



AbileneMachine[®]
Ag Replacement Parts

FOR CASE IH[®]
COMBINES



AbileneMachine.com

NEW My Shed Feature on AbileneMachine.com

A new way to narrow down your parts search geared specifically to your equipment

Select the make, equipment and model of your machine in the dropdown menus located at the top of the home page. Click the "Go" button.

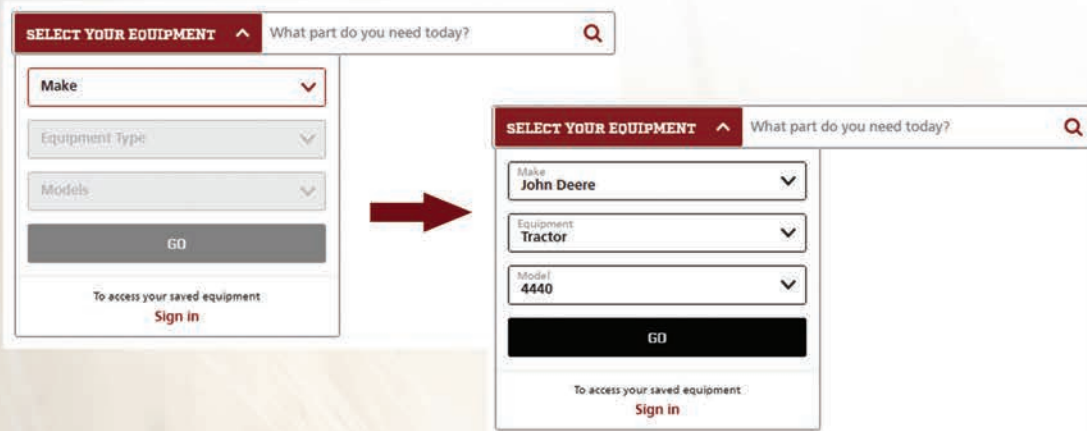

With your equipment selected, enter the product you are searching for (or part number if you have it). Suggested results will be displayed, or press enter to go to a list of all product results for your machine.

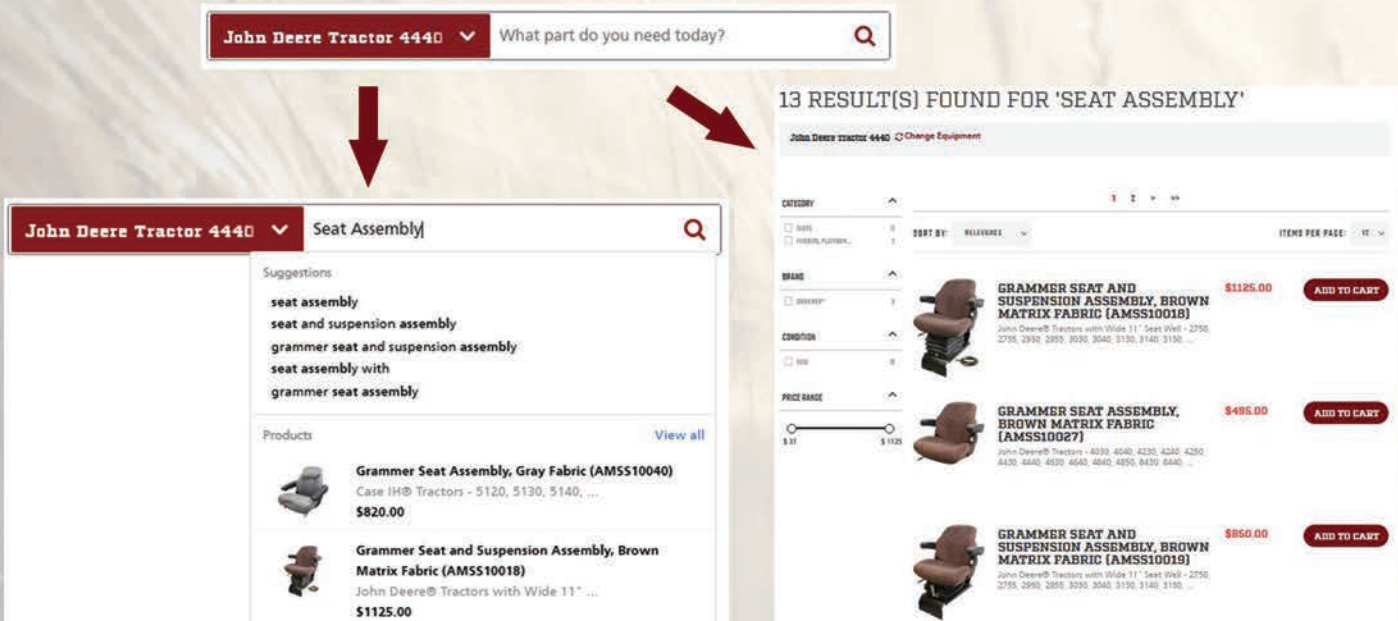

With the My Shed feature, your equipment selections can now be saved to your account to make future searching convenient and easy!

Once you create an account to access "My Shed," your equipment can be saved and you can also view past order history. This makes yearly maintenance easier and faster when it comes to getting the parts you need.

To create an account, select the Account icon to the right of the search bar and select "Create an account."



Follow the next screen to enter your information and create the account. If you made an equipment selection in the parts search, it will automatically be added to "My Shed" and will also be viewable on your Account Dashboard. Additional equipment can be added by clicking the "Add Equipment" button from either screen (prompts the dropdown menu at the top to open again) or by going directly to the parts search at the top of the page and making a new selection. When you hit "Go," this selection is automatically added to your shed.

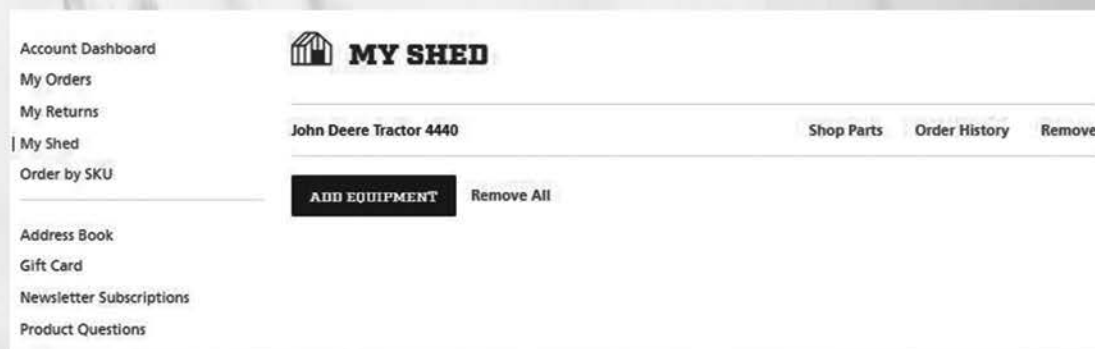

Quickly switch between equipment in your Shed by clicking the dropdown menu at the top of the page and selecting between machines. The page will reload to that selection and is ready to search for the products you need. As a thank you for reading about our new My Shed program, please use the code MYSHED22 for a 5% discount on one order through December 31, 2022.

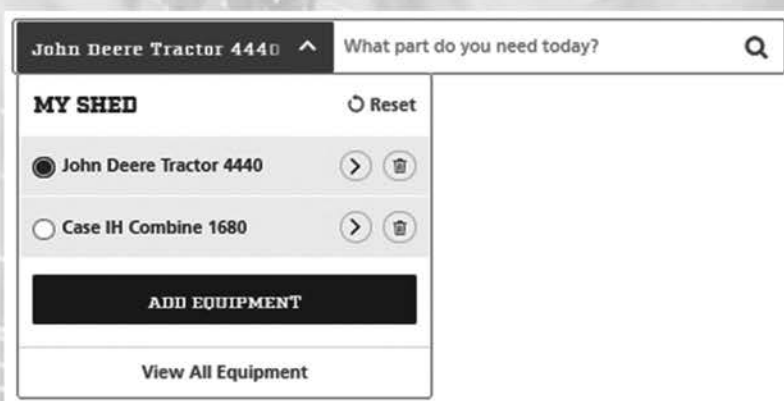

Abilene Machine LLC
Kansas & Montana: 800-255-0337
South Carolina: 800-543-2451
South Dakota: 844-340-4020
AbileneMachine.com

Case IH®—Combine

Table of Contents

Air Cleaner Components	4	Elevator Drive Shafts	39
Air Conditioning and Components	92	Elevator Drive Sprockets and Components	33
Alternators	5	Elevator Gearboxes	39
Auger Components—Bare Header / Platform	74	Elevator Head Shafts	39
Auger Extension Kits	59	Elevator Housings	34
Augers & Components—Distribution	47	Elevator Housing Sheet Metal	34
Augers & Components—Grain Delivery Leveling	45	Exhausts	4
Augers & Components—Horizontal Unloading	51	Fan Components	40
Augers & Components—Lower Clean Grain	41	Feederhouse Bottoms	19
Augers & Components—Lower Tailing Return	43	Feederhouse Chain Roller Kits	17
Augers & Components—Vertical Unloading	49	Feederhouse Chains	11
Augers—Grain Tank Bottom	57	Feederhouse Chain Sprockets	16
Augers—Top Tailing Return	44	Feederhouse Components	14
Auger Tube Donuts	59	Feederhouse Lower Shafts and Brackets	17
Axle Center Tubes	90	Feed Reverser Components	19
Axle Drive Shafts and Couplers	10	Final Drives and Components	9
Beater Components	39	Fuel Components	4
Belts—1420	110	Fuel Lift Pumps	4
Belts—1440, 1460, 1480	111	Gas Struts	92
Belts—1620	112	Glass	91
Belts—1640, 1660, 1680	113	Grain Drains	40
Belts—1644, 1666, 1688, 2144, 2166, 2188	114	Grain Pans and Components	65
Belts—2344, 2366, 2377, 2388, 2577, 2588	115	Grain Tank Auger Floor Liners	60
Belts—5088, 6088, 7088	116	Grain Tank Components	59
Belts—5130, 6130, 7130	117	Guards and Cutter Bar Parts	70
Belts—5140, 6140, 7140	118	Header Lift Cylinders and Components	77
Belts—5150, 6150, 7150	119	Hydraulic Oil Coolers	73
Belts—615, 715	108	Hydraulic Pump Drive Hubs and Components	72
Belts—7010, 7120, 8010, 8120, 9120	120	Hydrostats and Components	6
Belts—7230, 8230, 9230	121	Impeller Blade Kits (Elephant Ears)	24
Belts—7240, 8240, 9240	122	Lighting	80
Belts—7250, 8250, 9250	123	Longblock Assemblies	3
Belts—815, 915	109	Platform Components	76
Belts—Cotton Pickers & Swathers	124	Platform Floor Sheets	76
Belts—Platforms	124	Poly Skid Plate Kits and Components	80
Brakes and Components	11	Power Steering Cylinders and Components	89
Cab Components—Miscellaneous	87	Radiator Hoses and Thermostats	5
Chaffer and Sieve Frames and Components	62	Radiators and Components	4
Chaffers—Adjustable Air Foil Top	61	Reel Components	75
Chaffers—Long Finger Top	61	Return Elevator Boots	38
Chaffers—Rigid Air Foil	61	Rock Drums and Components	18
Chaffers—Short Finger Top	60	Rotor Assemblies and Components	27
Chaff Spreaders and Components	72	Rotor Bars—Specialty Rotors	23
Clean Grain Elevator Boot Kits and Parts	37	Rotor Bars—Standard Rotors	22
Cleaning Fan Shafts and Components	29	Rotor Front Kits and Components	27
Concave Components	22	Rotor Grates and Components	23
Concaves—Helical	22	Rotor Transition Cones and Components	25
Concave Sets	20	Rotor Vane Repair Kits	29
Cornhead—Augers and Auger Liners	99	Row Crop Dividers	76
Cornhead—Complete Polytin Heads	97	Sensors	5
Cornhead—Fenders and Snouts	97	Separator Gearbox Components	30
Cornhead—Hydraulic Deck Plate Kits	102	Separator Jackshafts, Sheaves and Components	30
Cornhead—Row Unit Components	102	Sickle Assemblies With Heads	70
Cornhead—Stalk Stompers and Components	100	Sickle Assemblies Without Heads	67
Cylinder Bars and Kits	20	Sickle Drives and Components	73
Distribution Auger Pans and Components	48		
Draper Belts and Components	77		
Elevator Chains	31		
Elevator Chain Sprockets	32		

Table of Contents Continued on Next Page

Case IH®—Combine

Table of Contents - Continued

Sickle Knife Heads	67	Transmissions	7
Sieves—Lower	62	Unloading Auger Bevel Gears	41
Spindles.....	89	Unloading Auger Elbows and Components.....	54
Steering Arms	87	Unloading Auger Housings and Components.....	40
Steps	91	Unloading Auger Swing Cylinders	41
Straw Chopper Blades and Components	66	Unloading Drive Components.....	56
Straw Chopper Drive Components.....	66	Unloading Gearbox Shafts	41
Straw Choppers.....	65	Upper Sprocket Tubes.....	16
Straw Spreader Shafts and Components.....	57	Vane Transports and Components.....	26
Straw Walkers and Parts	65	Wear Bars.....	24
Tie Rods and Components.....	88	Weight Brackets	91
Transmission Components.....	8	Wheel Hubs	90

Longblock Assemblies

Our remanufactured longblocks meet the highest standards in quality. All remanufactured components are inspected for structural integrity, cracks and dimensional specifications and then remanufactured back to OEM specifications. The components are then assembled using the highest quality new parts. We back this with one of the best warranties in the industry.



Application	Description	Part Number	Retail Price	Core
1460 w/ DT436 6 Cylinder Engine	Reman Longblock Assembly Vent in Valve Cover	LBIHT436T2	\$ 6450.00	\$ 1500.00
1480, 1680 - w/ DT466 6 Cylinder Engine	Reman Longblock Assembly Vent in Valve Cover	LBIHT466T2	\$ 6450.00	\$ 1500.00
1660, 1666, 2166 - w/ Cummins® 8.3T 6 Cylinder Engine	Reman Longblock Assembly Core charge includes similar block core only	LBCUM8.3T7220	\$ 8300.00	\$ 1500.00
1688, 2188, Cotton Pickers: 2044, 2555 - All w/ Cummins® 8.3T 6 Cylinder Engine	Reman Longblock Assembly Core charge includes similar block core only	LBCUM8.3T1688	\$ 8700.00	\$ 1500.00
1680, Cotton Pickers: 1822, 2022, 2055, 2155 BSN JJC0156230 - All w/ 8.3T 6 Cylinder Cummins® Engine	Reman Longblock Assembly Core charge includes similar block core only	LBCUM8.3T1680	\$ 8300.00	\$ 1500.00
2366, 2377, 2388, 2577, Sprayers: 4420, SPX4410	Reman Longblock Assembly	LBCUM8304HPCR24V	\$ 11000.00	\$ 2000.00
2388 BSN 273000 w/ 8.3 Turbo Engine	Reman Longblock Assembly	LBCUM8.3TE2388	\$ 9600.00	\$ 1500.00
2388 ASN 273000 w/ 8.3 Turbo Engine	Reman Longblock Assembly	LBCUM8.3TL2388	\$ 9900.00	\$ 1500.00
2388, 2588	Reman Longblock Assembly Electronic, 24 Valve	LBCUM8.3T2588	\$ 9900.00	\$ 2000.00
7088, Cotton Pickers: 620, 625	Reman Longblock Assembly Replaces 87603080, 87603080R	LBCUM8.9	\$ 12500.00	\$ 5000.00
Cotton Pickers: 2155 ASN JJC0156230, 2255, CPX420, Sprayer: SPX4260 - All w/ Cummins® 8.3T 6 Cylinder Engine	Reman Longblock Assembly Core charge includes similar block core only Cast # - 3923275, 3926567, 3938058	LBCUM8.3T8950	\$ 8700.00	\$ 1500.00
Cotton Pickers: 2555, CPX420 05/2005-06/13 - w/ 8.3T 6 Cylinder Cummins® Engine	Reman Longblock Assembly w/ Auxiliary Hydraulic Pump in timing cover Core charge includes similar block core only	LBCUM8.3T8950AUX	\$ 8700.00	\$ 1500.00
Swathers: 8820, 8825, 8825HP, 8830, 8860, 8860HP	Longblock Assembly Externally Balanced	LBCUM3.9-N	\$ 6175.00	\$ 1000.00
Swathers: 8825, 8825HP, 8840, 8860, 8860HP, 8870	Longblock Assembly Externally Balanced	LBCUM3.9TA-N	\$ 6495.00	\$ 1000.00
Swather: 8860	Reman Longblock Assembly 4-Bolt Injection Pump Mount	LBCUM3.9TA-4B	\$ 5100.00	\$ 1000.00
Case IH® Combine	New Engine, Complete Cursor 16, Tier 2 Replaces 5801897471	AM47702763	\$ 45000.00	\$ 7500.00

Case IH®—Combine

Exhausts

Application	Description	Part Number	Retail Price	Core
2388 SN JJC0267150-JJC0272999	Exhaust Pipe	AM364150A1	\$ 175.00	

Fuel Lift Pumps

Application	Description	Part Number	Retail Price	Core
1660, 1666, 1670, 1680, 2144, 2166, Cotton Pickers: 1822, 1844, 2022, 2044, 2055	Fuel Transfer Pump Replaces 87473337, J917998	AM87648717	\$ 70.00	
2344, 2366, 2377, 2388, 2577, 2588	Fuel Pump Replaces 302867A1	AM87472310	\$ 195.00	
2344, 2366, 2388, Cotton Picker: 2555	Fuel Transfer Pump 2-hole mount w/ manual priming plunger, gasket not included Replaces 87473338	AMJ936317	\$ 55.00	

Fuel Components

Application	Description	Part Number	Retail Price	Core
7240, 8240, 9240	Sensor, Fuel Pressure	AM5801567640	\$ 200.00	
	Sensor, Low Fuel Pressure Replaces 504343022	AM5801483105	\$ 445.00	
	Sender Unit For Fuel Level	AM47408083	\$ 145.00	

Air Cleaner Components

Application	Description	Part Number	Retail Price	Core
1460, 1480, 1640, 1644, 1660, 1666, 1680, 1688, 2144, 2166, 2188, 2344, 2366 BSN JJC0255700	Rotary Screen Shaft Replaces 118143A1, 234067A1, 1979590C1	AM234067A3	\$ 168.62	
9240	Sensor, Air Intake	AM504307953	\$ 150.00	
9240	Pressure Switch, Air Intake	AM47614038	\$ 17.00	



Radiators and Components

Application	Description	Part Number	Retail Price	Core
715, 815, 915, 1440	Radiator Overall: 25 3/4" x 33 3/4" x 4 1/8"	AM55650C3	\$ 1300.00	
1460, 1480, 1640 BSN JJC0034705, 1660 BSN JJC0038346	Radiator Overall: 28 3/4" x 38 1/2" x 4 3/16"	AMA189213	\$ 1097.00	
1620 ASN JJC0032629, 1640 ASN JJC0034704, 1644, 1660 ASN JJC0038345, 1666, 1680 ASN JJC0045688, 2144 BSN JJC0173150, 2166 BSN JJC0180000, 2344	Radiator Overall: 31 7/8" x 38 3/4" x 5 7/16"	AM1547946C3	\$ 1734.00	
1680 BSN JJC0045689 w/ IHC Engine	Radiator Overall: 26 1/8" x 43.00" x 3 9/16" 4 Rows *Overall width does not include the bracket Replaces 1265697C91	AMA189212	\$ 1515.00	
1688, 2188 BSN JJC019483	Radiator Replaces 117403A1, A189479	AM116154A1	\$ 2397.00	
2188 ASN JJC0191483, 2366 BSN JJC0255700, 2388 BSN JJC0273000	Radiator	AM194951A1	\$ 2060.00	

Case IH®—Combine

Application	Description	Part Number	Retail Price	Core
(2377, 2388 SN HAJ292001-HAJ300000), 2577, 2588, 5088, 5130, 5140, 5150, 6088, 6130, 6140, 6150, 7088, 7130, 7140, 7150, 9230	Radiator Overall: 29 1/4" x 40 3/4" x 4 1/2" 5 Rows, 7 Fins per Inch	AM87302088	\$ 1995.00	
7010, 7120, 7230, 8010 ASN HAJ202000, 8120	Radiator	AM87378361	\$ 1734.00	
Swathers: WD1203, WD1903, WD2303	Radiator	AM87340496	\$ 1680.00	
1440, 1460, 1480, 1620, 1640, 1644, 1660, 1666, 1670, 1680, 1688, 2166, 2188, Cotton Pickers: 420, 1800, 1822, 1844, 2022, 2044, 2055, 2155, 2555, CPX420	Radiator Cap Coolant Reservoir	AM437702C1	\$ 20.00	
1620, 1640, 1644, 1660, 1666, 1680, 1688, 2166, 2188, 2344, 2366, 2388, 2488	Radiator Cap 16 PSI, Fits 3/4" Deep Neck, w/ Drop-Type Vacuum Valve Replaces 90-6633T1, 4029/09070, 303494A2, 303496A2, 72186008, 76084259, 87774949, A171919, L302981, P2537495, W2537495	AMA170241	\$ 6.30	
2344, 2366, 2388 BSN JJC0276540, Cotton Pickers: CPX610, CPX620	Coolant Reservoir	AM251245A1	\$ 96.00	
5140, 6140, 7010, 7120, 7140, 8010, 8120, 9120	Coolant Temperature Sensor	AM82017881	\$ 26.40	

Radiator Hoses and Thermostats

Application	Description	Part Number	Retail Price	Core
1460, 1470, 1480, 1640 BSN JJC0034705, 1660 BSN JJC0038346, 1670 BSN JJC0080540, 1680 BSN JJC0045689	Radiator Hose, Lower 2.062" & 2.812" ID	AM121759C1	\$ 48.29	
815, 915, 1440, 1460, 1470, 1480, 1640, 1660, 1670, 1680	Thermostat Opening temperature of 190°F	AM684739C1	\$ 46.00	
1440, 1460, 1470, 1480, 1640, 1660, 1670, 1680, Cotton Pickers: 1822, 1844	Thermostat By-Pass Hose 1.16" ID	AM672242C2	\$ 6.68	



Alternators

Application	Description	Part Number	Retail Price	Core
1640, 1660, 1666, 1680, 1688, Cotton Pickers: 1800, 2022, 2044, 2055	Alternator w/o Pulley Bosch 12 Volt, 135 Amps, IR Replaces 91448C2R	AM91448C2	\$ 168.00	
1660 BSN 38346, 1680 BSN 45689	Alternator 105 Amps	AMA163085	\$ 144.00	
2144, 2166, 2188, 2344, 2366, 2377, 2388, 2577, 2588, 7088, Cotton Pickers: 420, 2155, 2555, CPX420, Floaters: FLX3010, FLX3300B, FLX3510, FLX4010, FLX4300, FLX4375, FLX4510, Sprayers: SPX4260, SPX4410	Alternator w/o Pulley 12 Volt, 135 Amps, IR, CW Rotation Replaces 91448C1, 86994128	AM125849A1	\$ 222.00	
5088, 6088, 7088	Alternator 12 Volt, 200 Amps, IR/IF	AM87715398	\$ 285.00	
8120, 9120	Alternator 14 Volt, 220 Amps Note: Special Order Item	AM87592254	\$ 790.00	

Sensors

Application	Description	Part Number	Retail Price	Core
1620, 1640, 1644, 1660, 1666, 1670, 1680, 1688, 2144, 2166, 2188, 2344, 2366, 2377, 2388, 2577, 2588	Transmitter, Straw Chopper	AM245410C1	\$ 107.00	
2377 SN HAJ292001-HAJ300000, 2388 ASN HAJ292001, 2577, 2588, 7010, 7120, 8010, 9010, AFX8010	Sensor, Feeder Pressure Replaces 122761A1, 84186707	AM86975430	\$ 167.00	

Case IH®—Combine

Application	Description	Part Number	Retail Price	Core
5088, 5130, 5140, 6088, 6130, 6140, 7088, 7130, 7140, 7230, 7240, 8230, 8240, 9230, 9240	Sensor, Grain Tank Cover/Spreader	AM87392235	\$ 29.00	
5088, 5130, 5140, 6088, 6130, 6140, 7010, 7088, 7120, 7130, 7140, 7230, 7240, 8240, 9120, 9230, 9240, Swathers: WD1204, WD1504, WD1904, WD2304	Sensor, Feeder and Lateral Tilt Replaces 87649361, 87649363	AM87330286	\$ 120.00	
5130, 5140, 6130, 6140, 7130, 7140, 7230, 7240, 8230, 8240, 9230, 9240	Switch, Auto-Guidance	AM84370690	\$ 26.00	
	Sensor, Def/AdBlue Tank Level Replaces 47682727, 84161271, LB50P01001P1	AM47512674	\$ 260.00	
5140, 6140, 7140, 7240, 8240, 9240	Switch, Engine Exhaust Pressure Replaces 2859674, 4890193, 6901334	AM504358206	\$ 80.00	
	Sensor, Exhaust Pressure	AM5801376024	\$ 60.00	
5140, 6140, 7140, 7240, 8240, 9240, Patriot Sprayers: 2240, 2250, 3240, 4430, 4440, Titan Floaters: 3040, 3540, 4040, 4540	Temperature Sender, Exhaust Temperature Replaces 47367178, 87482353, LB52S00001P1	AM47478880	\$ 66.00	
5140, Patriot Sprayers: 2240, 3230, 3330, SPX3320	Sensor, Fuel Pressure Replaces 2859145, 504123163, 504222094	AM2854542	\$ 170.00	
6140, 7140, 7240, 8240, 9240	Sensor, Crankcase Pressure	AM504364902	\$ 190.00	
7010, 7120, 7230, 7240, 8010, 8120, 8230, 8240, 9010, 9120, 9230, 9240	Sensor, Feeder Speed Replaces 87000101, 87105603	AM87662555	\$ 177.00	
7010, 7120, 7230, 8010, 8120, 8230, 9010, 9120, 9230, AFX8010	Sensor, Auto-Guidance Replaces 84161942, 86616461, 87387458	AM84058862	\$ 70.00	
7010, 7120, 7230, 8010, 8230, 9010, 9120, 9230, AFX8010	Sensor, Rotor Gearbox Speed Replaces 87105603	AM87662555	\$ 177.00	
7010, 7120, 8010, 8120	Sensor, Clogged Fuel Filter Indicator	AM500346371	\$ 40.00	
7010, 7120, 8010, 8120, 9010, 9120, AFX8010, Patriot Sprayers: 3230, 3330, SPX3320, Titan Floaters: 3030, 3530, 4030, 4530	Sensor, Oil Pressure and Temperature Replaces 4890193	AM504358206	\$ 80.00	
7010, 7120, 8010, 8120, 9010, 9120, AFX8010, Pickup Platform: 2016	Sensor, Transmission Speed Replaces 86593627	AM84058860	\$ 64.00	
7240, 8240, 9240	Sensor, Hydraulic Reservoir Level	AM47492948	\$ 104.00	
	Sensor, Fuel Pressure and Temperature	AM5801526037	\$ 125.00	
9240	Sensor, Exhaust Pressure	AM5801382522	\$ 104.00	
Patriot Sprayers: 3240, 3340, 4430	Electric Module	AM87601142	\$ 45.00	

Hydrostats and Components

Our hydrostats are remanufactured by a remanufacturing facility recognized by Sauer/Sundstrand. All units are assembled by a factory-trained technician, using genuine new and remanufactured replacement parts. All units are fully tested to factory specifications for maximum performance.

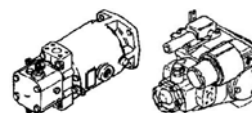

Application	Description	Part Number	Retail Price	Core
1460, 1480, 1660, 1680	Reman Hydrostat, Eaton Single Speed Screw-in Fittings	H1460E1-54/54	\$ 3850.00	\$ 500.00
	Reman Hydrostat, Eaton Dual Speed Screw-in Fittings	H1460E2-54/54	\$ 4195.00	\$ 600.00
1660, 1666, 1680, 1688	Reman Hydrostat, Eaton Dual Speed Both w/ Split Flange Hoses	H1660E2-54/54	\$ 4195.00	\$ 600.00
(1660, 1680 Late), 1688, 2188, 2388	Reman Hydrostat, Eaton Single Speed, Both w/ Split Flange Hoses	H1660LE1-54/54	\$ 3927.00	\$ 500.00
2188	Reman Hydrostat, Eaton 2-Piece RB, Dual Speed	H2188E2-64/54	\$ 4350.00	\$ 750.00
2388	Reman Hydrostat, Eaton	H2388E2-64/54	\$ 4437.00	\$ 600.00
Cotton Pickers: 622, 782, 1400	Reman Hydrostat, Eaton	H1400E-46/33	\$ 3550.00	\$ 500.00
	Reman Hydrostat, Sundstrand	H1400S-22/21	\$ 3550.00	\$ 500.00

Case IH®—Combine

Application	Description	Part Number	Retail Price	Core
Cotton Picker: 782	Reman Hydrostat, Eaton	H782E-46/33	\$ 3550.00	\$ 500.00
	Reman Hydrostat, Sundstrand	H782S-22/21	\$ 3550.00	\$ 500.00
Cotton Picker: 1822	Reman Hydrostat, Eaton	H1822E1-46/33	\$ 3550.00	\$ 500.00
	Reman Hydrostat, Eaton	H1822E2-46/33	\$ 3550.00	\$ 500.00
Cotton Picker: 1844	Reman Hydrostat, Eaton	H1844E1-54/33	\$ 3550.00	\$ 500.00
	Reman Hydrostat, Eaton	H1844E2-54/33	\$ 3550.00	\$ 500.00
Cotton Picker: 2022	Reman Hydrostat, Eaton	H2022E-46/33	\$ 3550.00	\$ 500.00
Cotton Picker: 2044	Reman Hydrostat, Eaton	H2044E-54/33	\$ 3550.00	\$ 500.00
7120, 7130, 7230, 7240, 7250, 8120, 8230, 8240, 9120, 9230, 9240	Hydrostat Motor 125 cc Replaces 84168175	AM47919915	\$ 2825.00	
2366, 2377, 2388, 2577, 2588, 5088, 5130, 5140, 5150, 6088, 6130, 6140, 6150, 7088, 7130, 7140, 7150, Cotton Pickers: 420, 620, 625, 2055, 2555, CPX420, CPX610, CPX620	Hydrostatic Motor Shaft 21 & 26 Spline, 12.40" Long	AM403147A1	\$ 295.00	
(7010, 8010, 9010 ASN HAJ202000), 7120, 7230, 7240, 7250, 8120, 8230, 8240, 8250, 9120, 9230, 9240, 9250 - w/ Thru Drive	Hydrostat Pump 71 cc	AM87577617	\$ 4590.00	
7120, (7130, 7240, 8230, 8240, 9230, 9240 - w/o Thru Drive), 8120, 9120	Hydrostat Pump 125 cc	AM87634754	\$ 7679.00	
2366, 2377, 2388 - Corn, Grain & Rice	Hydrostatic Pump Shaft	AM403149A1	\$ 275.00	
6088, 7088	Hydrostatic Pump Shaft 125 CC/REV	AM87699759	\$ 460.00	
1688, 2188, 2388	Hydro Input Shaft	AM1980169C1	\$ 255.00	
1460, 1480, 1660, 1680 BSN 45689	Hydro Output Shaft For Eaton Hydrostats	AM1980136C1	\$ 330.02	
1640, 1660, 1666, 1670, 1680, 1688, 2166, 2188, 2366, 2388, Cotton Pickers: 2055, 2155, 2555	Hydro Output Shaft	AM1980137C1	\$ 368.00	
5088, 6088, 7088	Auxiliary Drive Hub 21 Spline For 105 cc Hydrostatic Pump	AM87545088	\$ 125.00	
	Auxiliary Drive Hub 27 Spline For 25 cc Hydrostatic Pump	AM87545084	\$ 130.00	



Transmissions

Application	Description	Part Number	Retail Price	Core
1440	Reman Transmission	AMT1440	\$ 2100.00	\$ 1000.00
1460 Early	Reman Transmission	Wheat AMT1460EW	\$ 2573.00	\$ 500.00
		Corn AMT1460EC	\$ 2573.00	\$ 500.00
1460 Late	Reman Transmission	Wheat AMT1460LW	\$ 2573.00	\$ 500.00
		Corn AMT1460LC	\$ 2573.00	\$ 500.00
1480 Early	Reman Transmission	Wheat AMT1480EW	\$ 2573.00	\$ 500.00
		Corn AMT1480EC	\$ 2573.00	\$ 500.00
1480 Late	Reman Transmission	Corn AMT1480LC	\$ 2573.00	\$ 500.00
1660 Early	Reman Transmission	AMT1660EC	\$ 2888.00	\$ 500.00
1680 Early	Reman Transmission	AMT1680W	\$ 2888.00	\$ 1000.00
(1660, 1680 Late), 1666, 1688	Reman Transmission	AMT1688C	\$ 3675.00	\$ 1500.00
2144, 2166, 2188	Reman Transmission	AMT2188C	\$ 5775.00	\$ 1500.00

Case IH®—Combine

Application	Description	Part Number	Retail Price	Core
2344, 2366, 2377, 2388	Reman Transmission 34 & 38 Tooth Replaces 236706A1	AMT2388CR	\$ 5775.00	\$ 1500.00
	Reman Transmission 37 & 35 Tooth Replaces 236707A1	AMT2388C	\$ 5775.00	\$ 1500.00
2577, 2588, 5088, 6088, 7088	Reman Transmission 34 & 38 Tooth Replaces 84168421	Rice AM87393465	\$ 6825.00	\$ 1500.00
	Reman Transmission 37 & 35 Tooth Replaces 84168419	AM87393461	\$ 6825.00	\$ 1500.00
5130, 5140, 6130, 6140, 7130, 7140	Transmission	AM84602050	\$ 9600.00	











Transmission Components

Application	Description	Part Number	Retail Price	Core
1644, 1660 ASN JJC0038346, 1666, 1680 ASN JJC0045689, 1688, Cotton Picker: 2055	Differential Shaft	AM1342912C1	\$ 364.00	
7010, 7120, 7230, 7240, 8010, 8120, 8230, 8240, 9010, 9120, 9230, 9240, AFX8010	Differential Shaft w/ Lock 8 & 22 Spline, 17.09" Long	AM84069688	\$ 252.89	
2144 BSN JJC0173150, 2166 BSN JJC0182025, 2188 BSN JJC0193725, Cotton Picker: 2155	Transmission Output Shaft	AM1997455C1	\$ 408.00	
2144 ASN JJC0131750, 2166 ASN JJC0182025, 2188 ASN JJC0193725, 2344, 2366, 2377, 2388, 2577, 2588, 7088, Cotton Pickers: 420, 620, 625, 2555, CPX410, CPX610, CPX620	Transmission Output Shaft	AM236378A1	\$ 390.00	
7010, 7120, 7230, 7240, 8010, 8120, 8230, 8240, 9010, 9120, 9230, 9240, AFX8010	Transmission Output Shaft 8 & 22 Spline, 13.85" Long	AM84069687	\$ 210.84	
915 ASN 1250, 1460, 1470, 1480, 1600, 1644 ASN JJC0098060, 1666, 1670, 1680, 1688, 2144, 2166, 2188, 2344, 2366, 2377, 2388 BSN JJC0276540 & ASN HAJ0292001	Cluster Gear 59, 39 & 27 Tooth	AM530699R1	\$ 653.00	
	2nd & 3rd Gear Sliding, 26 & 46 Tooth	AM530700R1	\$ 415.00	
2388, 2577, 2588, 5088, 5130, 5140, 6088, 6130, 6140, 7088, 7130, 7140	Cluster Gear 27, 39 & 59 Tooth	AM87305298	\$ 1250.00	
	2nd & 3rd Gear Sliding, 26 & 46 Tooth	AM87305299	\$ 795.00	
2144, 2166, 2188, 2344, 2366, 2388, 2577, 2588, 5088, 6088, 7088	Gear, Change Driven 35 Tooth	AM1997649C1	\$ 225.00	
2144 ASN JJC0173150, 2166 ASN JJC0182025, 2188, 2344, 2377 ASN HAJ0292001, 2388 BSN JJC0276540 & BSN HAJ0292001, (2577, 2588 ASN HAJ0300001), 5088, 6088, 7088	Gear, Input Pinion 26 Tooth	AM184217C1	\$ 500.00	
2144, 2166, 2188, 2344, 2366, 2377 SN HAJ292001-HAJ300000, 2388, 2577, 2588, 5088, 5130, 5140, 6088, 6130, 6140, 7088, 7130, 7140, Cotton Pickers: 420, 620, 625, 635, 2555, CPX420, CPX610, CPX620	Bevel Gear 28 Tooth	AM236377A1	\$ 275.00	
1420, 1440, 1620, 1640, 1644 BSNJJC0098060, Cotton Pickers: 1822 ASN JJC0012000, 1844 ASN JJC0001999, 2022, 2044	Bearing Seal, Differential Bearing Cage	AM380182R91	\$ 14.00	
2144, 2166, 2188, 2344, 2366, 2377, 2388, 2577, 2588, 5088, 6088, 7088	Main Shaft Drive 37 Tooth	AM1997650C1	\$ 405.00	

Case IH®—Combine



Final Drives and Components

Application	Description	OE Part Number	Part Number	Retail Price	Core
1460, 1660 BSN 41095	Reman Final Drive, 66 Tooth	92769C93	FD1460	\$ 2100.00	\$ 200.00
1480	Reman Final Drive, 66 Tooth	92770C92	FD1480	\$ 2100.00	\$ 500.00
1680 BSN 48625	Reman Final Drive, 66 Tooth	92770C92	FD1680-66	\$ 2100.00	\$ 500.00
1644 ASN 98060, 1660 SN 41095-103799, 1666, 1680 ASN 48625, 1688	Reman Final Drive, 75 Tooth Replaces 134293C1	134297C1	FD1680-75	\$ 2625.00	\$ 1000.00
2144, 2166, 2344, 2366	Reman Final Drive, 73 Tooth Standard Duty Housing # - 140780A2, Axle # - 138279A1	141577A2	FD2166	\$ 2625.00	\$ 1000.00
2144, 2166, 2188, 2344 BSN 174224, 2366 BSN 245120, 2388 BSN 266791	Reman Final Drive, 73 Tooth Heavy Duty, 1" Thick Pilot Housing # - 135285A2, Axle # - 135288A2	1997415C3	FD2188	\$ 2625.00	\$ 1000.00
2344 ASN 174325, 2366 ASN 245121, 2388 ASN 266792	Reman Final Drive, 73 Tooth Heavy Duty, 2" Thick Pilot Housing # - 135285A2, Axle # - 335948A1	1997415C4	FD2188HD	\$ 3413.00	\$ 1500.00
5088, 5130, (5140, 6140, 7140 - 03/2014-10/15), 6088, 6130, 7088, 7130	Reman Final Drive	87695215	FD7088	\$ 3675.00	\$ 1000.00
	Final Drive 73 Tooth	87695215	AM87695215	\$ 7650.00	
1420, 1440, 1620, 1640, 1644, Cotton Pickers: 1400, 1800, 1822, 1844, 2022, 2044	 Final Drive Coupler 12 Spline, 3.312" Long Replaces 184226C1, 184226C2, 3177224R1	184342C1	AM184342C1	\$ 70.21	
503, 615, 715, Cotton Pickers: 414, 420, Cotton Harvester: 95	 Pinion Shaft	376461R2	AM376461R2	\$ 451.12	
815, 1420, 1440, Cotton Pickers: 616, 622	Pinion Shaft	395675R1	AM395675R1	\$ 437.74	
915, 1460, 1470, 1480, 1644, 1660, 1666, 1670, 1680, 1688, 2144, 2166, 2188, 2344, 2366, (2377, 2388 SN HAJ292001-HAJ300000), Cotton Pickers: 420, 620, 625, 635, 2055, 2155, 2555, CPX420, CPX610, CPX620	 Pinion Shaft	401870R1	AM401878R1	\$ 395.00	
915, 1460, 1660 BSN JJC0038346	 Pinion Shaft	401912R1	AM401912R1	\$ 425.16	
1480, 1680	 Pinion Shaft For 66 Tooth Bull Gear	130884C1	AM130884C1	\$ 404.47	
1644 ASN JJC009860, 1660 ASN JJ0103800, 1666, 1680 ASN JJC011760, 1688	 Pinion Shaft For 75 Tooth Bull Gear	1342907C1	AM1342907C1	\$ 459.00	
2144, 2166, 2188, 2344, 2366, 2388, Cotton Pickers: 2055 ASN JJC0155439, 2155, 2555, CPX610	 Pinion Shaft, 12 Tooth Replaces 87354348	135290A1	AM135290A1	\$ 295.00	
7010, 7120, 7230, 7240, 8010, 8120, 8230, 8240, 9010, 9120, 9230, 9240, AFX8010	 Pinion Shaft 18 Tooth Replaces 84074717	84449593	AM84449593	\$ 1000.00	
1644 ASN JJC009860, 1660 ASN JJ0103800, 1666, 1680 ASN JJC011760, 1688	 Gear, 75 Tooth	1342906C1	AM1342906C1	\$ 950.00	

Case IH®—Combine

Application	Description	OE Part Number	Part Number	Retail Price	Core
(2577, 2588 ASN HAJ300001), 5088, 5130, 5140, 6088, 6130, 6140, 7088, 7130, 7140, 9230	 Bull Gear 73 Tooth	87354349	AM87354349	\$ 1495.00	

Axle Drive Shafts and Couplers



Application	Description	Part Number	Retail Price	Core
915 Left Hand, (1460, 1660, 1670, 1688 - Right Hand)	Axle Drive Shaft	14.08" Long AM402725R2	\$ 184.31	
1460 BSN 32000	Axle Drive Shaft	Right Hand 16.65" Long AM121795C1	\$ 80.00	
	Axle Drive Shaft	Left Hand 29.77" Long AM121794C1	\$ 354.05	
1460 BSN 32000 w/ Axle Extensions	Axle Drive Shaft	Right Hand 22.65" Long AM193994C1	\$ 95.00	
	Axle Drive Shaft	Left Hand 35.77" Long AM193993C1	\$ 236.76	
1460 ASN 32001, 1660 w/ Axle Extensions	Axle Drive Shaft	Right Hand 20.08" Long AM184224C1	\$ 150.00	
1460 ASN 32001 w/ Axle Extensions, 1480 BSN 34000, 1660 w/ Axle Extensions, 1680, 1688	Axle Drive Shaft	Left Hand 33.04" Long AM184223C1	\$ 153.00	
1460 ASN 32001, 1644 BSN 98060, 1660, 1666, 1670 Hillside BSN 80539, 1688	Axle Drive Shaft	Left Hand 27.04" Long AM1309012C1	\$ 220.29	
1480 ASN 34001	Axle Drive Shaft	Right Hand 35.26" Long AM130841C1	\$ 113.00	
1480, 1660 ASN JJC0038346, 1680, 1688	Axle Drive Shaft	Right Hand 32.79" Long AM184189C1	\$ 286.37	
2144 ASN JJC0173150 w/ Axle Extension, 2166 ASN JJC0182025 w/ Axle Extension, 2344 BSN JJC0174359 w/ Standard Final Drive w/o Axle Extension, (2344, 2366 - w/ HD Final Drive w/o Axle Extension), 2366 BSN JJC0252949 w/ Standard Final Drive w/o Axle Extension	Axle Drive Shaft	Right Hand 16.85" Long AM242841A1	\$ 342.00	
	Axle Drive Shaft	Left Hand 30.08" Long AM242842A1	\$ 415.00	
(2144 ASN JJC0173150 w/ 144" Front Axle and Dual or Flotation Wheels), (2166 ASN JJC0182025 w/ 144" Front Axle and Dual or Flotation Wheels), (2344" BSN JJC0174359 w/ Standard Final Drive or All w/ Heavy Duty Final Drive), (2366" BSN JJC0252949 w/ Standard Final Drive or All w/ Heavy Duty Final Drive) *Models using 18" Axle Extension	Axle Drive Shaft	Right Hand 34.69" Long AM242843A1	\$ 385.00	
	Axle Drive Shaft	Left Hand 47.91" Long AM242844A1	\$ 425.00	
2166 w/o Axle Extensions	Axle Drive Shaft	Right Hand 10.87" Long AM242837A1	\$ 245.00	
	Axle Drive Shaft	Left Hand 24.09" Long AM242839A1	\$ 375.00	
2188, 2377, 2388, 2577, 2588	Axle Drive Shaft	29.50" Long AM242846A1	\$ 393.00	
2188 w/ Single Wheel Extension, 2377 SN HAJ292001-HAJ300000, 2388 w/ 6" Axle Extension, 2577, 2588	Axle Drive Shaft	Right or Left Hand 35.69" Long AM242852A1	\$ 600.18	
(2188 w/ Duals and Flotation Wheels and 12" Axle Extensions), (2377, 2388 - w/ 12" Axle Extensions), 2577, 2588	Axle Drive Shaft Replaces 135977A1	Right or Left Hand 41.181" Long AM242859A1	\$ 460.53	
(2188, 2388 - w/ Track Attachment), 2588	Axle Drive Shaft Replaces 87330885	Right or Left Hand 30.31" Long AM242853A1	\$ 480.41	
2344, 2366 - w/ 12" Axle Extensions	Axle Drive Shaft	Right Hand 28.465" Long AM280745A1	\$ 273.67	
	Axle Drive Shaft 12 Spline	Left Hand 41.69" Long AM280744A1	\$ 518.34	
2377 SN HAJ292001-HAJ300000, (2388 w/ Narrow Dual Wheels and 13" Axle Extensions), 2577	Axle Drive Shaft Replaces 87330891	Right or Left Hand 43" Long AM356460A1	\$ 512.42	
7010, 7230, 7240, 8010, 8120, 8230, 8240, 9010, 9120, 9230, 9240, AFX8010 - w/o Axle Extensions	Axle Drive Shaft 22 Spline	Left Hand 26.12" Long AM84440162	\$ 377.66	
8010, 8120, 9120, AFX8010 - w/ 265 mm Axle Extensions	Axle Drive Shaft 22 Spline Replaces 84440972	Right Hand 46.75" Long AM84440974	\$ 262.59	
8010, 8120, 9120, AFX8010 - w/o Axle Extensions	Axle Drive Shaft 22 Spline	Right Hand 36.38" Long AM84440165	\$ 361.64	
8010, 8120, 9120, AFX8010 - w/ 265 mm Axle Extensions	Axle Drive Shaft 22 Spline	Left Hand 36.50" Long AM84440967	\$ 256.07	

Case IH®—Combine

Application	Description	Part Number	Retail Price	Core
915, 1460, 1480, 1640, 1660, 1680, 1688, 2188	Axle Drive Shaft Coupler	3.00" Long AM184341C1	\$ 46.00	
(2344, 2366 w/ Standard Final Drive or w/ Heavy Duty Final Drive), 2388, 2588	Axle Drive Shaft Coupler	3.67" Long AM248600A1	\$ 56.00	
7010, 7120, 8010, 8120, 9120, AFX8010	Axle Drive Shaft Coupler 22 Spline	4.09" Long AM84438982	\$ 99.66	
2166, 2344, 2366, (2377, 2388 HAJ292001-HAJ300000), 2577, 2588, 5088, 5130, 5140, 6088, 6130, 6140, 7088, 7130, 7140, Cotton Pickers: 620, 625, 635, CPX610, CPX620	Axle Drive Shaft Collar Replaces 250756A1	AM244549A1	\$ 77.89	



Brakes and Components

Application	Description	Part Number	Retail Price	Core
2144 ASN JJC0173150, (2166, 2188 ASN JJC0193725), 2344, 2366, 2377 SN HAJ0292001-HAJ0300000, 2388 BSN JJC0276540 & ASN HAJ0292001, (2577, 2588 ASN HAJ0300001), 5088, 5130, 5140, 6088, 6130, 6140, 7088, 7130, 7140, Cotton Pickers: 420, 620, 625, 635, 2555, CPX420, CPX610, CPX620	Brake Assembly	AM236388A1	\$ 1530.00	\$ 350.00
2144, 2166, 2188, 2344, 2366, 2388, 2588, 5140, 6130, 6140, 7130, 7140	Wheel Brake Disc (12) Required	AM1997959C1	\$ 35.00	
2144, 2166, 2188, 2344, 2366, 2388, 2588	Transmission Separator Plate (13) Required	AM1285974C1	\$ 12.00	
141, 151, 181, 403, 503, 615, 715, 815, 1420, 1440, 1620, 1640, 1644, Cotton Pickers: 414, 416, 420, 422, 616, 622, 782, Cotton Harvesters: 95, 1400	Brake Disc, Bonded 12 Spline, 3.50" ID, 6.50" OD Replaces 121961C92, 321162R91, 351117R91, 368179R91, 1963810C1	AM1963810C2	\$ 18.00	
151, 403, 503, 915, 1460, 1480	Brake Disc, Bonded 12 Spline, 4" ID, 7.125" OD Replaces 121963C91, 369079R92	AM1975446C2	\$ 16.00	
715, 815, 1420, 1440, 1620, 1640, 1644 BSN JJC0098060	Brake Actuating Assembly	AM366182R93	\$ 262.18	

Feederhouse Chains

Our feederhouse chains for Case IH® and International® rotary combines are assembled from high-quality CA557 heavy-duty chain. Slats are mounted using 3/8" grade 5 hardware and locktite for added durability. Conventional combine chains use CA550 chain and slats are mounted with 3/8" grade 5 plated hardware. All feederhouse chains come with serrated slats unless otherwise noted.



Application	Description	Part Number	Retail Price	Core
715, 815 SN 8001	Feederhouse Chain 87 links - slats every 4th link 2 Chain Assembly	AM175991C92	\$ 615.38	
	Serrated Slat For 27 1/4" Chain Centers	AM118270A1	\$ 20.00	
915	Serrated Slat For 18.1875" Chain Centers	AM175997C1	\$ 15.00	
	Smooth Slat For 18.1875" Chain Centers Replaces 196358A1	AM196357A1	\$ 15.00	
1420, 1440, 1460, 1620, 1640, 1644, 1660, 1666, 2144, 2166, 2366	Feederhouse Chain, Serrated	AM117864A1	\$ 434.00	
	Feederhouse Chain, Smooth 60 links - 47" Feederhouse 1/4" slats every 6th link, chrome pins 2 Chain Assembly	AM117869A1	\$ 350.00	
1420, 1440, 1460, 1620, 1640, 1644, 1660, 1666, 2144, 2166	Serrated Slat For 27 1/4" Chain Centers	AM118270A1	\$ 20.00	
	Smooth Slat For 27 1/4" Chain Centers	AM118268A1	\$ 26.55	

Case IH®—Combine

Application	Description	Part Number	Retail Price	Core
1420, 1440, 1460, 1620, 1640, 1644, 1660, 1666, 2144, 2166	Feederhouse Chain, Serrated 60 links - 47" Feederhouse 1/4" slats every 8th link, chrome pins 2 Chain Assembly - Rice Chain	AM117868A1	\$ 499.00	
	Serrated Slat For 27 1/4" Chain Centers	AM118270A1	\$ 20.00	
1420, 1440, 1460, 1620, 1640, 1644, 1660, 1666, 2144, 2166, 2366	Feederhouse Chain, Serrated 69 links - 54" Feederhouse 1/4" slats every 8th link, chrome pins 2 Chain Assembly - Rice Chain	AM117865A1	\$ 774.46	
	Serrated Slat For 27 1/4" Chain Centers	AM118270A1	\$ 20.00	
1420, 1440, 1460, 1620, 1640, 1644, 1660, 1666, 2144, 2166, 2366	Feederhouse Chain, Serrated	AMX28017	\$ 485.00	
	Feederhouse Chain, Smooth 69 links - 54" Feederhouse 1/4" slats every 6th link, chrome pins 2 Chain Assembly, CA557	AM117871A1	\$ 485.00	
	Serrated Slat For 27 1/4" Chain Centers	AM118270A1	\$ 20.00	
	Smooth Slat For 27 1/4" Chain Centers	AM118268A1	\$ 26.55	
1480, 1482, 1680, 1682, 1688, 2188	Feederhouse Chain, Serrated	AMX28015	\$ 536.00	
	Feederhouse Chain, Smooth 69 links - 54" Feederhouse 1/4" slats every 6th link, chrome pins 2 Chain Assembly, CA557	AM117872A1	\$ 550.00	
	Serrated Slat For 36 3/8" Chain Centers	AM118271A1	\$ 30.00	
	Smooth Slat For 36 3/8" Chain Centers	AM118269A1	\$ 20.00	
1480, 1482, 1680, 1682, 1688, 2188	Feederhouse Chain, Serrated 69 links - 54" Feederhouse 1/4" slats every 8th link, chrome pins 2 Chain Assembly - Rice Chain	AM117866A1	\$ 530.00	
	Serrated Slat For 36 3/8" Chain Centers	AM118271A1	\$ 30.00	
1480, 1482, 1680, 1682, 1688, 2188	Feederhouse Chain, Serrated	AMX28016	\$ 510.00	
	Feederhouse Chain, Smooth 76 links - 60" Feederhouse 1/4" slats every 6th link, chrome pins 2 Chain Assembly, CA557	AM136440A1	\$ 500.00	
	Serrated Slat For 36 3/8" Chain Centers	AM118271A1	\$ 30.00	
	Smooth Slat For 36 3/8" Chain Centers	AM118269A1	\$ 20.00	
1480, 1482, 1680, 1682, 1688, 2188	Feederhouse Chain, Serrated 76 links - 60" Feederhouse 1/4" slats every 8th link, chrome pins 2 Chain Assembly - Rice Chain	AM117867A1	\$ 459.00	
	Serrated Slat For 36 3/8" Chain Centers	AM118271A1	\$ 30.00	
1480, 1482, 1680, 1682, 1688, 2188, 2388, 2588	Feederhouse Chain, Smooth 69 links - 54" Feederhouse 1/4" slats every 2nd & 4th link 3 Chain Assembly	AM195664A1	\$ 775.00	
	Smooth Slat For 18.1875" Chain Centers Replaces 196358A1	AM196357A1	\$ 15.00	

Case IH®—Combine

Application	Description	Part Number	Retail Price	Core
1480, 1482, 1680, 1682, 1688, 2188, 2388, 2588	Feederhouse Chain, Serrated 69 links - 54" Feederhouse 1/4" slats every 4th link, chrome pins 3 Chain Assembly	AMB93533	\$ 734.00	
	Serrated Slat For 18.1875" Chain Centers	AM175997C1	\$ 15.00	
	Smooth Slat For 18.1875" Chain Centers Replaces 196358A1	AM196357A1	\$ 15.00	
1480, 1482, 1680, 1682, 1688, 2188, 2388, 2588	Feederhouse Chain, Smooth 76 links - 60" Feederhouse 1/4" slats every 2nd & 4th link, chrome pins 3 Chain Assembly, CA557	AM195668A1	\$ 796.00	
	Smooth Slat For 18.1875" Chain Centers Replaces 196358A1	AM196357A1	\$ 15.00	
1480, 1482, 1680, 1682, 1688, 2188, 2388, 2588	Feederhouse Chain, Serrated	AMB93535	\$ 755.00	
	Feederhouse Chain, Smooth 76 links - 60" Feederhouse 1/4" slats every 4th link, chrome pins 3 Chain Assembly	AMB93534	\$ 740.00	
	Serrated Slat For 18.1875" Chain Centers	AM175997C1	\$ 15.00	
	Smooth Slat For 18.1875" Chain Centers Replaces 196358A1	AM196357A1	\$ 15.00	
(1480, 1482, 1680, 1682, 1688, 2188, 2377, 2388, 2577, 2588, 5088, 6088, 7088 - w/o Rocktrap), (5130, 5140, 6130, 6140, 7130, 7140 - w/ Rock Trap)	Feederhouse Chain, Serrated 76 links - 60" Feederhouse 1/4" slats every 2nd & 4th link, chrome pins 3 Chain Assembly, CA557 Machines w/ Field Tracker Kit must order (6) CA557OL Offset Links Replaces 195670A2	AM84207192	\$ 835.00	
	Serrated Slat For 18.1875" Chain Centers Replaces 196360A3	AM196359A2	\$ 18.00	
1480, 1482, 1680, 1682, 1688, 2188, 2388, (5088, 5130, 6088, 6130, 7088, 7130 - w/ Rock Trap)	Feederhouse Chain, Serrated 69 links - 54" Feederhouse 1/4" slats every 2nd & 4th link, chrome pins 3 Chain Assembly, CA557 Replaces 195666A2	AM84207190	\$ 815.00	
	Serrated Slat For 18.1875" Chain Centers Replaces 196360A3	AM196359A2	\$ 18.00	
2144, 2166, 2344, 2366	Feederhouse Chain, Serrated 74 links - 60" Feederhouse 1/4" slats every 6th link, chrome pins 2 Chain Assembly	AMX28038	\$ 546.00	
	Feederhouse Chain, Serrated 76 links - 60" Feederhouse 1/4" slats every 8th link, chrome pins 2 Chain Assembly	AM136438A1	\$ 546.00	
	Serrated Slat For 27 1/4" Chain Centers	AM118270A1	\$ 20.00	
2144, 2166, 2344, 2366	Feederhouse Chain, Smooth 76 links - 60" Feederhouse 1/4" slats every 6th link, chrome pins 2 Chain Assembly	AM136439A1	\$ 546.00	
	Smooth Slat For 27 1/4" Chain Centers	AM118268A1	\$ 26.55	

Prices Subject to Change without Prior Notice. The use of original equipment manufacturer (OEM) part numbers or trademarks, e.g. Case® and John Deere®, are for reference purposes only and for indicating product use and compatibility. Our company and the listed replacement parts contained herein are not sponsored, approved or manufactured by the OEM. All parts are New unless designated Reman in the description.

Case IH®—Combine

Application	Description	Part Number	Retail Price	Core
5130, 5140, 6130, 6140, 7130, 7140 - w/o Rock Trap	Feederhouse Chain, Serrated 87 Links 3 Chain Assembly, CA557 Machines w/ Field Tracker Kit must order (6) CA557OL Offset Links	AM84346485	\$ 863.00	
	Serrated Slat For 18.1875" Chain Centers Replaces 196360A3	AM196359A2	\$ 18.00	
(5140, 6140, 7140 ASN YFG14001), 5150, 6150, 7150	Feederhouse Chain, Serrated 22 Slats 3 Chain Assembly, CA557	AM47596677	\$ 1125.00	
7010, 8010, 9010, AFX8010 - w/ Rock Trap	Feederhouse Chain, Serrated 95 links 1/4" slats every 8th link, chrome pins 2 Chain Assembly, CA557 (2) Required Replaces 87397925	AM87283356	\$ 638.00	
7010, 8010, AFX8010 BSN HAJ106756 - w/o Rock Trap	Feederhouse Chain, Serrated 111 Links 1/4" slats every 8th link, chrome pins 18 1/16" center-to-center on sprockets 2 Chain Assembly, CA557 (2) Required per Machine Replaces 86995351, 87397924	AM87283358	\$ 875.00	
	Feederhouse Chain, Smooth 111 Links - U-Slats 1/4" every 8th link, chrome pins 2 Chain Assembly, CA557 Replaces 84084683, 86995123	AM87283359	\$ 840.60	
	Serrated Slat For 18 1/8" Chain Centers	AM87617002	\$ 18.00	
7120, 7230, 7240, 8120, 8230, 8240, 9120, 9230, 9240 - w/ Rock Trap	Feederhouse Chain, Serrated 103 Links, Slats every 2nd and 6th link, chrome pins 4 Chain Assembly	AM84179639	\$ 1173.00	
	Serrated Slat	AM84179662	\$ 15.00	
7120, 7230, 7240, 8120, 8230, 8240, 9120, 9230, 9240 - w/o Rock Trap	Feederhouse Chain, Serrated 114 Links - Slats every 2nd and 6th link, chrome pins 4 Chain Assembly Replaces 87646005	AM84179642	\$ 1395.00	
	Serrated Slat	AM84179662	\$ 15.00	



Feederhouse Components

For 2-chain feeder chains. If using split sprockets, material will have to be removed to allow clearance for larger sprocket hub.

Application	Description	Part Number	Retail Price	Core
1420, (1440, 1460, 1480 ASN 10001), 1470 ASN 1180, 1620 ASN JJC0032630, 1640, 1644, 1660, 1666, 1670, 1680, 1682, 1688, 2144, 2166, 2188, 2344, 2366	Feederhouse Chain Stripper Plate Right Hand	AM185819C1	\$ 16.00	
	Feederhouse Chain Stripper Plate Left Hand	AM185818C1	\$ 16.00	
2188, 2377, 2388, 2577, 2588	Feederhouse Center Stripper Plate	AM87530580	\$ 20.13	
7130, 7230, 7240, 8230, 8240, 9230, 9240	Feederhouse Chain Stripper Plate Replaces 48001329	Right Hand AM84470468	\$ 42.00	
	Feederhouse Chain Stripper Plate Replaces 48001318	Left Hand AM84470466	\$ 42.00	
	Feederhouse Center Stripper Plate Replaces 47963654	AM84470464	\$ 35.00	

Case IH®—Combine

Application	Description	Part Number	Retail Price	Core
1420, 1440, 1460, 1470, 1480, 1620, 1640, 1644, 1660, 1666, 1670, 1680, 1688, 2144, 2166, 2188, 2344, 2366, (2377, 2388 SN HAJ292001-HAJ300000), 2577, 2588, 5088, 5130, 5140, 6088, 6130, 6140, 7088, 7130, 7140	Bushing, Separator Drive 1" ID, 1.25" OD, 1.125" Wide	AM1302308C1	\$ 7.00	
1420, 1440, 1460, 1470, 1620, 1640, 1644, 1660, 1666, 1670, 2144, 2166, 2344, 2366	Front Wear Plate, Rock Trap	AM1320279C1	\$ 63.88	
1480, 1482, 1680, 1682, 1688, 2188, 2377 SN HAJ292001-HAJ300000, 2388 BSN JJC0276540, 2577, 2588, 5088, 5130, 5140, 6088, 6130, 6140, 7088, 7130, 7140	Front Wear Plate, Rock Trap Replaces 1320278C1	AM87612310	\$ 45.00	
1480, 1680, 1688, 2377, 2388, 2577, 2588, 5088, 5130, 5140, 6088, 6130, 6140, 7088, 7130, 7140	Upper Feederhouse Seal Replaces 634248R1	AM634248R2	\$ 17.63	
2188, 2377 SN HAJ292001-HAJ3000000, 2388 BSN JJC0276540, 2588 ASN HAJ300001	Support Right Hand	AM1989593C1	\$ 19.15	
2377, 2388, 2588	Feederhouse Plate, Field Tracker	AM197389A3	\$ 1964.00	
7010, 7120, 7230, 7240, 7250, 8010, 8120, 8230, 8240, 8250, 9120, 9230, 9240, 9250, AFX8010	Feederhouse Door, Access Cover Includes Bolt Kit	AMX29170	\$ 218.00	
2377 SN HAJ292001-HAJ300000, 2388, 2577, 2588	Rock Trap Door	AM241643A2	\$ 372.94	
(5130, 6130, 7130 - w/ Common Cab), (5140, 6140, 7140 - 03/2014-10/15), 7230, 7240, 7250, 8230, 8240, 8250, 9230, 9240, 9250	Solenoid, Feeder Valve Replaces 87775314	AM188105A1	\$ 70.00	
(2377, 2388 SN HAJ0292001-HAJ0300000), 2577, 2588	Feederhouse Drive Gearbox	AM393577A2	\$ 1530.00	
1440, 1460, 1470, 1480, 1640, 1644, 1660, 1666, 1670, 1680, 1688, 2144, 2166, 2188, 2344, 2366, 2377, 2388, 2577, 2588, 5130, 5140, 5150, 6130, 6140, 6150, 7088, 7130, 7140, 7150	Gear Set Includes 18 & 31 Tooth Gears Replaces 191285C1	AM1315597C1	\$ 500.00	
1640, 1644, 1660, 1666, 2144 BSN JJC0173150, 2166 BSN JJC0182025	Jackshaft, Feeder Cross 70" Long Replaces 1319482C1	AM1319482C2	\$ 355.81	
2344 ASN JJC0174400, 2366 ASN JJC0254000, 2377, 2388 ASN JJC0268800, 2577, 2588	Jackshaft, Feeder Drive	AM388771A1	\$ 490.01	
7010, 7120, 7230, 7240, 8010, 8120, 8230, 8240, 9010, 9120, 9230, 9240, AFX8010	Shaft, Rock Trap Friction 22 Tooth, 11 Spline	AM87536812	\$ 341.38	
	Knife Blade, Rock Trap Replaces 86995742	AM87108966	\$ 87.00	
7010, 7120, 7230, 7240, 8010, 8120, 8230, 8240, 9120, 9230, 9240, AFX8010	Feed Conveyor Shaft	AM87282003	\$ 332.00	
7010, 7120, 7230, 7240, 8010, 8230, 8240, 9010, 9120, 9230, 9240, AFX8010	Feederhouse Chain Wear Strip (4) Required	AM86638209	\$ 29.00	
7010, 7120, 8010, 8120, 9120, AFX8010	Clutch Plate For Feederhouse Drive Gearbox	AM87536805	\$ 40.98	
	Transmission Disc 35 Spline, 5.54" OD	AM87536806	\$ 74.97	
1440, 1460, 1470, 1480, 1620, 1640, 1644, 1660, 1666, 1670, 1680, 1688, 2144, 2166, 2188, 2344, 2366, 2377, 2388, 2577, 5088, 6088, 7088	Adjusting Eyebolt Replaces 1321735C1, 1321735C2	AM1321735C3	\$ 33.33	
1420, 1440, 1460, 1480, 1620, (1640, 1644, 1660, 1666, 1680, 1688, 2144, 2166, 2188, 2344 BSN JJC0174399, 2366 BSN JJC0253999, 2388 BSN JJC0268799 - w/ Rock Trap)	Idler Support Replaces 1321933C1, 1321933C2	AM1321933C3	\$ 60.98	
1680, 1688, 2188, 2377, 2388, 2577, 2588	Pulley, Feeder Drive 14 Tooth, 4-Groove, 12" OD Replaces 193999C1, 193999C2	AM193999C3	\$ 447.50	
(2377, 2388 SN HAJ292001-HAJ300000), 2577, 2588, 5088, 5130, 5140, 6088, 6130, 6140, 7088, 7130, 7140	Pulley, Feeder Jackshaft Drive 6 Spline, 4-Groove, 13.23" OD Replaces 87665210	AM388396A1	\$ 253.11	
1420, 1440 ASN 10000, 1460 ASN 12000, 1480 ASN 14000, 1620, 1640, 1644, 1660, 1666, 1680, 1688, 2144, 2166, 2188, 2344 BSN JJC0174399, 2366 BSN JJC0253999, 2388 ASN JJC0268799, 2577, 2588	Pulley Hub, Feederhouse Jackshaft Drive 2 Keyways, 1.508" Hex Bore Diameter Replaces 1305154C2	AM398526A1	\$ 196.00	

Prices Subject to Change without Prior Notice. The use of original equipment manufacturer (OEM) part numbers or trademarks, e.g. Case® and John Deere®, are for reference purposes only and for indicating product use and compatibility. Our company and the listed replacement parts contained herein are not sponsored, approved or manufactured by the OEM. All parts are New unless designated Reman in the description.

Case IH®—Combine

Application	Description	Part Number	Retail Price	Core
7010, 7120, 8010, 8120, 9120, AFX8010	Ball Bearing, Feeder Jackshat Replaces 80609150, 86533335, B92630	AM86575514	\$ 94.90	
1420, 1440, 1460, 1620, 1640, 1644, 1660, 1666, 2144, 2166, 2366	Beater Fins, Rock Trap Set of 3, Serrated, 32.675" Long	AMB95329	\$ 137.22	
	Beater Fins, Rock Trap Set of 3, 32.675" Long	AMB95330	\$ 202.45	
1460, 1620, 1640, 1644, 1660, 1666, 1670, 2144, 2166, 2344, 2366	Beater Fin, Rock Trap Serrated (3) Required Replaces 1324438C1, B95329, LBFHC40	AM1320921C2	\$ 47.00	
1480, 1680, 1688, 2188, 2377, 2388, 2577, 2588, 5088, 6088, 7088	Beater Fins, Rock Trap Set of 3, 42.313" Long Replaces 1324437C1	AMB95328	\$ 199.27	
5088, 5130, 5140, 6088, 6130, 6140, 7088, 7130, 7140	Sprocket, Rock Trap 30 Tooth, Hex Bore	AM87674273	\$ 78.00	
403, 503, 615, 715, 815, 915, 1440, 1460, 1480, 1482, 1640, 1644, 1660, 1666, 1670, 1680, 1682, 1688, 2144, 2166, 2188, 2344, 2366, 2377 SN HAJ292001-HAJ300000, 2388, 2577, 2588, 5088, 5130, 5140, 6088, 6130, 6140, 7088, 7130, 7140	Idler Pulley 0.625" ID, 8" OD, 3.25" Wide	AM176579C1	\$ 93.08	
5130, 5140, 6130, 6140, 7088, 7130, 7140	Feed Conveyor Shaft Replaces 84126834	AM84174008	\$ 306.39	
5130, 5140, 6088, 6130, 6140, (7010, 8010 BSN HAJ202001), 7088, 7130, 7140, AFX8010	Feeder Drum Idler Bearing 1 1/8" (28.60 mm) Hex Bore, 1.4843" (37.70 mm) Wide, 2.8346" (72 mm) OD	AM121602	\$ 18.00	
(640, 1660, 1680 - w/ Field Tracker), 2144, 2166, 2188, 2344, 2366, 2388 BSN JJC0276540, 2588	Bearing Support	AM100273A2	\$ 50.00	
1440, 1460, 1470, 1480, 1640, 1644, 1660, 1666, 1670, 1680, 1688, 2144, 2166, 2188, 2344, 2366, (2377, 2388 SN HAJ292001-HAJ300000), 2388 BSN JJC0276540, (2577, 2588 ASN HAJ300001), 5088, 5130, 5140, 5150, 6088, 6130, 6140, 6150, 7088, 7130, 7140, 7150, 9230	Output Driven Shaft	AM191384C2	\$ 160.00	

Feederhouse Chain Sprockets

To extend the life of your chain assemblies, always replace the sprockets when installing a new chain.



Application	Description	Part Number	Retail Price	Core
615 ASN 12000, 715, 815, 915 ASN 8001, 1420, 1440, 1460, 1480, 1482, 1620, 1640, 1644, 1660, 1666, 1680, 1682, 2144, 2166, 2188	Feederhouse Chain Sprocket 9 Tooth, 1.50" Hex	AM1970248C1	\$ 60.00	
	Feederhouse Chain Sprocket Hardened 9 Tooth, 1.50" Hex Split sprocket for easy changeover	AMFM-91	\$ 117.38	

Upper Sprocket Tubes



Application	Description	Part Number	Retail Price	Core
1480, 1680, 1688, 2188, 2388 BSN HAJ0300000	Sprocket Tube Heavy Duty Includes Sprocket Tube w/ Hardened Sprockets	AM1989587C2	\$ 525.00	
2388 ASN HAJ300001, 2577, 2588	Sprocket Tube Replaces 87384169	AM87642397	\$ 556.00	
5088, 5130, 5140, 5150, 6088, 6130, 6140, 6150, 7088, 7130, 7140, 7150	Sprocket Tube 9 Spline, 40.25" Overall Length, 39.75" Tube Length, 3.001" Spline ID, 5.14" Spline OD	AM84122242	\$ 597.00	
7010, 8010, 9010, AFX8010	Sprocket Tube Replaces 87282647, 87282648, 87283554	AM87284914	\$ 650.00	

Case IH®—Combine

Application	Description	Part Number	Retail Price	Core
7120, 7230, 7240, 8120, 8230, 8240, 9120, 9230, 9240 - w/ Rock Trap	Sprocket Tube No Internal Clutch Replaces 84296465	AM84414915	\$ 816.00	

Feederhouse Chain Roller Kits

These kits will reduce the wear on your feeder chain by keeping the chain off the upper and lower wear plates. This will reduce the noise and increase the life of your chain dramatically.



Application	Description	Part Number	Retail Price	Core
1420, 1440, 1460, 1620, 1640, 1660, 2144, 2166, 2344, 2366	Feederhouse Chain Roller Kit 2 Chain Roller Kit, 37" Wide	AMFCRA-1	\$ 439.00	
(1480, 1680, 2188, 2388 Early)	Feederhouse Chain Roller Kit 2 Chain Roller Kit, 47" Wide	AMFCRA-2	\$ 430.00	
(1480, 1680, 2188, 2388 Late)	Feederhouse Chain Roller Kit 3 Chain Roller Kit, 47" Wide	AMFCRA-3	\$ 581.00	
(2388, 2588, 5088, 6088, 7088, 7130 - 2011 and Later)	Feederhouse Chain Roller Kit 3 Chain Roller Kit	AMFCRA-4	\$ 632.00	
7010, 7120, 7230, 8120, 8230, 9210, 9230	Feederhouse Chain Roller Kit 4 Chain Roller Kit	AMFCRA-5	\$ 842.00	

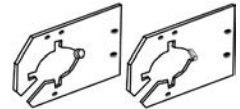

Feederhouse Lower Shafts and Brackets

Application	Description	Part Number	Retail Price	Core
(1440, 1460 - w/ Rock Trap), (1470, 1640, 1660, 1670 - w/ Regular Feederhouse)	Upper Feederhouse Shaft, 61.875" Long	AM1320160C3	\$ 155.00	
1480, 1482 - w/o Feeder Reverser or Rock Trap	Upper Feederhouse Shaft, 65.25" Long	AM197278C1	\$ 110.00	
1480, 1482 - w/ Feeder Reverser and w/ or w/o Rock Trap	Upper Feederhouse Shaft, 70.00" Long	AM1320099C2	\$ 299.68	
1680, 1682, 2188, 2388 BSN JJC0268799	Upper Feederhouse Shaft, 67.625" Long	AM1321440C2	\$ 168.00	
2377, 2388 ASN JJC0268800, 2577, 2588	Upper Feederhouse Shaft, 69.125" Long	AM389071A1	\$ 219.00	
1660, 1666, 1680, 1688, 2188 - w/o Field Tracker	Feederhouse Lower Shaft Bracket, Right Hand	AM1321629C2	\$ 25.00	
	Feederhouse Lower Shaft Bracket, Left Hand	AM138178A1	\$ 25.00	
2144 ASN JJC0173150, 2166, 2188 ASN JJC0193725, 2344, 2366, 2388 BSN JJC0268799	Feeder Pulley, Jackshaft Drive, 13.22" OD Replaces 238967A1	AM238967A2	\$ 184.00	
715, 815, 915, 1440, 1460, 1480	Feeder Shaft 70.00" Long, 1.375" Diameter Replaces 195560C2	AM176571C1	\$ 112.00	
1680, 1688, 2166 BSN 182025, 2188	Feeder Shaft 70.062" Long, 1.50" Diameter	AM1319483C2	\$ 189.00	
2144 ASN JJC0173150, 2166, 2188 ASN JJC0193725, 2344 BSN JJC0174399, 2366 BSN JJC0253999, 2388 BSN JJC0268799	Feeder Shaft, 70.06" Long Replaces 253531A1	AM241931A3	\$ 280.00	
615, 715, 1420, 1440, 1460, 1480	Bearing, Left Hand Feederhouse Jackshaft Replaces 611583R1, 611583R91	AMJD9275	\$ 24.15	
2144 ASN JJC0173149, 2166 ASN JJC0182024, 2188 ASN JJC0193724, 2344, 2366, 2377, 2388, 2577, 2588, 5088, 6088, 7088	Bearing, Feederhouse Jackshaft	AM241929A2	\$ 77.49	
5088, 5130, 5140, 5150, 6088, 6130, 6140, 6150, 7088, 7130, 7140, 7150	Bearing, Feederhouse Upper Shaft 1.75" Hex Bore Diameter	AM87620467	\$ 60.00	

Case IH®—Combine

Rock Drums and Components

Our six-bolt, heavier and stronger rock drums are built to exceed OEM specifications. They can be used for conversion to 3-chain feederhouse chain or for replacing your existing-style damaged or worn out rock drum.

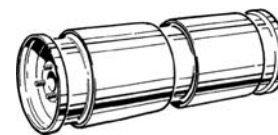

Application	Description	Part Number	Retail Price	Core
1420, 1440, 1460, 1470, 1620, 1640, 1644, 1660, 1666, 2144, 2166	Smooth Drum	AM1957437C1	\$ 357.00	
	Two Recess Drum	AM1957439C1	\$ 459.00	
1420, 1440, 1470, 1620, 1640, 1644, 1660, 1666, 2144, 2166, 2344, 2366	Rock Drum Shaft 35.75" Long, 1.25" Diameter	AM187207C2	\$ 68.00	
1480, 1482, 1680, 1682, 1688, 2188	Two Recess Drum	AM1957440C3	\$ 620.00	
1480, 1482, 1680, 1682, 1688, 2188, 2388, 2588	Smooth Drum	AM1957438C1	\$ 291.00	
	Three Recess Drum	AM196409A2	\$ 597.00	
	Rock Drum Shaft 45" Long, 1.25" Diameter	AM187208C2	\$ 71.00	
1482, 1680, 1688, 2188, 2377, 2388, 2577, 2588	Rock Drum Shaft 59" Long Replaces 1320129C1, 1320129C2	AM389022A1	\$ 200.00	
1660, 1644, 1680, 1688, 2144, 2166, 2188, 2344, 2366, 2388	Rock Drum Arm	Right Hand	AM1338288C3	\$ 138.00
		Left Hand	AM1338287C3	\$ 138.00
	Rock Drum Arm Hardware Kit Needed for installation on early machines w/ 1" diameter shaft, recommended for all other models	HW921-003	\$ 36.00	
1644, 1660, 1680, 1688, 2144, 2166, 2188, 2344, 2366, 2388	Rock Drum Arm Rice w/ Trash Shield	Right Hand	AM1319876C5	\$ 204.00
		Left Hand	AM1319875C5	\$ 200.00
	Rock Drum Arm Hardware Kit Needed for installation on early machines w/ 1" diameter shaft, recommended for all other models	HW921-003	\$ 36.00	
1420, 1440, 1460, 1480, 1620, 1640, 1644, 1660, 1666, 1680, 1688, 2144, 2166, 2188, 2344, 2366	Drum Arm Pivot Spacer 1.81" Long, 0.656" ID, 0.875" OD Replaces 187217R1	AM187217C1	\$ 4.16	
7010, 7120, 7230, 7240, 8010, 8230, 8240, 9010, 9120, 9230, 9240, AFX8010	Drum Arm Spacer 1.07" Long, 0.656" ID, 1" OD Replaces 86621437, 87013282	AM87021332	\$ 9.25	
7010, 8010, AFX8010	Feeder Drum 51.50" Long, 8" Tube Diameter, 9" Ring Diameter Replaces 87283559, 87283558, 87107284, 86995659	AM87660197	\$ 771.65	
7120, 7230, 7240, 8120, 8230, 8240, 9120, 9230, 9240	Feeder Drum Replaces 87640483	AM84294425	\$ 947.46	
7010, 7120, 7230, 7240, 8010, 8120, 8230, 8240, 9010, 9120, 9230, 9240, AFX8010	Feeder Drum Shaft 53.19" Long	AM87646024	\$ 318.23	
7010, 8010, 9010, AFX8010	Feeder Roller Arm Replaces 86995909, 87107279, 87281704	AM87282449	\$ 137.35	
1620, 1640, 1644, 1660, 1666, 1670, 1680, 1688, 2144, 2166, 2188, 2344, 2366, 2377, 2388, 2577, 2588	Bearing Flange 3.562" ID, 2.327" OD Replaces 187195C2, 187196C1, 1319861C2	AM1330461C1	\$ 6.25	
7010, 7120, 8010, 8120, 9120, AFX8010	Front Bracket, Feed Drum Tensioner	AM84075251	\$ 7.66	
	Rear Bracket, Feed Drum Tensioner	AM87644200	\$ 25.99	
5088, 5130, 5140, 5150, 6088, 6130, 6140, 6150, 7088, 7130, 7140, 7150	Bearing, Feederhouse Upper Shaft 1.75" Hex Bore Diameter	AM87620467	\$ 60.00	







Case IH®—Combine



Feederhouse Bottoms





Application	Description	Part Number	Retail Price	Core
1420, 1440, 1460, 1620, 1640, 1644, 1660, 1666	Feederhouse Bottom 35 9/16" x 43 1/2"	AM1324576C1	\$ 326.00	
1420, 1440, 1460, 1620, 1640, 1644, 1660, 1666, 2144, 2166, 2344, 2366	Feederhouse Bottom 35 9/16" x 51 1/4"	AM1324578C2	\$ 352.00	
1480, 1482, 1680, 1688, 2188, 2388, 2588	Feederhouse Bottom 44 3/4" x 51 1/2"	AM1324572C1	\$ 434.00	
1680, 1688, 2188, 2388, 2588	Feederhouse Bottom 44 3/4" x 56 3/4"	AM1324574C2	\$ 464.00	
2144, 2166, 2344, 2366	Feederhouse Bottom 35 9/16" x 56 3/4"	AM1994217C2	\$ 450.00	
5130, 5140, 5150, 6088, 6130, 6140, 6150, 7088, 7130, 7140, 7150 - w/o Rock Trap	Feederhouse Bottom Replaces 87666921	AM87727365	\$ 1100.00	
7010, 7120, 7230, 7240, 8010, 8120, 8230, 8240, 9120, 9230, 9240, AFX8010	Feederhouse Bottom, Center 53.50" Long, 28.90" Wide Replaces 87282536, 86995577	AM87282537	\$ 605.00	
7010, 7120, 8010, 8120, 9010, 9120, AFX8010 - w/ Rock Trap	Feederhouse Bottom, Rear Replaces 86995578, 87533212	AM87673525	\$ 252.01	
7010, 7230, 7240, 8010, 8120, 8230, 8240, 9230, 9240, AFX8010	Feederhouse Bottom, Front Replaces 87393958	AM84140379	\$ 898.46	
7120, 7230, 7240, 8120, 8230, 8240, 9120, 9230, 9240 - w/ Rock Trap	Feederhouse Bottom, Rear	AM84376397	\$ 269.30	
(7230, 8230, 9230 - w/ Common Cab), 7240, 8240, 9240	Feederhouse Bottom	AM47594973	\$ 650.00	
7010, 7120, 7230, 7240, 7250, 8010, 8120, 8230, 8240, 8250, 9120, 9230, 9240, 9250, AFX8010	Feederhouse Floor Liner Kit Bolt-On or Weld-In	AMX29169	\$ 1380.00	

Feed Reverser Components

	Application	Description	Part Number	Retail Price	Core
	1440, 1460, 1480, 1620, 1640, 1644, 1666, 1660, 1680, 1688, 2144, 2166, 2188, 2366, 2388	Reverser Motor All IH Rotary Models w/ Electric Reverser	AM245927C91	\$ 264.00	
	1420, 1440, 1460, 1480, 1620, 1640, 1644, 1660, 1666, 1680 BSN JJC0045689, 2144, 2166, 2188, 2344 BSN JJC0174399, 2366 BSN JJC0253999, 2388 BSN JJC0268799	Flywheel, Feed Reverser Motor 133 Tooth, 1.502" Bore Diameter, w/ Keyway Replaces 1321537C91	AM1321537C92	\$ 315.22	
	1420, 1440, 1460, 1480, 1620, 1640, 1644, 1660, 1666, 1680, 1688, 2144, 2166, 2344, 2366, 2388 BSN HAJ0292001 - w/ or w/o Rock Trap	Feed Reverser Drive Sprocket 20 Tooth	AM1329717C1	\$ 77.00	
	1644, 1666, 1688, 2144, 2166, 2188, 2344, 2366, 2377, 2388, 2577, 2588	Feed Reverser Rock Trap Drive Sprocket 30 Tooth	AM125407A1	\$ 70.00	
	1420, 1440, 1460, 1480, 1620, 1640, 1660, 1666, 1680, 1682, 1688, 2144, 2166, 2188, 2344, 2366, 2388 - w/ Rock Trap	Feed Reverser Idler Sprocket 0.625" Bore	AM541857R92	\$ 17.00	
	1640, 1644, 1660, 1666, 1680, 2144, 2166, 2188, 2344, 2366, 2388 BSN JJC0268799 - w/ Rock Trap	Feed Reverser Idler Sprocket 1.312" Bore	AM1321531C93	\$ 77.00	
	1420, 1440, 1460, 1480, 1620 ASN 0032630, 1640, 1644, 1660, 1670, 1680, 1682, 1688, 2144, 2166, 2188, 2344, 2366, 2377, 2388 BSN JJC0276540 - w/ Rock Trap	Feed Reverser Sprocket 20 Tooth	AM1329719C2	\$ 46.00	

Prices Subject to Change without Prior Notice. The use of original equipment manufacturer (OEM) part numbers or trademarks, e.g. Case® and John Deere®, are for reference purposes only and for indicating product use and compatibility. Our company and the listed replacement parts contained herein are not sponsored, approved or manufactured by the OEM. All parts are New unless designated Reman in the description.

Case IH®—Combine

Application	Description	Part Number	Retail Price	Core
 1420, 1440, 1460, 1480, 1620, 1640, 1644, 1666, 1680, 1682, 1688, 2144, 2166, 2188, 2344, 2366, 2377, 2388, 2577 - w/ or w/o Rock Trap	Feed Reverser Sprocket 40 Tooth	AM1329720C2	\$ 97.00	
 2344 ASN JJC0174400, 2366 ASN JJC0254000, 2377 ASN HAJ0292001, 2388 ASN HAJ0292001 & ASN JJC0268800, 2577, 2588, Cotton Pickers: (420, CPX420 ASN Y6T011117, CPX620 ASN Y6T011706 - Fan Engagement)	Feed Reverser Gearbox Cylinder	AM87449896	\$ 235.00	
 1420, 1440, 1460, 1480, 1620, 1640, 1644, 1660, 1666, 1680, 1682, 1688, 2144, 2166, 2188, 2344, 2366, 2388	Feeder Reverser Shaft 13" Long	AM1321534C1	\$ 61.00	
2344 ASN JJC0174400, 2366 ASN JJC0254000, 2377, 2388, 2577, 2588	Feeder Reverser Shaft 31 Spline	AM681639	\$ 617.41	
 2344, 2366, (2377, 2388 SN HAJ292001-HAJ300000), 2577, 2588	Feed Reverser Gear 32 Tooth, 6 Spline Hub, 8.335" OD Replaces 80681627	AM681627	\$ 517.54	
1420, 1440, 1460, 1620, 1640, 1644, 1660, 1666, 2144, 2166, 2344, 2366	Feed Plate Door Hinge Replaces 193364C1	AM193364C2	\$ 94.68	

Cylinder Bars and Kits

All bars are carefully checked and sets are matched for equal weight distribution on the cylinder prior to shipment. Grade 8 fasteners are supplied for most models.



Application	Description	Part Number	Retail Price	Core
1420, 1620	Cylinder Bar Kit (8) Helical and (8) Straight Bars w/ Mounting Fasteners	Standard AMOIHC-1420	\$ 448.01	
1440, 1460, 1470, 1640, 1644, 1660, 1666, 2144, 2166, 2344, 2366	Cylinder Bar Kit, Grain (12) Helical and (9) Straight Bars w/ Mounting Fasteners	Hardened AMB93417	\$ 469.00	
		Chrome AMB93869	\$ 965.00	
	Cylinder Bar Kit, Soybean (12) Helical and (3) Straight Bars w/ Mounting Fasteners	Hardened AMB93419	\$ 275.00	
1480, 1482, 1680, 1682, 1688, 2188, 2388, 2588	Cylinder Bar Kit, Grain (16) Helical and (12) Straight Bars w/ Mounting Fasteners	Hardened AMB93418	\$ 638.00	
		Chrome AMB93870	\$ 1275.00	
1480, 1482, 1680, 1688, 2188, 2377, 2388, 2577, 2588	Helical Cylinder Bar 120° Pitch Corn and Grain	AM1308830C2	\$ 27.84	
1420, 1440, 1480, 1620, 1640, 1644, 1660, 1666, 1680, 1688, 2144, 2166, 2188, 2344, 2366, 2377, 2388, 2577, 2588	Straight Rotor Bar Corn and Grain Replaces 1309123C1 (Hardened)	AM1308668C1	\$ 30.00	
1640, 1644, 1660, 2144, 2166, 2344, 2366	Helical Rotor Bar Corn and Grain	AM1308829C2	\$ 24.00	



Concave Sets

Application	Description	Part Number	Retail Price	Core
1420, 1620	Middle/Rear Wires are 1/8" Lower than OEM Concaves Replaces 193986C4, 1319187C1, 1319187C2	AM193986C5	\$ 585.23	

Case IH®—Combine

Application	Description	Part Number	Retail Price	Core
1440, 1460, 1470, 1640, 1644, 1660, 1666, 1670, 2144, 2166, 2344, 2366 Note: Concaves will accept bolt-on extensions	Concave Set, Set of 3, Small Wire	AMB93571	\$ 1450.00	
	Front, Small Wire	AM1309208C3	\$ 740.00	
	Concave Lip	AMX27518	\$ 60.00	
	Middle/Rear, Small Wire	AM1309210C3	\$ 600.00	
	Concave Set, Set of 3, Large Wire	AMB93572	\$ 1385.00	
	Front, Large Wire	AM1302606C5	\$ 510.00	
	Concave Lip	AMX27518	\$ 60.00	
	Middle/Rear, Large Wire	AM1302607C4	\$ 695.00	
1480, 1482, 1680, 1682, 1688, 2188, 2388, 2588 Note: Concaves will accept bolt-on extensions	Concave Set, Set of 3, Small Wire	AMB93573	\$ 1450.00	
	Front, Small Wire	AM1309204C3	\$ 700.00	
	Concave Lip	AMX27519	\$ 65.00	
	Middle/Rear, Small Wire	AM1309207C3	\$ 695.00	
	Concave Set, Set of 3, Large Wire	AMB93574	\$ 1450.00	
	Front, Large Wire	AM193782C6	\$ 730.00	
	Concave Lip	AMX27519	\$ 65.00	
	Middle/Rear, Large Wire	AM193783C5	\$ 525.00	
1640, 1644, 1660, 1666, 1670, 2144, 2166, 2366 Note: Concaves have built-in extension	Concave Set, Set of 3, Small Wire	AMB96130	\$ 1450.00	
	Front, Small Wire	AM430960A1	\$ 635.00	
	Concave Lip	AMX27516	\$ 70.00	
	Middle/Rear, Small Wire	AM430963A1	\$ 592.00	
	Concave Set, Set of 3, Large Wire	AMB96128	\$ 1450.00	
	Front, Large Wire	AM430964A1	\$ 555.00	
	Concave Lip	AMX27516	\$ 70.00	
	Middle/Rear, Large Wire	AM430965A1	\$ 505.00	
1640, 1644, 1660, 1666, 2144, 2166, 2344 ASN JJC0174451, 2366 ASN JJC0255001	Concave Set, Set of 3 Round Bar Replaces 87495745, 87495763	AM87299958	\$ 1648.47	
1680, 1682, 1688, 2188, 2377, 2388, 2577, 2588, 5088, 5130, 5140, 5150, 6088, 6130, 6140, 6150, 7088, 7130, 7140, 7150 Note: Concaves have built-in extension	Concave Set, Set of 3, Small Wire	AMB96127	\$ 1650.00	
	Front, Small Wire	AM418647A1	\$ 724.00	
	Concave Lip	AMX27515	\$ 80.00	
	Middle/Rear, Small Wire	AM418648A1	\$ 709.00	
	Concave Set, Set of 3, Large Wire	AMB96125	\$ 1450.00	
	Front, Large Wire	AM386188A1	\$ 648.00	
	Concave Lip	AMX27515	\$ 80.00	
	Middle/Rear, Large Wire	AM386189A1	\$ 627.00	
1680, 1682, 1688, 2188, 2377, 2388, 2577, 2588, 5088, 6088, 6130, 6140, 7088, 7130, 7140	Concave Set, Set of 3 Round Bar Replaces 412395A1, 87360523, 87456655	AM87298938	\$ 1825.00	
7010, 7120, 7230, 7240, 8010, 8120, 8130, 8230, 8240, 9120, 9130, 9230, AFX8010	Concave, Hardened Large Wire, (2) Required	Right Hand Left Hand	AM86976414 AM86976416	\$ 388.00 \$ 388.00
	7010, 7120, 7230, 7240, 7250, 8010, 8120, 8130, 8230, 8240, 8250, 9010, 9120, 9130, 9230, 9240, 9250, AFX8010	Concave, Hardened Small Wire, (2) Required	Right Hand Left Hand	AM86976418 AM86976420
7010, 7120, 7230, 7240, 7250, 8010, 8120, 8130, 8240, 8250, 9010, 9120, 9130, 9230, 9240, 9250, AFX8010		Concave, Extended Wear Round Bar, (2) Required	Right Hand Left Hand	AM87600863 AM87600861

Case IH®—Combine

Concaves—Helical

Application	Description	Part Number	Retail Price	Core
1640, 1644, 1660, 1670, 2144, 2166, 2366	Helical Concave, Front Narrow Space w/o Extension	AMCIHCH-1640-F	\$ 1066.18	
1680, 1682, 1688, 2188, 2388, 2577, 2588	Helical Concave, Front Narrow Space w/o Extension	AM418647A1H	\$ 1015.00	
7010, 7120, 7230, 8010, 8120, 8130, 8230, 9120, 9130, 9230, AFX8010	Helical Concave, Front Corn and Bean	Right Hand	AM86976414H	\$ 317.86
		Left Hand	AM86976416H	\$ 801.87
7010, 7120, 7230, 7240, 7250, 8010, 8120, 8130, 8230, 8240, 8250, 9010, 9120, 9130, 9230, 9240, 9250, AFX8010	Helical Concave Small Grain	Right Hand	AM86976418H	\$ 663.00
		Left Hand	AM86976420H	\$ 663.00

Concave Components

Application	Description	Part Number	Retail Price	Core
1440, 1460, 1470	Concave Cover Plate Will Fit OEM, Loewen and Helical Rotary Concaves	AMFPIHC-1440	\$ 54.04	
1640, 1644, 1660, 1666, 2144, 2166, 2344, 2366	Concave Cover Plate For 1-Piece Concaves w/o bolt-in Extension Will Fit OEM, Loewen and Helical Rotary Concaves	AMFPIHC-1640-1	\$ 55.71	
	Concave Cover Plate For 2-Piece Concaves w/ bolt-on Extensions Will Fit OEM, Loewen and Helical Rotary Concaves	AMFPIHC-1640	\$ 74.08	
1680, 1688, 2188, 2388	Concave Cover Plate For 1-Piece Concaves w/o bolt-in Extension Will Fit OEM, Loewen and Helical Rotary Concaves	AMFPIHC-1680-1	\$ 56.42	
	Concave Cover Plate For 2-Piece Concaves w/ bolt-on Extensions Will Fit OEM, Loewen and Helical Rotary Concaves	AMFPIHC-1680	\$ 70.93	
2577, 2588, 5088, 5130, 5140, 6088, 6130, 6140, 7088, 7130, 7140	Concave Support Plate Replaces 1318433C1, 1318433C2, 1318433C3	AM87627461	\$ 210.00	
7010, 7120, 7230, 7240, 8010, 8120, 8230, 8240, 9010, 9120, 9230, 9240, AFX8010	Concave Cover Plate	AM87748386	\$ 100.00	
7010, 7120, 7230, 8010, 8120, 8230, 9120, 9230	Front Module Curve Plate AR200 Steel Weld-In	AMX29152	\$ 360.00	
1640, 1644, 1666, 2144, 2166, 2366	Concave Extensions, Narrow - Set of 3	AMB94536	\$ 618.92	
	Concave Extensions, Wide - Set of 3	AMB94534	\$ 679.25	
1680, 1682, 1688, 2188, 2388	Concave Shock Kit	AMCSK-700	\$ 304.29	
7010, 7120, 8010, 8120, 9010, 9120, AFX8010	Potentiometer, Concave Position	AM86998035	\$ 80.00	

Rotor Bars—Standard Rotors

These rotor bars are for standard rotors. They are available in standard, hardened and chrome alloy. Sold and priced individually. Hardware is not included.



Application	Description	Part Number	Retail Price	Core
1420, 1440, 1460, 1480, 1620, 1640, 1644, 1660, 1666, 1670, 1680, 1688, 2144, 2166, 2188, 2344, 2366, 2388 (3) Required on 40 & 60 Series (4) Required on 20 & 80 Series	Toothed Rotor Bar	AM1302103C1	\$ 30.50	
1420, 1440, 1460, 1470, 1480, 1482, 1620, 1640, 1644, 1660, 1666, 1670, 1680, 1682, 1688, 2144, 2166, 2188, 2344, 2366, 2388, 2588 (3) Required on 40 & 60 Series (4) Required on 20 & 80 Series	Smooth Rotor Bar, 42" Long	Hardened	AM1303038C2	\$ 30.00
	Smooth Rotor Bar, 42" Long	Chrome	AM1324580C1	\$ 126.01

Case IH®—Combine

Rotor Bars—Specialty Rotors

These ductile bars meet or exceed OEM specifications. Most applications and crop conditions require bars with no spikes. Crops with excessive green material might require bars with spikes to prevent roping. Sold and priced individually.



Application	Description		Part Number	Retail Price	Core
1420, 1440, 1460, 1470, 1480, 1620, 1640, 1644, 1660, 1666, 1670, 1680, 1682, 1688, 2144, 2166, 2188, 2344, 2366, 2388, 2588, 5088, 5130, 5140, 5150, 6088, 6130, 6140, 6150, 7010, 7088, 7120, 7140, 7150, 7230, 7240, 7250, 8120, 8230, 8240, 8250, 9120, 9230, 9240, 9250, AFX8010	Specialty Rasp Bar w/ Spike	Hardened	AM1309175C1	\$ 13.00	
		Chrome	AM1968970C1	\$ 20.00	
	Specialty Rasp Bar w/o Spike Replaces 1309336C1 (Hardened)	Hardened	AM84164540	\$ 13.00	
		Chrome	AM278821A2	\$ 20.00	
5088, 5130, 5140, 5150, 6088, 6130, 6140, 6150, 7010, 7088, 7120, 7130, 7140, 7150, 7230, 7240, 7250, 8010, 8120, 8230, 8240, 8250, 9120, 9230, 9240, 9250	Rasp Bar w/ Spike For Small Diameter Rotor Replaces 47603368	Hardened	AM87368806	\$ 38.46	
5140, 6140, 7010, 7120, 7140, 7230, 7240, 8010, 8120, 8230, 8240, 9010, 9120, 9230, 9240	Rasp Bar, Grain For Small Diameter Rotor	Hardened	AM87368807	\$ 43.08	
1440, 1460, 1470, 1640, 1644, 1660, 1666, 1670, 2144, 2166, 2344, 2366 (3) Required on 40 & 60 Series	Helical Kicker Plate	Standard	AM1317690C1	\$ 95.38	
		Chrome	AM1968967C1	\$ 127.50	
1480, 1482, 1680, 1682, 1688, 2188, 2377, 2388, 2588, 5088, 5130, 5140, 6088, 6130, 6140, 7010, 7088, 7120, 7130, 7140, 7230, 7240, 8010, 8120, 8230, 8240, 9120, 9230, 9240 (2) Required on 80 Series	Helical Kicker Plate Replaces 86992048	Hardened	AM1327676C1	\$ 50.00	
1480, 1482, 1680, 1682, 1688, 2188, 2377, 2388, 2588, 5088, 5130, 6088, 6130, 7010, 7088, 7120, 7130, 7230, 8010, 8120, 8230, 9120, 9230 (2) Required on 80 Series	Helical Kicker Plate Replaces 86992048	Tungsten Carbide	AM1968968C2	\$ 133.00	
1420, 1440, 1460, 1470, 1480, 1620, 1640, 1644, 1660, 1666, 1670, 1680, 1682, 1688, 2144, 2166, 2188, 2344, 2366, 2377, 2388, 2577, 2588, 5088, 6088, 7010, 7088, 7230, 8010, 8120, 8230, 9120, 9230 (2) Required on 1620 (3) Required on 40 & 60 Series (4) or (8) Required on 80 Series	Straight Separator Rotor Bar w/o Hardware Replaces 86992047	Standard	AM1318976C1	\$ 46.00	
		Chrome	AM1968969C2	\$ 112.00	
5088, 5130, 5140, 6088, 6130, 6140, 7010, 7088, 7120, 7130, 7140, 8010, 8120, 9010, 9120	Rotor Bar Straight Shoe, Small Grain Small Tube, Abrasion Resistant 22.638" ID		AM87602594	\$ 46.77	
5088, 5130, 5140, 6088, 6130, 6140, 7088, 7130, 7140	Extension, Inlet Flighting		AM84162517	\$ 90.00	
1420, 1440, 1460, 1470, 1480, 1620, 1640, 1644, 1660, BSN JJC0038346, 1666, 1670, 1680, 1682, 1688, 2144, 2166, 2188, 2344, 2366, 2388 BSN JJC0272999, 5130, 5140, 6130, 6140, 7130, 7140, 7230, 7240, 8230, 8240, 9230, 9240	Rotor Bar Bolt 1/2"-13 x 1 1/4" Flanged Hex Bolt, Grade 8		AM87302717	\$ 2.00	
		Rotor Bar Nut 1/2" NC Flanged Hex Nut, Self-Locking, Grade 8	AM186852C1	\$ 1.25	
2366, 2377, 2388, 2577, 5088, 5130, 5140, 6088, 6130, 6140, 7010, 7088, 7120, 7130, 7140, 7230, 7240, 8010, 8120, 8230, 8240, 9120, 9230, 9240, AFX8010 - w/ Metric Hardware	Rotor Bar Bolt M12x35 mm, 10.9 Grade, Full Thread		AM86981487	\$ 2.00	

Rotor Grates and Components

Slotted grates perform well under grain harvesting conditions, while the keystack grates are better for corn, soybeans, rice and milo. The shredder grate replaces the rear grate and has a unique keystack grate and blade system that will thoroughly shred the stalks. Installation requires less than an hour and is an alternative to purchasing a more expensive straw chopper.



Application	Description		Part Number	Retail Price	Core
1420, 1620	Rotor Grates, Keystack - Set of 3 OEM Style		AM1303002C3	\$ 655.00	
1440, 1460, 1640, 1644, 1660, 1666, 2144, 2166, 2344, 2366	Rotor Grates, Keystack - Set of 3 OEM Style		AM1302562C1	\$ 665.00	
		Rotor Grates, Slotted - Set of 3	AM191538C3	\$ 689.00	

Case IH®—Combine

Application	Description	Part Number	Retail Price	Core
1480, 1482, 1680, 1682, 1688, 2188, 2388, 2588, 5088, 6088, 6130, 7088, 7130	Rotor Grates, Keystock - Set of 3 OEM Style	AMB95337	\$ 730.00	
	Rotor Grates, Slotted - Set of 3	AMB95336	\$ 1000.00	
7010, 7120, 8010, 8120, 9120, AFX8010	Rotor Gate, Slotted, Right Hand (2) Required Replaces 84247318	AM87000774	\$ 429.61	
	Rotor Gate, Slotted, Left Hand (2) Required Replaces 84247317	AM87000772	\$ 453.46	
1440, 1460, 1640, 1644, 1660, 1666, 2144, 2166, 2344, 2366	Rotor Gate Cover Plate Replaces 1319750C1	AMCPGIHC-1440	\$ 68.23	
1480, 1680, 1688, 2188, 2388	Rotor Gate Cover Plate Replaces 1319405C1	AMCPGIHC-1480	\$ 70.12	
1440, 1460, 1470, 1480, 1482, 1640, 1644, 1660, 1666, 1680, 1682, 2144, 2166, 2188, 2344, 2366, 2388	Channel for Slotted Grates Individual Channel, Hardware Not Included	AM191536C1	\$ 6.00	

Impeller Blade Kits (Elephant Ears)

Elephant Ears/Blade Kits are manufactured with abrasive-resistant steel for longer wear. High-strength, grade 8 hardware included. Hard chrome available upon request.



Application	Description	Part Number	Retail Price	Core
1420, 1620	Impeller Blade Kit (Elephant Ears) Set of 2 Blades w/ Hardware	AM1957447C2	\$ 295.00	
1440, 1460, 1640, 1644, 1660, 1666, 2144, 2166, 2344, 2366	Impeller Blade Kit (Elephant Ears) Set of 3 Blades w/ Hardware	AM1957446C3E	\$ 530.00	
1480, 1482, 1680, 1682, 1688, 2188, 2388, 2588	Impeller Blade Kit (Elephant Ears) Set of 2 Blades w/ Hardware	AM1957445C3E	\$ 332.00	
1480, 1482, 1680, 1682, 1688, 2188, 2388, 2588	Impeller Blade Kit (Elephant Ears) Set of 2 Chrome Blades w/ Hardware	AM195445C3EC	\$ 621.29	
1480, 1680, 1688, 2188, 2388, 2588, 5088, 6088, 7088 - w/ AFX Rotor	Impeller Blade Kit (Elephant Ears) Set of 2 Blades w/ Hardware	AM434525A3	\$ 501.54	
2366 w/ AFX Rotor	Impeller Blade Kit (Elephant Ears) Set of 2 Blades w/ Hardware	AM87308133	\$ 603.97	
7010, 7120, 7230, 7240, 8010, 8120, 8230, 8240, 9010, 9120, 9230, 9240, AFX8010	Impeller Blade Kit (Elephant Ears) Includes (2) Impeller Blades, (2) Wear Bars and Hardware Replaces 48119581, 84084819, 87315733, 87376706	AM87715003	\$ 795.00	

Wear Bars

Wear bars are made of hardened, abrasive-resistant steel for longer wear. They are easy to install, and high-strength grade 8 hardware is included. Wear bars are available in regular or large size to cover more of the blade (elephant ear) and protect it from excessive wear.

Application	Description	Part Number	Retail Price	Core
60 Series	Wear Bar Kit, KRF	AMX27188	\$ 335.00	
80 Series	Wear Bar Kit, KRF	AMX27189	\$ 310.00	
1420, 1620	Wear Bars, Set of 2	Chrome AM1309185C2	\$ 105.00	
1440, 1460, 1640, 1644, 1660, 1666, 2144, 2166, 2344, 2366	Wear Bars, Set of 3	Hardened AMB94524	\$ 130.00	
		Chrome AMB94525	\$ 205.00	
1480, 1482, 1680, 1682, 1688, 2188, 2388	Wear Bars, Set of 2	Hardened AMB94526	\$ 102.00	
		Chrome AMB94527	\$ 163.00	
6140, 7010, 7120, 7140, 7230, 7240, 8010, 8120, 8230, 8240, 9120, 9230, 9240, AFX8010	Wear Bars, Set of 2 Replaces 87297735, 87297735A	AM87376702	\$ 153.00	

Case IH®—Combine



Rotor Transition Cones and Components

Rotor cones are made of abrasive-resistant steel. The 5/32" cone with one welded seam compares to OEM 3 or 5 seam cones. The 3/16" cone with one welded seam compares to OEM rice cones. The 1/4" cone with one welded seam does not have an OEM comparison.

Application	Description	Part Number	Retail Price	Core
1420, 1620	Rotor Transition Cone Vane Kit - 3/16" Set of 6 Includes Mounting Hardware	AMCPRK-1420	\$ 251.33	
1440, 1460, 1640, 1660, 1644, 1666, 2144, 2166, 2344, 2366	Rotor Transition Cone Vane Kit - 1/8" Complete set of vanes and hardware	AMB93193	\$ 256.82	
	Rotor Transition Cone Vane Kit - 3/16" Complete set of vanes and hardware	AM87328881	\$ 264.09	
1440, 1460, 1640, 1644, 1660, 1666, 2144, 2166, 2344, 2366	Rotor Transition Cone Vane Kit - 3/16", Stainless Steel Complete set of vanes and hardware, Includes wear resistant T-bolts	AM321933A1	\$ 561.54	
1480, 1482, 1680, 1682, 1688, 2188, 2388	Rotor Transition Cone Vane Kit - 3/16" Complete set of vanes and hardware	AM437319A2	\$ 315.38	
1480, 1482, 1680, 1682, 1688, 2188, 2388	Rotor Transition Cone Vane Kit - 3/16", Stainless Steel Complete set of vanes and hardware, Includes wear resistant T-bolts Cones w/ 5/16" holes must be drilled out for 3/8" bolts	AM428875A2	\$ 753.00	
7010, 7120, 7230, 7240, 8010, 8120, 8230, 8240, 9230, 9240	Rotor Transition Cone Vane Kit - 3/16", Stainless Steel Complete set of vanes and hardware	AM87298773	\$ 578.00	
1440, 1460, 1470, 1640, 1644, 1660, 1666, 1670, 2144, 2166, 2344, 2366	Front Cone Vane, Upper	AM186985C3	\$ 40.40	
1440, 1460, 1470, 1620, 1640, 1644, 1660, 1666, 1670, 2144, 2166, 2344, 2366	Cone Vane Extension	AM186984C1	\$ 16.98	
7010, 7120, 7230, 7240, 8010, 8120, 8230, 8240, 9120, 9230, 9240, AFX8010	Rotor Transition Cone Vane, Stainless Steel (5) Required Replaces 87350845	AM87053359	\$ 95.00	
1440, 1460, 1640, 1660, 1644, 1666, 2144, 2166, 2344, 2366	Rotor Transition Cone 1/4" Wall Thickness, Includes 3/16" vanes	AMB92770	\$ 2135.00	
1480, 1482, 1680, 1682, 1688, 2188, 2388, 2588, 5088, 6088, 7088	Rotor Transition Cone 1/4" Wall Thickness, Includes 3/16" vanes	AM443123A1	\$ 2106.00	
7010, 7120, 7230, 7240, 7250, 8010, 8120, 8230, 8240, 8250, 9120, 9230, 9240, 9250, AFX8010	Rotor Transition Cone Extended Wear, Rice Includes 3/16" Stainless Steel Vanes Replaces 47843259, 84598183, 87053359, 87382439	AM87390937E	\$ 2345.08	
	Transition Cone Guard Set of 5 Panels 10-Gauge Abrasion-Resistant Steel Bolt-In w/ Pre-Drilled Holes	AMX29087	\$ 1632.00	
7010, 7120, 7230, 7240, 8010, 8120, 8230, 8240, 9010, 9120, 9230, 9240	Transition Cone Deflector, Right Hand Standard Wear Replaces 86980992, 87281152, 87324947	AM87524461	\$ 573.05	
	Transition Cone Deflector, Left Hand Standard Wear Replaces 86976155, 87281151, 87324946	AM87524460	\$ 531.38	
7010, 7120, 7230, 7240, 8010, 8120, 8230, 8240, 9010, 9120, 9230, 9240, AFX8010	Transition Cone Deflector, Right Hand Extended Wear Replaces 87281152, 87385250	AM87517351	\$ 567.93	
	Transition Cone Deflector, Left Hand Extended Wear Replaces 87354969, 87524460	AM87517350	\$ 526.64	

Case IH®—Combine

Application	Description	Part Number	Retail Price	Core
2366, 2377 SN HAJ292001-HAJ300000, 2388, 2577, 2588, 5088, 5130, 5140, 6088, 6130, 6140, 7088, 7130, 7140	Stiffener Vane - 3/16" Short Extension, Stainless Steel For Transition/Rotor Cone Replaces 411517A2	AM411518A2	\$ 23.06	
	Stiffener Vane - 3/16" Stainless Steel For Cone, Short Replaces 418655A1	AM418655A2	\$ 77.66	
	Stiffener Vane - 3/16" Stainless Steel For Cone, Front Replaces 418654A1	AM418654A2	\$ 99.63	
1680 BSN JJC0045689, 1688, 2188, 2377 SN HAJ292001-HAJ300000, 2388, (2577, 2588 ASN HAJ300001), 5088, 5130, 5140, 6088, 6130, 6140, 7088, 7130, 7140	Rotor Front Door Standard Wear Replaces 182974C93, 193607C1, 193607C2	AM193607C3	\$ 182.93	
7010, 7120, 7230, 7240, 7250, 8010, 8120, 8230, 8240, 8250, 9120, 9230, 9240, 9250	Rotor Access Door Liner Extended Wear, AR200 Steel	AMX29150	\$ 635.00	

Vane Transports and Components

Made from abrasive-resistant steel for longer wear. Consider increasing the capacity of your 1400 Series by installing 1600 Series transition cones, concaves, concave support kits and tubes.



Application	Description	Part Number	Retail Price	Core
1420, 1620	Vane Transport Vane Kit Replaces 183295C1, 194192C2, 1303059C1	1/8" AMCPVK-1420	\$ 183.08	
1440, 1460, 1640, 1644, 1660, 1666, 2144, 2166, 2344, 2366	Vane Transport Vane Kit Complete set of vanes and hardware	1/8" AMB94097	\$ 224.89	
	Vane Transport Vane Kit, Stainless Steel Complete set of vanes and hardware Includes wear resistant T bolts	3/16" AMCPVK-1440-3	\$ 310.00	
	Vane Transport Vane Kit, Stainless Steel Complete set of vanes and hardware Includes wear resistant T bolts	3/16" AMB95480	\$ 540.00	
1480, 1482, 1680, 1682, 1688, 2188, 2388, 2588	Vane Transport Vane Kit Complete set of vanes and hardware	1/8" AMB94098	\$ 240.00	
	Vane Transport Vane Kit Complete set of vanes and hardware	3/16" AM87297171	\$ 375.00	
1480, 1482, 1680, 1682, 1688, 2188, 2388	Vane Transport Vane Kit, Stainless Steel Complete set of vanes and hardware Includes wear resistant T bolts	3/16" AM348503A1	\$ 515.00	
1640, 1644, 1660, 1666, 2144, 2166, 2344, 2366	Vane Transport Less Vanes	Right Hand AM1318419C2	\$ 585.00	
		Left Hand AM1318829C2	\$ 675.00	
1680, 1682, 1688, 2188, 2388, 2588, 5088, 5130, 5140, 6088, 6130, 6140, 7088, 7130, 7140	Vane Transport Less Vanes	Right Hand AM1321661C3	\$ 556.00	
		Left Hand AM1318729C5	\$ 561.00	
7010, 7120, 7230, 7240, 8010, 8120, 8230, 8240, 9120, 9230, 9240, AFX8010	Vane Transport Extended Wear, Includes Vanes Replaces 87341408, 86980999	AM87391297	\$ 2652.00	
7010, 7120, 7230, 7240, 8010, 8120, 8230, 8240, 9120, 9230, 9240, AFX8010	Vane For Vane Transport, (11) Required Replaces 87341038	AM87717924	\$ 32.00	
	Vane For Vane Transport, (1) Required	AM87107892	\$ 32.00	
7010, 7120, (7230, 8230, 9230 BSN YDG220143), 8010, 8120, 9010, 9120	Vane Transport	AM87717923	\$ 30.00	
1480, 1482, 1680, 1688, 2188, (2377, 2388 SN HAJ292001-HAJ300000), 2577, 2588	Vane Transport Support, Stainless Steel Replaces 186075C1, 191272C1	3/16" AM186075C2	\$ 14.39	
7010, 7120, 7230, 7240, 7250, 8010, 8120, 8230, 8240, 8250, 9120, 9230, 9240, 9250	Vane Transport Cover Plate Liner 10-Gauge AR450 Steel	AMX29180	\$ 495.00	

Case IH®—Combine

Application	Description	Part Number	Retail Price	Core
2377 SN HAJ292001-HAJ300000, 2388, 2577, 2588, 5088, 5130, 5140, 6088, 6130, 6140, 7088, 7130, 7140	Stiffener Vane Extended Wear, Stainless Steel	3/16" AMX347917A1	\$ 30.55	

Rotor Assemblies and Components





Our AFX Rotors are dynamically balanced at high speed and feature hardened bars to increase capacity.



Application	Description	Part Number	Retail Price	Core
1420, 1620	Rotor Assembly Specialty Rotor Replaces 1317404C93	AM87442191	\$ 3295.00	
1440, 1460, 1640, 1644, 1660, 1666, 2144, 2166, 2344, 2366	Reman Rotor Assembly	Hardened Bars	AMX27272	\$ 4425.00 \$ 500.00
		Hardened Spike Bars	AMX27273	\$ 4425.00 \$ 500.00
1480, 1680, 1688, 2188, (2388, 2588 BSN HAJ303001)	Reman Rotor Assembly, MY2008	Hardened Bars	AMX27282	\$ 5150.00 \$ 500.00
		Hardened Spike Bars	AMX27275	\$ 5150.00 \$ 500.00
1640, 1660, 1670, 1680, 1688, 2144, 2166, 2188, 2344, 2366, 2377, 2388, 2577, 2588	Rotor Drive Coupling Assembly	AM1345307C1	\$ 250.00	
2144, 2166, 2188	Rotor Drive Coupler Kit Heavy Duty Includes Rotor Drive Hub, Plate, (6) Bolts and (12) Washers	AM140500A1	\$ 150.00	
2388 ASN 300001, 2577, 2588, 5088, 5130, 5140, 5150, 6088, 6130, 6140, 6150, 7088, 7130, 7140, 7150	Rotor Drive Coupling, 8-Bolt 23 Spline	AM87619364	\$ 465.00	
7010, 7120, 7230, 7240, 7250, 8010, 8120, 8230, 8240, 8250, 9010, 9120, 9230, 9240, 9250	Rotor Drive Coupling, 8-Bolt 12 Tooth For Small Grain Rotor Assemblies (Standard and Hard Threshing) and Twin Pitch Corn, Grain and Rice (Standard and High Performance) Replaces 7280751	AM84222993	\$ 350.00	
7010, 7120, 7230, 8010, 8120, 8230, 9010, 9230, AFX8010	Rotor Drive Coupling, Splined For Dual Speed Rotor Drive	AM86980985	\$ 82.00	

Rotor Front Kits and Components

Improve the performance of your Case IH® rotary combine with the addition of a KRF Rotor Flight Kit. Both styles offer you improved threshing performance, better distribution and consistent flow of material for smoother operation, while providing reduced horsepower requirements for increased fuel efficiency.

Application	Description	Part Number	Retail Price	Core
 1440, 1460, 1640, 1660, 1666, 2144, 2166, 2344, 2366	KRF Front Rotor Kit	AMX27135	\$ 1435.00	
 1480, 1680, 1688, 2188, 2388, 2588	KRF Front Rotor Kit	AMX27134	\$ 1250.00	
 1440, 1460, 1470, 1480, 1482, 1640, 1644, 1660, 1666, 1670, 1680, 1682, 1688, 2144, 2166, 2188, 2344, 2366	Rotor Gearbox Output Shaft	AM194059C1	\$ 851.38	
 1420, 1440, 1460, 1470, 1480, 1620, 1640, 1660, 1666, 1670, 1680, 1688, 2144, 2166, 2188, 2344, 2366, 2377, 2388	Rotary Bearing Housing Includes Bearing Replaces 251439A3, 87474830, 1309076C1	AM253439A3	\$ 326.00	

Case IH®—Combine

Application	Description	Part Number	Retail Price	Core
 1480, 1482, 1680, 1682, 1688, 2188, 2377 SN HAJ292001-HAJ300000, 2388, 2577, 2588, 5088, 5130, 5140, 6088, 6130, 6140, 7088, 7130, 7140	Lower Rotor Cage Seal Support	AM192385C1	\$ 140.34	
 1680, 1682, 1688, 2188, 2388	Rotor Gearbox Cover	AM182550C2	\$ 418.00	
 1680, 1688, 2188, 2377, 2577, 2588, 5088, 5130, 5140, 6088, 6130, 6140, 7088, 7130, 7140 - w/ AFX Rotor	KFX Rotor Flight Set of 2, Replaceable cast chrome wear plates Includes wear plates, mounting hardware and instructions	AMX27311	\$ 913.00	
 (2377, 2388 BSN HAJ0295001)	Rotor Drive Input Shaft	AM235575A2	\$ 1100.00	
 2377, 2388 ASN JJC0273000, 2577, 2588, 5130, 6088, 6130, 7088, 7130	Pulley Assembly 20.50" OD, For Variable Rotor Drive	AM413164A1	\$ 412.00	
 1620 ASN JJC0022108, 1640, 1644, 1660 ASN JJC0026711, 1666, 1680, 1688, 2144, 2166, 2188, 2344, 2366, 2377, 2388, 2577, 2588, 5088, 5130, 5140, 5150	Rotor Drive Pulley Hub 20 Tooth, 13 Spline, 11.73" Long Replaces 1315291C1, 1315291C2	AM184489C1	\$ 520.00	
 2377 SN HAJ292001-HAJ300000, 2388 BSN JJC0276540 & SN HAJ292001-HAJ300000	Output Gear 58 Tooth Replaces 235581A1	AM235581A2	\$ 496.00	
 1420, 1440, 1460, 1470, 1480, 1620, 1640, 1644, 1660, 1666, 1670, 1680, 1688	Motor, Rotor Speed Adjustment Wire Plugs in Back	AM126573C1	\$ 87.00	
 1420, 1440, 1460, 1470, 1480, 1620, 1640, 1644, 1660, 1666, 1670, 1680, 1688, 2144, 2166, 2188, 2344, 2366, 2388, 2577, 2588	Motor, Rotor Speed Adjustment Wire Plugs in Bottom	AM111787A2	\$ 67.00	
 (2577, 2588 ASN HAJ303001), 5088, 5130, 6088, 6130, 7088, 7130	Fan Speed Actuator	AM87693674	\$ 78.00	
 7010, 7120, 7230, 7240, 7250, 8010, 8120, 8230, 8240 09/2015 and Later, 8250, 9010, 9120, 9230, 9240, 9250, AFX8010	Rotor Impeller Shield	AM87315598	\$ 7.00	
1640, 1644, 1660, 1666, 1670, 1680, 1688, 2144, 2166, 2188, 2344, 2366, 2377, 2388, 2577, 2588	Rubber Insulator For Rotor Drive Hub	AM1345453C1	\$ 9.50	
 1440, 1460, 1480, 1620 ASN JJC0032629, 1640, 1644, 1660, 1666, 1680, 1688, 2144, 2166, 2188, 2344, 2366, 2377, 2388, 2577, 2588, 5088, 5130, 5140, 5150, 6088, 6130, 6140, 6150, 7088, 7130, 7140, 7150	Roller Chain, Rotor Speed Adjustment 34 Links, Size 2040 Chain Replaces B617107R91	AM617107R91	\$ 40.00	
 1620 BSN JJC0032631	Roller Chain, Rotor Speed Adjustment 32 Links, Size 2040 Chain	AMX34133	\$ 20.00	

Case IH®—Combine

Rotor Vane Repair Kits

- Decreases material stalling at transition
- Increases ground speed
- Bolt-on style, no modifications required - works with all crops
- Improves crop material feeding with ALL styles of impellers and flights
- Restores vane to original height



Application	Description	Part Number	Retail Price	Core
60 Series	Rotor Vane Kit, Bolt-On - Set of 3	AMX27190	\$ 360.00	
80 Series	Rotor Vane Kit, Bolt-On - Set of 4	AMX27191	\$ 395.00	

Cleaning Fan Shafts and Components



Application	Description	Part Number	Retail Price	Core
1420, 1440, 1460, 1470, 1480, 1482, 1620, 1640, 1660, 1666, 1670, 1680, 1682, 1688, 2144, 2166, 2188, 2344, 2366, 2388, 2588, 5130, 5140, 6130, 6140, 7130, 7140	Cleaning Fan Hub Assembly	AM185286C91	\$ 92.00	
1660, 2344, 2366, 2377, 2388, 2577, 2588, 5130, 6130, 7130	Cleaning Fan Hub Assembly 1.75" ID, 11.91" OD Replaces 84556153	AM1541552C2	\$ 155.00	
1420, 1440, 1460, 1470, 1480, 1482, 1620, 1640, 1644, 1660, 1666, 1670, 1680, 1682, 1688, 2144, 2166, 2188, 2344, 2366, 2377 SN HAJ292001-HAJ300000, 2388, 2577, 2588, 5088, 5130, 5140, 6088, 6130, 6140, 7088, 7130, 7140	Cleaning Fan Shaft 10" Long Replaces 194853C1, 194853C2	AM194853C3	\$ 97.00	
1440 SN 1501-10000, 1460 SN 1501-12000	Cleaning Fan Shaft	AM183445C2	\$ 84.25	
1480 BSN 14000	Cleaning Fan Shaft	AM191923C2	\$ 108.06	
1480 ASN 24852, 1680	Cleaning Fan Shaft	AM1309015C1	\$ 452.31	
2144, 2166, 2188, 2344, 2366, 2377, 2388	Cleaning Fan Shaft Adjusting Gear	AM142848A1	\$ 68.00	
1420, 1440, 1460, 1470, 1480, 1482, 1620, 1640, 1644, 1660, 1666, 1670, 1680, 1682, 1688, 2144, 2166, 2188, 2344, 2366, 2388	Cleaning Fan Pulley, Variable Speed 2" ID, 11.87" OD	AM183288C1	\$ 47.00	
1420, 1440, 1460, 1480, 1620, 1640, 1644, 1660, 1666, 1680, 1688, 2144, 2166, 2188, 2344, 2366, 2377, 2388, 2588, 5130, 5140, 5150, 6088, 6130, 6140, 6150, 7088, 7130, 7140, 7150	Cleaning Fan Drive Pulley 9.75" OD	AM193948C1	\$ 63.00	
1420, 1440, 1460, 1470, 1480, 1482, 1620, 1640, 1644, 1660, 1666, 1670, 1680, 1682, 1688, 2144, 2166, 2188, 2344, 2366, 2388, 5130, 5140, 6130, 6140, 7130	Cleaning Fan Drive Hub, Fixed	AM183333C1	\$ 102.00	
1420, 1440, 1460, 1480, 1620, 1640, 1660, 1680	Half Sheave, Adjustable 11.24" OD w/o bushings	AM1324948C1	\$ 125.00	
1420, 1440, 1460, 1480, 1620, 1640, 1660, 1680	Half Sheave, Fixed 11.24" OD	AM1324949C1	\$ 87.00	
1640, 1644, 1660 ASN JJC0038346, 1680, 1688, 2144, 2166, 2188, 2344, 2366, 2377 SN HAJ292001-HAJ300000, 2388, 2577, 2588, 5088, 5130, 5140, 6088, 6130, 6140, 7088, 7130, 7140	Half Sheave, Fixed 1.75" ID, 11.90" OD Replaces 1541553C1, 1541553C2	AM87522943	\$ 169.00	
1420, 1440, 1460, 1470, 1480, 1620, 1640, 1644, 1660, 1666, 1670, 1680, 1688, 2144, 2166, 2188, 2344, 2366, 2388, 2577, 2588	Motor, Fan Speed Adjustment Wire Plugs in Bottom	AM111787A2	\$ 67.00	
1420, 1440, 1460, 1470, 1480, 1620, 1640, 1644, 1660, 1666, 1670, 1680, 1688	Motor, Fan Speed Adjustment Wire Plugs in Back	AM126573C1	\$ 87.00	
7010, 7120, 7230, 7240, 8010, 8120, 8230, 8240, 9010, 9120, 9230, 9240, AFX8010	Disc Replaces 86998413	AM86980769	\$ 43.00	

Case IH®—Combine

Application	Description	Part Number	Retail Price	Core
1420, 1440, 1460, 1480, 1620	Bearing, Cleaning Fan Shaft Replaces 610188R91, 70017774, K3315	AM565673R92	\$ 21.29	

Separator Gearbox Components

Application	Description	Part Number	Retail Price	Core
1420, 1440, 1460, 1480, 1620, 1640, 1644, 1660, 1666, 1670, 1680, 1688, 2144, 2166, 2188, 2344, 2366, 2377, 2388	Solid PTO Drive Shaft	AM192816C1	\$ 342.00	
1420, 1440, 1460, 1470, 1620, 1640, 1644, 1660, 1670, 2144, 2166, 2344, 2366	Hydraulic Cylinder For Separator Clutch 2" ID, 12.50" Stroke Replaces 133408C91, 133408C92	AM1346042C1	\$ 325.00	
1420, 1440, 1460, 1480, 1640 BSN 24223, 1660 BSN 26711, 1680 Early - w/o Chopper	Jackshaft	AM1308505C1	\$ 298.87	
1644, 1660 ASN JJC0038345, 1666, 1688, 2144, 2166, 2188, 2344, 2366, 2377, 2388, 2577, 2588	Drive Plate 13 Spline, 13.87" OD Replaces 92590C1, 92590C2, 1251902C1, 1251902C2, 184429C1, 188013C91, 230233A1	AM184429C2	\$ 145.00	
1660 Late, 1666, 2166, 2366	Separator Bevel Gear Set Includes 31 & 41 Tooth Gears	AM184494C1	\$ 620.00	
1688, 2188, 2388 BSN JJC0276540, 2588	Pulley	AM1541713C1	\$ 475.00	
2144, 2166, 2188, 2344, 2366, 2377 SN HAJ292001-HAH300000, 2388, 5088, 5130, 6130, 7130	Bearing, Cam Follower Replaces 418732A1, 1315343C1	AM86582880	\$ 34.50	
2366, 2377 SN HAJ0292001-HAJ030000, 2388 BSN HAJ0300000, 2577, 2588, 5088, 6088, 7088	Shaft, PTO Gearbox Replaces 87603645	AM87589086	\$ 895.00	
(2377, 2388 SN HAJ292001-HAJ300000), 2577, 2588	Pulley 11" Diameter	AM364019A2	\$ 395.00	
5088, 5130, 5140, 6088, 6130, 6140, 7088, 7130, 7140	Pulley	AM87624862	\$ 444.00	
7010, 7120, 8010, 9010	Hydraulic Valve Control Pressure Regulator PTO Charge Regulator Replaces 87283362	AM87645689	\$ 445.00	

Separator Jackshafts, Sheaves and Components

Application	Description	Part Number	Retail Price	Core
1420, 1440, 1460, 1480, 1640 BSN 24223, 1660 BSN 26711, 1680 Early	Half Sheave, 1-Piece Assembly	AM193622C2	\$ 700.00	
1420, 1440, 1460, 1480, 1640 BSN 24223, 1660 BSN 26711, 1680 Early - w/o Chopper	Jackshaft	AM1308505C1	\$ 298.87	
1620 ASN JJC0022115, (1640 BSN JJC0024223 & ASN JJC034704, 1644, 1660 ASN JJC0026711, 1666 - w/o Straw Chopper), 1680 ASN JJC0028497, 1688, 2144, 2166, 2188, 2344, 2366, 2388	Hub Assembly, Rotor Drive Pulley	AM188846C2	\$ 303.00	
2344 ASN JJC0174451, 2366 ASN JJC0255001, 2377 SN HAJ0292001-HAJ0300000, 2388 ASN JJC0270501, 2577, 2588, 5088, 6088, 7088	Hub, Rotor Drive Variator 20 Spline Bore Replaces 47462117	AM87481453	\$ 342.04	
1420, 1440, 1460, 1480, 1620, 1640, 1644, 1660, 1666, 1680, 1688, 2144, 2166, 2188, 2344, 2366, 2377, 2388, 2588	Hub, Separator Drive Shaft	AM189419C1	\$ 92.41	
1420, 1440, 1460, 1480, 1620, 1640 BSN JJC0034705, (1640 ASN JJC0034704, 1644, 1660, 1666 - w/o Straw Chopper), 1680, 1688, 2144, 2166, 2188, 2344, 2366, 2377, 2388, 2577, 2588, 5130 w/ Non-Common Cab	Drive Hub, Separator Variable Speed	AM194394C1	\$ 128.00	

Case IH®—Combine

Application	Description	Part Number	Retail Price	Core
(2377, 2388 SN HAJ292001-HAJ300000), 2577, 2588	Pulley, Separator Driven 5-Groove, 3.507" ID, 14.75" OD	AM364320A2	\$ 275.79	
	Pulley, Separator Idler 1.8495" ID, 8" OD Requires Bearing and Snap Ring	AM87323202	\$ 110.77	
1420, 1440, 1460, 1470, 1480, 1620, 1640, 1644, 1660, 1666, 1670, 1680, 1688, 2144, 2166, 2188, 2344, 2366, 2377, 2388, 2577, 2588, 5130, 6088, 6130, 7088, 7130	Variator Pulley Sprocket 25 Tooth Replaces 194464C2, 194464C1	AM87678413	\$ 92.00	
1660, 2344, 2366, 2377, 2388 BSN JJC0276540, 2577, 2588, 5088, 5130, 5140, 6130, 7130	Jackshaft Thrust Bearing 2.75" ID, 4.481" OD, 0.88" Thick Replaces 194654C91	AM278927A1	\$ 50.00	
1640 ASN JJC0034705, 1666, 1688, 2144, 2166, 2188, 2344, 2366, 2377 SN HAJ292001-HAJ300000, 2388, 2577, 2588	Shaker Shaft Pitman Bearing Heavy Duty Drive	AM84435858	\$ 46.12	

Elevator Chains

Elevator chains include rubber paddles attached with 5/16" plated bolts and nuts (unless noted in the individual description). Chains feature full side plates for added strength.



Application	Description	Part Number	Retail Price	Core
815, 915	Clean Grain Elevator Chain 152 links - 7 5/8" x 2 3/4" paddles every 4th link	AM177453C91	\$ 434.58	
1420, 1620	Clean Grain Elevator Chain 149 links - 6 1/2" x 2 3/4" paddles every 4th link	AM186221C1	\$ 383.46	
	Rubber Paddle 6 1/2" x 2 3/4"	AM185333C1	\$ 3.19	
1440, 1460, 1470	Clean Grain Elevator Chain 149 links - 7 5/8" x 2 3/4" paddles every 4th link	AM1302201C91	\$ 350.00	
1480, 1482	Clean Grain Elevator Chain 160 links - 7 5/8" x 3 1/2" paddles every 4th link	AM1302195C91	\$ 310.00	
	Rubber Paddle 7 5/8" x 3 1/2"	AM1302197C1	\$ 5.41	
1640, 1644, 1660, 1666, 2144, 2166, 2344, 2366	Clean Grain Elevator Chain 152 links - 5 5/8" x 4" paddles every 4th link	AM1321334C92	\$ 270.00	
	Rubber Paddle 5 5/8" x 4"	AM1317480C2	\$ 8.00	
1680, 1682, 1688, 2188, 2377, 2388, 2577, 2588	Clean Grain Elevator Chain 152 links - 7 5/8" x 3 1/2" paddles every 4th link Replaces 87313692	AM1317482C92	\$ 365.00	
	Rubber Paddle 7 5/8" x 3 1/2"	AM1302197C1	\$ 5.41	
5088, 5130, 5140, 5150, 6088, 6130, 6140, 6150, 7088, 7130, 7140, 7150	Clean Grain Elevator Chain 154 Links Replaces 47717096, 87313692	AM87365387	\$ 325.00	
	Rubber Paddle 7 1/2" x 4"	AM1318493C2	\$ 4.45	
7010, 7120, 7230, 8010, 8120, 8230, 9120, 9230, AFX8010	Clean Grain Elevator Chain 145 links - 9 5/8" x 5" paddles every 4th link Last 2 paddles are every 6th link	AM87281911	\$ 415.00	
	Clean Grain Elevator Chain, Rubber Paddles 145 Links - 9 5/8" x 5" Rubber Paddles every 4th Link Last 2 Paddles are every 6th Link Heavy Duty w/ Steel Support Plate on Paddles	AM48089345	\$ 775.00	
	Rubber Paddle 9 5/8" x 5"	AM87282471	\$ 6.35	

Case IH®—Combine

Application	Description	Part Number	Retail Price	Core
1420, 1440, 1460, 1480, 1482, 1640, 1644, 1660, 1666, 1680, 1682, 1688, 2144, 2166, 2188, 2344, 2366, 2388, 2588, 5088, 5130, (5140, 6140, 7140 - Tier 4B 03/2014-10/15), 6088, 6130, 7088, 7130	Return Grain Elevator Chain 115 links - 5 5/8" x 2 3/4" paddles every 4th link	AM1303114C91	\$ 200.00	
	Rubber Paddle 5 5/8" x 2 3/4"	AM1303123C91	\$ 16.11	

Elevator Chain Sprockets

To extend the life of your chain assemblies, always replace the sprockets when installing a new chain.



Application	Description	Part Number	Retail Price	Core
815, 915 ASN 8001, 1420, 1480 ASN 14001	Clean Grain Elevator Chain Sprocket, Upper 7 Tooth, 1" Shaft Replaces 87691619	AM168683C1	\$ 36.00	
1420, 1440 BSN 10000, 1460 BSN 12001	Clean Grain Elevator Chain Sprocket, Upper 6 Tooth, 1" Shaft	AM165292C1	\$ 38.00	
1440, 1460 ASN 12001, 1480	Clean Grain Elevator Chain Sprocket, Upper 7 Tooth, 1.125" Shaft	AM1302200C1	\$ 41.00	
1640, 1644, 1660, 1666, 1680, 1688, 1682, 2144, 2166, 2188, 2344, 2366, 2388, 2588	Clean Grain Elevator Chain Sprocket, Upper 9 Tooth, 1.25" Shaft	AM1317192C2	\$ 49.00	
5088, 5130, 5140, 5150, 6088, 6130, 6140, 6150, 7088, 7130, 7140, 7150	Clean Grain Elevator Chain Sprocket, Upper 9 Tooth, 1.50" Shaft	AM87324981	\$ 60.00	
7010, 7120, 7230, 7240, 8010, 8120, 8230, 8240, 9120, 9230, 9240, AFX8010	Clean Grain Elevator Chain Sprocket, Upper 9 Tooth, 35 mm Round Bore Replaces 86998052	AM87283438	\$ 77.00	
715, 815, 915 ASN 8001, 1420, 1440 BSN 10000, 1460 BSN 12001	Clean Grain Elevator Chain Sprocket, Lower 6 Tooth, 1" Shaft	AM165292C1	\$ 38.00	
1440 ASN 10001, 1460 ASN 12001	Clean Grain Elevator Chain Sprocket, Lower 7 Tooth, 1" Shaft Replaces 87691619	AM168683C1	\$ 36.00	
1480 BSN 14001	Clean Grain Elevator Chain Sprocket, Lower 6 Tooth, 1.125" Shaft	AM186720C1	\$ 55.77	
1640, 1644, 1660, 1666, 1680, 1688, 2144, 2166, 2344, 2366	Clean Grain Elevator Chain Sprocket, Lower 9 Tooth, 1.25" Shaft	AM1317192C2	\$ 49.00	
2188, 2388, 2588	Clean Grain Elevator Chain Sprocket, Lower 9 Tooth, 1.375" Shaft	AM143960A1	\$ 37.00	
5088, 5130, 5140, 5150, 6088, 6130, 6140, 6150, 7088, 7130, 7140, 7150	Clean Grain Elevator Chain Sprocket, Lower 9 Tooth, 1.50" Shaft	AM87324981	\$ 60.00	
7010, 7120, 7230, 7240, 8010, 8120, 8230, 8240, 9120, 9230, 9240, AFX8010	Clean Grain Elevator Chain Sprocket, Lower 9 Tooth, 45 mm Round Bore Replaces 87283182, 86975226	AM87283436	\$ 77.00	
1420, 1440 BSN 10000, 1460 BSN 12001, 1480 BSN 14000	Return Grain Elevator Chain Sprocket, Upper 6 Tooth, 1" Shaft	AM165292C1	\$ 38.00	
1440 ASN 10001, 1460 ASN 12001, 1480 ASN 14001, 1640, 1644, 1660, 1666, 1680, 1688, 2144, 2166, 2188, 2344, 2366, 2388, 2588	Return Grain Elevator Chain Sprocket, Upper 7 Tooth, 1" Shaft Replaces 87691619	AM168683C1	\$ 36.00	
1480 BSN 14001	Return Grain Elevator Chain Sprocket, Upper 6 Tooth, 1.125" Shaft	AM186720C1	\$ 55.77	
715, 815, 915 ASN 8001, 1420, 1440 BSN 10000, 1460 BSN 12001	Return Grain Elevator Chain Sprocket, Lower 6 Tooth, 1" Shaft	AM165292C1	\$ 38.00	
1440 ASN 10000, 1460 ASN 12001	Return Grain Elevator Chain Sprocket, Lower 7 Tooth, 1" Shaft Replaces 87691619	AM168683C1	\$ 36.00	
1480 ASN 14001, 1680, 1688	Return Grain Elevator Chain Sprocket, Lower 7 Tooth, 1.125" Shaft	AM1302200C1	\$ 41.00	
2144, 2166, 2188, 2344, 2366, 2377, 2388, 2588, 5088, 6088, 7088	Return Grain Elevator Chain Sprocket, Lower 7 Tooth, 1.25" Shaft Replaces 87740180	AM144031A1	\$ 41.00	

Case IH®—Combine



Elevator Drive Sprockets and Components

Application	Description	Part Number	Retail Price	Core
2366 ASN JJC0184544, 2377 ASN HAJ0292001, 2388	Elevator Drive Sprocket Assembly 27 Tooth, 50 Chain, 1.25" Bore	AM296022A1	\$ 45.00	
1440, 1460, 1470, 1480, 1640, 1660, 1670, 1680, 1688, 2144, 2166, 2188, 2344, 2366, 2388 BSN JJC0276540	Elevator Drive Sprocket 25 Tooth	AM192139C2	\$ 46.00	
1440, 1460, 1480	Elevator Drive Sprocket 33 Tooth, 4 Bolt Holes, 2.25" ID, 6.92" OD	AM188189C1	\$ 20.00	
1460, 1470, 1480, 1482, 1640 BSN JJC0034705, 1660, 1670, 1680, 1682	Elevator Drive Sprocket 27 Tooth, For Size 50 Chain 2.25" ID, 5.723" OD	AM188188C1	\$ 22.00	
1640, 1660, 1670, 1680, 1688, 2144, 2166, 2188, 2366, 2388, 2577, 2588	Elevator Drive Sprocket 32 Tooth	AM1317412C1	\$ 51.00	
1640, 1660, 1670 ASN 80540, 1680 ASN 80540, 2366, 2388	Elevator Drive Sprocket 27 Tooth, For Size 50 Chain Replaces 1979808C1	AM1345472C1	\$ 51.00	
2144, 2166, 2188, 2344, 2366, 2388	Elevator Drive Sprocket 25 & 30 Tooth, 1.25" Bore, 2-Speed	AM182945A1	\$ 65.00	
2144, 2166, 2188, 2344, 2388, 5088, 5130, 5140, 6088, 6130, 6140, 7088, 7130, 7140	Return Grain Elevator Drive Sprocket, Upper 23 Tooth	AM84160043	\$ 100.00	
2366 ASN JJC0194544, 2377 ASN HAJ0292001, 2388, 2588	Elevator Drive Sprocket 27 & 32 Tooth	AM296023A1	\$ 70.00	
5088, 5130, (5140, 6140 - w/ Tier 4B Engine, 03/2014-10/15), 6088, 6130, 7088, 7130	Elevator Drive Sprocket 23 Tooth, Bubbler Driven	AM84167767	\$ 54.00	
5088, 5130, (5140, 6140 - w/ Tier 4B Engine, 03/2014-10/15), 6088, 6130, 7088, 7130, 7140	Elevator Drive Sprocket 23 & 27 Tooth	AM84159778	\$ 150.00	
	Elevator Drive Sprocket 27 Tooth, Driven	AM84163939	\$ 74.00	
5130, 5140, 6130, 6140, 7010, 7120, 7130, 7140, 7230, 7240, 8010, 8120, 8230, 8240, 9120, 9230, 9240, AFX8010 BSN HAJ105101	Elevator Drive Sprocket 15 Tooth	AM87283101	\$ 21.00	
7010, 7120, 7230, 7240, 8010, 8120, 8230, 8240, 9120, 9230, 9240, AFX8010	Elevator Drive Sprocket 22 Tooth Replaces 87108702, 86975916	AM87283695	\$ 32.00	
7010, 7120, 8010, 8120, 8230, 8240, 9120, 9230, 9240, AFX8010	Elevator Drive Sprocket 17 Tooth Replaces 87283677, 86999488	AM87731456	\$ 26.00	
7010, 7120, 7230, 8010, 8120, 8230, 8240, 9120, 9230, 9240, AFX8010	Elevator Driven Sprocket 37 Tooth, 1.182" Bore Replaces 86998172, 87108698, 87586562	AM87748377	\$ 75.00	
1440 ASN 40000, 1460 ASN 42001, 1470, 1480 ASN 44001, 1640, 1644, 1660, 1666, 1670, 1680, 1688, 2144, 2166, 2188, 2344, 2366, 2377, 2388, 2588, 5088, 6088, 7088 BSN Y9G001953	Elevator Jackshaft Clutch Plate Hub 3.53" Long, 1.25" Bore Diameter Replaces 1319232C1	AM198279A1	\$ 135.03	
1440, 1460, 1480, 1620, 1640, 1644, 1660, 1666, 1680, 1688, 2366, 2377, 2388, 2577, 2588	Elevator Jackshaft Drive Pulley 13" OD	AM183325C1	\$ 120.00	
403, 503, 615, 715, 815, 915, 1420, 1440, 1460, 1470, 1480, 1482, 1620, 1640, 1660, 1682, Platforms: 810, 820	Idler Sprocket 50 Chain, 17 Tooth, 0.50" ID	AM565442R91	\$ 15.52	
503, 1420, 1440, 1460, 1470, 1480, 1482, 1620, 1640, 1660, 1670, 1680	Idler Sprocket 60 Chain, 15 Tooth, 0.625" ID	AM629972R91	\$ 20.00	
1640, 1644, 1660, 1666, 2144, 2166, 2344, 2366	Idler Sprocket 17 Tooth, 0.755" Hex Bore	AM1319759C1	\$ 71.75	
2377, 2388, 2577, 2588, 5088, 6088, 7088	Idler Sprocket 17 Tooth Replaces 631905R91	AM103244	\$ 17.00	

Case IH®—Combine

Application	Description	Part Number	Retail Price	Core
503, 615, 715, 815	Idler Pulley, Flanged 1.312" Wide, 7" OD, 0.625" Bore Diameter	AM570265R91	\$ 35.27	
Most Models	Idler Pulley, V-Belt w/ 1/2" ID Sleeve 1.31" Wide, 7.31" OD, 0.635" Bore Diameter Replaces 673214C91, 86996213	IPCVI-117	\$ 26.00	
1440, 1460, 1470, 1480, 1482, 1640, 1644, 1660, 1666, 1670, 1680, 1682, 1688, 2144, 2166, 2188, 2344, 2366, 2377 SN HAJ292001-HAJ300001, 2388, 2577, 2588	Block For Elevator Drive Chain Tightener Replaces B95301, B512091	AM582018R1	\$ 7.96	
1440 BSN 10000, 1460 BSN 12001	Roller Chain, Clean Grain Elevator Drive 230 Links, Size 50 Chain	AMX34126	\$ 65.00	
1440 ASN 09999, 1460 ASN 11999 w/o Raised Level Auger	Roller Chain, Clean Grain Elevator Drive 260 Links, Size 50 Chain	AMX34127	\$ 70.00	
1460 ASN 11999 w/ Raised Level Auger	Roller Chain, Clean Grain Elevator Drive 284 Links, Size 50 Chain	AMX34128	\$ 75.00	
1620	Roller Chain, Clean Grain Elevator Drive 78 Links, Size 40 Chain	AMX34129	\$ 30.00	
1680 BSN JJC0045689	Roller Chain, Clean Grain Elevator Drive 266 Links, Size 50 Chain	AMX34130	\$ 70.00	
1680 ASN JJC0045688	Roller Chain, Clean Grain Elevator Drive 258 Links, Size 50 Chain	AMX34131	\$ 70.00	
(5088, 7088 ASN Y9G001954), 5130, (5140, 6140, 7140 - Prior to 10/2015), 6088 ASN Y9H001954, 6130, 7130	Roller Chain, Clean Grain Elevator Drive 224 Links, Size 60H Chain	AM84163936	\$ 90.00	
(5140, 6140, 7140 - 10/2015 and Later), 5150, 6150, 7150	Roller Chain, Clean Grain Elevator Drive 144 Links, Size 60H Chain	AM47709870	\$ 125.00	
7010, 7120, 7230, 7240, 7250, 8010, 8120, 8230, 8240, 8250, 9010, 9120, 9230, 9240, 9250, AFX8010 ASN HAJ105101	Roller Chain, Clean Grain Elevator Drive 104 Links, Size 60 Chain Replaces 87108801, 87584827	AM87470737	\$ 80.00	

Elevator Housings























Application	Description	Part Number	Retail Price	Core
1640, 1644, 1660, 1666, 2144, 2166, 2344, 2366	Clean Grain Elevator Housing	AM1317376C9	\$ 893.00	
1680, 1682, 1688, 2188, 2388, 2588 - w/o AFS	Clean Grain Elevator Housing	AM1317456C3	\$ 1025.00	
	Clean Grain Elevator Housing Stainless Steel	AM1317456C3E	\$ 1632.00	
2366 w/ Advanced Farming System	Clean Grain Elevator Housing Replaces 367708A1, 367708A2, 367708A3	AM367708A4	\$ 1142.86	
2377 SN HAJ292001-HAJ300000, 2388 SN HAJ292001- HAJ300001, 2577, 2588 - w/ AFS	Clean Grain Elevator Housing Replaces 367308A1, 367308A2, 367308A4	AM367308A5	\$ 1171.00	
7010, 7120, 8010, 8120, 9120	Clean Grain Elevator Housing Extended Wear Replaces 87586570 (Standard Wear)	AM87586569	\$ 1734.00	
1440, 1460, 1470, 1660, 1666, 1670, 2144, 2166, 2344, 2366	Tailings Elevator Housing Replaces 191778C1	AM191778C2	\$ 763.93	
1480, 1482, 1680, 1682, 1688, 2188, 2377, 2388, 2577, 2588	Tailings Elevator Housing	AM87470913	\$ 729.00	

Elevator Housing Sheet Metal

Application	Description	Part Number	Retail Price	Core
1640, 1644, 1660, 1666, 1670, 1682, 2144, 2166, 2344 BSN JJC0174359, 2366 BSN JJC0252949	Elevator Head Side Cover, Right Hand For Inclined Elevators	AM1321126C1	\$ 150.49	















Case IH®—Combine

	Application	Description	Part Number	Retail Price	Core
	1660, 1666, 1680, 1688, 2144, 2166, 2188, 2344, 2366, 2577, 2588	Clean Grain Elevator Head Side Cover, Right Hand Standard Duty For Inclined Elevators	AM1319908C1	\$ 105.49	
	7010, 7120, 7230, 7240, 8010, 8120, 8230, 8240, 9120, 9230, 9240, AFX8010	Clean Grain Elevator Head Cover	AM87109213	\$ 256.70	
	2188, 2377, 2388, 2577, 2588	Elevator Head Cover, Front w/ Yield Monitor, w/ Advanced Farming System	AM238646A1	\$ 154.00	
	2188, 2377, 2388, 2577, 2588	Elevator Head Cover, Front w/o Yield Monitor, w/o Advanced Farming System	AM198602A1	\$ 244.00	
	1680, 1682, 1688, 2188	Sealing Plate	AM1321230C1	\$ 40.00	
	1680, 1688, 2188	Front Head Cover	AM1319941C1	\$ 95.00	
	1640, 1644, 1660, 1666, 1670, 2144, 2166, 2344, 2366	Rear Cover	AM1319942C1	\$ 45.00	
	1680, 1682, 1688, 2188, 2377, 2388, 2577, 2588	Inclined Elevator Head Rear Cover	AM1319940C1	\$ 52.00	
	1660, 1666, 1680, 1688, 2144, 2166, 2188, 2344, 2366, 2377, 2388, 2588	Rear Support Panel	AM1321551C2	\$ 52.00	
	1680, 1688, 2188, 2377, 2388, 2588	Rear Support Panel	AM1321550C2	\$ 45.00	
	1680, 1688, 2188, 2377, 2388, 2577, 2588	Clean Grain Elevator Head Side Panel, Right Hand For Inclined Elevator	AM1321095C1	\$ 40.00	
	2144, 2166, 2188, 2344, 2377, 2388, 2588	Corn and Grain Cover	AM229609A2	\$ 45.00	
	1660, 1666, 1680, 1688, 2144, 2166, 2188, 2344, 2366, 2377, 2388, 2588	Auger Cover	AM1321097C2	\$ 42.00	
	1630, 1660, 1666, 1688, 2144, 2166, 2188, 2344, 2366, 2377, 2388, 2588	Auger U-Joint Cover	AM1321556C1	\$ 19.00	
	1660, 1666, 1680, 1688, 2144, 2166, 2188, 2344, 2366, 2377, 2388, 2588	Auger Bearing Support Plate	AM1979134C1	\$ 71.00	
	1660, 1666, 1680, 1688, 2144, 2166, 2188, 2344, 2366, 2377, 2388, 2588	Panel, Side Front	AM1321552C2	\$ 30.00	
	1680 Late, 2144, 2166, 2188, 2366, 2388	Clean Grain Elevator Front Side Panel, Left Hand Replaces 1321069C1	AM189456A1	\$ 43.00	
	(1644, 1666, 2144, 2166 - Prior to 1996), (2344, 2366 - 1996 and Later)	Corn and Grain Cover, Narrow Replaces 84163887	AM224602A1	\$ 105.00	
	1688, 2188, 2388 - w/ AFS	Corn and Grain Cover, Wide	AM224603A1	\$ 55.00	
	2144, 2166, 2344, 2366	Corn and Grain Cover	AM198603A2	\$ 90.00	
	1680, 1682, 1688, 2188, 2377, 2388, 2588	Panel, Left Side	AM1321497C1	\$ 86.00	

Prices Subject to Change without Prior Notice. The use of original equipment manufacturer (OEM) part numbers or trademarks, e.g. Case® and John Deere®, are for reference purposes only and for indicating product use and compatibility. Our company and the listed replacement parts contained herein are not sponsored, approved or manufactured by the OEM. All parts are New unless designated Reman in the description.













Case IH®—Combine

	Application	Description	Part Number	Retail Price	Core
	1660, 1666, 1680, 1688, 2144, 2166, 2188, 2344, 2366, 2377, 2388, 2577, 2588	Elevator Head Auger Mounting Support	AM1321060C1	\$ 64.00	
	1640, 1644, 1660, 1666, 1670, 1680, 1682, 1688, 2144, 2166, 2188, 2388, 2588	Head Shaft Support	AM1317251C2	\$ 42.50	
	1640, 1644, 1660, 1666, 1670, 1680, 1682, 1688, 2144, 2166, 2188, 2344, 2366, 2377, 2388, 2577, 2588	Clean Grain Elevator Head Side Panel, Left Hand For Horizontal or Inclined Elevator	AM1319901C1	\$ 65.93	
	1640, 1644, 1660, 1666, 1670, 2144, 2166, 2344, 2366	Clean Grain Elevator Door Perforated	AM1317841C1	\$ 80.00	
	1640, 1644, 1660, 1666, 1670, 2144, 2166, 2344, 2366	Grain Elevator Head Panel, Left Hand	AM1321496C1	\$ 50.00	
	1640, 1644, 1660, 1666, 2144, 2166, 2344 BSN JJC0174359, 2366 BSN JJC0252949	Grain Elevator Trough	AM1321130C1	\$ 148.97	
	1660, 1666, 1680, 1688, 2144, 2166, 2188, 2344, 2366, 2377, 2388, 2588	Upper Trough Panel	AM1321560C3	\$ 128.00	
	2144, 2166, 2188, 2344, 2366, 2377, 2388, 2588	Lower Trough Panel w/ Sensor Hole	AM199006A2	\$ 168.00	
	1660, 1666, 1680, 1688, 2144, 2166, 2188	Lower Tube Trough w/o Sensor Hole	AM1321557C2	\$ 168.00	
	1420, 1440, 1460, 1620, 1640, 1644, 1660, 1666, 1680, 1688, 2144, 2166, 2188, 2344, 2366, 2377, 2388, 2577, 2588	Return Elevator Head Trough	AM188119C1	\$ 135.30	
	1420, 1440, 1460, 1470, 1480, 1482, 1620, 1640, 1644, 1660, 1666, 1670, 1680, 1682, 1688, 2144, 2166, 2188, 2344, 2366, (2377, 2388 SN HAJ292001-HAJ300000), 2577, 2588	Return Elevator False Bottom Hinge Replaces 191790C1	AM191790C2	\$ 37.19	
	403, 503, 715, 815, 915, 1420, 1440, 1460, 1470, 1480, 1620, 1640, 1644, 1660, 1666, 1670, 1680, 1688, 2144, 2166, 2188, 2344, 2366, 2388, 2577, 2588	Tailings Elevator Door, Solid Replaces 184560C91	AM156910C1	\$ 45.66	
	403, 503, 715, 815, 915, 1420, 1440, 1460, 1470, 1480, 1620, 1640, 1644, 1660, 1666, 1670, 1680, 1688, 2144, 2166, 2188, 2344, 2366, 2388, 2577, 2588	Tailings Elevator Door, Perforated Replaces 239997A1	AM174193C1	\$ 57.00	
	7010, 7120, 7230, 7240, 7250, 8010, 8120, 8230, 8240, 8250, 9010, 9120, 9230, 9240, 9250, AFX8010	Upper Impeller Blower, Tailings Processor Replaces 87108642, 87335466, 87622761	AM87542137	\$ 243.00	
	7010, 7120, 7230, 7240, 7250, 8010, 8120, 8230, 8240, 8250, 9120, 9230, 9240, 9250, AFX8010	Tailings Processor Liner Kit Weld-In	AMX29174	\$ 920.00	

Case IH®—Combine

Clean Grain Elevator Boot Kits and Parts

Boot kits include outer and inner side boots, front and rear covers, deflector and non-perforated boot door. Kits also include nuts, bolts and washers to assemble the boot.

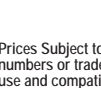
Application	Description	Part Number	Retail Price	Core
	1680, 1688	Clean Grain Elevator Boot Kit	AMX27123	\$ 350.00
	2188, 2388	Clean Grain Elevator Boot Kit w/ Yield Monitor	AMX27125	\$ 380.00
	2188, 2388	Clean Grain Elevator Boot Kit w/o Yield Monitor	AMX27124	\$ 350.00
	(7010, 7120, 7230, 7240, 8010, 8120, 8230, 9120, 9230 BSN YDG222000)	Clean Grain Elevator Boot Liner Kit Weld-In	AMX29173	\$ 557.00
	7010, 7120, 7230, 7240, 7250, 8010, 8120, 8230, 8240, 8250, 9120, 9230, 9240, 9250, AFX8010	Clean Grain Elevator Head Liner Kit Weld-In	AMX29172	\$ 771.00
	1660, 1666, 1680, 1688, 2144, 2166, 2188, 2344, 2366, 2577, 2588	Clean Grain Elevator Head Side Cover, Right Hand Standard Duty For Inclined Elevators	AM1319908C1	\$ 105.49
	2366, 2388, 2588	Clean Grain Elevator Head Side Plate, Right Hand Extended Wear, Stainless Steel	AM251458A1	\$ 276.92
	1680, 1682, 1688, 2188, 2388, 2577, 2588	Clean Grain Elevator Boot Door Non-Perforated	AM1317430C1	\$ 78.00
	1640, 1644, 1660, 1666, 1670, 2144, 2166, 2344, 2366	Clean Grain Elevator Door Solid	AM1317276C1	\$ 79.24
	5088, 5130, 5140, 6088, 6130, 6140, 7088, 7130, 7140	Clean Grain Elevator Door	AM84149722	\$ 385.00
	7010, 7120, 7230, 7240, 7250, 8010, 8120, 8230, 8240, 8250, 9120, 9230, 9240, 9250, AFX8010 ASN HAJ106401	Clean Grain Elevator Door	AM87282183	\$ 324.00
	1640, 1644, 1660, 1666, 1670, 2144, 2166, 2344, 2366	Clean Grain Elevator Boot Rear Cover	AM1317271C1	\$ 29.00
	1680, 1682, 1688, 2188, 2377, 2388, 2577, 2588	Clean Grain Elevator Boot Rear Cover	AM1317437C1	\$ 56.00
	5088, 5130, 5140, 6088, 6130, 6140, 7088, 7130, 7140	Clean Grain Elevator Boot Rear Cover	AM84149716	\$ 140.00
	1680, 1682, 1688, 2188, 2388, 2577, 2588	Clean Grain Elevator Boot Front Cover	AM1317439C1	\$ 51.00
	5088, 5130, 5140, 6088, 6130, 6140, 7088, 7130, 7140	Clean Grain Elevator Boot Front Cover	AM84171634	\$ 125.00
	(5088, 6088, 7088, BSN Y9G002404)	Clean Grain Elevator Boot Front Cover Replaces 87329127	AM87329806	\$ 365.00
	1680, 1682, 1688, 2188, 2388, 2577, 2588	Clean Grain Elevator Boot Bottom Deflector	AM1318590C3	\$ 24.00

Case IH®—Combine

Application	Description	Part Number	Retail Price	Core
 7010, 7120, 8010, 8120, 9120, AFX8010 ASN HAJ106401	Clean Grain Elevator Boot Bottom Replaces 8728146, 84194821	AM87510515	\$ 612.00	
 1640, 1644, 1666, 1670, 2144, 2166, 2366	Clean Grain Elevator Boot Side, Inner	AM1317673C2	\$ 76.92	
 1680, 1682, 1688, 2188, 2377, 2388, 2577, 2588	Clean Grain Elevator Boot Side, Inner	AM1318584C2	\$ 77.00	
 5088, 5130, 5140, 6088, 6130, 6140, 7088, 7130, 7140	Clean Grain Elevator Boot Side, Inner	AM84171638	\$ 179.00	
 1640, 1644, 1660, 1666, 1670, 1680, 1682, 1688, 2144, 2166, 2344, 2366	Clean Grain Elevator Boot Side, Outer w/o Yield Monitor	AM1318585C3	\$ 68.00	
 2144, 2166, 2188, 2344, 2366, 2388, 2588	Clean Grain Elevator Boot Side, Outer w/ Yield Monitor Replaces 87634786	AM223237A1	\$ 77.00	
 2188, 2388, 2588	Clean Grain Elevator Boot Side, Outer w/o Yield Monitor	AM176175A2	\$ 56.75	
 5088, 5130, 5140, 6088, 6130, 6140, 7088, 7130, 7140	Clean Grain Elevator Boot Side, Outer	AM84171636	\$ 190.00	
 7130 (2013), (7230, 8230 - 2013-09/14), 7240, 7250, 8250, 9230, 9240, 9250	Clean Grain Elevator Boot Replaces 47513518	AM48189965	\$ 1285.00	

Return Elevator Boots

Application	Description	Part Number	Retail Price	Core
1420, 1440, 1460, 1470, 1620, 1640, 1644, 1660, 1666, 1670	Tailings Elevator Boot	AM191771C1	\$ 262.24	
1480, 1482, 1680, 1682, 1688, 2144, 2166, 2188	Tailings Elevator Boot	AM183160C1	\$ 300.45	
2344, 2366, 2377 SN HAJ292001-HAJ300000, 2388, 2577, 2588	Tailings Elevator Boot Replaces 222814A2	AM87636252	\$ 223.02	
7010, 7120, 8010, 8120, (8230, 9230 - w/ Non-Common Cab), 9010 04/2008 and Later, 9120, AFX8010	Tailings Clean Out Door Extended Wear Replaces 87484453, 87484454, 87753013	AM87736624	\$ 440.00	
(7010, 8010 ASN HAJ202928), 7120, 7230, 7240, 7250, 8120, 8230, 8240, 8250, 9120, 9230, 9240, 9250	Tailings Clean Out Door	AM87728882	\$ 199.00	

Case IH®—Combine

Elevator Gearboxes

Application	Description	Part Number	Retail Price	Core
(5140, 6140, 7140 ASN YFG014001), 5150, 6150, 7010, 7120, 7150, 7230, 7240, 7250, 8010, 8120, 8230, 8240, 8250, 9010, 9120, 9230, 9240, 9250	Auger Gearbox Intermediate Shaft 11.267" Long	AM87441209	\$ 95.00	
	Gearbox Input Shaft 10.04" Long	AM87441212	\$ 90.00	
	Auger Gearbox Bevel Gear 18 Tooth	AM87441215	\$ 83.00	

Elevator Head Shafts

Application	Description	Part Number	Retail Price	Core
1420, 1620	Clean Grain Elevator Head Shaft 13.75" Long	AM186164C1	\$ 53.01	
1440 BSN 10000, 1460 BSN 12000, 1470 BSN 1180	Clean Grain Elevator Head Shaft 13" Long, 1" Diameter	AM191694C1	\$ 25.00	
1440 ASN 10000, 1460 ASN 12000, 1470 ASN 1180, 1480, 1482	Clean Grain Elevator Head Shaft 13.31" Long, 1.125" Diameter	AM186723C1	\$ 27.00	
1640, 1660, 1666, 2144, 2166, 2344, 2366	Clean Grain Elevator Head Shaft 10.97" Long, 1.25" Diameter	AM1317429C1	\$ 28.00	
1680, 1682, 1688, 2188, 2377, 2388, 2577, 2588	Clean Grain Elevator Head Shaft 12.94" Long, 1.25" Diameter	AM1317470C1	\$ 36.00	
7010, 7120, 7230, 7240, 8010, 8120, 8230, 8240, 9120, 9230, 9240, AFX8010 ASN HAJ105771	Clean Grain Elevator Head Shaft, Upper 24.62" Long	AM87283680	\$ 185.52	
7010, 7120, 8010, 8120, 9120, AFX8010	Clean Grain Elevator Head Shaft 15.81" Long	AM86998178	\$ 56.00	
1420, 1620	Tailings Elevator Head Shaft 12.75" Long	AM181312C1	\$ 66.40	
1440, 1460, 1470, 1480, 1482, 1640, 1644, 1660, 1666, 1670, 1680, 1682, 2144, 2166, 2188, 2344, 2366, 2388	Tailings Elevator Head Shaft 11" Long, 1" Diameter	AM191785C1	\$ 23.00	
1640, 1644, 1660, 1670, 1680, 1682, 1688, 2144, 2166, 2188, 2344, 2366, (2377, 2388 HAJ292001-HAJ300000), 2577, 2588	Flanged Bearing w/ Lock Collar	AM1317250C91	\$ 37.00	

Elevator Drive Shafts

Application	Description	Part Number	Retail Price	Core
1420, (1440, 1460, 1480 ASN 05501), 1620, 1640, 1644, 1660, 1666, 1680, 1688, 2144, 2166, 2188, 2344, 2366, 2377, 2388, 2577, 2588, 5088, 7088	Elevator Jackshaft Hub	AM183210C91	\$ 97.00	
1440, 1460, 1470	Elevator Drive Shaft 28.27" Long Threaded on one end	AM1319246C1	\$ 162.31	
1480, 1680, 1682, 1688, 2188, 2377, 2388, 2577, 2588	Elevator Drive Shaft	AM1319247C1	\$ 78.00	
(5088, 6088, 7088 ASN Y9G001953), 5130, 5140, 6130, 6140, 7130, 7140	Elevator Jackshaft Retainer	AM87470287	\$ 110.00	
1420, 1440, 1460, 1480, 1620, 1640, 1644, 1660, 1666, 1680, 1688, 2144, 2166, 2188, 2344, 2366, 2377, 2388, 2577, 2588, (5088, 6088, 7088 BSN Y9G001953)	Bearing, Elevator Jackshaft 1.25" Round Bore Replaces 473096R91, 473097R91, 473097R92	AM387284A1	\$ 23.84	

Beater Components

Application	Description	Part Number	Retail Price	Core
1440, 1460, 1640, 1644, 1660, 1666, 2144, 2166, 2344, 2366	Beater Blade (3) Required	AM1319269C1	\$ 108.00	

Case IH®—Combine

Application	Description	Part Number	Retail Price	Core
1480, 1482, 1660, 1680, 1682, 1688, 2188, 2377, 2388, 2577, 2588, 5088, 5130, 5140, 6088, 6130, 7088, 7130, 7140	Beater Blade (3) Required	AM1319270C1	\$ 78.00	
1440, 1460, 1470, 1640, 1644, 1660, 1666, 1670, 2144, 2166, 2344, 2366 - w/ Rock Trap	Beater Shaft 51" Long Replaces 1320138C1, 1320161C1, 1327502C1	AM389021A1	\$ 246.75	
1440, 1460, 1640, 1644, 1660, 1666, 2144, 2166, 2344, 2366	Beater Shaft	AM1302175C1	\$ 115.00	
1480, 1680, 1688, 2188, 2377, 2388, 2577, 2588	Beater Shaft	AM1302176C1	\$ 148.00	
8010, 8120, 9120, AFX8010	Beater Shaft Replaces 87107720	AM87282886	\$ 807.69	
1480, 1680, 1688, 2377, 2388, 2577, 2588	Serrated Fins, Rock Trap Beater Set of 3 41.938" Long, Serrated Fins bolt onto the outer edge of the Beater Blades Includes Hardware	AMB95678	\$ 168.83	
1420, 1440, 1460, 1470, 1480, 1620, 1640, 1644, 1660, 1666, 1670, 1680, 1688, 2144, 2166, 2188, 2344, 2366, 2377, 2388, 2577, 2588, 5088, 5130, 5140, (5150, 6150, 7150 - Tier 4B), 6088, 6130, 6140, 7088, 7130, 7140	Hub Assembly, Discharge Beater 14" OD Replaces 183129C2	AM1316266C1	\$ 154.02	
1420, 1440, 1460, 1470, 1480, 1482, 1620, 1640, 1644, 1660, 1666, 1670, 1680, 1682, 1688, 2144, 2166, 2188, 2344, 2366, 2377 SN HAJ292001-HAJ300000, 2388, 2577, 2588, 5088, 5130, 5140, 6088, 6130, 6140, 7088, 7130, 7140	Hub Assembly, Discharge Beater 14" OD Replaces 183129C2	AM1319266C1	\$ 89.00	
1420, 1440, 1460, 1470, 1480, 1482, 1620, 1640, 1644, 1660, 1666, 1670, 1680, 1682, 1688, 2144, 2166, 2188, 2344, 2366, 2377, 2388, 2577, 2588, 5088, 5130, 5140, 6088, 6130, 6140, 7088, 7130, 7140	Hub, Beater Drive 1.13" Hex Bore Replaces 176579C1	AM1319402C1	\$ 78.00	
7010, 7120, 7230, 8010, 8120, 8230, 9010, 9120, 9230, AFX8010	Bearing Assembly For Beater/Chopper Drive Replaces 47421133, 47663490, 87323956	AM87109088	\$ 260.00	
7120, 7230, 8120, 8230, 9120, 9230	Slotted Grate Insert Use w/ Discharge Beater Grates	AM87587528	\$ 360.00	

Fan Components

Application	Description	Part Number	Retail Price	Core
1440, 1460, 1470, 1480, 1640, 1644, 1660, 1666, 1670, 1680, 1688, 2144, 2166, 2188, 2344, 2366, 2377, 2388, 2577, 2588, 5130, 5140, 5150, 6130, 6140, 6150, 7088, 7130, 7140, 7150	Gear Set Includes 18 & 31 Tooth Gears Replaces 191285C1	AM1315597C1	\$ 500.00	
1688, 2188, 2377, 2388, 2588, 5088, 5130, 5140, 5150, 6088, 6130, 6140, 6150, 7088, 7130, 7140, 7150, 9230 Tier 4 Common Cab 2013-09/14	Cleaning Fan Shaft	AM1989543C3	\$ 350.00	
(2577, 2588 ASN HAJ303001), 5088, 5130, 6088, 6130, 7088, 7130	Fan Speed Actuator	AM87693674	\$ 78.00	



Unloading Auger Housings and Components Grain Drains

Application	Description	Part Number	Retail Price	Core
1 1420, 1440, 1460, 1480, 1620, 1640 BSN 97103, 1660 BSN 102897, 1680 BSN 115352	Lower Unloading Housing	AM1327976C91	\$ 455.38	
2 1420, 1440, 1460, 1470, 1480, 1482, 1620, 1640, 1644, 1660, 1666, 1670, 1680, 1682, 1688, 2144, 2166, 2188, 2344, 2366, 2388, 2588	Elevator Sump Elevator Sump, Stainless Steel Elevator Sump Rebuild Kit Stainless Steel Liners Includes Hardware	AM192475C3 AM192475C3S AMX29149	\$ 877.00 \$ 1000.00 \$ 391.00	
3 1420, 1440, 1460, 1470, 1480, 1482, 1620, 1640, 1644, 1660, 1666, 1670, 1680, 1682, 1688, 2144, 2166, 2188, 2344, 2366, 2388	Grain Drain	AMX27136	\$ 219.00	

Case IH®—Combine

Application	Description	Part Number	Retail Price	Core
4 1440, 1640 ASN 35422, 1644, 1660 ASN 40895, 1666, 1670 ASN 80540, 1680 ASN 48053, 1688, 2144, 2166, 2188, 2344, 2366, 2377, 2388	Vertical Grain Tank Unloading Tube Includes AM237009A1 Upper Ring	AM248307A2	\$ 500.00	
5 1660, 2144, 2166, 2188, 2344, 2366, 2377, 2388	Grain Tank Unloading Housing Upper Ring	AM237009A1	\$ 175.00	
NI 2144, 2166, 2188, 2344, 2366, 2377, 2388, 2577, 2588	Sump Housing Door Use w/ AM192475C3 Elevator Sump	AM189284A1	\$ 135.00	
NI 5088, 5130, 5140, 6088, 6130, 6140, 7010, 7088, 7120, 7130, 7140, 8010, 8120, 9010, 9120	Sump Liner Kit 4-Piece	AMX29160	\$ 257.00	



Unloading Auger Bevel Gears

Application	Description	Part Number	Retail Price	Core
1420, 1440, 1460, 1480, 1620, 1640 BSN 97103, 1660 BSN 102897, 1680 BSN 115352	Unloading Auger Bevel Gears Includes 21 Tooth Gear & 28 Tooth Gear Sold as Set Only	AM186517C1	\$ 232.31	



Unloading Gearbox Shafts

Application	Description	Part Number	Retail Price	Core
(815, 915 ASN 8001)	Unloading Gearbox Shaft, Horizontal	AM178115C1	\$ 41.79	
	Unloading Gearbox Shaft, Vertical	AM178116C1	\$ 27.68	
1420, 1440, 1460, 1480, 1620, 1640 BSN 97103, 1660 BSN 102897, 1680 BSN 115352	Unloading Gearbox Shaft, Vertical	AM1327739C2	\$ 146.26	
1420, 1440, 1460, 1470, 1480, 1482, 1620, 1640 BSN JJC0097103, 1660 BSN JJC0102897, 1670, 1680 BSN JJC0115352, 1682	Elevator Drive Shaft Horizontal Auger Gear Shaft	AM1327738C2	\$ 91.43	



Unloading Auger Swing Cylinders

Application	Description	Part Number	Retail Price	Core
1420, 1440, 1460, 1480	Unloading Auger Swing Cylinder	AM113960C92	\$ 518.80	
1620, 1640, 1644, 1660, 1666, 1670, 1680, 1682, 1688	Unloading Auger Swing Cylinder Replaces 1282488C92	AM1282488C91	\$ 536.00	
5130, 5140, 6130, 6140, 7010, 7120, 7130, 7140, 7230, 8010, 8120, 8230, 9010, 9210, 9230	Unloading Auger Swing Cylinder Replaces 84552262, 87592126, 87645216	AM84126280	\$ 605.00	
2144, 2166, 2188, 2344, 2366, 2377, 2388	Unloading Tube Swing Cylinder Replaces 175679A2, 87597336	AM87337241	\$ 393.00	

Augers & Components—Lower Clean Grain

All augers are made with continuous roll-formed flighting for accuracy and durability.



Application	Description	Part Number	Retail Price	Core
1440 ASN 30484, 1460 ASN 33285 AM144031A1 Sprocket is required when replacing 191737C1 Auger on early model 1440 (BSN 30484) and (1460 BSN 33285)	Lower Clean Grain Auger Extended Wear, 70 3/8" Overall Length, Right Hand Flighting, 6" Flighting Diameter, Shaft Diameter - 1" and 1 1/4", 6" Pitch	AM1319169C1	\$ 188.00	
	Bearing	AM160796C91	\$ 13.00	
1440 ASN 30484, 1460 ASN 33285, 1480, 1620, 5088, 6088, 7088	Clean Grain Elevator Chain Sprocket, Lower 7 Tooth, 1.25" Shaft Replaces 1319176C1	AM144031A1	\$ 41.00	

Case IH®—Combine

Application	Description	Part Number	Retail Price	Core
1480	Lower Clean Grain Auger Extended Wear, 76" Overall Length, Right Hand Flighting, 7" Flighting Diameter, 1 1/4" Shaft Diameter, 7" Pitch	AM1319173C1	\$ 247.00	
	Bearing	AM160796C91	\$ 13.00	
1640, 1644, 1660, 1666, 1670, 2144, 2166, 2344, 2366	Clean Grain Auger Trough Clamp	AM1317452C1	\$ 65.54	
1640, 1644, 1660, 1666, 2144, 2166	Lower Clean Grain Auger Extended Wear, 68 1/2" Overall Length, Right Hand Flighting, 7" Flighting Diameter, 1 1/4" Shaft Diameter, 7" Pitch	AM1317484C1	\$ 193.00	
	Bearing	AM1317250C91	\$ 37.00	
1644, 1666, 2144, 2166, 2344, 2366	Clean Grain Auger Trough	AM1541638C1	\$ 296.92	
1680, 1682, 1688, 2188, 2377, 2388, 2577, 2588	Clean Grain Auger Trough Tube Support	AM1317398C1	\$ 145.00	
	Clamp, Solid For Clean Grain Auger Trough	AM1317442C1	\$ 33.16	
1680, 1688	Lower Clean Grain Auger Extended Wear, 76" Overall Length, Right Hand Flighting, 8" Flighting Diameter, 1 1/4" Shaft Diameter, 7 1/2" Pitch	AM1317409C1	\$ 219.00	
	Bearing	AM160796C91	\$ 13.00	
1688, 2188, 2388, 2588	Clean Grain Auger Trough	AM1989374C1	\$ 194.00	
2188, 2388, 2588	Lower Clean Grain Auger Extended Wear, 76 3/8" Overall Length, Right Hand Flighting, 8" Flighting Diameter, 1 3/8" Shaft Diameter, 7 1/2" Pitch	AM143959A2	\$ 273.00	
	Bearing, (2) Required	SA207-22	\$ 15.00	
5088, 5130, 5140, 5150, 6088, 6130, 6140, 6150, 7088, 7130, 7140, 7150	Mid Range Clean Grain and Return Grain Auger Liner Kit Set of 2 Liners w/ Rivets	AMX29171	\$ 390.00	
5088, 5130, 5140, 6088, 6130, 6140, 7010, 7088, 7120, 7130, 7140, 7150, 7240, 7250, 8010, 8120, 8230, 8240, 8250, 9010, 9230, 9240, 9250	Clean Grain Auger Trough Liner 101.459" Long, 13.13" Wide Stainless Steel, Includes Mounting Hardware	AMX27265	\$ 325.00	
5088, 5130, 5140, 6088, 6130, 6140, 7088, 7130, 7140	Lower Clean Grain Auger Extended Wear, 76 5/8" Overall Length, Right Hand Flighting, 8 1/2" Flighting Diameter, 1 1/2" Shaft Diameter, 9" Pitch	AM87510720	\$ 551.00	
	Bearing	AMJD9202	\$ 18.00	
	Clean Grain Auger Trough Liner Kit Stainless Steel, Includes Rivets	AMX29157	\$ 393.00	
(5140, 6140, 7140 ASN YFG014001), 5150, 6150, 7150	Lower Clean Grain Auger 86.375" Overall Length, Right Hand Flighting, 8.50" Flighting Diameter, 69.50" Flighting Length, 1.50" Tube Diameter	AM47595610	\$ 527.79	
	Bearing	AMJD9202	\$ 18.00	
7010, 7120	Lower Clean Grain Auger Extended Wear Replaces 87380417, 87380423	AM87380422	\$ 691.00	
	Bearing	AMJD10384	\$ 22.00	
	Clean Grain and Return Grain Auger Trough Liner Patch Kit Set of 2 Stainless Steel Weld-In Liners (Narrow Frame)	AMX29120	\$ 885.00	
	Clean Grain and Return Grain Auger Trough Full Liner Kit Set of 2 Stainless Steel Weld-In Full Troughs, Narrow Frame 68" Overall Length Includes Stainless Steel for Door Covers	AMX29159	\$ 1075.00	
(7230, 8230, 9230 BSN YDG222000), 8010, 8120, 9120	Clean Grain and Return Grain Auger Trough Liner Kit Set of 2 Stainless Steel Weld-In Full Troughs 78" Overall Length Includes Stainless Steel for Door Covers	AMX29146	\$ 1082.00	

Case IH®—Combine

Application	Description	Part Number	Retail Price	Core
7230, 8010, 8120, 8230, 9010, 9120, 9230 BSN TDG222000	Clean Grain and Return Grain Auger Trough Liner Patch Kit Set of 2 Stainless Steel Weld-In Repair Panels, 24" Long	AMX29119	\$ 410.00	
(7230, 8230, 9230 ASN YDG222004), 7250, 8230, 8250, 9230, 9250	Lower Clean Grain Auger Extended Wear, 84 1/2" Overall Length, Right Hand Flighting, 10 1/2" Flighting Diameter, Shaft Diameter - 1.772" and 1.18", 10 1/2" Pitch Replaces 84577868	AM84583816	\$ 975.00	
	Bearing	AMJD10384	\$ 22.00	
(7230, 8230, 9230 BSN YDG222004), 8010, 8120, 9010, 9120, AFX8010	Lower Clean Grain Auger Extended Wear, 100 1/2" Overall Length, Right Hand Flighting, 8 7/8" Flighting Diameter, Shaft Diameter - 1.772" and 1.18", Reinforced 2.50" Tube, 9 7/8" Pitch Replaces 86975024, 87283266	AM87283130	\$ 712.00	
	Bearing	AMJD10384	\$ 22.00	
(7230, 8230, 9230 ASN YDG222000), 7240, 7250, 8240, 8250, 9240, 9250	Clean Grain and Return Grain Auger Trough Liner Patch Kit Set of 3 Stainless Steel Weld-In Repair Panels, 24" Long Includes Elevator Door Liners	AMX29147	\$ 480.00	
	Clean Grain and Return Grain Auger Trough Full Liner Kit Set of 3 Stainless Steel Weld-In Full Troughs Includes Stainless Steel for Door Covers	AMX29148	\$ 1114.00	

Augers & Components—Lower Tailing Return

All augers are made with continuous roll-formed flighting for accuracy and durability.

Application	Description	Part Number	Retail Price	Core
1440, 1460, 1640, 1644, 1660, 1666	Lower Return Auger Extended Wear, 62 1/2" Overall Length, Right Hand Flighting, 5" Flighting Diameter, 1" Shaft Diameter, 5" Pitch	AM191734C1	\$ 166.00	
	Bearing	NPS100RPC	\$ 7.00	
1480, 1482, 1680, 1682, 1688	Lower Return Auger Extended Wear, 85 3/8" Overall Length, Right Hand Flighting, 5" Flighting Diameter, 1 1/8" Shaft Diameter, 5 1/2" Pitch	AM192549C2	\$ 273.00	
	Bearing, (2) Required	SA206-18	\$ 14.25	
1480, 1680, 1688, 2188, 2377, 2388, 2577, 2588	Tailings Delivery Tube	AM191854C1	\$ 178.02	
1644, 1660 ASN JJC0038346, 1666, 2144, 2166, 2344, 2366 - w/ Straw Spreader	Rubber Seal For Tailing Auger Panel	AM1347000C2	\$ 72.28	
1680, 1688, 2188, 2388, 2588	Tailing Trough Replaces 1346938C1, 1346938C2	AM87392135	\$ 199.00	
2144, 2166, 2344, 2366	Lower Return Auger 62.81" Long	AM144021A2	\$ 306.97	
	Bearing - (2) Required	AM160796C91	\$ 13.00	
2188, 2388, 2588, 5088, 5130, 6088, 6130, 7088, 7130, 7140	Lower Return Auger Extended Wear, 85 3/4" Overall Length, Right Hand Flighting, 5 1/4" Flighting Diameter, 1 1/4" Shaft Diameter, 5 1/4" Pitch	AM144028A2	\$ 268.00	
	Bearing	AM160796C91	\$ 13.00	
2377, 2388, 2577, 2588	Seal, Tailings Auger Trough	AM1979194C2	\$ 82.68	
5088, 5130, 5140, 5150, 6088, 6130, 6140, 6150, 7088, 7130, 7140, 7150	Mid Range Clean Grain and Return Grain Auger Liner Kit Set of 2 Liners w/ Rivets	AMX29171	\$ 390.00	
5088, 5130, 5140, 6088, 6130, 6140, 7088, 7130, 7140	Return Grain Auger Trough Liner Stainless Steel Includes Stainless Steel Rivets and Mounting Hardware	AMX29158	\$ 219.00	
5140, 6140, 7140	Lower Return Auger 76.69" Long, 1.25" Shaft Diameter, 5" Flighting Diameter, Right Hand Rotation	AM47561763	\$ 280.37	
	Bearing	AM160796C91	\$ 13.00	

Prices Subject to Change without Prior Notice. The use of original equipment manufacturer (OEM) part numbers or trademarks, e.g. Case® and John Deere®, are for reference purposes only and for indicating product use and compatibility. Our company and the listed replacement parts contained herein are not sponsored, approved or manufactured by the OEM. All parts are New unless designated Reman in the description.

Case IH®—Combine

Application	Description	Part Number	Retail Price	Core
7010, 7120	Lower Return Auger, Extended Wear Replaces 87573646, 87730185	AM87730183	\$ 638.00	
	Lower Return Auger Trough Replaces 86975161	AM87380544	\$ 2000.00	
	Bearing	AMJD9202	\$ 18.00	
	Clean Grain and Return Grain Auger Trough Full Liner Kit Set of 2 Stainless Steel Weld-In Full Troughs, Narrow Frame 68" Overall Length Includes Stainless Steel for Door Covers	AMX29159	\$ 1075.00	
	Clean Grain and Return Grain Auger Trough Liner Patch Kit Set of 2 Stainless Steel Weld-In Liners (Narrow Frame)	AMX29120	\$ 885.00	
7010, 7120, 7230, 7240, 7250, 8010, 8120, 8230, 8240, 8250, 9010, 9120, 9230, 9240, 9250, AFX8010	Lower Return Auger Trough Cover Standard, w/o Holes, 62.55" Long	AM84078027	\$ 57.47	
7230, 8010, 8120, 8230, 9010, 9120, 9230 BSN TDG222000	Clean Grain and Return Grain Auger Trough Liner Patch Kit Set of 2 Stainless Steel Weld-In Repair Panels, 24" Long	AMX29119	\$ 410.00	
7230, 7240, 7250, 8010, 8120, 8230, 8240, 8250, 9120, 9230, 9240, 9250, AFX8010	Lower Return Auger, Extended Wear Replaces 84402650, 87573645, 86997058, 87730185, 87107475, 87282086, 87283631	AM84402652	\$ 677.00	
(7230, 8230, 9230 BSN YDG222000), 8010, 8120, 9120	Clean Grain and Return Grain Auger Trough Liner Kit Set of 2 Stainless Steel Weld-In Full Troughs 78" Overall Length Includes Stainless Steel for Door Covers	AMX29146	\$ 1082.00	
(7230, 8230, 9230 ASN YDG222000), 7240, 7250, 8240, 8250, 9240, 9250	Clean Grain and Return Grain Auger Trough Full Liner Kit Set of 3 Stainless Steel Weld-In Full Troughs Includes Stainless Steel for Door Covers	AMX29148	\$ 1114.00	
1440, 1460, 1480, 1680, 1688, 2188	Roller Chain, Return Elevator Drive 154 Links, Size 50 Chain	AM1302671C91	\$ 45.00	
1620	Roller Chain, Return Elevator Drive 66 Links, Size 40 Chain	AMX34132	\$ 30.00	
1640, 1644, 1660, 1666, 2144, 2166, 2344	Roller Chain, Return Elevator Drive 159 Links, Size 50 Chain	AM1327724C92	\$ 50.00	
2366	Roller Chain, Return Elevator Drive 162 Links, Size 50 Chain	AM301226A1	\$ 55.00	
2377, 2388, 2577, 2588	Roller Chain, Return Elevator Drive 156 Links, Size 50 Chain	AM84395718P	\$ 45.00	
5088, 6088, 7088 BSN Y9G001953	Roller Chain, Return Elevator Drive 134 Links, Size 60H Chain	AM1302671C92	\$ 45.00	
(5088, 6088, 7088 ASN Y9G001954), 5130, 5140, 6140 Prior to 10/2015, 6130, 7130	Roller Chain, Return Elevator Drive 134 Links, Size 60H Chain	AM84164207	\$ 60.00	
(5140, 6140 - 10/2015 and Later), 5150, 6150	Roller Chain, Return Elevator Drive 100 Links, Size 60H Chain	AM47707460	\$ 115.00	

Augers—Top Tailing Return

All augers are made with continuous roll-formed flighting for accuracy and durability.



Application	Description	Part Number	Retail Price	Core
1440, 1460, 1640, 1660, 1666, 2144, 2166, 2344, 2366	Top Return Auger 25 1/2" Overall Length, 5" Flighting Diameter, 1" Shaft Diameter, 5" Pitch	AM193225C1	\$ 155.00	
1480, 1482, 1680, 1682, 1688, 2188, 2377 SN HAJ292001-HAJ300000, 2388, 2577, 2588, 5088, 5130, 6088, 6130, 6140, 7088, 7130, 7140	Top Return Auger 37 1/2" Long, Left Hand Flighting, 5" Flighting Diameter, 1" Shaft Diameter, 5" Pitch Replaces 192563C1	AM87379140	\$ 177.00	

Case IH®—Combine

Application	Description	Part Number	Retail Price	Core
(5140, 6140, 7140 ASN YFG014001 and 10/2015), 5150, 6150, 7150	Top Return Auger 30 3/8" Overall Length, Left Hand Flighting, 4 3/4" Flighting Diameter, Shaft Diameter - 7/8" Hex Shaft and 0.997", 5" Pitch	AM47755502	\$ 336.00	
	Bearing, Metal	AM195293C91	\$ 7.00	
7010, 7120, 7230, 8010, 8120, 8230, 9010, 9120, 9230, AFX8010	Shaft, Tailings Processor Replaces 84405034	AM86997062	\$ 62.00	
1420, 1440, 1460, 1470, 1480, 1620, 1640, 1644, 1660, 1670, 1680, 1688, 2144, 2166, 2188, 2344, 2366, 2377 SN HAJ292001-HAJ300000, 2388, 2577, 2588	Bearing Hub, Return Auger 6.29" Long, 8.04" OD Replaces 192783C1	AM1324840C1	\$ 73.00	

Augers & Components—Grain Delivery Leveling

All augers are made with continuous roll-formed flighting for accuracy and durability.



Application	Description	Part Number	Retail Price	Core
1440 ASN 50001, 1460 ASN 52001	Grain Delivery Leveling Auger Extended Wear, 81 1/4" Overall Length, Left Hand Flighting, 7 1/2" Flighting Diameter, Shaft Diameter - 1 1/8" and 1", 7 1/2" Pitch	AM1319710C1	\$ 252.00	
	Slide-On Short Auxiliary Flight 11 1/2" Overall Length, Left Hand Flighting, 5" Flighting Diameter, Shaft Diameter - 1 3/4" Bore and 1 3/4" Bore, 5 1/4" Pitch For Grain Delivery Leveling Auger	AM162103C91	\$ 112.00	
	Bearing	NPS100RPC	\$ 7.00	
	Bearing, Flighting End	SA206-18	\$ 14.25	
1460 ASN 62001, 1620 Late, 1640 Early, 1644, 1660 Early, 1666	Grain Delivery Leveling Auger 79.06" Long, 1.25" Shaft - Horizontal	AM1318912C3	\$ 404.01	
	Slide-On Short Auxiliary Flight 11 1/2" Overall Length, Left Hand Flighting, 5" Flighting Diameter, Shaft Diameter - 1 3/4" Bore and 1 3/4" Bore, 5 1/4" Pitch For Grain Delivery Leveling Auger	AM162103C91	\$ 112.00	
	Bearing	NPS100RPC	\$ 7.00	
	Bearing, Flighting End	NPS104RPC	\$ 40.00	
1480, 1482 ASN 54001	Grain Delivery Leveling Auger Extended Wear, 79 3/8" Overall Length, Left Hand Flighting, 7 1/2" Flighting Diameter, Shaft Diameter - 1 1/8" and 1", 7 1/2" Pitch	AM1319709C1	\$ 291.00	
	Slide-On Short Auxiliary Flight 11 1/2" Overall Length, Left Hand Flighting, 5" Flighting Diameter, Shaft Diameter - 1 3/4" Bore and 1 3/4" Bore, 5 1/4" Pitch For Grain Delivery Leveling Auger	AM162103C91	\$ 112.00	
	Bearing	NPS100RPC	\$ 7.00	
	Bearing, Flighting End	SA206-18	\$ 14.25	
1660, 1666, 1680, 1688, 2144, 2166, 2188, 2344, 2366, 2388, 2588	Inclined Grain Delivery Leveling Auger Extended Wear-Sectional, 47 3/8" Overall Length, Left Hand Flighting, 7" Flighting Diameter, Shaft Diameter - 1" and 1 3/8"-16 Internal Spline, 8" Pitch Replaces 249275A2, 1968853C2	AM1968853C1	\$ 530.00	
	Bearing	SA207-22	\$ 15.00	
1660, 1666, 1680, 1688, 2144, 2166, 2188, 2344, 2366, 2388, 2588	Inclined Grain Delivery Leveling Auger Extended Wear-Sectional, 47 3/8" Overall Length, Hard Chrome Left Hand Flighting, 7" Flighting Diameter, Shaft Diameter - 1" and 1 3/8"-16 Internal Spline, 8" Pitch Replaces 320724A3, 87347842	AM222801A4	\$ 723.00	
	Bearing	NPS100RPC	\$ 7.00	
	Bearing	SA207-22	\$ 15.00	

Case IH®—Combine

Application	Description	Part Number	Retail Price	Core
1660, 1666, 1680, 1688, 2144, 2166, 2188, 2344, 2366, 2388 - w/ AFS	Inclined Grain Delivery Leveling Auger Extended Wear-Sectional, Notched for Sensor, 47 3/8" Overall Length, Hardened Chrome Left Hand Flighting, Split, 10" Flighting Diameter, Shaft Diameter - 1" and 1 3/8"-16 Internal Spline, 8" Pitch	AM320724A3	\$ 728.00	
5088, 5130, 6088, 6130, 7088, 7130, 7140	Inclined Delivery Auger Extended Wear, 76 1/2" Overall Length, Left Hand Flighting, 11 1/2" Flighting Diameter, Shaft Diameter - 1 3/8" Hex Shaft and 0.813" Bore, 8 1/2" Pitch Replaces 84577410	AM87563930	\$ 729.00	
5130, 6130, 7130	Bearing 2.838" OD, 1.378" Bore Replaces 80212606, 80212607, 84814912, 87605590	HC207-22	\$ 24.00	
(5140, 6140, 7140 ASN YFG014001), 6150, 7150	Incline Delivery Auger 81.50" Long, 1.377" Shaft Diameter Left Hand Flighting Ball Bearing	AM47740022	\$ 974.23	
(7230, 8230, 9230 - 2013-09/14 w/ Common Cab)	Incline Auger Liner Repair Sleeve	AMX29163	\$ 885.00	
7010, 7120, 8010, 8120, 9120, (7230, 8230, 9230 BSN 222000 w/ Non-Common Cab)	Incline Auger Liner Repair Sleeve 12-Gauge Steel Includes Bolt Kit	AMX29113	\$ 885.00	
(5140, 6140, 7140 ASN YFG014001), 5150, 6150, 7010, 7120, 7150, 7230, 7240, 7250, 8010, 8120, 8230, 8240, 8250, 9120, 9230, 9240, 9250, AFX8010	Inclined Delivery Auger Extended Wear, 81 5/8" Overall Length, Left Hand Flighting, 12" Flighting Diameter, Shaft Diameter - 1 3/8" and 1 1/4"-19 Internal Spline, 10" Pitch Replaces 47740022, 51620445, 87106615	AM87733275	\$ 733.00	
7010, 7120, 8010, 8120, 9120	Bearing	HC207-22	\$ 24.00	
7010, 7120, 8010, 8120, 9120	Inclined Delivery Auger Extended Wear, 72.562" Long Replaces 87106625	AM87733272	\$ 798.08	
1660, 1680, 1688, 2144, 2166, 2188, 2344, 2366, 2388, 2588	Bearing	HC207-22	\$ 24.00	
1660, 1680, 1688, 2144, 2166, 2188, 2366, 2377 SN 292001-300000, 2388, 2577	Inclined Delivery Drive Sprocket 29 Tooth	AM1321039C1	\$ 26.00	
1660, 1680, 1688, 2144, 2166, 2188, 2366, 2377 SN 292001-300000, 2388, 2577	Bearing, Incline Delivery Auger Replaces 611583R1, 611583R91	AMJD9275	\$ 24.15	
5088, 5130, (5140, 6140, 7140 - Prior to 2016), 6088, 6130, 7088, 7130	Incline Auger Liner Repair Sleeve 12-Gauge Steel Includes Bolt Kit	AMX29112	\$ 885.00	
(5140, 6140, 7140 - 2016 and Later), 5150, 6150, 7150	Incline Auger Liner Repair Sleeve 12-Gauge Steel	AMX29156	\$ 868.00	
7240, 7250, 8240, 8250, 9240, 9250	Incline Auger Liner Repair Sleeve 12-Gauge Steel Includes Bolt Kit	AMX29124	\$ 885.00	
7010, 7120, 7230, 7240, 8010, 8120, 8240, 9120, 9230, 9240, AFX8010	Driven Sprocket 26 Tooth, 1.182" Bore For Incline Delivery Auger	AM86999492	\$ 34.25	
1420, 1440, 1460, 1470, 1480, 1482, 1620, 1640, 1644, 1660, 1666, 1670, 1680, 1682, 1688, 2144, 2166, 2188, 2344, 2366, 2377, 2388, 2577	Flanged Bearing, 2-Bolt Replaces 211283C91	AM214490C91	\$ 15.00	
1660	Roller Chain, Horizontal Delivery Auger Drive 262 Links, Size 50 Chain	AMX34123	\$ 70.00	
1640, 1644, 1666, 2144, 2166, 2388 BSN JJC0276540	Roller Chain, Horizontal Delivery Auger Drive 264 Links, Size 50 Chain	AM1321308C91	\$ 70.00	
2344, 2366	Roller Chain, Horizontal Delivery Auger Drive 266 Links, Size 50 Chain	AM301228A1	\$ 76.00	
1660	Roller Chain, Incline Delivery Auger Drive Single Row, 246 Links, Size 50 Chain	AMX34124	\$ 65.00	

Case IH®—Combine

Application	Description	Part Number	Retail Price	Core
1666	Roller Chain, Incline Delivery Auger Drive Double Row, 246 Links, Size 50 Chain	AMX34125	\$ 65.00	
1688	Roller Chain, Incline Delivery Auger Drive 258 Links, Size 50 Chain	AM1327534C91	\$ 55.00	
2144, 2166	Roller Chain, Incline Delivery Auger Drive 246 Links, Size 50 Chain	AM1321307C91	\$ 65.00	
2344, 2366	Roller Chain, Incline Delivery Auger Drive 248 Links, Size 50 Chain	AM301227A1	\$ 65.00	
2377, 2388 BSN JJC0276540 & SN HAJ292001- HAJ300000, 2577, 2588	Roller Chain, Incline Delivery Auger Drive 260 Links, Size 50 Chain	AM1327534C92	\$ 76.00	
(5088, 6088 BSN Y9G001953), 7088 BSN Y9G001954	Roller Chain, Incline Delivery Auger Drive 266 Links, Size 50 Chain	AM87362139	\$ 76.00	
7010, 7120, 7230, 7240, 7250, 8010, 8120, 8230, 8240, 8250, 9010, 9120, 9230, 9240, 9250	Roller Chain, Incline Delivery Auger Drive 65 Links, Size 60 Chain Replaces 87105134, 87584814	AM87470736	\$ 70.00	
(5088, 7088 ASN Y9G001954), 5130, (5140, 6140, 7140 - Prior to 10/2015), 6088 ASN Y9H001954, 6130, 7130	Roller Chain, Incline Auger Drive 224 Links, Size 60H Chain	AM84163936	\$ 90.00	
(5140, 6140, 7140 - 10/2015 and Later), 5150, 6150, 7150	Roller Chain, Incline Auger Drive 144 Links, Size 60H Chain	AM47709870	\$ 125.00	

Augers & Components—Distribution

All augers are made with continuous roll-formed flighting for accuracy and durability.



Application	Description	Part Number	Retail Price	Core
1420 BSN 5500, 1440 BSN 30000, 1460 BSN 32000, (1470, 1482 BSN 10000), 1480 BSN 34000	Distribution Auger Extended Wear, 78 1/4" Overall Length, Right Hand Flighting, 5" Flighting Diameter, 1 1/8" Hex Shaft Diameter, 5" Pitch	AM193398C1	\$ 142.00	
	Bearing, Metal	AM195293C91	\$ 7.00	
1420 ASN 5501, 1440 ASN 30001, 1460 ASN 32001, (1470, 1482 ASN 10001), 1480 ASN 34001, 1620, 1640, 1644, 1660, 1666, 1670, 1680, 1682, 1688, 2144, 2166, 2188, 2344, 2366, 2388, 2588	Distribution Auger 78.25" Long, Right Hand Flighting, 0.875" Hex Shaft Replaces 1309229C1	AM1308541C1	\$ 165.00	
	Bearing, Metal	AM195293C91	\$ 7.00	
2577, 2588, 5088, 5130, 5140, 5150, 6088, 6130, 6140, 6150, 7088, 7130, 7140, 7150	Distribution Auger, Right Hand 79 1/4" Overall Length, Right Hand Flighting, 5" Flighting Diameter, Shaft Diameter - 7/8" Hex Shaft and 0.874" Hex Shaft, 5" Pitch	AM87649711	\$ 281.00	
	Distribution Auger, Left Hand 79 1/4" Overall Length, Left Hand Flighting, 5" Flighting Diameter, Shaft Diameter - 7/8" Hex Shaft and 0.874" Hex Shaft, 5" Pitch	AM87649712	\$ 275.00	
	Bearing, Metal	AM195293C91	\$ 7.00	
1440, 1460, 1470, 1640, 1644, 1666, 1670, 2144, 2166, 2344, 2366	Support, Auger Drive	AM1309225C1	\$ 65.40	
1420, 1440, 1460, 1470, 1480, 1482, 1620, 1640, 1644, 1660, 1666, 1670, 1680, 1682, 1688, 2144, 2166, 2188, 2344, 2366, 2388, 2588	Shoe Auger Board (1) Required per Auger Replaces B94626	AM193414C2	\$ 10.00	
1680, 1688, 2188, 2377 ASN HAJ0292001, 2388, 5130, 6088, 6130, 6140, 7088, 7130, 7140	Shaker Shoe Supply Auger Shaft 74.12" Long	AM1322616C2	\$ 372.00	
1420, (1440, 1460, 1482 ASN 5501), 1470 ASN 10001, 1480, 1620 ASN JJC0032630, 1640, 1644, 1660 ASN JJC0039550, 1666, 1670 ASN JJC0080540, 1680, 1682, 1688, 2144, 2166, 2188, 2344, 2366, 2377 ASN HAJ0292001, 2388 BSN JJC0276540 & ASN HAJ0292001, 2577, 2588, 5088, 5130, 6088, 7088	Slip Clutch Drive Hub	AM1303136C2	\$ 95.00	

Case IH®—Combine



Distribution Auger Pans and Components

Application	Description	Part Number	Retail Price	Core
1440, 1460, 1640, 1644, 1660 1666, 1670, 2144, 2166, 2344, 2366	Distribution Pan	AM185038C7	\$ 1315.38	
1480, 1680, 1688, 2188, 2388, 2588	Distribution Pan	AM191645C6	\$ 944.00	
1420, 1440, 1460, 1470, 1480, 1482, 1620, 1640, 1644, 1660, 1666, 1670, 1680, 1682, 1688, 2144, 2166, 2188, 2344, 2366, 2377, 2388, 2577, 2588	Grain Bed Auger Liner 16-Gauge Stainless Steel For Outside Augers Includes Rivets	AMX29153	\$ 225.00	
	Grain Bed Auger Liner 16-Gauge Stainless Steel For Inside Augers Includes Rivets	AMX29154	\$ 225.00	
1420, 1620	Grain Bed Auger Liner Set 16-Gauge Stainless Steel Includes (2) Outside Auger Bed Liners, Inside Auger Bed Liner and Rivets	AMX29164	\$ 650.00	
1440, 1460, 1470, 1640, 1644, 1660, 1666, 1670, 2144, 2166, 2344, 2366	Grain Bed Auger Liner Set Set of 4 16-Gauge Stainless Steel Includes (2) Outside Auger Bed Liners, (2) Inside Auger Bed Liners and Rivets	AMX29165	\$ 875.00	
1480, 1482, 1680, 1682, 1688, 2188, 2388, 2588	Front Panel Replaces 87378752	AM1345014C3	\$ 70.00	
1480, 1680, 1688, 2188, 2388, 2588	Clean Out Door (5) Required	AM185068C1	\$ 13.00	
1420, 1440, 1444, 1460, 1620, 1640, 1660, 1666, 2144, 2166, 2344, 2366	Grain Diverter	AMX29053	\$ 79.00	
1480, 1680, 1688, 2188, 2388	Grain Diverter	AMX29054	\$ 77.50	
1480 ASN 34002, 1680, 1688, 2188, 2377, 2388, 2577, 2588, 5088, 6088, 7088	Auger Drive Support Replaces 1309226C1	AM87379131	\$ 51.50	
1420, 1440, 1460, 1470, 1480, 1482, 1620, 1640, 1644, 1660, 1666, 1670, 1680, 1682, 1688, 2144, 2166, 2188, 2344, 2366, 2388	Bevel Gear 14 Tooth, 1.13" Hex ID Replaces 87375654	AM191677C1	\$ 26.00	
1420, 1440, 1460, 1470, 1480, 1482, 1620, 1640, 1644, 1660, 1666, 1670, 1680, 1682, 1688, 2144, 2166, 2188, 2344, 2366, 2388, 5088, 6088, 7088	Bevel Gear 14 Tooth, 0.875" Hex ID Replaces 87375653	AM194194C1	\$ 20.00	
1480, 1482, 1680, 1682, 1688, 2188, 2377, 2388, 2577, 2588	Grain Bed Auger Liner Set Set of 5 16-Gauge Stainless Steel Includes (2) Outside Auger Bed Liners, (3) Inside Auger Bed Liners and Rivets	AMX29166	\$ 1095.00	

Case IH®—Combine

Augers & Components—Vertical Unloading

All augers are made with continuous roll-formed fighting for accuracy and durability.

Application	Description	Part Number	Retail Price	Core
1440, 1460, 1480, 1640 BSN 97102, 1660 BSN 102896, 1680 BSN 115351	Vertical Unloading Auger Extended Wear, Single Fighting 50 1/4" Overall Length, Right Hand Fighting, 11.60" Fighting Diameter, Shaft Diameter - 1.385" Bore and 1.50" Square Bore, 8" Pitch For Older Open Gearbox	AM192835C1	\$ 407.00	
	Vertical Unloading Auger Extended Wear, Double Flight Auger 50 1/4" Overall Length, Right Hand Fighting, 11.60" Fighting Diameter, Shaft Diameter - 1.385" Bore and 1.50" Square Bore, 8" Pitch, Square Bottom Drive, Round Top Drive For Older Open Gearbox	AM132434C1	\$ 520.00	
1440, 1460, 1480, 1640, 1660, 1680 - Early models that have been retrofitted to or updated w/ new enclosed gearbox	Vertical Unloading Auger Extended Wear, 50 1/2" Overall Length, Right Hand Fighting, 11.60" Fighting Diameter, Shaft Diameter - 1 3/8" Bore and 1 3/8"-6 Internal Spline, 8" Pitch	AM1347341C1	\$ 546.00	
1640 ASN 97103, 1644, 1660 ASN 102897, 1666, 1680 ASN 115352, 1688, 2144, 2166, 2188, 2344, 2366, 2388, 2588	Vertical Unloading Auger Extended Wear, Single Fighting 49 1/8" Overall Length, Right Hand Fighting, 11.60" Fighting Diameter, Shaft Diameter - 1 1/4"-19 Internal Spline and 1 3/8"-6 Internal Spline, 8" Pitch Replaces 87325666	AM1347389C1	\$ 407.00	
5088, 5130, 5140, 5150, 6088, 6130, 6140, 6150, 7010, 7088, 7120, 7130, 7140, 7150, 7230, 7250, 8010, 8120, 8250, 9120, 9250, AFX8010	Vertical Unloading Auger, Extended Wear Extended Wear, 47" Overall Length, Left Hand Fighting, 14 1/2" Fighting Diameter, Shaft Diameter - 8 Internal Spline Both Ends, 11 1/2" Pitch Replaces 84447940, 87733266	AM87756536	\$ 850.00	
	Unloading Auger Drive Hub (2) Required per Auger	AM87011705	\$ 28.00	
(7230, 8230 - w/ High Capacity and Non-Common Cab or All w/ Common Cab), (7240, 8240, 9240 BSN YGG231218), 9230	Vertical Unloading Auger, Extended Wear Extended Wear, 41 1/4" Overall Length, Left Hand Fighting, 15 1/2" Fighting Diameter, Shaft Diameter - 24 Internal Spline Both Ends, 10 1/2" Pitch	AM84522663	\$ 1125.00	
(7230, 8230, 9230 - w/ Common Cab), (7240, 8240, 9240 ASN YGG231219 Excluding MY18), (7250, 8250, 9250 - MY19)	Vertical Unloading Auger, Extended Wear Extended Wear, High Capacity, 41 1/4" Overall Length, Left Hand Fighting, 15 1/2" Fighting Diameter, Shaft Diameter - 8 Internal Spline and 8 Internal Spline, 10 1/2" Pitch Replaces 47886358	AM47886360	\$ 1000.00	
5088, 5130, 5140, 6088, 6130, 6140, 7010, 7088, 7120, 7130, 7140, 7230, 8010, 8120, 9010, 9120 Will not fit models w/ cast Unloading Auger Elbow	Vertical Unloading Auger Liner Kit Includes Repair Ring and Full Sump Liner Kit All Weld-In Only	AMX29088	\$ 1148.00	
7230, 7240, 7250, 8230, 8240, 8250, 9230, 9240, 9250 For Models w/ Cast Iron Unloading Auger Elbow	Vertical Unloading Auger Liner	AMX29145	\$ 1125.00	
5088, 5130, 5140, 6088, 6130, 6140, 7088, 7130, 7140	Cone	AM87695821	\$ 30.00	
	Unloading Auger Drive Coupling	AM87470291	\$ 150.00	
1640, 1644, 1660, 1666, 1680, 1688, 2144, 2166, 2188, 2344, 2366, 2377, 2388	Unloading Auger Output Shaft	AM1989463C1	\$ 128.00	
1640 ASN JJC0034705, 1644, 1660 ASN JJC0037346, 1666, 1680 ASN JJC0045689, 1688, 2144, 2166, 2188, 2344, 2388, 2588	Unloading Auger Gearbox, Lower	AM1347336C2	\$ 842.00	
5088, 5130, 5140, 5150, 6088, 6130, 6140, 6150, 7010, 7088, 7120, 7130, 7140, 7150, 7230, 7240, 7250, 8010, 8120, 8230, 8240, 8250, 9010, 9120, 9230, 9240, 9250, AFX8010	Unloading Auger Gearbox, Lower	AM84320052	\$ 985.00	
1640, 1644, 1660, 1666, 1688, 2144, 2166, 2188, 2344, 2366, 2377, 2388	Gearbox Input Shaft	AM1989462C1	\$ 76.00	

Case IH®—Combine

Application	Description	Part Number	Retail Price	Core
5088, 5130, (5140, 6140, 7140 - 03/2014-10/15), (5150, 6150, 7150 - Tier 3), 6088, 6130 w/ Common Cab, 7088, 7130 w/ Common Cab 2013	Vertical Gearbox Input Shaft	AM87491122	\$ 325.00	
(5140, 6140, 7140 - 10/2015-08/18), 5150 10/2018-07/19, 6150, 7010, 7120, 7150 Tier 4B, 7230, 7240, 7250, 8010, 8120, 8230, 8240, 8250, 9010, 9120, 9230, 9240, 9250, AFX8010	Vertical Gearbox Output Shaft	AM87441208	\$ 215.00	
5088, (5130, 6130 - w/ Common Cab 2013-03/14), (7130 w/ Common Cab 2013), (5140, 6140, 7140 - 03/2014-10/15), 6088, 7088, (5150, 6150, 7150 - Tier 3)	Unloading Auger Bevel Gear	AM84437278	\$ 125.00	
5088, 5130, 5140, 6088, 6130, 6140, 7010, 7088, 7120, 7130, 7140, 8010, 8120, 9010, 9120	Repair Ring For Repair of Top of Vertical Unload Tube	AMX29111	\$ 65.00	
1440, 1460, 1480, 1620, 1640 BSN JJC0035422, 1660 BSN JJC040895, 1680 BSN JJC0047801	Roller Chain, Grain Tank Unloading Auger Drive 158 Links, Size 40 Chain	AM192927C91	\$ 30.00	
1620 BSN JJC0032630	Roller Chain, Grain Tank Unloading Auger Drive 158 Links, Size 50 Chain	AMX34116	\$ 40.00	
1620 ASN JJC0032629, 1644, 1666, 1688, 2144, 2166, 2188, 2344, 2366, 2377, 2388	Roller Chain, Grain Tank Unloading Auger Drive 150 Links, Size 40 Chain	AMX34118	\$ 30.00	
1640 ASN JJC0097102, 1660 ASN JJC0102896, 1680 ASN JJC0115351	Roller Chain, Grain Tank Unloading Auger Drive 154 Links, Size 40 Chain	AMX34117	\$ 30.00	
1640 SN JJC0035422-JJC0097103, 1660 SN JJC0040895-JJC0102897, 1680 SN JJC0047801-JJC0115352	Roller Chain, Grain Tank Unloading Auger Drive 162 Links, Size 40 Chain	AMX34119	\$ 30.00	
1680 ASN JJC0115351, 2577, 2588	Roller Chain, Grain Tank Unloading Auger Drive 124 Links, Size 50 Chain	AM87529598	\$ 38.00	
5088, 5130, 5140 Prior to MY18, 6130 - w/ Common Cab	Roller Chain, Grain Tank Unloading Auger Drive 266 Links, Size 60H Chain	AM87707588	\$ 90.00	
5140 (MY18), 5150, 6130 w/ Non-Common Cab, 6140, 6150, 7130, 7140	Roller Chain, Grain Tank Unloading Auger Drive 246 Links, Size 60H Chain Replaces 84250965	AM47694331	\$ 90.00	
6088, 7088	Roller Chain, Grain Tank Unloading Auger Drive 248 Links, Size 60H Chain Replaces 87524544	AM87713148	\$ 90.00	
7010, 7120, (7250, 8250, 9250 - Single Drive), 8010, 8120, 9010, 9120, 9240 (MY18), AFX8010	Roller Chain, Grain Tank Unloading Auger Drive 284 Links, Size 60H Chain	AM86998066	\$ 110.00	
7010, 7120, 8010, 8120, 9010, 9120, AFX8010	Roller Chain, Grain Tank Unloading Auger Drive 288 Links, Size 60H Chain	AM87680581	\$ 90.00	
7230, 7240, 8230, 8240, 9230, 9240 MY18 w/o Redekop™ Option	Roller Chain, Grain Tank Unloading Auger Drive 220 Links, Size 80 Chain Replaces 84375704	AM84566255	\$ 115.00	
7230, (7240, 8240 Prior to MY18), 7250, 8230, 8250, 9230 - w/ Non-Common Cab, 9240 09/2015 and Later w/o Redekop™ Option	Roller Chain, Grain Tank Unloading Auger Drive Dual Drive, 199 Links, Size 60H Chain	AM84345681	\$ 80.00	
7240 (MY18 w/o Redekop™ Option), 7250, 8230, 8240 (MY18), 8250, 9230 w/ Common Cab, 9240 w/o Redekop™ Option	Roller Chain, Grain Tank Unloading Auger Drive Dual Drive, 192 Links, Size 60H Chain	AM84351953	\$ 85.00	
5088, 5130, 5140 Prior to MY18, 6130 - w/ Common Cab	Roller Chain, Vertical Auger Drive 266 Links, Size 60H Chain	AM87707588	\$ 90.00	
5140 (MY18), 5150, 6130 w/ Non-Common Cab, 6140, 6150, 7130, 7140	Roller Chain, Vertical Auger Drive 246 Links, Size 60H Chain Replaces 84250965	AM47694331	\$ 90.00	
6088, 7088	Roller Chain, Vertical Auger Drive 248 Links, Size 60H Chain Replaces 87524544	AM87713148	\$ 90.00	
7010, 7120, 8010, 8120, 9010, 9120, AFX8010	Roller Chain, Vertical Auger Drive 288 Links, Size 60H Chain	AM87680581	\$ 90.00	
7230, 7240, 8230, 8240, 9230, 9240 MY18 w/o Redekop™ Option	Roller Chain, Vertical Auger Drive 220 Links, Size 80 Chain Replaces 84375704	AM84566255	\$ 115.00	

Case IH®—Combine

Application	Description	Part Number	Retail Price	Core
1440, 1460, 1480, 1620 ASN JJC032629, 1640 BSN JJC097103, 1660 BSN JJC0102897, 1680 BSN JJC0115352	Roller Chain, Vertical Unloading Auger Drive 134 Links, Size 50 Chain	AMX34120	\$ 40.00	
1620 BSN JJC032630, 1640 ASN JJC097103, 1660 ASN JJC0102896, 1666, 1688, 2144, 2166, 2188, 2344, 2366, 2377, 2388	Roller Chain, Vertical Unloading Auger Drive 131 Links, Size 50 Chain	AM1303207C91	\$ 53.00	
1644	Roller Chain, Vertical Unloading Auger Drive 130 Links, Size 50 Chain	AMX34121	\$ 40.00	
2577, 2588	Roller Chain, Vertical Unloading Auger Drive 107 Links, Size 60 Chain	AMX34122	\$ 60.00	
7230, 7240, 7250, 8230, 8240, 8250, 9230, 9240 w/o Redekop™ Option	Roller Chain, Vertical Unloading Auger Drive Dual Drive, 167 Links, Size 60H Chain Replaces 84525580	AM51436188	\$ 65.00	

Augers & Components—Horizontal Unloading

All augers are made with continuous roll-formed fighting for accuracy and durability.



Application	Description	Part Number	Retail Price	Core
1420, 1440, 1460, 1470, 1480, 1482	Horizontal Unloading Auger Tube - Rear	87" AM195342C1	\$ 510.00	
	Horizontal Unloading Auger Extended Wear, Right Hand Fighting, 11 1/2" Fighting Diameter, Shaft Diameter - 1" and 1.385" Bore, 11 1/2" Pitch 1-Piece Setup	143 3/8" AM192845C2	\$ 625.00	
	Bearing	AM160796C91	\$ 13.00	
1460, 1470, 1480, 1482	Horizontal Unloading Auger Tube - Front	85.50" AM192089C1	\$ 509.00	
	Horizontal Unloading Auger Tube - Rear	87" AM195342C1	\$ 510.00	
	Horizontal Unloading Auger Extended Wear, Early Style Smooth Hole, Right Hand Fighting, 11 1/2" Fighting Diameter, Shaft Diameter - 1" and 1 3/8" Bore, 13" Pitch 1-Piece Setup, 172"	182 1/8" AM1317935C1	\$ 691.00	
	Bearing	AM160796C91	\$ 13.00	
1600 Series Early, Smooth Hole	Horizontal Unloading Auger Tube - Front	90" AM1317738C1	\$ 578.00	
	Horizontal Unloading Auger Tube - Rear	82.50" AM1317783C2	\$ 434.00	
	Horizontal Unloading Auger Extended Wear, 1-Piece Setup, 172"	182 1/8" AM1317935C1	\$ 691.00	
	Bearing - 2 Required	AM160796C91	\$ 13.00	
1600 Series Late, Splined Hole	Horizontal Unloading Auger Tube - Front	90" AM1317738C1	\$ 578.00	
	Horizontal Unloading Auger Tube - Rear	82.50" AM1317783C2	\$ 434.00	
	Horizontal Unloading Auger Extended Wear, Right Hand Fighting, 11 1/2" Fighting Diameter, Shaft Diameter - 1" and 1 1/4"-19 Internal Spline, 11 3/4" Pitch	180 1/2" AM1347499C1	\$ 830.00	
	Bearing For 172" 1-Piece Setup	AM160796C91	\$ 13.00	
1620, 1640, 1644, 1660, 1666, 1680, 1688, 2144, 2166, 2188, 2344, 2366, 2377, 2388 BSN 300000	Horizontal Unloading Auger Tube - Front Perforated 1-Piece or 2-Piece Setup, 168" or 204"	90" AM1317873C1	\$ 673.00	
1620, 1640, 1644, 1660, 1666, 2144, 2166	Horizontal Unloading Auger Tube - Rear Replaces 1317734C1, 1317734C2, 1317734C3	136" AM1317734C4	\$ 420.00	
1640, 1644, 1660, 1666, 1670, 1680, 1688, 2144, 2166, 2188, 2344, 2366, 2388	End Cap, Horizontal Unloading Auger Tube Replaces 182837C1	AM182837C2	\$ 128.00	

Case IH®—Combine

Application	Description	Part Number	Retail Price	Core
(1640, 1660, 1680 Early)	Horizontal Unloading Auger Tube - Front	90" AM1317738C1	\$ 578.00	
	Horizontal Unloading Auger Tube - Rear	82.50" AM1317783C2	\$ 434.00	
	Horizontal Unloading Auger - Front Extended Wear, Right Hand Flighting, 11 1/2" Flighting Diameter, Shaft Diameter - 1" Hex Bore and 1.378" Bore, 11 3/4" Pitch	91 1/8" AM1317891C1	\$ 450.00	
	Horizontal Unloading Auger - Rear Extended Wear, Right Hand Flighting, 11 1/2" Flighting Diameter, Shaft Diameter - 1" and 1" Hex Bore, 11 3/4" Pitch Replaces 183925A1, 199018A1, 199018A2, 1317680C1	88 3/4" AM1317680C2	\$ 375.00	
	Bearing Support Use w/ Split Unloading Auger	AM1317859C1	\$ 55.00	
	Bearing	AMJD9313	\$ 11.00	
	Hex Shaft 2-Piece Setup	172" AM220040A2	\$ 20.00	
	(1640, 1660, 1666, 1680, 1688, 2144, 2166, 2188, 2344, 2366, 2388 Late)	Horizontal Unloading Auger Tube - Front	90" AM1317738C1	\$ 578.00
Horizontal Unloading Auger Tube - Rear		82.50" AM1317783C2	\$ 434.00	
Horizontal Unloading Auger - Front Extended Wear, Right Hand Flighting, 11 1/2" Flighting Diameter, Shaft Diameter - 1/4"-19 Internal Spline and 1" Hex Bore, 13" Pitch Replaces 198987A1, 1989388C1, 1989388C2		90 1/2" AM198987A2	\$ 626.00	
Horizontal Unloading Auger - Rear Extended Wear, Right Hand Flighting, 11 1/2" Flighting Diameter, Shaft Diameter - 1" and 1" Hex Bore, 11 3/4" Pitch Replaces 183925A1, 199018A1, 199018A2, 1317680C1		88 3/4" AM1317680C2	\$ 375.00	
Bearing Support Use w/ Split Unloading Auger		AM1317859C1	\$ 55.00	
Bearing		AMJD9313	\$ 11.00	
Hex Shaft 2-Piece Setup		172" AM220040A2	\$ 20.00	
(1644, 1660, 1666, 1680, 1688, 2144, 2166, 2188, 2344, 2366, 2388 Late)		Horizontal Unloading Auger Tube - Front	90" AM1317738C1	\$ 578.00
	Horizontal Unloading Auger Tube - Rear	118" AM1317899C3	\$ 580.00	
	Horizontal Unloading Auger - Front Extended Wear, Right Hand Flighting, 11 1/2" Flighting Diameter, Shaft Diameter - 1/4"-19 Internal Spline and 1" Hex Bore, 13" Pitch Replaces 198987A1, 1989388C1, 1989388C2	90 1/2" AM198987A2	\$ 626.00	
	Horizontal Unloading Auger - Rear Extended Wear, Right Hand Flighting, 11 1/2" Flighting Diameter, Shaft Diameter - 1" and 1" Hex Bore, 11 3/4" Pitch Replaces 199023A1, 1321147C1, 1321147C2, 87379141	125" AM199023A2	\$ 648.00	
	Bearing	AM160796C91	\$ 13.00	
	Bearing Support Use w/ Split Unloading Auger	AM1317859C1	\$ 55.00	
	Bearing	AMJD9313	\$ 11.00	
	Hex Shaft 2-Piece Setup, 208" Overall	172" AM220040A2	\$ 20.00	

Case IH®—Combine

Application	Description	Part Number	Retail Price	Core
1644, 1660, 1666, 1680, 1688, 2144, 2166, 2188, 2344, 2366, 2388, 2588	Horizontal Unloading Auger Outer Tube	142" AM1317899C3-3	\$ 695.00	
	Horizontal Unloading Auger - Rear Extended Wear, Right Hand Flighting, 11 1/2" Flighting Diameter, Shaft Diameter - 1" and 1" Hex Bore, 11 3/4" Pitch Note: 1-Piece Extender Setup extends Unloading Auger to 236", Tube and Auger must be used together	147 1/2" AM199023A2-3	\$ 810.00	
2577, 2588	Horizontal Unloading Auger Tube - Front Solid Tube Replaces 87556840	126" AM87557135	\$ 1225.00	
	Horizontal Unloading Auger Tube - Front Perforated Tube Replaces 87517336, 87556844	126" AM87557138	\$ 1300.00	
	Horizontal Unloading Auger Tube - Rear 18' Setup Replaces 87398374, 87557244	82.50" AM87581650	\$ 1065.00	
	Horizontal Unloading Auger Tube - Rear 21' Setup Replaces 87389564, 87398396, 87542332	118.50" AM87581654	\$ 1175.00	
	Horizontal Unloading Auger - Rear 18' Setup Replaces 183925A1, 199018A1, 199018A2	89.25" AM87557246	\$ 686.00	
	Bearing	AM160796C91	\$ 13.00	
	Horizontal Unloading Auger For 18' and 21' Systems	AM87556898	\$ 1057.33	
5088, 5130, 5140, 5150, 6088, 6130, 6140, 6150, 7010, 7088, 7120, 7130, 7140, 7150, (7230, 8230, 9230 - Tier 4 03/2012-13), (7240, 8240, 9240 - MY18), 7250, 8010, 8120, 8250, 9010, 9120, 9250, AFX8010	Horizontal Unloading Auger Extended Wear, Left Hand Flighting, 12 1/2" Flighting Diameter, Shaft Diameter - 1.18" and 8 Internal Spline, 16" Pitch Replaces 84073843, 87280339, 87560311, 87575221	214 15/16" AM84447941	\$ 1366.00	
	Bearing	AMJD10384	\$ 22.00	
5088, 5130, (5140, 6140, 7140 - Tier 4B 03/2014- 10/15), 6088, 6130, 7088, 7120, 7130, (7230, 8230, 9230 - Tier 4 03/2012-13), 8120, 9120	Horizontal Unloading Auger Tube Standard Rate, Red Tube Machines, 19-Hole Mounting Flange For 21' System Replaces 87738223	198.25" AM87743673	\$ 1550.00	
5088, 5130, 5140, 5150, 6088, 6130, 6140, 6150, 7010, 7088, 7120, 7130, 7140, 7150, 7230, 7250, 8010, 8120, 8230, 8250, 9010, 9120, 9230, 9250, AFX8010	Horizontal Unloading Auger Replaces 84331632, 87280340, 87280341, 87575225, 87657822	38" AM87575223	\$ 839.91	
	Horizontal Unloading Auger Extension Extended Wear, 3' Extension, 21 Spline, 4.50" Tube Diameter Replaces 87280340, 87280341, 87575225	38" AM87657822	\$ 911.65	
	Horizontal Unloading Auger Tube 3' Extension Replaces 87552536	AM87470153	\$ 908.00	
	Bearing	HC207-22	\$ 24.00	
5088, 6088, 7010, 7088, 7120, 8010, 8120, 9120	Bearing Support Use w/ 3" Unloading Auger Extension	AM84072623	\$ 35.79	
7010, 8010, AFX8010	Horizontal Unloading Auger Tube Extended Wear Replaces 87280552, 87284775	216" AM87470158	\$ 2640.00	
(7230, 8230, 9230 - w/ Common Cab 2013-09/14), (7240, 8240, 9240 - Prior to MY18)	Horizontal Unloading Auger Extension Extended Wear, 5' Extension, Left Hand Flighting, 14" Flighting Diameter, Shaft Diameter - 1 3/4" and 24 Internal Spline, 4.50" Tube Diameter, 14" Pitch Replaces 47395184, 84362490, 84384607	64 1/4" AM47395186	\$ 1040.00	
	Bearing w/ Lock Collar	AM84416910	\$ 52.13	









Case IH®—Combine

Application	Description	Part Number	Retail Price	Core
(7230, 8230, 9230 - w/ Common Cab 2013-09/14), 7240, 7250, 8240, 8250, 9240, 9250	Horizontal Unloading Auger - Rear Outer Fold Extended Wear Replaces 47395202, 47425443, 84365603, 84416898, 84529926	95.25" AM47445370	\$ 1520.54	
	Bearing w/ Lock Collar	AM84489731	\$ 37.17	
7230, 7240, 8230, 8240, 9230, 9240	Unloading Auger Tube Solid Tube Outer Section for 21' High Unload Auger	194 5/8" AM47405760	\$ 2100.00	
7230, (7240, 8240 BSN YGG231218), 8230, 9230, 9240	Horizontal Unloading Auger Extended Wear, High Capacity, Left Hand Flighting, 14" Flighting Diameter, Shaft Diameter - 1 3/16" and 24 Internal Spline 14 1/2" Pitch	228 3/8" AM47373691	\$ 2150.00	
(7230, 8230, 9230 - w/ Common Cab 2013-09/14), (7240, 8240, 9240 - Prior to MY18), (7250, 8250, 9250 - Perforated)	Horizontal Unloading Auger Extended Wear, High Capacity, Left Hand Flighting, 14" Flighting Diameter, Shaft Diameter - 1 3/16" and 8 Internal Spline, 14 1/2" Pitch	227 5/8" AM47897750	\$ 1943.00	
	Bearing	AMJD10384	\$ 22.00	
(7230, 8230, 9230 - w/ Common Cab 2013-09/14), (7240, 8240, 9240 - Prior to MY18)	Horizontal Unloading Auger - Front Inner Fold Extended Wear, Left Hand Flighting, 14" Flighting Diameter, Shaft Diameter - 1.62" and 24 Internal Spline, 14" Pitch Replaces 84512841	90 1/2" AM47395188	\$ 1050.00	
	Bearing w/ Lock Collar	AM84416910	\$ 52.13	
	Horizontal Unloading Auger - Middle Inner Fold Extended Wear Replaces 47389784, 47395199, 84364992, 84416893	114.75" AM47476066	\$ 1681.08	
	Bearing w/ Lock Collar	AM84416910	\$ 52.13	
(7230, 8230, 9230 - w/ Common Cab ASN YGG231219), (7240, 8240, 9240 ASN YGG231219), 7250, 8250, 9250	Horizontal Unloading Auger Extension High Capacity Extension Extended Wear, Left Hand Flighting, 14" Flighting Diameter, Shaft Diameter - 1 5/8" and 8 Internal Spline, 14" Pitch	72 1/4" AM47826369	\$ 1023.00	
	Bearing w/ Lock Collar	AM84416910	\$ 52.13	
(7230, 8230, 9230 - w/ Common Cab 2013-09/14), 7240, 7250, 8240, 8250, 9240, 9250	Horizontal Unloading Auger Extension Tube High Capacity, Cast Flange	60" AM84536432	\$ 3000.00	
7240, 8240, 9240 - Prior to MY18	Horizontal Unloading Auger - Front Inner Fold Extended Wear, Left Hand Flighting, 14" Flighting Diameter, Shaft Diameter - 1.62" and 24 Internal Spline, 14" Pitch	116 5/8" AM47523765	\$ 1229.00	
	Bearing w/ Lock Collar	AM84489731	\$ 37.17	
	Horizontal Unloading Auger - Middle Inner Fold Extended Wear, Left Hand Flighting, 14" Flighting Diameter, Shaft Diameter - 1.382" and 24 Internal Spline, 14" Pitch	91 3/4" AM47523269	\$ 998.00	
	Bearing w/ Lock Collar	AM84416910	\$ 52.13	
(1620, 1640, 1644, 1660, 1666, 1680, 1682, 1688 - w/ Spill Saver Attachment), 2144, 2166, 2188, 2344, 2366, 2377, 2388, 2577, 2588	Rubber Spout	AM113488A1	\$ 59.45	

Unloading Auger Elbows and Components

Application	Description	Part Number	Retail Price	Core
 1420, 1440, 1460, 1480, 1640, 1644, 1660, 1666, 1670, 1680, 1682, 1688, 2144, 2166, 2188, 2344, 2366, 2377, 2388, 2577, 2588	Unloading Auger Elbow 19-Bolt Tube Mount Replaces 248308A1, 248308A2, 1989472C1, 87398012	AM87598258	\$ 600.00	

Case IH®—Combine

	Application	Description	Part Number	Retail Price	Core
	5088, 5130, 5140, 5150, 6088, 6130, 6140, 6150, 7010, 7088, 7120, 7130, 7140, 7150, (7230, 8230, 9230 - w/ Non-Common Cab, 03/2012-01/13), (7240, 8240, 9240 - MY18), 7250, 8010, 8120, 8250, 9010, 9120, 9250	Unloading Auger Elbow Standard Capacity 19-Bolt Tube Mount Replaces 87474233, 87552529, 87754415	AM84126361	\$ 1760.00	
	5088, 5130, 5140, 5150, 6088, 6130, 6140, 6150, 7010, 7088, 7120, 7130, 7140, 7150, (7230, 8230, 9230 - w/ Non-Common Cab), (7240, 8240, 9240 - MY18), 7250, 8010, 8120, 8250, 9010, 9120, 9250, AFX8010	Unloading Auger Elbow Bushing 1.57" Tall, 16.06" ID, 17.32" OD	AM86558526	\$ 69.00	
	(7230, 7240, 7250, 8230, 8240 (MY18), 8250, 9230, 9240 (MY18), 9250 - w/ High Capacity Unloading System), (7230, 7240, 8240 (Prior to MY18), 9240 - w/ 21' High Speed, High Capacity Unloading System), (7230, 8230, 9230 - w/ High Speed, Folding Unloading System and w/ Common Cab 03/2012-09/14), (7240, 8240 (Prior to MY18), 9240 - w/ High Capacity Unloading System w/ Folding Top), (8230, 9230 - w/ 21' High Speed, High Capacity Unloading System and w/ Common Cab 03/2012-09/14)	Unloading Auger Elbow High Capacity, 10-Bolt Tube Mount Replaces 47463149	AM84345590	\$ 3900.00	
	AFX8010	Unloading Auger Elbow Black Replaces 87044522, 87280557, 87281407, 87354631, 87757649	AM84126362	\$ 1862.00	
	1640, 1644, 1660, 1666, 1670, 1680, 1682, 1688, 2144, 2166, 2188, 2344, 2366, 2388	Unloading Auger Gearbox	AM1347351C2	\$ 791.00	
	5088, 5130, 5140, 6088, 6130, 6140, 7010, 7088, 7120, 7130, 7140, 7230, (7240, 8240, 9240 - MY18), 7250, 8010, 8120, 8230, 8250, 9010, 9120, 9230, 9250, AFX8010	Unloading Auger Gearbox Standard Unload Rate w/ 24 Spline Output Shaft w/ 16 Tooth Inner Bevel Gear Replaces 84320130, 86523576	AM87331084	\$ 940.00	
	7130, 7230, 7240, 7250, 8250, 8230, 8240, 9230, 9240, 9250	Upper Unloading Auger Gearbox High Capacity Gearbox w/ 24 Spline Output Shaft w/ 16 Tooth Inner Bevel Gear Replaces 47919991, 84262051	AM47941493	\$ 1320.00	
	5088, 5130, 5140, 6088, 6130, 6140, 7010, 7088, 7120, 7130, 7140, 7230, 7240, 8010, 8120, 8230, 8240, 9010, 9120, 9230, 9240, AFX8010	Upper Unloading Auger Gearbox Shaft 15 Tooth, 21 Spline, 6.34" Long	AM87331114	\$ 275.00	
	5088, 5130, 5140, 6088, 6130, 6140, 7010, 7088, 7120, 7130, 7140, 7230, 7240, 8010, 8120, 8230, 8240, 9010, 9120, 9230, 9240, AFX8010	Lower Unloading Auger Gearbox Shaft 8 & 21 Spline, 7.81" Long	AM86623219	\$ 125.74	
	1420, 1440, 1460, 1480, 1620, 1640 BSN JJC0097103, 1660 BSN JJC0102897, 1680 BSN JJC0115352	Upper Unloading Auger Gearbox Gear 18 Tooth (2) Required Replaces 1300283C1, 1309380C1	AM1324929C1	\$ 107.00	
	1640, 1644, 1660, 1666, 1670, 1680, 1682, 1688, 2144, 2166, 2188, 2344, 2366, 2377, 2388	Gear	AM1347260C1	\$ 122.00	
	815, 915	Unloading Vertical Auger Gear Set	AM166063C91	\$ 89.27	

Case IH®—Combine

Unloading Drive Components

Application	Description	Part Number	Retail Price	Core
5088, 5130, 5140, 6088, 6130, 6140, 7010, 7088, 7120, 7130, 7140, 7230, 8010, 8120, 8230, 9010, 9120, 9230, AFX8010	Unloading Auger Drive Hub 21 Tooth Replaces 84073608, 84073843, 86563106	AM87011705	\$ 28.00	
1420, 1440, 1460, 1470, 1480, 1620, 1640, 1660, 1670, 1680	Grain Tank Unloader Drive Sprocket 43 Tooth, 1" ID, 7.13" OD For Size 40 Chain	AM192922C1	\$ 35.00	
1440, 1460, 1470, 1480	Grain Tank Unloader Drive Sprocket 33 Tooth, 1.127" ID, 6.92" OD For Size 50 Chain Replaces 192199C1	AM192199C2	\$ 30.00	
1440, 1470, 1480, 1620, 1640 BSN 97103, 1660 BSN 80540, 1670 BSN 102896	Grain Tank Unloader Drive Sprocket 37 Tooth, 1" ID, 6.21" OD For Size 40 Chain	AM192925C1	\$ 30.00	
1460, 1480, 1482, 1620 ASN JJC0032630, 1640 ASN JJC0034705, 1644, 1660 ASN JJC0038346, 1666, 1670 ASN JJC0080540, 1680 ASN JJC0045689, 2188, 2388 SN HAJ292001-HAJ300000, 2588	Grain Tank Unloader Drive Sprocket 49 Tooth, 1" ID, 8.09" OD For Size 40 Chain	AM187331C1	\$ 40.00	
1620, 1640, 1660, 1670	Grain Tank Unloader Drive Sprocket 33 Tooth, 1.132" & 1.25" ID, 6.92" OD	AM1321167C92	\$ 31.25	
1640 ASN 97103, 1644, 1660 ASN 102897, 1666, 1680 ASN 115352, 1688, 2144, 2166, 2188, 2344, 2366, 2377, 2388	Grain Tank Unloader Drive Sprocket 33 Tooth	AM1347360C1	\$ 61.00	
	Bushing 1.254" ID, 1.408" OD, 0.75" Wide Replaces A58376	AM1347384C1	\$ 10.67	
2388 ASN HAJ300001, 2577, 2588	Chain Drive Double Sprocket 43 & 25 Tooth	AM87525821	\$ 190.00	
2144, 2166, 2188, 2344, 2366, 2377 ASN HAJ0292001, 2388 SN JJC0268800-JJC0270499 & ASN HAJ0292001	Hydraulic Cylinder 1.25" ID, 2.75" Stroke For Unloader Clutch Replaces 112397A2	AM87337242	\$ 225.00	
1640 ASN JJC0097103, 1644, 1660 ASN JJC0038345, 1666, 1680 ASN JJC0115351, 1688, 2144, 2166, 2188, 2344, 2366, 2377, 2388	Grain Tank Unloader Jackshaft Driven Pulley Replaces 1994762C1	AM1994762C2	\$ 78.00	
1640 ASN JJC0097103, 1644, 1660 ASN JJC0102897, 1666, 1680 ASN JJC0115352, 1688, 2144, 2166, 2188, 2344, 2366, 2377, 2388, 2577, 2588	Bearing, Unloader Belt or Chain Drive Replaces 610188R91, 70017774, K3315	AM565673R92	\$ 21.29	
1440, 1470, 1480, 1482, 1620, 1640, 1644, 1660, 1666, 1680, 1682, 1688, 2144, 2166, 2188, 2344, 2366, 2388, 2577, 2588	Unloading Auger Speed Up Sprocket Replaces 1347360C1	AMX29175	\$ 414.00	
5088, 5130, 5140, 5150, 6088, 6130, 6150, 7010, 7088, 7120, 7130, 7140, 7150, 8010, 8120, 9120	Flagship High Speed Sprocket Replaces 84069795	AMX29176	\$ 450.00	
1640 ASN JJC0034705, 1644, 1660 ASN JJC0038346, 1666, 1680 ASN JJC0115352, 1688, 2144, 2166, 2188, 2344, 2366, 2388	Unloader Drive Sprocket, Lower 33 & 57 Tooth, 1.38" Bore	AM1347402C1	\$ 135.00	
7010, 7120, 8010, 8120, 9120, AFX8010	Unloader Drive Sprocket 38 Tooth	AM84069777	\$ 85.54	
5088, 5130, 5140, 6088, 6130, 6140, 7010, 7088, 7120, 7230, 7240, 8010, 8120, 8230, 8240, 9120, 9130, 9240, AFX8010	Unloader Idler Sprocket 15 Tooth	AM86627639	\$ 20.00	
7230, 8230, 9230	Unloading Auger Tensioner Cylinder	AM84300068	\$ 430.00	

Case IH®—Combine

Augers—Grain Tank Bottom

All augers are made with continuous roll-formed flighting for accuracy and durability.

Application	Description	Part Number	Retail Price	Core
1440, 1460, 1470, 1480, 1482, 1640, 1644, 1660, 1666, 1670, 1680, 1682, 1688, 2144, 2166, 2188, 2344, 2366, 2388	Grain Tank Bottom Auger 110 1/8" Overall Length, Left Hand Flighting, 7" Flighting Diameter, 1" Shaft Diameter, 7" Pitch Replaces Both Front and Rear Augers	AM192784C3	\$ 418.00	
	Grain Tank Bottom Auger Extended Wear-Sectional, 110 1/8" Overall Length, Right Hand and Left Hand Flighting, 7" Flighting Diameter, Shaft Diameter - 0.859" and 1", 7" Pitch	AM390556A1	\$ 562.00	
	Bearing	NPS100RPC	\$ 7.00	
5088, 5130, 5140, 5150, 6088, 6130, 6140, 6150, 7088, 7130, 7140, 7150	Grain Tank Bottom Auger, Rear Replaces 87280347	AM84075322	\$ 575.00	
	Bearing - Cover End	AMJD10384	\$ 22.00	
7010, 7120, 7230, 7240, 7250, 8010, 8120, 8230, 8240, 8250, 9010, 9120, 9230, 9240, 9250 - Extended Wear	Grain Tank Bottom Auger, Front Extended Wear, 120 3/4" Overall Length, Right Hand Flighting, 8 1/4" Flighting Diameter, Shaft Diameter - 2" and 1.18", 9 3/8" Pitch Replaces 84075319	AM87280345	\$ 395.00	
	Bearing - Cover End	AMJD10384	\$ 22.00	
(7010, 7120, 8010, 8120, 9010, 9120, AFX8010 - Extended Wear), (7230, 8230, 9230 - Extended Wear and Extended Wear High Capacity both w/ Non-Common Cab 03/2012-01/13), (7240, 7250, 8240, 8250, 9240, 9250 - Extended Wear High Capacity)	Grain Tank Bottom Auger, Rear Extended Wear, 120 3/4" Overall Length, Right Hand Flighting, 8 1/4" Flighting Diameter, Shaft Diameter - 2" and 1.18", 9 3/8" Pitch Replaces 84075320	AM87280343	\$ 514.00	
	Bearing - Cover End	AMJD10384	\$ 22.00	
7230, 7240, 7250, 8230, 8240, 8250, 9230, 9240, 9250	Grain Tank Bottom Auger, Front Extended Wear, High Capacity, 122 3/8" Overall Length, Left Hand Flighting, 9 1/2" Flighting Diameter, Shaft Diameter - 1 3/8" and 1 1/2", 10" Pitch Replaces 84348185	AM84368833	\$ 889.00	
	Grain Tank Bottom Auger, Rear Extended Wear, High Capacity, 122 3/8" Overall Length, Right Hand Flighting, 9 1/2" Flighting Diameter, Shaft Diameter - 1 3/8" and 1 1/2", 10" Pitch Replaces 84348188	AM84368835	\$ 966.00	
	Bearing - Cover End	HC207-22	\$ 24.00	

Straw Spreader Shafts and Components

Application	Description	Part Number	Retail Price	Core
1420, 1440, 1460, 1470, 1480, 1482, 1640, 1644, 1660, 1666, 1670, 1680, 1688	Straw Spreader Shaft, Vertical 10.625" Long, 0.875" Hex	AM192240C1	\$ 33.74	
	Bearing, Metal	AM195293C91	\$ 7.00	
1480, 1482, 1680, 1682, 1688, 2188, 2388	Straw Spreader Shaft, Horizontal 58.00" Long, 0.875" Hex	AM192241C4	\$ 119.28	
1440, 1460, 1470, 1640, 1644, 1660, 1666, 1670, 2144, 2166, 2344, 2366	Straw Spreader Shaft, Horizontal 47.50" Long, 0.875" Hex	AM192242C4	\$ 90.00	
1644, 1666, 1688, 2144, 2166, 2188, 2344, 2366, 2377, 2388, 2577, 2588	Straw Spreader Shaft 12" Long	AM128440A1	\$ 45.00	
1688, 2144, 2166, 2188, 2344, 2366, 2388, 2577, 2588	Straw Spreader Shaft 12" Long Replaces 109485A1	AM84224477	\$ 38.00	
2377, 2388 ASN JJC0270500, 2577, 2588	Straw Spreader Shaft 0.875" Diameter, 57.50" Long	AM427270A1	\$ 70.00	
5088, 6088, 7088	Straw Spreader Shaft	AM84163923	\$ 48.00	

Case IH®—Combine

Application	Description	Part Number	Retail Price	Core
5088, 5130, 5140, 6088, 6130, 6140, 7088, 7130, 7140	Bevel Gear For Straw Spreader Drive, Powershift	AM84467465	\$ 41.00	
(2577, 2588 - w/ Straw and Chaff Spreaders)	Cleaning Shoe Door Shield	AM87381635	\$ 170.01	
5088, 5130, 5140, 6088, 6130, 6140, 7088, 7130, 7140 - w/ Straw Spreader	Side Curtain	AM87478159	\$ 99.87	
5088, 5130, 5140, 6088, 6130, 6140, 7088, 7130, 7140 - w/ Straw and Chaff Spreader	Cleaning Shoe Door Shield	AM87684740	\$ 170.01	
7010, 7120, 7130, 7230, 7240, 8010, 8120, 8230, 8240, 9120, 9230, 9240	Rubber Curtain Replaces 84384419	AM87752499	\$ 113.16	
1688, 2188, 2377, 2388, 2577, 2588, 5088, 5130, (5140, 6140, 7140 - Prior to 11/2015), 6088, 6130, 7088, 7130, 7230, 8230, 9230	Straw Spreader Blade, Right Hand Curved Replaces 371055A1, 87324976	AM87726624	\$ 36.00	
1688, 2188, 2377, 2388, 2577, 2588, 5088, 5130, (5140, 6140, 7140 - Prior to 11/2015), 6088, 6130, 7088, 7130	Straw Spreader Blade, Left Hand Curved Replaces 371056A1, 87324975	AM87726623	\$ 35.00	
7230, 7240, 7250, 8230, 8240, 8250, 9230, 9240, 9250	Straw Spreader Spider, Right Hand 2.49" ID	AM84132360	\$ 120.00	
	Straw Spreader Spider, Left Hand 2.49" ID	AM84132358	\$ 120.00	
7230, 7240, 7250, 8230, 8240, 8250, 9230, 9240, 9250	Straw Spreader Paddle, Right Hand 12.30" Long, 9.72" Wide	AM87541487	\$ 85.00	
	Straw Spreader Paddle, Left Hand 12.30" Long, 9.72" Wide	AM87541485	\$ 99.00	
2377, 2388, 2577, 2588	Straw Spreader Rubber Guard Hardware Not Included	AM140277A1	\$ 45.90	
1440, 1460, 1480, 1640, 1644, 1660, 1666, 1680, 1688, 2144, 2166, 2188, 2344, 2366, 2377, 2388, 2577 - w/ Straw Spreader	Spreader Side Shield	AM1308916C2	\$ 39.24	
2144, 2166, 2188, 2344, 2366, 2377, 2388 - w/ Straw and Chaff Spreader	Spreader Side Shield Replaces 103211A1	AM103211A2	\$ 49.94	
1420, 1440 ASN 20976, 1460 ASN 24300, 1480 ASN 24000, 1620, 1640, 1644, 1660, 1666, 1680, 1688, 2144, 2166, 2188, 2344 BSN JJC0174399, 2366 BSN JJC0252399, 2388 BSN JJC0270499	Driven Pulley, Straw Spreader 10" OD Replaces 108533A1, 181196C1	AM181196C2	\$ 146.10	
1644, 1660, 1666, 1680, 1688, 2144, 2166, 2188, 2344, 2366, 2377, 2388, 2577, 2588	Drive Pulley For Straw Spreader and Shaker Shaft	AM566516R92	\$ 74.00	
1420, 1440, 1460, 1470, 1480, 1482, 1620, 1640, 1644, 1660, 1666, 1670, 1680, 1682, 1688, 2144, 2166, 2188, 2366, 2388	Idler Pulley 1" Wide, 4.375" OD, 0.50" Hole Diameter Replaces 428848A1, 1315269C1	AM1315269C2	\$ 34.84	
1420, 1440, 1460, 1480, 1620, 1640, 1644, 1660, 1666, 1680, 1688, 2144, 2166, 2188, 2344, 2366, 2377, 2388, 2588, 5088, 5130, (5140, 6140, 7140 - Prior to 10/2015), 6088, 6130, 7088, 7130, (7230, 8230, 9230 - w/ Common Cab), 7240, 7250, 8240, 8250, 9240, 9250	Straw Spreader Cone Replaces 1882218C1, 188218C5, 188218C6	AM47442301	\$ 101.00	
1666, 1688, 2166, 2188, 2366, 2377, 2388, 2577, 2588, 5088, 5130, (5140, 6140, 7140 Prior to 10/2015), 6088, 6130, 7088, 7130, 7230, 7240, 7250, 8230, 8240, 8250, 9230, 9240, 9250	Straw Spreader Disc 35.50" OD, Aluminum For Straw or Chaff Spreader	AM140189A1	\$ 226.00	
7010, 7120, 8010, 8120, 9010, 9120, AFX8010	Finger Bar, Long	AM87282590	\$ 105.00	
	Finger Bar, Short	AM87282592	\$ 135.00	

Case IH®—Combine

Auger Extension Kits

These kits extend the length of your unloading auger approximately three feet and increase your clearance for larger platforms and grain carts. Includes spring-loaded grain saver.



Application	Description	Part Number	Retail Price	Core
1420, 1440, 1460, 1480, 1620, 1640, 1644, 1660, 1666, 1680, 1688, 2144, 2166, 2188, 2344, 2366, 2388	Unloading Auger Extension Kit, 3' For Combines using AMI's Unloading Auger w/ 3 1/2" Tube	AMCIH3EXT	\$ 862.00	
	Replacement Parts:			
	Auger Flighting, 3 1/2" Tubing	AMX27501	\$ 84.00	
	Auger Flighting, 3" Tubing	AMX27502	\$ 79.00	
	Support Sleeve	AMX27184	\$ 175.00	
	Poly Snout, For CIH Extenders	AMCIHEXT-PS	\$ 106.00	
	Grain Saver Door	AMX27235	\$ 330.00	
5130, 5140, 5150, 6130, 6140, 6150, 7010, 7120, 7130, 7140, 7150, 7230, 8010, 8120, 8230, 9010, 9120, 9230, AFX8010	Unloading Auger Extension Kit, 3' 3' Extender Extended Wear Auger Tube and Auger Extension Includes Hardware	AM87471943	\$ 1600.00	
	Replacement Parts:			
	Horizontal Unloading Auger Tube	AM87470153	\$ 890.00	
	Horizontal Unloading Auger Extension	AM87657822	\$ 846.40	
5088, 6088, 7010, 7088, 7120, 8010, 8120, 9120, AFX8010	Unloading Auger Extension Kit	AMNH3EXT	\$ 1836.00	
5088, 6088, 7088, 7120, 8120, 9120 - w/ Red Unloading Tube	Unloading Auger Extension Kit 3' Extender w/ Spout	AMNH3EXT-R	\$ 1800.00	
1644, 1660, 1666, 1680, 1688, 2144, 2166, 2188, 2344, 2366, 2388, 2588	Horizontal Unloading Auger - Rear Extended Wear, 147 1/2" Overall Length, Right Hand Flighting, 11 1/2" Flighting Diameter, Shaft Diameter - 1" and 1" Hex Bore, 11 3/4" Pitch Note: 1-Piece Extender Setup extends Unloading Auger to 236", Tube and Auger must be used together	AM199023A2-3	\$ 810.00	
	Horizontal Unloading Auger Outer Tube	AM1317899C3-3	\$ 695.00	
5088, 6088, 7088, 7120, 8120, 9120	Grain Saver Door	AM84131732	\$ 109.74	
1420, 1440, 1460, 1480, 1620, 1640, 1644, 1660, 1666, 1680, 1688, 2144, 2166, 2188, 2344, 2366, 2388	Spring Kit, Grain Saver Door	AMX29019	\$ 50.00	

Auger Tube Donuts

Application	Description	Part Number	Retail Price	Core
2366, (2377, 2388 SN HAJ292001-HAJ300000), 2577, 2588	Splined Coupling (Donut)	AM198994A1	\$ 32.73	

Grain Tank Components

Application	Description	Part Number	Retail Price	Core
5088, 5130, 5140, 5150, 6088, 6130, 6140, 6150, 7088, 7130, 7140, 7150	Grain Bin Power Fold Actuator	AM84181862	\$ 935.00	

Case IH®—Combine

Grain Tank Auger Floor Liners

Application	Description	Part Number	Retail Price	Core
1420, 1440, 1460, 1480, 1640, 1660, 1666, 1680, 1688, 2144, 2166, 2188, 2344, 2366, 2388, 2588 BSN JJC0270499	Grain Tank Auger Floor Liner Kit	AMX27138	\$ 403.00	
1440, 1460, 1480, 1640, 1644, 1660, 1666, 1680, 1688, 2144, 2166, 2188, 2344, 2366, 2377, 2388, 2577, 2588	Grain Tank Auger Floor Liner Kit Stainless Steel, Includes Hardware	AM87561634	\$ 622.00	
5088, 6088, 7088, 5130, 6130, 7130	Grain Tank Auger Floor Liner Kit	AMX27428	\$ 423.00	
7010, 8010, 7120, 8120, 9120	Grain Tank Auger Floor Liner Kit	AMX27427	\$ 448.00	
	Grain Tank Auger Floor Liner Kit Oversized Liners Includes Stainless Steel Panels for both Grain Tank Auger Troughs, Rivets and Installation Instructions	AMX29168	\$ 2110.00	
7130, 7230, 7240, 7250, 8230, 8240, 8250, 9230, 9240, 9250	Grain Tank Auger Floor Liner Kit High Capacity Unload System Includes Stainless Steel Panels for both Grain Tank Auger Troughs, Rivets and Installation Instructions Replaces 84478565	AM84529552	\$ 525.00	
7230, 9230	Grain Tank Auger Floor Liner Kit	AMX27429	\$ 403.25	
7010, 7120, 7230, 7240, 8010, 8120, 8230, 8240, 9010, 9120, 9230, 9240, AFX8010	Grain Tank Auger Floor Liner Includes Stainless Steel Panels for both Grain Tank Auger Troughs, Rivets and Installation Instructions Replaces 87315123, 87662994	AM87662984	\$ 765.00	



Chaffers—Short Finger Top

Adjustable short finger chaffers with 1 1/8" wire spacing. For use in cereal and fine seed crops. Our presieves feature 1 1/8" wire spacing.

Application	Description	Part Number	Retail Price	Core
915 ASN 3180, 1440, 1460, 1470, 1640, 1660	Short Finger Top Chaffer	45.00" x 61.88" AM1330684C2	\$ 625.00	
915 ASN 3180, 1440, 1460, 1640, 1660	Short Finger Top Chaffer Wide Spaced - 1.625"	45.00" x 61.88" AM1330685C1	\$ 1222.78	
1480, 1482, 1680, 1682	Short Finger Top Chaffer, Short Shoe	60.00" x 61.88" AM1330687C3	\$ 775.00	
1480, 1680	Short Finger Top Chaffer, Short Shoe Wide Spaced - 1.625"	60.00" x 61.88" AM1330688C3	\$ 1359.52	
1644, 1666, 2144, 2166, 2344, 2366	Short Finger Top Chaffer, Long Shoe	45.00" x 74.88" AM1957316C6	\$ 875.00	
	Short Finger Top Chaffer, Long Shoe Wide Spaced - 1.625"	45.00" x 74.88" AM1957315C8	\$ 1664.16	
1680, 1682, 1688, 2188, 2388, 2588, 5088, 6088, 7088 Replaces 1322467C1, 1322467C6, 87710708	Short Finger Top Chaffer, Long Shoe	60.00" x 74.88" AM1322467C5	\$ 1015.00	
1680, 1688, 2188, 2388, 2588	Short Finger Top Chaffer, Long Shoe Wide Spaced - 1.625"	60.00" x 74.88" AM1322673C5	\$ 1148.00	
7010, 7120	Short Finger Top Chaffer Closed Slat (1) Required	59.125" x 51.75" AM87109836	\$ 780.00	
7240 (Prior to MY18), 8010, 8120, 8230, 8240, 9010, 9120, 9230 w/ Common Cab, 9240, AFX8010	Short Finger Top Chaffer Closed Slat, 1 1/8" Spacing (2) Required	56.813" x 30.938" AM87109830	\$ 495.00	
7230, (7240, 8240, 9240 - Prior to MY18), 8010, 8120, 8230, 9010, 9120, 9230, AFX8010	Short Finger Top Chaffer Closed Slat, 1 5/8" Spacing Double Handle, Manual Adjust (2) Required	56.813" x 30.938" AM87109838	\$ 465.00	
7230, (7240, 8240, 9240 - Prior to MY18), 8010, 8120, 8230, 9010, 9120, 9230, AFX8010	Short Finger Chaffer Precleaner 1 1/8" Spacing Replaces 84084942	29.878" x 61.938" AM87109817	\$ 428.00	

Case IH®—Combine

Application	Description	Part Number	Retail Price	Core
(2377, 2388 SN HAJ292001-HAJ300000), 2577, 2588	Lever Assembly Includes Bar Assembly, Shaft and Bushing Replaces 87671725	AM87313325	\$ 98.00	
7120, 7230, 7240, 8120, 8230, 8240, 9120, 9230, 9240	Chaffer Actuator Replaces 47421232	AM84208481	\$ 450.00	

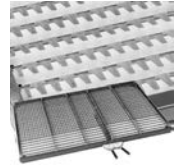

Chaffers—Long Finger Top

Adjustable long finger chaffers with 1 5/8" wire spacing. For use in large seed crops such as corn and beans. Our Presieves feature 1 1/8" or 1 5/8" wire spacing.

Application	Description	Part Number	Retail Price	Core
815 ASN 4689, 1420, 1620	Long Finger Top Chaffer	35.80" x 61.88" AM1330681C2	\$ 951.35	
915 ASN 3180, 1440, 1460, 1470, 1640, 1660	Long Finger Top Chaffer	45.00" x 61.88" AM1330686C1	\$ 561.00	
1480, 1482, 1680, 1682	Long Finger Top Chaffer, Short Shoe	60.00" x 61.88" AM1330689C3	\$ 791.00	
1644, 1666, 2144, 2166, 2344, 2366	Long Finger Top Chaffer, Long Shoe	45.00" x 74.88" AM1957314C7	\$ 729.00	
1680, 1682, 1688, 2188, 2388, 2588, 5088, 6088, 7088	Long Finger Top Chaffer, Long Shoe	60.00" x 74.88" AM1322659C5	\$ 1122.00	
7230, (7240, 8240, 9240 - Prior to MY18), 8010, 8120, 8230, 9010, 9120, 9230, AFX8010	Long Finger Top Chaffer 1 5/8" Spacing (2) Required	56.813" x 30.938" AM87109834	\$ 459.00	
7120, 7230, 7240, 7250, 8010, 8120, 8230, 8240, 8250, 9010, 9120, 9230, 9240, 9250, AFX8010	Long Finger Chaffer Precleaner 1 5/8" Spacing (2) Required Replaces 84083981, 87042470, 87105820	29.878" x 61.938" AM87109826	\$ 454.00	
7120, 7230, 7240, 8120, 8230, 8240, 9120, 9230, 9240	Chaffer Actuator Replaces 47421232	AM84208481	\$ 450.00	



Chaffers—Adjustable Air Foil Top

Application	Description	Part Number	Retail Price	Core
1440, 1460, 1470, 1640, 1660	Adjustable Air Foil Top Chaffer	45.00" x 61.88" AM1319092C4	\$ 1780.07	
1644, 1666, 2144, 2166, 2344, 2366	Adjustable Air Foil Top Chaffer, Long Shoe	45.00" x 74.88" AM1970516C8	\$ 1981.23	
1680, 1682, 1688, 2188, 2388, 2588, 5130, 6130, 7130	Adjustable Air Foil Top Chaffer, Long Shoe Replaces 87710707	60.00" x 74.88" AM1347372C7	\$ 2515.00	
7230, 8010, 8120, 8230, 9010, 9120, 9230, AFX8010	Adjustable Air Foil Top Chaffer Galvanized Double Handle, Manual Adjust (2) Required	56.813" x 30.94" AM87109842	\$ 1393.04	
7120, 7230, 7240, 8120, 8230, 8240, 9120, 9230, 9240	Chaffer Actuator Replaces 47421232	AM84208481	\$ 450.00	

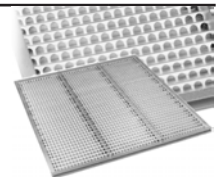

Chaffers—Rigid Air Foil

Rigid air foil chaffers are made of galvanized material. Dividers are included for even distribution and extra strength. These chaffers are preset for maximum performance at normal conditions.

Application	Description	Part Number	Retail Price	Core
915 ASN 3180, 1440, 1460, 1470, 1640, 1660	Rigid Air Foil Chaffer	45.00" x 61.88" AMB91515	\$ 807.69	
1480, 1482, 1680, 1682	Rigid Air Foil Chaffer, Short Shoe	60.00" x 61.88" AMB91516	\$ 1138.46	
1680, 1682, 1688, 2188, 2388	Rigid Air Foil Chaffer, Long Shoe	60.00" x 74.88" AMB91517	\$ 1463.00	

Case IH®—Combine

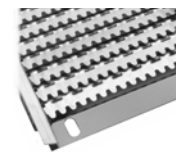

Sieves—Lower

Adjustable, blunt finger sieves with 1 1/8" wire spacing. For use in cereal and fine seed grains.

Application	Description	Part Number	Retail Price	Core
815 ASN 4689, 1420, 1620	Blunt Finger Bottom Sieve	36.00" x 51.50" AM1346913C2	\$ 600.00	
915 ASN 3180, 1440, 1460, 1470, 1640, 1660	Blunt Finger Bottom Sieve	45.75" x 51.50" AM1346914C2	\$ 500.00	
1480, 1482, 1680, 1682	Blunt Finger Bottom Sieve, Short Shoe	60.75" x 51.50" AM1346915C3	\$ 710.00	
1644, 1666, 2144, 2166, 2344, 2366	Blunt Finger Bottom Sieve, Long Shoe	45.75" x 65.00" AM1325323C5	\$ 638.00	
1680, 1682, 1688, 2188, 2388, 2588, 5088, 6088, 7088	Blunt Finger Bottom Sieve, Long Shoe	60.75" x 65.00" AM1322464C6	\$ 893.00	
7010, 7120	Short Finger Bottom Sieve Galvanized, Closed Slat, 1 5/8" Spacing (1) Required Replaces 86999992	59.125" x 51.75" AM87109848	\$ 663.00	
7010, 7120 BSN YAG209977	Short Finger Bottom Sieve Galvanized, 1 1/8" Spacing (1) Required Replaces 84319322	59.125" x 51.75" AM87109844	\$ 675.00	
(7230, 8230, 9230 - w/ Common Cab), 8010, 8120, 9010, 9120, AFX8010	Short Finger Bottom Sieve 1 1/8" Spacing (2) Required	56.813" x 30.938" AM87109846	\$ 495.00	
7120, 7230, (7240, 8240, 9240 - Prior to MY18), 8010, 8120, 8230, 9010, 9120, 9230, AFX8010	Long Finger Bottom Sieve Galvanized, 1 5/8" Spacing (2) Required Replaces 84400473	56.813" x 30.938" AM87109850	\$ 479.00	
5088, 5130, 5140, 6088, 6130, 6140, 7010, 7088, 7120, 7130, 7140, 7230, 8010, 8120, 8230, 9010, 9120, 9230, AFX8010	Sieve Adjuster Replaces 87011813, 87378807, 87387458	AM84335407	\$ 745.00	

Chaffer and Sieve Frames and Components



Application	Description	Part Number	Retail Price	Core
1420, 1440, 1460, 1470, 1620, 1640, 1660, 1670	Chaffer Shoe Frame Rail, Short Shoe	Right Hand	AM1979203C1	\$ 315.91
		Left Hand	AM1979202C1	\$ 390.68
1480, 1680, 1682	Chaffer Shoe Frame Rail, Short Shoe	Right Hand	AM1979199C1	\$ 315.00
		Left Hand	AM1979198C1	\$ 315.00
1640, 1644, 1660 ASN JJC0038346, 1666, 2144, 2166, 2344, 2366	Chaffer Shoe Frame Rail, Long Shoe	Right Hand	AM1979207C1	\$ 390.97
		Left Hand	AM1979206C1	\$ 386.65
1680 ASN JJC0047412, 1688, 2188, 2388, 2588	Chaffer Shoe Frame Rail, Long Shoe	Right Hand	AM1322453C2	\$ 388.00
		Left Hand	AM1322452C2	\$ 388.00
8010, 8120, 9120, AFX8010	Chaffer Shoe Frame, Upper, Wide Replaces 84462369	AM87491650	\$ 2507.69	
1440, 1460, 1470, 1480, 1482, 1640, 1644, 1660, 1666, 1670, 1680, 1682, 1688, 2144, 2166, 2188, 2344, 2366, 2377 SN HAJ292001-HAJ300000, 2388, 2577, 2588	Chaffer Front Hanger Support Replaces 87602594, 186651C91, 347907A1	AM87741795	\$ 230.00	
1640, 1644, 1660 ASN JJC0038346, 1666, 1670 ASN JJC0080540, 1680 ASN JJC0045689, 1682, 1688, 2144, 2166, 2188, 2344, 2366, 2377, 2388, 2577, 2588, 5088, 5130, 5140, 6088, 6130, 6140, 7088, 7130, 7140	Chaffer Shoe Arm	AM87672100	\$ 122.73	
1420, 1440, 1460, 1470, 1480, 1620, 1640, 1660, 1670, 1680, 1682	Sieve Shoe Frame Rail, Short Shoe	Right Hand	AM1302071C4	\$ 163.00
		Left Hand	AM1302070C4	\$ 169.23
1640, 1644, 1660 ASN JJC0038346, 1666, 1680 ASN JJC0047412, 1688, 2144, 2166, 2188, 2344, 2366, 2388	Sieve Shoe Frame Rail, Long Shoe	Right Hand	AM1979901C5	\$ 360.00
		Left Hand	AM1979900C5	\$ 360.00

Case IH®—Combine

Application	Description	Part Number	Retail Price	Core
2144, 2166, 2188, 2344, 2366, 2377, 2388, 2577, 2588, 7088	Seal, Sieve Frame 70 1/2" Long Replaces 47924947	AM198925A1	\$ 22.59	
1480, 1482, 1680, 1682	Shoe Return Pan, Short Shoe Replaces 191941C1	AM1319209C1	\$ 648.01	
1680 ASN JJC0045689, 1688, 2188, 2377 SN HAJ292001-HAJ300000, 2388, 2577, 2588	Shoe Return Pan, Long Shoe Replaces 87376644	AM1322461C1	\$ 549.45	
7010, 8010, 9010	Shaker Shoe Replaces 82034883, 84393491	AM87557503	\$ 1827.51	
1640, 1644, 1660 ASN JJC0038346, 1666, 1670 ASN JJC0080540, 1680 ASN JJC0045689, 1682, 1688, 2144, 2166, 2188, 2344, 2366, 2377, 2388, 2577, 2588, 5088, 5130, 5140, 6088, 6130, 6140, 7088, 7130, 7140	Hanger Arm Assembly, Front Chaffer Replaces 1957450C1	AM87671723	\$ 108.92	
2388, 2577, 2588, 5088, 5130, 5140, 6088, 6130, 6140, 7088, 7130, 7140	Hanger Arm Assembly, Rear Chaffer Replaces 1957451C1, 1957455A1	AM87671724	\$ 120.00	
1640, 1644, 1660, 1666, 1670, 1680, 1682, 1688, 2166, 2188, 2344, 2366, 2388	Hanger Arm Shaft	AM1979251C1	\$ 45.00	
1644, 1660 ASN JJC0038346, 1666, 2144, 2166, 2344, 2366 - w/ Straw Spreader	Rubber Seal	AM1346999C1	\$ 37.62	
1688, 2188, 2377, 2388, 2577, 2588 - w/ Straw and Chaff Spreader	Rubber Seal	AM124004A2	\$ 64.20	
2144, 2166, 2344, 2366 - w/ Straw and Chaff Spreader	Rubber Seal	AM124558A2	\$ 71.33	
2188, 2377, 2388, 2577, 2588 - w/ Straw Chopper	Rubber Seal	AM1979332C4	\$ 41.61	
1640, 1644, 1660 ASN JJ0038346, 1666, 1680 ASN JJ0045689, 2144, 2166, 2188, 2344, 2366, 2388, 2577, 2588, 5088, 5130, 5140, 5150, 6088, 6130, 6140, 6150, 7088, 7130, 7140, 7150	Sealing Strip (2) Required	AM1325331C1	\$ 29.00	
7010, 7120, 7230, 7240, 8010, 8120, 8230, 8240, 9010, 9120, 9230, 9240, AFX8010	Shaker Shoe Arm, Upper	AM87314041	\$ 168.51	
7010, 7120, 7230, 7240, 8010, 8120, 8230, 8240, 9010, 9120, 9230, 9240	Shaker Shoe Arm, Lower	AM87562561	\$ 88.01	
7120, 7230, 7240, 8010, 8120, 8230, 8240, 9010, 9120, 9230, 9240, AFX8010	Shaker Shoe Drive Arm	AM87317702	\$ 232.41	
7010, 7120, 8010, 8120, 9120, AFX8010	Shaker Shoe Drive Shaft 80.31" Long	AM86980613	\$ 567.49	
1640 ASN JJC0097189, 1644, 1660 ASN JJC0039549, 1666, 2144, 2166, 2344, 2366	Shaker Shaft 59.19" Long Replaces 1970192C1	AM1970192C2	\$ 235.00	
1640 ASN JJC0097189 w/ Heavy Duty Drive, 1644, 1660 ASN JJC0039549 w/ Heavy Duty Drive, 1666, 1670 ASN JJC0080539, 1680 ASN JJC0045688, 1688, 2144, 2166, 2188, 2344, 2366, 2377, 2388, 2577, 2588	Shaker Shaft Cam Left Hand	AM1322573C1	\$ 145.93	
7010, 7120, 7230, 7240, 8010, 8120, 8230, 8240, 9010, 9120, 9230, 9240, AFX8010	Bearing Housing, Upper Shoe Drive Replaces 80442901, 84032313, 84097461	AM84446877	\$ 11.44	
7010, 7120, 8010, 8120, 9120, AFX8010	Bearing Housing Half, Shaker Shoe Replaces 80320033	AM320033	\$ 12.00	
1440, 1460, 1470, 1480, 1482, 1640, 1644, 1660, 1670, 1680, 1682	Bushing, Hanger Arm Drive 0.63" ID Replaces B94623, B512078	AM186597C1	\$ 23.00	
1420, 1480, 1620, 1640, 1660 BSN JJC0039550, 1680 Standard Shoe	Hanger Arm Bushing, Shoe Hanger Arm	AM627555R91	\$ 9.00	
1640, 1644, 1660 ASN JJC0038346, 1670, 1680 ASN JJC0045689, 1682, 1688, 2144, 2166, 2188, 2344, 2366, (2377, 2388 SN HAJ292001-HAJ300000), 2577, 2588, 5088, 5130, 5140, 6088, 6130, 6140, 7088, 7130, 7140	Bushing, Chaffer 2.87" Long, 0.633" ID, 1.50" OD Replaces 87538599	AM1330323C2	\$ 32.00	

Case IH®—Combine

Application	Description	Part Number	Retail Price	Core
2577, 2588, 5088, 6088, 7088	Sieve Bushing Kit Includes (2) Shaker Shaft/Chaffer Drive Arm Bushings, (8) Sieve/Drive Hanger Bushings and (10) Rubber Bushings	AM87299946	\$ 457.51	
7230, 8230, 9230	Roller, Cleaning Shoe Pivot Frame Self-Leveling Replaces 89504221	AM434817	\$ 25.92	
5140, 6140, 7140, 7230, 7240, 8230, 8240, 9230, 9240	Rubber Bushing, Upper Shaker Shoe Drive Replaces 442446, 80442446	AM84459072	\$ 39.19	
7010, 7120, 8010, 8120, 9120, AFX8010	Rubber Bushing, Shaker Shoe Replaces 190068, 398810	AM84000052	\$ 4.76	
	Bushing, Upper Shaker Shoe 0.64" ID, 2.05" Long	AM84052651	\$ 6.01	
	Bushing, Upper Shaker Shoe Replaces 80338222	AM338222	\$ 4.03	
7010, 7120, 7230, 7240, 8010, 8120, 8230, 8240, 9010, 9120, 9230, 9240, AFX8010	Bushing, Upper Shoe Arm Replaces 84097509, 84320630, 89811082	AM9811082	\$ 76.26	
1640, 1644, 1660, 1666, 1680, 1688, 2144, 2166, 2188, 2344, 2366, 2377 ASN HAJ292001-HAJ300000, 2388, 2577, 2588, 5088, 5130, 5140, 6088, 6130, 6140, 7088, 7130, 7140	Bushing, Shaker Shaft Drive Arm 0.633" ID Replaces 1979383C1	AM87376924	\$ 53.00	
815, 915, 1420, 1440, 1460, 1470, 1480, 1620, 1640, 1644, 1660, 1666, 1670, 1680, 1682, 1688, 2144, 2166, 2188, 2344, 2366, 2377, 2388, 2577, 2588, 5088, 6088, 7088	Finger, Auger Bed	AM175114C1	\$ 4.00	
1420, 1440, 1460, 1470, 1480, 1482, 1620, 1640, 1644, 1660, 1666, 1670, 1680, 1682, 1688, 2144, 2166, 2188, 2344, 2366, 2377, 2388, 2577, 2588, 5088, 5130, 6088, 6130, 7088, 7130	Ratchet/Clutch	AMB12170	\$ 9.50	
1480, 1680, 1688, 2188, (2377, 2388 SN HAJ292001-HAJ300000), 2577, 2588	Front Seal Support Plate Replaces 192065C1	AM87378753	\$ 77.88	
1480, 1680, 1688, 2188, 2377, 2388	Chaffer Pan Support Replaces 192045C1	AM87379129	\$ 63.00	
1640, 1644, 1660, 1666, 2144, 2166, 2344, 2366	Chaffer Pan Support	AM1312156C1	\$ 139.02	
1680 ASN JJC0045689, 1688, 2188, 2377 SN HAJ292001-HAJ300000, 2388, 2577, 2588	Chaffer Pan Support, Long Shoe Replaces 1312969C1	AM87379150	\$ 78.00	
7010, 7120, 7230, 7240, 8010, 8120, 8230, 8240, 9010, 9120, 9230, 9240, AFX8010	Upper Shoe Drive Support Middle Pivot Plate	Right Hand AM84320472 Left Hand AM84320470	\$ 159.79 \$ 132.78	
5088, 5130, 5140, 6088, 6130, 6140, 7088, 7130, 7140	Curtain, Upper Sieve 1565 mm Long	AM87732448	\$ 74.90	
1644, 1660 ASN JJC0039549 w/o Extended Length Cleaning System or ASN JJC0038346 w/ Extended Length Cleaning System, 1666, 1670 ASN JJC0080539, 1680 ASN JJC047024 w/ Heavy Duty Drive or ASN JJC0047411 w/ Long Chaffer Cleaning System, 2144, 2166, 2188, 2344, 2366, 2377, 2388 BSN JJC0276540, (2577, 2588 BSN HAJ303741)	Rubber Bushing, Lower Sieve Front Hanger Replaces 564103R91	AM1330324C1	\$ 15.84	
2144, 2166	Rubber Bushing, Top Chaffer Rear Hanger Replaces 564103R91	AM1330324C1	\$ 15.84	
1644, 1660 ASN JJC0039549 w/ Extended Length Cleaning System, 1666, 1680 ASN JJC047024 w/ Heavy Duty Chaffer Drive or ASN JJC0047411 w/ Long Chaffer Cleaning System, 1688, 2188, 2344, 2366, 2377, 2388, (2577, 2588 BSN HAJ303741)	Rubber Bushing, Top Chaffer Front Hanger Replaces 564103R91	AM1330324C1	\$ 15.84	
1640 BSN JJC0034705 & ASN JJC0035369, 1660 BSN JJC0038346 & ASN JJC0040382, 1680 ASN JJC0047877	Rubber Bushing, Steering Axle Shield Support Replaces 564103R91	AM1330324C1	\$ 15.84	

Case IH®—Combine

Application	Description	Part Number	Retail Price	Core
1420, (1440, 1460 BSN 001501), 1480, 1620, 1640, 1660 BSN JJC0039550, 1680 Standard Shoe	Hanger Arm Bushing, Chaffer Hanger Arm	AM627555R91	\$ 9.00	

Grain Pans and Components

Our grain pans are built heavier than OEM and have galvanized pans to prevent rusting. Ripple pans may be ordered separately. Replaceable front sections are available.



Application	Description	Part Number	Retail Price	Core
1440, 1460, 1640, 1644, 1660, 1666, 2144, 2166, 2344, 2366	Grain Pan	AM192056C1	\$ 155.56	
1480, 1680, 1688, 2188, 2388	Grain Pan	AM192057C1	\$ 170.00	
1680 ASN JJC0045689, 1688, 2188, 2377, 2388, 2577, 2588, 5088, 5130, 5140, 6088, 6130, 6140, 7088, 7130, 7140, 9230	Sieve Finger Cover	AM1994858C1	\$ 31.90	
7010, 7120, 7240, 7250, 8010, 8120, 8240, 8250, 9120, 9240, 9250	Grain Pan Canvas Seal Replaces 87376933	AM87376934	\$ 27.00	
7010, 7120, 8010, 8120, 9010, 9120, AFX8010	Grain Pan Canvas Seal	AM87391543	\$ 26.16	

Straw Walkers and Parts



Application	Description	Part Number	Retail Price	Core
915	Straw Walker Wood Bearing Block Set Complete set includes upper bearing half, lower bearing half and bolts	AM166067C91	\$ 55.46	

Straw Choppers

Assembly includes rotor, side sheets, knife bank, flanges, hardware and 3-groove pulley unless otherwise noted. Original pulley must be returned to receive core credit.



Application	Description	Part Number	Retail Price	Core
1440 ASN 20977, 1460 ASN 23401, 1640, 1644, 1660, 1666, 2144, 2166, 2344, 2366 - w/o existing Straw Choppers	Straw Chopper Assembly w/ Drive	AMCIHD60	\$ 5300.00	\$ 150.00
1480 ASN 24001, 1680 - w/o existing Straw Choppers	Straw Chopper Assembly w/ Drive	AMCIHD80	\$ 5559.00	\$ 150.00
1688, 2188, 2388 BSN JJC0270499 - w/o existing Straw Choppers	Straw Chopper Assembly w/ Drive	AMCIHD88	\$ 5450.00	\$ 150.00
2377, 2388 ASN 292001, 2577 ASN 292001, 2588 - w/o existing Straw Choppers	Straw Chopper Assembly w/ Drive Includes 2 Speed Drive Kit 5-Groove Pulley	AMCIHD2588	\$ 5815.00	\$ 150.00
(2377, 2577 BSN JJC0292002), 2388 SN JJC0270499-292001 - w/o existing Straw Choppers	Straw Chopper Assembly w/ Drive 5-Groove Pulley	AMCIHD88N	\$ 5625.00	\$ 150.00
5088, 6088, 7088 - w/o existing Straw Choppers	Straw Chopper Assembly w/ Drive Includes 2 Speed Drive Kit	AMCIHD7088	\$ 6285.00	\$ 150.00
All Case IH® Straw Choppers	Dual Drive Kit	AMX27127	\$ 490.00	
1480, 1482, 1680, 1688, 2188, 2377, 2388	Bottom Knife Sheet	AM181147C4	\$ 735.35	
1440, 1460, 1640, 1666, 1660, 1666, 2144, 2166, 2344, 2366	Bottom Knife Sheet	AM185141C4	\$ 515.00	
7120, 7230, 7240, 8120, 8230, 8240, 9120, 9230, 9240	Straw Chopper Pan Replaces 87108192, 87282893, 87563854	AM84187500	\$ 725.00	
7230, 7240, 7250, 8230, (8240, 9240 - Except Redekop™), 8250, 9230, 9250	Slotted Grate Insert Use w/ Straw Chopper w/o Stationary Knives	AM87587528	\$ 360.00	

Case IH®—Combine

Straw Chopper Drive Components

Application	Description	Part Number	Retail Price	Core
1420, 1440, 1460, 1480, 1620, 1640 BSN JJC0034705, (1640 ASN JJC0034704, 1644, 1660, 1666 - w/o Straw Chopper), 1680, 1688, 2144, 2166, 2188, 2344, 2366, 2377, 2388, 2577, 2588, 5130 w/ Non-Common Cab	Drive Hub, Separator Variable Speed	AM194394C1	\$ 128.00	
1440 BSN 20976, 1460 BSN 23401, 1480 BSN 24001	Driven Pulley, Straw Chopper 10" OD Replaces 108533A1, 181196C1	AM181196C2	\$ 146.10	
1440, 1460, 1480	Pulley Hub, Straw Chopper Jackshaft Driven Pulley	AM181211C1	\$ 68.00	
1640, 1644, 1660, 1666, 1670 HillSide, 1680, 1688, 2144, 2166, 2188, 2344, 2366, 2388, 2577, 2588, 5088, 6088	Drive Pulley, Straw Chopper 12 Spline, 2-Groove, 7" & 14" OD	AM1315264C1	\$ 250.00	
2377 SN HAJ0292001-HAJ0300000, 2388 ASN JJC0273000, 2577, 2588, 5088, 6088, 7088	Drive Pulley, Straw Chopper 4.009" ID, 20.50" OD	AM87529708	\$ 411.19	
1440, 1460, 1470, 1480, 1640, 1644, 1660, 1666, 1670, 1680, 1688, 2144, 2166, 2188, 2344, 2366, 2377, 2388, 2577, 2588, 7088	Drive Shaft, Straw Chopper 11.48" Long	AM181195C1	\$ 210.00	
5088, 5130, 5140, 6088, 6130, 6140, 7088, 7130, 7140	Drive Shaft, Straw Chopper	AM87386758	\$ 280.00	
7010, 8010, 8120, 9010, 9120, AFX8010	Drive Shaft, Straw Chopper 104.31" Long Replaces 86975806, 87107192	AM87282228	\$ 996.89	
2344 ASN JJC0174449, 2366 ASN JJC0254999, 2377, 2388 ASN JJC0270500, 2577, 2588	Gear Housing Shaft, Straw Chopper	AM411043A1	\$ 475.00	

Straw Chopper Blades and Components

Hardened-steel chopper blades

Application	Description	Part Number	Retail Price	Core
715 ASN 23001, 815, 915 ASN 8000, 1420, 1440, 1460, 1620, 1640, 1644, 1666, 1680, 1682, 1688, 2144, 2166, 2188, 2344, 2366, 2388, 5088, 6088, 7088	Straw Chopper Blade Kit Set of 2 hardened and hard surfaced blades w/ mounting hardware	AMB96349	\$ 25.00	
	Straw Chopper Blade Kit Set of 2 sharpened bevel edge blades w/ hardware	AM442832A1	\$ 20.00	
7240, 8240, 9240	Straw Chopper Blade Kit Set of 4 Standard/Fine Cut Blades	AM47677377	\$ 73.00	
	Straw Chopper Blade Kit Set of 6 Magnacut Blades Replaces 84141246, 84232968, 87666976	AM47796266	\$ 148.00	
1688, 2188, 2344, 2366, 2388 BSN JJC0276540	Straw Chopper Blade, Single	AM1302764C1	\$ 10.40	
1440, 1460, 1470, 1480, 1482, 1640, 1644, 1660, 1666, 1670, 1680, 1682, 1688, 2144, 2166, 2188, 2344 BSN 174399, 2366 BSN 253999, 2388 BSN 268800	Straw Chopper Stationary Blade, Double	AM1302763C1	\$ 8.23	
(1440, 1460, 1640, 1644, 1660, 1666, 2144, 2166, 2344, 2366 ASN 4325), (1480, 1680 ASN 5138), (1688, 2188, 2388 ASN 6181) - w/ TSR Choppers Only Will not work on OEM Straw Choppers	Straw Chopper Blade	AMX27319	\$ 14.00	
1688, 2188, 2344, 2366, 2388 BSN JJC0276540	Straw Chopper Blade, Double	AM396960A1	\$ 16.63	
2377, 2388, 2577, 2588, 5088, 5130, 5140, 6088, 6130, 6140, 7088, 7130, 7140	Straw Chopper Blade, Double	AM87315088	\$ 12.00	
2388 BSN JJC0276540, 5088, 5130, 5140, 5150, 6088, 6130, 6140, 6150, 7088, 7130, 7140, 7150	Straw Chopper Blade Sold Individually Hardware Not Included	AM409731A1	\$ 10.00	
7010, 7120, 8010, 8120, 9120	Straw Chopper Blade, Offset Replaces 86999627	AM87280494	\$ 20.00	
7230, 7240, 8230, 8240, 9230, 9240	Straw Chopper Stationary Knife Kit Replaces 84424430	AM47952760	\$ 32.00	

Case IH®—Combine

Application	Description	Part Number	Retail Price	Core
7010, 7120, 7230, 7240, 8010, 8120, 8230, 8240, 9120, 9230, 9240, AFX8010	Straw Chopper Stationary Knife	AM87106692	\$ 4.00	
1440, 1460, 1470, 1480, 1482, 1640, 1644, 1660, 1666, 1670, 1680, 1682, 1688, 2144, 2166, 2188, 2344, 2366, 2388 BSN JJC0276540	Knife Mount Bar Assembly Includes Knives Replaces 185135C91, 87315091, 87328045	AM87315495	\$ 343.00	
	Knife Mount Bar Replaces 185135C91, 87315091, 87328045	AM396962A1	\$ 15.12	
7010, 7120, 7230, 8010, 8120, 8230, 9010, 9120, 9230, AFX8010	Bearing Assembly For Beater/Chopper Drive Replaces 47421133, 47663490, 87323956	AM87109088	\$ 260.00	
All Models w/ TSR Choppers Will not work on OEM Straw Choppers	Bushing	AMX27321	\$ 4.00	
	Bushing	AMX27318	\$ 3.00	
	Bushing, Trunnion	AMX27320	\$ 4.00	
	Bolt Kit	AMX27317	\$ 4.00	



Sickle Knife Heads

Application	Description	Part Number	Retail Price	Core
Platforms: 820 Series	Sickle Knife Head	AM197230C91	\$ 153.00	
Platforms: 1010, 1020 - w/ 3" Cut	Sickle Knife Head Replaces 1316161C95	AM1316161C93	\$ 120.00	
Platforms: 2010, 2020	Sickle Knife Head Single Drive	AM848094	\$ 220.00	
Platforms: 2052, 2062	Sickle Knife Head Replaces 87408818	AM153812	\$ 95.00	
Platforms: 1010, 1020	Sickle Drive Block Replaces 1313797C1	AM1313797C2	\$ 51.00	

Sickle Assemblies Without Heads

Easy-to-assemble interlocking/overlapping bar bolts together for greater field convenience. ThunderBOLT Sickles can ship via UPS and are easy to carry and store. The Gold'N Cut section utilizes a coarse serration that sharpens itself as wearing occurs, giving you the longest wear for your money. All sickle sections feature bolt-on convenience and are heat-treated for superior cutting life.



Application	Description	Part Number	Retail Price	Core
Platforms: 962, 963	Sickle Assembly w/o Head, Coarse Includes: (1) 87458220 Left Hand Head Segment, (2) 87458222 Mid Segments, (1) 87458225 Tail Segment, (3) 129043 Splice Kits	30' AMX29051	\$ 448.00	
	Sickle Assembly w/o Head, Coarse Includes: (1) 87458220 Left Hand Head Segment, (3) 87458222 Mid Segments, (1) 87458226 Tail Segment, (4) 129043 Splice Kits	36' AMX29052	\$ 545.00	

Case IH®—Combine

Application	Description	Part Number	Retail Price	Core
Platforms: 2042, 2052, 2062	Sickle Assembly w/o Head, Coarse Includes: (1) 87458220 Left Hand Head Segment, (1) 87458222 Mid Segment, (1) 87470116 Tail Segment, (2) 129043 Splice Kits	21' AMX29037	\$ 319.00	
	Sickle Assembly w/o Head, Coarse Includes: (1) 87458220 Left Hand Head Segment, (1) 87458222 Mid Segment, (1) 87458227 Tail Segment, (2) 129043 Splice Kits	25' AMX29038	\$ 365.00	
	Sickle Assembly w/o Head, Coarse Includes: (1) 87458220 Left Hand Head Segment, (2) 87458222 Mid Segments, (1) 87458225 Tail Segment, (3) 129043 Splice Kits	30' AMX29039	\$ 448.00	
	Sickle Assembly w/o Head, Coarse Includes: (1) 87458220 Left Hand Head Segment, (3) 87458222 Mid Segments, (1) 87458226 Tail Segment, (4) 129043 Splice Kits	36' AMX29040	\$ 545.00	
Platforms: 2142, 2152, 2162	Sickle Assembly w/o Head, Coarse Includes: (1) 87458220 Left Hand Head Segment, (1) 87458222 Mid Segment, (1) 87470116 Tail Segment, (2) 129043 Splice Kits	20' AMX29020	\$ 319.00	
	Sickle Assembly w/o Head, Coarse Includes: (1) 87458220 Left Hand Head Segment, (1) 87458222 Mid Segment, (1) 87458227 Tail Segment, (2) 129043 Splice Kits	25' AMX29021	\$ 365.00	
	Sickle Assembly w/o Head, Coarse Includes: (1) 87458220 Left Hand Head Segment, (2) 87458222 Mid Segment, (1) 87458225 Tail Segment, (3) 129043 Splice Kits	30' AMX29022	\$ 448.00	
	Sickle Assembly w/o Head, Coarse Includes: (1) 87458220 Left Hand Head Segment, (2) 87458222 Mid Segments, (1) 87685333 Tail Segment, (3) 129043 Splice Kits	35' AMX29023	\$ 532.00	
	Sickle Assembly w/o Head, Coarse Includes: (1) 87458220 Left Hand Head Segment, (3) 87458222 Mid Segments, (1) 87699654 Tail Segment, (4) 129043 Splice Kits	40' AMX29024	\$ 606.00	

Case IH®—Combine

Application	Description	Part Number	Retail Price	Core
Platforms: 2142, 2152, 2162 Note: Right and Left Hand Assemblies Must be Purchased Separately to Create Full Double Sickle	Double Sickle Right Hand Assembly w/o Head, Coarse Includes: (1) 87752689 Right Hand Head Segment	20' AMX29026	\$ 177.00	
	Double Sickle Left Hand Assembly w/o Head, Coarse Includes: (1) 87458220 Left Hand Head Segment, (1) 87585387 Left Hand Overlap Tail Segment, (1) 129043 Splice Kit	20' AMX29025	\$ 177.00	
	Double Sickle Right Hand Assembly w/o Head, Coarse Includes: (1) 87725592 Right Hand Head Segment, (1) 87752680 Right Hand Overlap Tail Segment, (1) 129043 Splice Kit	25' AMX29028	\$ 187.00	
	Double Sickle Left Hand Assembly w/o Head, Coarse Includes: (1) 87458220 Left Hand Head Segment, (1) 87585389 Left Hand Overlap Tail Segment, (1) 129043 Splice Kit	25' AMX29027	\$ 188.00	
	Double Sickle Right Hand Assembly w/o Head, Coarse Includes: (1) 87725592 Right Hand Head Segment, (1) 87752681 Right Hand Overlap Tail Segment, (1) 129043 Splice Kit	30' AMX29030	\$ 212.00	
	Double Sickle Left Hand Assembly w/o Head, Coarse Includes: (1) 87458220 Left Hand Head Segment, (1) 87585391 Left Hand Overlap Tail Segment, (1) 129043 Splice Kit	30' AMX29029	\$ 229.00	
	Double Sickle Right Hand Assembly w/o Head, Coarse Includes: (1) 87725592 Right Hand Head Segment, (1) 87752682 Right Hand Overlap Tail Segment, (1) 129043 Splice Kit	35' AMX29032	\$ 242.00	
	Double Sickle Left Hand Assembly w/o Head, Coarse Includes: (1) 87458220 Left Hand Head Segment, (1) 87752686 Left Hand Overlap Tail Segment, (1) 129043 Splice Kit	35' AMX29031	\$ 254.00	
	Double Sickle Right Hand Assembly w/o Head, Coarse Includes: (1) 87725592 Right Hand Head Segment, (2) 87458222 Mid Segments, (1) 87725593 Right Hand Overlap Tail Segments, (3) 129043 Splice Kits	40' AMX29034	\$ 380.00	
	Double Sickle Left Hand Assembly w/o Head, Coarse Includes: (1) 87458220 Left Hand Head Segment, (2) 87458222 Mid Segments, (1) 87725591 Left Hand Overlap Tail Segment, (3) 129043 Splice Kits	40' AMX29033	\$ 418.00	
Platforms: 2142, 2152, 2162 Note: Right and Left Hand Assemblies Must be Purchased Separately to Create Full Double Sickle	Double Sickle Right Hand Assembly w/o Head, Coarse Includes: (1) 87725592 Right Hand Head Segment, (2) 87458222 Mid Segments, (1) 87726850 Right Hand Overlap Tail Segment, (3) 129043 Splice Kits	45' AMX29036	\$ 420.00	
	Double Sickle Left Hand Assembly w/o Head, Coarse Includes: (1) 87458220 Left Hand Head Segment, (2) 87458222 Mid Segments, (1) 87726849 Left Hand Overlap Tail Segments, (3) 129043 Splice Kits	45' AMX29035	\$ 439.00	
Platform: 3020	Sickle Assembly w/o Head, Coarse Top Serrated	20' AM84585670	\$ 460.00	
	Features bolt-together, bolt-on coarse sections	25' AM84585668	\$ 490.00	
	Convenient to transport and store, Will ship UPS and FedEx	30' AM84585666	\$ 580.00	
		35' AM84585664	\$ 499.00	
Platform: 3020 Double Drive	Sickle Assembly w/o Head, Coarse Top Serrated	30' Right Hand AM84585676	\$ 266.00	
	Features bolt-together, bolt-on coarse sections	30' Left Hand AM84585677	\$ 260.00	
	Convenient to transport and store, Will ship UPS and FedEx	35' Right Hand AM84585678	\$ 433.00	
		35' Left Hand AM84585679	\$ 433.00	
Platform: 3020 ASN 222000	Splice Kit	AMX29063	\$ 27.00	

Case IH®—Combine



Sickle Assemblies With Heads

These assemblies feature bolt-together, coarse sections and include the drive head. Bolt-together sickles are convenient to transport and store. They will ship via UPS and FedEx.

Application	Description	Part Number	Retail Price	Core
Platforms: 1010, 1020	Sickle Assembly w/ Head, Coarse	15' AM371613A2	\$ 328.00	
	Sickle Assembly w/ Head, Coarse	16.50' AM371617A2	\$ 382.00	
	Sickle Assembly w/ Head, Coarse	17.50' AM371618A2	\$ 412.00	
	Sickle Assembly w/ Head, Coarse	20' AM371619A2	\$ 510.00	
	Sickle Assembly w/ Head, Coarse	22.50' AM371620A2	\$ 459.00	
	Sickle Assembly w/ Head, Coarse	25' AM371621A3	\$ 464.00	
	Sickle Assembly w/ Head, Fine Cut	25' AM451834A3	\$ 530.00	
	Sickle Assembly w/ Head, Coarse	30' AM371622A3	\$ 648.00	

Guards and Cutter Bar Parts



Application	Description	Part Number	Retail Price	Core
Used on most Case IH® Platforms, Including 810 Grain and 810 Draper Platforms	Knife Guard	AM633098R1	\$ 11.00	
Platforms: 820, 1010 BSN JJC0200000, 1020 BSN JJC0215001	Knife Guard, Double Pronged w/ Trashbar Use w/ 3" Cutter Bar Knife Replaces 613838R2, 613838R3	AM613838R1	\$ 11.00	
Platforms: 820, 1010, 1020, (2010, 2020 - w/ Single Drive or ASN CBJ021300 w/ Double Drive)	Knife Guard, Double Pronged w/o Trashbar Use w/ 3" Cutter Bar Knife For Drive Head End Replaces 483500R3, 1326787C1, 1326787C2, 1326787C3	AM87442329	\$ 12.50	
Platforms: 1010 BSN JJC020000, 1020 BSN JJC215001	Knife Guard, 4-Pronged For 1.50" Cutting System Replaces 1989552C1	AM1305195C1	\$ 12.00	
Platforms: 1010, 1020	Knife Guard, Single Prong End Use w/ 3" Cutter Bar Knife For 15', 20', 25' and 30' Platforms	AM1338269C1	\$ 11.00	
	Knife Guard, Double Pronged Drive Head Guard (3) Required per Head	AM1326787C3	\$ 12.00	
Platforms: 1010, 1020, 2010*, 2020** *20' and 25' Single Drive, 20' and 25' Double Drive SN CBJ020001-CBJ021301, or 30' Double Drive ASN CBJ020001 **20' and 25' Single Drive, 20' and 25' Double Drive SN CBJ020001-CBJ021301, 30' Double Drive ASN CBJ020001, or 35' Double Drive ASN CBJ021300	Knife Guard, Double Pronged w/o Trashbar Use w/ 3" Cutter Bar Knife Replaces 334305A1, 8744232A	AM1307299C2	\$ 12.00	
Platforms: 2010 (20' Single Drive BSN CBJ020001 or 20', 25' and 30' Double Drive BSN CBJ020001), 2020 (20', 25' and 30' Double Drive BSN CBJ020001)	Knife Guard, Double Pronged w/ Trashbar Use w/ 3" Cutter Bar Knife For Drive Head End Replaces 9801347, 86521590, 86553346, 86615983, 87042358, 87042360	AM86615984	\$ 19.50	
Platforms: 2010 (20' Single Drive BSN PNL020001 or 20', 25' and 30' Double Drive BSN PNL020001), 2020 (20', 25' and 30' Double Drive BSN PNL020001), Draper Platforms: 8830 SN CFH0030001-CFH0030158, (DH213, DH253, DH303 - 25' and 40' Double Drive w/ Honey Bee®, DH363 (40' Double Drive w/ Honey Bee®), (DH182, DH212, DH252, DH302, DH362, DHX182, DHX212, DHX252, DHX302, DHX362 - w/ Double Knife Drive) Replaces 86521587, 86553340, 87042356	Knife Guard, Double Pronged w/ Trashbar Use w/ 3" Cutter Bar Knife	AM86615982	\$ 12.00	

Case IH®—Combine









Application	Description	Part Number	Retail Price	Core
Platform: 2042	Knife Guard, Double Pronged Replaces 49312	AM118346	\$ 11.25	
Platform: 3020	Knife Guard, Double Pronged w/o Trashbar Use w/ 3" Cutter Bar Knife	AM87702974	\$ 15.00	
Platforms: 3020 (25', 30' and 35' Single Drive or 30' and 35' Double Drive), Draper Platforms: 3152, 3162	Knife Guard, Double Pronged w/o Trashbar Use w/ 3" Cutter Bar Knife	AM87702973	\$ 16.00	
Draper Platforms: 1052, 2042, 2052, 2062, 2152, 2162 Replaces 87421451	Knife Guard, Double Pronged	AM118344	\$ 11.00	
Draper Platforms: 1052, 2042, 2052, 2062, 2162	Knife Guard, Double Pronged Drive Head Guard (3) Required per Single Knife (6) Required per Double Knife	AM118345	\$ 12.00	
	Knife Guard First Guard, Left Hand w/ Cross Bar Double Heat Treated (1) Required per Head Replaces 47709129, 87422039	AM118301	\$ 13.00	
	Knife Guard Last Guard, Right Hand w/ Cross Bar Double Heat Treated (1) Required per Head Replaces 47709128, 87422040	AM118302	\$ 13.00	
Draper Platforms: DH182, DH212, DH252, DH302, DH362, DHX182, DHX212, DHX252, DHX302, DHX362	Knife Guard, Double Pronged Special, Center w/ Cross Bar	AM86615983	\$ 14.25	
Rigid Platforms: 2010, 2020	Knife Guard 4-Prong Bottom Guard	AM87015708	\$ 12.50	
Platform: 820	Guard Stub, Single Prong Forged Replaces 257635, H472717R2	AM472717R2	\$ 10.50	
Platforms: 820, 1010, 1020	Sickle Section Sold in Multiples of 25, Priced Individually	AM112074A1	\$ 2.00	
Platforms: 1042, 1052, 2015, 2042, 2062, 2142, 2152, 2162	Sickle Section, Coarse 3.25" Long, 3" Wide, 2.125" Hole Spacing Sold in Multiples of 25, Priced Individually	AM158516	\$ 2.25	
Platform: 3020	Sickle Section, Coarse Sold in Multiples of 25, Priced Individually	AM87728905	\$ 2.25	
Platform: 1020	Sickle Section End Replaces 148200C1	AM86617760	\$ 5.50	
Platforms: 1010, 1020, 2010, 2020, DHX182, DHX212, DHX252, DHX302, DHX362, HDX121, HDX122, HDX141, HDX142, HDX161, HDX162, HDX181, HDX182, SMX91	Knife Clip, Low Profile Adjustable Replaces 1307280C3, 71346158, 86630786, H84412	AMX29115	\$ 13.70	
	Knife Clip, Low Profile Replaces 1307280C3, 71346158, 86630786, H84412	AMX27554	\$ 6.50	
Platforms: 1010, 1020	Hold Down Clip For 1.50" Knife	AM101001A2	\$ 33.25	
	Hold Down Clip Hi-Arch, For 3" Knife	AM375900A1	\$ 14.00	
Platforms: 1042, 1052, 2042, 2052, 2062, 2142, 2152, 2162 Replaces 338591A1, 84399893	Hold Down Clip Hi-Arch Includes Nut and Bolt	AM118499	\$ 6.85	

Case IH®—Combine

Application	Description	Part Number	Retail Price	Core
Cutting Platforms: 1010, 1020, 2010, 2020, Draper Platforms: DHX182, DHX212, DHX252, DHX302, DHX362	Section Bolt and Nut Kit 7/32" x 5/8" Grade 8 Rib Neck, Package of 50 For Standard Straight Hole Sections Replaces 850716, 700705296	AM86507777	\$ 15.63	
Platform: 3020	Section Bolt and Nut Kit 22 mm, Package of 25	AMX26092	\$ 8.40	
	Section Bolt and Nut Kit 18 mm, Package of 50	AMX29061	\$ 12.15	

Chaff Spreaders and Components

Standard, patented single-wing arm design; spreader position is infinitely adjustable. Stainless steel front and rear shields. 39" chaff distribution area is the largest in the field. Complete with motor, hose kit and shaker pans.

Application	Description	Part Number	Retail Price	Core
 1420, 1440, 1460, 1480, 1620, 1640 BSN 97190, 1660 BSN 103800, 1680 BSN 117060	Chaff Spreader	AMEF1691IH	\$ 1695.00	
1640 ASN 97190, 1660 ASN 103800, 1680 ASN 117060	Chaff Spreader	AMEF1692CIHE	\$ 1695.00	
2144, 2166, 2188, 2344, 2366, 2388	Chaff Spreader	AMEF2100CIH	\$ 1695.00	
 1666, 1688, 2166, 2188, 2366, 2377, 2388, 2577, 2588, 5088, 5130, (5140, 6140, 7140 Prior to 10/2015), 6088, 6130, 7088, 7130, 7230, 7240, 7250, 8230, 8240, 8250, 9230, 9240, 9250	Chaff Spreader Disc 35.50" OD, Aluminum For Straw or Chaff Spreader	AM140189A1	\$ 226.00	
 1688, 2188, 2377, 2388 - w/ Straw and Chaff Spreader	Cleaning Shoe Door Shield Hardware Not Included	AM87301089	\$ 202.11	
 1644, 1666, 2144, 2166, 2344, 2366	Cleaning Shoe Door Shield, Narrow	AM122639A4	\$ 147.94	
 5088, 5130, 5140, 6088, 6130, 6140, 7088, 7130, 7140 - w/ Straw and Chaff Spreader	Cleaning Shoe Door Shield	AM87684740	\$ 170.01	
 7230, 7240, 7250, 8240, 8250, 9240, 9250	Spreader Divider Liner Kit Whale Tail Style, Stainless Steel Includes Right and Left Hand Weld-In Panels Replaces 47911828	AMX29151	\$ 414.00	
 2577, 2588 - w/ Straw and Chaff Spreader	Spreader Curtain Hardware Not Included	AM87739170	\$ 72.52	
 7010, 7120, 7130, 7230, 7240, 7250, 8010, 8120, 8230, 8240, 8250, 9010, 9120, 9230, 9240, 9250, AFX8010	Rubber Damper 310 mm x 178 mm (2) Required	AM84154916	\$ 22.00	



Hydraulic Pump Drive Hubs and Components

Application	Description	Part Number	Retail Price	Core
2144, 2166, 2188, 2344, 2366, 2377 SN HAJ292001-HAJ 300000, 2388 BSN JJC02766540 & ASN HAJ292001, (2577, 2588 ASN HAJ0300001)	Hydraulic Pump	AM87338787	\$ 1000.00	
2366 ASN JJC0255700, 2377, 2388 ASN JJC0270500, 2577, 2588	Hydraulic Pump	AM375147A1	\$ 675.00	
7010, 7120, 7230, 7240, 7250, 8010, 8120, 8230, 8240, 8250, 9010, 9120, 9230, 9240, 9250, AFX8010	Hydraulic Pump 63 cc	AM87105987	\$ 1925.00	

Case IH®—Combine

Application	Description	Part Number	Retail Price	Core
1420, 1440, 1460, 1470, 1480, 1620, 1640, 1644, 1660, 1666, 1670, 1680, 1688, 2144, 2166, 2188, 2344, 2366, 2377 SN HAJ292001-HAJ300000, 2388, (2577, 2588 ASN HAJ300001)	Auxiliary Hydraulic Pump Drive Hub Grease Zerk Not Included	AM196482C2	\$ 173.00	
5130, 5140, 5150, 6130, 6140, 6150, 7120, 7130, 7140, 7150, (7230, 9230 - w/ Common Cab), 7240 09/2014-09/16, 8120, 8230, 8240 Prior to 09/2017, 9120, 9240	Solenoid, Main Distributor Valve Replaces 87775314	AM188105A1	\$ 70.00	
5130, 5140, 5150, 6130, 6140, 6150, 7010, 7120, 7130, 7140, 7150, 7230, 7240, 7250, 8010, 8120, 8230, 8240, 8250, 9010, 9120, 9230, 9240, 9250, AFX8010	Solenoid 12 Volt	AM86995302	\$ 50.00	



Hydraulic Oil Coolers

Application	Description	Part Number	Retail Price	Core
2144 ASN JJC0173150, 2166 ASN JJC0180000, 2188 ASN JJC0191483, 2344, 2366	Hydraulic Oil Cooler w/ Fuel Cooler Core: 15" x 25" x 3 7/8" Replaces 195441A2	AM195441A3	\$ 980.00	
2366	Hydraulic Oil Cooler w/ Fuel Cooler Core: 33" x 35" x 3.10"	AM416766A2	\$ 1825.00	
2377, 2388, 2577, 2588	Hydraulic Oil Cooler Core: 36 1/2" x 24" x 3 7/8" Replaces 446343A1, 446343A2	AM446343A3	\$ 1575.00	
2388 BSN JJC0276540	Hydraulic Oil Cooler Core: 29.50" x 22" x 4.60" Replaces 242304A1, 275098A1	AM275098A2	\$ 1750.00	
	Hydraulic Oil Cooler Core: 35" x 24" x 3 7/8" Replaces 444921A3	AM444921A2	\$ 1530.00	
2388	Hydraulic Oil Cooler Core: 29 1/2" x 22" x 3 1/16" Replaces 275096A1	AM275096A2	\$ 1538.00	
5088, 6088, 7088	Hydraulic Oil Cooler Core: 36 3/8" x 24" x 3.80"	AM87614591	\$ 1600.00	
7010, 8010, 9010, AFX8010	Hydraulic Oil Cooler w/ Fuel Cooler Core: 36" x 41" x 3.50" Replaces 86976449	AM87106640	\$ 2026.00	
Patriot Sprayers: 2250, 3240, 3340, 4430, 4440	Hydraulic Oil Cooler Core: 19" x 36" x 3.40" Replaces 84223602	AM84427916	\$ 878.00	
Patriot Sprayers: 3230, 3330, SPX3320	Hydraulic Oil Cooler Core: 40.50" x 29" x 1.50"	AM86986928	\$ 724.00	
Patriot Sprayer: 4420	Hydraulic Oil Cooler Core: 36" x 36" x 1"	AM87271989	\$ 903.00	
8120, 8230, 9120, 9230	Condenser w/ Oil Cooler Replaces 84576582	AM47475783	\$ 1260.00	
Swathers: WD1903, WD2303	Condenser w/ Oil Cooler Core: 30 7/8" x 31" x 3.80" Replaces 87340522	AM87490300	\$ 1070.00	



Sickle Drives and Components

Application	Description	Part Number	Retail Price	Core
Grain Platforms: 1010 ASN JJC0300001, 1020 ASN JJC0315001	Wobble Box Assembly Replaces 87502685	AM133157A3	\$ 1658.00	
Platforms: 1042, 1052, 2042, 2052, 2062, 2142, 2152, 2162	Wobble Box	AM338670A1	\$ 1607.00	
Platforms: 2010, 2020, 2030, 2040, 2050	Wobble Box	AM85000175	\$ 1140.00	

Case IH®—Combine

Application	Description	Part Number	Retail Price	Core
Platforms: 3020, 3050 BSN C003	Wobble Box	AM87724927	\$ 1097.00	
Platforms: 810 ASN 501, 820	Wobble Box Pulley	AM182029C1	\$ 345.00	
Grain Platforms: 1010 ASN JJC0200001, 1020 SN JJC0215001-JJC0227000 & ASN JJC0315001	Wobble Box Pulley	AM138775A1	\$ 191.06	
Platforms: 1010	Wobble Box Lower Tray Replaces 87450181	AM129719A2	\$ 70.00	
	Wobble Box Support Plate	AM126316A1	\$ 75.00	
Platforms: 1052, 2042, 2052, 2062, 2142, 2152, 2162	Pulley, Knife Drive Gearbox	AM338585A1	\$ 265.00	
Platforms: 1010, 1020	Knife Drive Arm Replaces 126314A1	AM126314A2	\$ 121.96	
Platforms: 1052, 2042, 2052, 2062, 2142, 2152, 2162	Arm	AM369994A1	\$ 195.00	
Platform: 1020 SN JJC03150010-JJC0350294 & ASN JJC0215001	Idler Arm Replaces 87450150	AM138439A1	\$ 175.00	

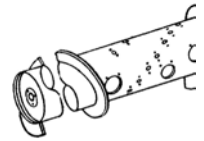

Auger Components—Bare Header / Platform

Application	Description	Part Number	Retail Price	Core
Platforms: 1010, 1020	Poly Finger Use w/ AMX29116 Finger Guide	AMX27276	\$ 9.00	
Platforms: (810, 820 ASN 25001), 1010, 1020 Replaces 434295A2	Auger Finger Use w/ AM87620690 Finger Guide	AM1320699C1	\$ 8.00	
Platforms: 2010, 2020	Auger Finger, Steel	AM87670642	\$ 17.00	
Platforms: 3020, 3050, 3152, 3162	Auger Finger	AM84194057	\$ 15.00	
Draper Platforms: 2142, 2152, 2162	Auger Finger Sold in Multiples of 5, Priced Individually Replaces 87561023	AM47548630	\$ 9.00	
Platforms: 1010, 1015, 1020	Auger Finger Shaft	AM1316383C1	\$ 106.43	
Platforms: 3016, 3020, 3050, 3152, 3162	Finger Holder	AM84362468	\$ 14.00	
Cutting Platforms: 1010, 1020, 2142, 2152, 2162	Finger Guide 9 1/8" Long Use w/ AMX27276 Poly Finger	AMX29116	\$ 4.50	
Grain Platforms: 810, 820, 1010, 1015, 1020, (2010, 2020 BSN CBJ20701), Draper Platforms: 1042 BSN CCC0010467, 1052 BSN CCC0012343, 2042, 2052, 2062, 2142, 2152, 2162 Replaces 410718A1, 1307259C1, 1307259C2, 87051323, 87666079, 87685315	Finger Guide Use w/ AM1302699C1 Finger	AM87620690	\$ 4.00	
Draper Platforms: 1042 ASN CCC0010467, 1052 ASN CCC0012343, 2042, 2052, 2062, 2142, 2152, 2162	Retracting Finger Guide Nut	AM410726A1	\$ 1.00	
Platforms: 810, 820, 1010, 1015, 1020, Draper Platforms: 1042, 1052, 2042, 2052, 2062	Hub Replaces 410719A1	AM1308425C1	\$ 4.00	
Platforms: 1010 ASN JJC0200001, 1020 SN JJC0215001-JJC0227000 & ASN JJC0315001	Auger Drive Sprocket	AM125990A1	\$ 33.00	
Platforms: (1010, 1020 ASN CBJ023001)	Auger Driven Sprocket 56 Tooth, 14 Spline	AM87450164	\$ 148.00	
Platforms: 1010, 1020, 2010, 2020	Idler Sprocket Replaces 179013A1	AM86627870	\$ 36.00	
Platforms: 810, 820	Slip Clutch Plate 6.50" Bolt Circle, 0.343" Hole Diameter	AM177963C1	\$ 125.17	
Platforms: 810 ASN 501, 820	Slip Clutch Facing 2.97" ID, 6" OD, 0.192" Thick	AM177964C2	\$ 16.07	
Cutting Platforms: 810, 820, 1010, 1015, 1020, Draper Platforms: 810	Bearing, Auger Shaft	AM664073R92	\$ 22.00	

Case IH®—Combine

Reel Components

Application	Description	Part Number	Retail Price	Core
Platforms: 820, 1020 - w/ Love Teardrop Reel	Reel Tine	AM1979845C1	\$ 4.16	
Platforms: 1010, 1020 Replaces 1989438C1, 9842263, B93868, B94710	Reel Tine Nylon, 3-Piece Double Wing Unit 4.50" Spacing Includes Hardware Sold in Multiples of 25, Priced Individually Replaces center tine, some modification required for right and left hand sides	AMTINE	\$ 2.25	
Platforms: 2010, 2020, 3020 Replaces 410856A1, 86608282, 86620758, B95856, B95857, B95872	Reel Tine Nylon, Double Wing Unit, 6" Spacing Includes Hardware Sold in Multiples of 25, Priced Individually	AMX27222	\$ 2.40	
Platforms: 2010, 2020, 3020 Replaces 410858A1, 86608284, 86620757	Reel Tine, Right Hand Wing 6" Spacing, Includes Hardware	AMX29057	\$ 4.00	
Platforms: 2010, 2020, 3020 Replaces 410857A1, 86608283, 86620755	Reel Tine, Left Hand Wing Nylon, 6" Spacing Includes Hardware	AMX29056	\$ 4.00	
Platform: 1020 ASN CBJ023001 Replaces 1970586C1, B93866, B1970586C1	Reel Tine For Platforms w/ Tear Drop Bats and Tines Mounted to Rear of the Steel Bat	AM1970586C1	\$ 2.00	
Platforms: 1052, 2052, 2062	Reel Tine Sold in Multiples of 25, Priced Individually Replaces 105212, 105351, 105352	AM381139A1	\$ 3.00	
Platforms: 2142, 2152, 2162	Reel Tine, HD Sold in Multiples of 25, Priced Individually	AM87561020	\$ 3.35	
Draper Platforms: 3152, 3162, DH213, DH253, DH303, DH363, DH403	Reel Tine Sold in Multiples of 25, Priced Individually Replaces 48056250, 48151645, 84566589	AM47392794	\$ 3.60	
Draper Platforms: DHX181, DHX182, DHX211, DHX212, DHX251, DHX252, DHX301, DHX302, DHX361, DHX362	Reel Tine, Flexible Tear Drop Style Replaces 276306M1, 700708862, 800714195	AM86562205	\$ 2.61	
Platforms: 1010, 1020, 2020	Quick Fingers, Package of 10	AMX27550	\$ 22.00	
Draper Platforms: 2142, 2152, 2162	Quick Finger Repair Tine	AMX41116	\$ 2.95	
Platforms: 1010, 1020, 2010 Rigid, Draper Platforms: DHX181, DHX182, DHX211, DHX212, DHX251, DHX252, DHX301, DHX302, DHX361, DHX362	Reel Bearing Replaces 84469382, 89842300, 9842300	AM1347084C1	\$ 2.25	
Draper Platforms: 2142, 2152, 2162	Reel Pipe Bushing Replaces 47731149, 87566335	AM47548631	\$ 18.00	
Platforms: 1010, 1020, 2010, 2020, Draper Platforms: DHX181, DHX182, DHX211, DHX212, DHX251, DHX252, DHX301, DHX302, DHX361, DHX362	Eccentric Bushing, Pickup Reel - Female Replaces 86518392	AM114951A1	\$ 3.00	
	Eccentric Bushing, Pickup Reel - Male Replaces 86518393	AM114952A1	\$ 3.00	
Platforms: 1010, 1020, 2010, 2020	Reel Drive Sprocket 17 Tooth, 1.125" Bore w/ Keyway	AM87035837	\$ 35.00	
Platforms: 1010, 1020, 2010, 2020	Reel Drive Sprocket 51 Tooth, 1.57" ID Replaces 87036543	AM129973A1	\$ 85.00	
7010, 7120, (7230, 8230, 9230 - w/ Non-Common Cab), 8010, 8120, 9010, 9120, AFX8010	Solenoid, Reel Drive Valve Replaces 87775314	AM188105A1	\$ 70.00	

Case IH®—Combine

Platform Floor Sheets

Application	Description		Part Number	Retail Price	Core
1020 BSN JJC0227000 & ASN JJC0315001	Bottom Floor Sheet 109" Long	Center	AM1313156C2	\$ 415.00	
	Bottom Floor Sheet 38.625" Long For 15' Platform	Right Hand	AM1313138C2	\$ 160.00	
		Left Hand	AM1313132C2	\$ 160.00	
	Bottom Floor Sheet 65.625" Long For 20' Platform	Right Hand	AM1313140C2	\$ 300.00	
		Left Hand	AM1313134C2	\$ 300.00	
	Bottom Floor Sheet 95.625" Long For 25' Platform	Right Hand	AM1313142C2	\$ 375.00	
Left Hand		AM1313136C2	\$ 395.00		
Bottom Floor Sheet 125.625" Long For 30' Platform	Right Hand	AM1313143C2	\$ 470.00		
	Left Hand	AM1313137C2	\$ 455.00		

Platform Components

Application	Description		Part Number	Retail Price	Core
Platforms: 1010, 1020	Jackshaft, Knife Drive 45.12" Long, 1.125" Hex Shaft Diameter		AM125971A2	\$ 129.71	
Platforms: 1010 BSN JJC0200000, 1015, 1020 BSN JJC0215001	Shaft Collar, Main Drive		AM1327106C1	\$ 26.24	
2144, 2166, 2188, 2344, 2366, 2377, 2388, 2577, 2588, 5088, 5130, 5140, 6088, 6130, 6140, 7088, 7130, 7140, 7230, 7240, 8230, 8240, 9230, 9240, Cotton Pickers: 420, 620, 625, 635, 2155, 2555, CPX420, CPX610	Potentiometer, Header Adjustment		AM114551A1	\$ 97.00	
Platform: 3020	Support Bracket, Left Hand		AM84296810	\$ 160.00	
Platforms: 3020, 3050, Draper Platform: 3162	Sprocket 47 Tooth For Slow RPM Auger Drive Replaces 47579289		AM84209468	\$ 265.00	
Platforms: 3020, 3152, 3162	Sprocket Assembly 43 Tooth, 80 Pitch		AM84176718	\$ 210.00	
Platform: 3152, 3162 - 11/2011 and Later	Turret Flap		AM47553645	\$ 75.00	
Platforms: 1020, 3020	Spring Nut, Upper		AM124366A1	\$ 50.00	
	Spring Plug, Lower		AM1313104C1	\$ 40.00	
5130, 5140, 6130, 6140, 7130, 7140, 7230, 7240, 8230, 8240, 9230, 9240	Quick Male Coupling, Header Coupler Replaces 47472035, 84435502		AM47360258	\$ 47.00	
	Quick Male Coupling, Header Coupler Replaces 47870683, 87691267		AM84580534	\$ 21.00	

Row Crop Dividers

Eliminate costly grain loss from knocked down plants. Change from short to long dividers in minutes. Safer transportation and easy storage. Sectional design allows you to replace only the damaged piece which saves you money.



Application	Description		Part Number	Retail Price	Core	
Flex Platforms: 800 Series	Complete Set of Dividers, Short		AMSCD500IH	\$ 1175.00		
		Components:				
		Rear Divider	1	AMSCD100IH-RH	\$ 400.00	
		Rear Divider	1	AMSCD100IH-LH	\$ 400.00	
		Short Divider Tip	2	AMSCD250	\$ 77.00	
		Divider Nose Bar	2	AMSCD300	\$ 51.00	

Case IH®—Combine

Application	Description	Part Number	Retail Price	Core
Flex Platforms: 800 Series	Complete Set of Dividers, Long	AMSCD400IH	\$ 1350.00	
	Components:			
	Rear Divider	1 AMSCD100IH-RH	\$ 400.00	
	Rear Divider	1 AMSCD100IH-LH	\$ 400.00	
	Divider Front Wing Section, Long	2 AMSCD200	\$ 550.00	
	Divider Nose Bar	2 AMSCD300	\$ 51.00	
Flex Platforms: 800 Series	Short Divider Tip	AMSCD250	\$ 55.00	
Fits All 1020 Platforms	OEM Style Divider	Right Hand	AM1316061C1	\$ 536.00
		Left Hand	AM1316060C3	\$ 597.00
	Outer Wing Assembly	AM1316062-N	\$ 597.00	

Header Lift Cylinders and Components



Application	Description	Part Number	Retail Price	Core
2144, 2166, 2188, 2344, 2366, 2388, 2577, 2588, 5088, 6088	Third Cylinder Kit For 54" Feederhouse w/ Rock Trap	AM137857A2	\$ 975.00	
	Third Cylinder Kit For 60" Feederhouse	AM137856A2	\$ 975.00	
2144, 2166, 2188, 2344, 2366, 2377, 2388, 2588	Header Lift Cylinder 2 7/8" Diameter, 22 15/16" Stroke	AM251807A2	\$ 520.00	
2144, 2166, 2188, 2344, 2366, 2377, 2388, 2577, 2588	Extension Tube, Feederhouse Lift Cylinder For 54.50" Feederhouse w/ Rock Trap	AM124059A2	\$ 100.00	
(7010, 8010, 9010, AFX8010 - Heavy Duty), 7230, 7240, 8230, 8240, 9230, 9240	Header Lift Cylinder 90 mm Replaces 84193227, 87728497	AM84263630	\$ 1377.00	
7010, 7120, 7230, 8010, 8120, 8230, 9010, 9120, 9230, AFX8010	Lateral Tilt Cylinder, HD 5.51" (140 mm) Stroke Length	AM87753846	\$ 675.00	
2144, 2166, 2188, 2344, 2366, 2377 SN AJ292001-HAJ300000, 2388 BSN JJC0276540 and SN HAJ292001-HAJ300000, 2577, 2588	Hydraulic Lift Valve	AM124566A3	\$ 4437.00	
2144, 2166, 2188, 2344, 2366, 2377, 2388, 2577, 2588, 5130, 5140, 5150, 6130, 6140, 6150, 7010, 7120, 7130, 7140, 7150, 7230, (7240, 8240, 9240 - Prior to 09/2017), 8010, 8120, 8230, 9010, 9120, 9230, AFX8010	Solenoid, Header Height Valve Replaces 87775314	AM188105A1	\$ 70.00	
2144, 2188, 2377, 2388, 2577, 2588	Seal Kit For Feederhouse Lift Cylinder Replaces 87385882	AM87552535	\$ 68.00	
5088, 5130, 5140, 6088, 6130, 6140, 7010, 7088, 7120, 7130, 7140, 7230, 7240, 8010, 8120, 8230, 8240, 9010, 9120, 9230, 9240, AFX8010	Seal Kit For Lateral Tilt Cylinders Replaces 84142087, 87352396	AM87105744	\$ 280.00	
5088, 6088, 7010, 7088, 7120, 7240, 8010, 8120, 8240, 9010, 9120, AFX8010	Seal Kit For Header Lift Cylinder, 75 mm	AM87031097	\$ 250.00	



Draper Belts and Components

Application	Description	Part Number	Retail Price	Core
Platforms: 1042, 1052, 2042, 2052, 2062	Draper Center Feeder Belt 38.40" x 97.00" Single V-Guide For 38.00" Feed Deck	AM338361A1	\$ 352.00	

Case IH®—Combine

Application	Description	Part Number	Retail Price	Core
Platforms: 1042, 2042 - w/ Double Delivery	Draper Belt, HD 30' Right Hand, 41.60" x 345.00" Single V-Guide	AM338630A1	\$ 857.00	
	Draper Belt, HD 30' Left Hand, 41.60" x 297.80" Single V-Guide	AM338629A1	\$ 736.00	
	Draper Belt, HD 36' Right Hand, 41.60" x 417.00" Single V-Guide	AM338635A1	\$ 1044.00	
	Draper Belt, HD 36' Left Hand, 41.60" x 369.70" Single V-Guide	AM338633A1	\$ 915.00	
Platforms: (1042, 1052 ASN CCC0010467), 2042, 2052, 2062 - w/ Center Delivery Replace 430272A1	Draper Center Feeder Belt 45.00" x 97.00" Single V-Guide For 45.00" Feed Deck	AM114267	\$ 348.00	
Platforms: 1052, 2052 - w/ Double Delivery	Draper Belt, HD 21' Right and Left Hand, 71.60" x 201.00" Single V-Guide	AM346016A1	\$ 516.00	
Platforms: 1052, 2052, 2062 - w/ Double Delivery	Draper Belt, HD 25' Right and Left Hand, 41.60" x 249.00" Single V-Guide	AM346018A1	\$ 604.00	
	Draper Belt, HD 30' Right and Left Hand, 41.60" x 309.00" Single V-Guide	AM346022A1	\$ 748.00	
Platforms: 1052, 2052, 2062 - w/ Center Delivery	Draper Belt, HD 36' Right Hand, 41.60" x 405.00" Single V-Guide	AM372312A1	\$ 997.00	
Platforms: 1052, 2052, 2062 - w/ Double Delivery	Draper Belt, HD 36' Left Hand, 41.60" x 357.00" Single V-Guide	AM372311A1	\$ 882.00	
Platforms: 2042, 2052, 2062 Replaces 87407808	Draper Center Feeder Belt 55.90" x 97.00" Single V-Guide	AM101672	\$ 500.00	
Platforms: 1052, 2052, 2062 - w/ Center Delivery	Draper Belt, HD 39' Right Hand, 41.60" x 433.00" Single V-Guide	AM87446870	\$ 1067.00	
	Draper Belt, HD 39' Left Hand, 41.60" x 389.00" Single V-Guide	AM87446868	\$ 968.00	
Platforms: 1052, 2052, 2062 - w/ End Delivery	Draper Belt, HD 36' Right Hand - Outboard Deck, 41.60" x 154.00" Single V-Guide	AM372321A1	\$ 485.00	
	Draper Belt, HD 39' Right Hand - Outboard Deck, 41.60" x 182.00" Single V-Guide	AM87446869	\$ 487.00	
Platforms: 2142, 2152, 2162 - w/ Center Delivery	Draper Center Feeder Belt 78.50" x 63.46" Single V-Guide	AM87560973	\$ 545.00	
Platforms: 2152, 2162	Draper Belt, HD 20' Right and Left Hand, 41.60" x 158.24" Single V-Guide	AM47611890	\$ 450.00	
Platforms: 2142, 2152, 2162 Replaces 47563846, 87560977, 87605706	Draper Belt, HD 25' Right and Left Hand, 41.60" x 217.24" Single V-Guide	AM47767475	\$ 609.00	
Platforms: 2142, 2152, 2162 - w/ Double or Triple Delivery Replaces 87560978	Draper Belt, HD 30' Right and Left Hand, 41.60" x 277.24" Single V-Guide	AM47489938	\$ 725.00	

Case IH®—Combine

Application	Description	Part Number	Retail Price	Core
Platforms: 2142, 2152, 2162 - w/ Double Delivery Replaces 47610128, 47679354	Draper Belt, HD 35' Right and Left Hand, 41.60" x 337.24" Single V-Guide	AM87560979	\$ 845.00	
Platforms: 2152, 2162 - w/ Double Delivery Replaces 47610129, 47679353	Draper Belt, HD 40' Right and Left Hand, 41.60" x 397.24" Single V-Guide	AM87560980	\$ 1048.00	
Platforms: 2152, 2162 Replaces 47767476, 51471583, 84122227	Draper Belt, HD 45' Right and Left Hand, 41.60" x 457.24" Single V-Guide	AM84399888	\$ 1142.00	
Platform: 3162 Replaces 47932768, 84289411	Draper Center Feeder Belt 42.00" x 60.24" Single V-Guide	AM47435658	\$ 274.00	
Platforms: 8210, 8220, 8230, 8240 ASN CFH0064005 Pull-Type	Draper Belt 21' Left Hand, 42.00" x 140.63" Long Bar	AM700712955	\$ 322.00	
Platforms: (8210, 8220, 8230, 8240 - 21' Models ASN CFH0064005 or 25' Models ASN CFH0065015 Pull-Type)	Draper Belt 21' or 25' Right Hand, 42.00" x 275.38" Long Bar	AM700712956	\$ 588.00	
Platform: 3152	Draper Center Feeder Belt 42.00" x 50.24" Single V-Guide Replaces 47377069, 47435660	AM47932836	\$ 264.00	
	Side Draper Belt 25' Right and Left Hand, 41.60" x 207.40" Single V-Guide	AM47371562	\$ 675.00	
Platforms: 3152, 3162 Replaces 84307562	Side Draper Belt 30' Right and Left Hand, 41.60" x 267.40" Single V-Guide	AM47371565	\$ 665.00	
Platforms: 3152, 3162 Replaces 87743629	Side Draper Belt 35' Right and Left Hand, 41.60" x 327.40" Single V-Guide	AM47371567	\$ 783.00	
Platforms: 3152, 3162 Replaces 87478999	Side Draper Belt 40' Right and Left Hand, 41.60" x 387.40" Single V-Guide	AM84487818	\$ 911.00	
Platforms: 3152, 3162 Replaces 87753630	Side Draper Belt 45' Right and Left Hand, 41.60" x 447.40" Single V-Guide	AM47371571	\$ 1026.00	
Platforms: 1042, 2042, 1052, 2052, 2062	Draper Belt Repair Kit For 41.60" Belt Includes 34" Repair Section of RAPTOR Material, Pre-Punched for Connector, (2) Steel Tube Connectors and Hardware	AM1014725	\$ 214.00	
Platforms: 2142, 2152, 2162	Draper Belt Repair Kit For 41.60" Belt Includes 34" Repair Section of RAPTOR Material Pre-Punched for Connector, (2) Steel Tube Connectors and Hardware	AMX27266	\$ 214.00	
Platforms: 3152, 3162	Draper Belt Repair Kit For 41.60" Belt Includes 34" Repair Section of RAPTOR Material, Pre-Punched for Connector, (2) Steel Tube Connectors and Hardware	AM1014727	\$ 214.00	
Platforms: 2142, 2152, 2162	Steel Tube Connector Set For 41.60" Belts 39.80" Long Includes (2) Steel Tube Connectors and Hardware	AM1002377	\$ 56.00	
Platforms: Most Models	Steel Tube Connector 10 Holes, 38.78" Long	AM1005840	\$ 56.00	



Case IH®—Combine









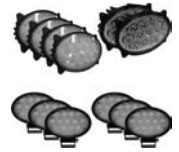

Poly Skid Plate Kits and Components

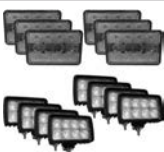
Application	Description	Part Number	Retail Price	Core
Platform: 820	Poly Skid Plate Kit	13' CS13IH	\$ 470.00	
		15' CS15IH	\$ 530.00	
		16.50' CS16.5IH	\$ 540.00	
		17.50' CS17.5IH	\$ 565.00	
		20' CS20IH	\$ 605.00	
		22.50' CS22.5IH	\$ 770.00	
Platform: 1020	Poly Skid Plate Kit	15' CS15IHNA	\$ 590.00	
		17.50' CS17.5IHNA	\$ 640.00	
		20' CS20IHNA	\$ 700.00	
		22.50' CS22.5IHNA	\$ 775.00	
		25' CS25IHNA	\$ 867.00	
Platforms: 2142, 2152, 2162	Poly Skid Plate, Right End Replaces 87561542	AM165386	\$ 51.00	
	Poly Skid Plate, Left End Replaces 87561540	AM165188	\$ 51.00	
	Poly Skid Plate, Center Replaces 47414657, 87561539	AM165208	\$ 61.00	
	Poly Skid Plate Transition Pan (4) Required Replaces 87597512	AM151551	\$ 46.00	
Draper Platforms: 2062, 2142, 2152, 2162	Poly Skid Plate, Cutterbar	AM87532221	\$ 10.50	
Platforms: 1020, 2020, 3020, 3152, 3162	Skid Shoe	AM377580A1	\$ 9.00	
Platform: 1020 ASN CBJ023001	Inner Runner Support	AM392423A3	\$ 250.00	





Lighting

Application	Description	Part Number	Retail Price	Core
 5088, 6088, 7088, 7120, 7130, 7230, 8010, 8120, 8230, 9120, 9130, 9230 - Early Models w/ 6 Lights on Top of the Cab	LED Floodlight Kit (4) Outer Cab Lights*, (2) Center Cab Lights*, (2) Stubble Lights** Includes Connectors and Mounting Hardware Uses Original Mount and Wiring *6000 Lumens, 65 Watts, 5.40 Amps **2900 Lumens, 35 Watts, 2.90 Amps	AMX34187	\$ 966.00	
 2144, 2166, 2188, 2344, 2366, 2377, 2388, 2577, 2588	LED Floodlight/Spotlight Combo Kit Includes (2) Center Hi/Lo Beams, (4) Outer High Beams and Mounting Hardware 4" x 6" Rectangle Combo Lights Each Light is 3500 Lumens, 60 Watts, 5 Amps For 12 to 24 Volt Systems Direct Replacement, Plug-and-Play	AMX34188	\$ 599.00	
 5088, 6088, 7010, 7088, 7120, 7130, 7230, 8010, 8120, 8230, 9120, 9130, 9230	LED Light Kit Includes (2) LED Center Headlights, Hi/Lo Beam*, (4) LED Outer Headlights*, (6) LED Work Lights**, Connectors and Mounting Hardware For 12 Volt to 24 Volt Systems Plug-and-Play Installation *6000 Lumens, 65 Watts, 5.40 Amps **2900 Lumens, 35 Watts, 2.90 Amps	AMX34174	\$ 1344.00	









Case IH®—Combine

Application	Description	Part Number	Retail Price	Core
 2144, 2166, 2188, 2344, 2366, 2377, 2388, 2577, 2588	LED Light Kit Includes (2) LED Center Headlights*, (4) LED Outer Headlights* and (8) LED Work Lights** For 12 Volt to 24 Volt Systems Plug-and-Play Installation *3500 Lumens, 60 Watts, 5 Amps **3600 Lumens, 40 Watts, 3.30 Amps	AMX34155	\$ 1286.00	
 Titan Floaters: 3020, 3040, 3540, 4020, 4030, 4040, 4520, 4530, 4540, Sprayers: 3320, 4420, SPX4260, SPX4410	LED Headlight, Right Hand 5300 Lumens, 70 Watts, 5.80 Amps For 12 Volt to 24 Volt Systems Includes Stainless Steel Hardware Replaces 232450A2, 365841A1, 87429390	AM232448A2	\$ 189.00	
	LED Headlight, Left Hand 5300 Lumens, 70 Watts, 5.80 Amps For 12 Volt to 24 Volt Systems Includes Stainless Steel Hardware Replaces 232451A2, 365842A1, 87429389	AM232449A1	\$ 189.00	
 Sprayers: 3320, 4420, SPX4260, SPX4410	LED Headlight, Center 4.25" x 10.50" Rectangle Light 7200 Lumens, 108 Watts, 9 Amps For 12 Volt to 24 Volt Systems Replaces 232454A2, 232455A2	AMTL6010	\$ 184.00	
 Universal Equipment	LED Floodlight All-Position Light 4.25" x 4.25" Square Light 2650 Lumens, 48 Watts, 4 Amps For 12 Volt to 24 Volt Systems Includes Mounting Bracket and Stainless Steel Hardware	AMTL105F	\$ 74.00	
 Universal Equipment	LED Floodlight All-Position Light 6.25" x 1.75" Rectangle Light 1300 Lumens, 18 Watts, 1.50 Amps For 12 Volt to 24 Volt Systems Includes Mounting Bracket and Stainless Steel Hardware	AMTL118F	\$ 53.00	
 Universal Equipment	LED Floodlight All-Position Light 5" Round Light 3200 Lumens, 40 Watts, 3.30 Amps For 12 Volt to 24 Volt Systems Includes Mounting Bracket and Stainless Steel Hardware	AMTL180	\$ 95.00	
 Universal Equipment	LED Floodlight All-Position Light Round Light 6900 Lumens, 50 Watts, 4.10 Amps For 9 Volt to 32 Volt Systems Includes Mounting Bracket and Stainless Steel Hardware	AMTL500F	\$ 126.00	
	LED Floodlight All-Position Light 4.30" Round Light 5040 Lumens, 50 Watts, 4.10 Amps For 12 Volt to 24 Volt Systems Includes Stainless Steel Adjustable Mounting Bracket	AMAT305931	\$ 113.00	
 Universal Equipment	LED Floodlight All-Position Light 4.25" Round Light 2650 Lumens, 42 Watts, 3.50 Amps For 12 Volt to 24 Volt Systems Includes Mounting Bracket and Stainless Steel Hardware	AMTL115F	\$ 62.00	

Case IH®—Combine





Application	Description	Part Number	Retail Price	Core
 Universal Equipment	LED Wide Floodlight All-Position Light 5" x 7" Rectangle Light 3800 Lumens, 35 Watts For 12 Volt to 24 Volt Systems Replaces 47682629, 47682620, 84236850, 87555142, 87584890	AMX34171	\$ 60.00	
 Universal Equipment	LED Floodlight, Sealed Beam Fender Mount 4.50" Diameter Round Light 1250 Lumens, 18 Watts, 1.50 Amps Trapezoid Pattern For 12 Volt to 24 Volt Systems Replaces 131203C1, 373662R1, 373662R91	AMTL3010	\$ 42.00	
	LED Floodlight Fender Mount 4.50" Diameter Sealed Beam Round Light 1250 Lumens, 18 Watts, 1.20 Amps Trapezoid Pattern For 12 Volt to 24 Volt Systems Lasts 50 times longer than halogen lighting, vibration resistant w/ no filament failures, uses original mount and wiring, Operating temperature of -40°F to 140°F / -40°C to 60°C Replaces 131203C1, 373662R1, 373662R91	AMRE336111	\$ 37.00	
 Universal Equipment	LED Floodlight Fender Mount 4.50" Diameter Sealed Beam Round Light 1440 Lumens, 18 Watts, 1.60 Amps Lasts 50 times longer than halogen lighting, vibration resistant w/ no filament failures, 2-terminal connection, Operating temperature of -40°F to 140°F / -40°C to 60°C Replaces 131203C1	AMRE336112	\$ 68.00	
 Floaters: 3520, 4020, 4520, FLX3010, FLX3510, FLX4010, FLX4510, Patriot Sprayer: 4420, Sprayer: SPX4410 Replaces 92263C1, 178345A1, 180097A1, 275335A1, 305256A1, 1983210C1, 87435762, 87773385	LED Floodlight Lower Front, Cab, Fender and ROPS 6" x 3.50" x 6" Rectangle Light 3600 Lumens, 40 Watts, 3.30 Amps For 12 Volt to 24 Volt Systems Includes Connector, Plug-and-Play	AMTL3030	\$ 94.00	
	LED Floodlight Lower Front, Cab, Fender and ROPS 6" x 3.50" x 6" Rectangle Light 3600 Lumens, 40 Watts, 3.30 Amps For 12 Volt to 24 Volt Systems Includes Connector, Plug-and-Play	AM92269C1	\$ 84.00	
 5088, 6088, 7088, 7120, 7130, 7230, 8010, 8120, 8230, 9120, 9130, 9230 Replaces 87106352, 87106354	LED Floodlight Hood Mount 6.50" x 4.50" x 4" Oval Light Dual Hi/Lo Beam 6000 Lumens, 65 Watts, 5.40 Amps For 12 Volt to 24 Volt Systems Uses Original Mount and Wiring, Plug-and-Play	AMTL8520S	\$ 131.00	

Case IH®—Combine









Application	Description	Part Number	Retail Price	Core
 <p>2166, 2188, 2366, 2377, 2388, 2577, 2588 Replaces 138225A1, 183162A1, 353656A1, 353657A1, 87368623</p>	<p>LED Floodlight Cab Mount 4" x 6.50" Rectangle Light High Beam 3500 Lumens, 60 Watts, 5 Amps For 12 Volt to 24 Volt Systems Includes Connector, Plug-and-Play</p>	AMTL6080	\$ 104.00	
	<p>LED Floodlight Grille Mount 4" x 6.50" Rectangle Light High Beam 3500 Lumens, 60 Watts, 5 Amps For 12 Volt to 24 Volt Systems Includes Connector, Plug-and-Play</p>	AM353656A1	\$ 93.00	
 <p>5088, 6088, 7088, 7120, 7130, 7230, 8010, 8120, 8230, 9120, 9230, Cotton Picker: 625 Module Express</p>	<p>LED Floodlight Cab Mount 6.50" x 4.50" x 4" Oval Light 6000 Lumens, 65 Watts, 5.40 Amps For 12 Volt to 24 Volt Systems Uses Original Mount and Wiring, Plug-and-Play Replaces 87106353</p>	AMTL8420	\$ 131.00	
 <p>Universal Equipment</p>	<p>LED Floodlight Cab and Fender Mount 3.50" x 6" Rectangle Light 3600 Lumens, 40 Watts, 3 Amps</p>	AMX34146	\$ 65.00	
 <p>2388, 5130, 5140, 6130, 6140, 7010, 7130, 7140, 7230, 7240, 7250, 8010, 8120, 8230, 8240, 8250, 9010, 9120, 9230, 9240, 9250, AFX8010 Replaces 870001315, 87284332, 87584890</p>	<p>LED Floodlight 5.75" x 3.75" x 3" Oval Light 2900 Lumens, 35 Watts, 2.90 Amps For 12 Volt to 24 Volt Systems Includes Stainless Steel Mounting Hardware and Mounting Bracket</p>	AMTL5655	\$ 100.00	
 <p>2144, 2166, 2188, 2344, 2366, 2377, 2388, 2577, 2588, Cotton Pickers: 420, 625, CPX420, CPX610, CPX620</p>	<p>LED Floodlight/Spotlight Cab Mount 4" x 6.50" Rectangle Light Dual Hi/Lo Beam 3500 Lumens, 60 Watts, 5 Amps For 12 Volt to 24 Volt Systems Replaces 138225A1, 183162A1, 353657A1, 87367623</p>	AMTL6090	\$ 104.00	
	<p>LED Floodlight/Spotlight Cab Mount 4" x 6.50" Rectangle Light Dual Hi/Lo Beam 3500 Lumens, 60 Watts, 5 Amps For 12 Volt to 24 Volt Systems Replaces 138225A1, 183162A1, 353657A1</p>	AM87367623	\$ 93.00	
 <p>5140, 6140, 7140, 7230, 8230, 8240, 9230, 9240 Replaces 47430977, 47430979</p>	<p>LED Floodlight/Spotlight Combo Upper Cab Mount 6" x 3" x 3.25" Oval Light 3200 Lumens, 40 Watts, 3.30 Amps For 12 Volt to 24 Volt Systems Uses Original Hardware, Plug-and-play Plastic Bezel Not Included</p>	AMTL8050	\$ 100.00	
 <p>Universal Equipment</p>	<p>LED Spotlight All-Position Light 4.25" x 4.25" Square Light 1400 Lumens, 27 Watts, 2.20 Amps For 12 Volt to 24 Volt Systems</p>	AMTL100S	\$ 47.00	
 <p>Universal Equipment</p>	<p>LED Spotlight All-Position Light 6.25" x 1.75" Rectangle Light 1300 Lumens, 18 Watts, 1.50 Amps For 12 Volt to 24 Volt Systems Includes Mounting Bracket and Stainless Steel Hardware</p>	AMTL118S	\$ 53.00	

Prices Subject to Change without Prior Notice. The use of original equipment manufacturer (OEM) part numbers or trademarks, e.g. Case® and John Deere®, are for reference purposes only and for indicating product use and compatibility. Our company and the listed replacement parts contained herein are not sponsored, approved or manufactured by the OEM. All parts are New unless designated Reman in the description.



Case IH®—Combine

Application	Description	Part Number	Retail Price	Core
 Universal Equipment	LED Spotlight All-Position Light Round Light 6900 Lumens, 50 Watts, 4.10 Amps For 9 Volt to 32 Volt Systems Includes Mounting Bracket and Stainless Steel Hardware	AMTL500S	\$ 126.00	
 5088, 5140, 6088, 6140, 7088, 7120, 7130, 7140, 7230, 8010, 8120, 8230, 8240, 9120, 9130, 9230, 9240 Replaces 87584890	LED Conversion Light Stubble Light 5.75" x 3.75" Oval Light 2900 Lumens, 35 Watts, 2.90 Amps For 12 Volt to 24 Volt Systems Includes Bracket and Connectors	AMTL5650	\$ 100.00	
	LED Conversion Light Stubble Light 5.75" x 3.75" Oval Light 2900 Lumens, 35 Watts, 2.90 Amps For 12 Volt to 24 Volt Systems Includes Bracket and Connectors	AMAH207788	\$ 90.00	
 Universal Equipment	LED Trapezoid Light Cab and Fender Mount 4.50" Diameter Round Light 2800 Lumens, 40 Watts, 3.30 Amps Trapezoid Pattern For 12 Volt to 24 Volt Systems Bottom Mount w/ Built-In Heat Sink Includes Mounting Bracket, Long and Short Rubber Bezels, and Stainless Steel Hardware Replaces 131368C92	AMTL2080	\$ 100.00	
	LED Trapezoid Light Cab and Rear Fender Mount 4.50" Diameter Round Light 2800 Lumens, 40 Watts, 3.30 Amps Trapezoid Pattern For 12 Volt to 24 Volt Systems Bottom Mount w/ Built-In Heat Sink Includes Mounting Bracket, Long and Short Rubber Bezels and Stainless Steel Hardware Replaces 131368C92	AMX33121	\$ 90.00	
 Universal Equipment	LED Warning Light Cab, Header or Swather Mount Can be used for Turn Signal, Brake or Running Lights 4.125" Diameter Round Light Double Sided, Amber Lenses 25 Bulbs per Side For 12 Volt to 24 Volt Systems	AMTLFL2	\$ 58.00	
	LED Warning Light Cab, Header or Swather Mount Can be used for Turn Signal, Brake or Running Lights 4.125" Diameter Round Light Double Sided, Amber Lenses 25 Bulbs per Side For 12 Volt to 24 Volt Systems	AMX1910149	\$ 52.00	







Case IH®—Combine

	Application	Description	Part Number	Retail Price	Core
	Universal Equipment	LED Warning Light Cab, Header or Swather Mount Can be used for Turn Signal, Brake or Running Lights 4.125" Diameter Round Light Double Sided, Red and Amber Lenses 25 Bulbs per Side For 12 Volt to 24 Volt Systems	AMTLFL3	\$ 58.00	
		LED Warning Light Cab, Header or Swather Mount Can be used for Turn Signal, Brake or Running Lights 4.125" Diameter Round Light Double Sided, Red and Amber Lenses 25 Bulbs per Side For 12 Volt to 24 Volt Systems	AMX33126	\$ 52.00	
	Universal Equipment	LED Magnetic Warning Light All-Position Light 360° Flashing Light, Multiple Patterns 9.50" x 6.75" Rectangle Light Magnetic Base or Solid Mount For 12 Volt to 24 Volt Systems Includes Cigarette Lighter Adapter, Wiring and Switch	AMTL1100	\$ 179.00	
	Universal Equipment	LED Magnetic Warning Light All-Position Light 360° Flashing Light, Multiple Patterns 14" x 6.75" Rectangle Light Magnetic Base or Solid Mount For 12 Volt to 24 Volt Systems Includes Cigarette Lighter Adapter, Wiring and Switch	AMTL1200	\$ 200.00	
	Universal Equipment	Warning Beacon 360° Flashing Beacon, Amber Lens For 0.9435" Diameter Pipe Replaces 84337818, AZ44705, AZ101891	AM82018390	\$ 52.48	
	Universal Equipment	LED Warning Beacon 360° Flashing Beacon 2.75" x 5.25" Light Polycarbonate Amber Lens and Housing For 12 Volt to 24 Volt Systems Includes Solid Mounting Pad and Stainless Steel Hardware	AMTL2100	\$ 32.00	
	Universal Equipment	LED Warning Beacon 360° Flashing Beacon, 3 Different Patterns 5" x 10" Light Amber Lens, 48 Watts, 4 Amps For 12 Volt to 24 Volt Systems Brackets Sold Separately	AMX33131	\$ 79.00	
	Universal Equipment	Warning Beacon Bracket	AMX33132	\$ 16.00	
	Universal Equipment	Warning Beacon Bracket	AMX33133	\$ 16.00	
	Universal Equipment	Warning Beacon Bracket	AMX33137	\$ 16.00	

Case IH®—Combine

Application	Description	Part Number	Retail Price	Core
 Universal Equipment	Warning Beacon Bracket	AMX33135	\$ 16.00	
 Universal Equipment	LED Light Bar 4" Long, 1260 Lumens, Cree Bulbs	AMLED4	\$ 45.00	
	LED Light Bar Flood/Spotlight Combo 10" Long, 5700 Lumens, 50 Watts, 4.20 Amps For 12 Volt to 24 Volt Systems Includes Mounting Bracket and Stainless Steel Hardware	AMTL10SRC	\$ 135.00	
	LED Light Bar Floodlight/Spotlight Combo 14" Long, 5400 Lumens, 72 Watts, 6 Amps Die Cast Aluminum Housing, Polycarbonate Lens For 12 Volt to 24 Volt Systems Includes Mounting Bracket and Heavy Duty Stainless Steel Hardware	AMTLB410C	\$ 158.00	
	LED Light Bar Floodlight/Spotlight Combo 30" Long, 13600 Lumens, 150 Watts, 12.50 Amps For 12 Volt to 24 Volt Systems Includes Mounting Bracket and Stainless Steel Hardware	AMTL30SRC	\$ 242.00	
	LED Light Bar 30" Long, 13860 Lumens, Cree Bulbs	AMLED30	\$ 130.00	
	LED Light Bar Floodlight/Spotlight Combo 40" Long, 17300 Lumens, 200 Watts, 16.70 Amps For 12 Volt to 24 Volt Systems Includes Mounting Brackets and Stainless Steel Hardware	AMTL40SRC	\$ 315.00	
	LED Light Bar 40" Long, 18200 Lumens, Cree Bulbs	AMLED40	\$ 160.00	
	LED Light Bar Floodlight/Spotlight Combo 42" Long, 14500 Lumens, 240 Watts, 19 Amps For 12 Volt to 24 Volt Systems Includes Mounting Bracket and Stainless Steel Hardware Replaces 1163691	AMTLB440C	\$ 291.00	
	LED Light Bar, Curved 50" Long, 21500 Lumens, Cree Bulbs	AMLED50C	\$ 194.00	
 Patriot Sprayers: 3230, 3240, 3330, 3340, SPX3320	LED Front Corner Light w/ Work Light, Right Hand Corner Light: Amber Lens, 17 Watts, 2.40 Amps, Built-in Resistor (12 Watts) Work Light: Floodlight, 3300 Lumens, 30 Watts, 3.30 Amps For 12 Volt to 24 Volt Systems Plug-and-Play for Direct Replacement Replaces 279220A1	AMTL6120R	\$ 126.00	
	LED Front Corner Light w/ Work Light, Left Hand Corner Light: Amber Lens, 17 Watts, 2.40 Amps, Built-in Resistor (12 Watts) Work Light: Floodlight, 3300 Lumens, 30 Watts, 3.30 Amps For 12 Volt to 24 Volt Systems Plug-and-Play for Direct Replacement Replaces 279219A1	AMTL6120L	\$ 126.00	

Case IH®—Combine

Application	Description	Part Number	Retail Price	Core
 Patriot Sprayers: 3230, 3240, 3330, 3340, SPX3320	LED Rear Corner Light, Left Hand Amber Lens, 17 Watts, 2.40 Amps Built-In Resistor, 12 Watts For 12 Volt to 24 Volt Systems Plug-and-Play for Direct Replacement	AM279224A1	\$ 63.00	
	LED Rear Corner Light, Right Hand Amber Lens, 17 Watts, 2.40 Amps Built-In Resistor, 12 Watts For 12 Volt to 24 Volt Systems Plug-and-Play for Direct Replacement	AM279223A1	\$ 63.00	
 2144, 2166, 2188, 2344, 2366, 2377, 2388, 2577, 2588, Cotton Pickers: 420, 2155, 2555, CPX420	LED Work Light 6" x 3.50" x 3" Rectangle Floodlight 3600 Lumens, 40 Watts, 3.30 Amps For 12 Volt to 24 Volt Systems Uses Original Mount and Wiring	AMTL3035	\$ 95.00	
 Universal Equipment	LED Magnetic Work Light All-Position Light 3.25" Square Floodlight 900 Lumens Magnetic Base Includes Lithium Ion Battery, Cigarette Lighter and DC Charger	AMTL2460	\$ 83.00	
 Universal Sprayers	LED Blue Work Light 4.25" x 4.50" x 3.00" Rectangle Light 2650 Lumens, 42 Watts, 3.50 Amps For 12 Volt to 24 Volt Systems Includes Stainless Steel Hardware and Mounting Bracket	AMTLFL5	\$ 62.00	
 7120, 7230, 7240, 8120, 8230, 8240, 9120, 9230, 9240	Light Switch, Work Light	AM87603462	\$ 39.00	
 5130, 5140, 6130, 6140, 7130, 7140, 7230, 7240, 8230, 8240, 9230, 9240	Switch, Road Mode	AM84380254	\$ 40.00	

Cab Components—Miscellaneous

Application	Description	Part Number	Retail Price	Core
2366, 2377, 2388, 7010, 7120, 8010, 8120, 9010, 9120	Reman AFS Display Monitor Universal Display Plus Monitor (2) Data Card Ports located on Left Hand Side of Monitor and (2) Electrical Ports located on Bottom of Monitor	AM295133A3	\$ 1650.00	\$ 500.00
(2377, 2388 SN HAJ292001-HAJ300000)	Reman Monitor Replaces 293255A3, 295133A5, 87668610	AM84604338R	\$ 1650.00	\$ 500.00















Steering Arms

Application	Description	Part Number	Retail Price	Core
1420, 1440, 1460, 1620, 1640, 1644, 1660, 1666, 2144, 2166, 2344 BSN JJC0174359, 2366 BSN JJC0252949	Steering Arm	Right Hand	AM193912C3	\$ 184.28
		Left Hand	AM193911C4	\$ 227.69
Cotton Harvester: 1800, Cotton Pickers: 420, 1822, 1844, 2022, 2055, 2155, 2555, CPX420	Steering Arm 36 Tooth	Right Hand	AM1259527C2	\$ 102.11
		Left Hand	AM1259526C2	\$ 120.13



Case IH®—Combine

Application	Description	Part Number	Retail Price	Core
Cotton Pickers: 1822, 2022	Steering Arm 24 Tooth	Right Hand AM148419C1	\$ 144.53	
		Left Hand AM148418C1	\$ 103.21	

Tie Rods and Components

Application	Description	Part Number	Retail Price	Core
 815, 915, 1420, 1440, 1460, 1620, 1640, 1660	Tie Rod 3.75" Long 1.00"x16 UN Right Hand External Thread	AM379551R92	\$ 62.86	
 1440, 1460, 1640, 1644, 1660, 1666, 2144, 2166, 2344, 2366	Tie Rod 3.87" Long, 1" Diameter 16 Right Hand Thread	AM1302687C1	\$ 27.00	
 1440, 1460, 1640, 1644, 1660, 1666, 2144, 2166, 2344, 2366	Tie Rod, Left Hand 9 Holes 40" Long, 1.187" Diameter	AM1302686C1	\$ 104.00	
 1460 Rice, 1480, 1660, 1666, 1680, 1688, 2166, 2188, 2344, 2366, 2388	Tie Rod, Left Hand 9 Holes in Side 45.50" Long, 1.50" Diameter	AM359774A1	\$ 128.00	
 1620, 1640, 1644, 1660, 1666, 1680, 1688, 2144, 2166, 2188, 2344, 2366, 2388, 2588 - w/ Power Guide Axle	Tie Rod 4.87" Long, 1.125" Diameter 12 UNF Right Hand Thread	AM1968998C1	\$ 46.00	
 1640, 1644, 1660, 1666, 1680, 1688, 2144, 2166, 2188, 2344, 2366, 2377 SN HAJ292001-HAJ300000, 2388, 2577 ASN HAJ300001, 2588 ASN HAJ300001	Outer Tie Rod Tube	AM1970102C1	\$ 408.51	
 1680, 1688, 2188, 2366 BSN JJC025949, 2388 BSN JJC0276540 - 2WD	Tie Rod 4" Long, 1" Diameter Right Hand Thread	AMA43376	\$ 22.00	
 2344, 2366, 2377, 2388	Tie Rod 5.50" Long, 1.125" Diameter 12 Right Hand Thread	AM86984112	\$ 55.00	
 2344, 2366, 2377, 2388	Ball Joint	AM437222A1	\$ 92.00	
 2366, 2377 SN HAJ292001-HAJ300000, 2388 ASN JJC076540, 2577, 2588	Tie Rod 33.75" Long, 1.50" Diameter	AM86984111	\$ 181.77	
 2377 SN HAJ292001-HAJ300000, 2388	Inner Tie Rod Tube 15 Holes 33.00" Long, 1 1/8" Diameter 12 Right Hand Thread Replaces 361408A1	AM87012417	\$ 218.05	
 7010, 7120, 7230, 7240, 8010, 8120, 8230, 8240, 9120, 9230, 9240, AFX8010	Tie Rod 4.75" Long M30x1.50" Right Hand Thread Replaces 84073399	AM84442906	\$ 47.00	
 7010, 7120, 7230, 7240, 8010, 8120, 8230, 8240, 9010, 9120, 9230, 9240, AFX8010	Tie Rod Tube, Right Hand	AM84074074	\$ 340.00	
 Cotton Pickers: 420 09/2006-10, 420 03/2008 and Later Tier 3, 1844 ASN JJC0002461 07/1989-93, 1844 1988-93 w/ Navistar® Engine, (2022, 2044 - 1991-94), 2055 1997-2005, 2155 02/1995-96, CPX420 05/2005-08/06	Tie Rod Tube 17.06" Long	AM1280657C1	\$ 30.00	

Case IH®—Combine

	Application	Description	Part Number	Retail Price	Core
	Cotton Pickers: 1844 ASN JJC0002461, 1844 w/ Navistar® Engine, 2022, 2044, 2055, 2155, 2555	Tie Rod 4.10" Long, 1.125" Diameter 12 Right Hand Thread	AM1280658C1	\$ 27.00	
	Cotton Pickers: 1844 ASN JJC0002461, 1844 w/ Navistar® Engine, 2022, 2044, 2055, 2155, 2555	Tie Rod 7 Holes, 15.275" Long, 1.185" Diameter	AM1280662C1	\$ 36.00	

Power Steering Cylinders and Components





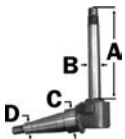

Application	Description	Part Number	Retail Price	Core
815, 915, 1420, 1440, 1460, 1480, 1620, 1640, 1644, 1660, 1666, 1670, 2144, 2166, 2344, 2366, Cotton Picker: 95 - All w/o Power Guide Axle	Power Steering Cylinder 2" ID, 9 Stroke Replaces 157422C91	AM548247R91	\$ 495.00	
1420, 1460, 1480, 1620 ASN JJC0032630, 1640, 1644, 1660, 1666, 1680 BSN JJC0045689, 2144, 2166, 2344, 2366, 2377 ASN HAJ292001, 2388, 2588 ASN HAJ30001 - w/ Power Guide Axle	Power Steering Cylinder 2.25" ID, 9 Stroke Replaces 127913C91	AM87337229	\$ 291.00	
5088, 5130, 5140, 6088, 6130, 6140, 7088, 7130, 7140 - w/ Standard Steering	Power Steering Cylinder Replaces 87519431	AM87674051	\$ 750.00	
6130, 6140 - w/ Auto-Guide Steering	Power Steering Cylinder	AM84385653	\$ 2900.00	
7230, 7240, 8230, 8240, 9230, 9240	Power Steering Cylinder 36 mm Rod Diameter, 330 mm Stroke Replaces 84448270, 87387458, 717582006	AM84370626	\$ 1440.00	
1420, 1440, 1460, 1620, 1640, 1660, 2144, 2166, 2344, 2366	Power Steering Cylinder End 2.75" Long M22x1.50" Right Hand Thread	AM186796C1	\$ 51.00	
(1420, 1460, 1480, 1620, 1640, 1644, 1660, 1666, 1680, 1688, 2144, 2166, 2188, 2344, 2366, 2388 BSN JJC00272999 - w/ Power Guide Axle), (1680, 1688, 2188, 2344 SN JJC0174400-JJC017449, 2366 SN JJC0254000-JJC02549999, 2388 BSN JJC0270499 - w/ Adjustable Axle)	Power Steering Cylinder End	AM186140C91	\$ 47.00	
7010, 7120, 7230, 7240, 8010, 8120, 8230, 8240, 9120, 9230, 9240, AFX8010	Power Steering Cylinder End 3.75" Long M16x1.50" Right Hand Thread Replaces 84073454	AM84814042	\$ 55.00	
Cotton Pickers: 1822 ASN 12691, 2022 BSN 13388	Power Steering Cylinder Replaces Late Style Cylinder w/ Tie Rod End, Tie Rod End Not Included	AM63864C91	\$ 310.00	
1460, 1480, 1660, 1666, 1680, 1688, 2166, 2188, 2344 ASN JJC0174360 w/o Power Guide Axle, 2366 ASN JJC0252949, 2377 ASN HAJ0292001, 2388 BSN JJC0270500 & ASN HAJ0292001, 2577	Power Steering Cylinder Support Replaces 133319A1	AM316945A1	\$ 210.81	
7010, 7120, 7230, 7240, 8010, 8120, 8230, 8240, 9010, 9120, 9230, 9240, AFX8010	Power Steering Cylinder Seal Kit For Auto-Guidance Enabled Steering Cylinder	AM84455606	\$ 160.00	

Spindles

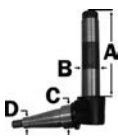
Application	Description	Part Number	Retail Price	Core
 1420, 1440, 1460, 1620*, 1640, 1644, 1660, 1666, 2144, 2166, 2344 BSN JJC0174360, 2366 BSN JJC00252949 - w/o Power Guide Axle *w/ 11x16, 12.40x16 or 11.20x24 Tires	Spindle, Right or Left Hand Replaces 1315374C1, 1315374C91 A - 12.50 B - 1.671 C - 2.6245 D - 1.6875	AM1315374C2	\$ 595.57	

Case IH®—Combine

Application	Description	Part Number	Retail Price	Core
 Cotton Pickers: 420, CPX420	Spindle Replaces 1259519C2, 1259519C92, 86503132, 87773201 A - 12.00 B - 2.499 C - 2.624 D - 1.687	AM1259519C3	\$ 478.17	
 1420, 1480, 1660, 1666, 1680, 1688, 2166, 2188, 2344 ASN JJC0174360, 2366 ASN JJC0252950, 2377 ASN HAJ0292001, 2388	Steering Knuckle King Pin 20" Long	AM186052C1	\$ 128.00	
 1460, 1480, 1660, 1666, 1680, 2166, 2188, 2344, 2366, (2377, 2388 SN HAJ292001-HAJ300000), 2577, 2588	Spindle Bushing	AM186680C1	\$ 20.00	
 Cotton Pickers: 1800, 1844, 2022, 2044, 2055, 2155, 2555, CPX420 - w/ Adjustable Axle w/o Guide Power	Spindle Bushing	AM1259518C1	\$ 36.23	

Wheel Hubs



Application	Description	Part Number	Retail Price	Core
(2377, 2388 SN HAJ292001-HAJ300000), 2577, 2588	Rear Axle Hub Assembly, HD Replaces 427351A1	AM87307670	\$ 265.13	
1822, 1844, 2022, 2044	Wheel Hub, 8-Bolt	AM391824R11	\$ 92.00	
1620, 1640, 1644, 1660, 1666, 2144, 2166, 2344, 2366, Cotton Harvester: 1800, Cotton Pickers: 420, 1844, 2022, 2044, 2055, 2155, CPX420	Wheel Hub, 8-Bolt	AM1259528C1	\$ 332.50	
(2377, 2388 SN HAJ292001-HAJ300000), 2577, 2588 - w/ 92"-120" Adjustable Axle	Wheel Hub, 8-Bolt	AM87307671	\$ 202.11	



Axle Center Tubes

Application	Description	Part Number	Retail Price	Core
Rotary Combines w/ Heavy Duty Axle	Axle Center Tube 56" Long, 4.50" Between Holes For 92"-122" Rear Axle	AMIHCCT45	\$ 1650.00	
	Axle Center Tube 56" Long, 5" Between Holes For 92"-122" Rear Axle	AMIHCCT50	\$ 1683.00	
1640, 1644, 1660, 1666, 1680, 1688, 2144, 2166, 2188, 2344, 2366, 2388 w/ Single Steering Cylinder	Axle Center Tube 63.50" Long, 3.25" Space Back For 108"-144" Rear Axle	AM1968991C1	\$ 1581.00	
1440, 1460, 1480, 1640, 1644, 1660, 1666, 1680, 1688, 2144, 2166, 2188, 2344, 2366, 2377, 2388	Axle Pivot w/ Bushings	AM186599C94	\$ 375.00	
815 ASN 8001, 915 ASN 8001, 1420, 1440, 1460, 1470, 1480, 1620, 1640, 1644, 1660, 1666, 1670, 1680, 1688, 2144, 2166, 2188, 2344, 2366, 2377 SN HAJ292001- HAJ300000, 2388 BSN JJC0276540, 2577, 2588, Cotton Pickers: 782, 1822, 1844, 2022, 2044, 2055	Bushing, Axle Pivot 1.47" Wide, 4.01" ID, 4.195" OD	AM177751C1	\$ 23.00	
1440, 1460, 1480, 1640, 1644, 1660, 1666, 1680, 1688, 2144, 2166, 2188, 2344, 2366, 2377, 2388, 2577, 2588	Bushing, Rear Axle Pivot 0.736" Wide, 4" ID, 4.178" OD	AM182794C1	\$ 26.25	
(1420, 1440, 1460, 1480, 1640 BSN JJC0034001, 1660 BSN JJC0036301, 1680 BSN JJC0044001 - w/ Power Guide Rear Axle)	Thrust Washer	AM890477C1	\$ 12.00	

Case IH®—Combine

Application	Description	Part Number	Retail Price	Core
Cotton Pickers: 1822, 2022	Pivot Pin Bushing, Rear 1.06" Long, 1.256" ID, 1.377" OD	AM482669R1	\$ 22.10	

Weight Brackets



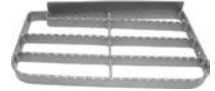

Application	Description	Part Number	Retail Price	Core
1640, 1644, 1660, 1680, 2144, 2166, 2188, 2344 BSN JJC0174398, 2388 BSN JJC0290499	Weight Bracket Replaces 185365C1, 185365C3	AM193440A3	\$ 445.00	
2377, 2388, 2577, 2588	Weight Bracket	AM431785A1	\$ 530.00	



Steps

Application	Description	Part Number	Retail Price	Core
2144, 2166, 2188, 2344, 2366 BSN 0256605, 2388 BSN 0275338	Steel Step Replaces all steps on combine applications	AM97050C3	\$ 61.00	
Cotton Pickers: 2555 ASN JJC0249500, CPX420, CPX610	Step	AM257375A1	\$ 41.00	
2344, 2366, 2377, 2388, 2577, 2588	Bottom Step Support, Rubber Hardware not included	AM87301176	\$ 29.73	

Glass

Application	Description	Part Number	Retail Price	Core
 2144, 2166, 2188, 2344, 2366, 2377, 2388, 2577, 2588, 5088, 6088, 7088, Cotton Pickers: 420, 620, 625, 2555, CPX420, CPX610	Windshield Replaces 116809A3, 116809A4	AM116809A2	\$ 774.40	
Patriot Sprayers: 3230, 3240, 3330, 3340, SPX3320	Cab Glass, Right Hand Replaces 242536A5, 87773671	AM87417671	\$ 800.00	
 Patriot® Sprayers: 3230, 3240, 3330, SPX3320	Rear Glass Tinted Replaces 242667A4	AM87309738	\$ 320.00	
 Swathers: 8860, 8860HP, 8870, 8880, 8880HP	Weatherstrip 176" Long For Front Cab Windshield	AM1990761C2	\$ 30.00	
 2144, 2166, 2188, Cotton Pickers: 2155, 2555	Weatherstrip 176" Long For Cab Door, Right and Left Hand	AM1990761C2	\$ 30.00	
Sprayer: 3320 11/2006-12/08	Weatherstrip For Cab Door	AM87534532	\$ 24.00	
Sprayers: 3320 2009 and Later, 3330	Weatherstrip For Cab Door	AM84160023	\$ 23.10	
 Sprayer: 3320 11/2006-12/08	Weatherstrip For Rear Cab Window	AM87534532	\$ 24.00	



Case IH®—Combine















Gas Struts

Application	Description	Part Number	Retail Price	Core
2366, 2377, 2388, 2577, 2588, 5088, 6088, 7088	Gas Strut, Engine Cover	AM446346A1	\$ 36.00	
7010, 7120, 7230, 8010, 8120, 8230, 9120, 9230	Gas Strut, Bumper	AM84334242	\$ 20.00	
2144, 2166, 2188, 2344, 2366, 2377, 2388, 2577, 2588, 5088, 5130, 6088, 6130, 7088, 7130, Cotton Pickers: 420, 620, 625, 2555, CPX420, CPX610, CPX620	Gas Strut, Steering Column	AM224357A1	\$ 36.00	
1620, 1640, 1644, 1660, 1666, 1670, 1688, Cotton Pickers: 1800, 1822, 1844, 2055	Gas Strut, Door	AM1280157C1	\$ 20.00	
2144, 2166, 2188, 2344, 2366, 2377, 2388, 2577, 2588, 5088, 5130, 6088, 6130, 7088, 7130, Cotton Pickers: 420, 620, 625, 2555, CPX420, CPX610, CPX620	Gas Strut, Door Right and Left Hand	AM144006A1	\$ 36.00	
5130, 5140, 6130, 6140, 7010, 7120, 7130, 7140, 7230, 7240, 8010, 8120, 8230, 8240, 9120, 9230, 9240, AFX8010, Swathers: WD1203, WD1903, WD2303, WDX1202, WDX1902, WDX2302	Gas Strut, Door Right and Left Hand	AM84320293	\$ 19.00	
2144, 2166, 2188, 2344, 2366, 2377, 2388, 2577, 2588	Gas Strut, Rear Panel	AM140311A3	\$ 19.00	
7010, 8010, AFX8010	Gas Strut, Upper Panel	AM87108531	\$ 32.00	
2344, 2366, 2388 BSN JJCO276540	Gas Strut, Rotary Air Screen Chute Replaces 229626A1	AM87025781	\$ 30.00	
Cornheads: Models w/ Tall Corn Attachment	Gas Strut, Tall Corn Kit Replaces 229626A1	AM87025781	\$ 30.00	
2388, 2588	Door Cylinder Kit, Right Hand	AMSS3319	\$ 81.00	
	Door Cylinder Kit, Left Hand	AMSS3320	\$ 81.00	
Cotton Pickers: 420 Express, 2555, CPX420, Titan Floaters: 3020, 3520, 4020, 4520, Floaters: FLX3010, FLX3510, FLX4010, FLX4510, Patriot Sprayers: 3320, 4420, Sprayers: SPX4260, SPX4410	Stud, Door Gas Strut Replaces 142597A1	AM3234063R1	\$ 7.00	

Air Conditioning and Components

Application	Description	Part Number	Retail Price
 615, 715, 815, 915, 1440, 1480, 1640, 1660 BSN JJC0038345, 1680	Compressor Conversion Kit York Style to Sanden Style Includes Compressor, Mounting Bracket, Compressor Manifold, O-Rings and Mounting Hardware Requires AMX10202 Service Valve Kit to Replace Original Service Valves Requires Pag Oil 100V, 6.76 oz (200 cc)	AMX10165	\$ 403.00
	Service Valve Kit R134a Tube O-Ring to O-Ring or Flare Fitting Insert Flare Adapters for Flare Applications	AMX10202	\$ 36.00
	Ultra Pag Double End Capped, 100V, 8 oz	AMX10267	\$ 12.00
	Universal Pag Oil, 8 oz	AMX10274	\$ 9.00
 615, 715, 815, 915, Swathers: 4000, 5000, 5500 Replaces 417888C92	Compressor, York Style Left Hand Suction, Rotolock Clutch Not Included Requires Synthetic Ester Oil 100V, See Manufacturer for Oil Quantity	AMX10225	\$ 270.00
	Double Groove Clutch for York Compressor, 7"	AM470	\$ 103.00
	Premium Synthetic Ester Oil, 100V, 12 oz	AMX10273	\$ 11.00
 1440, 1460, 1480	Compressor, York Style Right Hand Suction, Rotolock Clutch Not Included Requires Synthetic Ester Oil 100V, 9.50 oz (281 cc)	AM54-032	\$ 230.00
	Double Groove Clutch for York Compressor, 7"	AM470	\$ 103.00
	Premium Synthetic Ester Oil, 100V, 12 oz	AMX10273	\$ 11.00

Case IH®—Combine

Application	Description	Part Number	Retail Price
 <p>1620 BSN JJC0032630, 1640 BSN JJC0038345, 1670 BSN JJC0080539, Cotton Pickers: (1822 BSN JJC0012691, 1844 BSN JJC0002462 - w/ Navistar® Engine) Replaces 1255750C91, 1924008C1, 1924008C2</p>	Compressor, York Style Right Hand Suction, O-Ring Fitting, Clutch Not Included Requires Synthetic Ester Oil 100V, 9.50 oz (281 cc)	AMX10177	\$ 225.00
	Double Groove Clutch for York Compressor, 7"	AM470	\$ 103.00
	Premium Synthetic Ester Oil, 100V, 12 oz	AMX10273	\$ 11.00
 <p>1620* ASN JJC0032630, 1640* ASN JJC0034705, 1644*, 1660*, 1666*, 1680* ASN JJC0045689, 1688*, 2144, 2166, 2188, 2344, 2366, 2388, 2588, Cotton Pickers: 2022, 2044, 2155, 2555, Swathers: 8820* ASN CFH0049253, 8825, 8825HP, 8830 ASN CFH0028999, 8840 ASN CFH0086315, 8850, 8860, 8860HP *Optional R134a Compressor Replaces 1999755C2, 1999755C3, 86993462, 1977959C1</p>	Compressor, Sanden SD7H15 12 Volt, w/ 2-Groove Clutch, 6" Clutch Diameter, Horizontal Tube O-Ring Requires Synthetic Ester Oil 100V, 9.60 oz (285 cc)	AMX10125	\$ 245.00
	Premium Synthetic Ester Oil, 100V, 12 oz	AMX10273	\$ 11.00
 <p>7010, 7120, 8010, 8120, 9120, AFX8010 Replaces 504078610, 317008A3, 86992688, 317008A2, 87775469</p>	Compressor, Sanden SD7H15HD 12 Volt, w/ 8-Groove Clutch, 5.98" (152 mm) Clutch Diameter, Horizontal Tube O-Ring, Direct Mount Requires Pag Oil 100V, 9.64 oz (285 cc)	AM86993463	\$ 281.00
	Ultra Pag Double End Capped, 100V, 8 oz	AMX10267	\$ 12.00
	Universal Pag Oil, 8 oz	AMX10274	\$ 9.00
 <p>6140, 7140, 7240, 8240, 9240</p>	Compressor w/ Clutch Replaces 5801558535	AM84279787	\$ 390.00
 <p>Swathers: 6000, 6500 Replaces 1336431C1, 60-2921T94</p>	Compressor, Sanden SD508 Style 12 Volt, w/ 2-Groove Clutch, 5.19" (132 mm) Clutch Diameter, Vertical #8 and #10 Flare Fittings, w/ R12 Charge Ports Requires R12 Mineral Oil, 5.91 oz (175 cc)	AMX10178	\$ 260.00
 <p>Swathers: 6000, 6500, 8820 SN CFH0049001-49252, 8830 SN CFH0028001-28804, 8840 SN CFH0031001-86000</p>	Compressor, Sanden Style 12 Volt, w/ 2-Groove Clutch, 6" (152 mm) Clutch Diameter, Vertical #8 and #10 Flare Connections, w/ R12 Charge Ports Requires R12 Mineral Oil, 5.91 oz (175 cc)	AMX10134	\$ 265.00
 <p>2144, 2166, 2188, 2344, 2366, 2377, 2388, 5130, 5140, 6130, Cotton Pickers: 2022, 2044, 2155, 2555, CPX420, CPX610, CPX620 Replaces 135324A1, 47108807, 47110444, 700713455</p>	Compressor Clutch SD7H15 Clutch w/ 12 Volt Coil, 2-Groove, 5.98" Clutch Diameter, 0.47" Groove Width Use w/ AMX10125 Compressor	AM135324A2	\$ 122.00
 <p>6130, 7010, 7120, 7130, 8010, 8120, 9010, 9120, AFX8010</p>	Compressor Clutch SD7H15 Clutch w/ 12 Volt Coil, 8-Groove, 5.98" (152 mm) Clutch Diameter, Key-Type Hub Replaces 8775538	AM403585A1	\$ 140.00
 <p>Patriot Sprayer: SPX2130 Replaces BN67727</p>	High Pressure Switch Normally Closed, Opens at 375 PSI, Closes at 225 PSI 7/16"x20 Thread	AM539069R2	\$ 35.00
 <p>5088, 5130, 5140, 6088, 6130, 6140, 7088, 7130, 7140, 7230, 7240, 8230, 8240, 9230, 9240</p>	Low Pressure Switch Normally Open, Opens at 20 PSI, Closes at 7 PSI, 10 mm Metric Thread	AM84419250	\$ 65.20
 <p>Universal Equipment</p>	High Pressure Switch Normally Open, Opens at 305 PSI, Closes at 395 PSI, 7/16"x20 Thread	AMX10276	\$ 36.00
 <p>Universal Equipment</p>	Low Pressure Switch Normally Open, Opens at 6 PSI, Closes at 45 PSI, Standard 7/16"x20 Thread	AMX10277	\$ 56.00

Prices Subject to Change without Prior Notice. The use of original equipment manufacturer (OEM) part numbers or trademarks, e.g. Case® and John Deere®, are for reference purposes only and for indicating product use and compatibility. Our company and the listed replacement parts contained herein are not sponsored, approved or manufactured by the OEM. All parts are New unless designated Reman in the description.

Case IH®—Combine

Application	Description	Part Number	Retail Price
 Universal Equipment	Low Pressure Switch Normally Open, Opens at 35 PSI, Closes at 46 PSI, Standard 7/16"x20 Thread	AMX10278	\$ 42.00
 525, 527 Replaces 060506138	Receiver Drier 3" x 10 1/2" Male O-Ring, R12 and R134a Compatible	AMX10218	\$ 27.00
 1420, (1440, 1460 ASN 12001), 1470 ASN 1180, 1480 ASN 1400, Cotton Picker: 782, 1400	Receiver Drier 4" x 6 3/4", Inlet - #6, 3/8" Female O-Ring, Outlet - #6, 3/8" Male O-Ring, R12 and R134a Compatible Replaces 118304C2	AMX10162	\$ 33.00
 1440, 1460, 1470, 1480, Swathers: 6450, 6455, 6550, 6555, 6650, 6655	Receiver Drier Replaces 111218C1	AMX10172	\$ 31.00
 1620, 1640, 1644, 1660, 1666, 1670, 1680, 1688, 2144, 2166, 2188, 2344, 2366, 2377, 2388, 2577, 2588, 5088, 6088, 7088, Cotton Harvester: 1800, Cotton Pickers: 1822, 1844, 2022, 2044, 2055, 2155, 2555, CPX420, CPX610, CPX620 Replaces 143469C2, 1990758C2	Receiver Drier 4" x 7 3/4", Inlet - #6, 3/8" Male O-Ring, Outlet - #6, 3/8" Female O-Ring, Front Mount, R12 and R134a Compatible	AMX10161	\$ 31.00
 7010, 7120, 7230, 8010, 8120, 8230, 9120, 9230, AFX8010 Replaces 295006A1	Receiver Drier Receiver Drier, Import 4" x 7 1/2", Inlet - #6 Female O-Ring, Outlet - #6 Male O-Ring, R12 and R134a Compatible	AMX10154 AMX10208	\$ 26.00 \$ 22.00
 615, 715, 815, 915 Replaces 244562R91, 168903C1	Expansion Valve Internally Regulated w/ 12" Capacity Tube w/ Flare Connection, R12 and R134a Compatible	AMX10215	\$ 31.00
 715 ASN 23001, 815, 915, 1440 BSN 10000, 1460 BSN 12000, 1470 BSN 1179, 1480 BSN 14000, Swathers: 6000, 6500, 8820 SN CFH0049001-CFH0049252, 8830 SN CFH0028001-CFH0028805, 8840 SN CFH0031001-CFH0086000	Expansion Valve Bulb Type, R12 and R134a Compatible, 19" Tube Length, Flare Connection	AMX10146	\$ 20.00
 782, 1400, 1420, 1440 ASN 10001, 1460 ASN 12001, 1470 ASN 1180, 1480 ASN 14001, Swathers: 4000 ASN 1983, 5000 ASN 10001, 5500 ASN 601, 8820 ASN CFH0049253, 8825, 8830 ASN CFH0028031, 8840 ASN CFH0086001, 8850 Replaces 128033C1	Expansion Valve Bulb Type, Externally Equalized, R12 and R134a Compatible, 14" Tube Length, O-Ring Connection	AMX10145	\$ 20.00
 (1620, 1640, 1660, 1670, 1680 BSN JJC0032629) Replaces 118321C1, 4322165	Expansion Valve Block Type, R12 and R134a Compatible, O-Ring Connection	AMX10151	\$ 24.00

Case IH®—Combine

Application	Description	Part Number	Retail Price
 (1620, 1640, 1660, 1670, 1680 ASN JJC0032630), 1644, 1666, 1688, 1800, 1822, 1844, 2022, 2055, 2144, 2155, 2166, 2188, 2344, 2366, 2377, 2388, 2577, 2588, 5088, 5130, 6088, 6130, 7010, 7088, 7130, 8010, AFX8010, Cotton Pickers: 420, 620, 625, 1800, 1822, 1844, 2022, 2044, 2055, 2144, 2155, 2555, CPX420, CPX610, CPX620, Sprayers: 3320, 4420, Swathers: WD1203, WD1903, WD2303, WDX1202, WDX1902, WDX2302, WPX1202, WPX1902, WPX2302 Replaces 386535A1, 1990756C2	Expansion Valve Block Type, R12 and R134a Compatible, O-Ring Connection	AMX10150	\$ 27.00
 5130, 5140, 6130, 6140, 7120, 7130, 7140, 7230, 7240, 8120, 8230, 8240, 9120, 9230, 9240	Expansion Valve Flange Type, O-Ring Connection	AM82023542	\$ 46.00
 615, 715, 815, 915, 1420, 1440, 1460, 1470, 1480, 1620, 1640, 1660, 1670, 1680	Adapter Kit Rotolock to O-Ring or Flare Service Valve	AMX10204	\$ 33.00
 1440	Service Valve Kit R134a Tube O-Ring to O-Ring or Flare Fitting Insert Flare Adapters for Flare Applications	AMX10202	\$ 36.00
 2144, 2166, 2188, 2344, 2366, 2388, Cotton Pickers: 2155, 2555, CPX420, CPX610 Replaces 1977564C2, 355190A1	Blower Motor Assembly w/o Resistor 12 Volt, Includes Wiring Harness	AMX10121	\$ 184.00
 2344, 2366 ASN JJC025950, 2377, 2388 ASN JJC0267150, 2577, 2588, 5088, 6088, 7088, Cotton Pickers: 420, 620, CPX420, CPX620	Blower Motor Assembly 12 Volt, Resistor Not Included Replaces 323610A1	AM84222524	\$ 153.00
 2388, 7010, 7120, 7230, 8010, 8120, 8230, 9010, 9120, 9130, 9230, AFX8010, Patriot Sprayers: 3240, 3340, 4430	Blower Motor Assembly 12 Volt Replaces 87663947, 87663956	AM87663955	\$ 158.00
 7010, 7120, 8010, 8120, 9120, AFX8010, Swathers: WPX1202, WPX1902, WPX2302	Blower Motor Assembly Replaces 330137A1	AM87107380	\$ 128.00
 1400, 1420, 1440, 1460, 1480, 1620, 1640, 1660, 1666, 1680, 1688, Cotton Harvester: 1800, Cotton Pickers: 1822, 1844, 2022, 2055 Replaces 190333A1	Blower Motor, Vented Single Speed, Double Shaft, 2-Wire, Reversible, 3/8" Shaft Diameter, 4 3/8" Long	AMX10118	\$ 110.00
 1400, 1420, 1440, 1460, 1470, 1480, 1620, 1640, 1644, 1660, 1666, 1670, 1680, 1688, Cotton Pickers: 1822, 1844, 2022, 2044, 2055	Blower Motor Kit, HD 12 Volt Dual Motor Assembly, 3-Speed 22 7/16" x 5 5/8" Mounting Base	AM1255878C92	\$ 250.00
 715, 815, 915, 1400, 1420, 1440, 1460, 1480, 1620, 1640, 1660, 1670, 1680	Blower Motor Switch 3-Speed Replaces 168822C1, 168822C2, AH84588	AMX10261	\$ 16.00
 615, 715, 815, 915, 1420, 1440, 1460, 1470, 1480, 1620, 1640, 1660, 1670, 1680 BSN JJ0045689, Cotton Harvester: 1400, 1800, Cotton Pickers: 782, 1822 ASN 12691, 1844 ASN 2462, 2022, 2044, Swathers: 1270, 1370, 1570, 2470, 2670 Prior to Cab SN 7864002, 4000, 5000, 5500	Condenser Core: 19 7/8" x 14" x 2" Replaces 165130C91	AM183901C2	\$ 307.00
 1660 ASN JJC0038346, 2144, 2166, 2188, 2344, 2366, Cotton Pickers: 2155, 2555	Condenser Overall: 29" x 10" Core: 26" x 10" x 2 3/8"	AM84581C2	\$ 455.00

Case IH®—Combine

Application	Description	Part Number	Retail Price
 2377 SN 292001-295000, 2388 BSN 273000 - w/ Fuel Cooler	Condenser Core: 29 1/2" x 15 3/4" x 3"	AM275094A4	\$ 677.00
 2377 ASN 295001, 2388 ASN 273000, 2577, 2588	Condenser w/ Fuel Cooler Core: 35" x 17" x 3" Replaces 444922A1, 444922A2	AM444922A3	\$ 1265.00
 5088, 5130, 5140, 6130, 6140, 7130, 7140	Condenser	AM87559914	\$ 730.00
8120, 8230, 9120, 9230	Condenser w/ Oil Cooler Replaces 84576582	AM47475783	\$ 1260.00
 AFX8010	Condenser Core: 42" x 24" x 1 3/4" Replaces 86976448	AM87106641	\$ 245.00
 Swathers: WD1903, WD2303	Condenser w/ Oil Cooler Core: 30 7/8" x 31" x 3.80" Replaces 87340522	AM87490300	\$ 1070.00
 5130, 5140, 6130, 6140, 7130, 7140	Dual Oil Cooler	AM84349665	\$ 1589.00
 5088, 6088, 7088	Oil Cooler	AM87559913	\$ 1900.00
Swathers: WD1203, WD1903, WD2303	Charge Air Cooler	AM87340510	\$ 1325.00
Swathers: WD1203, WD1903, WD2303	Charge Air Cooler Core: 33.00" x 14.30" x 3" Replaces 87039232	AM87340512	\$ 950.00
 1420, 1440, 1460, 1470, 1480, Cotton Harvester: 1400, Cotton Picker: 782	Evaporator, Early Bulb Type Valve Overall: 32 1/2" x 5" x 6" Core: 25" x 3 1/2" x 6" Replaces 111468C2	AM118315C1	\$ 250.00
 1644, 1660, 1666, 1680 BSN 45689, 1688, Cotton Harvester: 1800, Cotton Picker: 1822, 1844, 2022, 2044, 2055	Evaporator w/ Heater Core, Late Block Type Valve, O-Ring Fitting Includes Expansion Valve Core: 25" x 5" x 6"	AM1974632C3	\$ 335.00
 2144, 2166, 2188, 2344, 2366, 2388 BSN JJC0267149, Cotton Pickers: 2155, 2555, CPX610	Evaporator Block Type, O-Ring Connection Overall: 22 1/2" x 10" x 8" Core: 17 1/2" x 3 3/4" x 8" Replaces 121590A2, 121591A2	AM121590A3	\$ 340.00
 2344, 2366, 2377, 2388 ASN JJC02267150, 2577, 5130, 6088, 6130, 7088, 7130, Cotton Pickers: CPX420, CPX620	Evaporator Block Type, O-Ring Connection Overall: 23" x 10" x 8" Core: 17 1/2" x 3 3/4" x 8"	AM377560A1	\$ 365.00

Case IH®—Combine











Cornhead—Complete Polytin Heads

Mounting hardware is included with kits. Individual replacement parts available.









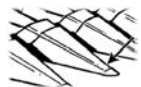

Applications	Description	Part Number	Retail Price	Core
900, 1000 Series	4 Row - 30" Complete Assembly	AMPTIH430	\$ 2720.00	
	6 Row - 30" Complete Assembly	AMPTIH630	\$ 3953.00	
	8 Row - 30" Complete Assembly	AMPTIH830	\$ 5030.00	
	12 Row - 30" Complete Assembly	AMPTIH1230	\$ 7333.00	
900, 1000 Series	4 Row - 36" Complete Assembly	AMPTIH436	\$ 2980.00	
	6 Row - 36" Complete Assembly	AMPTIH636	\$ 4110.00	
	8 Row - 36" Complete Assembly	AMPTIH836	\$ 5335.00	
	12 Row - 36" Complete Assembly	AMPTIH1236	\$ 7795.00	

Cornhead—Fenders and Snouts



Application	Description	Part Number	Retail Price	Core
 823, 824, 833, 834, 843, 844, 853, 854, 863, 864, 873, 883, 943, 944, 954, 963, 964, 983, 984, 1043, 1044, 1054, 1063, 1064, 1083, 1084	Outer Fender, Poly	Right Hand Left Hand	AM176192C3P AM176191C3P	\$ 405.00 \$ 405.00
	 823, 824, 833, 834, 843, 844, 853, 854, 863, 864, 873, 883	Outer Fender, Steel	Right Hand Left Hand	AM176192C3 AM176191C3
 943, 944, 954, 963, 964, 983, 984, 1043, 1044, 1054, 1063, 1064, 1083, 1084		Outer Fender, Steel	Right Hand Left Hand	AM199504C2 AM199503C2
	 2406, 2408, 2412, 3406, 3408, 3412, 3416, 3418	Outer Fender Replaces 86635993	Left Hand	AM87571755
 823, 824, 833, 834, 843, 844, 853, 854, 863, 864, 873, 883, 943, 944, 954, 963, 964, 983, 984, 1043, 1044, 1054, 1063, 1064, 1083, 1084	Outer Snout w/ Point, Poly	Right Hand Left Hand	AM320085A1P AM320084A1P	\$ 214.00 \$ 204.00
	 823, 824, 833, 834, 843, 844, 853, 854, 863, 864, 873, 883, 943, 944, 954, 963, 964, 983, 984, 1043, 1044, 1054, 1063, 1064, 1083, 1084	Outer Snout w/ Point, Steel	Right Hand Left Hand	AM176234C93 AM176233C93
 823, 824, 833, 834, 843, 844, 853, 854, 863, 864, 873, 883		Center Divider, Poly - 28" or 30"	Right and Left Hand	AMX27106
	Center Divider, Poly - 36"	Right and Left Hand	AMX27108	\$ 425.00
	Center Divider, Steel - 28" or 30" Replaces 176181C2	Right Hand	AM1345371C1	\$ 295.00
	Center Divider, Steel - 28" or 30" Replaces 176180C2	Left Hand	AM1345370C1	\$ 260.00
	Center Divider, Steel - 36", 38", 40"	Right Hand Left Hand	AM176164C2 AM176163C2	\$ 295.00 \$ 295.00
 943, 944, 954, 963, 964, 983, 984, 1043, 1044, 1054, 1063, 1064, 1083, 1084	Center Divider, Poly - 30"		AM1345363C1P	\$ 360.00
 943, 944, 954, 963, 964, 983, 984, 1043, 1044, 1054, 1063, 1064, 1083, 1084	Center Divider, Steel - 30"		AM1345363C1	\$ 595.00
	Center Divider, Poly - 36"	Right and Left Hand	AMX27107	\$ 380.00

Prices Subject to Change without Prior Notice. The use of original equipment manufacturer (OEM) part numbers or trademarks, e.g. Case® and John Deere®, are for reference purposes only and for indicating product use and compatibility. Our company and the listed replacement parts contained herein are not sponsored, approved or manufactured by the OEM. All parts are New unless designated Reman in the description.

Case IH®—Combine

	Application	Description		Part Number	Retail Price	Core
	943, 944, 954, 963, 964, 983, 984, 1043, 1044, 1054, 1063, 1064, 1083, 1084	Center Divider, Steel - 36", 38", 40"	Right Hand	AM1345362C1	\$ 260.00	
			Left Hand	AM1345361C1	\$ 260.00	
	2206, 2208, 2212, 2406, 2408, 2412, 3206, 3208, 3212, 3406, 3408, 3412, 3416	Center Divider - 30"		AM86978697	\$ 699.00	
	2206, 2208, 2212, 2406, 2408, 2412, 3206, 3208, 3212, 3406, 3408, 3412, 3416, 3418	Center Snout - 30" w/o Metal Frame		AM86980207	\$ 383.00	
	2206*, 2208*, 2212**, 2406, 2408, 2412, 3206, 3208, 3212, 3406, 3408, 3412, 3416, 3418 *30", 36" or 38" Row Spacing **20", 22" or 30" Row Spacing	Outer Snout		AM86980203	\$ 335.00	
	823, 824, 833, 834, 843, 844, 853, 854, 863, 864, 873, 883, 943, 944, 954, 963, 964, 983, 984, 1043, 1044, 1054, 1063, 1064, 1083, 1084	Row Center Snout w/ Point, Poly - 28", 30"	Narrow	AM176228C95P	\$ 224.00	
		Row Center Snout w/ Point, Steel - 28", 30"	Narrow	AM176228C94	\$ 330.00	
		Row Center Snout w/ Point, Poly - 36"	Wide	AM176221C94P	\$ 220.00	
		Row Center Snout w/ Point, Steel - 36"	Wide	AM176221C94	\$ 317.00	
	Models w/ Polytin Snouts	Wear Plate, Stainless Steel	Right Hand	AMX27289	\$ 25.00	
			Left Hand	AMX27288	\$ 25.00	
	2206, 2208, 2212, 2406, 2408, 2412, 3206, 3208, 3212, 3406, 3408, 3412, 3416, 3418	Wear Strip 30" Long For Inner Dividers	Right Hand	AM86553710	\$ 55.00	
			Left Hand	AM86553709	\$ 55.00	
	Models w/ Polytin Kits	Wear Strip, Stainless Steel For Fender Snout	Right Hand	AMX27314	\$ 23.00	
			Left Hand	AMX27313	\$ 27.00	
	823, 824, 833, 834, 843, 844, 853, 854, 863, 864, 873, 883, 943, 944, 954, 963, 964, 983, 984, 1043, 1044, 1054, 1063, 1064, 1083, 1084	Wear Tip For Polytin	Poly	AM71364963NP	\$ 28.00	
			Cast	AM71364963A	\$ 21.50	
			Cast	AM71364963	\$ 40.00	
	2206, 2208, 2212, 2406, 2408, 2412, 3206, 3208, 3212, 3406, 3408, 3412, 3416, 3418	Wear Tip - 20" or 22"		AM87015178	\$ 49.00	
	824, 833, 834, 843, 844, 853, 854, 863, 864, 873, 874, 914, 943, 944, 954, 963, 964, 983, 984, 1043, 1044, 1054, 1063, 1064, 1083	Ear Saver Sold Individually (2) Required per Row Replaces 199097C1, 199097C2		AM199097C3	\$ 4.76	
	2200, 2400, 3200 & 3400 Series	Ear Savers Sold Individually (2) Required per Row Replaces 86526475		AMX27177	\$ 15.00	
	2200, 2400, 3200 & 3400 Series	Ear Saver Sold Individually (2) Required per Row		AM86526475	\$ 6.50	
	3406, 3408, 3412, 3416, 3418, 4206, 4208, 4406, 4408, 4412	Ear Saver 30" Row Spacing	Inside Snout	AM47483715	\$ 7.95	
	4206, 4208, 4406, 4408, 4412	Ear Saver 30" Row Spacing	Outside Snout	AM47515996	\$ 8.33	
	Models w/ Metal Heads	Poly Skid Bubble Tip	Outside Snout	AMX27146	\$ 18.50	

Case IH®—Combine

Application	Description	Part Number	Retail Price	Core
 Models w/ Metal Heads	Poly Skid Bubble Tip	Inside Snout	AMX27147	\$ 18.50
 Models w/ Poly Snout	Poly Skid Bubble Tip	Outside Snout	AMX27150	\$ 18.50
 Models w/ Poly Snout	Poly Skid Bubble Tip	Inside Snout	AMX27151	\$ 19.00
Most Models	Poly Gathering Chain Guard 8.90" x 23" - Red, Includes Hardware		AMX27153	\$ 21.00

Cornhead—Augers and Auger Liners

Application	Description	Part Number	Retail Price	Core
30" Row	4 Row Poly Auger Liner	AMX27129	\$ 260.00	
30" Row	6 Row Poly Auger Liner	AMX27130	\$ 305.00	
30" Row	8 Row Poly Auger Liner	AMX27131	\$ 374.00	
30" Row	12 Row Poly Auger Liner	AMX27132	\$ 578.00	
963, 1063	6 Row Cornhead Auger - 30" Extended Wear, 173.25" Long	AM199694C4	\$ 1366.00	
983, 1083	8 Row Cornhead Auger - 30" Extended Wear, Overall Length - 225 1/4", Right and Left Hand Flighting, 13 3/4" Flighting Diameter, 1 1/8" Hex Shaft Diameter, 15" Pitch	AM199696C3	\$ 1581.00	
1064	6 Row Cornhead Auger, Wide	AM338927A1	\$ 1825.00	
2206, 2208, 2212, 2406, 2408, 2412, 3206, 3208, 3212, 3406, 3408, 3412	Cornhead Auger For 8 Row 30" or 12 Row 20"	AM86615202	\$ 2193.00	
943, 944, 954, 963, 964, 983, 984, 1043, 1044, 1054, 1063, 1064, 1083, 1084	Sprocket Assembly 64 Tooth, 1.139" Hex Hub, 13.073" OD	AM199729C1	\$ 125.00	
2206, 2208, 2212, 2406, 2408, 2412, 3206, 3208, 3212, 3406, 3408, 3412	Auger Drive Sprocket Assembly 20 & 24 Tooth, 5.20" & 6.135" OD	AM87283922	\$ 133.83	
943, 944, 954, 963, 964, 983, 984, 1043, 1044, 1054, 1063, 1064, 1083, 1084	Drive Sprocket 15 Tooth, 29 mm Hex Hub, 3.294" OD	AM199727C1	\$ 43.00	
2206, 2208, 2212, 2406, 2408, 2412	Idler Sprocket Replaces 179013A1	AM86627870	\$ 36.00	
2406, 2408, 2412	Auger Drive Sprocket 21 & 27 Tooth, 5.408" & 6.135" OD	AM87501858	\$ 58.00	
943, 944, 954, 963, 964, 983, 984, 1043, 1044, 1054, 1063, 1064, 1083, 1084	Slip Clutch Plate 6.50" Bolt Circle, 0.343" Hole Diameter	AM177963C1	\$ 125.17	
943, 944, 954, 963, 964, 983, 984, 1043, 1044, 1054, 1063, 1064, 1083	Slip Clutch Facing 2.97" ID, 6" OD, 0.192" Thick	AM177964C2	\$ 16.07	
2606, 2608, 2612, (4206, 4208, 4416 - w/ Chopping Row Units), 4406, 4408, (4408, 4412, 4416, 4418 - w/o Chopping Row Units), 4408F, 4412, 4412F	Idler Sprocket Replaces 47906258, 84977538	AM87473652	\$ 65.00	
2206, 2208, 2212, 2406, 2408, 2412, 3206, 3208, 3212, 3406, 3408, 3412	Auger Drive Bearing 1 1/8" (28.60 mm) Hex Bore, 1.4843" (37.70 mm) Wide, 2.8346" (72 mm) OD	AM121602	\$ 18.00	

Case IH®—Combine

Cornhead—Stalk Stompers and Components

Kits include header mounting brackets, 12" stalk stomper shoes, stalk stomper torsion mounts, u-bolts and mounting hardware. Kits require 2" x 2" square tool bar.

Application	Description	Part Number	Retail Price	Core
2206, 2208, 2212, 2406, 2408, 2412, 3206, 3208, 3212, 3406, 3408, 3412	Stalk Stomper Kit, 2 Row For 8 Row and 12 Row Covers 1 Row on Each Side of Feederhouse No Coverage Below Feederhouse Replaces 73343983	AMX31000	\$ 1000.00	
	Stalk Stomper Kit, 4 Row For 8 Row and 12 Row Cornheads Covers 2 Rows on Each Side of Feederhouse No Coverage Below Feederhouse Replaces 73343984	AMX31003	\$ 1550.00	
	Stalk Stomper Kit, 4 Row For 8 Row and 12 Row Cornheads Covers 2 Rows Below Feederhouse and 2 Outer Rows (1 per side) Replaces 73343985	AMX31004	\$ 1600.00	
	Stalk Stomper Kit, 6 Row For 8 Row and 12 Row Cornheads Covers 2 Rows Below Feederhouse and 4 Outer Rows (2 per side) Replaces 73343986	AMX31006	\$ 2500.00	
	Stalk Stomper Kit, 6 Row For 8 Row and 12 Row Cornheads Covers 3 Rows on Each Side of Feederhouse No Coverage Below Feederhouse Replaces 73343987	AMX31007	\$ 2450.00	
2206, 2208, 2212, 2406, 2408, 2412, 3206, 3208, 3212, 3406, 3408, 3412	Stalk Stomper Kit, 8 Row For 8 Row and 12 Row Cornheads Covers 2 Rows Below Feederhouse and 6 Outer Rows (3 per side) Replaces 73343988	AMX31008	\$ 3009.00	
	Stalk Stomper Kit, 12 Row For 8 Row and 12 Row Cornheads Covers 2 Rows Below Feederhouse and 10 Outer Rows (5 per side) Replaces 73343989	AMX31009	\$ 3825.00	
	Stalk Stomper Kit, 4 Row For 6 Row Cornheads Covers 2 Rows on Each side of Feederhouse No Coverage Below Feederhouse Replaces 73343973	AMX31001	\$ 1550.00	
	Stalk Stomper Kit, 4 Row For 6 Row Cornheads Covers 2 Rows Below Feederhouse and 2 Outer Rows (1 per side) Replaces 73343974	AMX31002	\$ 1600.00	
	Stalk Stomper Kit, 6 Row For 6 Row Cornheads Covers 2 Rows Below Feederhouse and 4 Outer Rows (2 per side) Replaces 73343975	AMX31005	\$ 2450.00	

Case IH®—Combine

Application	Description	Part Number	Retail Price	Core
2608, 2612, 4206, 4406, 4408, 4412, 4416, 4418	Stalk Stomper Kit, 2 Row Kit Covers 1 Row on Each Side of Cornhead Replaces 73343950	AMX31010	\$ 1000.00	
	Stalk Stomper Kit, 4 Row Kit Covers 2 Rows on Each Side of Cornhead Replaces 73343951	AMX31011	\$ 1500.00	
	Stalk Stomper Kit, 6 Row Kit Covers 3 Rows on Each Side of Cornhead Replaces 73343952	AMX31012	\$ 2000.00	
	Stalk Stomper Kit, 8 Row Kit Covers 6 Rows on Each Side of Cornhead Replaces 73343953	AMX31013	\$ 2650.00	
	Stalk Stomper Kit, 12 Row Kit Covers 6 Rows on Each Side of Cornhead Replaces 73343954	AMX31014	\$ 3600.00	
	Stalk Stomper Kit, 12 Row Folding Head Kit Covers 6 Rows on Each Side of Cornhead Replaces 73343967	AMX31015	\$ 3900.00	
	Stalk Stomper Kit, 16 Row Covers 8 Rows on Each Side of Cornhead Replaces 73343955	AMX31016	\$ 4225.00	
	Stalk Stomper Kit, 18 Row Kit Covers 9 Rows on Each Side of Cornhead Replaces 73343956	AMX31017	\$ 4700.00	
	2206, 2208, 2212, 2406, 2408, 2412, 3206, 3208, 3212, 3406, 3408, 3412	Header Mounting Bracket	AMX30007	\$ 180.00
2206, 2406, 3206, 3406	Header Bracket, Right End For 6 Row Header Kits	AMX30009	\$ 165.00	
	Header Bracket, Left End For 6 Row Header Kits	AMX30008	\$ 165.00	
2206, 2208, 2212, 2406, 2408, 2412, 3206, 3208, 3212, 3406, 3408, 3412	Header Bracket, Center	AMX30012	\$ 55.00	
2206, 2208, 2212, 2406, 2408, 2412, 2608, 2612, 3206, 3208, 3212, 3406, 3408, 3412, 4206, 4406, 4408, 4412, 4416, 4418	Single Row Shoe, 12" Includes Torsion Mounting Bracket	AMX30000	\$ 320.00	
	Replacement Shoe, 12" Torsion Mounting Bracket Not Included	AMX30002	\$ 125.00	
2206, 2208, 2212, 2406, 2408, 2412, 3206, 3208, 3212, 3406, 3408, 3412	Single Center Shoe, 12"	AMX30001	\$ 320.00	
2206, 2208, 2212, 2406, 2408, 2412, 2608, 2612, 3206, 3208, 3212, 3406, 3408, 3412, 4206, 4406, 4408, 4412, 4416, 4418	Stalk Stomper Torsion Unit	AMX30005	\$ 160.00	
	Tool Bar 2" x 2" Square, 72" Long, 3/16" Sidewall Thickness	AMX30003	\$ 75.00	
	Tool Bar 2" x 2" Square, 102" Long, 3/16" Sidewall Thickness	AMX30004	\$ 105.00	
2206, 2208, 2212, 2406, 2408, 2412, 3206, 3208, 3212, 3406, 3408, 3412	Tool Bar Mounting Bracket	AMX30010	\$ 80.00	
	Offset Tool Bar Mounting Bracket	AMX30011	\$ 90.00	
2412, 2612, 3212, 3412, 4412, 4416, 4418	Tool Bar Splice Bracket Use to splice 2 Tool Bars together to add extended length for various row spacing and additional rows	AMX30006	\$ 42.00	

Case IH®—Combine



Cornhead—Hydraulic Deck Plate Kits

















Kits include components to connect your cornhead to adjustable hydraulic deck plates.

Application	Description	Part Number	Retail Price	Core
943, 1043	Hydraulic Deck Plate Kit 900 & 1000 Series, 4 Row 30"	AMX27508	\$ 2050.00	
963, 1063	Hydraulic Deck Plate Kit 900 & 1000 Series, 6 Row 30"	AMX27509	\$ 2850.00	
983, 1083	Hydraulic Deck Plate Kit 900 & 1000 Series, 8 Row 30"	AMX27510	\$ 3725.00	
	Hydraulic Deck Plate Kit 900 & 1000 Series, 12 Row 30"	AMX27507	\$ 5400.00	

Cornhead—Row Unit Components



Application	Description	Part Number	Retail Price	Core
 823, 824, 833, 834, 843, 844, 853, 854, 863, 864, 873, 883	Chain and Sprocket Kit Includes Chain, Drive Gear and Non-Greaseable Idler	AMX27387	\$ 51.00	
	Chain and Sprocket Kit Includes Chain, Drive Gear and Greaseable Idler	AMX27388	\$ 50.00	
 900 & 1000 Series	Chain and Sprocket Kit Includes Chain, Drive Gear and Non-Greaseable Idler	AMX27155	\$ 51.00	
	Chain and Sprocket Kit Includes Chain, Drive Gear and Greaseable Idler	AMX27156	\$ 50.00	
 227, 228, 229, 327WN, 328N, 329N, 428, 429, 429N, 430, 430N, 620N, 630N, 724, 733, 734, 744, 762, 763, 764, 782	Gathering Chain	AM654164R91	\$ 75.00	
	823, 824, 833, 834, 843, 844, 853, 854, 863, 864, 873, 883, 943, 944, 954, 963, 964, 983, 984, 1043, 1044, 1054, 1063, 1083, 1084, 2206, 2208, 2212, 2406, 2408, 2412, (3206*, 3208* - 2011 and Later), 3212, 3406, 3408, 3412, 3416 *On These Models 8 Lug Chain Replaces 6 Lug Replaces 176279C91	Gathering Chain, Black 48 Links, 8 Lug 2.63" Wide Attachment Links	AMCHG-100	\$ 36.00
 2606, 2608, 2612	Gathering Chain, Black 76 Links, 8 Lug Replaces 84977231	AM84251979	\$ 71.00	
 (2206, 2208, 2212 ASN HAJ0003469), 2406, 2408, 2412, 3206, 3208, 3212, 3406, 3408, 3412 - 2011 and Later	Gathering Chain 6 Lug	AM84284709	\$ 60.00	
 843, 844, 863, 883	Gathering Chain Drive Sprocket 10 Tooth w/o Keyway	AM176278C2	\$ 30.00	
 943, 944, 954, 963, 964, 983, 984, 1043, 1044, 1054, 1063, 1064, 1083, 1084	Gathering Chain Drive Sprocket 10 Tooth w/ Keyway	AM199497C1	\$ 15.00	
 2206, 2208, 2212, 2406, 2408, 2412, 3206, 3208, 3212, 3406, 3408, 3412, 3416, 3418	Gathering Chain Drive Sprocket 7 Tooth	AM86837081	\$ 20.00	

Case IH®—Combine

	Application	Description	Part Number	Retail Price	Core
	2206, 2208, 2212, 2406, 2408, 2412, 3206, 3208, 3212, 3406, 3408, 3412, 3416, 3418	Gathering Chain Drive Sprocket 8 Tooth	AM86611371	\$ 28.00	
	2606XR, 2608XF, 2608XR, 2612XR	Gathering Chain Drive Sprocket 11 Tooth	AM84977235	\$ 61.00	
	823, 824, 833, 834, 843, 844, 853, 854, 863, 864, 873, 883	Topshaft Conversion Kit Changes 800 Drive to 900/1000 Keyed Style Includes Sprocket, Shaft, Snap Ring, Woodruff Key, Nut and Oil Seal	AM176371KIT	\$ 59.00	
	843, 844, 863, 883, 943, 944, 954, 963, 983, 984, 1043, 1044, 1054, 1063, 1083, 2206, 2208, 2212, 2406, 2408, 2412	Idler Sprocket, Greaseable 8 Tooth, 0.65" ID	AMAH101219	\$ 13.00	
	843, 844, 863, 883, 943, 944, 954, 963, 983, 984, 1043, 1044, 1054, 1063, 1083, 2206, 2208, 2212, 2406, 2408, 2412, 3206, 3208, 3212, 3406, 3408, 3412 Replaces 176283C91, 87034967	Idler Sprocket, Non-Greaseable 8 Tooth, 0.65" ID	AMAN102448	\$ 13.00	
	824, 833, 834, 844, 853, 854, 863, 864, 873, 874, 883, 943, 944, 954, 963, 964, 983, 984, 1043, 1044, 1054, 1063, 1064, 1083, 1084	Idler Sprocket 60 Chain, 15 Tooth, 0.625" ID	AM629972R91	\$ 20.00	
	2606XR, 2608XF, 2608XR, 2612XR, 4206, 4208, 4406, 4408, 4408F, 4412, 4412F, 4416	Idler Sprocket Replaces 84977538, 87473652	AM47906258	\$ 85.00	
	2206, 2208, 2212, 2406, 2408, 2412, 3206, 3208, 3212, 3406, 3408, 3412	Idler Sprocket Assembly 15 Tooth, 0.654" ID, 3.852" OD	AM86619126	\$ 28.04	
	823, 824, 833, 834, 843, 844, 853, 854, 863, 864, 873, 883	Gathering Chain Guide	AM176280C1	\$ 17.00	
	900 & 1000 Series	Gathering Chain Guide	AM1347176C1	\$ 17.00	
	2206, 2208, 2212, 2406, 2408, 2412	Chain Guide	AM86611426	\$ 36.00	
	3206, 3208, 3212, 3406, 3408, 3412, 3416, 3418	Chain Guide, Right Hand Chain Guide, Left Hand	AM87593362 AM84316263	\$ 73.00 \$ 87.00	
	823, 824, 833, 834, 843, 844, 853, 854, 863, 864, 873, 883	Deck Plate, Right Hand	AM176292C91	\$ 25.00	
	823, 824, 833, 834, 843, 844, 853, 854, 863, 864, 873, 883	Deck Plate, Left Hand	AM176291C91	\$ 25.00	
	900 & 1000 Series	Deck Plate, Right Hand	AM199382C1	\$ 19.00	
	943, 944, 954, 963, 964, 983, 984, 1043, 1044, 1054, 1063, 1064, 1083, 1084	Deck Plate, Left Hand	AM199381C1	\$ 19.00	
	2206, 2208, 2212, 2406, 2408, 2412	Deck Plate, Right Hand Replaces 86611537, 86978031	AM86978032	\$ 46.00	
	2206, 2208, 2212, 2406, 2408, 2412	Deck Plate, Left Hand Manual Adjust Replaces 86611536	AM87047540	\$ 33.00	
	2206, 2208, 2212, 2406, 2408, 2412	Deck Plate, Left Hand Hydraulic Adjust Replaces 86611535, 86980000	AM87047608	\$ 71.00	

Prices Subject to Change without Prior Notice. The use of original equipment manufacturer (OEM) part numbers or trademarks, e.g. Case® and John Deere®, are for reference purposes only and for indicating product use and compatibility. Our company and the listed replacement parts contained herein are not sponsored, approved or manufactured by the OEM. All parts are New unless designated Reman in the description.

Case IH®—Combine

	Application	Description	Part Number	Retail Price	Core
	2606X, 2608XR, 2612XR, 4206, 4208, 4412F BSN 697	Deck Plate, Right Hand For Non-Chopping Heads	AM84972758	\$ 55.00	
	(2606X, 2608XR, 2612XR ASN 636), 4206, 4208, 4412F BSN 697	Deck Plate, Left Hand For Non-Chopping Heads	AM47474090	\$ 41.00	
	2606XR, 2608XF, 2608XR, 2612XR, 4206, 4208, 4406, 4408, 4408F, 4412, 4412F, 4416, 4418	Shield, Left Hand Replaces 87662222	AM47640753	\$ 135.00	
	1043, 1044, 1054, 1063, 1064, 1083, 1084, 3206, 3208, 3212, 3406, 3408, 3412	Bearing and Shield Kit Includes (2) AM1989222C2 Bearings and (2) AM327913A2 Shields	AMB95612	\$ 99.00	
	1043, 1044, 1054, 1063, 1064, 1083, 1084	Weed Knife, Right Hand Front	AM1306824C1	\$ 19.49	
		Weed Knife, Left Hand Front	AM1306823C1	\$ 18.71	
	2206, 2208, 2212, 2406, 2408, 2412	Weed Knife, Right or Left Hand Rear	AM86611418	\$ 19.25	
	1043, 1044, 1054, 1063, 1064, 1083, 1084	Weed Knife, Right or Left Hand Rear 9.62" Long, 3.19" Width, 8.31" Hole Diameter	AM1306079C1	\$ 31.09	
	(1043, 1044, 1054, 1063, 1064, 1083, 1084 ASN JJC0146000), 3206, 3208, 3212, 3406	Stalk Roll Bearing 3.25" Long	AM1989222C2	\$ 22.00	
	(1043, 1044, 1054, 1063, 1064, 1083, 1084 ASN JJC0146000), 3206, 3208	Stalk Roll Bearing Shield	AM327913A2	\$ 7.00	
	(1043, 1044, 1054, 1063, 1064, 1083 ASN JJC0146000)	Stalk Roll Auger, Right Hand	AM352551A1	\$ 82.00	
		Stalk Roll Auger, Left Hand	AM352552A1	\$ 82.00	
	1043, 1044, 1054, 1063, 1064, 1083, 1084	Stalk Roll Cone, Right Hand Replaces 1306729C1, 1989232C1	AM1306729C2	\$ 127.57	
		Stalk Roll Cone, Left Hand Replaces 1989231C1, 1306728C1	AM1306728C2	\$ 130.67	
	2206, 2208, 2212, 2406, 2408, 2412	Stalk Roll Auger, Right Hand Replaces 86618147, 87021346	AM87737779	\$ 61.00	
		Stalk Roll Auger, Left Hand Replaces 86618146, 87021344	AM87737776	\$ 61.00	
	800, 900 & 1000 Series, 3206, 3208, 3212, 3406, 3408, 3412	Snapping Roll Drive Coupler (1) Required per Roll	AM176301C1	\$ 20.00	
	1000 Series, 3206, 3208, 3212, 3406, 3408, 3412	Stalk Roll Shaft	AM199293C5	\$ 84.00	
	823, 824, 833, 834, 843, 844, 853, 854, 863, 864, 873, 883	Stalk Roll Knife (4) Required per Roll	AM176304C2	\$ 13.00	
	943, 944, 954, 963, 964, 983, 984, 1043, 1044, 1054, 1063, 1064, 1083, 1084	Stalk Roll Knife (4) Required per Roll	AM1327126C1	\$ 13.00	
	2206, 2208, 2212, 2406, 2408, 2412	Stalk Roll Knife Extended Wear, 5.40 mm Thick (2) Required per Roll	AM86977538	\$ 45.00	





Case IH®—Combine

	Application	Description	Part Number	Retail Price	Core
	2606, 2608, 2612, 4206, 4208, 4212, 4406, 4408, 4412	Stalk Roll Knife Extended Wear, 5.40 mm Thick (4) Required per Roll	AM84499693	\$ 43.00	
	3206, 3208, 3212, 3406, 3408, 3412, 3416, 3418	Stalk Roll Knife	AM87598741	\$ 19.00	
	2606, 2608, 2612	Stalk Chopping Knife	AM84340041	\$ 20.65	
	2206, 2208, 2212, 2406, 2408, 2412	Stalk Roll Barrel, Binocular Replaces 86626793, 87107017, 87107018	AM87663360	\$ 390.00	
	823, 824, 833, 834, 843, 844, 853, 854, 863, 864, 873, 883, 943, 944, 954, 963, 964, 983, 984, 1043, 1044, 1054, 1063, 1064, 1083, 1084	Bracket, Right Hand For Gathering Chain Idler Sprocket	AM176287C2	\$ 48.00	
	823, 824, 833, 834, 843, 844, 853, 854, 863, 864, 873, 883, 943, 944, 954, 963, 964, 983, 984, 1043, 1044, 1054, 1063, 1064, 1083, 1084	Bracket, Left Hand For Gathering Chain Idler Sprocket	AM176286C2	\$ 46.00	
	2206, 2208, 2212, 2406, 2408, 2412, 3206, 3208, 3212, 3406, 3408, 3412	Idler Bracket	AM87029139	\$ 30.00	
	943, 944, 954, 963, 964, 983, 984, 1043, 1044, 1054, 1063, 1064, 1083, 1084	Support Assembly, Right Hand Replaces 199372C4, 199372C3	AM199372C5	\$ 138.00	
	943, 944, 954, 963, 964, 983, 984, 1043, 1044, 1054, 1063, 1064, 1083, 1084	Support Assembly, Left Hand Replaces 199371C4, 199371C3	AM199371C5	\$ 138.00	
	2203, 2205, 2212, 2406, 2408, 2412	Wear Plate Replaces 86583946	AM87027837	\$ 19.00	
	(1043, 1044, 1054, 1063, 1064, 1083, 1084 ASN JJC0146000), 3206, 3208, 3212, 3406, 3408, 3412	Support, Right Hand	AM1327205C1	\$ 48.00	
	(1043, 1044, 1054, 1063, 1064, 1083, 1084 ASN JJC0146000), 3206, 3208, 3212, 3406, 3408, 3412	Support, Left Hand May also be used to replace early needle bearing style supports (1306172C1 for Right Hand, 1306172C1 for Left Hand) for models BSN JJC0146000 if the Auger is replaced w/ AM352551A1 which has the water pump style bearing	AM1327204C1	\$ 46.00	
	823, 824, 833, 834, 843, 844, 853, 854, 863, 864, 873, 883	Stalk Roll Drive Gear Set	AM199308C1	\$ 330.77	
	2206, 2208, 2212, 2406, 2408, 2412, 3206, 3208, 3212, 3406, 3408, 3412	Bevel Drive Gear and Shaft	AM86530072	\$ 145.00	
	1043, 1044, 1054, 1063, 1064, 1083, 1084	Drive Sprocket Shaft	AM199490C2	\$ 79.12	
	823, 824, 833, 834, 843, 844, 853, 854, 863, 864, 873, 883, 943, 944, 954, 963, 964, 983, 984, 1043, 1044, 1054, 1063, 1064, 1083, 1084	Drive Sprocket Shaft Woodruff Key	AM124553	\$ 0.88	
	943, 944, 954, 963, 983, 984, 1054, 1063	Sprocket Assembly, Main Drive 24 Tooth Double Sprocket, 6.153" OD	AM1306352C1	\$ 180.00	

Case IH®—Combine

	Application	Description	Part Number	Retail Price	Core
	943, 963, 983, 1043, 1044, 1054, 1063, 1064, 1083, 1084	Sprocket Assembly 64 Tooth, 8.666" ID, 13.097" OD, 9.452" Bolt Hole Centers For Auger Slip Clutch Drive	AM1306333C1	\$ 180.00	
	2406, 2408, 2412	Sprocket Assembly 20 & 21 Tooth, 5.20" & 5.408" OD For Auger Drive	AM87283939	\$ 80.00	
	943, 944, 954, 963, 964, 983, 984, 1043, 1044, 1054, 1063, 1064, 1083, 1084	Sprocket, Main Drive 35 Tooth, 8.772" OD, 1.139" Hex Hub	AM199647C1	\$ 75.00	
	943, 944, 954, 963, 964, 983, 984, 1043, 1044, 1064, 1083, 1084	Sprocket, Main Drive 30 Tooth, 7.585" OD, 1.139" Hex Hub	AM199643C1	\$ 85.00	
	964, 983, 984, 1064, 1083, 1084	Sprocket, Main Drive 5-Bolt, 24 Tooth 3.255" ID, 6.136" OD	AM1306156C1	\$ 47.11	
	2208, 2212, 2406, 2408, 2412, 3208, 3212	Sprocket, Main Drive 30 Tooth, 7.57" OD, 1.257" Hex Bore	AM87024802	\$ 171.30	
	2208, 2212, 2406, 2408, 2412, 3208, 3212	Drive Sprocket 25 Tooth, 8.48" OD, 1.257" Hex Hub	AM87024803	\$ 95.00	
	1043, 1044, 1054, 1063, 1064, 1083, 1084	Shaft Collar, Main Drive	AM1327106C1	\$ 26.24	
	2206, 2208, 2212, 2406, 2408, 2412, 3206, 3208, 3212, 3406, 3408, 3412	Bracket	AM86611369	\$ 51.00	
	2206, 2208, 2212, 2406, 2408, 2412, 3206	Pickup Bearing 1.25" Hex Bore	AM86523785	\$ 30.93	
	2206, 2208, 2212, 2406, 2408, 2412, 3206, 3208, 3212, 3406, 3408, 3412	Spring	AM86583948	\$ 8.22	
	2206, 2208, 2212, 2406, 2408, 2412, 3206, 3208, 3408, 3412	Sprocket 7 Tooth For Row Unit	AM84347361	\$ 40.00	
	2206, 2208, 2212, 2406, 2408, 2412, 3206, 3208, 3212, 3406, 3408, 3412	Tube	AM86583945	\$ 15.12	
	843, 844, 863, 883, 943, 944, 954, 963, 983, 984, 1043, 1044, 1054, 1063, 1064, 1083, 1084, 3206, 3208, 3212, 3406, 3408, 3412	Stalk Roll Rivet 3" Long, 0.375" Diameter	AM176307C1	\$ 4.47	
	2206, 2208, 2212, 3206, 3208, 3212	Bearing Cup For Rear Axle Hub	AM625743C1	\$ 12.54	
	2206, 2208, 2212, 2406, 2408, 2412, 3206, 3208, 3212, 3406, 3408, 3412	Ball Bearing	AM45396	\$ 13.38	

Case IH®—Combine

	Application	Description	Part Number	Retail Price	Core
	2206, 2208, 2212, 2406, 2408, 2412, 3206, 3208, 3212, 3406, 3408, 3412	Bearing Flange	AM86620027	\$ 9.10	
	824, 833, 834, 843, 844, 853, 854, 863, 864, 873, 874, 883	Coupling, Main Drive 4.63" Long, 1.147" Hex Bore	AM178647C2	\$ 66.33	
	(2206, 2208, 2212 BSN 0018272)	Coupler Connects Row Unit Gearbox	AM86583943	\$ 63.69	
	943, 944, 954, 963, 964, 983, 984, 1054, 1063	Hub, Main Drive and Driven 4.57" OD, 1.134" Hex Hub, 3.625" Bolt Hole Centers	AM1306358C1	\$ 158.68	
	1043, 1044, 1054, 1063, 1064, 1083, 1084	Slip Clutch Holder	AM1327150C1	\$ 90.59	
	943, 944, 1043, 1044	Sprocket, Main Drive 24 Tooth, 6.145" OD, 1.139" Hex Hub	AM199645C1	\$ 83.82	
	943, 944, 954, 963, 964, 983, 984, 1043, 1044, 1054, 1063, 1064, 1083, 1084	Slip Clutch Hub	AM176499C1	\$ 98.15	
	1043, 1044, 1054, 1063, 1064, 1083, 1084	Slip Clutch Housing Replaces 199689C1, 199689C2, 199689C4	AM199689C5	\$ 143.52	
	(2206, 2208, 2212 BSN 0018272)	Slip Clutch Hub	AM86611420	\$ 72.82	
	1043, 1044, 1054, 1063, 1064, 1083, 1084	Stalk Roll Drive Retainer Replaces 1327111C1, 1327111C2, 1327111C3	AM1327111C4	\$ 60.76	
	1043, 1044, 1054, 1063, 1064, 1083, 1084	Stalk Roll Drive Spring Set Set of 6 Replaces 1327112C1	AM1327164C1	\$ 30.48	
	943, 944, 954, 963, 964, 983, 984, 1043, 1044, 1054, 1063	Spacer, Drive Shaft 5.90" Long, 1.138" Hex Diameter	AM1306158C1	\$ 67.02	
	1043, 1044, 1054, 1063, 1064, 1083, 1084	Thrust Washer 2.01" ID, 3.55" OD, 0.70" Thick	AM1327069C1	\$ 2.61	
	824, 833, 834, 844, 853, 854, 863, 864, 873, 874, 883	Bushing, Lower 1.25" Long, 1" ID	AM176374C1	\$ 19.46	
	843, 844, 853, 854, 863, 864, 873, 874, 883, 884, 943, 944, 954, 963, 964, 983, 984, 1043, 1044, 1054, 1063, 1064, 1083, 1084	Slip Clutch Hub	AM176387C1	\$ 63.36	
	943, 944, 954, 963, 964, 983, 984, 1043, 1044, 1054, 1063, 1064, 1083, 1084	Spring	AM176468C1	\$ 5.86	
	943, 944, 954, 963, 964, 983, 984, 1054, 1063	Sprocket Assembly, Main Drive 26 Tooth Double Sprocket 2.887" ID, 6.625" OD, 3.625" Bolt Hole Centers	AM1306146C1	\$ 240.25	
	1043, 1044, 1054, 1063, 1064, 1083, 1084	Bushing 1.43" Long, 1" ID Replaces 199479C1, 199479C2	AM199479C3	\$ 5.30	
	4412, 4418	Rubber Curtain	AM48113581	\$ 11.66	
	4206, 4208, 4406, 4408, 4412, 5505, 5506	Rubber Curtain	AM84977584	\$ 18.00	

Prices Subject to Change without Prior Notice. The use of original equipment manufacturer (OEM) part numbers or trademarks, e.g. Case® and John Deere®, are for reference purposes only and for indicating product use and compatibility. Our company and the listed replacement parts contained herein are not sponsored, approved or manufactured by the OEM. All parts are New unless designated Reman in the description.

Case IH®—Combine

Belts—615, 715

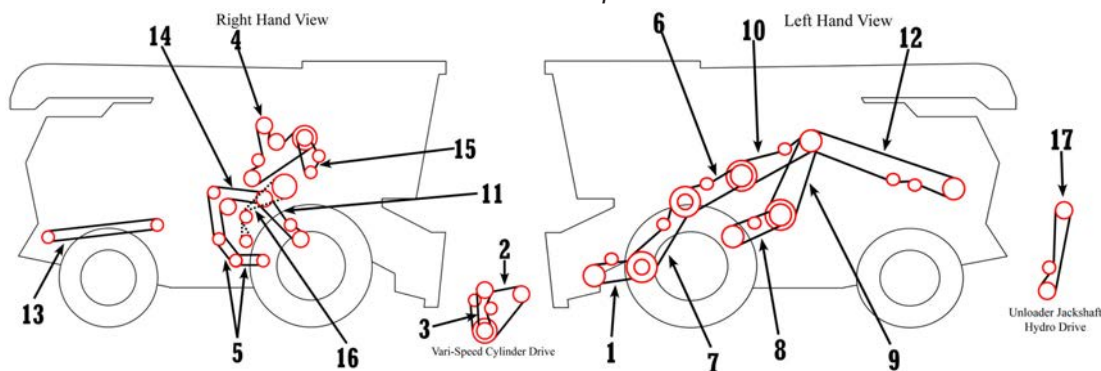

Application	Description	Part Number	Retail Price
1 715	Auger & Knife Drive (102")	AM178019C1	\$ 40.00
1 715	Auger & Knife Drive (150")	AM559064R1	\$ 74.10
1 715	Auger & Knife Drive (112")	AM191305C1	\$ 62.00
2 615, 715	Cylinder Drive, Variable Speed	AM171130C1	\$ 212.79
3 615, 715	Variable Speed Cylinder Drive (Primary)	AM171101C2	\$ 132.00
4 615, 715	Elevator Drive, w/o Raised Leveling Auger	AM937928R1	\$ 143.00
4 715	Elevator Drive, w/ Raised Leveling Auger	AM937929R1	\$ 87.63
4 715	Grain Tank Ext w/ Raised Leveling Auger	AM150433C1	\$ 89.00
6 615, 715	Feeder Drive, Regular	AM937932R1	\$ 78.00
7 615, 715	Feeder Jackshaft Drive Set of 2	AM176566C1	\$ 88.00
7 615 ASN 8001 w/o 34" Wheels, 715	Feeder Jackshaft Drive (Except Rice)	AM176565C1	\$ 87.00
7 715	Feeder Jackshaft Drive Double Belt Rice Only Set of 2	AM176577C1	\$ 160.18
7 (615, 715 ASN 8001 w/ 34" Wheels)	Feeder Jackshaft Drive, Rice	AM176576C1	\$ 80.09
8 715	Propulsion Drive (Belt Drive)	AM173110C1	\$ 121.38
8 615	Propulsion Drive	AM173109C1	\$ 105.00
9 615	Propulsion Jackshaft Drive, Diesel	AM172230C1	\$ 104.84
9 615	Propulsion Jackshaft Drive, Gas	AM937931R1	\$ 209.00
9 715	Propulsion Jackshaft Drive	AM150436C2	\$ 132.00
10 715	Separator Drive	AM171226C1	\$ 187.67
11 615	Shaker Shaft Drive, 265 RPM	AM564494R2	\$ 32.00
11 715	Shaker Shaft Drive	AM188716C1	\$ 46.00
12 715	Straw Chopper Drive	AM174614C2	\$ 106.14
13 615	Spreader Drive	AM171994C1	\$ 64.50
13 715	Straw Spreader	AM589622R1	\$ 53.00
14 615, 715	Straw Walker & Fan Jackshaft	AM170948C1	\$ 71.99
15 615, 715	Tailings Auger Drive	AM627297R1	\$ 8.89
16 615, 715	Unloader Drive, Belt Drive	AM559064R1	\$ 74.10
16 615, 715	Unloader Hydrostatic Drive	AM165676C1	\$ 62.00
17 615, 715	Unloader Jackshaft Drive, Hydrostat	AM175545C1	\$ 53.00
17 715	Unloader Jackshaft Drive	AM179317C2	\$ 69.67
NI 715	Compressor, A/C	AM936331R1	\$ 15.00
NI 715	Fan, Water Pump and Alternator (IH D310)	AM395539R1	\$ 17.92

Case IH®—Combine

Belts—815, 915

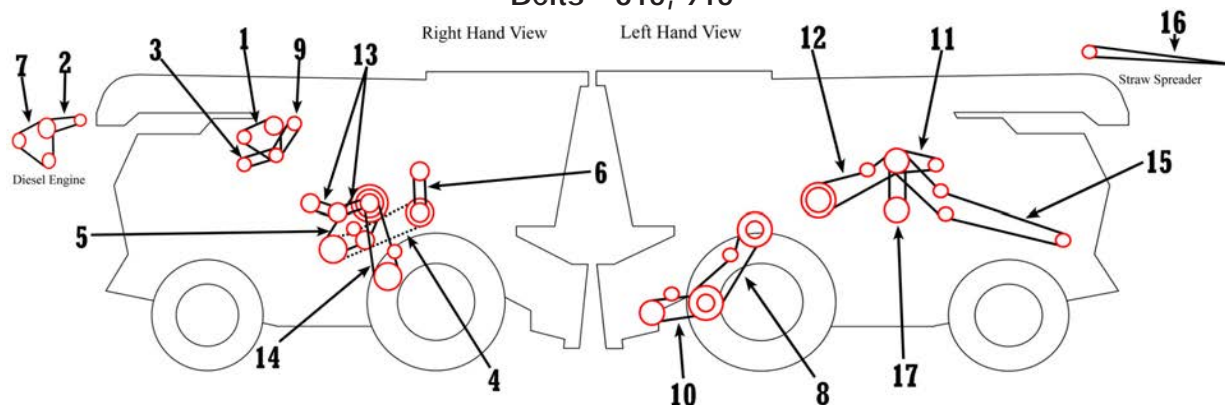

Application	Description	Part Number	Retail Price
1 815 ASN 8000, 915 w/ AC	Fan, Alternator, Water Pump	AM402253R91	\$ 44.50
2 815 ASN 8001	Compressor Drive, Diesel	AM65337C2	\$ 14.00
3 815 ASN 8001	Compressor Drive (Gas)	AM167031C2	\$ 5.60
4 815 ASN 8001, 915 ASN 2350	Cylinder Drive	AM174509C1	\$ 135.38
5 815, 915 - A/C w/ Cab	Cylinder Drive, Variable	AM164006C1	\$ 197.58
6 (815, 915 - ASN 8001)	Cylinder Speed Drive	AM167099C1	\$ 22.25
7 815 (D407), 915	Fan, Water Pump, Generator (Diesel Only)	AM528419R91	\$ 39.00
7 815 (D414), 915 BSN 8001	Fan, Water Pump, Generator w/ 414 Engine	AM537072R92	\$ 20.00
8 815 ASN 8001, 915 (w/o 23.1x34 or 24.5x32 Tires)	Feeder Jackshaft Drive	AM176565C1	\$ 87.00
8 (815, 915 - ASN 8001)	Feeder Drive (Belt Type) Bolt Att. Feeder	AM165053C2	\$ 134.00
8 815, 915	Feeder Jackshaft Drive Set of 3	AM176567C1	\$ 153.00
8 915 (w/ 23.1x34 or 24.5x32 Tires)	Feeder Jackshaft Drive	AM176576C1	\$ 80.09
8 915 BSN 19001 (w/ 23.1x34 or 24.5x32 Tires)	Feeder Jackshaft Drive Set of 2	AM176577C1	\$ 160.18
8 815 ASN 8001, 915 BSN 19001 (w/o 23.1x34 or 24.5x32 Tires)	Feeder Jackshaft Drive Set of 2	AM176566C1	\$ 88.00
9 (815, 915 - ASN 8001)	Governor Belt	AM532031R2	\$ 11.84
10 (815, 915 - ASN 8001)	Knife Drive	AM178019C1	\$ 40.00
10 (815, 915 - ASN 8001)	Hyd. Reel Pump Drive, Gas	AM178763C1	\$ 14.50
11 (815, 915 - ASN 8001)	Hyd. Reel Pump Drive, Gas	AM178763C1	\$ 14.50
11 915 ASN 8001	Hyd. Reel Pump Drive, Diesel	AM179007C1	\$ 10.30
12 815, 915	Separator Drive, Diesel	AM168665C2	\$ 202.49
12 815, 915	Separator Drive, Gas	AM166598C2	\$ 218.00
13 815, 915	Separator Fan Drive Set of 2	AM164999C92	\$ 60.00
14 815, 915	Shaker Shaft Drive 280 RPM	AM632702R1	\$ 52.00
14 815, 915	Shaker Shaft Drive 265 RPM	AM564494R2	\$ 32.00
15 815 ASN 3784, 915 ASN 2350	Straw Chopper Drive	AM174642C1	\$ 83.50
15 815 BSN 3784, 915 BSN 2350	Straw Chopper Drive	AM160870C1	\$ 72.88
16 815 ASN 8001	Straw Spreader Drive	AM196370C1	\$ 39.00
16 815 BSN 3784	Straw Spreader Drive	AM161820C1	\$ 39.00
16 815 ASN 3784, 915 ASN 2350	Straw Spreader Drive	AM161821C1	\$ 39.00
16 915 ASN 8001	Straw Spreader Drive	AM196371C1	\$ 66.00
17 815, 915	Unloader Jackshaft Drive	AM160173C1	\$ 69.00
NI 815 BSN 3783, 915 BSN 2349	Rotary Air Screen Drive	AM168725C1	\$ 9.00

Case IH®—Combine

Application	Description	Part Number	Retail Price
NI 815 ASN 3784, 915 ASN 2350	Rotary Air Screen Drive	AM172360C1	\$ 8.00
NI 815 BSN 8001	Platform Jackshaft Drive Bolt Att. Feeder	AM150816C1	\$ 67.00
NI 815, 915 BSN 8001	Feeder, Fast Speed for Bolt Att. Feeder	AM633728R2	\$ 64.50
NI 815 ASN 3784, 915 ASN 2350	Rotary Air Screen Drive	AM38331K	\$ 6.77
NI 815 ASN 3784, 915 ASN 2350	Straw Chopper Jackshaft Drive	AM160871C1	\$ 38.00

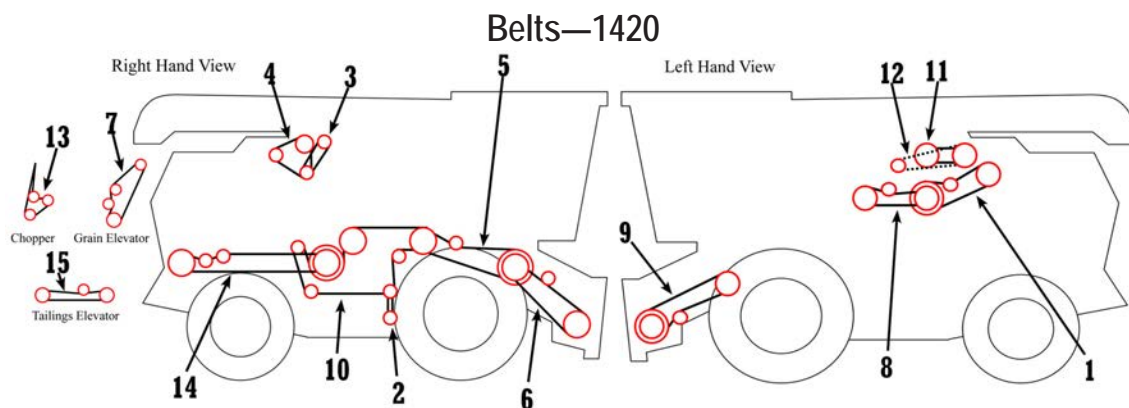

Application	Description	Part Number	Retail Price
1 1420	Auxiliary Pump Drive	AM191288C2	\$ 48.00
2 1420	Cleaning Fan Drive	AM599060R1	\$ 56.29
3 1420	Compressor Drive	AM280210C2	\$ 11.20
4 1420	Fan Belt (D358 Engine)	AM130724C91	\$ 23.28
5 1420	Feeder Drive	AM186377C1	\$ 118.00
6 1420	Feeder Jackshaft Drive Set of 2	AM197412C1	\$ 90.00
7 1420	Grain Elevator, Rice	AM181433C1	\$ 86.00
7 1420	Grain Elevator, Grain / Corn	AM182619C1	\$ 84.00
8 1420	Grain Tank Unloader Drive	AM195143C1	\$ 56.00
9 1420	Hydraulic Reel Drive	AM197414C2	\$ 91.00
10 1420	Right Side Drive, w/ Straw Chopper	AM186509C2	\$ 199.00
10 1420	Right Side Drive, w/ Discharge Beater	AM183049C1	\$ 154.00
11 1420	Rotor Variable Drive	AM1302174C1	\$ 238.38
12 1420	Separator Drive	AM191241C3	\$ 301.00
13 1420	Straw Chopper Drive	AM182945C1	\$ 77.00
14 1420 ASN 8000	Straw Spreader	AM589622R1	\$ 53.00
15 1420	Tailings Elevator Drive	AM674965R1	\$ 55.75

Case IH®—Combine

Belts—1440, 1460, 1480

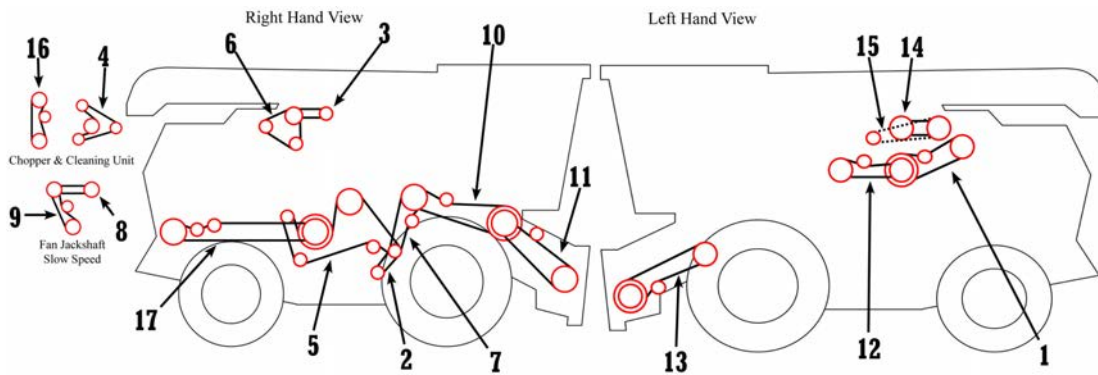

Application	Description	Part Number	Retail Price
1 1440, 1460, 1480	Auxiliary Pump Drive	AM191288C2	\$ 48.00
2 1440, 1460, 1480	Cleaning Fan Drive	AM195396C2	\$ 62.00
3 1440, 1460, 1480	Compressor Drive	AM874097C1	\$ 11.25
4 1440, 1460, 1480	Cleaning Unit Drive, w/ Straw Chopper	AM181055C1	\$ 173.00
5 (1440, 1460 BSN 1501)	Elevator Drive	AM192360C1	\$ 90.00
5 (1440, 1460 ASN 1501), 1480	Elevator Drive	AM186509C2	\$ 199.00
6 1440, 1460, 1480	Engine Fan (D436 Engine)	AM537072R92	\$ 20.00
7 1440, 1460	Fan Jackshaft Drive	AM191305C1	\$ 62.00
7 1480	Fan Jackshaft Drive	AM317904A1	\$ 79.00
8 1440, 1460, 1480	Slow Speed Fan Jackshaft Drive, 67"	AM181359C1	\$ 48.00
9 1440, 1460, 1480	Slow Speed Fan Jackshaft, 76"	AM610521R1	\$ 12.00
10 1480	Feeder Drive	AM194528C1	\$ 291.00
10 1440, 1460	Feeder Drive	AM192738C1	\$ 204.00
11 1480	Feeder Jackshaft Drive, 60" Feeder	AM393750A1	\$ 313.00
11 1440, 1460	Feeder Jackshaft Drive, 47" Feeder	AM1313095C2	\$ 173.00
11 1440, 1460, 1480	Feeder Jackshaft Drive, 54.50" Feeder	AM87629602	\$ 235.00
12 1440, 1460	Grain Tank Unloader Drive	AM191290C1	\$ 77.00
12 1480	Grain Tank Unloader Drive	AM191291C1	\$ 94.00
13 1440, 1460	Hyd Reel Drive, 47" Feeder w/o Trap	AM197411C1	\$ 68.00
13 1440, 1460 - w/ Rock Trap, 1480	Hydraulic Reel Drive	AM1315315C1	\$ 40.00
13 1440, 1460, 1480	Hyd Reel Drive, 54.50" Feeder w/o Trap	AM197414C2	\$ 91.00
13 1480	Hyd Reel Drive, 60" Feeder w/o Trap	AM197480C2	\$ 87.00
13 1480	Feeder Drive, w/ Rock Trap	AM1315074C1	\$ 263.00
14 1480	Rotor Drive, Variable	AM244422A1	\$ 321.00
14 1440, 1460	Rotor Drive, Variable	AM244420A1	\$ 311.00
15 1440, 1460	Separator Drive	AM191241C3	\$ 301.00
15 1480	Separator Drive	AM191244C1	\$ 207.00
16 1440 ASN 20715, 1460 ASN 23250	Straw Chopper Drive	AM181012C1	\$ 92.00
16 1480 ASN 24001	Straw Chopper Drive	AM181013C1	\$ 69.58
17 1440 BSN 20715, 1460 BSN 23250, 1480 BSN 24001	Straw Spreader Drive	AM153359C1	\$ 50.00
17 1440 ASN 20715, 1460 ASN 23250, 1480 ASN 24001	Straw Spreader Drive	AM196371C1	\$ 66.00

Case IH®—Combine

Belts—1620

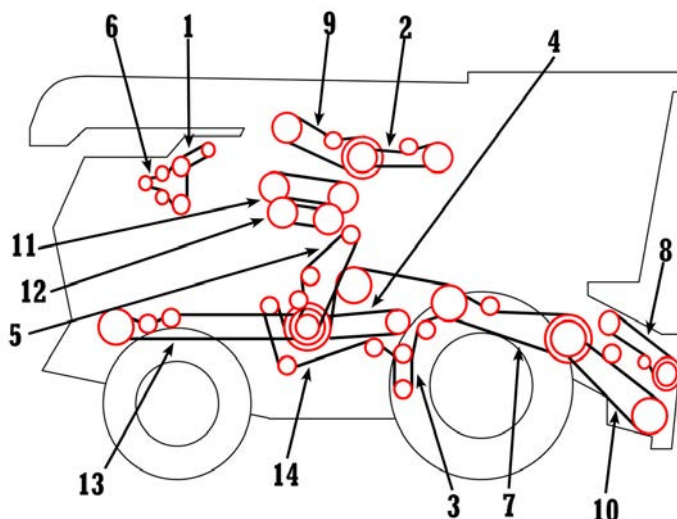

Application	Description	Part Number	Retail Price
1 1620	A/C Compressor	AM396829R1	\$ 6.84
2 1620	Auxiliary Pump Drive	AM1970115C1	\$ 48.00
3 1620	Cleaning Fan Drive	AM599060R1	\$ 56.29
4 1620	Cleaning Fan Jackshaft	AM191305C1	\$ 62.00
5 1620	Elevator Drive, w/ Straw Chopper	AM186509C2	\$ 199.00
6 1620	Engine Fan & Alternator	AMJ911574	\$ 31.81
7 1620	Feeder Drive, w/o Rock Trap	AM192738C1	\$ 204.00
7 1620	Feeder Drive, w/ Rock Trap	AM1315169C1	\$ 201.00
8 1620	Feeder Jackshaft Drive, 47" Feederhouse	AM1313095C2	\$ 173.00
8 1620	Feeder Jackshaft Drive, 54.50" Feederhouse	AM1313094C3	\$ 148.00
9 1620	Grain Tank Unloader Drive	AM191290C1	\$ 77.00
10 1620	Reel Pump Drive, 47"	AM1979606C1	\$ 35.00
10 1620	Reel Pump Drive, 54.50"	AM1330311C1	\$ 25.00
11 1620	Rotor Variable Drive	AM1302174C1	\$ 238.38
12 1620	Separator Drive	AM191241C3	\$ 301.00
13 1620	Straw Chopper Drive	AM1315265C1	\$ 68.00
14 1620	Straw Spreader Drive	AM196371C1	\$ 66.00

Case IH®—Combine

Belts—1640, 1660, 1680

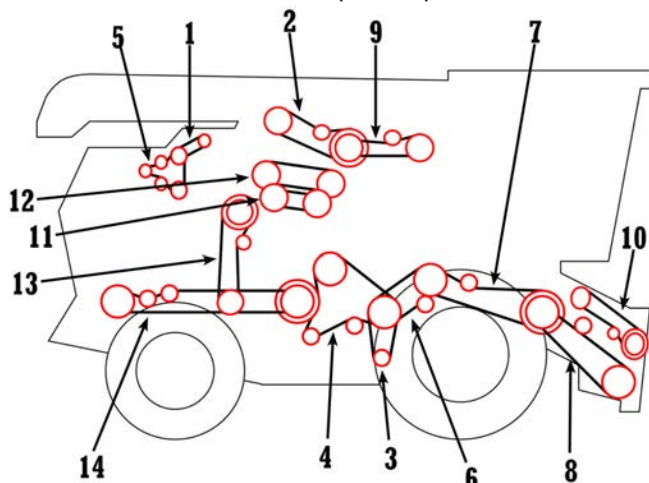

Application	Description	Part Number	Retail Price
1 1640, 1660, 1680	A/C Compressor	AM396829R1	\$ 6.84
2 1640, 1660	Auxiliary Pump Drive	AM1970115C1	\$ 48.00
2 1680 BSN JJC0045689	Auxiliary Pump Drive	AM191288C2	\$ 48.00
2 1680 SN JJC0045689-JJC0115352	Auxiliary Pump Drive	AM1970116C1	\$ 61.00
2 1680 ASN JJC0115352	Auxiliary Pump Drive	AM440498A3	\$ 100.00
3 1640, 1660, 1680	Cleaning Fan Drive	AM195396C2	\$ 62.00
4 1640, 1660, 1680	Elevator Drive, w/ Straw Chopper	AM181055C1	\$ 173.00
4 1640, 1660, 1680	Elevator Drive, w/ Discharge Beater	AM186509C2	\$ 199.00
5 1640 w/ IHC 400 Series Engine	Engine Fan and Alternator	AM537072R92	\$ 20.00
5 1640 w/ Cummins® Engines	Engine Fan and Alternator	AMJ911562	\$ 33.25
5 1660, 1680	Engine Fan and Alternator	AMJ911574	\$ 31.81
6 1640, 1660	Fan Jackshaft Drive	AM191305C1	\$ 62.00
6 1680	Fan Jackshaft Drive	AM317904A1	\$ 79.00
7 1640, 1660	Feeder Drive, w/o Rock Trap	AM192738C1	\$ 204.00
7 1640, 1660	Feeder Drive, w/ Rock Trap	AM1315168C1	\$ 219.00
7 1680	Feeder Drive, w/o Rock Trap	AM194528C1	\$ 291.00
7 1680	Feeder Drive, w/ Rock Trap	AM1315074C1	\$ 263.00
8 1660	Feeder Jackshaft Drive, 47" Feeder	AM1313095C2	\$ 173.00
8 1660, 1680	Feeder Jackshaft Drive, 54.50" Feeder	AM87629602	\$ 235.00
8 1680	Feeder Jackshaft Drive, 60" Feeder	AM393750A1	\$ 313.00
9 1640, 1660 BSN 102897	Grain Tank Unloader Drive	AM191290C1	\$ 77.00
9 1680 BSN JJC0115352	Grain Tank Unloader Drive	AM191291C1	\$ 94.00
9 1680 ASN JJC0115352	Grain Tank Unloader Drive	AM1989217C1	\$ 96.00
10 (1640, 1660 SN 34860-97170)	Reel Pump Drive, 47"	AM1979606C1	\$ 35.00
10 (1640, 1660 SN 34860-97170), 1680	Reel Pump Drive, 54.50"	AM1330311C1	\$ 25.00
10 (1640, 1660 BSN 34860 & ASN 97171)	Reel Pump Drive, 47"	AM1321564C1	\$ 39.00
10 (1640, 1660 BSN 34860 & ASN 97171), 1680 BSN 46598 & ASN 115001	Reel Pump Drive, 54.50"	AM1321565C1	\$ 53.00
10 1680 BSN 46598 & ASN 115001	Reel Pump Drive, 60"	AM1315226C1	\$ 33.19
10 1680	Reel Pump Drive, 54.50"	AM1979607C1	\$ 26.00
11 1640, 1660	Rotor Drive	AM244420A1	\$ 311.00
11 1680	Rotor Drive	AM244422A1	\$ 321.00
12 1640, 1660	Separator Drive	AM191241C3	\$ 301.00

Prices Subject to Change without Prior Notice. The use of original equipment manufacturer (OEM) part numbers or trademarks, e.g. Case® and John Deere®, are for reference purposes only and for indicating product use and compatibility. Our company and the listed replacement parts contained herein are not sponsored, approved or manufactured by the OEM. All parts are New unless designated Reman in the description.

Case IH®—Combine

Application	Description	Part Number	Retail Price
12 1680	Separator Drive	AM1330499C1	\$ 163.00
13 1640, 1660	Straw Chopper Drive	AM1315265C1	\$ 68.00
13 1640, 1660, 1680	Straw Chopper Drive	AM1315266C1	\$ 89.00
14 1640, 1660, 1680	Straw Spreader Drive	AM196371C1	\$ 66.00

Belts—1644, 1666, 1688, 2144, 2166, 2188

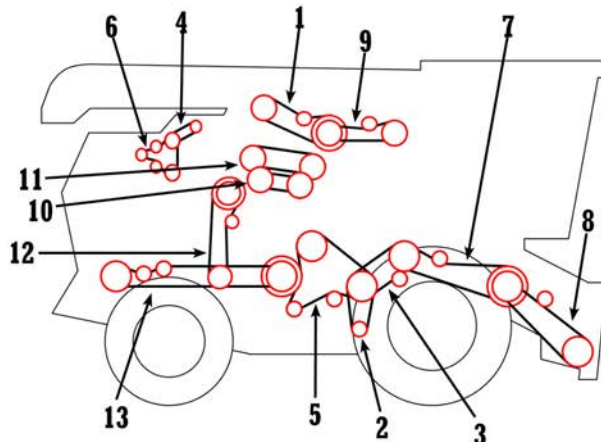

Application	Description	Part Number	Retail Price
1 2188	Auxiliary Pump Drive	AM124573A1	\$ 75.00
1 1644	Auxiliary Pump Drive	AM1347387C1	\$ 72.00
1 1666	Auxiliary Pump Drive	AM1541699C1	\$ 67.00
1 1688, 2144	Auxiliary Pump Drive	AM1541700C1	\$ 78.00
2 1644, 1666, 1688, 2144, 2166, 2188	Cleaning Fan Drive	AM1541569C1	\$ 63.00
3 1688, 2188	Cleaning Fan Jackshaft Drive	AM317904A1	\$ 79.00
3 1644, 1666, 2166	Cleaning Fan Jackshaft Drive	AM191305C1	\$ 62.00
4 1644, 2144	Compressor, AC	AM1250587C1	\$ 12.00
4 1666, 1688, 2166, 2188	A/C Compressor	AM396829R1	\$ 6.84
5 1644, 1666, 1688, 2144, 2166, 2188	Elevator Drive, w/ Chopper	AM181055C1	\$ 173.00
5 1644, 1666, 1688, 2144, 2166, 2188	Elevator Drive, w/ Discharge Beater	AM186509C2	\$ 199.00
6 1644, 2144	Fan, Alternator, Water Pump	AMJ911565	\$ 34.00
6 1666, 1688, 2166, 2188	Fan, Alternator, Water Pump	AMJ911572	\$ 50.00
7 1688, 2188	Feeder Drive, w/ Rock Trap	AM1315074C1	\$ 263.00
7 1644, 1666, 2144, 2166	Feeder Drive, w/ Rock Trap	AM1315168C1	\$ 219.00
7 1644, 1666, 2144, 2166	Feeder Drive, w/o Rock Trap	AM192738C1	\$ 204.00
7 1688, 2188	Feeder Drive, w/o Rock Trap	AM194528C1	\$ 291.00
8 1644, 1666	Feeder Jackshaft Drive, 47" Feeder	AM1313095C2	\$ 173.00
8 1644, 1666, 1688, 2144, 2166, 2188	Feeder Jackshaft Drive, 54.50" Feeder	AM87629602	\$ 235.00
8 1688, 2144, 2166, 2188	Feeder Jackshaft Drive, 60" Feeder	AM393750A1	\$ 313.00
9 1644, 1666	Grain Tank Unloader Drive	AM1989216C1	\$ 83.00
9 1688, 2188	Grain Tank Unloader Drive	AM1989217C1	\$ 96.00
10 1644, 1666, 2144, 2166	Rotor Drive, Variable	AM244420A1	\$ 311.00
10 1688, 2188	Rotor Drive	AM244422A1	\$ 321.00
11 1644, 1666, 2144, 2166	Separator Drive	AM191241C3	\$ 301.00
11 1688, 2188	Separator Drive	AM1541702C1	\$ 219.00
12 1644, 1666, 2144, 2166	Straw Chopper Drive	AM1315265C1	\$ 68.00

Case IH®—Combine

Application	Description	Part Number	Retail Price
12 1688, 1688, 2144, 2166, 2188	Straw Chopper Drive	AM1315266C1	\$ 89.00
13 1644, 1666, 1688, 2144, 2166, 2188	Straw Spreader Drive	AM196371C1	\$ 66.00

Belts—2344, 2366, 2377, 2388, 2577, 2588

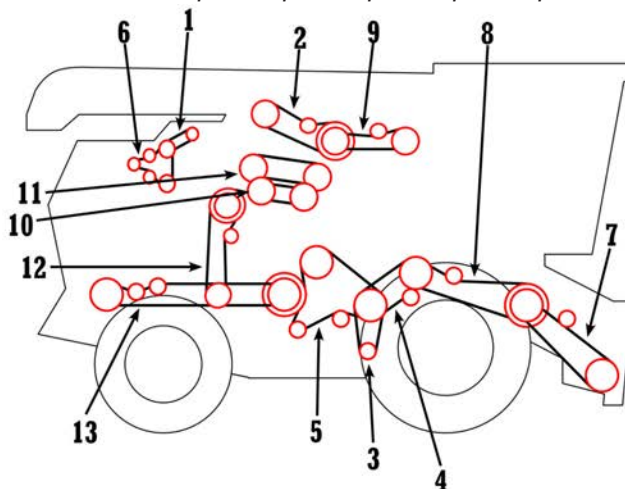

Application	Description	Part Number	Retail Price
1 2344	A/C Compressor	AM164550R2	\$ 14.00
1 2366 BSN JJC0255699, 2388 BSN JJC272999	A/C Compressor	AM396829R1	\$ 6.84
1 2366 ASN JJC0255700, 2377, 2388 ASN JJC0273000, 2388 SN HAJ292001-HAJ300000	A/C Compressor	AM235414A1	\$ 12.64
1 2388 ASN HAJ300001, 2577, 2588	A/C Compressor	AM87311867	\$ 14.30
2 2344	Auxiliary Pump Drive	AM1541700C1	\$ 78.00
2 2366	Auxiliary Pump Drive	AM124572A1	\$ 87.00
2 2377, 2388 ASN JJC0273000, 2388 ASN HAJ292001, 2577, 2588	Auxiliary Pump Drive	AM440498A3	\$ 100.00
3 2344, 2366 BSN JJC0184544, 2388 BSN JJC0198068	Cleaning Fan Drive	AM1541569C1	\$ 63.00
3 2366 ASN JJC0184544, 2377, 2388 ASN HAJ292001 & ASN JJC0198068, 2577, 2588	Cleaning Fan Drive	AM301146A1	\$ 44.00
4 2344, 2366 BSN JJC0184544	Cleaning Fan Jackshaft Drive	AM191305C1	\$ 62.00
4 2366 ASN JJC0184544	Cleaning Fan Jackshaft Drive	AM301111A1	\$ 52.00
4 2377, 2388, 2577, 2588	Cleaning Fan Jackshaft Drive	AM317904A1	\$ 79.00
5 2344, 2366, 2377, 2388, 2577, 2588	Elevator Drive, w/o Straw Chopper	AM186509C2	\$ 199.00
5 2344, 2366, 2377, 2388, 2577, 2588	Elevator Drive, w/ Straw Chopper	AM181055C1	\$ 173.00
6 2344	Engine Fan and Alternator	AMJ911565	\$ 34.00
6 2366 BSN JJC0255700, 2388 BSN JJC0273000	Engine Fan and Alternator	AMA77938	\$ 26.00
6 2366 ASN JJC0255700, 2377, 2388 ASN JJC0273000 & ASN HAJ292001, 2577, 2588	Engine Fan and Alternator Replaces A78022	AM87755884	\$ 28.00
7 2344, 2366, 2388 BSN JJC0268800	Feeder Jackshaft Drive, 54.50" Feeder	AM87629602	\$ 235.00
7 2344, 2366, 2388 BSN JJC0268800	Feeder Jackshaft Drive, 60" Feeder	AM3993750A1	\$ 313.00
7 2377, 2388 ASN JJC026880, 2388 ASN HAJ292001, 2577, 2588	Feeder Jackshaft Drive, 54.50" Feeder	AM402370A1	\$ 250.00
7 2377, 2388 ASN JJC026880, 2388 ASN HAJ292001, 2577, 2588	Feeder Jackshaft Drive, 60" Feeder	AM402368A1	\$ 235.00
8 2344, 2366	Feeder Drive w/o Rock Trap	AM192738C1	\$ 204.00
8 2344, 2366	Feeder Drive, w/ Rock Trap	AM1315168C1	\$ 219.00
8 2377, 2388, 2577, 2588	Feeder Drive w/o Rock Trap	AM194528C1	\$ 291.00
8 2377, 2388, 2577, 2588	Feeder Drive, w/ Rock Trap	AM1315074C1	\$ 263.00
9 2344, 2366	Grain Tank Unloader Drive	AM191290C1	\$ 77.00

Prices Subject to Change without Prior Notice. The use of original equipment manufacturer (OEM) part numbers or trademarks, e.g. Case® and John Deere®, are for reference purposes only and for indicating product use and compatibility. Our company and the listed replacement parts contained herein are not sponsored, approved or manufactured by the OEM. All parts are New unless designated Reman in the description.

Case IH®—Combine

Application	Description	Part Number	Retail Price
9 2377, 2388, 2577, 2588	Grain Tank Unloader Drive	AM1989217C1	\$ 96.00
10 2344, 2366	Rotor Drive	AM244420A1	\$ 311.00
10 2377 BSN HAJ0295001, 2388 SN JJC0273001-HAJ02955001	Rotor Drive	AM413159A1	\$ 324.00
10 2388 BSN JJC0273000	Rotor Drive	AM244423A1	\$ 383.00
10 2377 ASN HAJ0295001, 2388 ASN JJC0295001, 2577, 2588	Rotor Drive Replaces 87301455	AM84194650	\$ 307.00
11 2344, 2366	Separator Drive	AM191241C3	\$ 301.00
11 2377, 2388 ASN JJC0270500, 2388 ASN HAJ292001, 2577, 2588	Separator Drive	AM400427A1	\$ 301.00
11 2388 BSN JJC0270500	Separator Drive	AM1541702C1	\$ 219.00
12 2344, 2366	Straw Chopper Drive	AM1315265C1	\$ 68.00
12 2344, 2377, 2388, 2577, 2588	Straw Chopper Drive	AM1315266C1	\$ 89.00
13 2344, 2366, 2377, 2388, 2577, 2588	Straw Spreader	AM196371C1	\$ 66.00

Belts—5088, 6088, 7088

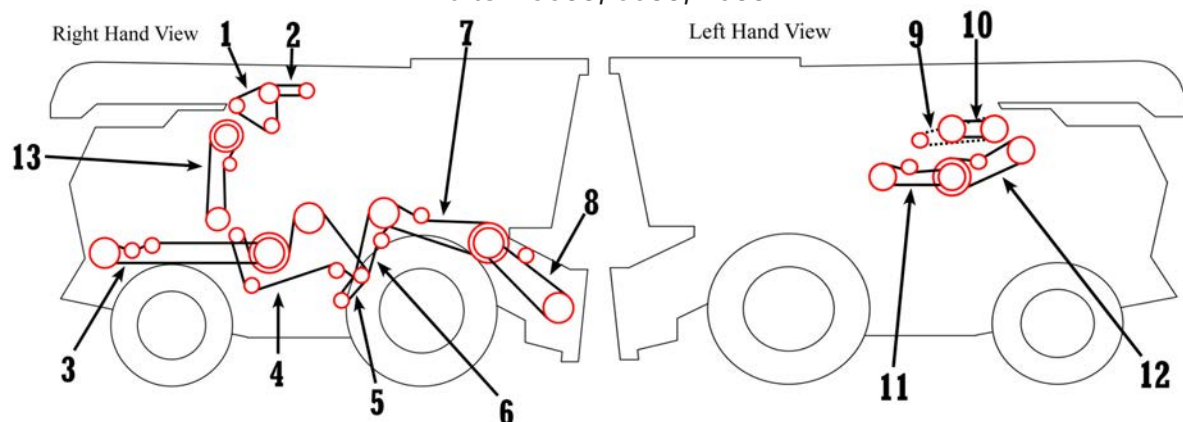

Application	Description	Part Number	Retail Price
1 5088, 6088, 7088	Fan Drive Replaces A78022	AM87755884	\$ 28.00
2 5088, 6088, 7088	A/C Compressor	AM87311867	\$ 14.30
3 5088, 6088, 7088	Straw Spreader Drive Replaces 87608414	AM84163222	\$ 68.00
4 5088, 6088, 7088	Cleaning System Drive, w/ Beater	AM186509C2	\$ 199.00
4 5088, 6088, 7088	Cleaning System Drive, w/ Straw Chopper	AM181055C1	\$ 173.00
5 5088, 6088, 7088	Cleaning Fan Drive	AM301146A1	\$ 44.00
6 5088, 6088, 7088	Fan Jackshaft Drive	AM87642957	\$ 50.00
7 5088, 6088, 7088 - w/ Rock Trap	Feederhouse Drive	AM87629601	\$ 245.00
7 5088, 6088, 7088 - w/o Rock Trap	Feederhouse Drive	AM87629602	\$ 235.00
8 5088, 6088, 7088 - w/ Rock Trap	Header Drive	AM87332159	\$ 199.00
8 5088, 6088, 7088 - w/o Rock Trap	Header Drive	AM87332161	\$ 195.00
9 5088, 6088, 7088	Separator Drive	AM84137716	\$ 241.00
10 5088	Rotor Drive	AM413159A1	\$ 324.00
10 5088, 6088, 7088	Rotor Drive Replaces 87301455	AM84194650	\$ 307.00
10 6088, 7088	Rotor Drive	AM87615553	\$ 371.00
11 5088	Unloader Drive	AM87566055	\$ 64.00
11 6088, 7088	Unloader Drive	AM87549557	\$ 130.00
12 5088, 6088, 7088	Auxiliary Pump Drive	AM87330894	\$ 90.00

Case IH®—Combine

Application	Description	Part Number	Retail Price
12 5088, 6088, 7088	Auxiliary Pump Drive Replaces 87549556	AM87283315	\$ 120.00
13 5088, 6088, 7088	Straw Chopper Drive	AM87330903	\$ 82.00
13 6088	Straw Chopper Drive	AM1315266C1	\$ 89.00

Belts—5130, 6130, 7130

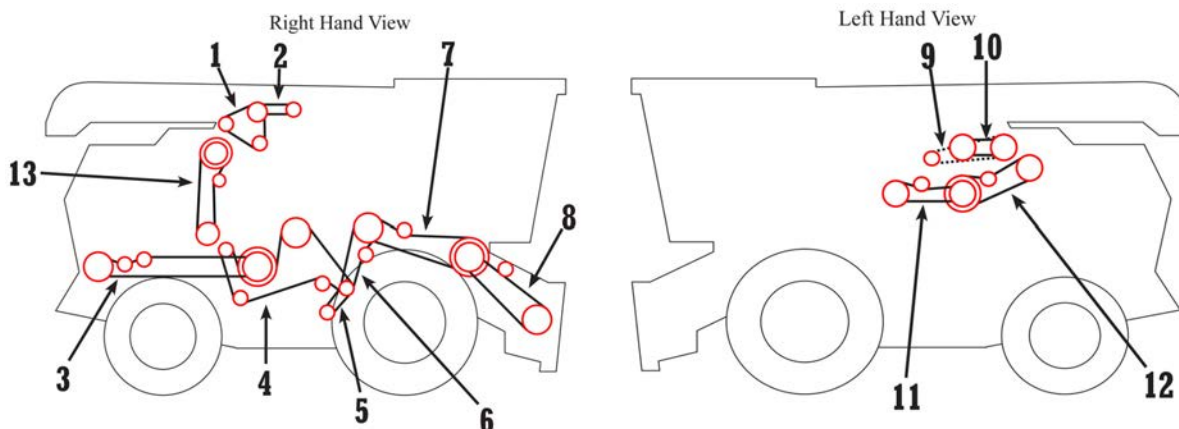

Application	Description	Part Number	Retail Price
1 5130, 6130, 7130	Engine Fan Drive	AM84150266	\$ 31.65
2 5130, 6130, 7130	A/C Compressor	AM84292913	\$ 40.00
2 5130	A/C Compressor	AM87489502	\$ 17.76
3 5130, 6130, 7130	Straw Spreader Drive Replaces 87608414	AM84163222	\$ 68.00
4 5130, 6130, 7130	Cleaning System Drive, w/ Beater	AM186509C2	\$ 199.00
4 5130, 6130, 7130	Cleaning System Drive, w/ Straw Chopper	AM181055C1	\$ 173.00
5 5130, 6130, 7130	Fan Jackshaft Drive, Lower	AM301146A1	\$ 44.00
6 5130, 6130, 7130	Fan Jackshaft Drive, Upper	AM87642957	\$ 50.00
7 5130, 6130, 7130 - w/ Rock Trap	Feederhouse Drive	AM87629601	\$ 245.00
7 5130, 6130, 7130 - w/o Rock Trap	Feederhouse Drive	AM87629602	\$ 235.00
8 5130, 6130, 7130 - w/ Rock Trap	Header Drive, Single Speed	AM87332161	\$ 195.00
8 5130, 6130, 7130 - w/ Rock Trap	Header Drive, 2-Speed	AM87332159	\$ 199.00
8 5130, 6130, 7130 - w/o Rock Trap	Header Drive	AM84365262	\$ 308.00
9 5130, 6130, 7130	Separator Drive 4 Banded Belt Replaces 84406044	AM84586129	\$ 293.00
10 5130	Rotor Drive	AM413159A1	\$ 324.00
10 5130, 6130, 7130 - w/ Common Cab	Rotor Drive	AM87615553	\$ 371.00
11 5130, 6130, 7130	Unloader Drive	AM87566055	\$ 64.00
11 6130, 7130	Unloader Drive	AM87549557	\$ 130.00
12 5130, 6130, 7130 - w/ Common Cab	Unloader Drive Mid Jackshaft, Left Hand Replaces 84149661	AM84548651	\$ 108.50
13 5130, 6130, 7130	Straw Chopper Drive	AM87330903	\$ 82.00
NI 5130	Alternator	AM84312027	\$ 28.55
NI 5130, 6130, 7130	Air Screen Drive	AM87583785	\$ 14.64

Case IH®—Combine

Belts—5140, 6140, 7140

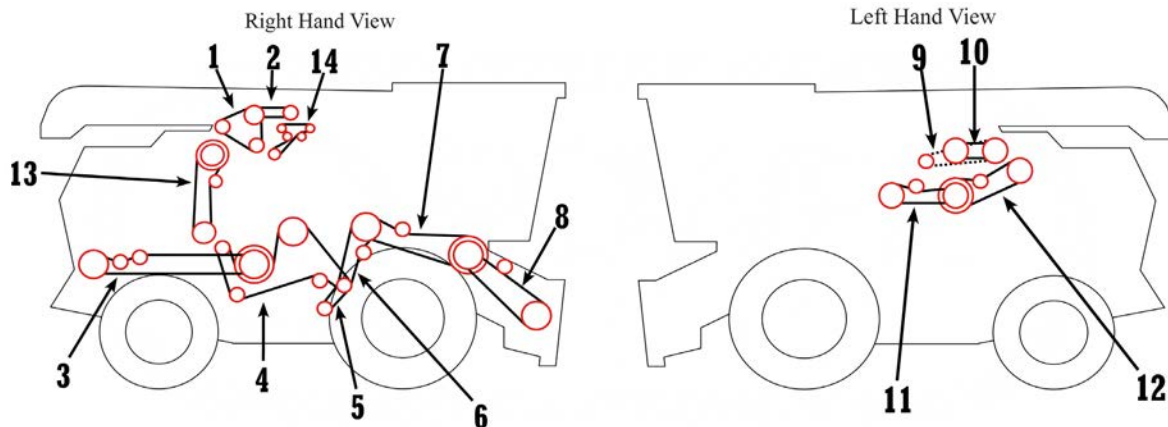

Application	Description	Part Number	Retail Price
1 5140, 6140, 7140 - 03/2014-10/15	Engine Fan Drive Set of 2	AM84150266	\$ 31.65
2 5140, 6140, 7140	A/C Compressor	AM87489502	\$ 17.76
2 5140, 6140, 7140	A/C Compressor	AM84292913	\$ 40.00
3 (5140, 6140, 7140 - 03/2014-10/15)	Straw Spreader Drive Replaces 87608414	AM84163222	\$ 68.00
4 5140, 6140, 7140 (03/2014-10/15)	Cleaning System Drive, w/ Beater	AM186509C2	\$ 199.00
4 5140, 6140, 7140 (03/2014-10/15)	Cleaning System Drive, w/ Straw Chopper	AM181055C1	\$ 173.00
4 (5140, 6140, 7140 10/2015 ASN YFG014001), (5150, 6150, 7150 - Prior to 2021)	Cleaning System Drive	AM84230076	\$ 135.55
5 5140, 6140, 7140 (03/2014-10/15)	Cleaning Fan Drive	AM301146A1	\$ 44.00
6 5140, 6140, 7140	Cleaning Fan, Jackshaft	AM84230075	\$ 197.11
6 5140, 6140, 7140 (03/2014-10/15)	Cleaning Fan, Jackshaft	AM87642957	\$ 50.00
7 5140, 6140, 7140 - w/ Rock Trap	Feederhouse Drive	AM87629601	\$ 245.00
7 5140, 6140, 7140 - w/o Rock Trap	Feederhouse Drive	AM87629602	\$ 235.00
8 5140, 6140, 7140 BSN YEG012701 - w/ Rock Trap	Header Drive	AM87332161	\$ 195.00
9 5140, 6140, 7140	Separator Drive 4 Banded Belt Replaces 84406044	AM84586129	\$ 293.00
10 5140	Rotor Drive	AM413159A1	\$ 324.00
10 5140, 6140, 7140	Rotor Drive Replaces 87301455	AM84194650	\$ 307.00
10 5140 (Tier 4B), 6140, 7140	Rotor Drive	AM87615553	\$ 371.00
11 5140, 6140, 7140	Unloader Drive	AM87566055	\$ 64.00
11 5140, 6140, 7140	Unloader Drive	AM87549557	\$ 130.00
12 5140, 6140, 7140 - 03/2014-10/15 w/ Tier 4B Engine	Unloader Drive Mid Jackshaft, Left Hand Replaces 84149661	AM84548651	\$ 108.50
13 5140, 6140, 7140	Straw Chopper Drive	AM87330903	\$ 82.00
14 5140, 6140, 7140	Alternator	AM84312027	\$ 28.55
NI 5140, 7140	Beater Drive	AM47655498	\$ 51.94
NI 5140, 6140, 7140	Air Screen Drive, Stationary	AM87583785	\$ 14.64

Case IH®—Combine

Belts—5150, 6150, 7150

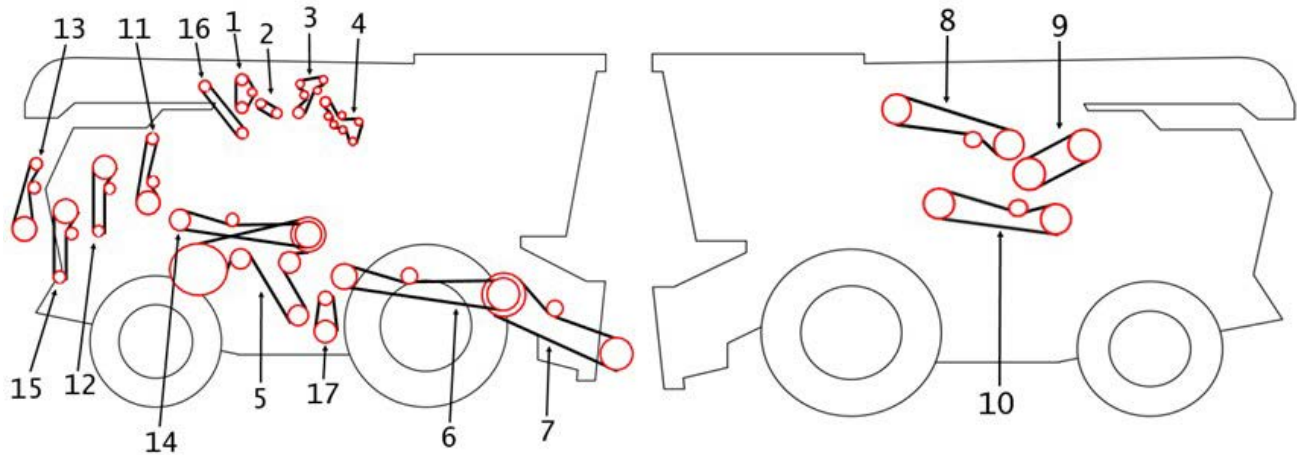

Application	Description	Part Number	Retail Price
1 5150, 6150, 7150	Engine Fan Drive	AM47708569	\$ 42.00
2 5150	A/C Compressor	AM87489502	\$ 17.76
3 5150	Alternator	AM84312027	\$ 28.55
4 6150, 7150	A/C Compressor	AM84292913	\$ 40.00
5 5150, 6150, 7150 - Prior to 2021	Cleaning System Drive	AM84230076	\$ 135.55
6 5150, 6150, 7150 - w/ Rock Trap	Feederhouse Drive	AM87629601	\$ 245.00
6 5150, 6150, 7150 - w/o Rock Trap	Feederhouse Drive	AM87629602	\$ 235.00
7 5150, 6150, 7150 - w/ Rock Trap	Header Drive	AM47455617	\$ 233.00
7 5150, 6150, 7150 - w/o Rock Trap	Header Drive	AM47616842	\$ 401.00
8 5150, 6150, 7150	Separator Drive 4 Banded Belt Replaces 84406044	AM84586129	\$ 293.00
9 5150	Rotor Drive	AM413159A1	\$ 324.00
9 5150 (Tier 3), 6150, 7150	Rotor Drive	AM87615553	\$ 371.00
10 5150, 6150, 7150	Unloader Drive	AM47360559	\$ 200.00
11 5150, 6150, 7150	Straw Chopper Flail Drive, Low Speed	AM47920775	\$ 119.48
12 5150, 6150, 7150	Straw Chopper Flail Drive, High Speed	AM47597575	\$ 129.00
13 5150, 6150, 7150	Beater Drive	AM47655498	\$ 51.94
14 5150, 6150, 7150	Elevator Jackshaft Drive	AM84230075	\$ 197.11
15 5150, 6150, 7150	Straw Chopper Drive	AM87330903	\$ 82.00
16 5150, 6150, 7150	Air Screen	AM87583785	\$ 14.64
17 5150, 6150, 7150	Variable Cleaning Fan	AM84238446	\$ 44.50

Case IH®—Combine

Belts—7010, 7120, 8010, 8120, 9120

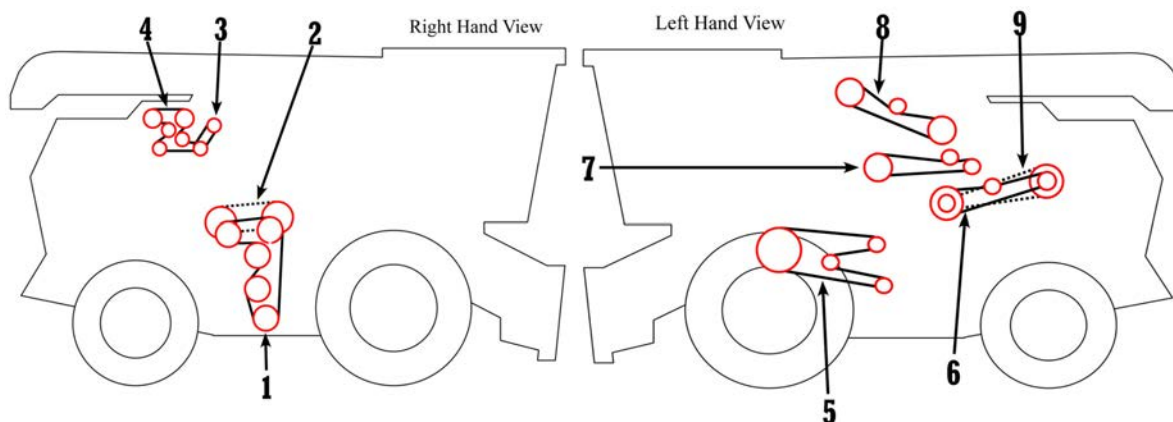

Application	Description	Part Number	Retail Price
1 7010, 7120, 8010 ASN HAJ105207, 8120, 9120	Tailings Drive	AM87283139	\$ 74.00
1 8010 BSN HAJ105207	Tailings Drive	AM87109130	\$ 98.00
2 7010, 7120, 8010, 8120, 9120	Bubble Up Drive, Right Hand	AM86975809	\$ 64.00
3 7010, 7120	Fan Drive	AM87526140	\$ 19.75
3 7010, 7120, 8010, 8120, 9120	Fan Drive	AM500371653	\$ 38.00
3 8010, 8120	Fan Drive	AM87282305	\$ 39.50
3 9120	Fan Drive	AM504049425	\$ 63.52
4 7010, 7120, 8010, 8120, 9120	A/C, Alternator and Water Pump	AM504212528	\$ 18.53
4 8010, 8120	A/C, Alternator and Water Pump	AM87282333	\$ 22.00
5 7010, 7120, 8010, 8120, 9120	Shoe Drive	AM87317063	\$ 48.00
6 7010, 7120, 8010, 8120, 9120	Beater Drive 3 Banded Belt Replaces 48114650	AM86517680	\$ 109.00
7 7010, 7120, 8010, 8120, 9120	Unloader Drive 2 Banded Belt	AM87011585	\$ 94.00
8 7010, 7120, 8010, 8120, 9120	Bubble Up Drive, Left Hand	AM86975809	\$ 64.00
9 7010, 7120, 8010 BSN JAH202001, 8120, 9120 - w/ 2800 RPM	Straw Chopper Drive, Inner Replaces 87549556	AM87283315	\$ 120.00
9 (7010, 8010 ASN HAJ202001), 7120, 8120, 9120 - w/ 3000 RPM	Straw Chopper Drive, Inner	AM86976208	\$ 112.00
NI 7120	A/C Drive Replaces 87592007, 504368979	AM84238514	\$ 11.50
NI 7010, 8010, 8120	Alternator	AM504049425	\$ 63.52
NI 7010, 7120, 8010, 8120	Rotary Screen (Lower)	AM87607871	\$ 16.00
NI 7010, 8010, 9120	Rotary Screen (Lower)	AM87733431	\$ 15.84
NI 7120, 8010, 8120	Rotary Screen (Upper)	AM86514512	\$ 30.00
NI 9120	Rotary Screen (Upper)	AM9842161	\$ 54.00

Case IH®—Combine

Belts—7230, 8230, 9230

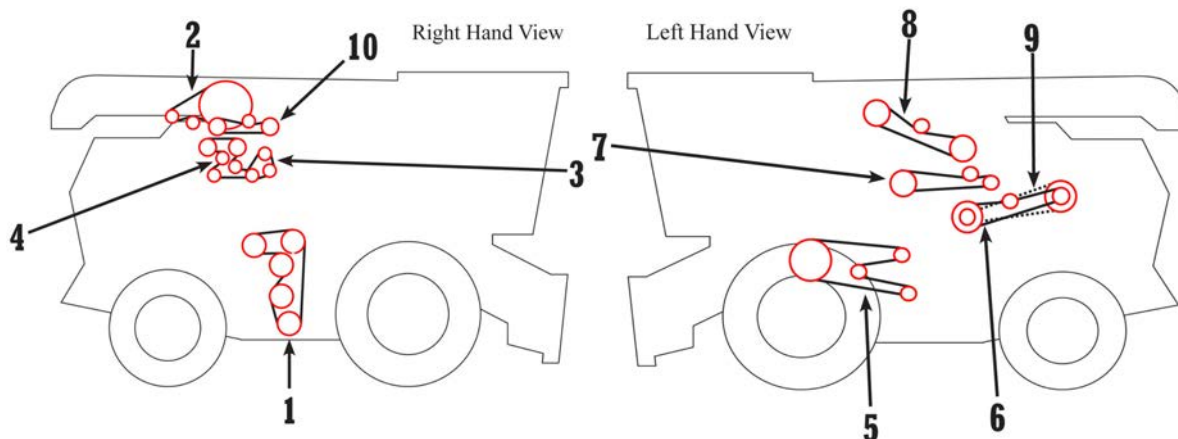

Application	Description	Part Number	Retail Price
1 7230, 8230, 9230	Tailings Drive	AM87283139	\$ 74.00
2 7230, 9230	Rotary Screen (Upper)	AM86514512	\$ 30.00
2 7230, 8230, 9230	Rotary Screen (Upper)	AM9842161	\$ 54.00
3 7230, 8230, 9230	Fan Drive	AM87526140	\$ 19.75
3 8230, 9230	Fan Drive	AM47490848	\$ 29.96
4 7230, 8230, 9230	Engine Belt Replaces 47452304	AM84292639	\$ 22.00
4 8230, 9230	A/C Drive Replaces 87592007, 504368979	AM84238514	\$ 11.50
4 8230, 9230	Alternator	AM504049425	\$ 63.52
5 7230, 8230, 9230	Shoe Drive	AM87317063	\$ 48.00
6 7230, 8230, 9230	Beater Drive 3 Banded Belt Replaces 48114650	AM86517680	\$ 109.00
7 7230, 8230, 9230	Unloader Drive, Standard 3 Banded Belt	AM84376860	\$ 97.00
7 7230, 8230, 9230	Unloader Drive, Dual Drive	AM84345673	\$ 51.00
7 7230, 8230, 9230	Unloader Drive, Dual Drive 2 Banded Belt	AM84345674	\$ 85.00
8 7230, 8230, 9230	Bubble Up Auger Drive	AM86975809	\$ 64.00
9 7230, 8230, 9230	Straw Chopper Drive, Inner	AM86976208	\$ 112.00
10 7230, 8230, 9230	Rotary Screen (Lower)	AM87607871	\$ 16.00
10 7230, 8230, 9230	Rotary Screen (Lower)	AM87733431	\$ 15.84
NI 7230, 8230, 9230	Cleaning Fan Drive	AM87683178	\$ 31.00
NI 8230, 9230	Transmission Belt	AM504049425	\$ 63.52
NI 9230 w/ Common Cab 01/2013-09/14 w/o Rock Trap	Header Drive	AM84365262	\$ 308.00

Case IH®—Combine

Belts—7240, 8240, 9240

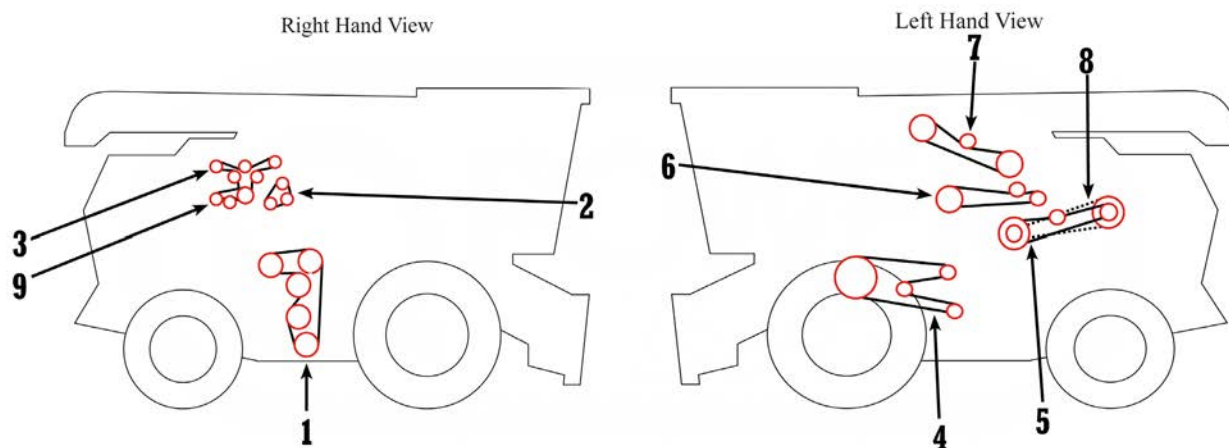

Application	Description	Part Number	Retail Price
1 7240, 8240, 9240	Tailings Drive	AM87283139	\$ 74.00
3 7240	Alternator	AM47506727	\$ 28.00
3 8240	Alternator	AM47513876	\$ 41.00
3 9240	Alternator	AM47569912	\$ 29.29
4 7240, 8240, 9240	Cleaning System	AM87317063	\$ 48.00
5 7240, 8240, 9240	Straw Chopper Drive, Outer 3 Banded Belt Replaces 48114650	AM86517680	\$ 109.00
6 7240, 8240	Unloader Drive, Single Drive 3 Banded Belt	AM84376860	\$ 97.00
6 7240, 8240, 9240	Unloader Drive, Dual Drive	AM84345673	\$ 51.00
6 7240, 8240, 9240	Unloader Drive, Dual Drive 2 Banded Belt	AM84345674	\$ 85.00
7 7240, 8240, 9240	Clean Grain Elevator	AM86975809	\$ 64.00
8 7240, 8240, 9240	Straw Chopper Drive, Inner	AM86976208	\$ 112.00
8 7240, 8240, 9240 - w/ 3000 RPM	Straw Chopper Drive, Inner 3 Banded Belt	AM47705826	\$ 103.00
8 7240, 8240, 9240 - MY18 w/ Redekop™ Straw Chopper	Straw Chopper Drive, Inner 135" Long	AM51407097	\$ 225.00
9 7240, 8240	A/C Compressor Replaces 87592007, 504368979	AM84238514	\$ 11.50

Case IH®—Combine

Belts—7250, 8250, 9250

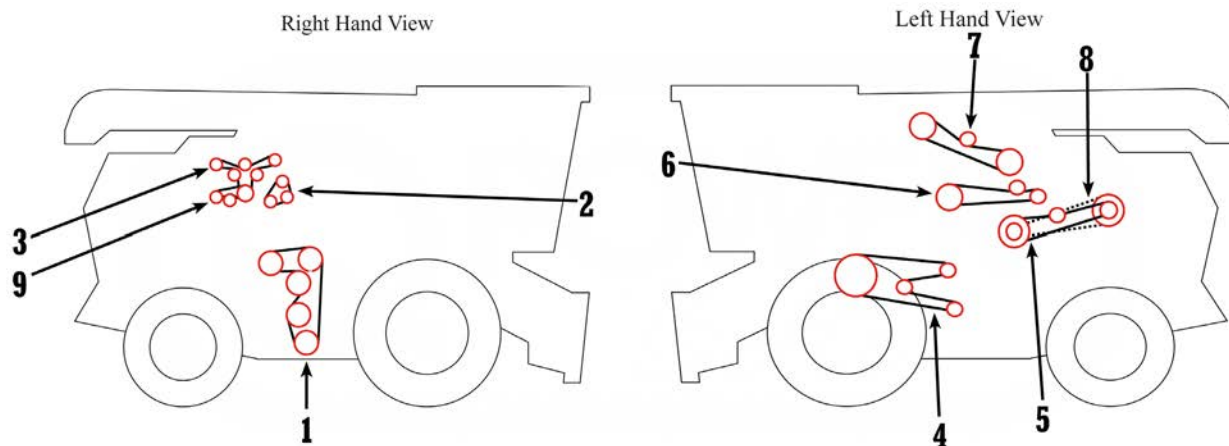

Application	Description	Part Number	Retail Price
1 7250, 8250, 9250	Tailings Processor	AM87283139	\$ 74.00
2 7250, 8250	Engine Fan Drive	AM47411931	\$ 44.69
3 7250	Alternator	AM47506727	\$ 28.00
3 8250	Alternator	AM47513876	\$ 41.00
3 9250	Alternator	AM47569912	\$ 29.29
4 7250, 8250, 9250	Cleaning System	AM87317063	\$ 48.00
5 7250, 8250, 9250	Straw Chopper Drive, Outer 3 Banded Belt Replaces 48114650	AM86517680	\$ 109.00
5 7250, 8250, 9250 - w/ Redekop™ Straw Chopper	Straw Chopper Drive, Outer 2 Banded Belt	AM48035443	\$ 176.00
6 7250, 8250, 9250	Unloader Drive 2 Banded Belt	AM87011585	\$ 94.00
6 7250, 8250, 9250	Unloader Drive, Single Drive 3 Banded Belt	AM84376860	\$ 97.00
6 7250, 8250, 9250	Unloader Drive, Dual Drive	AM84345673	\$ 51.00
6 7250, 8250, 9250	Unloader Drive, Dual Drive 2 Banded Belt	AM84345674	\$ 85.00
7 7250, 8250, 9250	Clean Grain Elevator	AM86975809	\$ 64.00
8 7250, 8250, 9250 - w/ 3000 RPM	Straw Chopper Drive, Inner 3 Banded Belt	AM47705826	\$ 103.00
8 7250, 8250, 9250 - w/ Redekop™ Straw Chopper	Straw Chopper Drive, Inner 135" Long	AM51407097	\$ 225.00
9 7250, 8250, 9250	A/C Compressor Replaces 87592007, 504368979	AM84238514	\$ 11.50
NI 7250, 8250, 9250	Fan Drive	AM87683178	\$ 31.00
NI 9250	Vacuum Fan	AM47623161	\$ 21.04

Case IH®—Combine

Belts—Cotton Pickers & Swathers

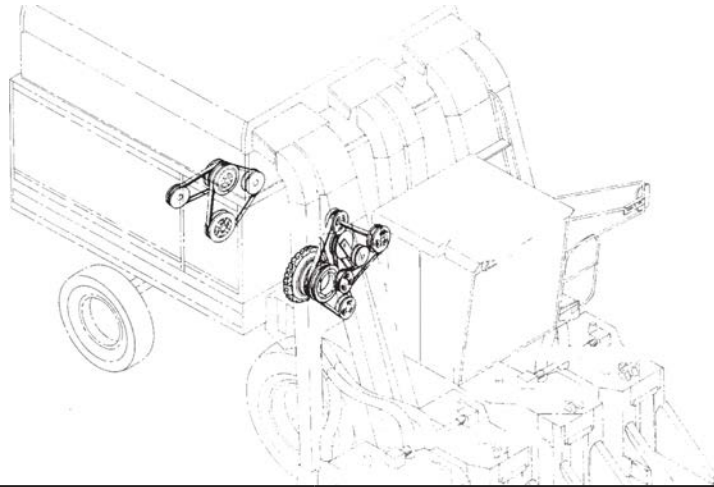

Application	Description	Part Number	Retail Price
782	Aux. Drum Drive	AM210185C1	\$ 61.50
782	Fan	AM214522C1	\$ 72.58
1822, 1844, 2022, 2044	Fan	AM1288899C5	\$ 112.00
2055, 2155	Fan Drive	AM1546117C2	\$ 119.00
420, 620, 625, 1844 ASN JJC002462, 2044, 2055, 2155, 2555, CPX420, CPX610, CPX620	Fan Drive, Front	AM1338328C1	\$ 78.00
420, 2555, CPX420, CPX610, CPX620 BSN Y6T0117	Fan Drive, Rear	AM1546117C2	\$ 119.00
782	Hyd. Pump	AM656349R1	\$ 8.90
1822, 1844, 2022, 2044	Hyd. Pump	AM1285320C1	\$ 65.18
420, 620, 625, 2055, 2155, 2555, CPX420, CPX610, CPX620	Auxiliary Pump Drive	AM1546118C1	\$ 79.00
1822, 1844, 2022, 2044	Middle Fan	AM1260258C2	\$ 44.50

Belts—Platforms

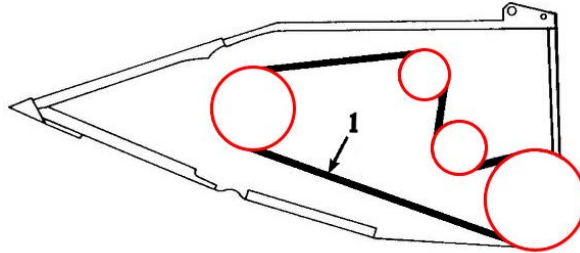

Application	Description	Part Number	Retail Price
1 1020	Platform Belt Replaces 1319245C1, 1319245C2, 1502461C1, 1866324R1	AM247428A1	\$ 78.00

Extended Wear Augers

Abilene Machine carries the best-built augers in the industry. Our in-house facility includes state-of-the-art equipment that balances, calibrates and tests our augers. These durable parts feature cupped flighting for longer life and greater grain-handling capacity.



Features and Benefits

Greater grain retention

Cupped Super-Edge™ Helicoid Flighting with enhanced edge thickness and up to 30° lean from vertical allows for increased grain-handling capability.

Increased wear resistance

Key edges of the Super-Edge™ Helicoid Flighting are up to 50% thicker (and a guaranteed minimum of 30% thicker) than standard augers. The tapered edges have targeted reinforcement, so our augers are stronger at the exact spots that tend to wear more easily, giving them a longer life in the field.

Improved strength and durability

Advancements in the Super-Edge™ Helicoid Flighting mean farmers have a stronger auger without extra weight and a more durable part.

Optimized output

With a longer life and higher grain capacity, our augers provide productivity gains over a much longer period, significantly reducing the cost per bushel.

Abilene Machine is a family-owned and operated company that's been serving farmers for over 40 years. With an inventory of more than 40,000 parts and four locations across the United States, we'll make sure you get dependable, durable parts shipped fast.

Abilene, Kansas
Bishopville, South Carolina
Sioux Falls, South Dakota
Billings, Montana

785-670-6741
AbileneMachine.com

All parts are new unless designated remanufactured in the description. Products listed are replacement parts only — not original equipment manufacturers. OEM names and brands are used for identification purposes only.

Air Conditioning Parts and Components



Blower Motors • Compressors • Condensers
Evaporators • Expansion Valves • Receiver Driers

LEDs Light Up Your World

LEDs are extremely energy efficient & more durable than traditional incandescent light bulbs. Other benefits include a much longer lifespan, reduced maintenance costs and higher safety.



LED kits and single replacement lights available for tractors, combines, harvesters, balers, loaders, skid steers, telehandlers and more.

Grammer® Seats & Suspensions

COMFORT THAT NEVER QUILTS

Grammer® seats are designed ultimately for the people who use them. Maximum comfort and intuitive operation are therefore major design principles.

For years, Grammer® has worked intimately with leading scientists researching the human spine. These findings then flow directly into their product development. You can feel it in every seat they design.

**After all, the operator shouldn't fit the seat;
the seat should fit the operator.**



Abilene Machine LLC

785-670-6741

Kansas | Montana | South Carolina | South Dakota

AbileneMachine.com



Agricultural and Industrial Belts



Q Power® uses the highest quality materials and the most advanced manufacturing in the world to build their belts.

Quality always comes through

New, Used and Remanufactured

Honest. Personal. Service.

Draper Belts

Abilene Machine is proud to offer the Q-Power[®] line of heavy-duty draper belts to keep up with the demands of harvest. These best-selling products are comparable to OEM parts in tensile strength, tear strength and puncture resistance. They are exceptional replacements for many makes, including John Deere[®], New Holland[®], Case IH[®] and MacDon[®].

Features and Benefits

Teardrop Cleats for Better Durability

Our draper belts are reinforced with teardrop-shaped fiberglass rods for increased cross-directional strength and durability.

Teardrop vs Diamond Cleat



Filament Fibers for Increased Tensile Strength

The patented design is made with filament fibers — long, continuous, uniform fibers — that consistently outperform belts made from typical spun fiber in strength tests. They stand up better to stretching and pulling than the competition.

Coated for Enhanced Tear and Puncture Resistance

Q-Power[®] Draper Belts feature both skim and friction coating for enhanced performance. This rubber reinforcement is applied to the top (skim) and bottom (friction) of the belt, increasing durability and fabric protection, while reducing drag and belt weight.

Abilene Machine is a family-owned and operated company that's been serving farmers for over 40 years. With an inventory of more than 40,000 parts and four locations across the United States, we'll make sure you get dependable, durable parts shipped fast.

Q-Power[®] is 29.5% stronger

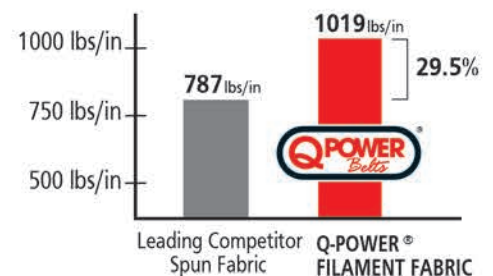

Q-Power[®] is 18.1% more tear resistant

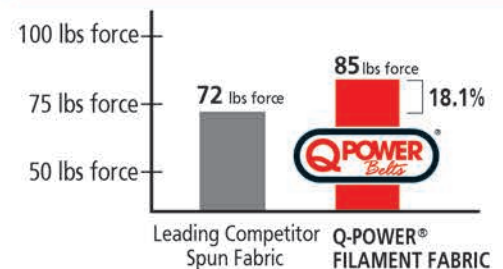

Q-Power[®] is 81.7% more puncture resistant

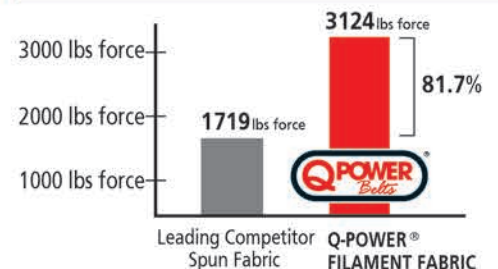

Abilene, Kansas
Bishopville, South Carolina
Sioux Falls, South Dakota
Billings, Montana

785-670-6741
AbileneMachine.com

All parts are new unless designated remanufactured in the description. Products listed are replacement parts only — not original equipment manufacturers. OEM names and brands are used for identification purposes only.



Abilene Machine LLC
P.O. Box 129
Abilene, KS 67410
(785) 670-6741

Honest. Personal. Service.

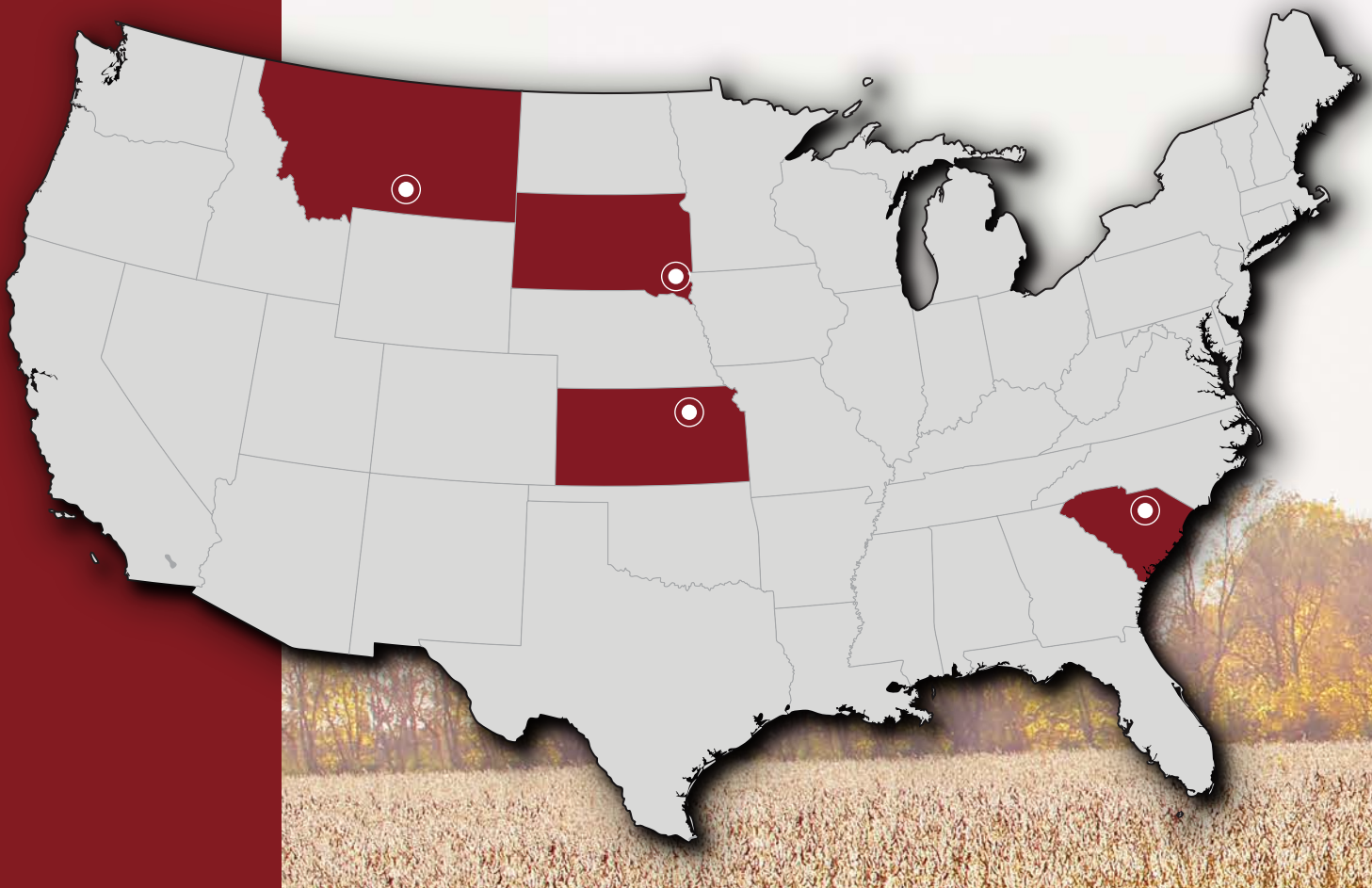

Abilene Machine LLC
(785) 670-6741



AbileneMachine.com



 Follow Abilene Machine on Facebook