



AbileneMachine[®]
Ag Replacement Parts

**FOR FORD[®]/NEW HOLLAND[®]
TRACTORS**



AbileneMachine.com

NEW My Shed Feature on AbileneMachine.com

A new way to narrow down your parts search geared specifically to your equipment

Select the make, equipment and model of your machine in the dropdown menus located at the top of the home page. Click the "Go" button.

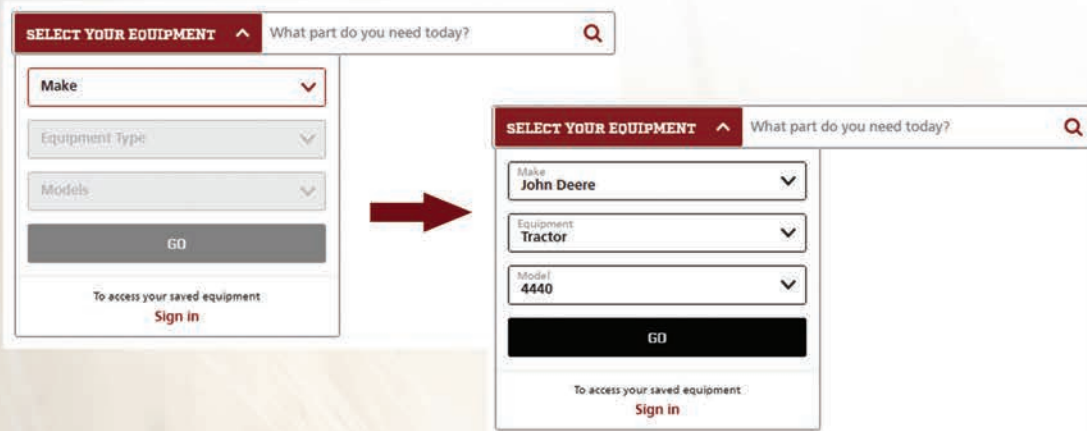

SELECT YOUR EQUIPMENT ^ What part do you need today?

Make

Equipment Type

Models

GO

To access your saved equipment
[Sign in](#)

SELECT YOUR EQUIPMENT ^ What part do you need today?

Make **John Deere**

Equipment **Tractor**

Model **4440**

GO

To access your saved equipment
[Sign in](#)

With your equipment selected, enter the product you are searching for (or part number if you have it). Suggested results will be displayed, or press enter to go to a list of all product results for your machine.

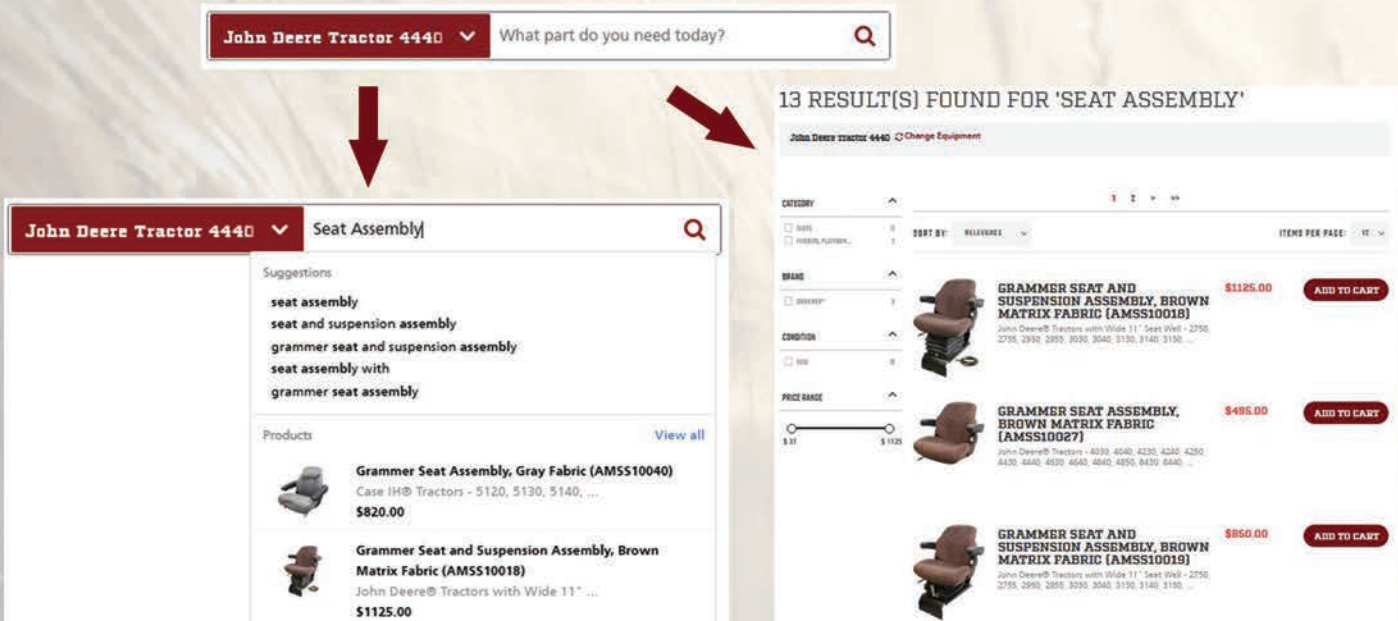



John Deere Tractor 4440 ^ What part do you need today?

John Deere Tractor 4440 ^ **Seat Assembly**

Suggestions

- seat assembly
- seat and suspension assembly
- grammer seat and suspension assembly
- seat assembly with grammer seat assembly

Products [View all](#)

-  **Grammer Seat Assembly, Gray Fabric (AMSS10040)**
Case IH® Tractors - 5120, 5130, 5140, ...
\$820.00
-  **Grammer Seat and Suspension Assembly, Brown Matrix Fabric (AMSS10018)**
John Deere® Tractors with Wide 11" ...
\$1125.00



13 RESULT(S) FOUND FOR 'SEAT ASSEMBLY'

John Deere tractor 4440 [Change Equipment](#)

CATEGORY

SEARCH BY: **RELEVANCE**

ITEMS PER PAGE:

-  **GRAMMER SEAT AND SUSPENSION ASSEMBLY, BROWN MATRIX FABRIC (AMSS10018)** **\$1125.00** [ADD TO CART](#)
John Deere® Tractors with Wide 11" Seat Well - 2750, 2755, 2850, 2855, 3030, 3040, 3130, 3140, 3150, ...
-  **GRAMMER SEAT ASSEMBLY, BROWN MATRIX FABRIC (AMSS10027)** **\$485.00** [ADD TO CART](#)
John Deere® Tractors - 4030, 4040, 4230, 4240, 4250, 4430, 4440, 4530, 4640, 4850, 4860, 4950, 4960, 4970, 4980, ...
-  **GRAMMER SEAT AND SUSPENSION ASSEMBLY, BROWN MATRIX FABRIC (AMSS10019)** **\$850.00** [ADD TO CART](#)
John Deere® Tractors with Wide 11" Seat Well - 2750, 2755, 2850, 2855, 3030, 3040, 3130, 3140, 3150, ...

With the My Shed feature, your equipment selections can now be saved to your account to make future searching convenient and easy!

Once you create an account to access "My Shed," your equipment can be saved and you can also view past order history. This makes yearly maintenance easier and faster when it comes to getting the parts you need.

To create an account, select the Account icon to the right of the search bar and select "Create an account."



Follow the next screen to enter your information and create the account. If you made an equipment selection in the parts search, it will automatically be added to "My Shed" and will also be viewable on your Account Dashboard. Additional equipment can be added by clicking the "Add Equipment" button from either screen (prompts the dropdown menu at the top to open again) or by going directly to the parts search at the top of the page and making a new selection. When you hit "Go," this selection is automatically added to your shed.

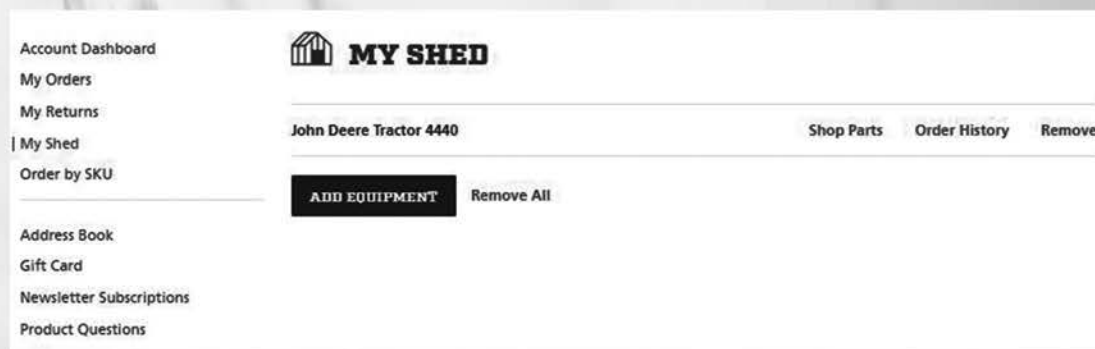

Quickly switch between equipment in your Shed by clicking the dropdown menu at the top of the page and selecting between machines. The page will reload to that selection and is ready to search for the products you need. As a thank you for reading about our new My Shed program, please use the code MYSHED for a 5% discount on one order through December 31, 2023.

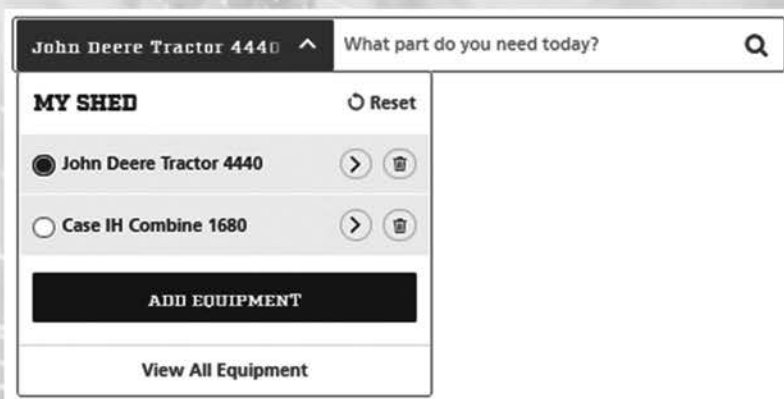

Abilene Machine LLC

Abilene, Kansas
Bishopville, South Carolina
Sioux Falls, South Dakota
Billings, Montana

785-670-6741 | abilenemachine.com

Ford® / New Holland® —Tractor

Table of Contents

Air Cleaner Components	29	MFWD Driveshafts	40
Air Conditioning and Components	84	MFWD Hub Components	35
Alternators	30	MFWD Hubs and Housings	32
Axle Center Tubes and Beams	50	Mufflers and Exhaust	26
Axle Knee Extensions	50	Oil Coolers, Engine	8
Battery Box Components	71	Oil Pumps, Engine	8
Belts	20	Overhaul Kits	4
Brake Components	64	Power Steering Cylinders and Components	50
Brake Shoes	63	Power Steering Gearbox Assembly and Components	65
Cab Components—Miscellaneous	80	Power Steering Orbit Motors	56
Cab Doors	81	Power Steering Pumps and Conversion Kits	55
Camshafts and Lifters	7	PTO Adapters	63
Carburetors	20	PTO Assembly Components	59
Connecting Rods	6	PTO Clutch Parts	61
Crankshaft Pulleys and Dampers	6	PTO Gears	63
Crankshafts	5	PTO Output Shafts	62
Cylinder Heads, Bare	7	PTO Shafts and Hubs	60
Differentials and Components	62	Quick Hitch Components	69
Distributors	29	Radiator Hoses	11
Drawbars and Components	65	Radiators and Components	9
Engine Fans and Components	16	Rear Axles and Components	62
Fan Clutches	20	Remote Valves	52
Fenders and Components	72	Rockshaft Components	67
Flywheels and Components	17	Sensors	31
Front Grilles, Nose Cones and Components	72	Shop Manuals and Collections	92
Fuel Components	21	Shortblock Assemblies	3
Fuel Lift Pumps	21	Side Panels and Hoods	71
Fuel Tanks	83	Spindles	45
Gas Struts	83	Starters	28
Glass	81	Steering Arms	49
Hammer Straps	67	Steering Shafts	65
Hydraulic Lift Components	69	Steering Wheels	84
Hydraulic Oil Coolers	52	Tachometers and Instrument Clusters	31
Hydraulic Pumps	53	Three Point Hitch Components	69
Hydrostats and Components	56	Tie Rods and Components	41
Injection Pumps	22	Toplink Assemblies	71
Injectors	23	Transmission Components	56
Lift Link Assemblies and Components	67	Transmission Discs	59
Lighting	72	Turbochargers	24
Longblock Assemblies	3	Water Pumps and Components	17
Lower Lift Links	68	Wheel Bearing Kits	48
Manifolds and Components	25	Wheel Hubs and Components	48
Manual Steering Gearbox Assemblies	65		
Mechanical Front Wheel Drive Parts	32		
MFWD Differentials and Components	37		

Ford® / New Holland® —Tractor



Longblock Assemblies

Our remanufactured longblocks meet the highest standards in quality. All remanufactured components are inspected for structural integrity, cracks and dimensional specifications and then remanufactured back to OEM specifications. The components are then assembled using the highest quality new parts. We back this with one of the best warranties in the industry.

Application	Description	Part Number	Retail Price	Core
8970, 8970A	Reman Longblock Assembly Replaces 87800718BR	LBFD456T8970	\$ 8900.00	\$ 2500.00
TW25, TW35	Reman Longblock Assembly	LBFD401TW35	\$ 7900.00	\$ 2500.00
TG215, TG275, TG305, T8010, T8020, T8030, T8040, Versatile® Tractors: 250, 305	Reman Longblock Assembly	LBCUM8304HPCR24V	\$ 11000.00	\$ 2000.00
Ind: (345C, 445C, 545C - 12/1988-08/92 w/ 3 Cylinder Engine), (345D, 445D - 09/1992-10/2000 w/ 3 Cylinder Engine), 545D 11/1988-2001 w/ 3 Cylinder Engine	Longblock Assembly	AM87801544	\$ 3750.00	\$ 1000.00
Combines: CR9040, CR9060	Reman Longblock Assembly Replaces 87603080, 87603080R	LBCUM8.9	\$ 12500.00	\$ 5000.00
T6010, TS100A	Reman Engine, Complete 4.5 Liter NF 45	AM87318785ER	\$ 8500.00	\$ 2500.00
T6030	New Engine, Complete 6.7 Liter NEF 67 Replaces 50427568ER	AM87318901ER	\$ 11000.00	\$ 5000.00
T6030, T6050, T6070, T6080	New Engine, Complete 6.7 Liter NEF 67 Replaces 87312077ER, 87516256ER	AM87312078ER	\$ 12500.00	\$ 5000.00
7840, 8240, 8340, TS115	New Engine, Complete Emission Engine Replaces 87800805, 87801845, 87840842	AM87802221	\$ 12500.00	\$ 5000.00
Combines: (CR9040, CR9060, CR9065, CR9070 BSN Y8G112001)	New Engine, Complete 10.3 Liter Iveco® Replaces 87283632	AM504099224	\$ 17500.00	\$ 7500.00

Shortblock Assemblies

Our remanufactured shortblocks meet the highest standards in quality. All remanufactured components are inspected for structural integrity, cracks and dimensional specifications and then remanufactured back to OEM specifications. The components are then assembled using the highest quality new parts. We back this with one of the best warranties in the industry. Camshafts and lifters are not included with these shortblocks and must be purchased separately.



Application	Description	Part Number	Retail Price	Core
3230, 3430, 3930, 4130, 4630 - w/ 201 Ford® Engine	Shortblock Assembly Includes cam gear, timing gears and steel timing plate	AM87800041	\$ 4100.00	\$ 500.00
5000, 5100, 5110, 5200, 5340, 5600, 5610, 5700, 6410, 6600, 6600C, 6600O, 6610, 6610O, 6700, 6710, 6810, 7000, 7100, 7200, 7410, 7600, 7600C, 7610, 7610O, 7700, 7710, Swather: 1118 - All w/ 268 4 Cylinder Diesel Engine	Shortblock Assembly Replaces 83904003, 83918888, 83944995	AM84227839	\$ 5000.00	
8670, 8770, 8870, 8970, Combine: TR88	Reman Shortblock Assembly Big Snout 8-Bolt Flywheel Mounting	SBFD456T	\$ 7380.00	\$ 1000.00
TW10 w/ 401 6 Cylinder Diesel Non-Turbo Engine	Reman Shortblock Assembly	SBFD401TW10	\$ 6350.00	\$ 750.00
TW20, TW30 - w/ 401 6 Cylinder Diesel Turbo Engine	Reman Shortblock Assembly	SBFD401TW30	\$ 6350.00	\$ 750.00
TW35 Late w/ 401 6 Cylinder Diesel Turbo Engine	Reman Shortblock Assembly w/ Auxiliary Drive Hole in Left Hand Rear Corner of Block	SBFD401TW35	\$ 6350.00	\$ 750.00

Ford® / New Holland®—Tractor



Overhaul Kits

Application	Description		Retail Price	Core
2N, 8N, 9N	120 Engine - Gas 0.04" Wall Thickness	Inframe Kit	\$ 236.00	
		Overhaul Kit	\$ 251.00	
600 & 700 Series, NAA	134 Engine - Gas	Inframe Kit	\$ 418.00	
		Overhaul Kit	\$ 383.00	
2000, 2100, 2110, 2120, 2300, 2310, 3000, 3055, 3100, 3120, 3190, 3330, 3400, 3500, 3550	158 Engine - Gas	Inframe Kit	\$ 573.00	
		Overhaul Kit	\$ 584.00	
2000, 2100, 2110, 2120, 2300, 2310	158 Engine - Diesel	Inframe Kit	\$ 395.00	
		Overhaul Kit	\$ 440.00	
800, 900, 1800 & 4000 Series	172 Engine - Gas Non-Sleeved	Inframe Kit	\$ 373.00	
		Overhaul Kit	\$ 389.00	
800 Series, 900 Series, 1800 Series, 4000 Series	172 Engine - Gas Sleeved	Inframe Kit	\$ 407.00	
		Overhaul Kit	\$ 435.00	
800, 900, 1800 & 4000 Series - 1958-81	172 Engine - Diesel Non-Sleeved	Inframe Kit	\$ 666.00	
		Overhaul Kit	\$ 729.00	
3000, 3100, 3110, 3120, 3150, 3190, 3300, 3310, 3330, 3400, 3500	175 Engine - Diesel	Inframe Kit	\$ 394.00	
		Overhaul Kit	\$ 403.00	
4000, 4100, 4110, 4140, 4190, 4200, 4330, 4340, 4400, 4500 - 1965-68	192 Engine - Gas	Inframe Kit	\$ 570.00	
		Overhaul Kit	\$ 548.00	
3610, 3910	192 Engine - Diesel	Overhaul Kit	\$ 438.00	
4000, 4100, 4110, 4140, 4190, 4200, 4330, 4340, 4400, 4410, 4500	201 Engine - Diesel 01/1965-05/69	Inframe Kit	\$ 419.00	
		Overhaul Kit	\$ 445.00	
4000, 4100, 4110, 4140, 4190, 4200, 4330, 4340, 4400, 4410, 4500, 4600, 4610, Ind: 515, 530A, 531, 532, 535, 540A, 540B, 545, 545A	201 Engine - Diesel 06/1969-12/74	Inframe Kit	\$ 401.00	
		Overhaul Kit	\$ 390.00	
5000, 5100, 5190, 5200, 5500, 5600, 5700	233 Engine - Diesel	Inframe Kit	\$ 517.00	
		Overhaul Kit	\$ 577.00	
5000, 5100, 5190, 5200, 5340, 5600, 5610, 5900, 6600, 6700, Ind/Const: 5500, 5550, 6500, Swathers: 907, 909, 910, 912, 1100, 1112, 1114, Mower Conditioner: 1495	256 Engine - Diesel	Inframe Kit	\$ 477.00	
		Overhaul Kit	\$ 491.00	
7000, 7100, 7200, 7500, 7600, 7700	256T Engine - Diesel	Inframe Kit	\$ 493.00	
		Overhaul Kit	\$ 570.00	
5610S, 5640	268 Engine - Diesel 09/1990-07/96	Inframe Kit	\$ 523.00	
		Overhaul Kit	\$ 573.00	
6600, 6610	268 Engine - Diesel	Inframe Kit	\$ 521.00	
6610, Ind: 655C, 655D	268 Engine - Diesel	Major Overhaul Kit	\$ 741.00	
6810, 7610, 7710, Ind: 755B	268T Engine - Diesel	Major Overhaul Kit	\$ 729.00	
7710	268T Engine - Diesel	Inframe Kit	\$ 490.00	

Ford® / New Holland®—Tractor

Application	Description		Retail Price	Core
7840	401 Engine - Diesel	Inframe Kit	\$ 998.00	
		Overhaul Kit	\$ 1209.00	
(7910, 8210, TW5 - Prior to 03/1986), 8000, 8600, 8700, TW10	401 Engine - Diesel	Inframe Kit	\$ 777.00	
		Overhaul Kit	\$ 878.00	
9000, 9600, 9700, TW15, TW20, TW25, TW30, TW35	401T Engine - Diesel	Inframe Kit	\$ 799.00	
		Overhaul Kit	\$ 898.00	
6640	304 Engine - Diesel	Inframe Kit	\$ 516.00	
		Overhaul Kit	\$ 566.00	
7740	304T Engine - Diesel, Non Emission	Inframe Kit	\$ 699.00	
		Overhaul Kit	\$ 607.00	
8240 Non-Turbo, 8340 Turbo and Non-Turbo	456 Engine - Diesel	Inframe Kit	\$ 1084.00	
		Overhaul Kit	\$ 1185.00	
3610, 3910	192 Engine - Diesel	Inframe Kit	\$ 361.00	

Crankshafts



Application	Description	Part Number	Retail Price	Core
2N, 8N, 9N	Crankshaft	AM9N6303A	\$ 414.00	
650, 5000 Major, 5000 Super Major, 5000, 5100, 5190, 5200, 5500, 5600, 5610, 5700, 6000, 6500, 6600, 6610, 6700, 6710, 7000, 7100, 7200, 7500, 7600, 7610, 7700, 7710, Combines: 620, 622 Replaces 1595N, 6110A	Crankshaft w/ Gear BSD442 4.2 Stroke 256 CID 4.2 Liter 4 Cylinder Engine 4.203" Stroke, 4.4007" - 4.4032" Bore, 2.7496" - 2.7504" Rod, 3.3713" - 3.3723" Main Flange - Centering Ring, 6 Bolt Holes, 1 Dowel Hole Snout - 1 Bolt Hole, 1 Keyway, w/ 78 Tooth Balance Drive Gear 12.50 mm Wide, Right Hand Helix	AMC5NE6303K	\$ 561.00	
801, 901, 1801, 4000 Series Replaces B9NN6302B	Crankshaft 172D 172 CID 2.8 Liter 4 Cylinder Diesel Engine 3.60" Stroke, 3.8998" - 3.9018" Bore, 2.2978" - 2.2988" Rod, 2.4978" - 2.4988" Main Flange - No Centering Ring, Flat, 6 Bolt Holes, 1 Dowel Hole Snout - Splined, 1 Keyway, w/ 74 Tooth Straight Balance Gear Replaces B9NN6302B	AMEZJL6300BA-2	\$ 693.47	
2000, 2100, 2110, 2120, 2300, 2310, 2610, 2910, 3000, 3000 Super Dexta, 3055, 3100, 3110, 3120, 3150, 3190, 3230, 3300, 3310, 3330, 3500, 3600, 3610, 3900, 3910, (4100, 4110, 4130, 4140, 4200, 4330, 4400, 4410, 4500, 4600, 4610, 4630 - w/ Gas), Ind: 230A, 234, 333, 335, 336, 340, 340A, 445, 450, 3400, 3550	Crankshaft BSD329, D175, D183, D192 - 3 Cylinder Engines 4.200" Stroke, 4.200" Bore, 2.7496" - 2.750" Rod, 3.3713" - 3.3723" Main Flange - Centering Ring, 6 Bolt Holes, 1 Dowel Hole Snout - Keyed, 1 Bolt Hole	AME0NN6303AA	\$ 475.00	
3930, 3930H, 3930N, 3930NO, 4000, 4000 Major, 4100, 4110, 4130, 4130N, 4130NO, 4140, 4190, 4200, 4330, 4340, 4410, 4600, 4600SU, 4610, 4610SU, 4630, Ind: 260C, 455C, 455D, 530A, 531, 532, 535, 540, 540A, 540B, 545, 545A, 545C, 555, 555A, 555B Replaces C5NE6303N, E5NN6306N	Crankshaft BSD333 4.4 Stroke 201 CID 3.3 Liter 3 Cylinder Engine 4.400" Stroke, 4.4007" - 4.4032" Bore, 2.7496" - 2.7504" Rod, 3.3713" - 3.3723" Main Flange - 6 Bolt Holes, 1 Dowel Hole, Centering Ring Snout - Keyed, 1 Bolt Hole	AMF0NN6303MA	\$ 434.00	
6000, 6600, 6610, 6700, 7000, 7100, 7200, 7600, 7610, 7700, 7710 Replaces D5NN6303FA, D9NN6110AA, D9NN6303A, D9NN6303AA, E5NN6303CA	Crankshaft w/ Gear BSD444 268 CID 4.4 Liter 4 Cylinder Engine 4.400" Stroke, 4.4007" - 4.403" Bore, 2.7496" - 2.7504" Rod, 3.3713" - 3.3723" Main Flange - Centering Ring, 6 Bolt Holes, 1 Dowel Hole Snout - 1 Bolt Hole, 1 Keyway, w/ 76 Tooth Balance Drive Gear 15.00 mm Wide, Right Hand Helix	AME5NN6303DA-76-2	\$ 505.00	
6000, 6600, 6610, 6700, 7000, 7100, 7200, 7600, 7610, 7700, 7710 Replaces 1598N, D5NN6303FA, D9NN6110AA, D9NN6303A, D9NN6303AA, E5NN6303CA	Crankshaft w/ Gear BSD444 268 CID 4.4 Liter 4 Cylinder Engine 4.400" Stroke, 4.4007" - 4.403" Bore, 2.7496" - 2.7504" Rod, 3.3713" - 3.3723" Main Flange - Centering Ring, 6 Bolt Holes, 1 Dowel Hole Snout - 1 Bolt Hole, 1 Keyway, w/ 78 Tooth Balance Drive Gear 12.50 mm Wide, Right Hand Helix	AME5NN6303DA-2	\$ 495.00	

Prices Subject to Change without Prior Notice. The use of original equipment manufacturer (OEM) part numbers or trademarks, e.g. Case® and John Deere®, are for reference purposes only and for indicating product use and compatibility. Our company and the listed replacement parts contained herein are not sponsored, approved or manufactured by the OEM. All parts are New unless designated Reman in the description.

Ford® / New Holland® —Tractor

Application	Description	Part Number	Retail Price	Core
T6030, T6050, T6070, T6080, T6090, T7030, T7040, T7050, T7060, T7.170, T7.185, T7.200, T7.210, T7.220, T7.235, T7.250, T7.260, T7.270, TS125A, TS130A, TS135A Replaces 2830398, 2831071, 2831402, 2856281, 2856282, 2859446, 504347348	Crankshaft 6.7 Liter Mechanical Injection Engine	AM504203869	\$ 1650.00	
(T9030, T9040, T9050 ASN Z7F204001), TJ380, TJ430	Crankshaft Cursor 13	AM99438979	\$ 2750.00	

Connecting Rods

All connecting rods are cleaned and inspected for defects prior to remanufacturing. Rods are then shot-peened for stress relief and the size is checked against OEM specifications. New piston pin bushings are installed in each rod and bored to the correct center-to-center dimensions. The center-to-center dimension greatly affects the performance of your engine and is a step that many remanufacturers ignore. Final assembly of our connecting rods include installation of new rod bolts and verifying product dimensions, including bend and twist, one final time.



Application	Description	Part Number	Retail Price	Core
455, 550, 555, 655, 3230, 3930, 4130, 4630, 5030, 5110, 5610, 5640, 5900, 6410, 6610, 6640, 6710, 6810, 7000, 7410, 7600, 7610, 7810, 7910, 8210, 8240, 8260, 8340, 8530, TS115	Connecting Rod Replaces 81875622, 83958631, 83972114	AM87801218	\$ 105.00	
3230, 3430, 3610, 3910, 3930, 4000, 4110, 4120, 4130, 4140, 4330, 4340, 4600, 4610, 4630, 4830, 5000, 5030, 5100, 5600, 5900, 6600, 6700, 6710, 7910, 8000, 8210, 8530, 8600, 8700, TW5, TW10 - w/ 192, 201, 233, 256, 268 or 401 Engine	Connecting Rod 1.50" Pin Diameter	AMC7NN6205	\$ 86.40	
7000, 7100, 7200, 7400, 7600, 7700, 7710, 8630, 8730, 8830, 9000, 9600, 9700, TW15, TW20, TW25, TW30, TW35 - w/ 256T, 268T or 401T Engine	Connecting Rod w/ Flat Wrist Pin, 1.625" Pin Diameter	AM87801220	\$ 80.00	
9000, 9600, TW20, TW30, TW35	Reman Connecting Rod 1.50" Pin Diameter	AMCR6205S-R	\$ 185.00	\$ 30.00
9000, 9600, TW20, TW30, TW35	Reman Connecting Rod 1.625" Pin Diameter	AMCR6205L-R	\$ 185.00	\$ 40.00
Genesis Engine	Reman Connecting Rod w/ Tapered Wrist Pin, 1.625" Pin Diameter	AMCR6205LGEN-R	\$ 185.00	\$ 40.00
T8050, T9020, TJ325 w/ 6TAA-9004 Engine, TJ330, Combines: (CR9040, CR9060 BSN Y8G112001)	Connecting Rod Bolt Replaces J944679	AM3944679	\$ 3.00	

Crankshaft Pulleys and Dampers

Application	Description	Part Number	Retail Price	Core
7910, 8210, 8530, 8630, 8730, 8830, 9700, TW5, TW10, TW20, TW25, TW30, TW35	Crankshaft Damper Pulley 3-Groove	AMD8NN6316AC	\$ 256.00	
T8010, T8020, T8030, T8040, T8050, TG215, TG245, TG275, TG305 - w/ 6CT, 6CTA, 6CTAA or QSC 8.3 Liter Cummins® Engine	Crankshaft Damper Pulley Replaces 87773050, J910907, J914456	AMJ925570	\$ 97.00	
TG210, TG230, TG255, TG285	Crankshaft Damper Pulley 2.24" Thick, 0.95" ID, 9.67" OD Replaces 39255568, J910907, J914456	AMJ925568	\$ 128.00	
TM115, TM120, TM125, TM130, TM135, TM140, TM150, TM155, TM165	Crankshaft Damper Pulley 10 Spline, 13.701" OD, 1.575" Spline Diameter Replaces 5187845	AM87304267	\$ 390.00	

Ford® / New Holland®—Tractor



Camshafts and Lifters

Application	Description	Part Number	Retail Price	Core
401 Engine	Camshaft 6 Cylinder	AM87802904	\$ 209.00	
8N w/ Side Mount Distributor	Camshaft	AM8N6250	\$ 179.00	
501, 541, 600, 601, 611, 620, 621, 630, 631, 640, 641, 650, 651, 660, 661, 671, 681, 700, 701, 740, 741, 771, 800, 801, 811, 820, 821, 840, 841, 850, 851, 860, 861, 871, 881, 900, 901, 941, 950, 951, 960, 961, 971, 981, 1801, 1811, 1821, 1841, 1871, 1881, 2000 Series, 4000 Series, NAA - w/ 4 Cylinder 134/172 Gas Engine	Camshaft and Reman Lifters Kit Lifter 4 Cylinder 134/172 Gas	AMC0NN6251A-K AMF3JL6500AA	\$ 305.67 \$ 8.00	
2000, 2600, 2610, 3000, 3055, 3100, 3400, 3500, 3550, 3600, 3610, 3900, 3910, 4000, 4100, 4110, 4140, 4200, 4400, 4410, 4500, 4600, 4610, Ind: 335, 340, 420, 515, 532, 535, 545, 550, 555	Camshaft 3 Cylinder	AM87800323	\$ 125.00	
4230, 4430, 4835, 5635	Camshaft Includes Gear, Key and Thrust Plate	AM98425868	\$ 1789.79	
5000, 5100, 5200, 5590, 5600, 5610, 6600, 6610, 6700, 6710, 7200, 7600, 7610, 7700, 7710, Ind: 650, 655, 750, 755, 5500, 6500, 7500	Camshaft 4 Cylinder Replaces 84157722	AM87800353	\$ 133.00	
Versatile®: 276V	Camshaft 3.9 Cummins® Engine	AMJ929039	\$ 97.00	
Most 3 Cylinder, 4 Cylinder and 6 Cylinder Engines	Lifter	AMC7NN6500B	\$ 8.00	
TG210, TG230	Push Rod	AMJ905194	\$ 10.25	

Cylinder Heads, Bare

Our remanufactured cylinder heads are cleaned, pressure-tested and resurfaced. New seats and guides are installed using OEM specifications. These heads are ready for final assembly.



Application	Description	Part Number	Retail Price	Core
2N, 8N, 9N	Cylinder Head, Bare Replaces 8N6050	AM9N6050	\$ 221.00	
2N, 8N, 9N	Valve Train Kit Free Rotating Valves For Engines w/ Adjustable Lifters Includes (4) Rotating Exhaust Valves, (4) Intake Valves, (8) 1-Piece Solid Guides with Guide Seals, (8) Springs, (4) Intake Spring Retainers, (4) Exhaust Spring Retainers, (4) Lash Caps, (8) Guide Locking Clips and (16) Valve Lock Keepers	AMVK1000	\$ 151.19	
2000, 2100, 2110, 2120, 2300, 2310, 2600, 2610, 2810, 2910, 3000, 3055, 3100, 3110, 3120, 3190, 3230, 3300, 3310, 3430, 3550, 3600, 3610, 3900, 3910, 3930, 4000, 4100, 4110, 4130, 4140, 4190, 4200, 4330, 4340, 4400, 4410, 4500, 4600, 4610, Ind/Const: 230A, 231, 233, 234, 250C, 333, 334, 335, 340, 340A, 340B, 345C, 345D, 420, 445, 445A, 445C, 445D, 455, 515, 530A, 531, 532, 535, 540, 540A, 545, 545A, 550, 555, 555A	Valve Train Kit Includes (3) Exhaust Valves*, (3) Intake Valves**, (6) Valve Springs, (6) Valve Spring Retainers, (6) Valve Spring Retainer Sleeves, (12) Valve Keepers and (6) Valve Seals *5.766" Long, 45° **5.746" Long, 45°	AMVK1045	\$ 120.89	

Ford® / New Holland®—Tractor

Oil Pumps, Engine

All of our remanufactured engine oil pumps are disassembled, thoroughly cleaned and inspected. All worn parts are replaced and tolerances are checked to guarantee our oil pumps will perform to OEM specifications. The pump is reassembled and—as a safety measure—each pump is lubricated with Clevite Bearing Guard to ensure there is no damage during initial start up. Replacing the engine oil pump during an overhaul is a step many people overlook.



Application	Description	Part Number	Retail Price	Core
600, 700, 800, 900 Series - w/ 4 Cylinder Engine	Engine Oil Pump Hex Drive, Gear Type Output Mounting Flange Has Square Opening	AMEAE6621AB	\$ 61.00	
501, 601, 701, 801, 901, (2000, 4000 - w/ 4 Cylinder Engine)	Engine Oil Pump Hex Drive, Roto Type Output Mounting Flange Has Slotted Opening	AMD1NL6600A	\$ 180.00	
(2000, 3000, 4000, 5000 - 1965-75), (2600, 3600, 3900, 4600, 5600, 6600 1975-81), (2310, 2610, 2810, 2910, 3910, 4110, 4610 - 1981-10/91), (3230, 3430, 3930, 4130, 4930, 4830, 5030 - 03/90-5/94), Ind: 230A, 231, 233, 234, 333, 334, 335, 420, 515, 530A, 531	Engine Oil Pump Replaces E1NN6600DA, E1NN6600DB, E1NN6600DC	AME1NN6600DD	\$ 66.00	
4630, 5030, 7000 Series 10/71 and Later, (7600, 7700 - 1975-81), Swather: 1118	Engine Oil Pump Replaces E1NN6600CB	AME1NN6600CC	\$ 70.00	
6640, 7740 - w/ 340 or 304T Engine	Engine Oil Pump	AM81868537	\$ 115.00	
7840, 8240, 8340 - w/ 401 or 456 Engine	Engine Oil Pump	AME9NN6600BB	\$ 110.00	
8700	Engine Oil Pump	AME1NN6600BC	\$ 126.00	
Dexta, Super Dexta - w/ Perkins® 144 CID or 152 CID Engine	Engine Oil Pump Replaces 957E6600C, 41314078	AM41314187	\$ 86.00	
T8010, T8020, T8030, T8040	Engine Oil Pump	AM3991123	\$ 160.98	
TG210, TG230, TG255, TG285, TJ275, TJ325, TJ450	Engine Oil Pump Replaces 3948072, 87775216, J942723	AMJ948072	\$ 235.00	
8630, 8730, 8830, TW15, TW20, TW25, TW30, TW35 - w/ Turbo Engines Only	Engine Oil Pump Replaces D8NN6600AJ	AM87840275	\$ 365.00	
Swathers: HW305, HW305S, HW325 - w/ N45 Fiat® Diesel Engine	Engine Oil Pump	AM4897480	\$ 162.64	
2000, 2100, 3000, 3100, 3400, 3500, 4000, 4110, 4400, 4500, 5000, Ind: 3550, 5500, 5550	Oil Filter Adapter Kit Spin-On, Pre-Assembled O-Ring Not Included Replaces 309825F, 1821119, DBPN309825	AM309825	\$ 25.00	
T8010, T8020, T8030, T8040, T8050, T9010, T9020, TG215, TG245, TG275, TG305, (TJ275, TJ325 - w/ 6TAA-8304 or 6TAA-9004 Engine), TJ280, Combines: CR9040, CR9060 BSN Y8G112001)	Gasket, Oil Pump Pickup Tube Replaces 3914302, 87775049, A77583, J908540, J914302	AM87447959	\$ 3.00	

Oil Coolers, Engine

Application	Description	Part Number	Retail Price	Core
5610S, 6610S, 7610S, TS6020, TS6030	Oil Cooler N45 Fiat® Diesel, 5 Fins	AM2853722	\$ 172.00	
8670, 8670A, 8770, 8770A, 8870, 8870A, 8970, TM125, TM135, TM150, TM165, Combines: TR87, TR88, TR89, TR98	Oil Cooler Replaces E9HN6A640AA	AM87380919	\$ 769.23	
T8010, T8020, T8030, T8040, T8050, T9010, T9020, TJ280, TJ330	Oil Cooler 8.9 Cummins®, 14 Fins	AM87452245	\$ 195.00	

Ford® / New Holland® —Tractor



Radiators and Components

Application	Description	Part Number	Retail Price	Core
Boomer 1020, Boomer 1025, Boomer 1030, T1010, T1030, T1110, TZ18DAASN HB20001, TZ22DA, TD25DA	Radiator	AMSBA310101140	\$ 850.00	
2N, 8N, 9N	Radiator Overall: 16 1/2" x 23 1/2" Core: 15 3/8" x 17" x 2" Replaces 86551430	AM8N8005	\$ 225.00	
250C, 260C, 532 w/ Torque Conversion 1975-07/81, (2000, 4000 - w/ 3 Cylinder Engine w/ Oil Cooler), (2100, 2110, 2120, 2300, 2310, 3000, 3055, 3100, 3110, 3120, 3150, 3190, 3300, 3310, 3330, 3400, 4100 - 1965 and Later), Ind/Const: (340A, 340B, 540A, 540B - 08/1981 and Later), 420 w/ Torque Conversion 1975-07/81, 445 Prior to 09/1978, 540 Prior to 07/1981, (3500, 3550, 4400 - 1965 and Later)	Radiator Overall: 19" x 22 1/2** Core: 17 1/4" x 16" x 2" 3 Rows, 8 Fins per Inch *Overall Height Does Not Include Filler Neck Oil Cooler Ports Are on the Grille Side Replaces 82847505, C5NN8005J, C5NN8005T, E1NN8005AB15M	AMD8NN8005PA	\$ 275.00	
5000, 5100, 5600, 6600 - w/o Oil Cooler	Radiator Overall: 18 3/4" x 24" Core: 18" x 17 3/4" x 1 3/4" 3 Rows, 9 Fins per Inch Replaces C5NN8005N, D6NN8005A, D6NN8005B	AMC7NN8005E	\$ 292.00	
600, 700, 800, 900, 2000, 4000, NAA - w/ 4 Cylinder Engine	Radiator Overall: 17 5/8" x 24" Core: 17 1/4" x 17 1/2" x 2" 3 Rows, 8 Fins per Inch	AMC5NN8005AB	\$ 260.00	
2000, 2100, 2120, 2300, 2600, 2610, 3000, 3100, 3400, 3550, 3600, 3610, 3900, 3910, 4000, 4110, 4140, 4400, 4410, 4600, 4610	Radiator Overall: 19" x 22 1/2" x 17 3/8" Core: 16" x 2" 3 Rows, 9 Fins per Inch	AMC7NN8005H	\$ 240.00	
2600, 2600N, 2600R, 2600V, 3600, 3600N, 3600NO, 3600R, 3600V, 4100, 4600, 4600NO, 4600O, 4600SU, 5110, 5600, 5610, 5610S, 5700, 6600, 6610, 6610O, 6610S, 6700, 6710, 6810, 7010, 7410, 7600, 7600C, 7610, 7610O, 7700, 7710, TB80, TB85, TB90, TB100, TB110, TB120	Fan Shroud, Fiberglass Replaces D3NN8146A, E2NN8146BB, E6NN8146AA	AM81869055	\$ 125.00	
2600, 3600, 4100, 4600, 5600, 6600, 6700, 7600, 7700 - w/ Oil Cooler	Radiator Overall: 18 3/4" x 24 1/4** Core: 18" x 17 3/4" x 2 3/4" 4 Rows, 9 Fins per Inch *Overall Height Does Not Include Filler Neck Oil Cooler Ports Are on the Engine Side	AMD5NN8005A	\$ 395.00	
3230, 3430, 3930, 3930H, 3930N, 4130, 4130N, 4630, 4630N, 4630NO, 4630O - 1990 and Later	Radiator Overall: 19" x 21 1/2** Core: 18" x 16" 3 Rows, 8 Fins per Inch *Overall Height Does Not Include Filler Neck	AME9NN8005AB15M	\$ 255.00	
5640, 6640 - w/ or w/o A/C	Radiator Core: 19 1/8" x 20 1/8" x 3" 5 Rows, 8 Fins per Inch	AM82015101	\$ 525.00	
5700, 6700 - 1976 and Later w/ Cab	Radiator Overall: 21 11/16" x 25 7/8** Core: 19 3/4" x 19 15/16" 3 Rows, 7 Fins per Inch *Overall Height Does Not Include Filler Neck	AMD6NN8005D	\$ 585.00	
6710, 7700, 7710	Radiator Replaces E1NN8005EA15M, D8NN8005LA15M, D6NN8005SF	AME1NN8005EB15M	\$ 561.00	
(5110, 6410, 7410 - w/o A/C), 5610, 6610, (6810, 7610 - w/o A/C and w/o Viscous Fan)	Radiator Oil Cooler Ports are on the Engine Side	AME7NN8005BA	\$ 535.00	

Ford® / New Holland®—Tractor

Application	Description	Part Number	Retail Price	Core
7000, 7100, 7200	Radiator Core: 18" x 17 3/4" x 2 3/4" Oil Cooler Ports are on the Engine Side	AMD3NN8005B	\$ 360.00	
7910, 8210 - 1982 and Later	Radiator w/o Cooler	AME1NN8005BD15M	\$ 860.00	
8530, 8630, TW5, TW10, TW15, TW20	Radiator Replaces E3NN8005BD15M, E3NN8005AD15M	AM82847503	\$ 760.00	
8730, 8830, TW25, TW35 - w/ Oil Cooler	Radiator Core: 22 1/8" x 25" x 2 3/4" 4 Rows, 11 Fins per Inch	AME3NN8005DE15M	\$ 895.00	
8830, TW30, TW35	Radiator w/o Hydraulic Oil Cooler Overall: 24 9/16" x 31" Core: 22" x 25" 4 Rows, 10 Fins per Inch *Overall Height Does Not Include Filler Neck	AME3NN8005CE15M	\$ 695.00	
T2310	Radiator Core: 17 5/8" x 16 3/4" x 1 7/8"	AM87305450	\$ 415.00	
T6030, T6050, T6070, T6080	Radiator Aluminum Core: 20.72" x 23.44" x 4.80" 4 Rows, 4.80 Fins per Inch Replaces 84160716, 87575998, 87737096	AM87575996	\$ 1110.00	
(T6030, T6050, T6070, T6080 BSN Z*BK40000)	Radiator 6 Rows Replaces 87575996, 87575998, 87737096	AM87737098	\$ 971.00	
T6070	Radiator	AM87574213	\$ 950.00	
T8030, T8040, T8050, TG275, TG305	Radiator Core: 20" x 31.50" x 4" 6 Rows, 7 Fins per Inch	AM87448824	\$ 993.00	
T8.320 Tier 4B CVT, PST and NA/ROW, (T8.350, T8.380 - CVT, PST and NA/ROW)	Radiator	AM47787075	\$ 1300.00	
TM120, TM130	Radiator Overall: 31" x 22 1/4" Core: 22 1/8" x 21" x 4"	AM87352188	\$ 1110.00	
TM140, TM155, TS115A, TS125A, TS135A	Radiator Overall: 31" x 22 1/4" Core: 23 1/2" x 20 1/2" x 5" There is a 5/8" heater bypass connection to the right of the outlet connection	AM87352191	\$ 1110.00	
TM175, TM190	Radiator Core: 21 1/4" x 27 3/4" x 5" 7 Rows, 7 Fins per Inch Outlet is left of center Replaces 82033525, 82033792, 82038688, 87306754	AM87352193	\$ 1060.00	
TS115A, TS125A, TS135A	Radiator Outlet is right of center, 3/8" vent tube on top of tank, 5/8" vent tube on bottom of tank Replaces 82033774	AM87306756	\$ 1190.00	
Utility: 1530, 1630, 1725, 1925, TC25, TC25D, TC29, TC29D, TC29DA, TC33, TC33D, TC33DA	Radiator Core: 15.50" x 15.75" x 1.75" Includes Bracket for Shield Screen w/ Remote Drain	AM86402723	\$ 675.00	
Utility: T2210, T2220, TC31DA, TC34DA	Radiator Core: 17.625" x 14.875" x 1.75" 2 Rows, 10 Fins per Inch	AM87305451	\$ 376.00	
Utility: T2320, T2330, TC45A, TC45DA	Radiator Core: 17.625" x 16.75" x 2.25" 2 Rows, 10 Fins per Inch	AM87305449	\$ 532.00	

Ford® / New Holland®—Tractor

Application	Description	Part Number	Retail Price	Core
Utility: TC35, TC35A, TC35D, TC35DA, TC40, TC40A, TC40D, TC40DA	Radiator Core: 17 3/8" x 14 3/4" 3 Rows Includes Cap Replaces 86400443, 86401465, 86402465	AM86402724	\$ 469.00	
Workmaster 55, Workmaster 65, Workmaster 75	Fan Shroud	AM87757220	\$ 16.00	
T9.615, T9.670	Charge Air Cooler	AM84286668	\$ 2390.00	
(3010S, 3230, 3830 Orchard, 4010S, 4030 Orchard, TT55, TT60A, TT65 - w/ 3 Cylinder Engine), (4230 Orchard, 4330V, 4430 Orchard, 5010S, 5530, 6530, TT45A, TT50A, TT75, TT75A, Workmaster 55, Workmaster 65, Workmaster 75 - w/ 4 Cylinder Engine), 4835, 5635, 6635, 7635, 8160, 8260, 8360, 8560, (8830, TV140, Workmaster 45 - w/ 6 Cylinder Engine), L65, PowerStar™ 65, PowerStar™ 75, T4020, T4020V, T4030, T4030F, T4030N, T4030V, T4040, T4040F, T4040N, T4040V, T4050, T4050F, T4050N, T4050V, T4060F, T4060N, T4060V, T4.55, T4.65, T4.65V, T4.75, T4.75F, T4.75V, T4.85F, T4.85V, T4.95F, T4.95V, T4.105F, T4.105V, T5040, T5050, T5060, T5070, TD60D, TD70D, TD75D, TD80D, TD85F, TD90D, TD95D, TD4020F, TD4030F, TD4040F, TD5010, TD5020, TD5030, TD5050, TD4.90F, TL70, TL80, TL80A, TL90, TL90A, TL100, TL100A, TM115, TM125, TM135, TM150, TM165, TN55, TN55D, TN55S, TN60A, TN60DA, TN60SA, TN60VA, TN65, TN65D, TN65F Orchard, TN65S, TN65V, TN70, TN70A, TN70D, TN70DA, TN70F Orchard, TN70NA, TN70S, TN70SA, TN70VA, TN75, TN75A, TN75D, TN75DA, TN75F Orchard, TN75FA, TN75S, TN75SA, TN75V, TN75VA, TN80F Orchard, TN85A, TN85DA, TN85FA Orchard, TN85SA, TN90F Orchard, TN95A, TN95DA, TN95F Orchard, TN95FA Orchard, TN95NA, TN95VA, Workmaster 75	Rubber Mount	AM5108225	\$ 9.00	

Radiator Hoses



Application	Description	Part Number	Retail Price	Core
2N, 8N, 9N	Radiator Hose, Upper 1.50" ID	AM2N8260	\$ 6.50	
60 1959-63, (501, 601 - 1957-62), (541, 611 - 1959-64), 600 1957, 620 1954-64, (621, 631, 641, 651 - 1958-64), (630, 640 - 1955-57), 650 1956-57, 700, 800, 900, (2000, 4000 - 1962-64), (2031, 4031 - 1960-62), (2111, 2120, 2130, 2131, 4110TR, 4120, 4121, 4130, 4131, 4140 - 1963-64), (4030, 4040 - 1961-62), Jubilee, NAA - All w/ 4 Cylinder Engine	Radiator Hose, Upper 1.25" ID Replaces 310048	AMNAA8260B	\$ 4.00	
(230A, 334, 3610V 1981-04/83 - w/ 3 Cylinder Engine), (231, 233, 333, 531, 2600N, 2600R, 3600, 3600N, 3600V, 3900, 4600O - 1975-81 w/ 3 Cylinder Engine), (234 1975-04/83, 2000, 2100 03/1965-74, 2310 03/1982-83, 2600V 10/1975-09/76, 2610V 1970-02/90, 3600R 1975-77, 3610NO 08/1981-04/83, 3910 05/1983-02/90, 3910R (981-84, 3910V 12/1983-02/90, 4000 Diesel, 4110N 12/1981-02/90, 4410 1969-74, 4600NO 10/1975-81, 4600SU 1975-07/81 - w/ 3 Cylinder Engine), (335, 340, 2610, 2810, 3000, 3055, 3100, 3400, 3610, 4000SU, 4100, 4110, 4600, 4610, 5600 w/ Transmission Oil Cooler - Diesel), (2110, 2120, 2300, 4190, 4200, 4330, 4340 - 1965-74 w/ 3 Cylinder Engine), 2600, 5000, 5100, 6600, 6700, 7000, 7100, 7600, (2910, 3910H, 3910N - 1983-02/90 w/ 3 Cylinder Engine), (4110NO, 4110O, 4110V, 4610NO - 1981-02/90 w/ 3 Cylinder Engine), (5110 05/1984-10/91, 6710 1981-09/85, 7610O 10/1981-91, 7700 1976-80, 7710 1981-10/91 w/ 4 Cylinder Engine), (6810, 7410 - 04/1989-10/91 - w/ 4 Cylinder Engine), (5610, 5900, 6610, 7610 - Prior to 07/31/1987), Ind: (420, 445, 445A, 515, 535, 540, 540A, 540B, 545, 545A, 3500, 3550, 4500 - Diesel)	Radiator Hose, Upper 1.50" ID Replaces 81805628, 83907414, C5NN8260A, C5NN8260B, D5NN8260DV	AMD5NN8260D	\$ 5.95	

Ford® / New Holland®—Tractor

Application	Description	Part Number	Retail Price	Core
(231, 233, 333, 531, 2600, 2600N, 2600R, 3600, 3600N, 3600V, 3900, 4100, 4600, 5700, 6700 - 1975-81 w/ 3 Cylinder Engine), (2600V 10/1975-09/76, 3600R 1975-77, 4600NO 10/1975-81, 4600O, 4600SU 1975-07/81 - w/ 3 Cylinder Engine), (5110 05/1984-10/91, 5900 05/1985-93, 7610 1981-10/91, 7610O 10/1981-91, 7710 Prior to 07/1987 w/o A/C - w/ 4 Cylinder Engine), (5610, 6610 - 1981-93 w/ 4 Cylinder Engine), (6710, 7700 - w/o A/C w/ 4 Cylinder Engine), (6810, 7410 - 04/1989-10/91 w/ 4 Cylinder Engine)	Radiator Hose, Upper 1.50" ID Replaces 83905554, D5NN8260CV, K916316	AMD5NN8260C	\$ 14.00	
(231, 233, 333, 531, 2600, 2600N, 2600R, 3600, 3600N, 3600V, 3900, 4100, 4600, 4600O - 1975-81 w/ 3 Cylinder Engine), (2600V 10/1975-09/76, 3600R 1975-77, 4600NO 10/1975-81, 4600SU 1975-07/81 - w/ 3 Cylinder Engine), (5110 05/1984-10/91, 5900 05/1985-93, 6710, 7610 1981-10/91, 7610O 10/1981-91, 7700, 7710 - w/ 4 Cylinder Engine), (5610, 6610 - 1981-93 w/ 4 Cylinder Engine), (6810, 7410 - 04/1989-10/91 w/ 4 Cylinder Engine)	Radiator Hose, Upper 1.50" ID	AMD4NN8260C	\$ 15.00	
(231, 233, 333, 531, 2600, 2600N, 2600R, 3600, 3600N, 3600V, 3900, 4100, 4600O - 1975-81 w/ 3 Cylinder Engine), (2600V 10/1975-09/76, 3600R 1975-77, 4600 w/ Cab and A/C, 4600NO 10/1975-81, 4600SU 1975-07/81 - w/ 3 Cylinder Engine), (4610, 7700 1976-80 - w/ 4 Cylinder Engine)	Radiator Hose, Upper 1.50" ID	AMD6NN8260A	\$ 18.00	
2000, 2100, 2110, 2120, 2300, 2310, 2600, 2610, 2810, 2910, 3000, 3055, 3100, 3110, 3120, 3190, 3300, 3310, 3330, 3400, 3600, 3610, 3910, 4000, 4100, 4110, 4330, 4340, 4400, 4410, 4600, 4610, 5600, 6600, 7600, Ind: 230A, 234, 334, 340, 340A, 445, 445A, 450, 530A, 540, 540A, 540B, 545, 545A, 3500, 3550, 4500	Radiator Hose, Upper 1.50" ID	AMC5NN8260D	\$ 7.00	
3230 03/1990-09/94, 3430, 3930 05/1990-07/99, 3930N 03/1990-06/95, (3930NO, 4130NO, 4630N, 4630NO, 4630O - 03/1990-08/99), 4130 03/1990-07/99, 4630 - All w/ 3 Cylinder Engine	Radiator Hose, Upper 1.50" ID	AME9NN8260AA	\$ 18.00	
(3230, 3430, 4630 - w/ 3 Cylinder Engine w/o Spigot), (3930, 3930N 03/1990-06/95, 4130 03/1990-07/99 - w/ 3 Cylinder Engine), (3930NO, 4130NO, 4630N, 4630NO, 4630O - 03/1990-08/99 w/ 3 Cylinder Engine)	Radiator Hose, Upper 1.50" ID Replaces 82015118	AMF0NN8260AA	\$ 14.00	
(4000, 4110, 4190, 4330, 4340 1965-74 w/ 3 Cylinder Engine), 4100 w/ 3 Cylinder Engine, 4200 Gas or Diesel, 5200, 4410 1969-74 w/ 3 Cylinder Engine, Ind: 4500 - 1965-74 w/ 3 Cylinder Engine	Radiator Hose, Upper 1.50" ID	AMC5NN8260E	\$ 15.00	
4010S 1996 and Later w/ 3 Cylinder Engine, (5530, 6530 - 03/1992-97 w/ 4 Cylinder Engine)	Radiator Hose, Upper 1.687" ID	AM5104825	\$ 29.00	
4830, 4830N 07/1990-05/94 w/ 4 Cylinder Engine, 5030, 5030O 06/1994-04/98 w/ 4 Cylinder Engine	Radiator Hose, Upper 1.50" ID	AMF0NN8260BB	\$ 26.00	
5110 05/1984-10/91, (5610, 6610 - 1981-93), 5900 05/1985-93, 6710 1981-09/85, (6810, 7410 - 04/1989-10/91), 7610 1981-10/91, 7610O 10/1981-91, 7710 08/1987 and Later w/ A/C - All w/ 4 Cylinder Engine	Radiator Hose, Upper 1.50" ID	AME6NN8260AA	\$ 23.00	
(5110 05/1984-10/91, 5610S 1993 and Later, 6710 1981-09/85, 7610O 10/1981-91, 7710 1981-10/91 - w/ 4 Cylinder Engine), (6610S, 7610S - 1994 and Later w/ 4 Cylinder Engine), (6810, 7410 - 04/1989-10/91 w/ 4 Cylinder Engine), (5610, 5900, 6610, 7610 - 08/1987 and Later), Backhoe-Loaders: 655, 655A 08/1987 and Later, 655C Prior to 08/1993	Radiator Hose, Upper 1.625" ID Replaces E7NN8260BA	AME6NN8260CA	\$ 9.00	
5640, 6640, 7740	Radiator Hose, Upper 1.50" ID Replaces 81862934, 87745807, D0NN8260CA	AMF0NN8260CA	\$ 9.00	
7810 w/ BSD666 Engine, (7810O 02/1988-10/91, 8010 04/1996 and Later - w/ 6 Cylinder Engine), 7810S	Radiator Hose, Upper 1.75" ID Replaces 83961073, 87745813	AME7NN8260AA	\$ 13.00	
7840, 7840O 02/1993-01/98 w/ 6 Cylinder Engine, 8240, 8340	Radiator Hose, Upper 1.50" ID Replaces 81862935	AMF0NN8260DA	\$ 15.00	
(7910, 8210 - w/ BSD666 Engine)	Radiator Hose, Upper 1.75" ID Replaces 83929875	AME0NN8260AA	\$ 37.00	

Ford® / New Holland®—Tractor

Application	Description	Part Number	Retail Price	Core
(8000 1968-78, 8200 1968-09/72, 8600 10/1972-07/76, 8700 08/1976-78, 9200 1969-09/72, 9600 10/1973-07/76, 9700 08/1976-78 - w/ 6 Cylinder Engine), 9000 Prior to 09/1972, Ind: 8400 1971-09/72 w/ 6 Cylinder Engine	Radiator Hose, Upper 1.75" ID	AMC9NN8260A	\$ 33.00	
8000 Prior to 07/1976, (8200 1968-09/72, 8600 10/1972-07/76, 8700 08/1976-78, 9000 1969-78, 9200 1969-09/72, 9600 1973-07/76, 9700 1976-78 - w/ 6 Cylinder Engine), Ind: 8400 1971-09/72 w/ 6 Cylinder Engine	Radiator Hose, Upper 1.50" ID	AMD2NN8260B	\$ 21.00	
(8000 1968-78, 8200 1968-09/72, 8600 10/1972-07/76, 8700 08/1976-78, 9200 1969-09/72, 9600 10/1973-07/76, 9700 08/1976-78 - w/ 6 Cylinder Engine), 9000 Prior to 07/1976, Ind: 8400 1971-09/72 w/ 6 Cylinder Engine	Radiator Hose, Upper 1.75" ID	AMD2NN8260C	\$ 18.00	
(8000 1968-78, 8200 1968-09/72, 8600 10/1972-07/76, (8700, 9700 - 08/1976-78), 9000 1969-78, 9200 1969-09/72, 9600 10/1973-07/76 - w/ 6 Cylinder Engine), TW10, TW20, TW30, Ind: 8400 1971-09/72 w/ 6 Cylinder Engine	Radiator Hose, Upper 1.75" ID	AMD8NN8260BB	\$ 28.00	
(8000, 9000 - 08/1976 and Later), 8700, 9700, 8200 1968-09/72, 8600 10/1972-07/76, 9200 1969-09/72, 9600 10/1973-07/76, Ind: 8400 1971-09/72 w/ 6 Cylinder Engine	Radiator Hose, Upper 1.75" ID Replaces 83914013	AMD8NN8260CA	\$ 19.00	
(8530, 8630, 8730 - 03/1990-93 w/ 6 Cylinder Engine), 8830, TW5, TW15, TW25, TW35	Radiator Hose, Upper 1.75" ID Replaces 83918850, 83933451, 83934898	AME3NN8333AA	\$ 17.00	
8670, 8670A, 8770, 8770A, 8870, 8870A, 8970, 8970A	Radiator Hose, Upper 2" ID Replaces 86013975	AM9821598	\$ 28.00	
Dexta	Radiator Hose, Upper 1.625" ID Replaces 81718085, 87295814	AM957E8260A	\$ 22.00	
Major, Super Major	Radiator Hose, Upper 1.75" ID Replaces 87295271, E1ADKN8260	AM81718084	\$ 13.00	
Super Dexta	Radiator Hose, Upper 1.75" ID Replaces 81805632	AM957E8260B	\$ 24.00	
Utility: 1100	Radiator Hose, Upper 1.25" ID	AMSBA310160320	\$ 19.00	
Utility: 1110 w/ Manual Transmission	Radiator Hose, Upper 1.312" ID	AMSBA310160780	\$ 11.00	
Utility: 1120, 1210, 1215, 1220, 1310	Radiator Hose, Upper 1" ID	AMSBA310160730	\$ 18.00	
Utility: 1200	Radiator Hose, Upper 1.25" ID	AMSBA310160460	\$ 39.00	
Utility: 1320, 1520, 1620, 1715, 1720, 1920, T1520, TC30	Radiator Hose, Upper 1.312" ID	AMSBA310160932	\$ 17.00	
Utility: 1300	Radiator Hose, Upper 1" & 1.25" ID	AMSBA310160290	\$ 27.00	
Utility: 1500	Radiator Hose, Upper 1.25" ID	AMSBA310160380	\$ 25.00	
Utility: 1510	Radiator Hose, Upper 1.25" ID	AMSBA310160750	\$ 19.00	
Utility: 1530, 1630, 1725, 1925, TC25, TC25D, TC29, TC29D, TC33, TC33D	Radiator Hose, Upper 1.312" ID	AM86519847	\$ 11.00	
Utility: 1600	Radiator Hose, Upper 1.25" ID	AMSBA310160050	\$ 21.00	
Utility: 1700 10/1979 and Later, 1710	Radiator Hose, Upper 1.312" ID	AMSBA310160450	\$ 22.00	
Utility: 1700, 1900 1979-09/79	Radiator Hose, Upper 1.25" ID	AMSBA310160170	\$ 21.00	
Utility: 1900 ASN U902326 10/1979 and Later	Radiator Hose, Upper 1.25" ID	AMSBA310160430	\$ 30.00	

Prices Subject to Change without Prior Notice. The use of original equipment manufacturer (OEM) part numbers or trademarks, e.g. Case® and John Deere®, are for reference purposes only and for indicating product use and compatibility. Our company and the listed replacement parts contained herein are not sponsored, approved or manufactured by the OEM. All parts are New unless designated Reman in the description.

Ford® / New Holland®—Tractor

Application	Description	Part Number	Retail Price	Core
Utility: 1910	Radiator Hose, Upper 1.25" ID	AMSBA310160840	\$ 21.00	
2N, 8N, 9N	Radiator Hose, Lower 1.562" ID	AM8N8286	\$ 9.35	
2N, 8N, 9N, 501 Series, 600, 601 Series, 650, 701 Series, 800, 801 Series, 1800 Series, (2000, 4000 - 1962-64 w/ 4 Cylinder Engine), 2030, 2120, 2130, 4030, 4040, 4120, 4130, 4140, Ind: 660	Radiator Hose, Lower 1.50" ID	AM312588	\$ 5.00	
(230A, 334, 3610V - 1981-04/83 w/ 3 Cylinder Engine), (231, 233, 333, 531, 2600N, 2600R, 3600N, 3600V, 3900, 4600O - 1975-81 w/ 3 Cylinder Engine), (234 1975-04/83, 2310 03/1982-83, 2600V 10/1975-09/76, 2610V 1970-02/1990, 3600R 1975-77, 3610NO 08/1981-04/83, 3910 05/1983-02/90, 3910R 1981-84, 3910V 12/1983-02/90, 3930N 03/1990-06/95, 4110N 12/1981-02/90, 4410 1969-12/74, 4600NO 10/1975-81, 4600SU 1975-07/81 - w/ 3 Cylinder Engine), (2000, 3230, 3930, 4000, 4630 - w/ 3 Cylinder Engine), 340, 2600, 2610, 2810, 3000, 3055, 3100, 3400, 3430, 3600, 3610, 4100, 4110, 4600, 4610, 4830, 5030, 6600, (2100, 2110, 2120, 2300, 2310, 3110, 3120, 3190, 3300, 3310, 3330, 4190, 4200, 4330, 4340 - 1965-74 w/ 3 Cylinder Engine), (2910, 3910H, 3910N - 1983-02/90 w/ 3 Cylinder Engine), (3930NO, 4130NO, 4630N, 4630NO, 4630O - 03/1990-08/99 w/ 3 Cylinder Engine), (4110NO, 4110O, 4110V, 4610NO - 1981-02/90 w/ 3 Cylinder Engine), (4830N 07/1990-05/94, 5030O 06/1994-04/98, 7700 1976-80 - w/ 4 Cylinder Engine), Ind: 420, 445, 515, 540, 3500, 3550, 4130 1963-64, 4500 1965-74 w/ 3 Cylinder Engine	Radiator Hose, Lower 1.725" ID	AMC5NN8286B	\$ 11.00	
(231, 233, 333, 531, 2600, 2600N, 2600R, 3600, 3600N, 3600V, 3900, 4100, 4600, 4600NO, 4600O - 1975-81 w/ 3 Cylinder Engine), 335, 2100 03/1965-74, 2600V 10/1975-09/76, 3600R 1975-77, 4600SU 1975-07/81, 5000, 5100, 5600, 5900, 7000, 7100, 7600, (2000, 2110, 2120, 2300, 3055, 4000, 4100, 4110, 4190, 4200, 4330, 4340, 4410 - 1965-74 w/ 3 Cylinder Engine), (5110 05/1984-10/91, 5610 1981-93, 5610S 12/1993 and Later, 6600 w/o Oil Cooler, 6610 1981-93, 6610S 1994 and Later, 6710 1981-09/85, 7010 04/1996 and Later, 7610O 10/1981-91, 7610S 1994 and Later, 7700 1976-80 - w/ 4 Cylinder Engine), (6810, 7410 - 04/1989-10/91 w/ 4 Cylinder Engine), (7610, 7710 - 1981-10/91 w/ 4 Cylinder Engine), Ind: 445 Gas or Diesel, 535, 540A Diesel, 540B Diesel, 545, 545A Diesel, (3500, 3550 1965-74 w/ 3 Cylinder Engine), 4500	Radiator Hose, Lower 1.645" & 1.757" ID Replaces 81805638, 83907879, 87745803, C5NN8286CV	AMC5NN8286C	\$ 12.00	
(231, 233, 333, 531, 2600, 2600N, 2600R, 3600, 3600N, 3600V, 3900, 4100, 4600, 4600O - 1975-81 w/ 3 Cylinder Engine), (4600NO 10/1975-81, 2600V 10/1975-09/76, 3600R 1975-77, 4600SU 1975-07/81 w/ 3 Cylinder Engine), (5110 05/1984-10/91, 5610S 12/1993 and Later, 5900 05/1985-12/93, 6710 1981-09/85, 7010 04/1996 and Later, 7610O 10/1981-91, 7700 1976-80, 7710 1981-10/91 - w/ 4 Cylinder Engine), (5600, 6600 - w/ 4 Cylinder Engine w/ Transmission Oil Cooler), 5610, 6610, (6610S, 7610S - 1994 and Later w/ 4 Cylinder Engine), (6810, 7410 - 04/1989-10/91 w/ 4 Cylinder Engine), 7610	Radiator Hose, Lower 1.812" ID Replaces 83907879, 87745809	AMD5NN8286F	\$ 18.00	
(231, 233, 333, 531, 2600, 2600N, 2600R, 3600, 3600N, 3600V, 3900, 4100, 4600, 4600O - 1975-81 w/ 3 Cylinder Engine), (2600V 10/1975-9/76, 3600R 1975-77, 4600NO 10/1975-81, 4600SU 1975-07/81 - w/ 3 Cylinder Engine), (4000, 4110, 4190, 4200, 4330, 4340 - 1965-74 w/ 3 Cylinder Engine), 4410 1969-74 w/ 3 Cylinder Engine, 5200, 6600C, 7200, 7600C, 7700 1976-80 w/ 4 Cylinder Engine, Ind: 4500 1965-74 w/ 3 Cylinder Engine	Radiator Hose, Lower 1.75" ID	AMD0NN8286A	\$ 30.00	
(231, 233, 333, 531, 2600, 2600N, 2600R, 3600, 3600N, 3600V, 3900, 4100, 4600, 4600O - 1975-81 w/ 3 Cylinder Engine), (4600NO 10/1975-81, 4600SU 1975-07/81, 2600V 10/1975-09/76, 3600R 1975-77 - w/ 3 Cylinder Engine), (5110 05/1984-10/91, 5610 1981-93, 6610 1981-93, 6710 w/o A/C, 6810 04/1989-10/91, 7410 04/1989-10/91, 7610 1981-10/91, 7610O 10/1981-91, 7700 1976-80, 7710 w/o A/C - w/ 4 Cylinder Engine), 5700, 6700	Radiator Hose, Lower 1.75" ID Replaces 83909073	AMD6NN8286B	\$ 26.00	

Ford® / New Holland®—Tractor

Application	Description	Part Number	Retail Price	Core
231, 233, 333, 531, 2600, 2600N, 2600R, 3600, 3600N, 3600V, 3900, 4100, 4600, 4600NO, 4600O - 1975-81 w/ 3 Cylinder Engine), (2600V 10/1975-09/76, 3600R 1975-77, 4600SU 1975-07/81 - w/ 3 Cylinder Engine), (5110 05/1984-10/91, 5610 1981-93, 6610 1981-93, 5900 1985-93, 6710 w/ A/C, 6810 04/1989-10/91, 7410 04/1989-10/91, 7610 1981-10/91, 7610O 10/1981-91, 7710 w/ A/C - w/ 4 Cylinder Engine), 7700	Radiator Hose, Lower 1.75" ID	AME8NN8286BA	\$ 22.00	
1000, Utility: 1600	Radiator Hose, Lower 2.75" & 2.875" ID	AMSBA310160060	\$ 30.00	
2000, 2120, 2150, 2300, 2310, 2600, 2600V, 2610, 2810, 2910, 3000, 3055, 3110, 3120, 3150, 3190, 3230, 3300, 3310, 3330, 3400, 3430, 3500, 3600, 3600V, 3610, 3900, 3910, 3930, 4110, 4130, 4140, 4190, 4330, 4340, 4400, 4410, 4600, 4600SU, 4610, 4630, 4830, 5000, 5030, 5190, 5340, 5600, 5700, 6600, 6700, 7000, 7600, 7700, Ind: 230A, 231, 233, 234, 250C, 260C, 333, 334, 335, 340, 340A, 340B, 420, 445, 445A, 450, 515, 530A, 531, 532, 535, 540, 540A, 540B, 545, 545A, 3550	Radiator Hose, Lower 1.725" ID Replaces C5NN8286B	AM81805637	\$ 9.35	
(4000, 4110, 4190, 4330, 4340 - 1965-74 w/ 3 Cylinder Engine), 4100 w/ 3 Cylinder Engine, 4200 Gas or Diesel, 4410 1969-74 w/ 3 Cylinder Engine, Ind: 4500 1965-74 w/ 3 Cylinder Engine	Radiator Hose, Lower 1.75" ID	AMC5NN8286D	\$ 23.00	
(5610S 12/1993 and Later, 6610S 1994 and Later, 7610O 10/1981-91 - w/ 4 Cylinder Engine), (6810, 7610 - 06/1989 and Later w/ A/C), 7610S 10/1997 and Later, 7810 w/ BSD666 Engine, 7810S, (7810O 02/1988-10/91, 8010 04/1996 and Later - w/ 6 Cylinder Engine)	Radiator Hose, Lower 1.97" ID Replaces 83961071, 83976368, 87745812	AME7NN8286AA	\$ 30.00	
5640, 6640, 7740, 7840, 7840O 02/1993-01/98 w/ 6 Cylinder Engine, 8240, 8340	Radiator Hose, Lower 1.75" ID Replaces 81868754	AMF0NN8286AB	\$ 20.00	
6000	Radiator Hose, Lower 1.875" ID	AMC0NN8286A	\$ 9.00	
(7910, 8210 - w/ BSD666 Engine), (8000 1968-78, 8200 1968-09/72, 8600 10/1972-07/76, 8700 08/1976-78, 9000 1969-78, 9200 1969-09/72, 9600 10/1973-07/76, 9700 08/1976-78 - w/ 6 Cylinder Engine), TW10, TW20, TW30, Ind: 8400 1971-09/72 w/ 6 Cylinder Engine	Radiator Hose w/ Clamps, Lower 1.75" ID	AMD8NN8B274AB	\$ 13.00	
8000 Prior to 07/31/76, 9600 Radiator to Cooler, (8200 1968-09/72, 8600 10/1972-07/76, 8700 08/1976-78, 9000 10/1972-07/76, 9200 1969-09/72, 9700 08/1976-78 - w/ 6 Cylinder Engine), Ind: 8400 1971-09/72 w/ 6 Cylinder Engine	Radiator Hose, Lower 2" & 2.375" ID	AMC7NN8286A	\$ 16.00	
(8000 1968-78, 8200 1968-09/72, 8600 10/1972-07/76, 8700 08/1976-78, 9200 1969-09/72, 9600 10/1973-07/76, 9700 1976-78 - w/ 6 Cylinder Engine), 9000 Prior to 07/1976, Ind: 8400 1971-09/72 w/ 6 Cylinder Engine	Radiator Hose, Lower 2" ID	AMC9NN8286A	\$ 18.00	
(8000, 8700, 9000 - 08/1976 and Later), 9700, (8200 1968-09/72, 8600 10/1972-07/76, 9200 1969-09/72, 9600 10/1973-07/76 - w/ 6 Cylinder Engine), Ind: 8400 1971-09/72 w/ 6 Cylinder Engine	Radiator Hose, Lower 1.75" & 2" ID Replaces 86620261	AMD6NN8286C	\$ 35.00	
8670, 8670A, 8770, 8770A, 8870, 8870A, 8970, 8970A	Radiator Hose, Lower 2" & 2.06" ID	AM9821599	\$ 22.00	
Dexta, Super Dexta	Radiator Hose, Lower 1.28" & 1.40" ID	AM957E8286	\$ 33.00	
Major, Super Major, Power Major	Radiator Hose, Lower 1.75" ID Replaces E1ADDN8286	AM81718086	\$ 17.00	
(Workmaster 65, Workmaster 75 - Prior to 09/2018)	Radiator Hose, Lower	AM87473908	\$ 12.00	
Ind: 7500	Radiator Hose, Lower 1.75" ID	AMD1NN8286B	\$ 40.00	
Utility: 1110 w/ Hydrostatic Transmission	Radiator Hose, Lower	AMSBA310160770	\$ 10.00	
Utility: 1110 w/ Manual Transmission	Radiator Hose, Lower 1.312" ID	AMSBA310160790	\$ 9.00	
Utility: 1120, 1210, 1215, 1220, 1310	Radiator Hose, Lower 1" ID	AMSBA310160740	\$ 21.00	

Prices Subject to Change without Prior Notice. The use of original equipment manufacturer (OEM) part numbers or trademarks, e.g. Case® and John Deere®, are for reference purposes only and for indicating product use and compatibility. Our company and the listed replacement parts contained herein are not sponsored, approved or manufactured by the OEM. All parts are New unless designated Reman in the description.

Ford® / New Holland®—Tractor

Application	Description	Part Number	Retail Price	Core
Utility: 1320, 1520, 1620, 1715	Radiator Hose, Lower 1.25" ID	AMSBA310161091	\$ 10.00	
Utility: 1500	Radiator Hose, Lower 1.25" ID	AMSBA310160310	\$ 31.00	
Utility: 1510, 1710	Radiator Hose, Lower 1.312" ID	AMSBA310160441	\$ 21.00	
Utility: 1530, 1630, 1725, TC25, TC25D, TC29, TC29D	Radiator Hose, Lower 1.312" ID	AM86519855	\$ 13.00	
Utility: (1700, 1900 - 1979-09/79)	Radiator Hose, Lower 1.312" ID	AMSBA310160150	\$ 30.00	
Utility: (1700, 1900 - 10/1979 and Later)	Radiator Hose, Lower 1.25" ID	AMSBA310160350	\$ 31.00	
Utility: 1720, 1920	Radiator Hose, Lower 1.312" ID	AMSBA310161031	\$ 14.00	
Utility: 1910	Radiator Hose, Lower 1.25" & 1.532" ID	AMSBA310160850	\$ 26.00	
Utility: 1925, TC33, TC33D	Radiator Hose, Lower 1.312" ID	AM86526943	\$ 13.00	
Utility: T1520, TC30	Radiator Hose, Lower 1.312" ID	AMSBA310161630	\$ 18.00	
(Dexta, Super Dexta - Prior to 09/30/1989)	Radiator Hose 1.625" ID Replaces 957E8333B	AM81718101	\$ 24.00	
Fordson Major, Fordson Super Major, Fordson Power Major	Radiator Hose 1.75" ID	AM81718097	\$ 9.00	
1320, 1520, 1530, 1620, 1630, 1710, 1710O, 1715, 1720, 1725, 1920, 1925, 2030, 2120, 3415, Boomer 1020, Boomer 1025, Boomer 1030, Boomer 2035, Boomer 3040, Boomer 3045, Boomer 3050, Boomer 4055, Boomer 4060, T1010, T1030, T1110, T1510, T1520, T2210, T2220, T2310, T2320, T2330, T2410, T2420, TC23DA, TC24D, TC24DA, TC25, TC25D, TC26DA, TC29, TC29D, TC29DA, TC30, TC31DA, TC33, TC33D, TC33DA, TC34DA, TC35, TC35A, TC35D, TC35DA, TC40, TC40A, TC40D, TC40DA, TC45, TC45A, TC45D, TC45DA, TC48DA, TC55DA, TT45A, TT50A, TZ18DA, TZ22DA, TZ25DA	Bypass Hose 0.54" ID Replaces 83966732, 87772767, 87780789	AMSBA145536051	\$ 7.00	
Dexta, Super Dexta	Bypass Hose 1.125" ID Replaces 747936M91, 81716947, 86513585, E6CJ9, E15CJ9	AM731256M1	\$ 7.00	
Dexta, Super Dexta	Water Pump Inlet Hose 1.375" ID Replaces 8176946	AM732443M1	\$ 9.00	



Engine Fans and Components

Application	Description	Part Number	Retail Price	Core
500 Series, 600 Series, 800 Series, 900 Series, 2000, 4000 - Gas	Engine Fan 3 Blade, 16" Diameter, 3.12" Bolt Circle Diameter, 0.625" Pilot Hole Diameter	AMNCA8600S	\$ 57.00	
5610S ASN 308716M, 6610S ASN 359818M, 6810S, 7600, 7610, 7610S, 7810, 7810S, 8010, TB80, TB85, TB90, TB100, TB110, TB120	Engine Fan 7 Blade, 17.50" Diameter, 5/8" Pilot Hole	AME8NN8600DB	\$ 75.00	
TG210, TG230, TG255, TG285	Engine Fan 8 Blade, 6-Bolt Hub Replaces 87778091	AM278432A1	\$ 385.00	

Ford® / New Holland® —Tractor

Application	Description	Part Number	Retail Price	Core
501, 541, 600, 601, 611, 620, 621, 630, 631, 640, 641, 650, 651, 660, 661, 671, 681, 700, 701, 740, 741, 771, 800, 801, 811, 820, 821, 840, 841, 850, 851, 860, 861, 871, 881, 900, 901, 941, 946, 950, 951, 960, 961, 971, 981, 2000, 2031, 2111, 2130, 2131, 4000, 4030, 4031, 4110, 4120, 4121, 4130, 4140	Fan Shroud Replaces NCA8146A	AM86551380	\$ 80.00	



Flywheels and Components

Application	Description	Part Number	Retail Price	Core
2N, 8N, 9N, 600, 700, 800, 900, (2000, 4000 - Prior to 1964), NAA, NAB	Flywheel Ring Gear 134 Tooth, 11.994" ID, 13.552" OD	AM9N6384	\$ 28.50	
2000, 2100, 2110, 2120, 2300, 2310, 2600, 2610, 2810, 2910, 3000, 3055, 3100, 3120, 3190, 3300, 3310, 3330, 3400, 3600, 3610, 3900, 3910, 4000, 4100, 4110, 4190, 4200, 4330, 4340, 4410, 4600, 4610, 5000, 5100, 5190, 5200, Ind/Const: 230A, 231, 233, 234, 333, 334, 335, 340, 340A, 340B, 420, 445, 445A, 450, 515, 530A, 531, 532, 535, 540, 540A, 540B, 545, 545A, 550, 555, 555A, 555B, 655, 655A, 3500, 3550, 4400, 4500, 5500, 5550	Flywheel Ring Gear 162 Tooth, 14.634" ID, 16.245" OD	AMC5NE6384B	\$ 210.00	
2000, 2600, 2610, 3000, 3230, 3430, 3600, 3610, 3930, 4000, 4110, 4200, 4430, 4600, 4610, 4630, 5000, 5600, 5700, 6600, 6700, 7000, 7600, 7700, 8000, 9000, TW5, TW10, TW15, TW20, TW25, TW30, TW35	Flywheel Ring Gear 128 Tooth, 16.115" OD, 14.52" ID, 0.625" Wide	AME2NN6384AA	\$ 47.00	
Dexta, Super Dexta	Flywheel Ring Gear Replaces 957E6384, 81804209	AM957E6384B	\$ 84.00	
8670, 8670A, 8770, 8770A, 8870, 8870A, 8970, 8970A	Drive Plate 36 Spline, 13" OD	AM9825201	\$ 580.00	\$ 15.00

Water Pumps and Components

The remanufactured water pumps we supply have an extra step added to the remanufacturing process to ensure quality. Since the bearing and seal assembly are critical in performance, we ensure air-tight seals by vacuum testing our water pumps prior to packaging. This guarantees no leakage will occur after your water pump has been installed.



Application	Description	Part Number	Retail Price	Core
2N, 8N, 9N	Water Pump w/ Single Groove Pulley	AMCDPN8501A	\$ 43.00	
230A, 231, 233, 234, 250C, 260C, 333, 334, 335, 340, 340A, 340B, 345C, 345D, 420, 445, 445A, 445C, 445D, 450, 455, 455C, 455D, 515, 530A, 531, 532, 535, 540, 540A, 540B, 545, 545A, 545C, 545D, 550, 555, 555A, 555B, 650, 655, 655A, 2000, 2100, 2110, 2120, 2300, 2310, 2600, 2610, 2810, 2910, 3000, 3055, 3100, 3120, 3230, 3300V, 3310N, 3330NO, 3400U, 3430, 3500, 3550, 3600, 3610, 3910, 3930, 4000, 4100, 4110, 4130, 4140SU, 4200, 4330NO, 4340, 4400, 4410, 4500, 4600, 4610, 4630, 4830, 5000, 5030, 5100, 5110, 5200, 5340O, 5600, 5610, 5700, 5900, 6410 United Kingdom, 6500, 6600, 6600C, 6610, 6700, 6710, 6800, 6810, 7000, 7100, 7200, 7410, 7600, 7600C, 7610, 7700, 7710, Ind/Const: 750TLB, 755TLB, 755ATLB, 755BTLB, 3500, 3550 - All 1965-88 w/ 3 Cylinder or 4 Cylinder Engine, Engines: BSD332, BSD333, BSD333H, BSD442, BSD444, BSD444H, BSD444T	Water Pump w/ Single Groove Pulley, 5/16" and 3/8" Bolts Replaces EGP8A513DA, EAPN8A513F, FAPN8A513GG	AM82845215	\$ 54.00	
230A, 231, 234, 334, 335, 340, 340B, 420, 445, 445A, 515, 530A, 531, 532, 535, 540, 540A, 540B, 545, 545A, 650, 750, 755, 755A, 2000, 2110, 2310, 2600, 2610, 2610N, 2810, 2910, 3000, 3400, 3600, 3610, 3610NO, 3610V, 3910, 4000, 4100, 4110, 4110N, 4400, 4410, 4500, 4600, 4600O, 4600SU, 4610, 4610O, 5000, 5200, 5500, 5600, 5610, 6500, 6600, 6610, 6610N, 6700, 6710, 7000, 7200, 7500, 7600, 7610, 7700, 7710, Ind: 3500, 3550 - All w/ 3 and 4 Cylinder Engine, 1965-11/1986	Reman Water Pump w/ Double Groove Pulley, 5/16" and 3/8" Bolts	AMEAPN8A513E-R	\$ 90.00	\$ 25.00

Ford® / New Holland®—Tractor

Application	Description	Part Number	Retail Price	Core
501, 541, 600, 601, 611, 620, 621, 630, 631, 640, 641, 650, 651, 660, 661, 671, 681, 701, 740, 741, 771, 800, 801, 811, 820, 821, 840, 841, 850, 851, 860, 861, 871, 881, 900, 901, 941, 950, 951, 960, 961, 971, 981, 1801, 1811, 1821, 1841, 1871, 1881, 2000 Series 1955 and Later, 2030, 2031, 2110TR, 2111, 2120, 2130, 2131, 4000 Series 1955 and Later, 4030, 4031, 4040, 4110TR, 4120, 4121, 4130, 4131, 4140 - 1955-64 w/ 172 CID Gas or Diesel Engine	Water Pump w/ Hub For Bolt-on Pulley Pulley Not Included Replaces CDPN8501C, DCPN8501A	AM3971351	\$ 46.00	
501, 541, 600, 601, 611, 620, 621, 630, 631, 640, 641, 650, 651, 660, 661, 671, 681, 701, 740, 741, 771, 800, 801, 811, 820, 821, 840, 841, 850, 851, 860, 861, 871, 881, 900, 901, 941, 950, 951, 960, 961, 971, 981, 2031, 2110, 2111, 2120, 4031, 4040, 4110, 4120, 4121, 4131, 4030, 4130, 4140, Ind: 1801, 1811, 1821, 1841, 1871, 1881, 2030, 2130, 2131 - All 1955-64 w/ 172 CID 4 Cylinder Gas or Diesel Engine	Water Pump w/ Single Groove Pulley Replaces 3971351, DCPN8501A	AMCDPN8501C	\$ 61.00	
1120, 1210, 1215, 1220, 1310	Water Pump	AMSBA145017300	\$ 104.00	
1164 1972-07/76, (8000, 8200 - 1968-07/76), 8600 1972 and Later, Ind: 8400 1972 and Later	Reman Water Pump w/ Single Groove Pulley, 5/16" and 3/8" Bolts 5 5/8" Diameter Pulley, 2 5/8" Tall, 4" Diameter Impeller	AMDHPN8A513B-R	\$ 89.00	\$ 25.00
1500, 1700, 1900	Water Pump	AMSBA145016120	\$ 78.00	
1710 - 1983-86	Water Pump Replaces 83940738, SBA145016510	AMSBA145016450	\$ 107.00	
(1720, 1920, 3415 - 1987 and Later), 2120 03/1999 and Later, Boomer 4055, Boomer 4060, T1510, T1520, T2210, T2220, T2310, T2320, T2330, T2410, T2420, TC33, TC33D, TC34DA, TC35, TC35A, TC35D, TC35DA, TC40, TC40A, TC40D, TC40DA, TC45, TC45A, TC45D, TC45DA, TC48DA, TC55DA, TT45A, TT50A	Water Pump	AMSBA145017790	\$ 176.00	
(2000, 3000, 4000, 5000, 7000 - w/ 3 and 4 Cylinder Engines, 1965-75), (2600, 3600, 4100, 4600, 5600, 5700, 6600, 6700, 7600, 7700 - w/ 3 and 4 Cylinder Engines, 1975-81), (2310, 2610, 2810, 2910, 3610, 3910, 4110, 4610 - w/ 3 and 4 Cylinder Engines, 1981-02/90), (5110, 5610, 6610, 6710, 7610, 7710 - w/ 3 and 4 Cylinder Engines, 1981-10/88)	Water Pump w/ Double Groove Pulley, 5/16" and 7/16" Bolts Replaces EAPN8A513E, EGN8A513CA, FAPN8A513DD	AM87800109	\$ 60.00	
3010S, 3830, 4230, 4330V, 4430, 4835, 5530, 5635, 6530, 6635, 7635, TL100, TL70, TL80, TL90, TN55, TN55D, TN55S, TN60VA, TN65, TN65D, TN65F, TN65S, TN65V, TN70, TN70D, TN70F, TN70S, TN75, TN75D, TN75F, TN75S, TN74V, TN80F, TN90F, TN95F, TT55, TT75	Water Pump	AM99454833	\$ 133.00	
4830, 4830N, 4830O, 5030, 5030O, 5110, 5610, 6410, 6610, 6610O, 6710, 6810, 7410, 7610O, 7710	Water Pump Replaces 81872278, 83960873, E6NN8501HA	AM87800119	\$ 140.00	
5110, 5610, 5910, 6410, 6810, 7610, 7710 - 11/88-10/91 w/ 4 Cylinder Diesel Engine	Water Pump w/ Single Groove Pulley, Threaded for Fan Replaces FAPN8A513HH	AMFAPN8A513HH	\$ 130.00	
	Water Pump w/ Fan Clutch Replaces EJP8A513FB	AMFAPN8A513AA	\$ 170.00	
	Water Pump w/ Double Groove Pulley	AMEAPN8A513D	\$ 81.00	
5640, 6640, 7740, 7840	Water Pump w/ Serpentine Pulley, 147 mm Diameter Will not fit models equipped w/ Mando A/C	AM87800714	\$ 230.00	
	Water Pump w/ Serpentine Pulley, 140 mm Diameter Will not fit models w/ Mando A/C	AM87800712	\$ 128.00	
7740, 7840, 8240, 8340 - w/ Mando A/C	Water Pump Includes Mounting Gasket	AM87840257	\$ 218.00	
7810, 7810S, 8010, TB120	Water Pump Includes Mounting Gasket Replaces 81863835, 83926130, 83961310, EJPN8A513BA, SW06499, VPE1038	AMFAPN8A513CC	\$ 167.00	

Ford® / New Holland®—Tractor

Application	Description	Part Number	Retail Price	Core
(7910, 8210 - 02/1982-10/91), (8530, 8630, 8730, 8830 - 03/1990 and Later), (8700, 9700 - 08/1976-78), (TW5, TW15, TW25, TW35 - 1983-02/90), (TW10, TW20, TW30 - 1979-82)	Water Pump w/ Single Groove Pulley, Mounts w/ 5/16" and 7/16" Bolts Replaces EAPN8A513G, EGPN8A513BA	AMFAPN8A513LL	\$ 84.00	
7910 02/1982-11/86, 8700 1976 and Later, 9700, (TW5, TW10, TW15, TW20, TW25, TW30, TW35 - 08/1976-11/87)	Reman Water Pump w/ Single Groove Pulley, 5/16" and 3/8" Bolts	AMEAPN8A513G-R	\$ 95.00	\$ 25.00
8000, 8200, 8400, 8600	Water Pump Includes Mounting Gasket Pulley and Hub Not Included Replaces 8508AB, 83912464	AMDHPN8A513B	\$ 92.00	
8160, 8260, 8360, 8560, TM115, TM125, TM135, TM150, TM165, TV140	Water Pump Replaces 82847714, 87840689, 87840823	AM82847712	\$ 224.00	
8670, 8670A, 8770, 8770A, 8870, 8870A, 8970, 8970A	Water Pump w/ O-Ring Seal Replaces 87800490, 87800491, 87840704, 87840705	AM87801873	\$ 206.00	
9000, 9200, 9600 - 1969-07/76	Reman Water Pump w/ Single Groove Pulley, 5/16" and 3/8" Bolts 4 1/2" Diameter Pulley, 2 5/8" Tall, 4" Diameter Impeller	AMDHPN8A513A-R	\$ 95.00	\$ 25.00
9000, 9600 - 1968-07/76	Water Pump w/ Single Groove Pulley, 4.50" Diameter Pulley Includes Mounting Gasket Replaces 83912463	AMDHPN8A513A	\$ 97.00	
Dexta, Super Dexta	Water Pump w/ Hub	AM957E8501B	\$ 90.00	
Fordson Major Diesel, Fordson Super Major	Water Pump w/ Hub w/o Pulley Replaces DKN8501A, DKN8501B, DKN8501C, E1ADKN8501A, E1ADKN8501C	AME1ADKN8501B	\$ 50.50	
NAA (Golden Jubilee) 1953-54	Water Pump w/ Single Groove Pulley Replaces CPN8591B, EAF8501B	AMCDPN8501B	\$ 73.00	
TG210, TG230, TG255, TG285	Water Pump Replaces 86993431	AM87453208	\$ 145.00	
TL70A, TL80A, TL90A, TL100A, TS100A, TS110A, TS115A, TS125A, TS130A, TS135A	Water Pump w/o O-Ring Seal	AM2852114	\$ 60.00	
TJ275, TJ325	Water Pump Replaces 87308650, 87774990, J940052	AMJ804927	\$ 80.00	
TJ380, TJ430, T9030, T9040, T9050, Combine: CR9070	Water Pump Replaces 504079715	AM504102491	\$ 108.00	
TM120, TM130	Water Pump Replaces 87384587	AM87802491	\$ 280.00	
TM120, TM130, TM140, TM155, TM175, TM190, TV145	Water Pump w/o O-Ring Seal w/ Dual Serpentine Pulley, Threaded Hub for Fan Clutch	AM87384588	\$ 120.00	
TM140, TM155, TM175, TM190	Water Pump Replaces 87384586	AM87802490	\$ 245.00	
Ind: 550, 555, 555A - 1975-12/86	Reman Water Pump w/ Double Groove Pulley, 5/16" and 3/8" Bolts 5 5/8" Diameter Pulley, 3 3/4" Tall, 4" Diameter Impeller	AMEAPN8A513H-R	\$ 85.00	\$ 5.00
Utility: 1530, 1630, 1725, TC25, TC25D, TC29, TC29D, TC29DA	Water Pump Includes Mounting Gasket Replaces 87761849, SBA145016891, SBA145017660	AMSBA145017661	\$ 156.00	
Utility: 1720, 1920, 2120 ASN UV32235, 3415	Water Pump	AMSBA145017730	\$ 77.00	
5640, 6640, 7740, 8240, 8340, TS90, TS100, TS110, TS115	Belt Tensioner Replaces 83998237, F0NN6B209AA, F1NN6B209AA	AM87801689	\$ 56.00	

Prices Subject to Change without Prior Notice. The use of original equipment manufacturer (OEM) part numbers or trademarks, e.g. Case® and John Deere®, are for reference purposes only and for indicating product use and compatibility. Our company and the listed replacement parts contained herein are not sponsored, approved or manufactured by the OEM. All parts are New unless designated Reman in the description.

Ford® / New Holland®—Tractor

Application	Description	Part Number	Retail Price	Core
T6010, T6020, T6030 SN Z*BK40001-Z*BK50000 Excluding Power Command, T6040, (T6050, T6070, T6080 SN Z*BK40001-Z*BK50000 Excluding Power Command and Range Command), T6060, (TS100A, TS115A - Excluding Plus and Deluxe), TS125A, TS130A, TS135A, TS6020, TS6030, TV6070 Bi-Directional	Belt Tensioner Replaces 2852161, 2853680, 2854611, 2855622, 2856687, 87415847, 87415848, 87803067	AM504028028	\$ 89.00	
8160, 8260, 8360, 8560, TC140, TM115, TM120, TM125, TM130, TM135, TM140, TM150, TM155, TM165, TM175, TM190, WDX2302	Belt Tensioner	AM87801838	\$ 119.00	
TG210, TG230, TG255, TG285, TJ280, TJ330, T9020 Replaces 87409564, 87775209	Belt Tensioner	AM87436755	\$ 67.19	

Fan Clutches

Application	Description	Part Number	Retail Price	Core
5640, 6640, 7740, 7840, 8240, 8340, T6010, T6020, T6030, T6050, T6070, T6.120, T6.140, T6.150, T6.155, T6.160, T6.165, T6.175, TM120, TM130, TM140, TM175, TM190, TS90, TS100, TS100A, TS110, TS110A, TS115A, TS125A, TS130A, TS135A, TS6.110, TS6.120, TS6.125, TS6.130, TS6.140	Fan Clutch Assembly	AM81862862	\$ 225.00	
8530, 8630, 8730, TW5, TW15, TW25	Fan Clutch Assembly 4-Bolt Mount Replaces 83932779, E4NN8A616BC	AM81865533	\$ 270.00	
Workmaster 65, Workmaster 75 - Prior to 09/2018	Fan 6 Blade	AM87479461	\$ 66.00	
2N, 8N, 9N, NAA, NAB	Fan w/ Spacer 4 Blade	AM8N8600A	\$ 57.00	
Workmaster 65, Workmaster 75 - Prior to 09/2018	Fan Drive Spacer	AM87479460	\$ 17.00	

Belts

Application	Description	Part Number	Retail Price	Core
5640, 6640, 7740, 7840, 8240, 8340 - Models Prior to 11/91 w/ AC	Fan Belt, Alt / Gen Belt	AMF3NN8620AA	\$ 31.64	
8000 1960-01/73 (Alt Belt - 1968-7/76)	Fan Belt Alt / Gen Belt	AM86518907 AM9604339	\$ 9.90 \$ 10.00	
8000 02/73-07/76	Fan Belt, Alt / Gen Belt	AMD2NN8620A	\$ 13.46	
8670, 8770, 8870, 8970 - 09/93	Fan Belt, Water Pump Belt	AM86013678	\$ 38.25	
8700, 9700 - 08/76-78	Fan Belt, Alt / Gen Belt	AM9625879	\$ 12.55	
TW5, TW15, TW25, TW35	Fan Belt Alt / Gen Belt	AMAD6NN8620B AM9842660	\$ 12.55 \$ 13.00	
8160, 8260, 8360, 8560, TM115, TM120, TM125, TM130, TM135, TM140, TM150, TM155, TM165, TM175, TM190, TV140	Belt Tensioner	AMAH155348	\$ 75.00	



Carburetors

Application	Description	Part Number	Retail Price	Core
2N, 8N, 9N	Carburetor	AMTSX241C	\$ 160.00	
600, 700, 800, 900, 2000, 4000	Carburetor, Zenith	AMX82003	\$ 550.00	
600, 700, 2000	Carburetor, Zenith	AMX82002	\$ 508.00	
600, 700, 2000	Carburetor, Zenith	AMTSX765	\$ 402.00	
800 w/ 172 CID Engine	Reman Carburetor	AMEAF9510G	\$ 195.00	\$ 100.00
800, 900, 4000	Carburetor	AMX82007	\$ 550.00	
800, 4000	Carburetor, Zenith	AMTSX813	\$ 457.00	
800, 4000	Carburetor, Zenith	AMTSX769	\$ 489.00	
800, 900, 4000	Carburetor, Zenith	AMTSX706	\$ 524.00	

Ford® / New Holland®—Tractor

Application	Description	Part Number	Retail Price	Core
2000, 2100, 2110, 2120, 2300, 2310, 2600, 2610, Ind: 230A, 231	Carburetor, Zenith	AMR8552	\$ 646.00	
2000, 2100, 2120, 2300, 2310, 2600, 2610 - w/ 3 Cylinder Engine	Carburetor, Zenith Replaces C5NN-L	AMR3656	\$ 669.00	
2000, 3000, 4000 - w/ 3 Cylinder Engine	Reman Holley Carburetor	AME1NN9510A	\$ 225.00	\$ 100.00
3055, 3100, 3120, 3190, 3330, 3400, 3500, 3600, Ind: 335, 340, 420, 445	Carburetor, Zenith	AMR7893	\$ 634.00	
4000, 4100, 4110, 4140, 4190, 4200, 4330, 4340, 4400, 4500, 4600, 4610, Ind: 515, 531, 535, 545, 550, 555	Carburetor, Zenith	AMR8554	\$ 588.00	
4000, 4110, 4140, 4190, 4200, 4330, 4340, 4400, 4410, 4500, 4600, 4610 - w/ 3 Cylinder Engine	Carburetor Replaces C5NN-N	AMR3657	\$ 825.00	



Fuel Lift Pumps

Application	Description	Part Number	Retail Price	Core
Models 1965 and Later Used on Most 3, 4 and 6 Cylinder Diesel Engines	Fuel Lift Pump	AMD8NN9350AB	\$ 20.00	
5610S, 6610S, 6810S, 7010 ASN 850179M, 7610S, 8010, 8160, 8260, 8360, 8560, TB80, TB85, TB90, TB100, TB110, TB120, TM115, TM120, TM125, TM130, TM135, TM140, TM150, TM155, TM165, TM175, TM190, TS90, TS100, TS110, TS115 ASN 170078, TV145	Fuel Lift Pump	AM87802238	\$ 77.00	
5610S, 6610S, 7610S, T4020, T4020V, T4030, T4030F, T4030N, T4030V, T4040, T4040F, T4040N, T4040V, T4050, T4050F, T4050N, T4050V, T4060F, T4060N, T4060V, T5040, T5050, T5060, T5070, T6010, T6020, T6030, T6050, T6070, T4.65, T4.65V, T4.75, T4.75F, T4.75V, T4.85F, T4.85V, T4.95F, T4.95V, T4.105F, T4.105V, TD4040F, TD5010, TD5020, TD5030, TD5050, TL80A, TL90A, TL100A, TN85A, TN85DA, TN85SA, TN95A, TN95DA, TS100A, TS110A, TS115A, TS125A, TS130A, TS6000, TS6020, TS6030, TV6070, Workmaster 45, Workmaster 55, Workmaster 65, Workmaster 75, Ind/Const: B90B, B95, B95LR, B95TC, B110, B115, E175B, E215B, LB75.B, LB90.B, LB110.B, LB115.B, LM415A, LM435A, LM445A, LM1340, LM1440, LM1740, LM5040, LM5060, LM5080, LW110.B, LW130.B, M357, M427, M428, M459, M551, T13, T14, T17, VL5080, VL5090, VL6040, VL6050, VL6060, VL6090, VM370, VM460, VN2090, VM3080, VM3090, VM4090, VX7090, W110, W110TC, W130, W130TC	Fuel Lift Pump Replaces 84268475, 84269570, 504146090	AM2830266	\$ 37.00	
7010, 8010, TB80, TB85, TB90, TB100, TB110, TB120	Fuel Lift Pump	AM82980167	\$ 78.00	
5640, 6640, 7740, 7840, 8240, 8340	Fuel Primer Pump All Primer Assembly	AM81866602	\$ 69.00	
Ind: LV80, U80	Fuel Transfer Pump Replaces 87473337, J917998	AM87648717	\$ 87.00	

Fuel Components

Application	Description	Part Number	Retail Price	Core
T8.275, T8.300, T8.320, T8.330, T8.350, T8.360, T8.380, T8.390, T8.410, T8.420, T8.435	Fuel Cooler	AM84384558	\$ 690.00	
2000, 2110, 2120, 2150, 2300, 2310, 2600, 2610, 2810, 2910, 3000, 3055, 3110, 3120, 3150, 3300, 3310, 3330, 3400, 3500, 3600, 3610, 3900, 3910, 4110, 4330, 4340, 4400, 4410, 4500, 4600, 4600SU, 4610, 5000, 5340, 5600, 6600, 7000, 7600	Fuel Sending Unit Replaces 87712903, D8NN9A316EA, D8NN9A316EB	AMC5NN9A316B	\$ 50.00	
5000, 5100, 5110, 5600, 5610, 5900, 6410, 6600, 6610, 7000, 7100, 7600, 7610	Fuel Sending Unit Replaces 83917697, D8NN9A316DA, D8NN9A316DB	AMC5NN9A316A	\$ 68.00	
T9.480, T9.530, T9.565, T9.600, T9.645, T9.700	Sensor, Fuel Pressure	AM5801567640	\$ 200.00	

Ford® / New Holland®—Tractor

Injection Pumps

All of our injection pumps are disassembled, thoroughly cleaned and inspected. All worn out parts are replaced and the pumps are reassembled with new gaskets. Pumps are tested for leaks and fuel delivery at low idle, high idle, full load, part load and at start up. Any pumps with an automatic advance system has the advance set. As an additional quality check, all pumps are tested with a special oil that will not varnish inside the pump.

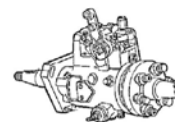

Application	Description	Part Number	Retail Price	Core
2000	Reman Injection Pump CAV, Mfg # - 3233F151	AMP2000-DPA	\$ 1075.00	\$ 200.00
2310, 2600	Reman Injection Pump CAV, Mfg # - 3233F661	AMP2310-DPA	\$ 1075.00	\$ 200.00
2610	Reman Injection Pump CAV, Mfg # - 3233F900	AMP2610-DPA	\$ 1075.00	\$ 200.00
3000	Reman Injection Pump CAV, Mfg # - 3233F380	AMP3000-DPA	\$ 1075.00	\$ 200.00
3000	Reman Injection Pump Simms, Mfg # - P4665/6	AMP4665-6	\$ 1725.00	\$ 200.00
3600	Reman Injection Pump CAV, Mfg # - 3233F631	AMP3600-DPA	\$ 1075.00	\$ 200.00
3610	Reman Injection Pump CAV, Mfg # - 3233F880	AMP3610-DPA	\$ 1075.00	\$ 200.00
4000	Reman Injection Pump Roosa Master, Mfg # - DBGVCC4298AJ24A	AMP192-DBGVCC	\$ 995.00	\$ 300.00
4000	Reman Injection Pump CAV, Mfg # - 3233F171, F390	AMP4000-DPA	\$ 1075.00	\$ 200.00
4100	Reman Injection Pump CAV, Mfg # - 3233F641	AMP4100-DPA	\$ 1075.00	\$ 200.00
4110	Reman Injection Pump CAV, Mfg # - 3233F890	AMP4110-DPA	\$ 1075.00	\$ 200.00
4600, 4610, Ind: 550, 555	Reman Injection Pump CAV, Mfg # - 3233F651, F770	AMP4600-DPA	\$ 1075.00	\$ 200.00
4610	Reman Injection Pump CAV, Mfg # - 3238F060	AMP4600-DPAF060	\$ 1075.00	\$ 200.00
4610	Reman Injection Pump CAV, Mfg # - 3233F860	AMP4610-DPA	\$ 1075.00	\$ 200.00
5000, Ind: 5500	Reman Injection Pump CAV, Mfg # - 3249F771	AMP5000-DPA	\$ 1075.00	\$ 200.00
5000, Ind: 5500	Reman Injection Pump Simms, Mfg # - P4666/1	AMP46661	\$ 1725.00	\$ 200.00
5000, Ind: 5500	Reman Injection Pump Simms, Mfg # - P5024/8A	AMP5024	\$ 1725.00	\$ 300.00
5600	Reman Injection Pump CAV, Mfg # - 3249F921, F951	AMP5600-DPA	\$ 1097.00	\$ 200.00
5610	Reman Injection Pump CAV, Mfg # - 3242F771	AMP5610-DPA	\$ 1075.00	\$ 200.00
6000	Reman Injection Pump Simms, Mfg # - P4573/2A	AMP4573-2A	\$ 1875.00	\$ 300.00
6600, 6700	Reman Injection Pump CAV, Mfg # - 3249F951	AMP6600-DPA	\$ 1075.00	\$ 200.00
6600, 6700	Reman Injection Pump Simms, Mfg # - P4862/9B, P4862/9D, P5438/3A	AMP4862	\$ 1725.00	\$ 300.00
6610, 6710	Reman Injection Pump Simms, Mfg # - P5498/A, P5598/1D	AMP5498-A	\$ 1850.00	\$ 300.00
7000	Reman Injection Pump Simms, Mfg # - P5144/4, P5147/4	AMP5144-4	\$ 1725.00	\$ 300.00
7000	Reman Injection Pump Simms, Mfg # - P5147	AMP5147-4	\$ 1725.00	\$ 300.00
7600, 7700	Reman Injection Pump Simms, Mfg # - P5319/1A, P5319/5H, P5319/5J	AMP5319	\$ 1725.00	\$ 300.00

Ford® / New Holland®—Tractor

Application	Description	Part Number	Retail Price	Core
7610, 7710	Reman Injection Pump Simms, Mfg # - P5494A, P5597/1D	AMP5597	\$ 1850.00	\$ 300.00
8000, 8600 Early	Reman Injection Pump Simms, Mfg # - P4784/6	AMP4784-6	\$ 1875.00	\$ 300.00
8600, 8700	Reman Injection Pump Simms, Mfg # - P5376, P5376/2R	AMP5376-2R	\$ 1887.00	\$ 300.00
9000, 9600	Reman Injection Pump Simms, Mfg # - P4784/6A	AMP4784-6A	\$ 1913.00	\$ 300.00
9700	Reman Injection Pump Simms, Mfg # - P5376/H, P5376/2H	AMP5376-2H	\$ 1850.00	\$ 300.00
TW5, TW10	Reman Injection Pump Simms, Mfg # - P5419/A, P5579/1A	AMP5419	\$ 1850.00	\$ 300.00
TW15	Reman Injection Pump Simms, Mfg # - P5636	AMP5636	\$ 1850.00	\$ 300.00
TW20	Reman Injection Pump Simms, Mfg # - P5450, P5580/1	AMP5450	\$ 1887.00	\$ 300.00
TW25	Reman Injection Pump Simms, Mfg # - P5637	AMP5637	\$ 1850.00	\$ 300.00
TW30	Reman Injection Pump Simms, Mfg # - P5451, P5581/1	AMP5451	\$ 1850.00	\$ 300.00
TW30	Reman Injection Pump Simms, Mfg # - P5351	AMP5351-TW30	\$ 1850.00	\$ 300.00
TW35	Reman Injection Pump Simms, Mfg # - P5638	AMP5638	\$ 1850.00	\$ 300.00
TG255, TG285, TJ275, TJ325	CAPS Pump Replacement Kit Includes In-Line "P" 7100 Fuel Injection Pump HD, Fuel Injection Lines, Installation Components and Hardware	AMX36274	\$ 10700.00	

Injectors

Our remanufactured injectors are disassembled and thoroughly cleaned. The internal components are lapped to ensure there is no leakage. All tips are inspected for hole erosion and opening pressure; and the spray pattern is tested using OEM specifications.



Application	Description	Part Number	Retail Price	Core
231, 232, 234, 250C, 260C, 333, 334, 335, 340, 340A, 340B, 530A, 531, (2000, 3000 - w/ 3 Cylinder Engine), 2300, 2310, 2600, 2610, 2810, 2910, 3055, 3120, 3150, 3190, 3300, 3310, 3330, 3400, 3550, 4110, 4140, 4200, 4330, 4400, 4410, 4600, 4610, 5000, 5110, 5600, 5610, 5700, 5900, 6000, 6410, 6600, 6610, 6700, 6710, 6810, 7000, 7410, 7610, 7700, 7710, 7810, 7910, 8000, 8200, 8210, 8400, 8530, 8600, 8630, 8700, 8730, 8830, 9000, 9200, 9600, 9700, TW5, TW10, TW15, TW20, TW25, TW30, TW35, Ind/Const: 420, 445, 445A, 450, 455, 455C, 515, 535, 540, 540A, 540B, 545, 545A, 550, 555, 555A, 555B, 655, 655A, 755, 755A, 755B, 3500, 4500, 5550, 6500, 7500	Fuel Injector Washers and Seals Not Included Replaces C9NN9F593B	AMC5NE9F593A	\$ 73.00	
231, 233, 333, 335, 340, 450, 445, 450, 515, 532, 535, 540, 545, 2600, 3600, 3900, 4100, 4600, 5600, 5700, 6600, 6700, 7600, 7700, D175, D256	Injector	AMD4NN9F593A	\$ 79.00	
4130, 4630	Injector For 201 Diesel Engine	AME9NN9F593CA	\$ 156.18	
8000, 8600	Reman Injector Holder # - BKBL 80S 5204 Valve # - BDLL-150S6476	NBKBL80-6476	\$ 65.00	\$ 30.00
9000, 9600, 9700, TW20, TW30	Reman Injector Holder # - BKBL 80S 5389 Valve # - BDLL-150S6552	NBKBL80-6552	\$ 65.00	\$ 30.00
TW10	Reman Injector Holder # - BKBL 80S 5388 Valve # - BDLL-150S6764	NBKBL80-6764	\$ 65.00	\$ 35.00

Ford® / New Holland®—Tractor



Turbochargers

Application	Description	Part Number	Retail Price	Core
Boomer 4055, Boomer 4060, T2410, T2420, TC55DA	Turbocharger Replaces 87780726, SBA135756170, SBA135756171	AMSBA135756172	\$ 450.00	
4630, 4630N, 4630NO, 4630O, Ind/Const: 345C, 345D, 445C, 445D, 545C, 545D - All w/ Emissionized Engine	Turbocharger Replaces 465209-0004, 87801364	AM87801413	\$ 625.00	
6600, 6610, 6810, 7410, 7600, 7610, 7700, 7710, Ind/Const: A62, A64, A66, 750, 753, 755A, 755B, 6500, 7500, Swather: 1118	Turbocharger Replaces 83959416, E6NN6K682AA	AM466746-9003	\$ 388.00	
6610S, 7010, 7610S, 7740, TB100, TB110, TS100, TS110, Backhoe-Loaders: (575E, 675E ASN 31009910), LB90, (LB110, LB115 - 4WS), Swather: 2550 ASN 60631 - All w/ Emissioned Engine	Turbocharger T250 Replaces 87800859, 87800959	AM465153-5004	\$ 1150.00	
(7010 ASN 850001M, TB100, TB110 - w/ Non-Emissionized Engine), 7610S, 7740, TB85, Swather: 2550 BSN 606630	Turbocharger Replaces 83991489, F0NN6K682AA, F0NN6K682BA	AM83999247	\$ 690.00	
7700	Turbocharger 3LDA168, Schwitzer Replaces 182990R, 83910864, 87764591, D3NN6K682A	AM182990	\$ 811.00	
8630, 8730, TW15, TW20, TW25	Turbocharger Replaces E2NN6K682BC Reman Turbocharger TO4B09, AiResearch Replaces 81868484, E2NN6K682BC	AM81868484 AM465218-4	\$ 690.00 \$ 735.00	 \$ 200.00
8670, 8670A, 8770	Turbocharger Replaces 87840269, 87840269T	AM87840269	\$ 520.00	
8670, 8670A, 8770, 8770A, 8870, 8870A, 8970, 8970	Turbocharger Replaces 452173-0001	AM87800544	\$ 425.00	
8830, TW30, TW35	Reman Turbocharger TO4B09, AiResearch Replaces D8NN6K682FB	AM465218-2	\$ 710.00	\$ 200.00
8970, 8970A	Turbocharger Replaces 81876813, 81876980, F2NN6K682CA	AM87840271	\$ 425.00	
9000, 9200, 9600	Reman Turbocharger 3LD229, Schwitzer Replaces C9NN6K682B	AM150627R	\$ 709.00	\$ 200.00
9700	Reman Turbocharger Replaces D6NN6K382C, D8NN6K682DA	AM180316	\$ 885.00	\$ 200.00
T2410, T2420, TC55DA	Turbocharger Replaces 4T507, 87772751, 87780726, 135756172	AMSBA135756171	\$ 520.00	
TD70D, TD90D, TD95D, TN70, TN70A, TN70D, TN70NA, TN70S, TN70SA, TN70VA, TN75, TN75A, TN75D, TN75S, TN75SA, TN75V, TN75VA	Turbocharger Replaces 454163-5002S	AM99462782	\$ 425.00	
TR70, TR75	Reman Turbocharger H54375(3LD), Holset	AM54375	\$ 840.00	\$ 400.00
Combines: TR86, TR87, TR96, TR97	Reman Turbocharger TO4E14, Garrett Replaces E6NN6K682CA	AM466290-9	\$ 1225.00	\$ 200.00
Versatile®: 835, 875, 895	Turbocharger	AM167050	\$ 700.00	
Versatile®: 836, 846	Turbocharger	AM178022	\$ 800.00	
Versatile®: 850	Turbocharger	AM193903	\$ 1000.00	
Versatile®: 876	Turbocharger	AM168823	\$ 710.00	
Versatile®: 935, 950, 956	Turbocharger	AM196390	\$ 875.00	
Versatile®: 936, 945, 946, 955	Turbocharger	AM167713	\$ 715.00	

Ford® / New Holland®—Tractor

Application	Description	Part Number	Retail Price	Core
S215, SE190, SE215, SE240	Cooler, Air-to-Air Core Dimensions: 23 7/16" x 2 5/8" x 25 1/2" 3" Inlet and Outlet	AM437249A1	\$ 1270.00	
TM120, TM130, TM140, TM155	Cooler, Air-to-Air Core Dimensions: 17 7/8" x 2 3/4" x 14 3/4" 2 1/2" Inlet and Outlet	AM82028450	\$ 715.00	



Manifolds and Components

Application	Description	Part Number	Retail Price	Core
2N, 8N, 9N	Intake and Exhaust Manifold	AM9N9425	\$ 61.00	
	Manifold Gasket Set Replaces 9N9448	AMX36206	\$ 6.00	
600, 700, 800, 900, 2000, 4000, NAA - w/ 172 CID Gas Engine	Intake and Exhaust Manifold Replaces 500683	AMB9NN9425A	\$ 102.00	
	Manifold Gasket Set Replaces C0NN9448C	AMX36237	\$ 14.00	
2000, 2600, 3000, 3600, 4000, 4600 - w/ 3 Cylinder Gas or Diesel Engine w/ Horizontal Exhaust	Exhaust Manifold	AMC5NE9430A	\$ 36.00	
	Manifold Gasket Replaces E8NN9448AA	AMX36238	\$ 11.00	
(2000 Series 1965-74, 2100, 2110, 2120, 2300, 2310, 3000 Series 1965-74, 3055, 3100, 3120, 3190, 3300 Vineyard, 3400 Utility, 3500, 3550, 4000 Series 1965-74, 4100, 4110 LCG, 4140, 4190, 4200, 4330 Narrow Orchard, 4340 Orchard, 4400, 4500 - w/ 3 Cylinder Gas or Diesel Engine), (3310, 3330 - Narrow w/ 3 Cylinder Gas or Diesel Engine)	Exhaust Manifold	AMC5NE9430E	\$ 46.00	
	Manifold Gasket Replaces E8NN9448AA	AMX36238	\$ 11.00	
2310, 2600, 2610, 2810, 2910, 3600, 3610, 3910, 3930, 4110, 4600, 4610, 4630 - w/ 3 Cylinder Diesel Engine w/ Vertical Exhaust	Exhaust Manifold	AMD3NN9430A	\$ 38.00	
	Manifold Gasket Replaces E8NN9448AA	AMX36238	\$ 11.00	
5000, 5100, 5200, 5340, 5900, Ind: 5190, 5500, 6500 - All w/ 4 Cylinder Diesel Engine w/ Vertical Exhaust	Exhaust Manifold	AMC5NE9430D	\$ 46.00	
	Manifold Gasket Replaces C5NE9448B, E8NN9448BA, 83983680	AMX36239	\$ 11.00	
5600, 5610, 6600 - w/ 4 Cylinder Engine	Exhaust Manifold	AMD3NN9430B	\$ 65.00	
7000, 7100, 7200	Exhaust Manifold	AMD1NN9430A	\$ 279.00	
7910, 8210, 8700, 9700, TW10, TW20, TW30, TW35	Exhaust Manifold - Front Section	AMD8NN9430AB	\$ 155.00	
	Manifold Gasket Ref# E2NN5C250BA, C5NE9448A, E8NN9448AA	AMX36240	\$ 14.00	
	Exhaust Manifold - Rear Section	AMD5NN9431A	\$ 80.00	
8000, 8200, 8400, 8600, 9000, 9200, 9600	Exhaust Manifold - Front Section	AMC9NN9430B	\$ 120.00	
	Manifold Gasket Ref# E2NN5C250BA, C5NE9448A, E8NN9448AA	AMX36240	\$ 14.00	
	Exhaust Manifold - Rear Section Has 4-Bolt Pattern on Top Side of Manifold Replaces C7NN9428A, C9NN9431A	AMC9NN9431B	\$ 148.00	
T8010, T8020, T8030, T8040, T8050, T9010, T9020, TG215, TG245, TG275, TG305, TJ280, TJ330, Combines: (CR9040, CR9060 BSN Y8G112001)	Exhaust Manifold - Front Section	AM87344861	\$ 175.00	
T8010, T8020, T8030, T8040, T8050, T9010, T9020, TG215, TG245, TG275, TG285, TG305, TJ275, TJ280, TJ325, TJ330	Manifold Gasket	AM84368103AM	\$ 8.00	

Ford® / New Holland®—Tractor

Mufflers and Exhaust

Our mufflers are manufactured by experienced craftsmen here in the United States. All mufflers have welded seams. Aluminized steel is used for critical components. These features ensure that our products resist the corrosive effects of air, heat and the by-products of combustion that work to shorten muffler life. Additionally, they are painted either silver or black to cosmetically match its OEM counterpart, as well as provide further protection from the elements.

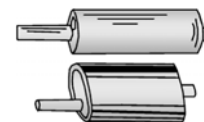

Application	Description	Part Number	Retail Price	Core
Universal Tractors	Exhaust Pipe Diameter 3.50", Length 48"	AMS312X48	\$ 73.50	
2N, 8N, 9N	Exhaust System - Horizontal Welded 1-Piece Muffler & Pipe Assembly w/ Flared Pipe Inlet Uses Clamp for Flared Inlet	AM8N5230	\$ 36.50	
230A, 231, 233, 250C, 260C, 333, 334, 335, 340, 340A, 340B, 345C, 345D, 420, 445A, 445C, 445D, 450, 455, 455D, 515, 530A, 531, 532, 535, 540, 540A, 540B, 545, 545A, 545C, 545D, 550, 555, 555A, 555B, 655, 655A, 2310, 2600, 2600N, 2610, 2610V, 2910, 3230, 3430, 3600, 3600N, 3600NO, 3600V, 3610, 3610NO, 3910, 3910H, 3910N, 3910R, 3910V, 3930, 3930H, 3930N, 3930NO, 4100, 4110, 4110N, 4110O, 4110NO, 4110V, 4130, 4130N, 4130NO, 4600, 4600O, 4600NO, 4600SU, 4610LCG, 4610N, 4610O, 4610NO, 4610SU, 4610V, 4630, 4630N, 4630NO, 4630O, 5110, 5600, 5610, 5700, 5900, 6410, 6600, 6600C, 6600O, 6700, 6710, 6810, 7610, 7610O - w/ 3 or 4 Cylinder Gas or Diesel Engine w/ Vertical Exhaust w/ 3-Bolt Flange	Exhaust Pipe Elbow Replaces D3NN5246G, D4NN5246E, D6NN5246U	AMD6NN5246N	\$ 77.00	
(501, 601, 701, 2000 - w/ 172 CID Gas or Diesel Engine), (801, 901, 1801, 4000 - w/ 3 Cylinder Diesel Engine), (3600, 4000, 4600 - w/ 144 CID Diesel Engine)	Muffler Round, Inlet 2", Length 17 1/2" Inlet Clamp Outlet Clamp	AM310079 CL-200 CL-200	\$ 32.00 \$ 4.80 \$ 4.80	
(600, 700 - w/ 134 CID Gas Engines 1955-57), (601, 701 - w/ 134 CID Gas Engines 1958-62), (800, 900 - w/ 172 CID Gas Engines 1955-57), (2000 Series 1963-64, NAA 1953-54 - w/ 134 CID Gas Engines)	Muffler Horizontal Round, Inlet 1 5/8", Length 17 1/2" Replaces NAA5230E Inlet Clamp Outlet Clamp	AMNAA5230E CL-158 CL-158	\$ 25.25 \$ 4.75 \$ 4.75	
2000 Series, (2100, 3100 - 1969-1975), 2110, 2600, 3000 Series, 3600, 4110, Ind: (31, 531 -1965-81) - All w/ 3 Cylinder Diesel	Muffler w/ Hanger Bracket Horizontal Oval, Inlet 1 3/4", Length 20 1/2" Inlet Clamp	AMC7NN5230G CL-134	\$ 43.00 \$ 4.75	
(2000, 3000 - 1969 and Later), 2100, 2110, 2600, 3100, 3600, 4110, Ind: (231, 531 -1965 and Later)	Horizontal Tailpipe Inlet Inside Diameter 2", Horizontal Length 47", Vertical Length 24", Outlet OD 1 3/4" Inlet Clamp	AMC7NN5245B CL-200	\$ 44.00 \$ 4.80	
2000, 2600, 2610, 3000, 3600, 3610, Ind/Const: 230A, 231, 335, 340, 420, 445, 540, 540A, 540B, 2110, 3400, 3500	Muffler Vertical Oval Body, Inlet 6", Length 49"	AME4NN5230FA	\$ 124.00	
2000, 3000, 4000, 4400, 5000, 5100 - w/ 3 or 4 Cylinder Gas or Diesel Engine, 1968 and Later	Muffler Vertical Round, Inlet 1 7/8", Length 29" Replaces C7NN5230AB, C7NN5230AC Inlet Clamp Rain Cap	AMC7NN5230Z CL-178 RC-2	\$ 38.00 \$ 4.75 \$ 16.80	
2000, 3000, 4000, 4200, 5000, 5100 Series - w/ 3 or 4 Cylinder Gas, LPG or Diesel Engine, 1975 and Later	Muffler Vertical Oval, Inlet 1 7/8", Length 39" Inlet Clamp Rain Cap	AMD5NN5230D CL-178 RC-2	\$ 93.50 \$ 4.75 \$ 16.80	
2000, 3000 Series - w/ 3 Cylinder Gas or Diesel Engine, 1964-69	Muffler w/ Hanger Bracket Horizontal Oval, Inlet 1 3/4", Length 29" Outlet Clamp	AMC5NN5230AH CL-134	\$ 60.00 \$ 4.75	
2910, (3910, 4110 - 1981-85), 4000, (4600, 4610 - 1965-82), (6600, 6700 - 1965-80), 5000, 5600, 5700	Muffler Vertical Oval, Inlet 1 7/8", Length 41"	AME4NN5230GB	\$ 92.50	

Ford® / New Holland®—Tractor

Application	Description	Part Number	Retail Price	Core
(5000 Series, 5600 Series, 6600 Series, 6700 Series, 7600 Series, 7700 Series - w/ 4 Cylinder Diesel 1965-75), Ind: (231, 232 - 1975-81 w/ 3 Cylinder Diesel), 4600 Series	Muffler Vertical Oval, Inlet 1 7/8", Length 49"	AMD6NN5230T	\$ 94.00	
	Inlet Clamp	CL-178	\$ 4.75	
	Rain Cap	RC-2	\$ 16.80	
5030, 5610, 6610, 6710, 7600, 7610, 7700, 7710	Muffler Vertical Oval, Inlet 2 1/2", 33 1/4"	AME5NN5230HA	\$ 75.00	
5110, 5610, 5900, 6410, 6610, 6710, 6810, 7610 - w/ Vertical Exhaust w/ 4-Bolt Rectangular Flange	Exhaust Pipe Elbow Replaces E0NN5246AA	AME0NN5246AA12B	\$ 126.00	
5110, 5610, 6610, 6710, 7000, 7100, 7200, 7600, 7610, 7700, 7710	Muffler Vertical Oval, Inlet 4", Length 38" Replaces 83908348, 83910404, 83919567, 83919568, 83932274, 83949814, 84362368, 87295250, 87704570, D5NN5230R, D9NN5230FA, D9NN5230GA, E4NN5230DA, E4NN5230DA17M	AMD5NN5230V	\$ 100.00	
5640, 6640, 7740, 7740O, TS90, TS100, TS110	Muffler Replaces 82010856	AM87704566	\$ 332.00	
7840, 8240, 8340	Muffler Replaces 82001308, 82003116, 82003737	AM82009296	\$ 245.00	
(8200, 8600 - 1968-76), (9200, 9600 - 1969-76) - All w/ 6 Cylinder Diesel Engines	Muffler Vertical Round, Inlet 2 7/8", Length 41"	AMC9NN5230C	\$ 84.50	
8360, 8560, TM125, TM135, TM150, TM165, TV140	Muffler Replaces 82008337, 82010811	AM87344289	\$ 325.00	
8700 1976-78, TW10 1979-82	Muffler Vertical Oval, Inlet 2 3/4", Length 44"	AMD5NN5230S	\$ 160.00	
	Inlet Clamp	CL-234	\$ 13.50	
	Rain Cap	RC-4	\$ 19.40	
9600, 9700, TW10, TW20	Muffler Vertical Oval, Inlet 3 1/2", Length 44 1/2"	AMD6NN5230AJ	\$ 207.00	
	Inlet Clamp	CL-312	\$ 7.43	
	Rain Cap	RC-8	\$ 21.30	
TD55D, TD60D, TD65D, TD70D, TD75D, TD80D, TD85D, TD90D, TD95D, TD5040, TD5050, TN55, TN55D, TN55S, TN55V, TN60A, TN60DA, TN60SA, TN60VA, TN65, TN65D, TN65F, TN65N, TN65S, TN65V, TN70, TN70A, TN70F, TN70NA, TN70VA, TN75, TN75A, TN75F, TN75FA, TN80F	Muffler Vertical Oval Body, Inlet 2", Length 14"	AM5172649	\$ 144.00	
TM120, TM130, TM140, TM155	Muffler, Underhood	AM82022922	\$ 167.00	
TW30	Muffler	AME4NN5230AA17M	\$ 210.00	
Versatile®: 256, 276	Muffler Vertical Oval, Inlet 3", Length 33 1/2"	AM9700143	\$ 179.00	
	Inlet Clamp	CL-212	\$ 5.21	
Versatile®: 750, 800, 825, 835, 850, 855, 875, 895	Muffler Vertical Oval, Inlet 5", Length 46"	AMV108431	\$ 595.00	
	Rain Cap	RC-11	\$ 30.75	
Versatile®: 836, 846, 856, 876	Muffler Inlet 4", Length 36 1/2"	AMV108093	\$ 875.00	
	Clamp	CL-400	\$ 7.85	
Versatile®: 936, 946, 956, 976	Muffler Inlet 5", Length 45 1/2"	AMV108094	\$ 785.00	
Versatile®: 9030E, 9030V	Muffler Vertical Oval, Inlet 3", Length 43"	AM9702857	\$ 148.00	
	Inlet Clamp	CL-234	\$ 13.50	

Ford® / New Holland®—Tractor

Starters

All of our remanufactured starters are disassembled, cleaned and inspected. Almost all units receive new field coils. If it meets OEM specifications the armature is test turned and under cut, otherwise it is replaced with a quality factory remanufactured or new part. Starters with factory solenoids have the solenoids replaced with new parts. The drive is carefully inspected and if it does not meet specifications it is replaced with new or quality factory remanufactured drives.



Application	Description	Part Number	Retail Price	Core
2N, 8N, 9N	Starter, 6 Volt Delco 10MT	AM8N11001	\$ 130.00	
501, 600, 601, 700, 701, 800, 801, 900, 901, 4000, NAA, Jubilee	Starter, 6 Volt 9 Tooth, CW Rotation Replaces C3NF11001A, FAC11000, FAC11001	AMFAC11001P	\$ 198.00	
600, 650, 660, 800, (2000, 4000 - w/ 4 Cylinder Engines, 1962-64), 2030, 2120, 2130, 4030, 4040, 4120, 4130, 4140	Starter w/ Drive Direct Drive, CW Rotation	AMC3NF11002D	\$ 170.00	
	Starter w/o Drive Direct Drive, CW Rotation	AMC3NF11002	\$ 138.00	
2000, 3000, 5000, 6600, 6610, 6700, 6710, 6810, 7000, 7100, 7200, 7410, 7500, 7600, 7610, 7700, 7710, 7810, 7910, 8000, 8200, 8210, 8530, 8600, 8630, 8700, 8730, 8830, 9000, 9030, 9600, 9700, TW5, TW10, TW15, TW20, TW25, TW30, TW35 - Diesel	Starter, 12 Volt Lucas M50G	AM26395	\$ 185.00	
3230, 3430, 3930, 4130, 4830, 5030, 5610S, 5640, 6810S, 7010, 7610S, 7630, 7740, 7810S, 7840, 8240, 8340, LB115, TM115, TM125, TM135, TM150, TM165, TS90, TS100	Starter, 12 Volt Lucas M50G, 10 Tooth, 3.20kW Replaces Bosch	AM86513093	\$ 225.00	
3430, 3930, 4130, 4630, 4830, 4835, 5030, 5610S, 5640, 6610S, 6640, 7010, 7610S, 7740, 7840, 8010, 8010HC, 8160, 8240, 8260, 8340, 8360, TB80, TB85, TB90, TB100, TB110, TB120, TM115, TM125, TM135, TM150, TM165, TS100, TS115, TS125, TV140, Swathers: HW300, HW320, HW340, HW345, HW365	Starter, 12 Volt Planetary Gear Reduction, 10 Tooth, 3kW, CW Rotation Note: Special Order Item	AM82021372	\$ 300.00	
8670, 8670A, 8770, 8770A, 8870, 8870A, 8970, 8970A - Diesel	Starter, 12 Volt HD Planetary Gear Reduction, 10 Tooth Steel Pinions, Steel Ring Gear, 4kW, CW Rotation For Diesel Engines Replaces 1113391, 1113672	AMX34112	\$ 325.00	
	Solenoid Use w/ AMX34112 Starter	AMX34113	\$ 63.00	
8670, 8770, 8870, 8970, TV140, TV145	Starter, 12 Volt Delco 37MT, 10 Tooth, Direct Drive, CW Rotation Replaces 9842667	AM1903109M91	\$ 399.00	
Fordson, Fordson Hi-Drive, Fordson Super Major	Starter, 12 Volt 11 Tooth, CW Rotation Replaces 81712422, E1ADDN11000D	AM26072	\$ 457.00	
T8010, T8020, T8030, T8040, T8050, T9020, TG215, TG245, TG275	Starter, 12 Volt Gear Reduction, 10 Tooth, 4.20kW Note: Special Order Item Replaces 84213446	AM87425232	\$ 383.00	
T6.120, T6.140, T6.150, T6.160, T6.175, T6020, T6030, T6040, T6050, T6060, T6070, T6080, T6090, T7.170, T7.185, T7.200, T7.210, T7.220, T7.230, T7.235, T7.240, T7.245, T7.250, T7.255, T7.260, T7.270, T7030, T7040, T7050, T7060, T7070, TC5070, TD5.105, TD5.95, TK4050, TM7010, TM7020, TM7030, TM7040, TS90, TS100, TS110, TS6.100, TS6.120, TS6.125, TS6.140, TS7020, TT60A	Starter Bosch, 10 Tooth, 4kW, CW Rotation Bosch Mfg # - 504357110 Iskra Mfg # - IS1109	AM84151331	\$ 305.00	
TD75D, TD80D, TD90D, TD95D, TL70, TL80, TL90, TL100, TN65F, TN70F, TN75F, TN75FA, TN80F, TN85FA, TN90F, TN95F, TN95FA, TN95NA, TN95VA, TT55, TT60A, TT65, TT75, TT75A	Starter, 12 Volt Replaces 82980757, 87538219, 500338952	AM5801441814	\$ 195.00	
Swathers: H8040, H8060, H8080, Speedrower Swathers: 130, 200, 240	Starter, 12 Volt Gear Reduction, 10 Tooth, 4.20kW Replaces 87054526	AM87577368	\$ 315.00	
Utility: 1320, 1520, 1530, 1620, 1630, 1710, 1715, 1720, 1725, 1925, T1510, T1520, T2210, TC25, TC25D, TC29, TC29D, TC29DA, TC30, TC31DA, TC33, TC33D, TC33DA	Starter, 12 Volt 9 Tooth	AMSBA185086551	\$ 107.00	

Ford® / New Holland®—Tractor

Application	Description	Part Number	Retail Price	Core
Utility: 1920, 2120 ASN UV32235, 3415, T1520, T2220, T2310, T2320, T2330, T2410, T2420, TC34DA, TC35, TC35A, TC35D, TC35DA, TC40, TC40A, TC40D, TC40DA, TC45, TC45A, TC45D, TC45DA, TC48DA, TC55DA, TT45A, TT50A	Starter, 12 Volt 11 Tooth	AMSBA185086530	\$ 140.00	
TR75, TR85, TR86, TR87, TR88, TR89, TR95, TR96, TR97, TR98, TR99, Swathers: 1100 ASN 425318, 1112 ASN 325611, 1114, 1116, 1118, 2450, 2550, HW300, HW305, HW305S, HW320, HW340	Ignition Switch Replaces 529713, 8641833, 80641833	AM641833	\$ 23.00	
Utility: 1000, 1100, 1110, 1200, 1210, 1300, 1310, 1500, 1510, 1600, 1700, 1710, 1900, 1910, 2110	Ignition Switch	AMSBA385200331	\$ 46.00	
2N, 8N BSN 263844, 9N	Resistor Replaces 501933	AM8NE10306	\$ 6.00	



Distributors

Application	Description	Part Number	Retail Price	Core
2N, 8N BSN 263844, 9N	Distributor, Front Mount	AM9N12100	\$ 160.00	
8N ASN 263843	Distributor, Side Mount	AM8N12127B	\$ 179.00	
600, 700, 800, 2000, 4000 - w/ 4 Cylinder Engines	Distributor	AMFDN12127A	\$ 159.00	
2000, 2100, 2110, 2120, 2150, 2300, 2310, 2600, 2610, 2810, 2910, 3000, 3055, 3100, 3110, 3120, 3150, 3330, 3400, 3500, 3600, 3610, 3910, 4000, 4100, 4110, 4140, 4200, 4330, 4340, 4400, 4500, 4600, 4600SU, 4610, 4610SU, Ind/Const: 230A, 234, 334, 335, 340, 340A, 340B, 420, 445, 450, 3550	Distributor For 3 Cylinder Engines Replaces 47821367, C7NF12127D, F0NN12100AA, F1NN12100AA, FDS3329	AM47573265	\$ 115.00	
Jubilee, NAA	Distributor w/ Slotted Shaft Replaces FAC12127D	AM86643560	\$ 115.00	

Air Cleaner Components

Application	Description	Part Number	Retail Price	Core
8N	Air Cleaner Assembly	AM8N9600B	\$ 98.50	
(600, 601, 700, 701, 800, 801, 900, 901, 2000, 4000, NAA - w/ 4 Cylinder Engine)	Air Funnel Air Cleaner Vent Tunnel	AMNAA9684A	\$ 34.50	
2000, 2100, 2110, 2120, 2300, 2310, 2600, 2610, 2810, 2910, 3000, 3055, 3100, 3120, 3190, 3230, 3300, 3310, 3330, 3400, 3430, 3600, 3610, 3900, 3910, 3930, 4000, 4110, 4130, 4140, 4190, 4200, 4330, 4340, 4400, 4410, 4600, 4610, 4630, 4830, 5000, 5030, 5200, 5340, 5600, 5610, 5700, 5900, 6000, 6410, 6600, 6610, 6700, 6710, 6810, 7410, 7600, 7610, 7700, 7710, Ind/Const: 230A, 231, 233, 234, 334, 335, 530A, 531, 532 Replaces CONN9A633A	Small Precleaner Bowl 7" Diameter	AMP02-0227	\$ 10.00	
2N, 8N, 9N, 600, 620, 630, 640, 650, 660, 700, 740, 800, 820, 840, 850, 860, 900, 950, 960, NAA, NAB	Air Cleaner Hose 1.50" ID, 1.875" OD, 2.562" Long	AM9N9652	\$ 4.00	
(500 Series, 600 Series, 700 Series, 800 Series, 900 Series, 2031, 2111, 2120, 2131, 4030, 4031, 4040, 4120, 4121, 4130, 4131 - w/ 134" Gas Engine), (501, 601 - w/ 4 Cylinder Engine, 1957-62), (541, 611 - w/ 4 Cylinder Engine, 1959-64), 620 w/ 4 Cylinder Engine, 1954-64, (621, 631, 641, 651 - w/ 4 Cylinder Engine, 1958-64), (2000, 4000 - Prior to 1964 w/ 134" Gas Engine), (4110TR, 4140 - w/ 4 Cylinder Engine, 1963-64), Ind: (1801, 1811, 1821, 1841, 1871, 1881, 2030, 2130 - w 134" Gas Engine)	Air Cleaner Hose 1.50" ID	AM311112	\$ 44.00	
(2000, 3000, 4000 - Diesel), 2100 03/1965-74 w/ 3 Cylinder Engine, (2110, 2300, 3055, 4100, 4110, 4190, 4200, 4330, 4340, 4410 - 1965-74 w/ 3 Cylinder Engine), Ind: 3500, 3550, 4500 1965-74 w/ 3 Cylinder Engine	Air Cleaner Hose, Lower 2" & 2.25" ID	AMC5NN9B640B	\$ 16.00	

Ford® / New Holland® —Tractor

Application	Description	Part Number	Retail Price	Core
2600, 2610, 2810, 2910, 3230, 3430, 3600, 3610, 3900, 3910, 3930, 4100, 4110, 4130, 4600, 4610, 4630, 4830, 5030, 5110, 5600, 5610, 5640, 5700, 5900, 6410, 6600, 6610, 6640, 6700, 6710, 6810, 7000, 7100, 7200, 7410, 7600, 7610, 7700, 7740, 7810, 7910, 8000, 8200, 8210, 8400, 8530, 8600, 8630, 8700, 9000, 9030E, 9030V, 9200, 9600, 9700, TS90, TW5, TW10, TW15, TW20, Ind/Const: 230A, 231, 233, 234, 333, 334, 335, 515, 530A, 531, 532 Replaces 594075	Large Precleaner Bowl 10.50" Diameter	AMP01-6330	\$ 12.00	
T6.125, T6.145, T6.155, T6.165, T6.175, T6.180, T7.165S, T7.175, T7.190, T7.210, T7.225, T7.230, T7.245, T7.260, T7.270, T8.320, T8.350, T8.380, T8.410, T8.435, T9.435, T9.480, T9.530, T9.565, T9.600, T9.645, T9.700	Sensor, Nox Replaces 47688088	AM84422747	\$ 420.00	



Alternators

Application	Description	Part Number	Retail Price	Core
2N, 8N w/ Front Mount Distributor, 9N	Alternator Conversion Kit Includes 12 Volt Alternator, Brackets, Coil, Wiring Harness and Resistor	AMX19007	\$ 183.00	
8N w/ Side Mount Distributor	Alternator Conversion Kit Includes 12 Volt Alternator, Brackets, Wiring Harness and Resistor	AMX34152	\$ 159.00	
501, 600, 700, 800, 900, (2000, 4000 - w/ 4 Cylinder Engine)	Alternator Conversion Kit Includes 12 Volt Alternator, Brackets, Wiring Harness and Resistor	AMX34153	\$ 168.00	
230A, 231, 233, 234, 333, 334, 335, 530A, 531, 2310, 2600, 2600N, 2600R, 2600V, 2610, 2810, 2910, 3600, 3600NO, 3600R, 3600V, 3610, 3610NO, 3900, 3910, 3910H, 3910N, 3910R, 4110, 4110N, 4600, 4600NO, 4600O, 4600SU, 4610, 4610O, 4610SU, 5600, 5700, 6600, 6600C, 6600O, 6700, 7600, 7700	Alternator w/ 6-Groove Pulley Lucas, Mfg # - 23814, 24211, 12 Volt, 43 Amps, IR/IF, CW Rotation Replaces D6NN10B376A	AM23814	\$ 175.00	
2310, 2600, 2610, 2810, 2910, 3600, 3610, 3900, 3910, 4100, 4110, 4600, 4610, 5600, 5610, 5900, 6600, 6610, 6700, 6710, 7600, 7610, 7700, 7710, 8600, 8700, 9600, 9700, Ind: 231, 233, 234, 250C, 260C, 333, 334, 335, 340, 345C, 420, 445, 445A, 445C, 450, 515, 530A, 531, 532, 535, 540, 545, 545A, 545C, 550, 555, 555A, 555B, 655A, 750, 755, 755A	Alternator 12 Volt, 51 Amps Replaces Motorola 8AL2055FA, 8AL2056K, 8AL2056KA	AMD5NN10300E	\$ 164.00	
2600, 2610, 2810, 2910, 3230, 3430, 3600, 3610, 3900, 3910, 3930, 4100, 4110, 4130, 4600, 4610, 4630, 4830, 5030, 5110, 5610, 5610S, 5640, 6610, 6640, 7610, 7710, 7740, 7810, 7840, 8240, 8340, Ind: 231, 233, 234, 250C, 260C, 333, 334, 335, 345C, 345D, 420, 445C, 445D, 455, 455C, 455D, 515, 531, 532, 535, 530A, 545C, 545D, 555C, 555D, 575D, 655C, 655D, 675D	Alternator Lucas, 12 Volt, 45 Amps, IR/EF, CW Rotation 1-Groove Pulley Replaces 81863039, 81868798, 83961474	AM82857207	\$ 120.00	
T6020, T6030, T6040, T6050, T6060, T6070, T6080, T6090, T5.95, T5.105, T5.115, T6.120, T6.140, T6.150, T6.160, T6.175, T7.170, T7.185, T7.200, TD5.85, TD5.95, TD5.105, TD5.115	Alternator 14 Volt, 120 Amps Note: Special Order Item Replaces 84141452	AM87361082	\$ 225.00	
T7030, T7040, T7050, T7060	Alternator w/o Pulley 12 Volt, 150 Amps, IR/IF, CW Rotation	AM87452821	\$ 220.00	
T8010, T8020, T8030, T8040, T8050, T9010, T9020, T9030, T9040, T9050, T9060, T9.450, T9.480, T9.505, T9.530, T9.560, T9.565, T9.615, T9.670, TG215, TG245, TG275, TG305, TJ280, TJ330, TJ380, TJ430, TJ480, TJ530	Alternator 12 Volt, 200 Amps, IR/IF	AM87715398	\$ 460.00	
T8010, T8020, T8030, T8040, T8050, TG215, TG245, TG275, TG305, Sprayers: Patriot 250, SP2500	Alternator 14 Volt, 175 Amps Note: Special Order Item Replaces 87645567	AM87418226	\$ 360.00	
(TG210, TG230, TG255, TG285 BSN JAW135316), TJ275, TJ325, TJ375, TJ425, TJ450, TJ500	Alternator w/o Pulley 12 Volt, 135 Amps, IR, CW Rotation Replaces 91448C1, 86994128	AM125849A1	\$ 225.00	

Ford® / New Holland®—Tractor

Application	Description	Part Number	Retail Price	Core
TL70, TL80, TL90, TL100 - w/ Cab	Alternator 14 Volt, 65 Amps Replaces 84402418, 84402419, 84522025	AM84402417	\$ 160.00	
TM120, TM130, TM140, TM155, TM175, TM190	Alternator 14 Volt, 120 Amps Note: Special Order Item Replaces 47744887	AM87361085	\$ 260.00	
Ind/Const: B95, B95LR, B95TC, B110, B115	Alternator 14 Volt, 60 Amps Replaces 84254289, 84416587, Denso 1022119090	AM87422777	\$ 161.00	
Utility: 1320, 1520, (1530, 1630, 1725, 1925, T2210, T2220, TC31DA, TC34DA - w/o Cab), 1620, 1715, 1720, 1920, 2120, 3415, T1510, T1520, T2310, T2320, T2330, TC25, TC25D, TC29, TC29D, TC29DA, TC30, TC33, TC33D, TC33DA, TC35, TC35A, TC35D, TC35DA, TC40, TC40A, TC40D, TC40DA, TC45, TC45A, TC45D, TC45DA, TT45A, TT50A	Alternator 12 Volt, 40 Amps	AMSBA185046320	\$ 146.00	
1100, 1120, 1200, 1210, 1220, 1300 Replaces SBA185516010	Voltage Regulator 12 Volt - 14.30 volt setting, B-circuit, Single multi-spade (6) connector w/ pins: I - N - F - E - L - B, +IG female bullet pigtail Solid State unit to replace original mechanical unit	AM70000-65398	\$ 58.00	

Sensors

Application	Description	Part Number	Retail Price	Core
T6020, T6030, T6040, T6050, T6060, T6070, T6080, T6090, T7030, T7040, T7050, T7060, (T9030, T9040 ASN Z6F200013), T9050 ASN Z7F204001, T7.165S, T7.175, T7.190, T7.210, T7.225, T7.230, T7.245, T7.260, T7.270, T7.315, TJ380, TJ430	Sensor, Oil Pressure and Temperature Replaces 4890193	AM504358206	\$ 80.00	
T6030, T6050, T6070, T6080, T6090, T7030, T7040, T7050, T7060, T7070, T6.125, T6.145, T6.155, T6.165, T6.175, T6.180, T7.165, T7.170, T7.175, T7.185, T7.190, T7.200, T7.210, T7.220, T7.225, T7.235, T7.250, T7.260	Sensor, Fuel Pressure Replaces 2859145, 504123163, 504222094	AM2854542	\$ 170.00	
T9030, T9040, T9050, TJ380, TJ430	Sensor, Clogged Fuel Filter Indicator	AM500346371	\$ 40.00	
T4.80F, T4.80V, T4.90, T4.90F, T4.90V, T4.100, T4.100F, T4.100V, T4.110, T4.110F, T4.110V, T4.120, T5.110, T5.120	Sensor, Exhaust Pressure	AM5801382522	\$ 104.00	
T4.90, T4.100, T4.110, T4.120, T5.110, T5.120, T6.125, T6.145, T6.155, T6.165, T6.175, T6.180, T7.165, T7.165S, T7.175, T7.190, T7.210, T7.225, T7.230, T7.245, T7.260, T7.270, T7.290, T7.315, T8.320, T8.350, T8.380, T8.410, T8.435, T9.390, T9.435, T9.450, T9.480, T9.505, T9.530, T9.560, T9.565, T9.600, T9.645, T9.670, TK4.100, TK4.100M, TS6.110, TS6.120, TS6.130, TS6.140	Temperature Sender, Exhaust Temperature Replaces 47367178, 87482353, LB52S00001P1	AM47478880	\$ 66.00	
T7.290, T7.315	Switch, Engine Exhaust Pressure Replaces 2859674, 4890193, 6901334	AM504358206	\$ 80.00	
T8.320, T8.350, T8.380, T8.410, T8.435	Sensor, Def/AdBlue Tank Level Replaces 47682727, 84161271, LB50P01001P1	AM47512674	\$ 260.00	



Tachometers and Instrument Clusters

Application	Description	Part Number	Retail Price	Core
500, 600, 700, 800, 900, 2000, 4000 Series, Jubilee, NAA - 1953-64 4 Cylinder with 4-Speed Transmission	Tachometer	AMC3NN17360N	\$ 44.50	
(600 Series, 800 Series, 900 Series, 2000 Series, 4000 Series - 1955-64 w/ 4 Cylinder Engine, w/ 5-Speed Transmission)	Tachometer	AMC3NN17360K	\$ 35.00	
2000, 3000, 4000, 5000, 7000 Series, 7100, 7200, Ind: 3500, 3550	Instrument Cluster For 3 and 4 Cylinder Tractors Equipped w/ Generators, CW Sweep	AMEHPN10849A	\$ 153.00	

Ford® / New Holland® —Tractor

Application	Description	Part Number	Retail Price	Core
2310, 2600, 2610, 2810, 2910, 3600, 3610, 3910, 4610, 5600, 5610 Prior to 1987, 6600, 6610 Prior to 10/1985, 7600, Ind: 231, 335, 340, 445, 531, 540	Instrument Cluster CCW Sweep Replaces E5NN10849BA, E7NN10849BA	AMD8NN10849TB	\$ 152.00	
2600, 2610, 3600, 3610, 4100, 4110, 4600, 4610, 5600, 5610, 6600, 6610, 7600, 7610	Instrument Cluster For 3 and 4 Cylinder Tractors Equipped w/ Alternators, CCW Sweep	AME5NN10849BA	\$ 147.00	
3830, 4030, 4230, 4330, 4430, 7530	Instrument Cluster Replaces 5125046, 5133783	AM5145186	\$ 239.00	
2600, 2610, 2810, 3230, 3430, 3600, 3610, 3930, 4100, 4110, 4130, 4600, 4610, 4630, 4830, 5030, 5110, 5600, 5610, 5700, 5900, 6500, 6600, 6610, 6700, 6710, 7600, 7610, 7700, 7710, Ind/Const: 230A, 231, 233, 234, 250C, 260C, 333, 335, 340, 345C, 345D, 420, 445, 445A, 445C, 445D, 450, 515, 530A, 531, 532, 535, 540, 545, 545D, 550, 555, 655, 750, 755	Tachometer Drive Assembly Replaces 87800006	AMD3NN17N264B	\$ 30.00	
2000, 2100, 2110, 2120, 2300, 2310, 2600, 2610, 2810, 2910, 3000, 3100, 3110, 3120, 3230, 3300, 3400, 3430, 3500, 3550, 3600, 3610, 3900, 3910, 3930, 4000, 4100, 4110, 4130, 4200, 4330, 4340, 4400, 4410, 4500, 4600SU, 4610, 4630, 4830, 5000, 5030, 5100, 5200, 5340, 5600, 5610, 5900, 6600, 6610, 6710, 7000, 7600, 7610, Fordson Major, Fordson Super Major, Ind/Const: 230A, 233, 234, 333, 334, 335, 340, 340A, 340B, 345C, 345D, 420, 445, 445A, 445D, 450, 515, 530A, 531, 532, 535, 540, 540A, 545, 545A, 545C, 545D, 750, 755A, 755B, 3500, 3550, 4140, 4400, 4500	Tachometer Cable Replaces C7NN17365B, D3NN17365C, D9NN17365AA, D9NN17365AB, E1ADDN17365C, E1NN17365BA, E9NN17365AA	AMD3NN17365F	\$ 12.00	
2000, 2100, 2110, 2120, 2300, 2310, 2600, 2610, 2810, 2910, 3000, 3100, 3110, 3120, 3230, 3300, 3400, 3430, 3500, 3550, 3600, 3610, 3900, 3910, 3930, 4000, 4100, 4110, 4130, 4200, 4330, 4340, 4400, 4410, 4500, 4600SU, 4610, 4630, 4830, 5000, 5030, 5100, 5200, 5340, 5600, 5610, 5900, 6600, 6610, 6710, 7000, 7600, 7610, Fordson Major, Fordson Super Major, Ind/Const: 230A, 233, 234, 333, 334, 335, 340, 340A, 340B, 345C, 345D, 420, 445, 445A, 445C, 445D, 450, 515, 530A, 531, 532, 535, 540, 540A, 540B, 545, 545A, 545C, 545D, 750, 755A, 755B, 3500, 3550, 4140, 4400, 4500	Tachometer Cable Replaces C7NN17365B, D3NN17365C, D3NN17365F, D9NN17365AA, D9NN17365AB, E1ADDN17365C, E1NN17365BA, E9NN17365AA	AM1970820C1	\$ 14.00	
2000, 2110, 2120, 2150, 2300, 2310, 3000, 3055, 3300, 3310, 3330, 3400, 3500, 3550, 4110, 4140, 4330, 4340, 4400, 4410, 4500, 5340	Tachometer Cable	AMC7NN17365A	\$ 11.00	
(2000, 2110, 2120, 4000, 4130 w/o Cab, 4140 - w/ 3 Cylinder Engine), 2100, 2300, 2310, 2600, 2610, 2810, 2910, 3000, 3055, 3100, 3110, 3120, (3230, 3430, 3930, 4630, 4830 - w/o Cab), 3300, 3310, 3330, 3400, 3500, 3550, 3600, 3610, 3900, 3910, 4100, 4110, 4200, 4330, 4340, 4400, 4410, 4500, 4600, 4610, 4610SU, 5000, 5030, 5100, 5110, 5200, 5340, 5600, 5610, 5900, 6410, 6600, 6610, 6810, 7000, 7100, 7200, 7600, 7610, Ind/Const: 30A, 231, 233, 234, 250C, 260C, 333, 334, 335, 340, 340A, 340B, 345C, 345D, 420, 445, 445A, 445C, 445D, 450, 515, 530A, 531, 532, 535, 540, 540A, 540B, 545, 545A, 545C, 545D, 750, 755, 755A, 755B	Tachometer Cable 47 7/16" Long Replaces 82847520, E1ADDN17365C, E9NN17365AA	AMD9NN17365AB	\$ 15.00	
(5110, 5610, 6410, 6610, 6810, 7610 - w/ Q-Cab and Mechanical Instrument Cluster), 5700, 6700, 6710, 7700, 7710	Tachometer Cable Replaces 83904959	AMD5NN17365D	\$ 20.00	







Mechanical Front Wheel Drive Parts

MFWD Hubs and Housings

Mechanical Front Wheel Drive Parts	Application	Description	Part Number	Retail Price	Core
		5600, 5700, 6600, 6700 - w/ APL1351 Front Axle	Front Axle Replaces ZP1927860	AMAL33349	\$ 200.00
	T8010, T8020, T8030, T8040, T8050, TG210, TG215, TG230, TG245, TG255, TG275, TG285, TG305	Front Axle Housing, Super Steer	AM87404286	\$ 6500.00	











Ford® / New Holland® —Tractor

Mechanical Front Wheel Drive Parts

Application	Description	Part Number	Retail Price	Core
 (T8010, T8020, T8030, T8040, T8050, T8.275*, T8.330*, T8.360*, T8.390*, TG210, TG215, TG230, TG245, TG255, TG275, TG285, TG305 - w/ 12-Bolt Hubs), (TG210, TG230 BSN MY00182861 w/ 10-Bolt Hubs) *Prior to 06/14/2013 w/o CVT w/ DANA® Axle w/ Differential Lock	Axle Housing For Suspended Axles w/ Differential Lock	AM87404290	\$ 4400.00	
 T8010, T8020, T8030, T8040, T8050, T8.275*, T8.330*, T8.360*, T8.390 w/o CVT, TG210**, TG215, TG230**, TG245, TG255, TG275, TG285, TG305 *w/o CVT w/ DANA® Axle or w/ CVT w/ DANA® Axle w/o Differential Lock **BSN MY00184591 w/o Differential Lock or All w/ Differential Lock	Axle Housing For Standard Axles w/ 12-Bolt Hubs w/ or w/o Differential Lock	AM87404249	\$ 3366.00	
 T8010, T8020, T8030, T8040, T8050, TG210, TG215, TG230, TG245, TG255, TG275, TG285, TG305	Axle Housing For Standard Axles w/ 10-Bolt Hubs w/ or w/o Differential Lock For Specialty Axles w/ 10-Bolt Hubs w/o Differential Lock	AM87404246	\$ 3750.00	
T8010, T8020, T8030, T8040, T8050, TG210, TG215, TG230, TG245, TG255, TG285	Axle Housing Suspended Axles w/ 10-Bolt Hubs w/ Differential Lock	AM87404289	\$ 5750.00	
5640, 6640, 7740, 7840, 8240, 8340, Ind/Const: 345C, 345D, 445C, 445D, 455C, 455D, 545C, 545D, 555C, 555D, 555E, 575E, 655, 655A, 655C, 655D, 655E, 675D, 675E	Upper Bearing, King Pin 1.378" ID, 2.047" OD, 0.65" Thick Replaces N14372	AM9967999	\$ 37.00	
 (T8010, T8020, T8030, T8040, T8050, TG210, TG215, TG230, TG245, TG255, TG275, TG285, TG305 - w/ DANA® Axle), (T8.275, T8.330, T8.360, T8.390 - w/ DANA® Axle w/o CVT)	Cradle For Suspended Axles	AM87406430	\$ 1530.00	
(T8010, T8020, T8030, T8040, T8050, TG210, TG215, TG230, TG245, (TG255, TG285 ASN MY00183034 10-Bolt Hubs or all 12-Bolt Hubs), TG275 - w/ Suspended Axles w/ 10-Bolt Hubs w/ Differential Lock or Suspended Axle w/ 12-Bolt Hubs), TG305, T8.275*, T8.330*, T8.360*, T8.390* - w/ Suspended Axles w/ 12-Bolt Hubs *Prior to 06/14/2013 without CVT w/ DANA® Axle w/ Differential Lock	Front Axle Pin	AM87406480	\$ 135.00	
T8010, T8020, T8030, T8040, T8050, T8.275, T8.330, T8.360, TG210, TG215, TG230, TG245, TG255, TG275, TG285, TG305 - w/ Suspended Axle	Suspension Cylinder Pin For Upper and Lower Ends of Cylinder	AM87406468	\$ 145.00	
(T8010, T8020, T8030, T8040, T8050, TG210, TG215, TG230, TG245, TG255, TG275, TG285, TG305 - w/ Suspended Axle), (T8.275, T8.330, T8.360 - w/ Suspended Axle w/ DANA® Axle)	Swing Arm Pin	AM87406453	\$ 250.00	
T8010, T8020, T8030, T8040, T8050, T8.275, T8.300, T8.330, T8.360, TG210, TG215, TG230, TG245, TG255, TG275, TG285, TG305	Pivot Pin For Suspended Suspension	AM87406467	\$ 300.00	
(T8010, T8020, T8030, T8040, T8050, TG210, TG215, TG230, TG245, TG255, TG275, TG285, TG305 - w/ Suspended Axles), (T8.275, T8.330, T8.360 - w/ Suspended Axles w/o CVT w/ DANA® Axle)	Pin, Upper Swing Arm Pin, Lower Swing Arm	AM87406452 AM87406451	\$ 200.00 \$ 265.00	
 T8010, T8020, T8030, T8040, T8050, (T8.275, T8.330, T8.360, T8.390 - w/ DANA® Axle), TG210, TG215, TG245, TG255, TG275, TG285, TG305	Suspension Cylinder, Right Hand Suspension Cylinder, Left Hand For Suspended Axles	AM87406484 AM87406483	\$ 2325.00 \$ 985.00	
 T8010, T8020, T8030, T8040, T8050, (T8.275, T8.330, T8.360 - w/ DANA® Axle), TG210, TG215, TG245, TG255, TG275, TG285, TG305	Lower Swing Arm For Suspended Axles	AM87406431	\$ 2050.00	

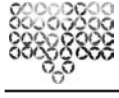

Ford® / New Holland® —Tractor

Mechanical Front Wheel Drive Parts



Application	Description	Part Number	Retail Price	Core
 8530, 8630, 8670, 8730, 8770, 8830, 8870, 8970 - w/ Standard Steer Axle	Hub Assembly w/ Knuckle, Right Hand	AMX4110102	\$ 4988.00	
	Hub Assembly w/ Knuckle, Left Hand	AMX4110103	\$ 4988.00	
 T8010, T8020, T8030, T8040, T8050, TG210, TG215, TG230, TG245, TG255, TG275, TG285, TG305	Hub Assembly w/ Knuckle, Right Hand Replaces 302174A1, 87404300	AMX41136	\$ 4750.00	
	Hub Assembly w/ Knuckle, Left Hand 12-Bolt For Super Steer Replaces 302174A1, 87404298	AMX41135	\$ 4750.00	
 8530, 8630, 8670, 8730, 8770, 8830, 8870, 8970	Hub Assembly	AMX411116	\$ 3675.00	
8670, 8770, 8870, 8970	Hub Assembly 10-Bolt Hub 4-Gear Assembly	AM86025945	\$ 4029.00	
 5600, 5700, 6600, 6700 - w/ APL1351 Front Axle	Steering Knuckle, Right Hand	AMZP4468358032	\$ 390.00	
	Steering Knuckle, Left Hand	AMZP4468358031	\$ 390.00	
 8670, 8770, 8870, 8970	Steering Knuckle, Right Hand	AM86015342	\$ 918.00	
	Steering Knuckle, Left Hand 1 1/4" Tie Rod Hole Diameter For Super Steer	AM86015341	\$ 650.00	
	Steering Knuckle, Right Hand	AM86015340	\$ 650.00	
	Steering Knuckle, Left Hand 10-Bolt, 1 1/8" Tie Rod Hole Diameter For Standard Steer	AM86015339	\$ 650.00	
 T4020, T4030, T4030F, T4030N, T4040, T4040F, T4040N, T4050, T4050F, T4050N, T4060F, T4060N, T4.75F, T4.80F, T4.85F, T4.90F, T4.95F, T4.100F, TN55S, TN60SA, TN70NA, TN70S, TN70SA, TN75DA, TN75FA, TN75SA, TN85FA, TN85SA, TN90F, TN95FA, TN95NA	Steering Knuckle, Right Hand	AM5184889	\$ 265.00	
	Steering Knuckle, Left Hand	AM5184894	\$ 265.00	
 T8010, T8020, T8030, T8040, T8050, TG210, TG215, TG230, TG245, TG255, TG285	Steering Knuckle, Right Hand	AM87404296	\$ 1400.00	
	Steering Knuckle, Left Hand For Super Steer	AM87404291	\$ 1450.00	
 T8010, T8020, T8030, T8040, T8050, TG210, TG215, TG230, TG245, TG255, TG285	Steering Knuckle, Right Hand	AM87404300	\$ 1495.00	
	Steering Knuckle, Left Hand 12-Bolt For Super Steer	AM87404298	\$ 1400.00	
 T8010, T8020, T8030, T8040, T8050, TG210, TG215, TG230, TG245, TG255, TG285	Shim Kit Replaces 1277247C1, B94587, B94585	AM1981236C1	\$ 20.00	
 T8010, T8020, T8040, T8050, TG210, TG230, TG245, TG255, TG275, TG285, TG305	Shim Kit	AM310960A1	\$ 100.00	
 5640, 6640, 6640O, 7740, 7740O, 7840, 7840O, 8240, 8340	Trunnion, Upper Replaces 1995414C1, B503049, CAR125149	AM81863173	\$ 105.00	
 5640, 6640, 6640O, 7740, 7740O, 7840, 7840O, 8240, 8340, Ind/Utility: 250C, 340B, 345C, 345D, 445, 445A, 445C, 445D, 450, 455, 455C, 455D, 540, 540B, 545, 545A, 545C, 545D	Trunnion, Lower Replaces 3475348M1, 83952503, 153326212	AMN13504	\$ 83.00	

Ford® / New Holland® —Tractor

Mechanical Front Wheel Drive Parts











Application	Description	Part Number	Retail Price	Core
 5600, 5700, 6600, 6700	Trunnion	AML35606	\$ 30.00	
 5610S, 6610S, 6810S, 7610S, TB80, TB85, TB90, TB100, TB110B, TB120, TS6000, TS6020, TS6030	Trunnion Replaces 122259A1, 3311329M91, 3311331M91, 3523550M1, 6190566M1, 47108554, 81863002, 82850292, 137700410855, CAR12881	AM9968025	\$ 144.56	
 (T8010, T8020, T8030, T8040, T8050, T8.275 w/o CVT, TG255, TG275, TG285, TG305 - w/ Standard Axle w/ 12-Bolt Hubs w/ and w/o Differential Lock), (T8010, T8020, T8030, T8040, T8050, TG210, TG215, TG230, TG245, TG255, TG275, TG285, TG305 - w/ Suspended Axle w/ 12-Bolt Hubs w/ Differential Lock), (T8010, T8020, T8030, T8040, T8050, TG210, TG215, TG230, TG245, TG255, TG275, TG285, TG305 - w/ SuperSteer™ Axle w/ 12-Bolt Hubs w/ and w/o Differential Lock), T8.275* w/ Suspended Axle w/ 12-Bolt Hubs w/ Differential Lock, (TG210, TG215, TG230 ASN MY00184591, TG245 - w/ Standard Axle w/ 12-Bolt Hubs w/ Differential Lock), (TG210 ASN MY00184591, TG230 - w/ Standard Axle w/ 12-Bolt Hubs w/o Differential Lock), (T8.275 w/o CVT w/ DANA® Axle w/ 12-Bolt Hubs w/o Differential Lock) *Prior to 06/14/13 w/o CVT	Shim Kit For Upper and Lower Trunnion Caps	AM313557A1	\$ 102.00	
T8010, T8020, T8030, T8040, T8050, T8.275, T8.300, T8.330, T8.360, TG210, TG215, TG230, TG245, TG255, TG275, TG285, TG305	Trunnion Bearing, Pivot Housing Replaces 070HC103	AM368728A1	\$ 173.00	
(T8010, T8020, T8030, T8040, T8050, TG210, TG215, TG230, TG245, TG255, TG275, TG285, TG305 - w/ Suspended Axles), (T8.275, T8.330, T8.360 - w/ Suspended Axles w/o CVT w/ DANA® Axle)	Plate	AM87406476	\$ 415.00	
(5640, 6640, 7740 - 10/1994 and Later), (7840, 8240, 8340 - 1995 and Later), 8160, 8260, TD75D, TD80D, TD90D, TD95D, TD5030 (Tier 3), TD5050, TL80, TL80A, TL90, TL90A, TL100, TL100A, TM115, TM120, TM125, TM130, TM135, TM140, TS90, TS100, TS100A, TS110, TS110A, TS115, TS115A, TS125A, TS130A, TS135A	Trunnion	AM5137239	\$ 75.00	

MFWD Hub Components

Application	Description	Part Number	Retail Price	Core
8670, 8770, 8870, 8910, 8920, 8970	Carrier Flange Assembly 3-Pin Hub 86017447, 87780417, B94587	AM86020261	\$ 1800.00	
 T8010, T8020, T8030, T8040, T8050, TG210, TG215, TG230, TG245, TG255, TG275, TG285	Carrier Flange Assembly 4-Pin Hub, 10-Bolt Flange Includes Flange, Gears, Needle Bearings and Thrust Washers	AM302251A2	\$ 1625.00	
8670, 8770, 8870, 8970	Flange Assembly 10-Bolt Hub Replaces 86002342, 86505121	AM86025944	\$ 820.00	
 T8010, T8020, T8030, T8040, T8050, TG210, TG215, TG230, TG245, TG255, TG285	Flange Assembly 10-Bolt Hub Replaces 295165A1, 87588833	AM302173A1	\$ 705.00	
T8010, T8020, T8030, T8040, T8050, TG210, TG215, TG230, TG245, TG255, TG285	Flange 10-Bolt Hub Bolts and Bearings Not Included	AM87588833	\$ 625.00	



Ford® / New Holland® —Tractor

Mechanical Front Wheel Drive Parts

Application	Description	Part Number	Retail Price	Core
 T8010, T8020, T8040, T8050, TG210, TG230, TG245, TG255, TG275, TG285, TG305	Planetary Gear Kit For 10-Bolt Hub	AM316330A2	\$ 650.00	
 T8010, T8020, T8040, T8050, TG210, TG230, TG245, TG255, TG275, TG285, TG305	Planetary Gear Kit For 12-Bolt Hub	AM316328A1	\$ 1060.00	
 3230, 3430, 3930, 4130, 4630, 4830, 5030	Planetary Pinion Carrier Replaces 81879351	AMRE45942	\$ 531.62	
 5610, 6610, 6710, 7610, 7710, 7910, 8210 - w/ APL325 Front Axle	Planetary Pinion Carrier	AME1NN1N045AA	\$ 1812.00	
(3600, 4100, 4600, 5600, 5700 - 1977 and Later), 6600, 6700	Planetary Pinion Gear 26 Tooth Replaces 3230261R1, L35588	AMZP1927562	\$ 172.00	
(5110, 5610, 6410, 6610, 7610 Prior to 02/1987)	Planetary Pinion Gear Replaces 83946053, 4472352014, ZP4472352014	AM81325C1	\$ 64.00	
 5610, 6610, 6710, 7610, 7710, 7910, 8210 - w/ APL325 Front Axle	Planetary Pinion Gear	AME1NN4044AB	\$ 200.00	
 (6710, 7610, 7710 - w/ APL345 Front Axle), (6710, 7710, 7910, 8210 - w/ APL350 Front Axle), (7910, 8210, TW5, TW12, TW25 - w/ APL355 Front Axle)	Planetary Pinion Gear	AMZP4472353463	\$ 180.00	
 5610, 6610, 6710, 7610, 7710, 7910, 8210 - w/ APL325 Front Axle	Planetary Pinion Shaft	AME1NN3A328AB	\$ 235.00	
 (6710, 7610, 7710, TW5, TW25 - w/ APL345 Front Axle), (6710, 7710, 7910, 8250 - w/ APL350 Front Axle)	Planetary Pinion Shaft	AMZP4472353158	\$ 180.00	
4WD: 5110, 5610, 6610, 7610 - Prior to 02/1987 w/ APL335 Front Axle	Planetary Pinion Shaft Replaces 83946032, 83949049, ZP4472352075	AM81320C1	\$ 64.00	
5110, 5610, 5610S, 5640, 6410, 6610, 6610O, 6610S, 6640, 6640O, 6710, 6810, 6810S, 7010, 7410, 7610, 7610O, 7610S, 7710, 7740, 7740O, 7810S, 7840, 7840O, 8010, TB80, TB85, TB90, TB100, TB110, TB120, TS6000, TS6020, TS6030, Ind/Utility: 250C, 260C, 345C, 345D, 445C, 445D, 455, 455C, 455D, 545C, 545D	Ring Gear Replaces 83952533, H437677, K395126	AM9968069	\$ 344.00	
 5610, 6610, 6710, 7610, 7710, 7910, 8210 - w/ APL325 Front Axle	Ring Gear	AME1NN1N043AA	\$ 575.00	
5610S, 5640, 6610S, 6640, 6640O, 6810, 6810S, 7610, 7610O, 7610S, 7710, 7740, 7740O, 7810, 7810O, 7840, 7840O, 7910, 8010 ASN 800001M, TB80, TB85, TB90, TB100, TB110, TB120, TS6000, TS6020, TS6030, Ind/Const: 345C, 345D, 445, 445A, 445C, 445D, 450, 545, 545A, 545C, 545D, 555C, 555D, 575D, 655C, 655D, 675D	Ring Gear Replaces 3475610M1, 83954696, 137700420856	AMN13513	\$ 97.00	
 8670, 8770, 8870, 8970	Ring Gear Replaces 86505064	AM1277250C1	\$ 555.00	
4WD: 5110, 5610, 6610, 7610 - Prior to 02/1987 w/ APL335 Front Axle	Ring Gear Replaces 83946031, 83954879, ZP4472352168	AM81319C1	\$ 366.00	

Ford® / New Holland® —Tractor

Mechanical Front Wheel Drive Parts





Application	Description	Part Number	Retail Price	Core
5640, 6640, 66400, 6810, 7010, 7610, 76100, 7710, 7740, 77400, 78100, 7810S, 7840, 8010, Ind: 250C, 260C, 345C, 345D, 445C, 445D, 455C, 455D, 545C, 545D, 555C, 555D, 555E, 575D, 575E, 655C, 655D, 655E, 675D, 675E	Inner Plate, Planetary Ring Gear Replaces 44079R1, 9968065, 83952534	AMH437678	\$ 135.00	
 8530, 8630, 8670, 8730, 8770, 8830, 8870, 8970	Sun Shaft Replaces 1961770C1, 86016137	AM250728A1	\$ 179.00	
 T8010, T8020, T8040, T8050, TG210, TG230, TG245, TG255, TG275, TG285, TG305	Sun Shaft	AM281982A3	\$ 330.00	
 (8670, 8770, 8870, 8970 - 09/1993 and Later), T8010, T8020, T8030, T8040, T8050, TG210, TG215, TG230, TG245, TG255, TG275, TG285, TG305, (T8.275*, T8.300**, T8.330***, T8.360**** - w/ DANA® MFWD Axle) *Prior to 06/14/2013 w/o CVT w/ Suspended Axle w/ Differential Lock and 12-Bolt Hubs or All w/o CVT w/ Standard Axle **Prior to 06/14/2013 w/o CVT and Suspended Axle w/o Differential Lock and 12-Bolt Hubs or All w/o CVT w/ Standard Axle, or All w/o CVT and DANA® Suspended Axle ***Prior to 06/14/2013 w/o CVT and Suspended Axle w/o Differential Lock and 12-Bolt Hubs, or All w/o CVT w/ Standard Axle, or All w/o CVT and Suspended Axle w/o Differential Lock and 12-Bolt Hubs, or All w/o CVT and Standard Axle w/o Differential Lock and 12-Bolt Hubs ****Prior to 06/14/2013 w/ CVT and Suspended Axle w/ Differential Lock and 12-Bolt Hubs, or All w/ CVT and Suspended Axle w/ Differential Lock and 12-Bolt Hubs, or All w/ CVT and Standard Axle w/ 12-Bolt Hubs, or All w/o CVT w/ Standard Axle	Oil Seal, Sunshaft 0.499" Wide, 1.563" ID, 2.129" OD Replaces 86508079, 87759992	AM128647A1	\$ 45.00	
T8010, T8020, T8030, T8040, T8050, (T8.275, T8.330, T8.360, T8.390 - w/o CVT), TG210, TG215, TG230, TG245, TG255, TG275, TG285, TG305 - All w/ 12-Bolt Hubs	Bearing Cup, Inner Planetary Hub 1.9375" Wide, 7.1875" OD	AML31698	\$ 77.00	

MFWD Differentials and Components

Application	Description	Part Number	Retail Price	Core
T8010, T8020, T8030, T8040, T8050, T8.275, T8.300, T8.330, T8.360, TG210, TG215, TG230, TG245, TG255, TG275, TG285, TG305	Differential Carrier Assembly, MFWD For Axles w/ 10-Bolt Hubs w/ Differential Lock Replaces 87404543	AM87324474	\$ 7000.00	
T8010, T8020, T8030, T8040, T8050, TG210, TG215, TG230, TG245, TG255, TG285	Differential Carrier Assembly, MFWD For Axles w/ 10-Bolt Hubs w/o Differential Lock Replaces 87404055	AM87324562	\$ 5350.00	
 T8010, T8020, T8030, T8040, T8050, TG210, TG215, TG230, TG245, TG255, TG275, TG285, TG305 - w/ 12-Bolt Hubs	Differential Carrier Assembly, MFWD For Axles w/o Differential Lock Replaces 87404092	AM87324564	\$ 7400.00	
8160, 8260, TM115, TM120, TM125, TM130, TM135, TM140, TS100A, TS110A, TS115A, TS125A, TS130A, TS135A	Ring Gear and Pinion Set 10 and 46 Tooth	AM5145486	\$ 890.00	
8670, 8770, 8870, 8970	Ring Gear and Pinion Set, MFWD Replaces 86002330	AM86017483	\$ 975.00	
T8010, T8020, T8030, T8040, T8050, T8.275, T8.300, T8.330, T8.360, TG210, TG215, TG230, TG245, TG255, TG275, TG285, TG305	Ring Gear and Pinion Set, MFWD 12-Bolt	AM87324538	\$ 1020.00	

Ford® / New Holland® —Tractor

Mechanical Front Wheel Drive Parts

Application	Description	Part Number	Retail Price	Core
 T8010, T8020, T8030, T8040, T8050, TG210, TG215, TG230, TG245, TG255, TG285	Ring Gear and Pinion Set, MFWD Replaces 84427940	AM1968293C1	\$ 320.00	
 TG210, TG230, TG255, TG285	Ring Gear and Pinion Set, MFWD 30 km/hr	AM321516A1	\$ 655.00	
8670, 8770, 8870, 8970	Axle Shaft Assembly, Right Hand Axle Shaft Assembly, Left Hand	AM86505032 AM86505031	\$ 920.00 \$ 1725.00	
 5600, 5700, 6600, 6700 - w/ APL1351 Front Axle	Axle Shaft, Long For 35.50" Axles Only	AMZP1927573	\$ 353.00	
T8010, T8020, T8030, T8050, TG210, TG215, TG230, TG245, TG255, TG275, TG285, TG305	Differential Clutch Disc and Gear Kit, MFWD Includes Bevel Gears, Pinion Gears, Cross Shaft, Clutch Discs, Clutch Plates and Thrust Washers For Axles w/o Differential Lock Replaces 377176A1, 87775804	AM377176A3	\$ 1350.00	
 T8010, T8020, T8030, T8040, T8050, TG210, TG230, TG245, TG255, TG275, TG285, TG305	Differential Carrier Assembly, MFWD For Axles w/ 10-Bolt or 12-Bolt Hubs w/o Differential Lock Replaces 345688A1, 345688A2	AM345688A4	\$ 1750.00	
(T8010, T8020, T8030, T8040, T8050 - w/ 10-Bolt or 12-Bolt Hubs), (T8.275, T8.330, T8.360 - Prior to 06/14/2013 w/ 12-Bolt Hubs w/ DANA® Axle w/o CVT), ((TG210, TG230, TG255, TG285 ASN MY00184591), TG215, TG245, TG275, TG305 - All w/ 12-Bolt Hubs), (TG210, TG230, TG255, TG285 ASN MY00195879), TG215, TG245 - All w/ 10-Bolt Hubs)	Differential Clutch Piston, MFWD For Axles w/ Differential Lock	AM87324486	\$ 220.00	
(T8010, T8020, T8030, T8040, T8050 - w/ 10-Bolt or 12-Bolt Hubs w/ Differential Lock), (TG210, TG215, TG230, TG245, TG255, TG275, TG285, TG305 - w/ 12-Bolt Hubs w/ Differential Lock), ((TG210, TG230, TG255, TG285 ASN MY00195879), TG215, TG245 - All w/ 10-Bolt Hubs w/ Differential Lock)	Differential Housing Assembly, MFWD w/ Bare Carrier Differential, Ring Gear and Pinion Not Included Replaces 87310140, 87404545	AM87324492	\$ 6000.00	
(T8010, T8020, T8030, T8040, T8050 - w/ 10-Bolt and 12-Bolt Hubs w/ Differential Lock), (T8.275, T8.330, T8.360 - Prior to 06/14/2013 w/ 12-Bolt Hubs w/ Differential Lock w/ DANA® Axle w/o CVT), ((TG210, TG230, TG255, TG285 ASN MY 00184591), TG275, TG305 - All w/ 12-Bolt Hubs w/ Differential Lock), (TG210, TG230, TG255, TG285 ASN MY 00195879 - w/ 10-Bolt Hubs w/ Differential Lock), (TG215, TG245 - w/ 10-Bolt and 12-Bolt Hubs w/ Differential Lock)	Differential Clutch Disc Kit, MFWD Includes (9) Clutch Discs and (10) Clutch Plates	AM87324488	\$ 515.00	
(T8010, T8020, T8030, T8040, T8050 - w/ 10-Bolt and 12-Bolt Hubs w/ Differential Lock), (T8.275, T8.330, T8.360 - Prior to 06/14/2013 w/ 12-Bolt Hubs w/ Differential Lock w/ DANA® Axle w/o CVT), (TG210, TG230, TG255, TG285 ASN MY00184591 - w/ 12-Bolt Hubs w/ Differential Lock), (TG210, TG230, TG255, TG285 ASN MY 00195879 - w/ 10-Bolt Hubs w/ Differential Lock), (TG215, TG245 - w/ 10-Bolt and 12-Bolt Hubs w/ Differential Lock), (TG275, TG305 - w/ 12-Bolt Hubs w/ Differential Lock)	Differential Gear Kit, MFWD Includes Bevel Gears, Pinion Gears, Cross Shaft, Thrust Washers	AM87324491	\$ 1335.00	
T8010, T8020, T8030, T8040, T8050, (TG210, TG230, TG255, TG285 ASN MY00184591), TG215, TG245, TG275, TG305 - All w/ 12-Bolt Hubs	Differential Carrier Bearing Cone, MFWD Differential Carrier Yoke, MFWD	AM87324516 AM87324528	\$ 365.00 \$ 310.00	
(TG210, TG230 BSN MY00164725 w/ 10-Bolt Hubs), (TG210, TG230, TG255, TG285 BSN MY00182905 w/ 12-Bolt Hubs)	Differential Clutch Driver, MFWD For Axles w/ Differential Lock	AM87404485	\$ 360.00	

Ford® / New Holland® —Tractor





Mechanical Front Wheel Drive Parts

Application	Description	Part Number	Retail Price	Core
(TG210, TG230 BSN MY00164725 w/ 10-Bolt Hubs), (TG210, TG230, TG255, TG285 BSN MY00182905 w/ 12-Bolt Hubs)	Differential Clutch Disc Kit, MFWD Includes (13) Clutch Discs and (14) Clutch Plates For Axles w/ Differential Lock	AM87405209	\$ 725.00	
T8010, T8020, T8030, T8040, T8050, (TG210, TG230, TG255, TG285 ASN MY00184591), TG215, TG245, TG275, TG305 - All w/ 12-Bolt Hubs w/ Differential Lock	Differential Carrier, MFWD Bare Carrier Ring Gear and Pinion Not Included	AM87324513	\$ 1900.00	
((T8010, T8020, T8030, T8040, T8050, (T8.275, T8.330 - Prior to 06/14/2013 w/o CVT w/ DANA® Axle), T8.360, TG210, TG215, TG230, TG245, TG255, TG275, TG285, TG305 - w/ 12-Bolt Hubs w/ Differential Lock), (T8010, T8020, T8030, T8040, T8050, TG210, TG215, TG230, TG245, TG255*, TG285* - w/ 10-Bolt Hubs w/ Differential Lock) *ASN MY00195879 w/ Standard Axle, ASN MY00183034 w/ Suspended Axle or ASN MY00193740 w/ SuperSteer™ Axle	Seal Retainer	AM87404997	\$ 350.00	
(T8010, T8020, T8030, T8040, T8050, T8.275*, T8.330*, T8.360*, TG210, TG215, TG230, TG245, TG255, TG275, TG285, TG305 - w/ 12-Bolt Hubs w/ Differential Lock), (T8010, T8020, T8030, T8040, T8050, TG210, TG215, TG230, TG245, TG255 ASN MY0019587, TG285 ASN MY00195879 - w/ Standard Axle w/ 10-Bolt Hubs w/ Differential Lock), (TG255 ASN MY00183034, TG285 ASN MY00184588 - w/ Suspended Axle w/ 10-Bolt Hubs w/ Differential Lock) *Prior to 06/14/2013 w/out CVT w/ DANA® Axle	Seal	AM87404471	\$ 85.00	
Ford®/New Holland® Tractors: (T8010, T8020, T8030, T8040, T8050, (TG210, TG230, TG255, TG285 ASN MY00184591), TG275, TG305 - w/ Standard Axle w/ 12-Bolt Hubs w/ and w/o Differential Lock), (T8010, T8020, T8030, T8040, T8050, TG215, TG245, TG275, TG305 - w/ Suspended Axle w/ 12-Bolt Hubs w/ and w/o Differential Lock or w/ SuperSteer™ Axle w/ 12-Bolt Hubs w/ and w/o Differential Lock), (T8.275**, T8.330**, T8.360** - w/ Standard Axle w/ 12-Bolt Hubs w/ Differential Lock), (TG210***, TG230***, TG255***, TG285*** - w/ Suspended Axle w/ 12-Bolt Hubs w/ and w/o Differential Lock), (TG210****, TG230****, TG255****, TG285**** - w/ SuperSteer™ Axle w/ 12-Bolt Hubs w/ and w/o Differential Lock), (TG215, TG245 - w/ Standard Axle w/ 12-Bolt Hubs w/ Differential Lock) **Prior to 06/14/2013 w/o CVT w/ DANA® Axle ***ASN MY00184588 w/ Differential Lock or ASN MY00195684 w/o Differential Lock ****ASN MY00195701 w/ Differential Lock or ASN MY00190632 w/o Differential Lock	Shim Kit, Differential Pinion Shaft	AM87324518	\$ 200.00	

Ford® / New Holland® —Tractor





Application	Description	Part Number	Retail Price	Core
(T8010, T8020, T8030, T8040, T8050, (TG210, TG230, TG255, TG285 ASN MY00184591), TG275, TG305 - w/ Standard Axle w/ 12-Bolt Hubs w/ and w/o Differential Lock), (T8010, T8020, T8030, T8040, T8050, TG210**, TG215, TG230**, TG245, TG255**, TG275, TG285**, TG305 - w/ Suspended Axle w/ 12-Bolt Hubs w/ and w/o Differential Lock), (T8010, T8020, T8030, T8040, T8050, TG210***, TG215, TG230***, TG245, TG255***, TG275, TG285***, TG305 - w/ SuperSteer™ Axle w/ 12-Bolt Hubs w/ and w/o Differential Lock), (T8.275*, T8.330*, T8.360*, TG215, TG245 - w/ Standard Axle w/ 12-Bolt Hubs w/ Differential Lock) *Prior to 06/14/2013 w/o CVT w/ DANA® Axle **ASN MY00184588 w/ Differential Lock or ASN MY00195684 w/o Differential Lock ***ASN MY00195701 w/ Differential Lock or ASN MY00190632 w/o Differential Lock	Shim Kit, Differential Carrier Yoke	AM87324536	\$ 180.00	
(T8010, T8020, T8030, T8040, T8050, TG210, TG215, TG230, TG245 - w/ 10-Bolt or 12-Bolt Hubs), (TG255, TG285 - w/ 10-Bolt Hubs w/o Differential Lock or ASN MY00195879 w/ Differential Lock), (T8.275*, T8.330, T8.360*, TG255, TG275, TG305 - w/ 12-Bolt Hubs) *Prior to 06/14/2013 w/o CVT w/ DANA® Axle w/ Differential Lock	Adjusting Ring, MFWD Differential Bearing	AM1277233C1	\$ 180.00	
(T8010, T8020, T8030, T8040, T8050, TG210, TG215, TG230, TG245 - w/ 10-Bolt or 12-Bolt Hubs w/ Differential Lock), (T8.275*, T8.330*, T8.360*, TG275, TG305 - w/ 12-Bolt Hubs w/ Differential Lock), (TG255**, TG285** - w/ 10-Bolt Hubs w/ Differential Lock) *Prior to 06/14/2013 w/o CVT w/ DANA® Axle **ASN MY00195879 w/ Standard Axle, ASN MY0183034 w/ Suspended Axle, ASN MY0193740 w/ SuperSteer™	Nipple Coupling, MFWD	AM87404480	\$ 95.00	

MFWD Driveshafts







Application	Description	Part Number	Retail Price	Core
 (TG210, TG230*** - w/ Standard, Suspended or Super Steer Axle w/ 10-Bolt Hubs), (TG210, TG230, TG255, TG285**** - w/ Standard, Suspended or Super Steer Axle w/ 12-Bolt Hubs) ***BSN MY00164725 w/ Standard Axle, BSN MY00182861 w/ Suspended Axle or BSN MY00184573 w/ Super Steer Axle ****BSN MY00182905 w/ Standard Axle, BSN MY00178966 w/ Suspended Axle or BSN MY00164720 w/ Super Steer Axle	Drive Shaft Assembly, Right Hand For Axles w/ Differential Lock	AM87404999	\$ 700.00	
	Drive Shaft Assembly, Left Hand For Axles w/ Differential Lock	AM87405000	\$ 675.00	
 T9020, TJ275, TJ280, TJ325, TJ330 - w/ Powershift Transmission	Drive Shaft Engine to Transmission Driveline	AM402177A1	\$ 1845.00	
 T8010, T8020, T8030, T8040, T8050, T8.275, T8.300, T8.330, T8.360, TG210, TG215, TG230, TG245, TG255, TG275, TG285, TG305	Axle Shaft Assembly, Right Hand w/ Differential Lock	AM87324476	\$ 910.00	
 T8010, T8020, T8040, T8050, TG210, TG230, TG245, TG255, TG275, TG285, TG305	Inner Yoke, Right Hand w/ Differential Lock	AM87325892	\$ 815.00	
	Inner Yoke, Left Hand w/ Differential Lock	AM87307641	\$ 875.00	

Ford® / New Holland® —Tractor











Mechanical Front Wheel Drive Parts

	Application	Description	Part Number	Retail Price	Core
	T8010, T8020, T8040, T8050, TG210, TG230, TG245, TG255, TG275, TG285, TG305	Inner Yoke, Right Hand w/o Differential Lock	AM395741A1	\$ 715.00	
		Inner Yoke, Left Hand w/o Differential Lock	AM395743A1	\$ 800.00	
	T8010, T8020, T8040, T8050, TG210, TG230, TG245, TG255, TG275, TG285, TG305	Outer Yoke	AM395737A1	\$ 300.00	
	T8010, T8020, T8040, T8050, TG210, TG230, TG245, TG255, TG275, TG285, TG305	Center Yoke	AM395740A1	\$ 245.00	
	T7030, T7040, T7050, T7060, T7070, T6.120, T6.125, (T6.140, T6.150, T6.160 - Electro Command), T6.145, T6.155, T6.165, T6.175, T6.180, T7.220, T7.230, T7.235, T7.245, T7.250, T7.260, T7.270, T7.290, T7.315, TM175, TM190	Friction Disc, MFWD Engagement Clutch	AM5163844	\$ 11.00	
	T8010, T8020, T8030, T8040, T8050, T8.275, T8.300, T8.330, T8.360, TG210, TG215, TG230, TG245, TG255, TG275, TG285, TG305	Seal	AM302957A1	\$ 24.00	













Tie Rods and Components

	Application	Description	Part Number	Retail Price	Core
	2N, 9N	Tie Rod 3.187" Long, 0.687" Diameter 18 Right Hand Thread	AM9N3270	\$ 10.00	
	2N, 8N, 9N, 600, 800, 2000, 4000 Series, NAA - w/ 4 Cylinder Engines	Tie Rod, Rear Drag Link End 4.25" Long, 0.687" Diameter 18 Right Hand Thread	AMNAA33271A	\$ 13.00	
	(2N, 8N, 9N, 600 Series, 700 Series, 800 Series, 900 Series, 2000 Series, 4000 Series, NAA - w/ 4 Cylinder Engines Prior to 1964), (2000 Series, 3000 Series, 4000 Series - w/ 3 Cylinder Engines 1965-74), (2310, 2600, 2610, 2810, 2910, 3600, 3610, 3910, 4600SU, 4610SU - w/ 3 Cylinder Engines)	Radius Rod Ball Cap	AME0NN3N406BA	\$ 10.00	
	(2N, 8N, 9N, 600 Series, 700 Series, 800 Series, 900 Series, 2000 Series, 4000 Series, NAA - w/ 4 Cylinder Engine, Prior to 1964), (2000 Series, 3000 Series, 4000 Series - w/ 3 Cylinder Engines, 1965-75), (2310, 2600, 2610, 2810, 2910, 3600, 3610, 3910, 4600SU, 4610SU - w/ 3 Cylinder Engine)	Radius Rod Ball Socket	AME0NN3N442BA	\$ 18.40	
	8N	Tie Rod, Front Drag Link End 3.375" Long, 0.687" Diameter 18 Left Hand Thread	AM8N3270	\$ 11.00	
	8N	Tie Rod Tube 32.75" Long, 0.875" OD	AM8N3314D	\$ 63.00	
	230A, 231, 234, 334, 335, 530A, 531, 532, 2000, 2100, 2110, 2120, 2150, 2310, 2600, 2600N, 2600R, 2600V, 2610, 2810, 2910, 3000, 3055, 3100, 3150, 3330, 3600, 3600N, 3600NO, 3600R, 3600V, 3610, 3610NO, 3610V, 3900, 3910, 3910H, 3910N, 3910R, 3910V, 4000, 4100, 4110, 4110N, 4110NO, 4110O, 4140, 4330, 4340, 4600, 4600SU, 4610, 4610NO, 4610SU, 4610V	Tie Rod, Rear Drag Link End, Left Hand 28.125" Long Replaces 81802895	AMC5NN3308E	\$ 134.00	

Ford® / New Holland®—Tractor













	Application	Description	Part Number	Retail Price	Core
	234, 334, 335, 2000, 2310, 2600, 2610, 2810, 2910, 3000, 3600, 3610, 3900, 3910, 4000, 4100, 4110, 4140, 4330, 4340, 4600SU, 4610, Ind: 530A - w/ Power Steering	Tie Rod 3.312" Long, 0.75" Diameter 16 Left Hand Thread	AMC5NN3A300B	\$ 15.00	
	250C, 260C, 345C, 345D, 445A, 445C, 445D, 450, 455, 455C, 455D, 545, 545A, 545C, 545D, 550, 555, 555A, 555B, 555C, 555D, 575D, 655 - w/ MFWD	Inner Tie Rod, Right Hand M24x1.50 mm Thread Replaces 8390617	AMCAR87031	\$ 73.25	
	600, 800, 2000, 4000 Series, NAA - w/ 4 Cylinder Engines	Tie Rod, Front Drag Link End 3.875" Long, 0.687" Diameter 18 Left Hand Thread	AMNAA3270A	\$ 11.00	
	2000 w/ 3 Cylinder Engine w/ Power Steering, 2100, (2120, 4140 - w/ 3 Cylinder Engine), (2600, 2610, 3600, 3610, 3910, 4100 - w/o Cab w/ Power Steering), 2810, 2910, 3000, 3330, 3900, 4000, 4110, 4330, 4340, 4600, Ind: 230A, 231, 234, 334, 335, 531	Rear Drag Link End, Right Hand 29.625" from Grease Zerk to End of Shaft	AMC5NN3307G	\$ 124.00	
	2000, 2600, 2610, 2910, 3000, 3600, 3610, 3910, 4000, 4100, 4110, 4600SU, 4610SU, Super Dexta - w/ Manual Steering	Tie Rod, Front Drag Link End 4" Long, 0.687" Diameter 18 Left Hand Thread	AM957E3290B	\$ 11.00	
	2000, 2600, 2610, 2910, 3000, 3600, 3610, 3910, 4000, 4100, 4110, 4600SU, 4610SU, Super Dexta - w/ Manual Steering	Tie Rod, Rear Drag Link End 4.50" Long, 0.687" Diameter 18 Right Hand Thread	AM957E3307B	\$ 12.00	
	(3000, 3400, 3600, 4000, 4100, 4410, 4600 - European), Ind: 335, 532	Tie Rod 4" Long 13/16"-16 Left Hand Thread	AMC5NN3A300C	\$ 36.00	
	(3010S, 4010S, 5010S ASN 702415M), 5610S ASN 310660M, 6610S ASN 362005M, 7610S ASN 258571M, TB80, TB85, TB90, TB100M, TB110, TB120, TT55, TT65, TT75	Outer Tie Rod End, Right Hand 30" Long, 1" Diameter	AM82981599	\$ 120.00	
	(3010S, 4010S, 5010S ASN 400001M), TD60D, TD70D, TT55, TT60A, TT65, TT75, TT75A	Tie Rod Assembly 49.88" Long	AM5135076	\$ 200.00	
	(3010S, 4010S, 5010S ASN 400001M), TT55, (TT60A, TT75A - w/ MFWD), TT65, TT75	Tie Rod 51.94" Long 1 1/8" Internal Threads	AM5135075	\$ 200.00	
	3230, 3430, 3930, 4130, 4630, 4830, 5030 - w/ 4WD Carraro™ Axle	Tie Rod End 6.625" Long M18x1.50" Left Hand Internal Thread Replaces 1537611C1, 81875596, 81878537	AMVPJ3210	\$ 130.00	
	3230, 3430, 3930, 4130, 4630, 4830, 5030	Tie Rod 7 Holes in Side 0.935" ID, 17.812" Long Replaces 83983704	AME7NN3278AA	\$ 97.00	
	3230, 3430, 3930, 4130, 4630, 4830, 5030, 5610, 5610S, 6610, 6610S, 6810, 6810S, 7010, 7610, 7610S, 7810, 7910, 8010	Ball Joint, Left Hand 7.04" Long M20x1.50" Right Hand Thread M18x1.50" Left Hand Thread Replaces 48084983, 83957148, 87714488	AMCAR49006	\$ 61.00	
	3430, 3930, 4000, 4100, 4330, 4340, 4600, 4610, 4630, 4830, 5030	Tie Rod, Front Drag Link End 9" Long, 0.865" Diameter, Notched Replaces C5NN3A300A	AMD0NN3A300A	\$ 19.00	
	3430 w/ Manual Steering, 4000, 4130, 4600, 4610	Outer Tie Rod, Right Hand 3.75" Long, 0.75" Diameter 16 Internal Thread	AMC5NN3289C	\$ 18.00	

Ford® / New Holland®—Tractor







	Application	Description	Part Number	Retail Price	Core
	3600, 4100, 4600, 5610, 5700, 6610, 6700, 6710, 7410, 7610, 7700, 7710, 7810, 7810O, 7910, 8000, 8210, 8530, 8630, 8700, 8730, 8830, 9000, 9700, TW5, TW10, TW15, TW20, TW25, TW30, TW35, Utility: 532	Tie Rod, Short 8.625" Long, 1" Diameter, 16 Right Hand Thread Replaces 83906918, 83929289, D5NN3289A	AME1NN3289AA	\$ 32.00	
	4000, 4600, 4610	Outer Tie Rod, Left Hand 19" Long, 0.75" Diameter	AMC5NN3278A	\$ 23.00	
	5000, 5100, 5340, 7000, 7100 - w/ Manual Steering	Drag Link End 5.031" Long, 1" Diameter 16 Right Hand Thread	AMC5NN3307E	\$ 25.00	
	(5000, 5340, 5600, 5610, 6600, 6610, 7000, 7100 - 1965-05/31/67 w/ Manual Steering)	Outer Tie Rod, Left Hand 0.94" Diameter, 17.50" Long 7 Notches	AMC5NN3281C	\$ 45.00	
	5000, 5100, 5600, 5900, 6600, 6610, 7000, 7100, 7600, 7610 - w/ Power Steering	Outer Tie Rod, Right Hand 15.375" Long, 0.937" Diameter, 7 Notches	AMC7NN3280E	\$ 27.00	
		Outer Tie Rod, Left Hand 15.375" Long, 0.937" Diameter, 7 Notches	AMC7NN3281A	\$ 26.00	
	5000, 5100, (5600, 6600 - Hi-Clearance), 5610, 5900, 6610, 6700, 7000, 7100, 7600, 7700, 7710	Inner Tie Rod, Right Hand 3.75" Long, 1" Diameter 16 Thread	AMC7NN3289D	\$ 18.00	
	5000, 5100, 5600, 5610, 5900, 6600, 6610, 7000, 7100, 7600, 7610	Drag Link Assembly 50.50" Long	AME0NN3304CA	\$ 95.00	
	5000, 5600, 5610, 6600, 6610, 7000 - 1965-06/67 w/ Manual Steering	Outer Tie Rod, Right Hand 17.50" Long, 0.94" Diameter	AMC5NN3280F	\$ 35.00	
	5100, 5600, (5600, 6600, 7600 - Hi-Clearance), 5610, 5900, 6600, 6610, 7100, 7600, 7610 - w/ Power Steering	Tie Rod, Left Hand 18.125" Long	AMC7NN3B161A	\$ 23.60	
	5110, 5610, 5910, 6610, 6710, 6810, 7410, 7610, 7710	Ball Joint 7.54" Overall Length M20x1.50" Right Hand External Thread M22x1.50" Right Hand External Thread Replaces 1968463C1, 1968468C1, 83957098	AMZP0501310060	\$ 52.25	
	5110, 5610, 6410, 6610, 6610O, 6710, 6810, 7410, 7610, 7610O, 7710	Outer Tie Rod, Right Hand 13.375" Long M22x1.50" Right Hand Thread Replaces 83984963, ZP0501205469	AMZP0501206191	\$ 186.00	
	5640, 6640, 7740, 7840, 8240, 8340 - w/ MFWD	Tie Rod End 9.50" Long M24x1.50" Left Hand Thread Replaces 81863335, CAR48978	AM81863221	\$ 127.00	
	5640, (T6020, T6030 - Tier 3 Delta or Tier 3 Plus), 6640, 7740, (7840, 8240, 8340 - 11/1991 and Later), T6010, TS90, TS100, TS100A, TS110, TS115A, TS130A	Outer Tie Rod, Right Hand 19.875" Long, 1.375" Diameter Replaces E9NN3278AA	AM81864106	\$ 131.00	
	5700, 6700, 6710, 7700, 7710, 8000, 8700, 9000, 9700, TW5, TW15, TW25, TW30	Tie Rod 3.75" Long, 1" Diameter 16 Right Hand Thread	AMD8NN3A302AA	\$ 40.00	
	7840, 7840O, 8240, 8340, T6010, T6020, T6030, T6050, T6070, TS90, TS100, TS100A, TS110, TS110A, TS115A, TS125A, TS130A, TS135A	Tie Rod End 4" Long 1 1/4"x12 UNC Right Hand Thread	AM81863815	\$ 200.00	
	8000, 8200, 8400, 8600, 8700, 9200, 9600 - w/ Wide or All Purpose Axle	Tie Rod 3.812" Long, 1" Diameter 16 Right Hand Thread Use w/ AMC7NN3280D Tie Rod Replaces C5NN3280R, C5NN3307F	AME3NN3307AA	\$ 20.00	

Prices Subject to Change without Prior Notice. The use of original equipment manufacturer (OEM) part numbers or trademarks, e.g. Case® and John Deere®, are for reference purposes only and for indicating product use and compatibility. Our company and the listed replacement parts contained herein are not sponsored, approved or manufactured by the OEM. All parts are New unless designated Reman in the description.

Ford® / New Holland®—Tractor

	Application	Description	Part Number	Retail Price	Core
	8000, 8200, 8400, 8600, 8700, 9200, 9600 - w/ Wide or All Purpose Axle	Tie Rod 19.625" Long, 0.937" Diameter, 9 Notches	AMC7NN3280D	\$ 36.00	
	8530, 8630, 8730, 8830, TW5, TW15, TW25, TW35 - w/ Heavy Duty Wide Adjustable Axle	Tie Rod 7 Cross Holes 1.187" Diameter, 29.50" Long	AME2NN3280BA	\$ 197.00	
	8530, 8630, 8730, 8830, TW5, TW15, TW25, TW35 - w/ APL 365 Axle	Ball Joint 9" Long M22x1.50" Right Hand Thread M28x1.50" Right Hand Thread Replaces 3957095	AMZP0501205394	\$ 97.00	
	8670, 8670A, 8770, 8770A, 8870, 8870A, 8970, 8970A	Tie Rod 4.125" Long, 1.125" Diameter 12 Right Hand Thread	AM86502997	\$ 55.00	
	8670, 8670A, 8770, 8770A, 8870, 8870A, 8970, 8970A	Tie Rod 7.25" Long, 1.25" Diameter 12 Right Hand Thread	AM86020750	\$ 31.00	
		Tie Rod 7.25" Long, 1.25" Diameter 12 Left Hand Thread	AM86020751	\$ 60.00	
	8670, 8770, 8870, 8970 - w/ MFWD	Tie Rod, Right Hand 12.75" Long, 1.25" Diameter 12 Right Hand Thread	AM86024885	\$ 175.00	
		Tie Rod, Left Hand 12.75" Long, 1.25" Diameter 12 Left Hand Thread	AM86024884	\$ 264.00	
	8700, 9700, (TW10, TW20 - w/ Standard Short Wheelbase)	Tie Rod 8 Cross Holes 33.062" Long, 1.187" Diameter	AME1NN3280AA	\$ 50.00	
	T6010, T6020, T6030, T6040, T6050, T6060, T6070, T6080, TS110A, TS115A, TS125A, TS135A	Tie Rod Assembly 58.875" Long M18x1.50" Right Hand Thread M24x1.50" Right Hand Thread	AM5197798	\$ 225.00	
	T6010, T6020, T6030, T6050, T6070, T6.125, T6.145, T6.155, T6.165, T6.175, T6.180	Tie Rod End 3.75" Long, 0.875" ID 14 UNF Right Hand Thread	AM81863813	\$ 39.00	
	T6010, T6020, T6030, T6050, T6070, T6.125, T6.145, T6.155, T6.165, T6.175, T6.180, TS125A, TS135A - w/ Heavy Duty Axle	Tie Rod 20.50" Long, 1.362" Diameter	AM81863803	\$ 186.00	
	T6030, T6050, T6070, T6080	Tie Rod Assembly 58 7/8" Long M18x1.50" Right Hand Thread M24x1.50" Right Hand Thread	AM87332622	\$ 175.00	
	T7030, T7040, T7050, T7060, TM175, TM190	Tie Rod End 4" Long 7/8"x14 Right Hand Internal Thread	AM44995130	\$ 85.00	
	T7030, TM175, TM190	Tie Rod End, Left Hand 4.31" Long M24x1.50" Right Hand Thread	AM5198880	\$ 65.00	
	T8010, T8020, T8030, T8040, T8050, TG210, TG215, TG230, TG245, TG255, TG275, TG285, TG305	Tie Rod Tube For 10-Bolt Axle	AM87455775	\$ 250.00	
	T8010, T8020, T8030, T8040, T8050, TG210, TG215, TG230, TG245, TG255, TG275, TG285, TG305	Tie Rod, Right Hand 20.21" Long M36x1.50" Right Hand Thread	AM87455779	\$ 425.00	
		Tie Rod, Left Hand 20.21" Long M36x1.50" Left Hand Thread	AM87455778	\$ 425.00	

Ford® / New Holland®—Tractor





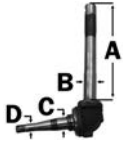
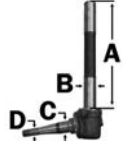

	Application	Description	Part Number	Retail Price	Core
	T8010, T8020, T8030, T8040, T8050, TG210, TG215, TG230, TG245, TG255, TG275, TG285, TG305 - w/ SuperSteer™ Axle	Tie Rod End, Right Hand 16" Long M38x1.50" Left Hand Thread Original assembly must be updated to metric to use this end Replaces 409569A2	AM87417424	\$ 375.00	
		Tie Rod End, Left Hand 16" Long M38x1.50" Left Hand Thread Original assembly must be updated to metric to use this end Replaces 409568A2	AM87417425	\$ 375.00	
	T8010, T8020, T8030, T8040, T8050, TG210, TG215, TG230, TG245, TG255, TG275, TG285, TG305 - w/ SuperSteer™ Axle	Tie Rod End, Right Hand 6.37" Long M38x1.50" Right Hand Thread Original assembly must be updated to metric to use this end Replaces 402341A2	AM87417426	\$ 175.00	
	TB80, TB90, TB100, TB110, TB120, TS6020, TS6030	Tie Rod and Coupling, Left Hand Replaces 48084958	AM1997712C2	\$ 210.00	
	TD60D, TD70D, TD75D, TD80D, TD90D, TD95D, TD5010, TD5020, TD5030, TD5050	Tie Rod End 21 3/8" Long Replaces 5086980	AM5085085	\$ 60.00	
	TG210, TG215	Tie Rod M38 Right Hand Thread	AM87455743	\$ 301.00	
		Tie Rod M38 Left Hand Thread	AM87455742	\$ 301.00	
	TS100A, TS110A, TS115A	Tie Rod Assembly 54.375" Long M18x1.50" Right Hand Thread M24x1.50" Right Hand Thread	AM5196358	\$ 200.00	
	TT45A, TT50A, TT60A, TT75A	Outer Tie Rod End, Left Hand 27 1/2" Long, 0.867" Diameter	AM9970790	\$ 35.00	

Spindles



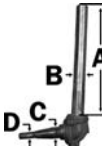
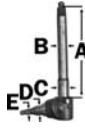

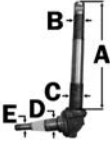
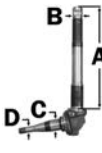
Spindles are forged from high grades of alloy steel, machined and assembled to exact specifications that meet or exceed OEM specifications.

	Application	Description	Part Number	Retail Price	Core
	8N 1948-52, NAA 1953-54	Spindle	Right Hand	AM8N3105B	\$ 65.00
			Left Hand	AM8N3106B	\$ 65.00
		Bushing - Upper		AM2N3109	\$ 3.00
		Thrust Bearing		AMCONN3123B	\$ 5.00
		Wheel Bearing Kit		WBK-FD-1	\$ 30.00
	2N, 9N - 1939-47	Spindle	Right Hand	AM2N3105	\$ 65.00
			Left Hand	AM2N3106	\$ 65.00
		Bushing - Upper		AM2N3109	\$ 3.00
		Thrust Bearing		AMCONN3123B	\$ 5.00
		Wheel Bearing Kit		WBK-FD-1	\$ 30.00

Ford® / New Holland®—Tractor

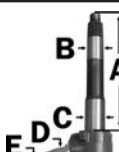
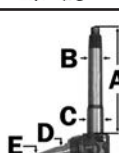
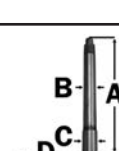
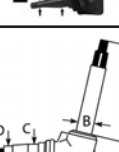
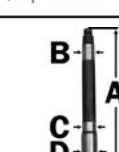
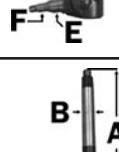
	Application	Description		Part Number	Retail Price	Core
	(600, 700, 800, 900, 2000, 4000 - 1955-64) BSN 137818 use WBK-FD-2 ASN 137818 use WBK-FD-3	Spindle	Right Hand	AMNCA3105B	\$ 73.00	
		Replaces 957E3105	Left Hand	AMNCA3106B	\$ 60.00	
		A - 10.687	Bushing - Upper	AM2N3109	\$ 3.00	
		B - 1.25	Bushing - Lower	AMNCA3110A	\$ 4.95	
		C - 1.34	Thrust Bearing	AMC0NN3123B	\$ 5.00	
		D - 1.25	Wheel Bearing Kit	WBK-FD-2	\$ 30.00	
		E - 0.75	Wheel Bearing Kit	WBK-FD-3	\$ 28.00	
	(2000, 3000 - 1965-75 Vineyard), (2600, 2610, 3600, 3610, 3900, 4100 - 1976-81 w/o Cab)	Spindle - Keyed	Right Hand	AMC5NN3105U	\$ 71.00	
		Heat Treated	Left Hand	AMC5NN3106R	\$ 71.00	
		A - 11.687	Bushing - Upper	AM2N3109	\$ 3.00	
		B - 1.25	Bushing - Lower	AMNCA3110A	\$ 4.95	
		C - 1.34	Thrust Bearing	AMC0NN3123B	\$ 5.00	
		D - 1.25				
E - 0.75						
	2310, 2610, 2910, 3610, 3910, 4110, 4410SU, 4610 Standard, 4610SU - 1981 and Later	Spindle - Keyed	Right Hand	AME0NN3105AA	\$ 163.00	
		Standard	Left Hand	AME0NN3106AA	\$ 75.00	
		A - 11.75	Bushing - Upper	AM2N3109	\$ 3.00	
		B - 1.246	Bushing - Lower	AMC5NN3110B	\$ 4.25	
		C - 1.464	Thrust Bearing	AMC5NN3A299A	\$ 6.00	
		D - 1.375				
E - 0.75						
	2600, 3600, 3900, 4100 - 1976-81 w/ Cab	Spindle - Keyed	Right Hand	AMD4NN3105B	\$ 120.00	
		Standard	Left Hand	AMD4NN3106B	\$ 120.00	
		A - 12.00	Thrust Bearing	AM138712	\$ 13.00	
		B - 1.34	Bushing - Lower	AMNCA3110A	\$ 4.95	
		C - 1.25	Wheel Bearing Kit	WBK-FD-4	\$ 29.00	
		D - 0.75				
	(3600, 4100, 4600 - 1975-81 w/ 3 Cylinder Engine), 5700, 6700, 7700	Spindle	Right Hand	AMD5NN3105E	\$ 425.00	
			Left Hand	AMD5NN3106E	\$ 417.00	
		A - 16.875				
		B - 1.722				
		C - 1.934				
	3600, 4100, 4600, 5610, 5700, 6610, 6700, 6710, 7410, 7610, 7700, 7710, 7810, 7810O, 7910, 8210, Utility: 532	Spindle	Right Hand	AMD5NN3105F	\$ 399.00	
		A - 12.875"				
		B - 1.722"				
		C - 1.934"				
	4000 1965-75, Excluding Vineyard	Spindle	Right Hand	AMC5NN3105T	\$ 70.00	
		Standard	Left Hand	AMC5NN3106N	\$ 71.00	
		A - 12.125	Bushing - Upper	AM2N3109	\$ 3.00	
		B - 1.244	Bushing - Lower	AMC5NN3110B	\$ 4.25	
		C - 1.465	Thrust Bearing	AMC5NN3A299A	\$ 6.00	
		D - 1.375				
		E - .75				
	4600 1976-81, 4610 1981-02/90	Spindle	Right Hand	AMD4NN3105A	\$ 85.00	
		Standard	Left Hand	AMD4NN3106A	\$ 85.00	
		A - 12.25	Bushing - Lower	AMC5NN3110B	\$ 4.25	
		B - 1.464	Thrust Bearing	AMC5NN3A299A	\$ 6.00	
		C - 1.375	Wheel Bearing Kit	WBK-FD-5	\$ 49.00	
		D - 0.75				
	5000, 5100, 5600, 6600, 7000, 7100, 7600 - 1963-75 w/ 10x16 Tires	Spindle	Right Hand	AMD2NN3105C	\$ 311.00	
			Left Hand	AMD2NN3106C	\$ 339.00	
		A - 10.687	Thrust Bearing	AM138712	\$ 13.00	
		B - 1.498	Bushing	AMC5NN3109A	\$ 5.50	
		C - 1.784	Bushing	AMC5NN3110A	\$ 4.50	
		D - 1.797				
		E - 1.125				

Ford® / New Holland®—Tractor

	Application	Description		Part Number	Retail Price	Core
	(5000, 7000 - 1965-75 w/o 10x16 Tires), (5600, 6600 - 1976-81), (5610, 6610 - 1981 and Later), (7600, 7610, 7700 - 1976 and Later)	Spindle - Keyed	Right Hand	AMC5NN3105M	\$ 71.00	
		A - 10.625	Left Hand	AMC5NN3106J	\$ 70.00	
		B - 1.498	Thrust Bearing	AM138712	\$ 13.00	
		C - 1.748	Bushing	AMC5NN3109A	\$ 5.50	
		D - 1.625	Bushing	AMC5NN3110A	\$ 4.50	
E - 0.843						
	5640, 6640, 6640O, 7740, 7740O, 7840, 7840O, 8240, 8340, TS90, TS100, TS100A, TS110, TS110A, TS115A, TS125A, TS130A, TS135A	Spindle	Right or Left Hand	AME9NN3105EB	\$ 162.00	
		A - 12.00				
		B - 1.722				
		C - 1.934				
		D - 1.625				
E - 0.843						
	5700, 6700, 6710, 7700, 7710	Spindle	Left Hand	AMD5NN3106F	\$ 490.00	
		Replaces 83908153				
		A - 12.875				
		B - 1.722				
		C - 1.934				
D - 1.625						
E - 0.842						
	5700, 6700, 6710, 7700, 7710 - Hi-Clearance	Spindle	Right Hand	AMD5NN3105D	\$ 694.00	
		A - 16.775	Left Hand	AMD5NN3106D	\$ 646.00	
		B - 1.722	Thrust Bearing	AM138712	\$ 13.00	
		C - 1.934	Wheel Bearing Kit	WBK-FD-6	\$ 54.00	
		D - 1.625	Wheel Hub	AMC9NN1104D	\$ 63.00	
		E - 0.842				
	8000, 8530, 8630, 8700, 8730, 8830, 9700, TW10, TW20, TW30, TW35	Spindle	Left or Right Hand	AMD9NN3105AA	\$ 948.00	
		42 Spline	Thrust Bearing	AM138712	\$ 13.00	
		A - 14.75				
		B - 1.999				
		C - 2.00				
D - 1.50						
	8000, 9000	Spindle	Right Hand	AMC9NN3105C	\$ 587.00	
		36 Spline	Left Hand	AMC9NN3106B	\$ 681.00	
		A - 16.775	Thrust Bearing	AM138712	\$ 13.00	
		B - 1.638	Bushing	AMC5NN3109A	\$ 5.50	
		C - 1.722	Wheel Bearing Kit	WBK-FD-7	\$ 45.00	
		D - 1.934				
		E - 1.794				
F - 1.125						
	8700, 9700, TW5, TW10, TW15, TW20, TW25, TW35	Spindle	Right Hand	AMD5NN3105C	\$ 508.00	
		A - 16.775	Left Hand	AMD5NN3106C	\$ 522.00	
		B - 1.722	Thrust Bearing	AM138712	\$ 13.00	
		C - 1.934	Wheel Bearing Kit	WBK-FD-7	\$ 45.00	
		D - 1.794				
E - 1.125						
	(2000, 3000, 4000 - 1965-07/70), 4110, 4140	Front Axle Support Pin		AMC5NN3127B	\$ 24.00	
		1.75" OD, 4.25" Long	Bushing	AMC5NN3153C	\$ 12.00	
	(2000, 3000, 4000 - 08/70 and Later), 2100, 2110, 2120, 2310, 2600, 2610, 3055, 3100, 3120, 3310, 3600, 3610, 3910, 4100, 4110, 4140, 4600	Front Axle Support Pin		AMC7NN3127D	\$ 40.00	
		2" OD, 5.50" Long	Bushing	AMC7NN3153B	\$ 4.60	
	(5000, 5100, 5110, 5200, 5600, 5610, 6410, 6600, 6610, 6710, 7000, 7100, 7200, 7600, 7610, 7710 - 1981-03/85)	Front Axle Support Pin, Rear		AMC5NN3N160A	\$ 38.00	
		1.25" OD, 5.15" Long	Bushing	AMC5NN3446A	\$ 3.50	
	(5000, 7000, 5600, 6600, 7600, 5610, 6610, 7610 - 1981-03/85)	Front Axle Support Pin, Front		AMC5NN3N159A	\$ 36.00	
		1.875" OD, 9" Long	Bushing	AMC5NN3153A	\$ 5.00	

Prices Subject to Change without Prior Notice. The use of original equipment manufacturer (OEM) part numbers or trademarks, e.g. Case® and John Deere®, are for reference purposes only and for indicating product use and compatibility. Our company and the listed replacement parts contained herein are not sponsored, approved or manufactured by the OEM. All parts are New unless designated Reman in the description.



Ford® / New Holland®—Tractor





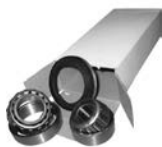

Wheel Hubs and Components

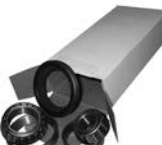
Application	Description	Part Number	Retail Price	Core
8N, 501, 600, 601, 700, 800, 801, 900, 2000, 2100, 2600, 2810, 2910, 3000, 3055, 3100, 3230, 3600, 3910, 4000, 4100, 4110, 4140, 4600, 4610, 4630, NAA, Dexta	Hub Cap	AM957E1139	\$ 7.00	
601, 801, 2100, 2310, 2610, 2810, 2910, 3055, 3230, 3610, 3910, 3930, 4000, 4100, 4110, 4130AP, 4130N, 4410SU, 4600, 4610, 4610N, 4610SU 1981 and Later, 4630	Wheel Hub, 6-Bolt Hub Cap	AMC9NN1104E AM2N1139B	\$ 51.00 \$ 10.80	
501, 600, 700, 800, 900, 2000, 2100, 2300, 2600, 2610 1976-81 w/o Cab, 2910, 3000, 3100, 3300, 3600, 3610 1976-81 w/o Cab, 3900, 3910, 4000 1955-64 Orchard, 4100, 4140, Dexta	Wheel Hub, 6-Bolt Hardware Not Included Replaces C5NN1104B, C9NN1104C	AMC9NN1104F	\$ 62.50	
2030, 3400 1965-74, 3500, 3550, 3910, 4400, 4410, 4500, 4610, 5100, 5110, 5200, 5600, 5610, 5700, 5900, 6000, 6410, 6600, 6600C, 6610, 6700, 6710, 6810, 7100, 7200, 7410, 7600, 7600C, 7610, 7700, 7710, 8000, 8240, 8340, 8700, 9000, 9700, TW5, TW10, TW15, TW20, TW25, TW30, TW35	Wheel Hub, 6-Bolt Press-In Hub Cap Use w/ WBK-FD-7 Wheel Bearing Kit	AM313020	\$ 87.00	
5000, 5100, 5110, 5200, 5600, 5610, 5640, 5700, 5900, 6410, 6600, 6610, 6640, 6700, 6710, 6810, 7000, 7100, 7200, 7410, 7600, 7610, 7710, 7740, 7810, 7840, 7910, 8210	Wheel Hub, 6-Bolt Requires AMC5NN1130A Threaded Hub Cap Use w/ WBK-FD-6 Wheel Bearing Kit Replaces C5NN1104F, C9NN1104B Hub Cap, Threaded	AMC9NN1104D AMC5NN1130A	\$ 63.00 \$ 4.00	
8530, 8630, 8730, 8830, TW5, TW10, TW15, TW20, TW25, TW30, TW35	Wheel Hub, 8-Bolt Standard Duty	AME1NN1104AA	\$ 236.00	

Wheel Bearing Kits

Application	Description	Part Number	Retail Price	Core
 2N 1939-47, 8N 1948-52, 9N, NAA 1953-54	Wheel Bearing Kit	WBK-FD-1	\$ 30.00	
	Components:			
	Inner Cone	1 15118	\$ 8.00	
	Inner Cup	1 15250	\$ 4.75	
	Outer Cone	1 09074	\$ 3.20	
	Outer Cup	1 09196	\$ 5.00	
 (600, 700, 800, 900, 2000, 4000 - 1955-64) Measure spindle bearing size prior to ordering kit, same applications could use WBK-FD-3	Wheel Bearing Kit	WBK-FD-2	\$ 30.00	
	Components:			
	Inner Cone (1.25" ID, 0.75" Wide)	1 15123	\$ 6.00	
	Inner Cup (2.441" OD, 0.5625" Wide)	1 15245	\$ 4.00	
	Outer Cone (0.75" ID, 0.75" Wide)	1 09067	\$ 3.12	
	Outer Cup (1.938" OD, 0.5625" Wide)	1 09195	\$ 2.45	
 (600, 700, 800, 900, 2000, 4000 - 1955-64) Measure spindle bearing size prior to ordering kit, same applications could use WBK-FD-2	Wheel Bearing Kit	WBK-FD-3	\$ 28.00	
	Components:			
	Inner Cone (1.25" ID, 0.5937" Wide)	1 LM67048	\$ 7.00	
	Inner Cup (2.328" OD, 0.465" Wide)	1 LM67010	\$ 2.75	
	Outer Cone (0.75" ID, 0.655" Wide)	1 LM11949	\$ 2.99	
	Outer Cup (1.781" OD, 0.475" Wide)	1 LM11910	\$ 1.70	
Seal	1 AP19220	\$ 3.00		

Ford® / New Holland®—Tractor

Application	Description	Part Number	Retail Price	Core
 1830, 2310, 2610, 2830, 2910, 2930, 3610, 3910, 3930, 4000 1965-75 Except Vineyard, 4100, 4110, 4130AP, 4130N, 4610N, 4610SU 1981 and Later, 4630	Wheel Bearing Kit	WBK-FD-5	\$ 49.00	
	Components:			
	Inner Cone	1 LM48548	\$ 6.00	
	Inner Cup	1 LM48510	\$ 4.00	
	Outer Cone	1 LM11949	\$ 2.99	
	Outer Cup	1 LM11910	\$ 1.70	
	Seal	1 AM310195	\$ 6.00	
 (2000, 3000 - 1965-75), (2600, 3600, 3900, 4100 - 1975-81), (2610, 3610, 3910, 4110 - 1981 and Later), Dexta, Super Dexta	Wheel Bearing Kit	WBK-FD-4	\$ 29.00	
	Components:			
	Inner Cone	1 LM67048	\$ 7.00	
	Inner Cup	1 LM67010	\$ 2.75	
	Outer Cone	1 LM11949	\$ 2.99	
	Outer Cup	1 LM11910	\$ 1.70	
	Seal	1 AP19060	\$ 3.00	
 (5000, 7000 - w/o 10x16 Tires, 1965-75), 5100, 5110, 5600, 5610, 5640, 5700, 5900, 6410, 6600, 6610, 6640, (6700, 6710, 7710 - w/ Lo- or Hi-Clearance), 6810, 7100 (Left Hand Only), 7600, 7610, 7700, 7740, 7840	Wheel Bearing Kit	WBK-FD-6	\$ 54.00	
	Components:			
	Inner Cone	1 LM501349	\$ 6.00	
	Inner Cup	1 LM501310	\$ 7.50	
	Outer Cone	1 M12649	\$ 4.50	
	Outer Cup	1 M12610	\$ 2.00	
	Seal	1 AP19195	\$ 6.00	
 (5000, 7000 - w/ 10x16 Tires, 1963-75), (8000, 8600, 8700, 9000, 9600, 9700, TW5, TW10, TW15, TW20, TW25 - w/ Standard Axle)	Wheel Bearing Kit	WBK-FD-7	\$ 45.00	
	Components:			
	Inner Cone	1 25590	\$ 11.00	
	Inner Cup	1 25521	\$ 7.50	
	Outer Cone	1 02474	\$ 13.00	
	Outer Cup	1 02420	\$ 5.85	

Steering Arms



Application	Description	Part Number	Retail Price	Core
(5000, 7000 - 06/1966 and Later), 5600, 5610, 6600, 7600, 6610, 7610 - w/ Power Steering	Steering Arm	Center AMD6NN3N670A	\$ 75.00	
	Steering Arm	Right Hand AMC5NN3130A	\$ 56.00	
	Tie Rod attaches from bottom of steering arm	Left Hand AMC5NN3131A	\$ 56.00	
5700, 6700, 6710, 7700, 7710, 7810, 7910, 8210, 8700, 9700, TW10, TW20, TW30	Steering Arm, Left Hand	AMD5NN3131B	\$ 295.00	
Major, Super Major, Power Major	Steering Arm Replaces E1ADKN-3133C	AME1ADKN3133B	\$ 84.00	
(5000, 7000 Series - 06/1966-74), 5600, 5610, 6600, 6610, 7600, 7610	Center Steering Shaft	AMC5NN3N703C	\$ 28.00	
	Steering Shaft Bushing	Upper AMC5NN3179B	\$ 6.00	
	Steering Shaft Bushing	Lower AMC5NN3179A	\$ 5.00	
2N, 8N, 9N, 501, 531, 541, 600, 601, 611, 620, 621, 630, 631, 640, 641, 650, 651, 660, 661, 671, 681, 700, 701, 740, 741, 771, 800, 801, 811, 820, 821, 840, 841, 850, 851, 860, 861, 871, 881, 900, 901, 941, 950, 951, 960, 961, 971, 981, 2000, 2110, 2120, 2310, 2600, 2810, 2910, 3000, 3100, 3110, 3120, 3310, 3600, 3610, 3900, 3910, 4000, 4100, 4110, 4120, 4140, 4200, 4330, 4340, 4600SU, 4610SU	Dust Seal, Steering Arm	AMC5NN3125A	\$ 2.50	

Ford® / New Holland® —Tractor

Axle Center Tubes and Beams

Application	Description	Part Number	Retail Price	Core
2000, 2100, 2310, 2600, 2610, 2810, 2910, 3000, 3055, 3100, 3110, 3120, 3150, Ind: 231, 233, 234	Front Axle Assembly w/ Bushing	AMC7NN3010F	\$ 143.00	

Axle Knee Extensions

Application	Description	Part Number	Retail Price	Core
231, 233, 333, 531, 2000, 2100, 2110, 2120, 2150, 2300, 2310, 2600, 3000, 3055, 3100, 3110, 3120, 3150, 3300, 3310, 3330, 3600, 3900, 4000, 4110, 4140, 4600 - w/ 3 Cylinder Engine	Axle Knee Extension, Left Hand Replaces 81822704	AMC7NN3007J	\$ 226.00	
2000, 2100, 2110, 2120, 2150, 2310, 3000, 3055, 3100, 3110, 3120, 3150, 3310, 4000, 4110, 4140 - w/ 3 Cylinder Engine	Axle Knee Extension, Right Hand	AMC5NN3006G	\$ 65.79	

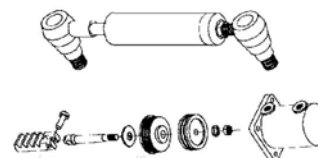

Power Steering Cylinders and Components

Application	Description	Part Number	Retail Price	Core
601, 801, 2000, 3000, 3600, 4600	Power Steering Cylinder Right or Left Hand, 5/8" Diameter Rod 7/16" Male Thread Ref# 81846467	AMD4NN3A540A	\$ 214.00	
601, 801, 2000, 3000, 3600, 4600, Ind/Utility: 230A, 231, 234, 355, 531	Power Steering Cylinder Right or Left Hand, 1/2" Diameter Rod 7/16" Male Thread	AME2NN3A540BA	\$ 318.00	
5610, 5610S, 5900, 6610, 6610S, 7610, 7610S, 7810, 7810S	Power Steering Cylinder	AME3NN3A540BA	\$ 316.00	
5640, 6640, 6640O, 7740, 7740O, 7840, 7840O, TS90, TS100, TS100A, TS110, TS115A	Power Steering Cylinder Replaces 8865697, 81864108, 82037177	AM81869701	\$ 390.00	
7530	Power Steering Cylinder Replaces 5140638, 5143022, 5189897	AM5113130	\$ 295.00	
T8010, T8020, T8030, T8040, T8050, TG210, TG215, TG230, TG245	Power Steering Cylinder, Right Hand For 10-Bolt Hub	AM87455637	\$ 2425.00	
	Power Steering Cylinder, Left Hand For 10-Bolt Hub	AM87455636	\$ 2525.00	
T8010, T8020, T8030, T8040, T8050, TG210, TG215, TG230, TG245, TG255, TG275, TG285, TG305 - w/ Super Steer Axle	Power Steering Cylinder, Right Hand Replaces 87455625	AM87455620	\$ 1200.00	
	Power Steering Cylinder, Left Hand Replaces 87421635, 87455621	AM87455619	\$ 1224.00	
T8010, T8020, T8040, T8050, TG210, TG230, TG245, TG255, TG275, TG285, TG305	Power Steering Cylinder, Right Hand For 12-Bolt Axle	AM87455648	\$ 1600.00	
	Power Steering Cylinder, Left Hand For 12-Bolt Axle	AM87455647	\$ 2025.00	
	Seal Kit Use w/ AM87455647 or AM87455648 Power Steering Cylinder	AM87455632	\$ 245.00	
T8.300, T8.320, T8.330, T8.350, T8.360, T8.380, T8.390, T8.410, T8.420, T8.435 - w/ Class 5 Axles	Power Steering Cylinder	AM84336641	\$ 550.00	
TG210, TG230 - w/ 10-Bolt Hubs w/ SupersSeer™ Axle	Power Steering Cylinder MFWD, Right or Left Hand	AM87404328	\$ 475.00	
TG210, TG230, TG255, TG285 - w/ 12-Bolt Hub w/o SuperSteer™ Axle	Power Steering Cylinder DANA® MFWD, Right or Left Hand Ref# 293678A2, 87455650	AM293678A2	\$ 597.00	
TM115, TM120, TM125, TM130, TM135, TM140, TM150, TM155, TM165, TM175, TM190 - w/ MFWD	Power Steering Cylinder Replaces 5164022, 82991196	AM87302891	\$ 360.00	

Ford® / New Holland®—Tractor

Application	Description	Part Number	Retail Price	Core
Ind: (535, 545, 555 Early), 4500 - w/ HD Axles	Power Steering Cylinder Right or Left Hand, 0.75" Diameter Rod	AMD8NN3A540AB	\$ 356.00	
601, 801, 2000, 3000, 3600, 4600, Ind/Utility: 230A, 231, 234, 335, 531	Power Steering Cylinder End 7/16" 20 Female Thread, 2.75" Long Use w/ AME2NN3A540BA Cylinder	AMC5NN3A302B	\$ 13.00	
5100, 5600, 5610, 5900, 6410, 6600, 6610, 6710, 6810, 7100, 7600, 7610, 7810, 8010 04/1996 and Later	Power Steering Cylinder End 3.625" Long, 0.875" Diameter Internal 14 Thread	AME3NN3B539AA	\$ 23.00	
5640, 6640, 7740, 7840, TS90, TS100, TS110	Power Steering Cylinder End 2.875" Long, 1.25" Diameter 12 Right Hand Thread	AM81864115	\$ 35.00	
5700, 6700, 6710, 7700, 7710, 8000, 8700, 9700, TW10, TW20, TW30	Power Steering Cylinder End 3.75" Long, 0.875" Diameter 18 Thread Replaces D5NN3B539C, D8NN3B539AA	AMD8NN3B539AB	\$ 59.00	
5700, 6700, 6710, 7700, 7710, 7810, 7910, 8000, 8210, 8530, 8630, 8700, 8730, 8830, 9000, 9700, TW5, TW15, TW25, TW30, TW35	Power Steering Cylinder End 3.75" Long, 1" Diameter 16 Right Hand Thread Replaces E6NN3N81AA, D5NN3A302C, D5NN3A302D, D8NN3A302AA	AME6NN3N981AA	\$ 61.00	
(T8010, T8020, T8030, T8040, T8050, TG210, TG215, TG230, TG245, TG255, TG275, TG285, TG305 - w/ 12 Bolt Hubs w/ SuperSteer™ Axle)	Power Steering Cylinder End 4" Long, 0.89" Thread Length M22x1.50" Right Hand Thread 1.25"x12 UNF Right Hand Thread Replaces 87421641, 87455618	AM47381302	\$ 175.00	
For Aftermarket Power Steering Cylinders that Replace OEM E2NN3A540BA, D4NN3A540A, C5NN3A739B	Power Steering Cylinder End 2.125" Long, 0.687", 18 Thread Not used on OEM Power Steering Cylinders	AME2NN3A540BJ	\$ 20.00	
Ind: (535, 545, 555 Early), 4500 - w/ HD Axles	Power Steering Cylinder End Female Thread Use w/ AMD8NN3A540AB Cylinder	AMD8NN3A540BJF	\$ 17.00	
For C5NN3A739B Power Steering Cylinder	Power Steering Ball Joint 20 Female Thread	AMCAPN3300A	\$ 20.00	
5640, 6640, 7740, 7840, 8210, 8240, 8340, Backhoe-Loaders: 555E, 575E, 655E, 675E	Power Steering Ball Joint 8.21" Long M22x1.50" and M24x1.50" Right Hand Thread Replaces 247522A1, 83957792, N14377	AM9968018	\$ 77.00	
Ind: (535, 545, 555 Early), 4500 - w/ HD Axles	Power Steering Ball Joint Male Thread	AMD8NN3A540BJM	\$ 14.00	
(T8010, T8020, T8030, T8040, T8050 - w/ 10-Bolt Hubs or 12-Bolt Hubs), (T8.275, T8.330, T8.360 - w/ 12-Bolt Hubs All w/ or w/o CVT models w/ DANA® Axle w/o Differential Lock), T8.390 w/ 12-Bolt Hubs w/o CVT, (TG210, TG215, TG230, TG245, (TG275, TG285 - w/ Differential Lock) - w/ 10-Bolt Hubs), (TG255, TG285 - w/ 10-Bolt Hubs All w/o Differential Lock or ASN MY00195879 w/ Differential Lock), (TG255, TG275, TG285, (TG215, TG245 - w/ Differential Lock) - w/ 12-Bolt Hubs), (TG210, TG230 - w/ 12-Bolt Hubs All w/ Differential Lock or ASN MY00184591 w/o Differential Lock)	Power Steering Cylinder Pin	AM292565A1	\$ 135.00	
3230, 3430, 3930, 4130, 4630, 4830, 5030, (5110, 5610, 6610, 7610, 7710, 7810, 7910 - 02/1987 and Later), 5610S, 6610S, 6810, 7010 ASN 850001M, 7610S, 8010 ASN 800001M, TB80, TB85, TB90, TB100, TB110, TB120 - w/ MFWD	Power Steering Cylinder Seal Kit Axle Reference # - 124961, 149749 Replaces CAR49101	AM83957762	\$ 68.00	
(4030, 4230, 4430, TM115, TM125, TM135 ASN D4628 w/ 4WD Front Axle), (TD55D, TD60D, TD70D, TD85D ASN D5665 w/ 4WD Front Axle), (TD75D, TD80D, TD90D, TD95D, TD5010, TD5020, TD5030, TD5040, TD5050, TM120, TM130, TM140, TS100A, TS110A, TS115A, TS125A, TS130A, TS135A - 4WD Front Axle), TL70 ASN 1198664 w/ 4WD Front Axle	Power Steering Cylinder Seal Kit Use w/ 5098111, 5189887, 5189887R, 5189888 Steering Cylinders	AM5190591	\$ 33.00	

Ford® / New Holland®—Tractor

Remote Valves

Application	Description	Part Number	Retail Price	Core
T6010, T6020, T6030, T6040, T6050, T6060, T6070, T6080, T6090, TS100A, TS115A, TS125A, TS135A	Remote Valve	AM84125295	\$ 2652.00	
T6020, T6030, T6050, T6070, TS115A	Remote Valve	AM87328572	\$ 2065.00	
T6010, T6020, T6030, T6040, T6050, T6060, T6070, T6080, T6090, T6.120, T6.125, T6.140, T6.145, T6.150, T6.155, T6.160, T6.165, T6.175, T6.180, T7.165, T7.165S, T7.170, T7.175, T7.185, T7.190, T7.200, T7.210, T7.225	Control Valve Replaces R917006069, R917008844	AM84230181	\$ 1975.00	
T6030 BSN Z*BK 40001-50000 01/2007-09/13, T6050 BSN Z*BK 40001-50000 01/07-10/2016, T6070 BSN Z*BK 40001-50000, T6080, T6090, T7030, T7040, T7050, T7060, T7070, T7.170, T7.185, T7.200, T7.210, T7.220, T7.235, T7.250, T7.260, T7.270	Control Valve Replaces R917005998, R917006594	AM84214463	\$ 2200.00	
T7030, T7040, T7050, T7060, T7.195S, T7.215S, T7.230, T7.245, T7.260, TM115, TM120, TM125, TM130, TM135, TM140, TM150, TM155, TM165, TM175, TM190	Control Valve Replaces 5190713, 5195165, 87779662	AM87526168	\$ 1220.00	
T7.220 12/2010-02/16, T7.250, (T7.230, T7.245, T7.260 - 04/2014-MY18), (T7030, T7040, T7050, T7060 - 2007-11)	Control Valve Replaces 873134310	AM87313431	\$ 1780.00	
2000, 2100, 2110, 2120, 2150, 2300, 2310, 2600, 2610, 2810, 2910, 3000, 3055, 3100, 3110, 3120, 3150, 3230, 3300, 3310, 3330, 3400, 3430, 3500, 3550, 3600, 3610, 3900, 3910, 3930, 4000, 4100, 4110, 4130, 4140, 4200, 4330, 4340, 4400, 4410, 4500, 4600, 4610, 4630, 4830, 5000, 5030, 5100, 5200, 5340, 7000, 7100, 7200	Hydraulic Selector Valve Replaces C5NN0960D, E0NND960AA	AMC5NND960C	\$ 175.00	
T4020, T4020V, T4030, T4030F, T4030N, T4030V, T4040, T4040F, T4040N, T4040V, T4050, T4050F, T4050N, T4050V, T4060F, T4060N, T4060V, T4.100, T4.100F, T4.105, T4.105F, T4.105V, T4.110, T4.110F, T4.110LP, T4.110V, T4.115, T4.120, T4.55, T4.65, T4.65V, T4.75, T4.75F, T4.85, T4.85F, T4.85V, T4.90, T4.90F, T4.90LP, T4.90V, T4.95, T4.95F, T4.95V, TN55, TN55D, TN55S, TN60A, TN60DA, TN60SA, TN60VA, TN65, TN65D, TN65F, TN65S, TN65V, TN70, TN70A, TN70D, TN70F, TN70NA, TN70S, TN70SA, TN75, TN75A, TN75D, TN75DA, TN75F, TN75FA	Hydraulic Coupler, Female 22 mm x 1 1/2" ORB Male Threads	AM5179558	\$ 75.00	
T8010, T8020, T8030, T8040, T8050, T9020, T9030, T9040, T9050, T9060, TG210, TG215, TG230, TG245, TG255, TG275, TG285, TG305, TJ275, TJ280, TJ325, TJ330, TJ375, TJ380, TJ425, TJ430, TJ450, TJ480, TJ500, TJ530	Internal Female Coupler Kit Recommended to purchase in quantities of two (pressure and return) Genuine OEM Coupler includes HA345193 O-Ring and Seal Kit Replaces 93328C1, 275182A1, 87776294	AM84262367	\$ 163.00	
T5.105, T5.115, T6.140, T6.150, T6.155, T6.160, T6.175, T7.210, T7.260, T7.270, TS6.110, TS6.120, TS6.125, TS6.140	Hydraulic Remote Valve Coupling M22x1.50" Male Thread Quick Release	AM47370116	\$ 81.00	

Hydraulic Oil Coolers

Application	Description	Part Number	Retail Price	Core
(2600, 3600, 4600, 5600, 6600, 7000, 7600 - w/o Cab), (7100, 7200 - w/ Dual Power), Ind: (231, 233, 333, 335, 531, 532 - w/o Cab)	Hydraulic Oil Cooler	AMD3NNH860A	\$ 316.00	
5110, 5610, 6610, 66100, 6710, 6810, 7410, 7610, 76100, 7710	Hydraulic Oil Cooler, Power Steering Core: 3" x 5 1/2" x 1"	AM83954673	\$ 360.00	
T2310, T2320, TC40DA, TC45DA	Hydraulic Oil Cooler Core: 15" x 16" x 1 1/8"	AM87344149	\$ 430.00	
T9010, T9020, (T9030, T9040 ASN Z6F200013), TJ275, TJ280, TJ325, TJ330, TJ375, TJ380, TJ425, TJ430, TJ450, TJ500	Hydraulic Oil Cooler Core: 36" x 29" x 2 1/2" Replaces 345228A1, 361082A1	AM87312759	\$ 875.00	
T9.615, T9.670	Hydraulic Oil Cooler Core: 24.60" x 19.50" x 4"	AM84252569	\$ 1375.00	
	Transmission Oil Cooler Core: 19.50" x 24.60" x 4"	AM84210954	\$ 1250.00	

Ford® / New Holland®—Tractor

Application	Description	Part Number	Retail Price	Core
(2310, 2610, 2810, 2910, 3610, 3910, 4610 - w/ Transmission Cooler), (2600, 3230, 3430, 3600, 3930, 4130, 4600, 4630, 4830, 5030, 5600, 6600, 7600 - w/ Hydraulic Cooler)	Hydraulic Cooler/Transmission Oil Cooler Replaces 83902919	AMD4NNH860A	\$ 128.00	
8670, 8670A, 8770, 8770A, 8870, 8870A, 8970, 8970A	Charge Oil Cooler Core: 30 1/4" x 21.00" x 2 5/8" Replaces 9860029, 89821609, 89860029	AM86011668	\$ 1234.00	



Hydraulic Pumps

Application	Description	Part Number	Retail Price	Core
2N, 8N, 9N	Hydraulic Pump Rebuild Kit Replaces PTO shaft bushing, PTO shaft gasket, base gasket, safety valve, sump plug gasket, side gasket, piston, side plate gasket, cam block and includes chamber repair kit	AMX47114	\$ 310.00	
775 1995-10/95, (5640, 66400, 7740, 77400, 7840, 8240, 8340 - 11/91 and Later), 78400 2/93 and Later	Hydraulic Pump - Engine Mount Auxiliary Pump	AMF0NN600AA	\$ 365.00	
1920, 2120, 3415, T1530, T2310, T2320, T2330, TC35, TC40, TC45	Hydraulic Pump	AMSBA340450991	\$ 895.00	
2310, 2600, 2600N, 2600R, 2600V, 2610, 3600, 3600N, 3600NO, 3600R, 3600V, 3610, 4100, (4110NO, 4110O, 4110V - Prior to 04/1983), 5610, 6610, 6710, 7610, 7710, 7910, 8210, TW5, TW15, TW25, TW35, Ind/Utility: 233	Hydraulic Pump - Engine Mount (Optional) Uses a spin-on oil filter	AME1NN600AB	\$ 350.00	
(2910, 3910, 4110, 4610 - 04/83 and Later), 46100, 4610SU	Hydraulic Pump - Engine Mount (Optional)	AME2NN600AB	\$ 365.00	
3010S, 4010S, 4030, 4230, 4430, TD80D Standard Model, TD85F, TD95DHC Plus, TT55, TT65, TT75	Hydraulic Pump 14.35 cc, 10.80 GPM Replaces 1909915, 1909919, 1930068, 5086286, 5094391, 5113284, 5120849, 5129483, 5169772, 5179719, 8280127, 9967928, 84467651, 85086286, 87325370, 87721169, 87737603, 153634445, 320446000	AM84530156	\$ 160.00	
3010S, 4010S, 5010S, TD60D, TD70D, TD75D, TD80D, TD90D, TD90F, TD95, (TT55, TT65, TT75 ASN T00352M)	Hydraulic Pump - Engine Mount 19.33 cc, 10.80 GPM Replaces 2040333, 5093658, 5094394, 5169770, 5179414, 5179711, 5179714, 9967782, 47562399, 82987745, 87716629, 87737605	AM84530154	\$ 125.00	
3230, 3400, 3430, 3550, 3930, 4100, 4110, 4400, 4410, 4500, 4600, 4610, 4630, Ind: 340, 345C, 345D, 420, 515, 535, 540, 545	Hydraulic Pump - Transmission Mount Does not use a spin-on oil filter	AMD8NN600LB	\$ 301.00	
4000 1965 and Later, Ind: 3550	Hydraulic Pump - Transmission Mount	AMD0NN600F	\$ 565.00	
4835, TL70	Hydraulic Pump Replaces 5129486, 5169039	AM5179728	\$ 160.00	
5000, 5100, 5200, 7000, 7100, 7200 1965-75	Hydraulic Pump - Transmission Mount	AMD0NN600G	\$ 301.00	
5100, 5200, 7100, 7200	Hydraulic Pump - Transmission Mount 20 GPM	AMD2NN600B	\$ 425.00	
5100, 5600, 5610, 6600, 6610, 6700, 6710, 7100, 7600, 7610, 7700, 7710, 7910, 8210	Hydraulic Pump - Transmission Mount Uses a spin-on oil filter	AME0NN600AC	\$ 489.50	
5600, 5700, 6600, 6700, 7600, 7700	Hydraulic Pump - Transmission Mount	AMD8NN600KB	\$ 450.50	
5640, 6640, 7740, 7840, 8240, 8340, TS100, TS110, TS90	Hydraulic Pump - Transmission Mount Tandem Gear Pump	AMF0NN600BB	\$ 717.50	
5640, 6640, 7740, 7840, TS90, TS100, TS110, TS115	Hydraulic Pump - Transmission Mount Replaces 25917715, F0NN600CE, VPK1109	AM82850804	\$ 4870.00	
8000, 8600, 8700, 9000, 9600, 9700 1968-78	Hydraulic Pump - Transmission Mount 16 GPM	AMD5NN600C	\$ 590.00	
8430, 8530, 8630, 8830, TW30, TW35	Hydraulic Pump - Transmission Mount 20 GPM	AME2NN600BA	\$ 295.00	

Ford® / New Holland® —Tractor

Application	Description	Part Number	Retail Price	Core
Boomer 8N, Boomer 45D, Boomer 46D, Boomer 50D, Boomer 54D, Boomer 2030, Boomer 2035, Boomer 3040, Boomer 3045, Boomer 3050, Boomer 4055, Boomer 4060, T1530, T2210, T2220, T2310, T2320, T2330, T2410, T2420, TC29DA, TC31DA, TC33DA, TC34DA, TC35, TC35A, TC35D, TC35DA, TC40, TC40A, TC40D, TC40DA, TC45, TC45A, TC45D, TC45DA, TT45A, TT50A, Workmaster 45, Workmaster 55	Hydraulic Pump	AMSBA340451020	\$ 495.00	
Boomer 2030, Boomer 2035, T2210, T2220, TC29D ASN G039488, TC29DA, TC31DA, TC33DA, TC34DA	Hydraulic Pump	AMSBA340451090	\$ 470.00	
8670, 8670A, 8770, 8770A, 8870, 8870A, 8970, 8970A	Hydraulic Pump	AM86018162	\$ 2156.00	
(T6010, T6020, T6030, T6040, T6050, T6060, T6070 - Prior to 12/2009), T7030, T7040, T7050, T7060, TM175, TM190, (TS100A, TS115A - Plus/Deluxe Only), TS125A, TS135A	Hydraulic Pump 45 cc, 113 Liters per Minute Replaces 47127050, 87725827	AM5198694	\$ 3665.00	
T6030, T6040, T6060, T6070, T6080, T6090, T6.120, T6.125, T7.165, T7.175, T7.185, T7.210, T7.225 (MY15 and Later), (T6050, T7.170 - Power Command™ and Range Command™), (T6.140, T6.150, T7.200 - Excluding Auto Command™), (T6.145, T6.180 - Tier 4B 03/2015-01/18, Tier 4B MY18 and Electro Command™), (T6.155, T6.165, T6.175 - Tier 4, Tier 4B 03/2015-01/18, Tier 4B MY18 and Electro Command™), T6.160 (Tier 4, Tier 4B MY18 and Electro Command™), T7.190 (Excluding Auto Command™ MY15)	Hydraulic Pump 45 cc, 29.80 GPM Replaces 8416091	AM84471387	\$ 2151.75	
T7030, T7040, T7050, T7060, T7.220, T7.230, T7.235, T7.245, T7.250, T7.260, T7.270	Hydraulic Pump	AM84471388	\$ 2150.00	
T9010, T9020, T9030, T9040, T9050, T9060, TJ275, TJ280, TJ330, TJ375, TJ380, TJ425, TJ430, TJ450, TJ480, TJ500, TJ530	Reman Hydraulic Pump	AM432244A3	\$ 850.00	\$ 500.00
TL70, TL80, TL90, TL100, TN55, TN55D, TN55S, TN60A, TN60SA, TN65, TN65D, TN65F, TN65S, TN70, TN70A, TN70D, TN70F, TN75, TN75A, TN75D, TN75F, TN75FA, TN75S, TN80F, TN85FA, TN85SA, TN90F, TN95F, TN95FA	Hydraulic Pump	AM5168841	\$ 486.00	
T8.275, T8.300, T8.320, T8.330, T8.350, T8.360, T8.380, (T8.380, T8.410, T8.435 - SmartTrax™), T8.390, T8.410, T8.420, T8.435	Hydraulic Pump 85 cc, 55.60 GPM, High Capacity	AM47473854	\$ 2115.00	
T8.275, T8.300, T8.320, T8.330, T8.350, T8.360, T8.380, (T8.380, T8.410, T8.435 - SmartTrax™), T8.390, T8.410, T8.435	Hydraulic Pump 63 cc, 41.30 GPM, Standard Capacity Replaces 87538166	AM87538174	\$ 2015.00	
T9.390, T9.615, T9.670, (T9.435, T9.480, T9.530, T9.565, T9.600, T9.645, T9.700 - Optional Equipment on MY17), (T9.435 HD, T9.450, T9.480 HD, T9.505, T9.530 HD, T9.560, T9.565 HD, T9.600 HD, T9.645 HD, T9.700 HD - Optional Equipment)	Hydraulic Pump 85 cc Mega Flow Pump Replaces 84178463	AM47764642	\$ 2450.00	
T9.615, T9.670	Hydraulic Pump Replaces 84194336	AM47528844	\$ 2205.00	
(TW5, TW10, TW20 - 1979-82), TW15, TW25	Hydraulic Pump - Transmission Mount 16 GPM	AMD8NN600FA	\$ 588.00	
Utility: 1120, 1215, 1220, 1320, 1520, 1530, 1620, 1630, 1715, 1720, 1725, 1925, TC18, TC21, TC21D, TC21DA, TC23DA, TC24D, TC24DA, TC25, TC25D, TC26DA, TC29, TC29D, TC30, TC33, TC33D, T1510, T1520	Hydraulic Pump	AMSBA340451060	\$ 460.00	
TJ425, TJ450, TJ500	Hydraulic Fan Drive Pump 100 cc	AM413152A1	\$ 3300.00	
T9.600, T9.645, T9.700	Hydraulic Fan Drive Pump Replaces 84194336	AM47528844	\$ 2205.00	
5635, 6635, 7635, 8160, 8260, 8360, 8560, TL80, TL90, TL100, TM115, TM120, TM125	Hydraulic Lift Pump 19.33 cc Replaces 5129493, 5143768, 5169041, 5179726	AM84530167	\$ 200.00	

Ford® / New Holland® —Tractor

Application	Description	Part Number	Retail Price	Core
TD60D, TD70D, TD75D, TD80D, TD90D, TD95D Upgrade Model	Hydraulic Lift Pump 11.26 cc Replaces 1901322, 1930061, 5085685, 5088382, 5094395, 5094396, 5129481, 5143767, 5179722, 8273385, 8273973, 9967929, 84467650, 87325369, 87725756, 153633457	AM84530166	\$ 160.00	
2N, 8N, 9N	Hydraulic Pump Shaft 6 Spline, 13" Long, 3/4" Diameter	AM194354	\$ 30.75	
2N, 8N, 9N	Hydraulic Pump Drive Shaft 13.06" Long, 0.75" Diameter 5/8" Right Hand Thread	AM190760	\$ 38.00	
2N, 8N, 9N	Hydraulic Pump Drive Shaft 10 Spline, 3/8" Long	AM195454	\$ 41.50	
2N, 8N, 9N	Hydraulic Pump Drive Hub 3" Diameter 18 UNF Left Hand Thread	AM191196	\$ 54.00	
4030, 4230, 4430, TN55, TN60A, TN60DA, TN60SA, TN65, TN65D, TN65F, TN65S, TN70, TN70A, TN70D, TN70DA, TN70F, TN70S, TN70SA, TN75, TN75A, TN75DA, TN75F, TN75FA, TN75S, TN75SA, TN80F, TN85FA, TN90F, TN95F, TN95FA	Hydraulic Steering Pump Replaces 569306, 1901323, 1930058, 5088381, 5120406, 5129478, 5179730, 44900783, 87326060, 98420895, 153630659, 153634396, 153634432	AM5179729	\$ 125.00	



Power Steering Pumps and Conversion Kits

Application	Description	Part Number	Retail Price	Core
455C, 555C, 575D, 655C	Power Steering Pump Replaces E9NN3K514BA, E9NN3K514BB	AM81871798	\$ 675.00	
2110, 2600, 3500, 3550, 3600, 4100, 4100SU, 4500, 4600, 5100, 5600, 6600, 7100, 7600, Ind: 231, 233, 420, 3500	Power Steering Pump, Reservoir Style 2.74 GPM at 1100 PSI Replaces D8NN3K514CC, E6NN3K514CA, E6NN3K514FA, E6NN3K514GA, E6NN3K514HA, E6NN3K514KC	AME6NN3K514EA	\$ 290.00	
3230, 3430, 3930, 3930H, 3930N, 3930NO, 4130, 4130N, 4130NO, 4630, 4630O, 4830, 5030 Prior to 05/1993	Power Steering Pump w/ Flat Face Fittings	AME8NN3K514BA	\$ 520.00	
4100, 4600, 4610, 4630, 5100, 5600, 6610, 7100, 7600, 7610	Power Steering Pump, Reservoir Style Used w/ Flare Fittings	AME6NN3K514PA99	\$ 270.00	
4200, 5200, 7200	Power Steering Pump, Non-Reservoir Style 3.50 GPM at 1100 PSI Replaces 81851286	AMC7NN3A674G	\$ 750.00	
4610V 04/88-04/89, 5610, 5900, 6610, 66100	Power Steering Pump, Reservoir Style Replaces E4NN3K514AA, E4NN3K514AB, E6NN3K514AA	AME6NN3K514AB	\$ 308.50	
6710, 7710, 7910, 8210	Power Steering Pump, Reservoir Style	AME6NN3K514TA	\$ 775.00	
8000, 8600, 9000, 9600	Power Steering Pump, Reservoir Style Replaces D2NN3A674B, D3NN3A674B	AMD6NN3K514B	\$ 1045.00	
8000, 8600, 8700, 9000, 9600, 9700 1968-02/73	Power Steering Pump, Non-Reservoir Style 4.20 GPM at 1500 PSI	AMC7NN3A674B	\$ 560.00	
8530, 8630, 8730, 8830, TW30, TW35	Power Steering Pump Replaces 3924997, 83924997, D8NN3K514JD	AMD8NN3K514JC	\$ 525.00	
8700, 9700, TW5, TW10, TW15, TW20, TW25	Power Steering Pump, Reservoir Style Replaces D6NN3A674B, D7NN3A674H, D7NN3K514G, E0NN3K514AA	AME0NN3K514AB	\$ 560.00	
8730, 8830, 9700 08/1978 and Later, TW30, TW35	Power Steering Pump, Reservoir Style Replaces D8NN3K514JC	AMD8NN3K514JD	\$ 690.00	
Ind: 445, 445A, 445C, 445D, 450, 545A, 545C, 545D	Power Steering Pump, Reservoir Style Flows 2.74 GPM at 1600 PSI, 1000 RPM 5/8" Port Diameter	AME7NN3K514CA	\$ 480.00	

Ford® / New Holland®—Tractor

Application	Description	Part Number	Retail Price	Core
Ind: 4000, 4500	Power Steering Pump, Reservoir Style Flows 2.74 GPM at 1250 PSI, 1000 RPM Replaces 83928652, D8NN3K514KB, D8NN3K514KC	AMD8NN3K514C	\$ 867.50	
2000, 3000, 3600, 3610 - w/ 3 Cylinder Engines	Power Steering Conversion Kit Kit includes oil reservoir, hydraulic steering pump, cylinder bracket, steering cylinder & valve, tie rod and hoses	AMX47103	\$ 995.00	
5000 Series w/ 4 Cylinder Engines, 5600, 6600, 6610	Power Steering Conversion Kit Kit includes oil reservoir, hydraulic steering pump, cylinder bracket, steering cylinder, drag link, 5/8" hose clamp, 5/16" pressure hose and 3/8" return hose	AMX47102	\$ 535.00	



Power Steering Orbit Motors

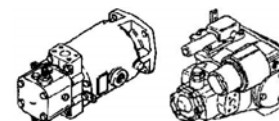

Application	Description	Part Number	Retail Price	Core
500, 555, (700, 755, 800, 825, 850, 900, 950 - All Series II)	Power Steering Orbit Motor 5-Line, Ross Style Pump	AMV53616	\$ 1795.00	
756, 836, 846, 856, 876	Power Steering Orbit Motor 4-Line, Char-Lynn Style Pump	AMV90159	\$ 2050.00	
835, 855, 875, 895, 945, 950, 955, 975	Power Steering Orbit Motor 4-Line, Ross Style Pump	AMV72318	\$ 1950.00	
5110, 5610, 5610S, 5900, 6410, 6610, 6610O, 6610S, 6810, 6810S, 7610, 7610O, 7700, 7710, 7810, 7810S	Power Steering Orbit Motor w/ Relief Valve Replaces 83948972, 86602590, E4NN3A244AA	AM86602557	\$ 705.00	
8000, 8700, 9000, 9700, TW10, TW20, TW30	Power Steering Orbital Motor Roll-Pin Style Replaces 81875266, E3NN3A244CB	AM86585453	\$ 1250.00	
(3230, 3430, 3930, 4130, 4630, 4830, 5030, 7010, 8010 - 10/1996 and Later), 5640, 6640, 7740, 7840, 8240, 8340, TD80D, TD90D, TD95D, TD5030, TD5050, TL70, TL80, TL80A, TL90, TL90A, TL100, TL100A, TS90, TS100, TS100A, TS110, TS110A, TS115, TS115A, TS130A, TT55, TT65, TT75, Ind: (345D, 445D, 545D ASN A442030)	Orbital Steering Motor Seal Kit Replaces 82010262	AM9966147	\$ 93.00	





Hydrostats and Components

Application	Description	Part Number	Retail Price	Core
276 Versatile® Bi-Directional	Reman Hydrostat 2-Piece Eaton Hydrostat	H276E-46/46	\$ 3550.00	\$ 500.00

Transmission Components









Application	Description	Part Number	Retail Price	Core
 231, 335, 340, 445, 531, 540, 2000, 2310, 2600, 2610, 2810, 2910, 3000, 3400, 3500, 3600, 3610, 3910, 4000, 4000SU, 4500, 4600SU, 4610	Shift Cover w/ Levers Replaces 82004680	AMC5NN7211F	\$ 85.00	
 (2000, 2100, 2110, 2120, 2150, 2300, 2310, 2600, 3000, 3055, 3100, 3110, 3120, 3150, 3190, 3300, 3310, 3330, 3400, 3500, 3550, 3600, 3900, 4000, 4100, 4110, 4140, 4200, 4330, 4340, 4400, 4410, 4500, 4600 - w/ 3 Cylinder Engine), Ind/Const: 231, 233, 333, 335, 420, 515, 531, 532, 533	Shift Lever 13 1/4" Long	AMC7NN7210AD	\$ 39.00	

Ford® / New Holland®—Tractor





Application	Description	Part Number	Retail Price	Core
 8N 1948-52	Countershaft	AM8N7111	\$ 170.00	
 8N, 600, 800, 900, 2000, 4000, NAA	2nd Mainshaft Gear	AMB9NN7A381B	\$ 121.00	
 2000, 2310, 2600, 2610, 3000, 3600, 3610, 3910, 4000, 4110, 4600, 4610	Main Drive Bearing Retainer For Models with Transmission Drive PTO or w/o PTO	AMC5NN7050A	\$ 90.00	
 2000, 2600, 2810, 2910, 3000, 3600, 3910, 4000, 4110, 4600, 4610	PTO Input Shaft w/ IPTO	AMD1NN772B	\$ 308.00	
 5000 Series, 5600, 5700, 6600, 6700, 7000 Series, 7600, 7700	Main Input Shaft 19.125" Long, 25 Spline For Models w/o Dual Power Transmissions	AMC5NN7017A	\$ 101.00	
 5610, 5900, 6610, 6710, 7610, 7710 - 1981-4/84	Main Input Shaft 19.22" Long, 20 Tooth, 10 Spline For Models w/ 8 Speed Transmissions w/o Dual Power	AME0NN7017HA	\$ 173.00	
 5110, 5610, 5610S, 5640, 6610, 6610O, 6610S, 6640, 6640O, 6710, 6810, 7010, 7610, 7610O, 7610S, 7710, 7740, 7740O, 7910, 7810S, 7840, 7840O, 8010, 8240, TB100, TB110, TB120, TS90, TS100, TS110	Main Input Shaft 19.22" Long, 20 Tooth, 10 Splines For 5/1984 and Later Models w/ 8X2 Transmissions w/o Dual Power, Non-Synchro	AME2NN7017EA	\$ 195.00	
 2000, 3000, 4000 Series, 2310, 2600, 2610, 3600, 3610	Rear Mainshaft 30 Tooth, 17/28 Splines	AMC5NN7C095D	\$ 315.00	
 Early 5000, 7000 Series	Mainshaft 30/16 Tooth	AMC5NN7C094A	\$ 325.00	
 (5000 Series, 7000 Series - w/ 7 & 8 Speed Transmission, 1968 and Later), (5600, 5700, 6600, 6700 - w/ IPTO), (5610, 6610, 6710 - 1981-04/84)	Mainshaft 9.937" Long, 30 Tooth, 18/16 Splines For Models w/o Dual Power	AMC9NN7C094B	\$ 319.00	
 230A, 231, 233, 234, 333, 334, 335, 530A, 531, 2000 Series, 2100, 2110, 2120, 2300, 2310, 2600, 2600N, 2600R, 2600V, 2610, 2610V, 3000 Series, 3100, 3110, 3120, 3190, 3300, 3310, 3330, 3400, 3500, 3600, 3600N, 3600NO, 3600R, 3600V, 3610, 3610NO, 3610V, 4000 Series, 4110, Ind: 3500 - All w/ Transmission Drive PTO	Countershaft 28 Tooth, 23 Internal Spline and 26 External Spline For Models w/ Transmission Drive PTO	AMC5NN7111M	\$ 70.00	
 (5610, 6610, 7610, 7710 - Prior to 1984 w/ 8-Speed Non-Synchro Transmission w/o Dual Power), Ind/Const: 5550 Series Prior to 10/1970	Countershaft 11.75" Long, 28/30 Tooth, 20/17 Spline	AMC9NN7111B	\$ 69.00	
 230A, 231, 233, 234, 333, 334, 335, 530A, 531, 2000 Series, 2100, 2110, 2120, 2300, 2310, 2600, 2600N, 2600R, 2600V, 2610, 2610V, 3000 Series, 3100, 3110, 3120, 3190, 3300, 3310, 3330, 3400, 3500, 3600, 3600N, 3600NO, 3600R, 3600V, 3610, 3610NO, 3610V, 4000 Series, 4110, Ind: 3500 - All w/ Dual Range 8-Speed Transmissions	Countershaft Gear 30/56 Tooth	AMC5NN7113D	\$ 284.00	
 2000, 3000, 4000 Series, 2110, 2120, 2300, 2310, 2600, 2610, 2810, 2910, 3110, 3120, 3190, 3230, 3310, 3330, 3400, 3430, 3600, 3610, 3910, 3930, 4100, 4110, 4130, 4140, 4190, 4200, 4330, 4340, 4400, 4410, 4600, 4610, 4830, 5000 Series, 5100, 5110, 5190, 5200, 5340, 5600, 5610, 5640, 5700, 6600, 6610, 6640, 6700, 6710, 6810, 7000 Series, 7010 ASN 850001M, 7100, 7200, 7600, 7610, 7700, 7710, 7740, 7810, 7840, 8010 ASN 800001M, 8240, TS90, TS100, TS110	Output Gear Assembly 28/49 Tooth For most 3, 4 and 6 Cylinder Tractors w/ 7 or 8 Speed Transmissions	AME6NN7145AA	\$ 350.00	

Prices Subject to Change without Prior Notice. The use of original equipment manufacturer (OEM) part numbers or trademarks, e.g. Case® and John Deere®, are for reference purposes only and for indicating product use and compatibility. Our company and the listed replacement parts contained herein are not sponsored, approved or manufactured by the OEM. All parts are New unless designated Reman in the description.

Ford® / New Holland®—Tractor

	Application	Description	Part Number	Retail Price	Core
	(3000, 4000 Series - w/ 8 Speed Transmission 1965-9/65), (5000, 7000 Series - w/ 7 Speed Transmission 1965-3/68 or 8 Speed Transmission 1965-9/65)	1st Gear 49/28 Tooth	AMC5NN7N100A	\$ 95.00	
	(230A, 231, 233, 234, 250C, 260C, 333, 334, 335, 340, 340A, 340B, 345D, 445, 445A, 445D, 2000 Series, 2100, 2110, 2120, 2300, 2310, 2600, 2610, 2810, 2910, 3000 Series, 3100, 3110, 3120, 3190, 3230, 3300, 3310, 3400, 3430, 3600, 3610, 3910, 3930, 4000 Series, 4100, 4110, 4130, 4140, 4190, 4200, 4330, 4340, 4400, 4410, 4500, 4600, 4610, 4630 - 09/1965 and Later w/ 3 Cylinder Engine and 8-Speed Transmission), (515, 530A, 531, 532, 540, 540A, 540B, 545, 545A, 545D, 4830, 5000 Series, 5030, 5100, 5110, 5190, 5200, 5340, 5600, 5610, 5700, 6600, 6610, 6700, 6710, 6810, 7000 Series, 7100, 7200, 7600, 7610, 7700 - 09/1965 and Later w/ 4 Cylinder Engine and 7-Speed or 8-Speed Transmission), Ind: (3500, 3550 - 09/1965 and Later w/ 3 Cylinder Engine and 8-Speed Transmission)	1st Gear 46/28 Tooth Replaces C5NN7N100C	AME6NN7N100AA	\$ 205.00	
	2000, 2310, 2610, 3000, 3600, 3610, 4000	2nd Gear 28/43 Tooth Replaces C5NN7102A	AMC5NN7102F	\$ 185.00	
	(2810, 2910, 3910, 4110, 4610 - w/ Non-Synchro Transmission 1981-02/89), 4100, 4600, (5000, 5100, 5200, 5340, 7000, 7100, 7200 - 1973 and Later w/ Independent PTO w/ Dual Power), (5110, 5610, 6610, 6710, 6810, 7610, 7710, 7810 - w/ Non-Synchro Transmission), 5600, 5640, 5700, 6600, 6700, 7010 ASN 850001M, (7600, 7700 - w/ Independent PTO w/ or w/o Dual Power), 7740, 7840, 8010 ASN 800001M, 8240, TB100, TB110, TB120, TS90, TS100, TS110, Ind/Const: 340, (340A, 445 - 1982-05/85), (340B, 540A - 1982 and Later), 420, 445A, 515, 532, 540, (540B, 545A - 06/1985-07/87), 545	2nd Gear 28/43 Tooth w/ 8 Speed Transmission	AME6NN7N101BA	\$ 143.00	
	2000, 2310, 2600, 2610, 3000, 3600, 3610, 4000	3rd Gear 28/35 Tooth	AMC5NN7B340A	\$ 105.00	
	4000 Series, 4100, 4140, 4190, 4200, 4330, 4340, 4400, 4410, 4500, 5000 Series, 5100, 5110 w/ Dual Power, 5190, 5200, 5340, 5600, 5610, 5700, 6600, 6610, 6700, 6710, 6810	3rd Gear 28/35 Tooth w/ 7 or 8 Speed Transmissions	AME6NN7N315AA	\$ 150.00	
	3000, 3600	Reverse Gear 28/32 Tooth	AMC5NN7K013E	\$ 107.00	
	(5000 Series, 5100 - 10/1970 and Later w/ 8-Speed Transmissions), (5110, 5190, 5200, 5340, 5600, 5700, 6600, 6600C, 6600O, 6700 - w/ 8-Speed Transmissions), (5610, 6610, 6610O, 6710, 6810, 7610, 7610O, 7710, 7810 - Tractors), (5610S, 6610S, 7610S, 7810S, TB100, TB110, TB120 - w/ 8-Speed Transmissions and Creeper Gear Countershaft), (5640, 6640, 7740, 7740O, 7840, 7840O, 8240 - Prior to 10/1992 w/ 8-Speed Transmissions), (7010, 8010 - w/ 8-Speed Transmissions and Creeper Gear Countershaft, ASN 850001M), Ind/Const: 345C, 345D, 445C, 445D, 545C, 545D, 5500 Series Backhoe	Secondary Countershaft 35 Tooth, 16 Spline For Models w/ 8 Speed Non-Synchro Transmissions	AMC9NN7113B	\$ 185.00	
	2000, 3000, 4000 Series, 2310, 2600, 2610, 2810, 2910, 3230, 3600, 3610, 3910, 3930, 4600, 4610, 4630, 4830, 5000 Series, 5600, 5610, 5640, 5700, 6600, 6610, 6640, 6700, 6710, 7000 Series, 7600, 7610, 7700, 7710, 7810, 7740, 8240, TS90, TS100, TS110	Countershaft Gear Coupling Sliding, 21 Tooth For Models w/ 8 Speed Non-Synchro Transmissions	AME0NN7106BA	\$ 60.00	

Ford® / New Holland®—Tractor

Application	Description	Part Number	Retail Price	Core
 2000, 3000, 4000 Series, 2310, 2610, 2810, 2910, 3230, 3610, 3910, 3930, 4110, 4330, 4610, 4630, 4830, 5000 Series, 5030, 5610, 5640, 6610, 6640, 7000 Series, 7010, 7610, 7710, 7740, 7840, 8010, 8240, Dexta, Super Dexta, TS90, TS100, TS110	Front Gear Shift Coupling Assembly 28 Tooth, 17 Spline For most Models w/ 6, 7 or 8 Speed Transmissions	AME6NN7N072AA	\$ 50.00	
 2000 Series, 2100, 2110, 2600, 2610, 2810, 2910, 3000 Series, 3100, 3230, 3330, 3400, 3430, 3500, 3550, 3600, 3610, 3900, 3910, 3930, 4000 Series, 4100, 4110, 4130, 4140, 4190, 4200, 4330, 4340, 4400, 4410, 4500, 4600, 4610, 4630, 4830, 5000 Series, 5030, 5100, 5110, 5190, 5200, 5340, 5600, 5610, 5640, 5700, 6600, 6610, 6640, 6700, 6710, 6810, 7000 Series, 7010 ASN 850001M, 7100, 7200, 7600, 7610, 7700, 7710, 7740, 7810, 7840, 8010 ASN 800001M, 8240, TS90, TS100, TS110	Rear Gear Shift Coupling Assembly 28 Tooth, 20 Spline	AME6NN7N072BA	\$ 95.00	
 2000, 2100, 2600, 3000, 3100, 3400, 3500, 3550, 3600, 3900, 4100, 4200, 4400, 4410, 6710, 6810, 7100, 7600, 7610, 7700, 7710, 8000, 8700, 9000, 9700, TW10, TW20, TW30	Clutch Pedal Return Spring	AMC7NN7N598A	\$ 6.00	
 2100, 2110, 2300, 3000, 3100, 3120, 3190, 3310, 3400, 3600, 3610, 4110	Main Input Shaft 17.75" Long, 19 Tooth, 10 Spline	AMC7NN7017AB	\$ 110.00	
(T7.220, T7.235, T7.250, T7.260 - Power Command)	Friction Disc, Transmission Engagement Clutch	AM5163844	\$ 11.00	

Transmission Discs

Application	Description	Part Number	Retail Price	Core
8160, 8260, 8360, 8560, (T6030, T7040 - Power Command), (T6050, T6070, T6080, T6090, T7.170 - Range Command and Power Command), (T7030, T7050, T7060, T7.185, T7.200, T7.220, T7.230, T7.235, T7.245, T7.260 - Excluding Auto Command), T7.165, T7.165S, (T7.175, T7.190, T7.225 - Excluding Auto Command MY15, MY18), (T7.210 Excluding Non Tier 4B Auto Command and Tier 4B Auto Command MY15, MY18), T7.215S, TM115, TM120, TM125, TM130, TM135, TM140, TM150, TM155, TM165, TM175, TM190	Transmission Clutch Pack Includes (6) Inner Spline Discs and (6) Outer Spline Discs Replaces 5167875, 5167876	AM87530788	\$ 77.00	
8160, 8260, 8360, 8560, T6030, T6050, T6070, T6080, T6090, T7.165, T7.170, T7.175, T7.185, T7.190, T7.200, T7.210, T7.225, TM115, TM120, TM125, TM130, TM135, TM140, TM150, TM155, TM165	Transmission Clutch Pack Please verify model year and serial number for fit before ordering Includes (8) Inner Spline Discs and (8) Outer Spline Discs	AM87530796	\$ 144.00	
T6030, T6050, T6070, T6080, T6090, T7030, T7040, T7050, T7060, T7.165, T7.170, T7.175, T7.185, T7.190, T7.200, T7.210, T7.220, T7.225, T7.230, T7.235, T7.245, T7.250, T7.260, TM120, TM130, TM140, TM155, TM175, TM190	Transmission Clutch Pack Please verify model year and serial number for fit before ordering Includes (8) Inner Spline Discs and (8) Outer Spline Discs Replaces 5165058, 5165059	AM87530789	\$ 116.00	

PTO Assembly Components

Application	Description	Part Number	Retail Price	Core
TM120, TM130, TM155, TM175, TM190	PTO Damper Replaces 47126791, 47127097	AM87302871	\$ 256.00	
231, 233, 234, 333, 334, 335, 340, 531, 535, 2000 1965 and Later, 2100, 2110, 2120, 2150, 2300, 2310, 2600, 2610, 2810, 2910, 3000, 3055, 3100, 3110, 3120, 3150, 3190, 3300, 3310, 3330, 3400, 3600, 3610, 3910, 4000 1965 and Later, 4100, 4110, 4190, 4200, 4330, 4340, 4400, 4410	PTO Shifter Fork Replaces 81801836	AMC5NN720A	\$ 15.00	
TL70, TL70A, TL80, TL100, TL100A	PTO Clutch Disc 44 Spline, 3.85" ID, 5.23" OD, 0.059" Thick	AM5165950	\$ 10.00	
(TL70, TL80, TL90, TL100 BSN C4738)	Separator Plate, PTO Clutch	AM5165954	\$ 7.00	

Ford® / New Holland® —Tractor

Application	Description	Part Number	Retail Price	Core
T6010, T6020, T6030, T6050, T6060, T6070, T6080, T6090, T7030, T7040, T7050, T7060, T7070, T6.120, T6.125, T6.140, T6.145, T6.150, T6.155, T6.160, T6.165, T6.175, T6.180, T7.165, T7.170, T7.175, T7.185, T7.190, T7.200, T7.210, T7.220, T7.225, T7.230, T7.235, T7.245, T7.250, T7.260, T7.270, T7.290, T7.315 Excluding Tier 4B MY18, TM175, TM190, TS100A, TS110A, TS115A, TS130A, TS135A	Friction Disc, PTO Clutch	AM5163844	\$ 11.00	
3600, 4100, 4600, 5000, 5100, 5110, 5600, 5610, 5610S, 5640, 5900, 6000, 6410, 6600, 6610, 6610S, 6640, 6700, 6710, 6810, 7000, 7010, 7100, 7410, 7600, 7610, 7610S, 7700, 7710, 7740, 7810, 7810S, 7910, 8000, 8010, 8200, 8210, 8340, 8600, 8670, 8670A, 8770, 8770A, 8870, 8870A, 8970, 8970A, 9000, 9200, 9600, 9700, TW10, TW20	PTO Brake Band Replaces 81819772, 83924796, 83956644, 89845550, C7NNB726D, E0NNB726AA	AME0NNB726AB	\$ 38.00	

PTO Shafts and Hubs

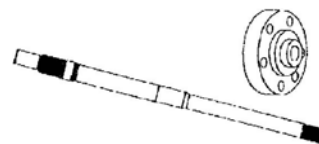

Application	Description	Part Number	Retail Price	Core
5000, 5100, 5110, 5600, 5610, 5900, 6410, 6600, 6610, 6700, 6710, 6810, 7100, 7200, 7600, 7610, 7700, 7710 - w/ 8 Speed Non-Synchro Transmissions	PTO Shaft - Internal PTO Drive 39.87" Long, 20 & 25 Spline Requires AME1NNN777AB 20 Spline PTO Hub when replacing C5NN7A684A 15 Spline Shaft	AME4NN7A684AA	\$ 357.00	
5000, 5600, 5610, 5700, 6600, 6610, 6700, 6710, 7000 Series, 7600, 7610, 7700, 7710	PTO Shaft - Internal PTO Drive 25.40" Long, 21 & 25 Spline	AMC5NNA701A	\$ 130.00	
8000, 8200, 8400, 8600, 8700, 9200, 9600, 9700	PTO Shaft - Internal PTO Drive 37.50" Long, 2 Sets of Splines, 22 & 25 Spline Use w/ AMD8NNN778AA PTO Hub	AMD8NN7A684BA	\$ 403.00	
8000, 8200, 8400, 8600, 8700, 9200, 9600, 9700	PTO Shaft - Internal PTO Drive 37.562" Long, 20 Spline Use w/ AME1NNN777AB PTO Hub	AMC9NN7A684A	\$ 551.00	
8000, 8700, 9000, 9700	PTO Shaft - Internal PTO Drive 37.50" Long, 20 Spline Use w/ AME1NNN777AB PTO Hub	AMC7NN7A684D	\$ 459.00	
T6010, T6020, T6030, T6040, T6050, T6060, T6070, T6080, T6090, T7030, T7040, T7050, T7060, T7070, T6.120, T6.140, T6.150, T6.155, T6.160, T6.165, T6.175, T7.185, T7.200, T7.210, T7.220, T7.235, T7.250, T7.260, T7.270, TM115, TM120, TM125, TM130, TM135, TM140, TM150, TM155, TM165, TM175, TM190, TS100A, TS110A, TS115A, TS125A, TS130A, TS135A	PTO Shaft 540 RPM, 6 Tooth Front Spline Replaces 5182612, 5182613	AM47130743	\$ 192.00	
TW10, TW20, TW30	PTO Shaft - Internal PTO Drive 37.50" Long, 3 Sets of Splines, 22 & 25 Spline Use w/ AMD8NNN778AA PTO Hub	AMD8NN7A684AB	\$ 373.00	
TM120, TM175, TS125A	PTO Shaft 1000 RPM, 21 Spline, 1 3/8" Spline Diameter	AM47130744	\$ 128.00	
5000 Series, 5100, 5110, 5600, 5610, 5640, 5700, 5900, 6600, 6610, 6640, 6700, 6710, 6810, 7000 Series, 7010, 7100, 7200, 7410, 7600, 7610, 7700, 7710, 7740, 7810, 7840, 7910, 8010, 8210, 8240, 8400, 8600, 8700, 9000, 9200, 9600, 9700, TS90, TS100, TS110	PTO Hub 20 Spline Use w/ AMC7NN7A684D & AMC9NN7A684A PTO Shafts	AME1NNN777AB	\$ 71.00	
5000, 5110, 5600, 5610, 5900, 6410, 6600, 6610, 6700, 6710, 6810, 7000, 7600, 7610, 7700, 7710	PTO Hub 15 Spline	AMC5NNN777A	\$ 50.00	
8000 Series, 8200, 8400, 8530, 8600, 8630, 8700, 8730, 8830, 9000 Series, 9200, 9600, 9700, TW5, TW10, TW15, TW20, TW25, TW30, TW35	PTO Hub 22 Spline Use w/ AMD8NN7A684BA & AMD8NN7A684AB PTO Shafts	AMD8NNN778AA	\$ 149.00	
233, 234, 333, 334, 335, 515, 2100, 2110, 2120, 2300, 2310, 2600, 2600N, 2600R, 2600V, 2610, 2610V, 3055, 3100, 3110, 3120, 3300, 3310, 3400, 3500, 3550, 3600, 3600N, 3600NO, 3600R, 3600V, 3610, 3610NO, 3610V, 4100, 4110, 4140, 4190, 4200, 4330, 4340, 4400, 4410, 4500	PTO Countershaft Replaces 81801786	AMC5NN702A	\$ 23.65	

Ford® / New Holland®—Tractor







PTO Clutch Parts

Application	Description	Part Number	Retail Price	Core
5000, 5100, 5200, 5340, 5600, 5610, 5700, 5900, 6600, 6610, 6700, 7000, 7100, 7200, 7600, 7610, 7700, 7710	PTO Clutch Pack 3 5/8" Overall Height Includes (4) Friction Discs Replaces 83903939, D5NNN707A	AMD2NNN751D	\$ 225.00	
5000, 5100, 5200, 5340, 5600, 5700, 5900, 6600, 6700, 7000, 7100, 7200, 7600, 7700	PTO Clutch Pack 4-Plate, Preloaded Housing Includes (3) Friction Discs Replaces 83908229, D3NNN751D, D5NNN707A	AMD5NNN751A	\$ 256.00	
5110, 5610, 5610S, 5640, 5900, 6410, 6610, 6640, 6710, 6810, 7410, 7610, 7710, 7740, 7810, 7840, 7910, 8100, 8210, 8240, 8340, TB80, TB85, TB90, TB100, TB110, TB120, TS90, TS100, TS110	PTO Clutch Pack 3 7/8" Overall Height Includes (5) Friction Discs Replaces 81871420, E0NNN751BB	AME0NNN751BA	\$ 225.00	
8530, 8630, 8730, 8830, TW5, TW15, TW25, TW35	Dual Power Clutch Plate External Spline, 4.495" ID, 6.058" OD Replaces 83934543, 83958329, 89823827	AM83958330	\$ 13.00	
8670, 8670A, 8770, 8770A, 8870, 8870A, 8970, 8970A	PTO Clutch Plate External Spline, 4.495" ID, 6.058" OD Replaces 83934543, 83958329, 89823827	AM83958330	\$ 13.00	
5000 Series, 5600, 5610, 5700, 6600, 6610, 6700, 6710, 7000 Series, 7600, 7610, 7700, 7710, 7810	PTO Drive Clutch Hub 25/52 Tooth, 10-Plate Hub	AMF1NNN750AA	\$ 180.00	
5610S, 5640, 6610S, 6640, 7010, 7740, 7840, 8240, 8340, TB80, TB85, TB90, TB100, TB110, TB120, TS90, TS100, TS110, TS115, TS6000, TS6020, TS6030, TV140, TV145, TV6070, Versatile®: (9030E, 9030V - 04/1994 and Later)	PTO Drive Clutch Hub 26 Tooth Gear, 23 Internal Spline, 52 External Spline Replaces 83999197, 83999198, E9NNN750AB	AM81865535	\$ 183.00	
5000 Series, 5600, 5700, 6600, 6700, 7000 Series, 7600, 7700	PTO Drive Clutch Housing w/ Bushing When used on 5000 and 7000 Series w/ Single Speed PTO, Replacing C9NN7R007A Direct Drive Housing Plate w/ D5NN7R007A Drive Housing Plate Is Required	AMD5NNN707A	\$ 200.00	
2000, 2310, 2600, 2610, 2810, 2910, 3000, 3600, 3610	PTO Clutch Sleeve Replaces 81801828	AMC5NN717A	\$ 227.00	
5000 Series, 7000 Series	PTO Drive Clutch Valve Support w/ Relief Hole	AMC7NNN776C	\$ 24.00	
5000 Series, 5600, 5610, 5640, 5700, 5900, 6600, 6610, 6640, 6700, 6710, 6810, 7000 Series, 7010, 7600, 7610, 7700, 7710, 7740, 7810, 8010, 8200, TS90, TS100	PTO Drive Clutch Valve Support w/o Relief Hole	AMD2NNN776A	\$ 25.00	
5110, 5610, 5610S, 5640, 6610, 6610S, 6640, 6710, 6810 1981 and Later, (7010, 8010 ASN 850001M), 7610, 7710, 7740, 7810, 7810S, 7840, 7910, 8000, 8200, 8210, 8240, 8530, 8600, 8630, 8700, 8730, 8830, 9000, 9200, 9600, 9700, TB80, TB85, TB90, TB100, TB110, TB120, TS90, TS100, TS110, TW5, TW10, TW15, TW20, TW25, TW30, TW35	Internal Spline Plate Replaces 81870603, 83934543, 83958329	AM83925696	\$ 11.95	

Ford® / New Holland® —Tractor

Differentials and Components

Application	Description	Part Number	Retail Price	Core
2000 Series, 2310, 2600, 2610, 2810, 2910, 3000 Series, 3230, 3600, 3610, 3900, 3910, 3930, 4000 Series, 4600, 4610, 4630, 4830, 5000 Series, 5030, 5600, 5610, 5640, 5700, 6600, 6610, 6640, 6700, 7000 Series, 7010, 7600, 7610, 7700, 7710, 7740, 7810, 7840, 8240, TB100, TB110, TB120, TS90, TS100, TS110, TS115	 Side Gear w/ Smooth Outer Surface	AM81803445	\$ 85.00	
	 Side Gear w/ Splined Outer Surface	AM81803451	\$ 100.00	
	 Differential Spider Replaces C5NN4211A	AM81876885	\$ 90.00	
	 Differential Pinion Gear	AM81728114	\$ 35.00	
	 Pinion Thrust Washer	AM508E4230A	\$ 3.50	

Rear Axles and Components

Application	Description	Part Number	Retail Price	Core
8N, NAA 1948-54	Rear Axle Shaft	AM8N4235B	\$ 147.00	
5000, 5600, 5700, 6600, 6700, Ind: 650, 5500, 6500	Rear Axle Shaft	AMC5NN4244N	\$ 225.00	
8N, NAA, NAB	Rear Axle Hub	AM8N1171	\$ 102.00	

PTO Output Shafts

Application	Description	Part Number	Retail Price	Core
600, 700, 800, 900	PTO Output Shaft Conversion Kit Converts PTO Output Shaft from 1 1/8" to 1 3/8" Includes PTO Output Shaft, Shaft Cover, Front Bearing, Seals, Snap Rings, Collar and Tapered Pin	AMNCA700-38	\$ 107.00	
NAA 1953-54	PTO Output Shaft Conversion Kit Converts PTO Output Shaft from 1 1/8" to 1 3/8" Includes PTO Output Shaft, Shaft Cover, Front Bearing, Seals, Gasket, Snap Rings, Collar and Tapered Pin	AMNAA700-38	\$ 125.50	
2N, 8N, 9N	PTO Output Shaft Includes 1 3/8" Shaft, Front Bearing, Seals and Snap Rings	AM9N700-38	\$ 95.00	
2000, (2310, 2610, 2810, 2910, 3610, 3910 - 1981-04/83), 2600, 3000, 3600, 4000 Series	PTO Output Shaft, 540 RPM 10 Tooth, 6 Spline 29.46" Long, 1.375" Spline Diameter	AME5NNA728AA	\$ 75.00	
5000, 5100, 5200, 5600, 6600, 6700, 7000, 7100, 7200, 7600, 7700, 8000, 8600, 8700, 9000, 9600, 9700 - w/ 2 Speed PTO	PTO Output Shaft, 540 RPM 11.475" Long, 36 & 38 Tooth Drive Spline	AMD2NNB728A	\$ 120.00	
5000, 5100, 5200, 5600, 5700, 6600, 6700, 7000, 7100, 7200, 7600, 7700, 8000, 8600, 8700, 9000, 9600 - w/ 2 Speed PTO	PTO Output Shaft, 1000 RPM 11.475" Long, 38 Tooth Drive Spline	AMD2NNB728B	\$ 212.48	
5000 w/ Independent PTO, 5100, 5200, 7000 w/ Independent PTO, 7100, 7200 - w/ Single Speed PTO	PTO Output Shaft, 540 RPM 10.88" Long, 29 Tooth Drive Spline	AMD2NNN752C	\$ 161.00	
5000 Series, 5110, 5600, 5610, 5700, 5900, 6600, 6610, 6700, 6710, 6810, 7000 Series, 7600, 7610, 7700, 7710 - w/ Single Speed PTO	PTO Output Shaft, 540 RPM 12.03" Long, 29 Tooth Drive Spline	AME4NNN752AA	\$ 105.00	

Ford® / New Holland®—Tractor

Application	Description	Part Number	Retail Price	Core
5100, 5110, 5600, 5610, 5640, 5900, 6410, 6600, 6610, 6640, 6700, 6710, 6810, 7100, 7600, 7610, 7700, 7710, 7740, 7810, 7840, 7910, 8000, 8210, 8240, 8340, 8670, TW5, TW10, TW15, TW20, TW25 - w/ 2 Speed PTO	PTO Output Shaft, 540 RPM 11.719" Long, 8 Tooth Drive Spline	AME6NNB728AA	\$ 149.00	
5100, 5110, 5600, 5610, 5640, 5900, 6410, 6600, 6610, 6610S, 6640, 6700, 6710, 6810, 7100, 7600, 7610, 7700, 7710, 7740, 7810, 7840, 7910, 8000, 8210, 8240, 8340, 8670, 8700, 9700, TS100, TW5, TW10, TW15, TW20, TW25	PTO Output Shaft, 1000 RPM 11.719" Long, 8 Spline Replaces 86511620, D8NNB728BA	AMD8NNB728BC	\$ 213.00	
8670, 8670A, 8770, 8770A, 8870, 8870A, 8970, 8970A	PTO Output Shaft, 1000 RPM 20 Spline, 1 3/4" Diameter	AM9840406	\$ 342.00	
	PTO Output Shaft, 1000 RPM 21 Spline, 1 3/8" Diameter	AM9843942	\$ 415.00	

PTO Adapters

Application	Description	Part Number	Retail Price	Core
Tractors up to 70HP	PTO Adapter Small 540 to 1000 Spline, 4 1/8" Overall Length Changes PTO from 1 3/8" x 6 spline to 1 3/8" x 21 spline and extends the PTO shaft 4 1/8"	AMX59112	\$ 40.00	
Tractors up to 70HP	PTO Adapter Small 1000 to 540 Spline, 6 3/8" Overall Length Reduces PTO from 1 3/8" x 21 spline to 1 3/8" x 6 spline and extends the PTO shaft 4 1/8"	AMX59108	\$ 40.00	
Tractors up to 100HP	PTO Adapter Large 1000 to 540 Spline, 7 1/2" Overall Length Reduces PTO from 1 3/4" x 20 spline to 1 3/8" x 6 spline and extends the PTO shaft 4 5/8"	AMX59109	\$ 71.00	
Tractors up to 100HP	PTO Adapter Large 1000 to Small 1000 Spline, 7" Overall Length Reduces PTO from 1 3/4" x 20 spline to 1 3/8" x 21 spline and extends the PTO shaft 4 5/8"	AMX59110	\$ 71.00	



PTO Gears

Application	Description	Part Number	Retail Price	Core
5610, 5610S, 5640, 6610, 6610S, 6640, 6710, 7010S, 7610, 7610S, 7710, 7740, 7810, 7810S, 7840, 7910, 8210, 8240, 8340	PTO Drive Gear - Double For 540 & 1000 RPM 2-Speed Independent PTO, 20 & 41 Tooth Drive Gear	AME0NN745AA	\$ 130.00	
	PTO Driven Gear - 1000 RPM For 540 & 1000 RPM 2-Speed Independent PTO, 8 Splines, 84 Tooth - Helical	AME0NNA726BA	\$ 430.00	
	PTO Driven Gear - 540 RPM For 540 & 1000 RPM 2-Speed Independent PTO, 70 Tooth	AME0NNA726AD	\$ 325.00	
5000, 5600, 5610, 5700, 6600, 6610, 6700, 6710, 7000 Series, 7600, 7610, 7700, 7710	PTO Driven Gear 81 Tooth Gear, 10 1/8" Outside Diameter	AMC5NNA726A	\$ 225.00	



Brake Shoes

Application	Description	Part Number	Retail Price	Core
8N, NAA	Brake Shoe Set Set of 4	AM8N2200B	\$ 46.00	
501, 600, 700, 800, 900, (2000, 4000 - w/ 4 Cylinder Engine)	Brake Shoe Set Set of 4	AMNCA2218B	\$ 29.00	
2N, 9N	Brake Shoe Replaces 9N2219A	AM9N2019	\$ 40.00	

Ford® / New Holland®—Tractor

Application	Description	Part Number	Retail Price	Core
231, 335, 2000, 2110, 2310, 2600, 2610, 3000, 3400, 3500, 3600, 3610, Ind: 3500 - All w/ 3 Cylinder Engines	Brake Shoe 2" Wide, Sold Individually (2) Required Per side When Converting 1 1/2" Wide Shoes to 2" Wide Shoes, (8) 957E2069A Pins Are Required	AMC7NN2218A	\$ 20.00	
2000, 2600, 2610, (3000, 4110 - 12/1966 and Later), 3600, 3610	Brake Shoe 1 1/2" Wide, Sold Individually (2) Required Per Side	AMD9NN2218AA	\$ 28.00	

Brake Components

Application	Description	Part Number	Retail Price	Core
Models w/ Internal Wet Brakes	Brake Rod Seal	AM86576339	\$ 3.00	
8N	Brake Drum	AM8N1126	\$ 197.00	
230A, 231, 233, 234, 333, 334, 335, 530A, 531, 2000 Series, 2100, 2110, 2120, 2300, 2310, 2600, 2600N, 2600R, 2600V, 2610, 2610V, 3000 Series, 3100, 3120, 3190, 3300, 3310, 3330, 3400, 3500, 3600, 3600N, 3600NO, 3600R, 3600V, 3610, 3610NO, 3610V, 4000 Series, 4110, Ind: 3500	Brake Drum	AMC5NN1126E	\$ 58.00	
2000, 2110, 2310, 2600, 2610, 3000, 3400, 3600, 4110, Ind/Const: 230A, 233, 234, 333, 334, 335, 530A, 531	Brake Backing Plate Replaces 81815610	AMC5NN2212D	\$ 200.00	
2810, 2910, 3100, 3900, 3910, 4100, 4110, 4600, 4610, Ind: 445, 445A, 445C, 445D, 455	Brake Plate 4.488" ID, 8.228" OD Replaces 81802536	AMC5NN2N315B	\$ 5.00	
3000 Series, 4000 Series, 5000 Series, 5600, 5610, 5900, 6600, 6610, 6810, 7000 Series, 7600, 7610, 7710, 7810	Actuator Rod	AMC7NN2466B	\$ 32.00	
5000, 5100, 5200, 5600, 5610, 5640, 5700, 5900, 6410, 6600, 6600C, 6610, 6640, 6700, 6710, 7000, (7010, 8010 ASN 800001M), 7100, 7200, 7600, 7600C, 7700, 7710, 7740, 7810, 7840, 7910, 8210, 8240, 8340, TB80, TB85, TB90, TB100, TB110, TB120, TS90, TS100, TS110, TS115, TV140, TV145, TV6070	Brake Disc 22 Tooth, 0.19" Thick, 2.086" ID, 8.819" OD Replaces 83956599, C5NN2A097A, C7NN2A097B, E6NN2A097AA	AM87518036	\$ 32.00	
5000 Series, 5600, 5610, 6600, 6610, 6710, 6700, 7000 Series, 7610, 7710, 7600, 7810, 7910, 8210	Brake Actuator Assembly	AMC7NN2N317A	\$ 104.00	
8160, 8260, 8360, 8560, (TM115, TM120, TM125, TM130, TM135, TM140, TM150, TM155, TM165 BSN C4806)	Friction Disc, Handbrake 34 Spline 4.126" ID, 7.067" OD, 0.236" Thick	AM5146036	\$ 56.00	
8160, 8260, 8360, 8560, TM115, TM120, TM130, TM135, TM140, TM150, TM155, TM165	Pressure Ring	AM5152350	\$ 140.50	
T6010, T6020, T6030, T6040, T6050, T6060, T6070, T6080, T6090, T5.95, T5.105, T5.115, T6.120, T6.140, T6.145, T6.150, T6.155, T6.160, T6.165, T6.175, T6.180, T7.170, T7.175, T7.185, T7.190, T7.200, T7.210, T7.225, T7.230, T7.245, T7.260, T7.270, TM115, TM120, TM125, TM130, TM135, TM140, TM150, TM155, TM165 ASN D4806, TS100A, TS110A, TS115A, TS125A, TS130A, TS135A	Brake Pad Single Sided, 0.131" Thick	AM5199607	\$ 14.00	
T6010, T6020, T6030, T6040, T6050, T6060, T6070, T5.95, T5.105, T5.110, T5.115, T5.120, T6.120, T6.125, T6.140, T6.145, T6.150, T6.155, T6.160, T6.165, T6.175, T6.180, TM115, TM125, TM135, TM150, TM165, TS100A, TS110A, TS115A, TS125A, TS130A, TS135A	Brake Plate Splined, 4.134" ID, 7.441" OD, 0.177" Wide	AM47127225	\$ 21.00	
T6010, T6020, T6030, T6040, T6050, T6060, T6070, T6.120, T6.140, T6.150, T6.155, T6.160, T6.165, T6.175, TS100A, TS110A, TS115A, TS125A, TS130A, TS135A	Brake Disc	AM5191497	\$ 145.00	
T6010, T6020, T6030, T6040, T6050, T6060, T6070, TS100A, TS115A, TS125A, TS135A	Brake Disc	AM47131048	\$ 425.00	
T7030, T7040, T7050, T7060, T7070, T7.220, T7.230, T7.235, T7.245, T7.250, T7.260, T7.270, TM175, TM190	Brake Plate, Separator and Parking Replaces 5196708	AM47663732	\$ 41.00	

Ford® / New Holland®—Tractor

Application	Description	Part Number	Retail Price	Core
TG210, TG230, TG255, TG285	Brake Disc, Parking 3.50 mm Thick, 6.87" ID Replaces 87776014	AM195067A2	\$ 80.00	
TL70, TL80, TL90, TL100, TM115, TM120, TM125, TM130, TM135, TM140, TM150, TM155, TM165	Master Cylinder Replaces 82006194, 82018664	AM84558759	\$ 149.00	

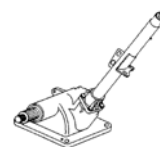

Manual Steering Gearbox Assemblies

Application	Description	Part Number	Retail Price	Core
2000, 2100, 2150, 2300, 2310, 2610, 3000, 3055, 3100, 3110, 3120, 3150, 3300, 3310, 3330, 3400, 3500, 3610, 3910, 4000, 4110, Ind: 230A, 530A	Steering Column Assembly	AME0NN3503AA	\$ 575.00	
5100, 5110, 5600, 5610, 5900, 6410, 6600, 6610, 7100, 7600 - Models w/ Cylinder under Radiator	Steering Column Assembly	AMD7NN3503A	\$ 680.00	
8N ASN 216989	Steering Gearbox	AM8N3548B	\$ 505.00	
600, 800, 2000, 3000, 4000, NAA	Steering Gearbox Arm	AM86542743	\$ 98.00	

Power Steering Gearbox Assembly and Components

Application	Description	Part Number	Retail Price	Core
5600, 6600, 7600 1975-81 w/o Cab	Steering Column Assembly For Power Steering Assembly	AME1NN3N503BC	\$ 1423.00	

Steering Shafts



Application	Description	Part Number	Retail Price	Core
8N ASN 216989, 600, 800, 2000, 4000, NAA - w/ 4 Cylinder Engines	Steering Sector Shaft, Right Hand Single, Works w/ OEM Gears	AM251293	\$ 130.00	
1300, 1500, 1700, 3000, 3600, 3900 Replaces SBA334130041, SBA34130041	Steering Sector Shaft 15/16" to 1" Taper, 5 Tooth, 36 Spline	AM38180-16120	\$ 158.50	
2000, 3000, 4000	Rocker Shaft Replaces DKN3575B	AMC9NN3575C	\$ 156.00	
2000, 2600, 3000, 3600, 3900, 4100	Manual Steering Shaft w/ Nut 26.25" Long	AMD2NN3A710B	\$ 60.00	
5000, 5100, 5110, 5600, 5610, 5900, 6410, 6600, 6610, 7410, 7700	Manual Steering Shaft w/ Nut 28.75" Long Replaces C5NN3A710B	AMD2NN3A710A	\$ 60.00	
5000, 5100, 5340, 7000, 7100	Steering Shaft 28.65" Long	AMC5NN3A710A	\$ 175.00	

Drawbars and Components

All of our drawbars are cut, drilled and heat-treated to exact design and specifications that meet or exceed OEM specifications.



Application	Description	Part Number	Retail Price	Core
2000, 2600, 2610, 2810, 2910, 3000, 3100, 3230, 3430, 3600, 3610, 3910, 3930, 4130, 4610, 4630, 4830	Drawbar 2" x 1" x 32.875" w/ 1.50" Offset, (2) 0.970" Diameter Holes: 1.75" & 3.75" from Front	AM82009197	\$ 180.00	
(2000, 3000, 4110 - w/ Swinging Drawbar), 2600, 2610, 2810, 2910, 3100, 3600, 3610, 3910, 4610	Drawbar 2" x 1" x 30.875" w/ 1.75" Offset, (2) 0.906" Diameter Holes: 1.25" & 3.25" from Front	AM86531346	\$ 65.00	

Ford® / New Holland®—Tractor

Application	Description	Part Number	Retail Price	Core
2600, 3600, 3900, 4100, 4600, Ind: 515, 532	Drawbar 2" x 1.25" x 34.625", (4) 0.937" Diameter Holes: 1.343", 3.343", 5.718" & 7.718" from Front	AMC5NN805F-SPL	\$ 70.00	
(2810, 2910, 3910, 4100, 4110, 4600 - w/ Clevis), (3230, 3430, 3930, 4130, 4630, 4830 - 07/1990 and Later), 4000 w/ 540 RPM PTO, 5030 09/1992 and Later	Drawbar 2" x 1.25" x 32.50" w/ 2.75" Offset, (2) 0.922" Diameter Holes: 1.375" & 5.75" from Front	AMC5NN805J	\$ 125.00	
3230, 3430, 3930, 4130, 4630, 4830, 5030	Drawbar 2" x 1.25" x 32.63"	AM86520237	\$ 174.00	
3900, 4000 w/ 540 or 1000 RPM PTO, 4400, 4600	Drawbar 2" x 1.25" x 34.63" w/ 2.75" Offset, (4) 0.937" Diameter Holes: 1.343", 3.34", 5.718" & 7.718" from Front	AMC5NN805F	\$ 80.00	
4100, 4600, 5000 Series, 5100, 5110, 5200, 5340, 5600, 5610, 5700, 5900, 6410, 6600, 6610, 6700, 6710, 6810, 7000 Series, 7100, 7200, 7410, 7600, 7610, 7700, 7710	Drawbar 2.344" x 1.156" x 33.125", (2) 1.18" Diameter Holes: 1.75" & 4.75" from Front	AMD2NN805A	\$ 89.00	
(5000, 7000 - 1965-06/73), 7100, 7200	Drawbar 2.25" x 1.375" x 34.75"	AMC5NN805A	\$ 115.00	
5100, 5110, 5600, 5610, 5900, 6410, 6600, 6610, 6700, 6710, 6810, 7000, 7100, 7410, 7600, 7610, 7700, 7710, 7810, 7910, 8210	Drawbar, Standard Duty 2.50" x 1.375" x 36.90", (3) 1.165" Diameter Holes: 1.25", 3.25", & 7.75" from Front For Both Single Speed & Dual Speed PTO Tractors because of the Third Hole in the Front of the Drawbar	AME0NN805AC	\$ 91.00	
5640, 6640, 7740, 7840, 8240, 8340	Drawbar 2.25" x 1.625" x 36.25", (3) 1.156" Diameter Holes at 1.25", 3.25" & 7.75" from Front For Standard Swinging Drawbar	AME9NN805AA	\$ 185.00	
7810, 78100, 7910, 8000, 8210, 8400, 8530, 8600, 8630, 8700, 8730, 8830, 9000, 9200, 9600, 9700, TW5, TW10, TW15, TW20, TW25, TW30, TW35	Drawbar 3" x 1.375" x 42.50", (2) holes at 1.125" & 3.25" from front Replaces 83902378, C9NN805A	AMD3NN805A	\$ 265.00	
8210, (8160, 8260, 8360, 8560 BSN C3857 w/ Rollers), (TS90, TS100, TS110, TS115 ASN C3855 w/ Swinging Drawbar)	Drawbar 3" x 1.375" x 41.75", (2) 1.141" Diameter Holes at 1.125" & 2.75" from Front Replaces 82010158	AME3NN805AA12B	\$ 185.00	
T8010, T8020, T8030, T8040	Drawbar Replaces 232515A1, 87773618	AM232515A2	\$ 860.00	
T8010, T8020, T8030, T8040, T8050, TG210, TG215, TG230, TG245, TG255, TG275, TG285, TG305	Drawbar Replaces 310529A1, 719663006, 719663016	AM87680426	\$ 1664.00	
T8010, T8020, T8030, T8040, TG210, TG215, TG230, TG245, TG255, TG275, TG285, TG305	Drawbar Replaces 277702A1, 87773807	AM277702A2	\$ 863.00	
TG210, TG230, TG255, TG285	Drawbar 5" x 2" x 57.125", (6) Holes: 1.625", 3.8125", 7.375", 9.50", 11.625" & 13.75" from Front	AM426511A1	\$ 1035.00	
TG215, TG245, TG275, TG305	Drawbar Cat IV	AM87688072	\$ 1697.00	
230A, 231, 233, 333, 335, 420, 515, 530A, 531, 532, 535, 2000 Series, 2100, 2110, 2120, 2150, 2300, 2310, 2600, 2610, 3000 Series, 3055, 3100, 3110, 3120, 3150, 3300, 3310, 3330, 3400, 3500, 3600, 3610, 3900, 4000 Series, 4100, 4110, 4600, 5600, 5700, 6600, 6700, 7600, 7700, Ind: 3500	Drawbar Hanger	AMD1NN809A	\$ 270.00	

Ford® / New Holland®—Tractor



Hammer Straps

Application	Description	Part Number	Retail Price	Core
T6010, T6020, T6030, T6050, T6070, T6080, T6090, T7030, T7040, T7050, T7070, T6.120, T6.125, T6.140, T6.145, T6.150, T6.155, T6.160, T6.165, T6.175, T6.180, T7.165, T7.170, T7.175, T7.185, T7.190, T7.195S, T7.200, T7.210, T7.220, T7.225, T7.230, T7.235, T7.245, T7.260, T7.270, TM120, TM130, TM140, TM155, TM175, TM190, TS100A, TS115A, TS125A, TS130A, TV140	Hammer Strap	AM82026931	\$ 85.00	
TG210, TG230, TG255, TG285	Hammer Strap	AM232615A3	\$ 148.00	

Rockshaft Components

Application	Description	Part Number	Retail Price	Core
8160, 8260, 8360, 8560, TM115, TM120, TM125, TM130, TM135, TM140, TM150, TM155, TM165	Rockshaft Control Shaft	AM5171027	\$ 375.00	
TM115, TM120, TM125, TM130, TM135, TM140, TM150, TM155, TM165	Rockshaft Lift Arm Replaces 5171960	Left Hand AM87317739	\$ 235.00	
TM140, TM150	Rockshaft Lift Arm	Right Hand AM87317740	\$ 235.00	



Lift Link Assemblies and Components

Application	Description	Part Number	Retail Price	Core
2N, 8N, 9N	Leveling Box Assembly w/ Fork, Right Hand	AM8N577A	\$ 54.00	
2N, 8N, 9N, 501, 541, 600, 601, 611, 621, 630, 631, 640, 641, 650, 651, 660, 661, 671, 681, 700, 701, 740, 741, 771, 800, 801, 811, 820, 821, 840, 841, 850, 851, 860, 861, 871, 881, 900, 901, 941, 950, 951, 960, 961, 971, 981, (2000, 4000 - w/ 4 Cylinder Engine), 2120, 4120	Leveling Box Fork, Right Hand 9" Long	AMEC0N585A	\$ 16.00	
2N, 8N, 9N, 600, 700, 800, 900, 2000, 2100, 2110, 2120, 2150, 2300, 2310, 2600, 2610, 3000, 3120, 3300, 3310, 3330, 3400, 3500, 3600, 3610, 4110, 4600, NAA	Leveling Box Fork, Left Hand Replaces 81802071, 87712987	AMC5NNB863A	\$ 28.00	
2N, 8N, 9N, NAA	Lift Rod Assembly, Left Hand Replaces 9N564B, 182544M92, 81801642	AM1884720M1	\$ 40.00	
600, 601, 800, 801, 2000, 2610, 3000, 3100, 3600, 3610, 4000	Leveling Rod Assembly Replaces C5NN585D, C7NN564B	AMC5NNR862A	\$ 45.00	
2000 Series w/ 3 Cylinder Engines, 2600, 2610, 3000, 3100, 3600, 3610, Ind/Utility: 340, 2100, 3400, 3550, 4110, 4200	Leveling Box Assembly w/ Fork, Right Hand Adjusts from 20.25" to 25.25" center-to-center on mounting holes	AME0NN569AA	\$ 55.00	
2000, 2100, 2110, 2120, 2150, 2300, 2310, 2600, 2610, 3000, 3100, 3120, 3300, 3310, 3330, 3400, 3500, 3600, 3610, 4110, 4600SU	Lift Link Assembly, Left Hand Assembly Includes Knuckle, Rod and Fork Replaces C5NN564D, C5NNR862A, E0NNB484DA	AM2N564B	\$ 36.00	
4000, 4600	Leveling Box Assembly w/ Fork, Right Hand Adjusts from 27.25" to 32.25" center-to-center on mounting holes	AMC5NN569AM	\$ 78.00	
	Lift Link Assembly, Left Hand Includes Knuckle, Rod and Fork	AM4N564B	\$ 67.00	
5000, 5100, 5110, 5200, 5340, 5600, 5610, 5700, 5900, 6000, 6410, 6600, 6600C, 6600O, 6610, 6610O, 6700, 6710, 6810, 7000, 7100, 7200, 7410, 7600, 7600C, 7610, 7610O, 7700, 7710	Lift Link Assembly w/ Fork, Left Hand Replaces C5NNB863CA, VPL2229	AMD2NNN984A	\$ 94.00	

Ford® / New Holland® —Tractor

Application	Description	Part Number	Retail Price	Core
5000, 5100, 5200, 5600, 6600, 6610, 6700, 7100, 7200, 7600, 7700	Leveling Box Assembly w/ Fork, Right Hand Adjusts from 25.00" to 31.00" center-to-center on mounting holes	AMD2NNN983WF	\$ 135.00	
	Components:			
	Level Box Assembly, Right Hand	AMD2NNN983A	\$ 100.00	
	Fork	AMC7NNA935C	\$ 50.00	
5110, 5610, 5900, 6410, 6710, 6810, 7410, 7610, 7710	Leveling Box Assembly w/ Fork, Right Hand Adjusts from 20.25" to 25.25" center-to-center on mounting holes	AME0NN569WF	\$ 165.00	
	Components:			
	Level Box Assembly, Right Hand	AME0NN569KB	\$ 85.00	
	Fork	AMD5NNA935B	\$ 90.00	
5640, 6640, 6640C, 7740, 7740C, 7840, 7840C, 8240, 8340, TV140	Leveling Box Assembly w/ Fork, Right Hand Replaces 82021056, F0NNA935AA, F0NNA954CD	AM83991548	\$ 360.00	
5000, 5100, 5110, 5200, 5340, 5600, 5610, 5700, 5900, 6410, 6600, 6610, 6700, 6710, 6810, 7000, 7100, 7200, 7410, 7600, 7610, 7700, 7710, 8600, 8700, 9000, 9600, 9700, TW10, TW20, TW30	Bevel Gear For Lift Link Assemblies Replaces 81821842	AMC7NN568B	\$ 17.00	
T7030, T7040, T7050, T7060, T7.220, T7.230, T7.235, T7.245, T7.250, T7.260	Lift Link Assembly Replaces 5188140, 47133994	AM84253931	\$ 270.00	

Lower Lift Links



Application	Description	Part Number	Retail Price	Core
(600, 601, 700, 701, 800, 801, 900, 901, 2000, 4000 - w/ 4 Cylinder), (2000, 3000, 3610 - w/ 3 Cylinder)	Lower Lift Arm, Cat I 32.25" Long, 7/8" Hole	Right Hand AMD0NN555D Left Hand AMD0NN555C	\$ 44.00 \$ 44.00	
2310, 2600, 2610, 3000 Series, 3055, 3100, 3310, 3600, 3610, 3900, 4000 Series, 4600, 4610SU, Ind/Utility: 230A, 231, 233, 250C, 260C, 333, 334, 335, 340, 340A, 340B, 345C, 345D, 420, 445, 445A, 445C, 445D, 450, 515, 530A, 531, 532, 535, 540, 540A, 540B, 545, 545A, 545C, 545D, 3550	Lower Lift Arm, Cat I 33" Long, 0.875" Hole	Right Hand AME5NN555AA Left Hand AME5NN556AA	\$ 140.00 \$ 87.00	
2810, 2910, 3000, 3055, 3230, 3430, 3900, 3910, 3930, 4000, 4100, 4110, 4130, 4200, 4330, 4340, 4400, 4410, 4600, 4610, 4610SU, 4630, 4830, 5030, Ind/Utility: 250C, 260C, 345D, 445D, 515, 532, 535, 545D, 3550, 4500	Lower Lift Arm, Cat II 35" Long, 1 1/8" Hole	Right or Left Hand AM82002004	\$ 182.00	
2310, 2600, 2610, 2810, 2910, 3000 Series, 3055, 3100, 3230, 3310, 3430, 3600, 3610, 3900, 3910, 3930, 4000 Series, 4100, 4110, 4130, 4200, 4330, 4340, 4400, 4410, 4600, 4610SU, 4630, 4830, 5030, Ind/Utility: 230A, 231, 233, 250C, 260C, 333, 334, 335, 340, 340A, 340B, 345C, 345D, 420, 445, 445A, 445C, 445D, 450, 515, 530A, 531, 532, 535, 540, 540A, 540B, 545, 545A, 545C, 545D, 3550, 4500	Lift Arm Replacement Ball, Cat I 0.875" ID, 2.25" OD Use w/ AME5NN556AA, AME5NN555AA or AM82002004 Lift Arm w/ Removable Ball	AME1ADDN995233	\$ 8.00	
5000 Series, 5100, 5200, 5340, 5600, 5700, 6600, 6600C, 6600O, 6700, 7000 Series, 7100, 7200, 7600, 7600C, 7700	Lower Lift Arm, Cat II 35" Long, 1 1/8" Hole	Right or Left Hand AMD2NN555E	\$ 66.00	
5000 Series, 5600, 5610, 5700, 5710, 6600, 6610, 6700, 6710, 7000 Series, 7600, 7610, 7700, 7710	Lower Lift Arm, Cat II 37" Long, 1 1/8" Hole	Right or Left Hand AM82002013	\$ 140.00	

Ford® / New Holland®—Tractor

Three Point Hitch Components





Application	Description		Part Number	Retail Price	Core
2910, 3910, 4110, 4620	Stabilizer Assembly Complete Assembly w/o Bracket and U-Bolts	Right or Left Hand	AMD9NNB856BB	\$ 85.00	
	Stabilizer Bracket	Right Hand	AMC7NND933B	\$ 30.00	
		Left Hand	AMC7NND932B	\$ 30.00	
	Stabilizer Bracket U-Bolt		AMC5NN16N321A	\$ 9.00	
5610, 6610, 6710, 7710, 8210	Stabilizer Assembly Complete Assembly w/o Bracket and U-Bolts	Right or Left Hand	AMD9NNB856AA	\$ 70.00	
5610, 6610, 6710, 7610, 7710, 8210	Stabilizer Bracket	Right Hand	AMC7NND933A	\$ 30.00	
		Left Hand	AMC7NND932A	\$ 30.00	
	Stabilizer Bracket U-Bolt		AM388838S36	\$ 8.00	
5000, 5100, 5110, 5200, 5340, 5600, 5610, 5640, 5700, 5900, 6410, 6600, 6610, 6640, 6700, 6710, 6810, 7000, 7100, 7200, 7600, 7610, 7700, 7710, 7740, 7810, 7840, 7910, 8210, 8240, 8340	Draft Control Yoke Replaces 81827128		AMD2NN546A	\$ 60.00	



Quick Hitch Components

Application	Description		Part Number	Retail Price	Core
8670, 8670A, 8770, 8770A, 8870, 8870A, 8970, 8970A, TM115, TM120, TM125, TM130, TM135, TM140, TM150, TM155, TM165, TS100, TS110, TS115	Pull Arm Latch, CAT III Right or Left Hand For Flat/Hook Style Pull Arm Replaces 3903314M91, 86017137, CH167802		AMAL117727	\$ 60.00	

Hydraulic Lift Components

	Application	Description	Part Number	Retail Price	Core
	T6030, T6050, T6070, T6080	Hydraulic Lift Cylinder	AM87392350	\$ 370.00	
	2N, 8N, 9N	Hydraulic Lift Cylinder Housing	AM9N510D	\$ 60.00	
	2N, 8N, 9N	Hydraulic Lift Ram Arm	AM8N545B	\$ 60.00	
	600, 700, 800, 900, 2000, 4000 - w/ 4 Cylinder Engines	Hydraulic Lift Ram Arm	AMNCA545B	\$ 70.00	
	2000 Series, 2100, 2110, 2120, 2150, 2300, 2310, 2600N, 2600V, 2610V, 3000 Series, 3100, 3110, 3120, 3150, 3300, 3310, 3330, 3400, 3500, 3600N, 3600V, 3610N, 3610V, 4000 Series, 4110 - w/ 3 Cylinder Engines	Hydraulic Lift Ram Arm	AMC5NN545B	\$ 60.00	
	5000, 5100, 5200, 5340, 5600, 5700, 5900, 6600, 6700, 7600, 7700	Hydraulic Lift Ram Arm	AMC7NN545C	\$ 124.63	

Ford® / New Holland® —Tractor

	Application	Description	Part Number	Retail Price	Core
	2310, 2600, 2610, 2910, 3600, 3610, 3900, 3910, 4600, Ind: 230A, 231, 233, 234, 333, 334, 335, 340, 340A, 340B, 530A, 531	Hydraulic Lift Arm, Right Hand Use on AMC5NN544D Hydraulic Lift Shaft	AMC5NNB920D	\$ 50.00	
		Hydraulic Lift Arm, Left Hand Use on AMC5NN544D Hydraulic Lift Shaft	AMC5NNB921D	\$ 50.00	
	5000 Series, 5600, 5610, 5700, 6600, 6610, 6700, 7000, 7600, 7610, 7700, 7810, 7910, 8210	Hydraulic Lift Arm, Right Hand Use on AMC5NN544B Hydraulic Lift Shaft	AME3NN838AA	\$ 80.00	
		Hydraulic Lift Arm, Left Hand Use on AMC5NN544B Hydraulic Lift Shaft	AME3NN839AA	\$ 80.00	
	2310, 2600, 2610, 2910, 3600, 3610, 3900, 3910, 4600, Ind: 230A, 231, 233, 234, 333, 334, 335, 340, 340A, 340B, 530A, 531	Hydraulic Lift Shaft	AMC5NN544D	\$ 90.00	
	5000 Series, 5600, 5610, 5700, 6600, 6610, 6700, 7000, 7600, 7610, 7700, 7810, 7910, 8210	Hydraulic Lift Shaft	AMC5NN544B	\$ 142.00	
	2N, 8N, 9N, 600, 700, 800, 900, (2000, 4000 - w/ 3 or 4 Cylinder Engine), 2310, 2600, 2610, 3000, 3600, 3610, 3910, 4600, NAA, Dexta, Super Dexta, Ind: 230A, 234, 334, 335, 340A 10/1981-04/83, 530A	Lift Cylinder Rod Replaces 957E526	AM86563314	\$ 38.00	
	5000, 5600, 5610, 5640, 5700, 6600, 6610, 6640, 6700, 7000, 7600, 7610, 7640, 7700, 7710, 7740, 7810, 7840, 8210, 8240, 8340, TS90, TS100, TS110	Lift Cylinder Rod	AMC7NN526D	\$ 35.00	
	2N, 8N, 9N	Hydraulic Lift Piston	AM9N530B	\$ 21.75	
	5600, 5610, 5640, 5700, 5710, 6600, 6610, 6640, 6700, 7600, 7610, 7640, 7700, 7710, 7810, 7840, 7910, 8210, 8240, 8340, 8530, 8630, 8730, 8830, TS90, TS110, TS115, TW5, TW15, TW25, TW35	Hydraulic Lift Piston 4.125" Diameter	AMD5NN530A	\$ 30.00	
	8000, 8200, 8400, 8600, 8700, 9200, 9600, TW5, TW15	Snap Ring For Hydraulic Lift Position Control Lever to Shaft	AM505026	\$ 1.50	
	2000, 2100, 2110, 2120, 2150, 2300, 2310, 2600, 2610, 2810, 2910, 3000, 3055, 3100, 3110, 3120, 3150, 3230, 3300, 3310, 3330, 3400, 3430, 3600, 3610, 3900, 3910, 3930, 4000, 4100, 4110, 4130, 4140, 4200, 4330, 4340, 4400, 4410, 4600, 4610, 4630, 4830, 5030, Ind: 345C, 345D, 420, 445, 445D, 450, 535, 540, 545, 545D, 3500, 3550, 4500	Draft Control Spring Housing Replaces 81815737	AMC5N905B	\$ 65.00	
	T8010, T8020, T8030, T8040, T8050, TG210, TG215, TG230, TG245, TG255, TG275, TG285, TG305	Solenoid, Hitch Valve Replaces 87775314	AM188105A1	\$ 70.00	

Ford® / New Holland®—Tractor



Toplink Assemblies

Application	Description	Part Number	Retail Price	Core
230A, 2000 Series, 2600, 2610, 3000 Series, 3600, 3610, Ind/Utility: 334, 335, 530A	Toplink Assembly Cat I, 3/4" Holes	AME0NN576DA	\$ 37.66	
2810, 2910, 3000 Series, 3055, 3900, 3910, 4000, 4100, 4110, 4600, 4600SU, 4610, 5000, 5100, 5110, 5200, 5600, 5610, 5700, 5900, 6000, 6600, 6610, 6700, 6710, 6810, 7000, 7100, 7200, 7410, 7600, 7610, 7700, 7710, Ind/Utility: 340, 340A, 340B, 445, 445A, 450, 540, 540A, 540B, 545, 545A, 3550	Toplink Assembly Cat II, 1" Holes	AMD0NN576A	\$ 46.00	
3000 Series, 3910, 4000 Series, 4100, 4110, 4600, 4610, 4610SU, Ind/Utility: 340, 340A, 340B, 445, 445A, 450, 515, 532, 535, 540, 540A, 540B, 545, 545A, 3550, 4500	Toplink Assembly Cat I & II, 3/4" & 1" Holes	AMD6NN576C	\$ 107.00	
2000 1965 and Later w/ 3 Cylinder Engine, (2600, 3000, 3600, 3600N - 1975 and Later), 2610 1981-04/83, (3610, 3610N - 1981-82)	Hydraulic Lift Rocker	AME0NN535AA	\$ 75.00	
2N, 8N, 9N, 800, 900, (2000, 4000 - w/ 4 Cylinder Engines, Hi-Clearance)	Toplink Bracket	AMNCA535A	\$ 60.00	
2000, 2310, 2600, 2610, 3000, 3600, 3610, 4000SU, 4600SU, 4610SU	Toplink Bracket Replaces E0NN535AA	AMC7NN535C	\$ 60.00	
2000 w/ 3 Cylinder Engines, 2600 - 1975 and Later	Toplink Bracket	AMC7NN535B	\$ 55.00	
2810, 2910, 3000 1965 and Later, 3055, 3600 1975 and Later, 3610 1981-1982, 3910, 4000 3 Cylinder 1965 and Later, 4100, 4110, 4610 1981 and Later, 4610SU, Ind/Utility: 340, 340A, 340B, 445, 445A, 450, 540, 540A, 540B, 545, 545A, 3550, 4400, 4500	Toplink Bracket	AME2NN535BA	\$ 112.00	

Battery Box Components

Application	Description	Part Number	Retail Price	Core
8N	Battery Box	AM8N10732	\$ 41.00	
	Battery Hold Down	AMNCA10718A	\$ 19.00	
9N, 600, 700, 800, 900, 2000, 4000, Jubilee, NAA	Battery Box Primer Coated, Ready for Paint For 6 Volt Battery	AMC0NN10732T	\$ 57.60	
501, 541, 600, 601, 611, 620, 621, 630, 631, 640, 641, 650, 651, 660, 661, 671, 681, 700, 701, 740, 741, 771, 800, 801, 811, 820, 821, 840, 841, 850, 851, 861, 871, 900, 901, 941, 950, 951, 960, 971, 981, (2000, 4000 - w/ 4 Cylinder Engine), 2031, 2111, 2120, 2130, 2131, 4031, 4120, 4121, 4130, 4131, NAA, NAB, Ind/Const: 1801, 1811, 1821, 1841, 1871, 1881, 2030, 2130, 4030, 4040, 4140	Battery Tray For 6 Volt Battery	AMC0NN10732	\$ 45.00	
2000, 2100, 2110, 2300, 2310, 2600, 2610, 2810, 2910, 3000, 3055, 3100, 3110, 3120, 3150, 3300, 3310, 3330, 3400, 3500, 3600, 3610, 3900, 3910, 4000, 4100, 4110, 4140, 4200, 4330, 4340, 4400, 4410, 4500, 4600, 4600SU, 4610, 4610SU, 5000, 5100, 5110, 7810 - 1965-01/31/67 w/ Diesel Engine	Battery Tray 19.75" x 9" Overall Dimensions Replaces 81814352, C5NN10723A, C5NN10723B	AMC5NN10723H	\$ 160.00	



Side Panels and Hoods

Panels are painted with a primer coat unless otherwise noted.

Application	Description	Part Number	Retail Price	Core
2N, 8N, 9N	Side Panel			
		Right Hand	AM8N16618A-R	\$ 86.00
		Left Hand	AM8N16618A-L	\$ 85.00
600, 800, 900, NAA	Side Panel			
		Right Hand	AMC3NN16653A	\$ 140.00
		Left Hand	AMC3NN16652A	\$ 140.00
8N	Hood		AM8N16612	\$ 483.00
2000, 2100, 2110, 2120, 2300, 2310, 3000, 3055, 3100, 3110, 3120, 3300, 3310, 3330, 3400, 3500, 3550, 4000, 4100, 4110, 4140, 4330, 4340, 4400, 4410, 4500, 7000, 7100, 7200	Hood 31" Long	Right Hand	AMC5NN16625F	\$ 65.00
6600, 6610	Hood Replaces C5NN16626J, C7NN16626C	Left Hand	AMD5NN16626	\$ 84.00

Ford® / New Holland®—Tractor



Front Grilles, Nose Cones and Components

Application	Description	Part Number	Retail Price	Core
2N, 8N, 9N	Grille	AM8N8204	\$ 54.00	
231, 233, 333, 335, 515, 531, 532, 2600, 2600N, 2600R, 2600V, 3600, 3600N, 3600NO, 3600R, 3600V, 3900, 4100, 4600, 4600D, 4600U, 4600SU, 5600, 6600, 6600C, 6600D, 7600, 7600C	Grille 1-Piece	AMD5NN8200C	\$ 50.00	
2600, 3600, 3900, 4100, 4600, 5600, 6600, 7600	Grille	AMD5NN8200A	\$ 31.00	
2000, 3000, 4000, 5000 Series	Upper Front Grille, Plastic	AMC9NN8A163AG	\$ 21.00	
2000, 4000 - w/ 4 Cylinder Engine	Front Grille	AMC3NN8200A	\$ 86.00	
2000, 3000, 4000, 5000 Series - 01/1965-12/74	Lower Front Grille, Plastic Replacement lower grille section for tractors w/ external headlights	AMD1NN8151A	\$ 18.00	
2310, 2610, 2810, 2910, 3610, 3910, 4110, 4910, Ind: 230A, 335, 530A	Nose Cone Replaces E4NN6A858AA	AME4NN16A858AA	\$ 291.00	
231, 233, 333, 531, 2000, 2600, 3000, 3600, 4100	Bumper Axle Mount	AMD8NN17750AA	\$ 275.00	
5610, 5700, 6610, 6700, 6710, 7410, 7610, 7700, 7710, 7810, 7810C, 7910, 8000, 8210, 8530, 8630, 8700, 9000, 9700, TW5, TW10, TW15, TW20	Outer Grille Screen, Right Hand Outer Grille Screen, Left Hand Replaces 83909848	AMD5NN8150A AMD5NN8151A	\$ 78.00 \$ 112.00	

Fenders and Components

Fenders are painted with a primer coat unless otherwise noted.









Application	Description	Part Number	Retail Price	Core
2N, 8N, 9N, NAA	Fender w/ Bracket Right or Left Hand Fender w/o Bracket, Skin Only Right or Left Hand	AMC0NN16312A AMC0NN16312SK	\$ 176.00 \$ 133.00	
601, 611, 621, 631, 641, 651, 661, 671, 681, 801, 811, 821, 841, 851, 861, 871, 881, 2000, 2031, 2150, 2300, 2310, 2600, 2610, 2810, 2910, 3000, 3100, 3110, 3120, 3150, 3230, 3300, 3310, 3330, 3400, 3430, 3500, 3600, 3610, 3900, 3910, 3930, 4000, 4000SU, 4030, 4031, 4120, 4121, 4131, 4400, 4500, 4600, 4600SU, 4610	Fender w/ Bracket, Clam Shell Right or Left Hand	AMC5NN16312AK	\$ 128.00	
2600, 2610, 2810, 2910, 3600, 3610, 3910, 3930, 4100, 4110, 4600, 4610, 4630, 4830, 5030, 5600, 5610, 6600, 6610, 7600, 7610, Ind: 515, 532, 535	Fender, Flat Top Right Hand Fender, Flat Top Left Hand Bracket Right or Left Hand	AMD8NN16312ABB AME5NN16313DA AMD3NN16N319A	\$ 260.00 \$ 214.00 \$ 143.50	

Lighting

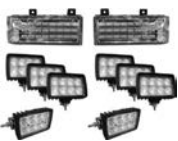
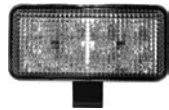





Application	Description	Part Number	Retail Price	Core
8N, 600, 620, 630, 640, 650, 660, 700, 740, 800, 820, 840, 850, 860, 900, 950, 960, Jubilee, NAA, NAB	Light Bulb, Sealed Beam 4 1/2" Diameter Round Bulb Dimpled Lens 6 Volt	AM8N15514	\$ 30.00	
Versatile®: 190, 220, 250, 260, 285, 290, 305, 310, 340, 375, 400, 405, 435, 535, 550, 575	LED Floodlight Conversion Kit (2) 6.50" x 4.50" Oval Lights, Each Light is 5000 Lumens, 60 Watts, 5 Amps For 12 Volt to 24 Volt Systems Includes Mounting Brackets, Stainless Steel Hardware and Wiring Harness (Plug-and-Play)	AMTL8320-KIT	\$ 386.00	









Ford® / New Holland®—Tractor

Application	Description	Part Number	Retail Price	Core
 <p>8670, 8670A, 8770, 8770A, 8870, 8870A, 8970, 8970A, Versatile®: 2145, 2160, 2180, 2210</p>	<p>LED Light Kit Includes Right Hand and Left Hand LED Headlight**, (2) Cab Mount LED Floodlights*, (6) Cab/Fender Mount LED Floodlights*, Connectors and Stainless Steel Mounting Hardware For 12 Volt to 24 Volt Systems Uses Original Mount and Wiring *3600 Lumens, 40 Watts, 3.30-3.33 Amps **8200 Lumens, 90 Watts, 7.50 Amps</p>	AMX34162	\$ 1300.00	
 <p>T6020, T6040, T6060, T7030, T7040, T7050, T7060, TG210, TG215, TG230, TG245, TG255, TG275, TG285, TG305, TS100A, TS110A, TS115A, TS125A, TS130A, TS135A Replaces 82031075</p>	<p>LED Upper Cab Light 6" x 3" x 2.50" Rectangle Light 3000 Lumens, 40 Watts, 3.33 Amps For 12 Volt to 24 Volt Systems Due to cab variations, please verify correct part number before ordering</p>	AMTL7040	\$ 102.00	
	<p>LED Upper Cab Light 6" x 3" x 2.50" Rectangle Light 3000 Lumens, 40 Watts, 3.33 Amps For 12 Volt to 24 Volt Systems Due to cab variations, please verify correct part number before ordering</p>	AM82031078	\$ 85.00	
 <p>2310, 2600, 2610, 2810, 2910, 3600, 3610, 3910, 3930, 4200, 4600, 4600SU, 4610, 5200, 5600, 5610, 5900, 6600, 6610, 7000, 7200, 7600, 7610 Replaces D9NN13005CA, D4NN13002C</p>	<p>LED Trapezoid Light Fender Mount 4.50" Sealed Beam Round Light 2800 Lumens, 40 Watts, 3.30 Amps For 12 Volt to 24 Volt Systems Rear Stud Mount w/ Built-In Heat Sink Includes Both Long and Short Rubber Bezels</p>	AMTL2060	\$ 115.00	
	<p>Headlight Sealed Beam, 12 Volt, 2-Wire</p>	AMRE25126	\$ 90.00	
 <p>8670, 8670A, 8770, 8770A, 8870, 8870A, 8970, 8970A, Versatile®/Buhler®: 2145, 2160, 2180, 2210</p>	<p>LED Headlight, Right Hand Hi/Low Beam and Side Beam 8200 Lumens, 90 Watts, 7.50 Amps For 12 Volt to 24 Volt Systems Uses Original Mount and Wiring Replaces 86514346, 86514347</p>	AMTL8970R	\$ 253.00	
	<p>LED Headlight, Left Hand Hi/Low Beam and Side Beam 8200 Lumens, 90 Watts, 7.50 Amps For 12 Volt to 24 Volt Systems Uses Original Mount and Wiring Replaces 86514348, 86514349</p>	AMTL8970L	\$ 253.00	
 <p>2310, 2600, 3600, 4000, 4100, 4200, 4600, 5000, 5200, 5600, 5900, 6600, 6700, 7000, 8600, 8700, 9000, 9700</p>	<p>Halogen Floodlight, Sealed Beam 4.50" Diameter Round Light 2-Terminal Connection For 12 Volt Systems Replaces A47179, AR104119, E3NN15330AA</p>	AMH7606	\$ 10.00	
 <p>Universal Equipment</p>	<p>LED Floodlight All-Position Light 5" Round Light 3200 Lumens, 40 Watts, 3.30 Amps For 12 Volt to 24 Volt Systems Includes Mounting Bracket and Stainless Steel Hardware</p>	AMTL180	\$ 102.00	
 <p>Universal Equipment</p>	<p>LED Floodlight All-Position Light 4.25" x 4.25" Square Light 2650 Lumens, 48 Watts, 4 Amps For 12 Volt to 24 Volt Systems Includes Mounting Bracket and Stainless Steel Hardware</p>	AMTL105F	\$ 79.00	







Ford® / New Holland®—Tractor

Application	Description	Part Number	Retail Price	Core
 Universal Equipment	LED Floodlight All-Position Light 6.25" x 1.75" Rectangle Light 1300 Lumens, 18 Watts, 1.50 Amps For 12 Volt to 24 Volt Systems Includes Mounting Bracket and Stainless Steel Hardware	AMTL118F	\$ 57.00	
 Universal Equipment	LED Floodlight All-Position Light Round Light 6900 Lumens, 50 Watts, 4.10 Amps For 9 Volt to 32 Volt Systems Includes Mounting Bracket and Stainless Steel Hardware	AMTL500F	\$ 130.00	
	LED Floodlight All-Position Light 4.30" Round Light 5040 Lumens, 50 Watts, 4.10 Amps For 12 Volt to 24 Volt Systems Includes Stainless Steel Adjustable Mounting Bracket	AMAT305931	\$ 113.00	
 Universal Equipment	LED Floodlight All-Position Light 4.25" Round Light 2650 Lumens, 42 Watts, 3.50 Amps For 12 Volt to 24 Volt Systems Includes Mounting Bracket and Stainless Steel Hardware	AMTL115F	\$ 66.00	
 Universal Equipment	LED Wide Floodlight All-Position Light 5" x 7" Rectangle Light 3800 Lumens, 35 Watts For 12 Volt to 24 Volt Systems	AMX34171	\$ 60.00	
 Universal Equipment	LED Floodlight, Sealed Beam Fender Mount 4.50" Diameter Round Light 1250 Lumens, 18 Watts, 1.50 Amps Trapezoid Pattern For 12 Volt to 24 Volt Systems	AMTL3010	\$ 50.00	
	LED Floodlight Fender Mount 4.50" Diameter Sealed Beam Round Light 1250 Lumens, 18 Watts, 1.20 Amps Trapezoid Pattern For 12 Volt to 24 Volt Systems Lasts 50 times longer than halogen lighting, vibration resistant w/ no filament failures, uses original mount and wiring. Operating temperature of -40°F to 140°F / -40°C to 60°C	AMRE336111	\$ 37.00	
 Universal Equipment	LED Floodlight Fender Mount 4.50" Diameter Sealed Beam Round Light 1440 Lumens, 18 Watts, 1.60 Amps Lasts 50 times longer than halogen lighting, vibration resistant w/ no filament failures, 2-terminal connection. Operating temperature of -40°F to 140°F / -40°C to 60°C	AMRE336112	\$ 68.00	
 T8010, T8020, T8030, T8040, T8050, T8.275, T8.300, T8.320, T8.330, T8.350, T8.360, T8.380, T8.390, T8.410, T8.420, T8.435, TG210, TG215, TG230, TG245, TG255, TG275, TG285, TG305	LED Floodlight Fender Mount w/ Hollow Bolt 6" x 3.50" Rectangle Light 3600 Lumens, 40 Watts, 3.33 Amps For 12 Volt to 24 Volt Systems Uses Original Wiring Includes Deutsch Connector, Mounting Bracket and Stainless Steel Hardware	AMTL3085	\$ 105.00	





Ford® / New Holland®—Tractor

Application	Description	Part Number	Retail Price	Core
 Universal Equipment	LED Floodlight Cab and Fender Mount 3.50" x 6" Rectangle Light 3600 Lumens, 40 Watts, 3 Amps	AMX34146	\$ 65.00	
 8670, 8670A, 8770, 8770A, 8870, 8870A, 8970, 8970A	LED Floodlight Cab Mount 3.50" x 6" Rectangle Light 3600 Lumens, 40 Watts, 3 Amps Post on Side Deutsch Connector	AM9846126	\$ 85.50	
 8670, 8670A, 8770, 8770A, 8870, 8870A, 8970, 8970A	LED Floodlight Cab Mount 6" x 3" Rectangle Light 3600 Lumens, 40 Watts, 3.33 Amps For 12 Volt to 24 Volt Systems Uses Original Mount and Wiring Includes Deutsch Connector, Mounting Bracket and Stainless Steel Hardware Replaces 9824851	AMTL3050	\$ 105.00	
 Versatile®: 190, 220, 250, 260, 290, 300, 305, 310, 320, 335 Replaces 86038024	LED Floodlight Hood Mount 5.50" x 3.75" Oval Light 3000 Lumens, 35 Watts, 2.90 Amps For 12 Volt to 24 Volt Systems Uses Original Mount and Wiring, Plug-and-Play	AMTL9220	\$ 115.00	
 T8010, T8020, T8030, T8040, T8050, TG210, TG215, TG230, TG245, TG255, TG275, TG285, TG305	LED Floodlight Side Mount 6" x 3.50" x 3" Rectangle Light 3600 Lumens, 40 Watts, 3.30 Amps For 12 Volt to 24 Volt Systems Requires Splicing into Original Wiring	AMTL3075	\$ 105.00	
 T8010, T8020, T8030, T8040, T8050, TG210, TG215, TG230, TG245, TG255, TG275, TG285, TG305, TJ275, TJ325, TJ425, TJ450, TJ500 Replaces 87435762, 87773385	LED Floodlight Lower Front, Cab, Fender and ROPS 6" x 3.50" x 6" Rectangle Light 3600 Lumens, 40 Watts, 3.30 Amps For 12 Volt to 24 Volt Systems Includes Connector, Plug-and-Play	AMTL3030	\$ 105.00	
	LED Floodlight Lower Front, Cab, Fender and ROPS 6" x 3.50" x 6" Rectangle Light 3600 Lumens, 40 Watts, 3.30 Amps For 12 Volt to 24 Volt Systems Includes Connector, Plug-and-Play	AM92269C1	\$ 84.00	







Ford® / New Holland®—Tractor

Application	Description	Part Number	Retail Price	Core
 Versatile®: 190, 220, 250, 260, 285, 290, 305, 310, 340, 375, 400, 405, 435, 535, 550, 575	LED Floodlight Upper Front and Rear Cab, Rear Fender and Mid Mount 6.50" x 4" Oval Light 5200 Lumens, 65 Watts, 5.40 Amps For 12 Volt to 24 Volt Systems Housing Has Powder Coat Finish Includes Mounting Bracket and Stainless Steel Hardware	AMTL5680	\$ 135.00	
	LED Floodlight Upper Front and Rear Cab, Rear Fender and Mid Mount 6.50" x 4" Oval Light 5500 Lumens, 65 Watts For 12 Volt to 24 Volt Systems Housing Has Powder Coat Finish Includes Connector and Bracket for Plug-and-Play Installation	AMAH212523	\$ 117.00	
 5640, 6640, 66400, 7740, 77400, 7840, 78400, 8160, 8240, 8260, 8340, 8360, 8560, TM115, TM120, TM125, TM130, TM135, TM140, TM150, TM155, TM165, TM175, TM190, TV140	LED Floodlight/Spotlight Combo Grille Mount 6" x 4" Rectangle Light 3500 Lumens, 60 Watts, 5 Amps For 12 Volt to 24 Volt Systems Includes Mounting Bracket and Stainless Steel Hardware	AMTL7740	\$ 124.00	
	LED Floodlight/Spotlight Combo Grille Mount 6" x 4" Rectangle Light, 3500 Lumens, 60 Watts, 5 Amps For 12 Volt to 24 Volt Systems Includes Mounting Bracket and Stainless Steel Hardware	AMF0NN1305AB	\$ 99.00	
 TS90, TS100, TS110, TS115	LED Floodlight/Spotlight Combo Hood Mount 6" x 4" Rectangle Light 3500 Lumens, 60 Watts, 5 Amps For 12 Volt to 24 Volt Systems Includes Connector, Mounting Brackets and Stainless Steel Hardware	AMTL6070	\$ 157.00	
 Universal Equipment	LED Spotlight All-Position Light 4.25" x 4.25" Square Light 1400 Lumens, 27 Watts, 2.20 Amps For 12 Volt to 24 Volt Systems	AMTL100S	\$ 50.00	
 Universal Equipment	LED Spotlight All-Position Light 6.25" x 1.75" Rectangle Light 1300 Lumens, 18 Watts, 1.50 Amps For 12 Volt to 24 Volt Systems Includes Mounting Bracket and Stainless Steel Hardware	AMTL118S	\$ 57.00	
 Universal Equipment	LED Spotlight All-Position Light Round Light 6900 Lumens, 50 Watts, 4.10 Amps For 9 Volt to 32 Volt Systems Includes Mounting Bracket and Stainless Steel Hardware	AMTL500S	\$ 135.00	





Ford® / New Holland®—Tractor

Application	Description	Part Number	Retail Price	Core
 Universal Equipment	LED Trapezoid Light Cab and Fender Mount 4.50" Diameter Round Light 2800 Lumens, 40 Watts, 3.30 Amps Trapezoid Pattern For 12 Volt to 24 Volt Systems Bottom Mount w/ Built-In Heat Sink Includes Mounting Bracket, Long and Short Rubber Bezels and Stainless Steel Hardware	AMTL2080	\$ 107.00	
	LED Trapezoid Light Cab and Rear Fender Mount 4.50" Diameter Round Light 2800 Lumens, 40 Watts, 3.30 Amps Trapezoid Pattern For 12 Volt to 24 Volt Systems Bottom Mount w/ Built-In Heat Sink Includes Mounting Bracket, Long and Short Rubber Bezels and Stainless Steel Hardware	AMX33121	\$ 90.00	
 233, 333, 2000, 2100, 2110, 2120, 2150, 2300, 2310, 2600, 2600N, 2600R, 2600V, 3000, 3055, 3100, 3110, 3120, 3150, 3300, 3310, 3330, 3400, 3500, 3550, 3600, 3600N, 3600NO, 3600R, 3600V, 3900, 4000, 4100, 4110, 4140, 4200, 4330, 4340, 4400, 4410, 4500, 4600, 4600NO, 4600O, 4600SU, 5000, 5100, 5200, 5340, 5600, 5700, 6600, 6600C, 6600O, 6700, 6710, 7000, 7100, 7200, 7600, 7600C, 7700, 7710, 7910, 8000, 8210, 8600, 8700, 9000, 9600, 9700, TW5, TW10, TW15, TW20, TW25, TW30, TW35	LED Trapezoid Light Fender Mount 4.50" Sealed Beam Round Light 2200 Lumens, 24 Watts, 2 Amps For 12 Volt to 24 Volt Systems Uses Original Mount and Wiring Replaces RE336111	AMTL3015	\$ 55.00	
	 8670, 8670A, 8770, 8770A, 8870, 8870A, 8970, 8970A, Versatile®: 2145, 2160, 2180, 2210	LED Warning Light, Right Hand Cab Mount 4.75" x 3.25" x 2.50" Rectangle Light Amber Lens, 7 Watts, 0.60 Amp For 12 Volt to 24 Volt Systems Includes Stainless Steel Hardware Replaces 86507530	AMTL7015R	\$ 57.00
LED Warning Light, Left Hand Cab Mount 4.75" x 3.25" x 2.50" Rectangle Light Amber Lens, 7 Watts, 0.60 Amp For 12 Volt to 24 Volt Systems Includes Stainless Steel Hardware Replaces 86507530		AMTL7015L	\$ 57.00	
 9184, 9280, 9282, 9384, 9480, 9482, 9484, 9680, 9682, 9684, 9880, 9882, 9884	LED Warning Light Cab Mount 3.15" x 6.75" Rectangle Light 9 Watts, 0.75 Amp For 12 Volt to 24 Volt Systems Replaces 92260C1, 107324C91, 130882C91, 216044C91, 216044C92, 9706415, 83977683, 86012669, 86014019, 86016518, 86023276, 87053368	AMX34180	\$ 57.00	
	LED Warning Light Cab Mount 3.15" x 6.75" Rectangle Light 9 Watts, 0.75 Amps For 12 Volt to 24 Volt Systems Replaces 92260C1, 107324C91, 130882C91, 216044C91, 216044C92, 9706415, 83977683, 86012669, 86014019, 86016518, 86023276, 87053368	AM92185C1	\$ 47.00	





Ford® / New Holland®—Tractor

Application	Description	Part Number	Retail Price	Core
 T9020, T9030, T9040, T9050, T9060, TJ275, TJ280, TJ325, TJ330, TJ375, TJ380, TJ425, TJ430, TJ450, TJ480, TJ500, TJ530	Warning Light, Side Marker Amber Lenses	AM367321A1	\$ 34.00	
 Universal Equipment	LED Warning Light Cab, Header or Swather Mount Can be used for Turn Signal, Brake or Running Lights 4.125" Diameter Round Light Double Sided, Amber Lenses 25 Bulbs per Side For 12 Volt to 24 Volt Systems	AMTLFL2	\$ 62.00	
	LED Warning Light Cab, Header or Swather Mount Can be used for Turn Signal, Brake or Running Lights 4.125" Diameter Round Light Double Sided, Amber Lenses 25 Bulbs per Side For 12 Volt to 24 Volt Systems	AMX1910149	\$ 52.00	
 Universal Equipment	LED Warning Light Cab, Header or Swather Mount Can be used for Turn Signal, Brake or Running Lights 4.125" Diameter Round Light Double Sided, Red and Amber Lenses 25 Bulbs per Side For 12 Volt to 24 Volt Systems	AMTLFL3	\$ 62.00	
	LED Warning Light Cab, Header or Swather Mount Can be used for Turn Signal, Brake or Running Lights 4.125" Diameter Round Light Double Sided, Red and Amber Lenses 25 Bulbs per Side For 12 Volt to 24 Volt Systems	AMX33126	\$ 52.00	
 Universal Equipment	LED Magnetic Warning Light All-Position Light 360° Flashing Light, Multiple Patterns 9.50" x 6.75" Rectangle Light Magnetic Base or Solid Mount For 12 Volt to 24 Volt Systems Includes Cigarette Lighter Adapter, Wiring and Switch	AMTL1100	\$ 192.00	
 Universal Equipment	LED Magnetic Warning Light All-Position Light 360° Flashing Light, Multiple Patterns 14" x 6.75" Rectangle Light Magnetic Base or Solid Mount For 12 Volt to 24 Volt Systems Includes Cigarette Lighter Adapter, Wiring and Switch	AMTL1200	\$ 215.00	
Universal Equipment	Warning Beacon 360° Flashing Beacon, Amber Lens For 0.9435" Diameter Pipe Replaces 84337818, AZ44705, AZ101891	AM82018390	\$ 58.00	
 Universal Equipment	LED Warning Beacon 360° Flashing Beacon 2.75" x 5.25" Light Polycarbonate Amber Lens and Housing For 12 Volt to 24 Volt Systems Includes Solid Mounting Pad and Stainless Steel Hardware	AMTL2100	\$ 34.00	

Ford® / New Holland®—Tractor

	Application	Description	Part Number	Retail Price	Core
	Universal Equipment	LED Warning Beacon 360° Flashing Beacon, 3 Different Patterns 5" x 10" Light Amber Lens, 48 Watts, 4 Amps For 12 Volt to 24 Volt Systems Brackets Sold Separately	AMX33131	\$ 85.00	
	Universal Equipment	Warning Beacon Bracket	AMX33132	\$ 17.00	
	Universal Equipment	Warning Beacon Bracket	AMX33133	\$ 17.00	
	Universal Equipment	Warning Beacon Bracket Use w/ AMX33131 LED Warning Beacon, TL2000	AMX33137	\$ 17.00	
	Universal Equipment	Warning Beacon Bracket Use w/ AMX33131 LED Warning Beacon, TL2000	AMX33135	\$ 17.00	
	Universal Equipment	LED Light Bar 4" Long, 1260 Lumens, Cree Bulbs	AMLED4	\$ 45.00	
		LED Light Bar Flood/Spotlight Combo 10" Long, 5700 Lumens, 50 Watts, 4.20 Amps For 12 Volt to 24 Volt Systems Includes Mounting Bracket and Stainless Steel Hardware	AMTL10SRC	\$ 145.00	
		LED Light Bar Floodlight/Spotlight Combo 14" Long, 5400 Lumens, 72 Watts, 6 Amps Die Cast Aluminum Housing, Polycarbonate Lens For 12 Volt to 24 Volt Systems Includes Mounting Bracket and Heavy Duty Stainless Steel Hardware	AMTLB410C	\$ 169.00	
		LED Light Bar Floodlight/Spotlight Combo 30" Long, 13600 Lumens, 150 Watts, 12.50 Amps For 12 Volt to 24 Volt Systems Includes Mounting Bracket and Stainless Steel Hardware	AMTL30SRC	\$ 259.00	
		LED Light Bar 30" Long, 13860 Lumens, Cree Bulbs	AMLED30	\$ 130.00	
		LED Light Bar Floodlight/Spotlight Combo 40" Long, 17300 Lumens, 200 Watts, 16.70 Amps For 12 Volt to 24 Volt Systems Includes Mounting Brackets and Stainless Steel Hardware	AMTL40SRC	\$ 337.00	
		LED Light Bar 40" Long, 18200 Lumens, Cree Bulbs	AMLED40	\$ 160.00	

Ford® / New Holland®—Tractor

Application	Description	Part Number	Retail Price	Core
 Universal Equipment	LED Light Bar Floodlight/Spotlight Combo 42" Long, 14500 Lumens, 240 Watts, 19 Amps For 12 Volt to 24 Volt Systems Includes Mounting Bracket and Stainless Steel Hardware Replaces 1163691	AMTLB440C	\$ 328.00	
	LED Light Bar, Curved 50" Long, 21500 Lumens, Cree Bulbs	AMLED50C	\$ 194.00	
 Universal Equipment	LED Magnetic Work Light All-Position Light 3.25" Square Floodlight 900 Lumens 3 Modes of 30% Intensity, 100% Intensity and S.O.S. Pattern Magnetic Base Includes Lithium Ion Battery, Cigarette Lighter and DC Charger	AMTL2460	\$ 89.00	
 2N, 8N, 9N	Light Switch Replaces 9N11652, 830517M91	AM9N11652B	\$ 7.00	
 2000, 2310, 2600, 2610, 2810, 2910, 3000, 3600, 3610, 3910, 4000, 4110, 4600, 4610, 5000, 5110, 5600, 5610, 6410, 6610, 6710, 6810, 7000, 7600, 7610, 7710, 7910, 8210	Light Switch Replaces C5NN11654C, D6NN11N650A, EDPN11654AA	AM251405	\$ 12.00	
 2310, 2610, 2810, 2910, 3610, 3910, 3930, 4110, 4610, 4630, 4830, 5110, 5610, 6410, 6610, 6710, 6810, 7410, 7610, 7710, 8210, 8530, 8630, 8730, 8830, TW5, TW15, TW25, TW35, Ind/Const: 230A, 234, 250C, 260C, 334, 335, 340, 340A, 340B, 345C, 345D, 445, 445A, (445C, 445D, 545C, 545D - w/o Cab), 450, 530A, 540, 540A, 540B, 545, 545A	Light Switch	AME3NN11654AA	\$ 14.75	

Cab Components—Miscellaneous

Application	Description	Part Number	Retail Price	Core
8670, 8670A, 8770, 8770A	Reman Monitor Replaces 86025959, 86027424, 86027424R	AM84595297R	\$ 3880.00	\$ 250.00
T6030, T6050, T6070, T6080, T6090, T7030, T7040, T7050, T7060, T7070, T7.170, T7.185, T7.200, T7.210, T7.220, T7.235, T7.250, T7.260, T7.270	Reman Monitor Replaces 293255A3, 295133A5, 87668610	AM84604338R	\$ 1650.00	\$ 500.00
T8.275, T8.300, T8.320, T8.330, T8.350, T8.360, T8.380, T8.390, T8.410, T8.420, T8.435	Monitor Bracket Well-suited for use w/ multiple monitors, less restriction of operator's view improves safety. Assembly hardware and tray pad included, monitor mounting hardware not included.	AMSS3178	\$ 191.00	
(T8.275, T8.300, T8.320, T8.330, T8.350, T8.360, T8.380, T8.390, T8.410, T8.420, T8.435 - 2014 and Later)	Monitor Bracket Well-suited for use w/ multiple monitors, less restriction of operator's view improves safety. Assembly hardware and tray pad included, monitor mounting hardware not included.	AMSS3192	\$ 170.00	







Ford® / New Holland®—Tractor

Application	Description	Part Number	Retail Price	Core
Most Models	Tablet Holder, Rail Mount Universal tablet mount, heavy duty Standard double knuckle w/ 9" extension, will hold tablets up to 11" w/ (4) cutouts for camera lens 360° rotation for portrait or landscape viewing Limited Lifetime Warranty	AMX19135	\$ 100.00	













Cab Doors

Application	Description	Part Number	Retail Price	Core
3600, 4600, 4610, 5600, 5610, 6600, 6610, 6710, 7600, 7610, 7700, 7710, 7910, 8200, 8210, 8530, 8630, 8700, 8730, 8830, 9700, TW5, TW10, TW15, TW20, TW25, TW35	Door Molding Kits Sold in Pairs, w/ Blue Push Pins	AMX19105	\$ 199.00	

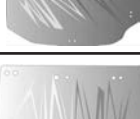
Glass

Application	Description	Part Number	Retail Price	Core
 T6010, T6020, T6030, T6040, T6050, T6060, T6070, T6080, TS100A, TS110A, TS115A, TS125A, TS130A, TS135A	Front Windshield Glass Hinged	AM82032042	\$ 255.00	
 T6010, T6020, T6030, T6040, T6050, T6060, T6070, T6080, T6090, T7030, T7040, T7050, TS100A, TS110A, TS115A, TS125A, TS130A, TS135A	Front Windshield Glass Replaces 82030483	AM87304257	\$ 320.00	
 8670, 8670A, 8770, 8770A, 8870, 8870A, 8970, 8970A	Lower Windshield Glass, Right Hand Replaces 89827540	AM9827540	\$ 55.00	
T6010, T6020, T6030, T6040, T6050, T6060, T6070, T6080, TS100A, TS110A, TS115A, TS125A, TS130A, TS135A	Lower Front Glass, Right Hand Replaces 82030487	AM87566891	\$ 128.00	
	Lower Front Glass, Left Hand Replaces 82030488	AM87566892	\$ 114.00	
 T6010, T6020, T6030, T6040, T6050, T6060, T6070, T6080, T6090, T7030, T7040, T7050, T7060, T7070, TS100A, TS110A, TS115A, TS125A, TS130A, TS135A	Lower Front Glass, Right Hand Replaces 82030485	AM87304259	\$ 91.00	
	Lower Front Glass, Left Hand Replaces 82030486	AM87304261	\$ 118.00	
 233, 234, 333, 334, 2600, 2610, 3600, 3610, 3910, 4100, 4110, 4600, 4610, 5110, 5600, 5610, 5700, 6410, 6600, 6610, 6700, 6710, 6810, 7410, 7600, 7610, 7700, 7710, 7910, 8000 Series, 8210, 8700, 9000 Series, 9700, TW5, TW10, TW15, TW20, TW25, TW30, TW35	Wing Window	AMD5NN9425722B	\$ 80.00	
T8010, T8020, T8030, T8040, T8050, T8.275, T8.300, T8.320, T8.330, T8.350, T8.360, T8.380, T8.390, T8.410, T8.420, T8.435, TG210, TG215, TG230, TG245, TG255, TG275, TG285, TG305	Cab Glass, Right Hand Replaces 242536A5, 87773671	AM87417671	\$ 800.00	
 8670, 8670A, 8770, 8770A, 8870, 8870A, 8970, 8970A	Side Glass, Right Hand Hinged Replaces 9861002, 89861002	AM86521435	\$ 115.00	
(5610, 6640, 7740, 7840, 8240, 8340 - Prior to 10/1995), (8670, 8770, 8870, 8970 - 09/1993 and Later), 8670A, 8770A, 8870A, 8970A	Door Glass, Left Hand Replaces 83994233, 86508175, 89823599	AME9NN94032N18BB	\$ 184.00	

Ford® / New Holland® —Tractor

	Application	Description	Part Number	Retail Price	Core
	T6010, T6020, T6030, T6040, T6050, T6060, T6070, T6080, T6090, T7030, T7040, T7050, T7060, TS100A, TS110A, TS115A, TS125A, TS130A, TS135A	Door Glass, Right Hand Replaces 82027356, 87528172	AM84280178	\$ 505.00	
	T8010, T8020, T8030, T8040, T8050, T8.275, T8.300, T8.320, T8.330, T8.350, T8.360, T8.380, T8.390, T8.410, T8.420, T8.435, TG215, TG245, TG275, TG305	Door Glass, Left Hand	AM344730A2	\$ 358.00	
	TS100A, TS110A, TS115A, TS125A, TS130A, TS135A	Door Glass, Left Hand Replaces 82027357, 87560786	AM87528171	\$ 418.00	
	5110, 5600, 5610, 6600, 6610, 6810, 7410, 7600, 7610, 7700, 7710, 7810, 7910, 8000, 8210, 8530, 8630, 8700, 8730, 8830, 9000, 9700, TW5, TW10, TW15, TW20, TW25, TW30, TW35	Upper Door Glass, Right or Left Hand Tinted Replaces 82015335, 82019226, D8NN9421410BA	AM83914255	\$ 61.00	
	8670, 8670A, 8770, 8770A, 8870, 8870A, 8970, 8970A	Rear Glass Replaces 9823602, 89823602	AM86002901	\$ 196.00	
	5640, 6640, 7740, 7840, 8240, 8340 - Prior to 06/1994 w/ SuperLux Cab	Rear Glass Replaces 81865244, 83995319	AMF0NN9442038BA	\$ 150.00	
	T6010, T6020, T6030, T6040, T6050, T6060, T6070, T6080, T6090, T7030, T7040, T7050, TS100A, TS110A, TS115A, TS125A, TS130A, TS135A	Rear Glass Replaces 82030887, 87663400	AM87744542	\$ 250.00	
	T8010, T8020, T8030, T8040, T8050, T8.275, T8.300, T8.320, T8.330, T8.350, T8.360, T8.380, T8.390, T8.420, T8.435, TG215, TG245, TG275, TG305	Rear Glass Tinted Replaces 242667A4	AM87309738	\$ 320.00	
	4635, 4835, 5635, (5640, 6640, 7740, 7840, 8240, 8340 - 11/1995 and Later w/ SuperLux Cab), 7635, (8160, 8260, 8360, 8560, TS90, TS100, TS110, TS115 - w/ D3814 Engine w/ SuperLux Cab)	Upper Rear Glass Replaces 5178304, 82005316, VPM7343	AM82016997	\$ 225.00	
	4835, 5635, 6635, 7635, 8160, 8260, 8360, 8560, T5040, T5050, T5060, T5070, TL70, TL70A, TL80, TL80A, TL90, TL90A, TL100, TL100A, TM115, TM120, TM125, TM130, TM135, TM140, TM155, TM165, TM175, TM190, TS90, TS100, TS110, TS115	Lower Rear Glass	AM82000485	\$ 27.00	
	(T8010, T8020, T8030, T8040, T8050 BSN Z8RW08527), TG210, (TG215, TG245, TG275, TG305 BSN Z8RW08527), TG230, TG255, TG285	Weatherstrip For Cab Door	AM87534532	\$ 24.00	
	T8.275, T8.300, T8.320, T8.330, T8.350, T8.360, T8.380, T8.390, T8.410, T8.420, T8.435, (T8010, T8020, T8030, T8040, T8050, TG215, TG245, TG275, TG305 ASN Z8RW08528)	Weatherstrip For Cab Door	AM84160023	\$ 23.10	
	T8.275, T8.300, T8.320, T8.330, T8.350, T8.360, T8.380, T8.390, T8.410, T8.420, T8.435, T8010, T8020, T8030, T8040, T8050, TG210, TG215, TG230, TG245, TG255, TG275, TG285, TG305	Weatherstrip For Rear Cab Window	AM87534532	\$ 24.00	

Ford® / New Holland®—Tractor

Gas Struts



Application	Description	Part Number	Retail Price	Core
8160, 8260, 8360, 8560, TM115, TM120, TM125, TM130, TM135, TM140, TM150, TM155, TM165, TV140, TV145, TV6070 Replaces 82007029	Gas Strut, Hood	AM82019392	\$ 26.00	
TD4020F, TD4030F, TD4040F	Gas Strut, Hood	AM5097656	\$ 43.00	
4835, 5635, 6635, 7635, TL70, TL80, TL80A, TL90, TL90A, TL100, TL100A	Gas Strut, Roof Hatch	AM82002925	\$ 19.00	
5110, 5610, 5640, 6410, 6610, 6640, 6710, 6810, 7610, 7710, 7740, 7810, 7840, 7910, 8210, 8240, 8340, 8530, 8560, 8630, 8730, 8830, TW5, TW15, TW25, TW35	Gas Strut, Roof Hatch	AM83949895	\$ 19.00	
8670, 8670A, 8770, 8770A, 8870, 8870A, 8970, 8970A, T8010, T8020, T8030, T8040, T8050, TG210, TG215, TG230, TG245, TG255, TG275, TG285, TG305	Gas Strut, Door	AM1280263C1	\$ 19.00	
T6000, T7000	Gas Strut, Door Left Hand	AM87374182	\$ 33.00	
TM120, TM130, TM140, TM155, TM175, TM190	Gas Strut, Door	AM82027922	\$ 19.00	
230A, 234, 334, 335, 530A, 1710, 1710O, 1910, 2310, 2610V, 2810, 2910, 3230, 3430, 3610, 3610V, 3910, 3910H, 3910N, 3910R, 3910V, 3930, 3930H, 3930N, 3930NO, 4110, 4110N, 4110NO, 4110O, 4110V, 4130, 4130N, 4130NO, 4610, 4610N, 4610NO, 4610O, 4610SU, 4610V, 4630, 4630N, 4630NO, 4630O, 4830, 4830N, 4830O, 5030, 5030O, 5110, 5610, 6410, 6610, 6610O, 6710, 6810, 7410, 7610, 7610O, 7710, Ind: 45D, 545D	Gas Strut, Rear Window Replaces 3038161M91, 3476187M1, 83932024	AME2NN9444000AA	\$ 15.50	
2310, 2610, 2810, 2910, 3430, 3610, 3910, 3930, 4110, 4130, 4610, 4630, 4830, 5030, 5110, 5610, 6410, 6610, 6710, 6810, 7410, 7610	Gas Strut, Rear Window	AM83932028	\$ 35.00	
4835, 5635, 5640, 6635, 6640, 7635, 7740, 7840, 8160, 8240, 8340, 8360, 8560, TL65, TL70, TL80, TL90, TL100, TM115, TM120, TM125, TM130, TM135, TM140, TM150, TM155, TM165, TM175, TM190, TS90, TS100, TS110, TS115 Replaces 81865239, F0NN9444000BA	Gas Strut, Rear Window	AM82019393	\$ 19.00	
5110, 5610, 6410, 6610, 6710, 6810, 7610, 7710, 7810, 7910, 8210, 8530, 8630, 8730, 8830, TW5, TW15, TW25, TW35	Gas Strut, Rear Window	AME4NN9444000AA	\$ 15.00	
T2310, T2320, T2410, T2420, TC40DA, TC45DA	Gas Strut, Rear Window	AM84320293	\$ 19.00	
T6010, T6020, T6030, T6040, T6050, T6060, T6070, T6080, T7030, T7040, T7050, T7060, TS100A, TS115A, TS125A, TS130A, TS135A	Gas Strut, Rear Window	AM82022486	\$ 19.00	



Fuel Tanks

Application	Description	Part Number	Retail Price	Core
2N, 8N, 9N	Fuel Tank, Metal	AM9N9002	\$ 205.00	
600, 620, 630, 640, 650, 660, 700, 740, 800, 820, 840, 850, 860, 900, 950, 960, NAA, NAB	Fuel Tank For gas models only unless return line has been added for diesel models Tank has option for fuel sender, must be purchased separately Use w/ AM311292 Valve in the bottom of the tank	AMNAA9002E	\$ 245.00	
	Fuel Shut Off Valve	AM311292	\$ 44.00	
600, 800, 900, (2000, 4000 - w/ 4 Cylinder Engines), NAA	Fuel Tank, Metal Only Flat Bottom	AMNAA600	\$ 220.00	





Ford® / New Holland® —Tractor











Steering Wheels

Application	Description	Part Number	Retail Price	Core
8N, 231, 233, 234, 333, 334, 335, 340, 501, 515, 531, 532, 535, 541, 600, 601, 611, 620, 621, 630, 631, 640, 641, 650, 651, 660, 671, 681, 700, 701, 740, 741, 771, 800, 801, 811, 820, 821, 840, 841, 850, 851, 860, 861, 871, 881, 900, 901, 941, 950, 951, 961, 971, 981, 2000, 2120, 2130, 2310 All Purpose, 2600, 2610, 2810, 2910, 3000, 3110, 3120, 3230, 3300, 3310, 3330, 3400, 3430, 3600, 3610, 3900, 3910, 3930, 4000, 4110, 4120, 4130, 4140, 4330, 4340, 4400, 4410, 4600, 4610, 4630, 4830, 5000, 5030, 5100, 5110, 5340, 5600, 5610, 5900, 6600, 6610, 7000, 7600, 7610, NAA, NAB, (2100, 2110 - w/ Power Steering), (2300, 2310 Narrow - w/ Manual Steering)	Steering Wheel 36 Spline, 18" Diameter, 0.785" Hub Diameter	AMD6NN3600B	\$ 20.00	
8N 1948-52, 600, 700, 800, 900, (2000, 4000 - w/ 4-Cylinder Engine 1953-64), NAA, Jubilee	Steering Wheel 17 5/8" Diameter, 36 Spline Hub, 11/16" Shaft	AM8N3600	\$ 26.00	
2N 1939-47, 9N	Steering Wheel 17 5/8" Diameter, Keyed Hub, 11/16" Shaft	AM180576M1	\$ 23.00	
1100, 1110, 1120, 1200, 1210, 1215, 1220, 1320, 1520, 1620, 1720, 1920, 2120, 3415, TC30, TC1510, TC1520	Steering Wheel 15 3/4" Diameter, 18 Spline Hub, 3 1/2" Shaft Replaces 66611-41400, SBA334300050, SBA334310110	AM32400-16800	\$ 64.00	
Major, Super Major	Steering Wheel 6-Spline Hub, 18" Diameter 3 Covered Spokes Replaces 81717476, E1ADKN3600A	AME1ADKN3600	\$ 25.00	

Air Conditioning and Components

Application	Description	Part Number	Retail Price
 5610, 6610, 6710, 6810, 7410, 7610	Compressor Conversion Kit Rotary Tecumseh HR980 to Sanden Includes Compressor, Mounting Bracket, Hoses, O-Rings and Mounting Hardware Requires Pag Oil 100V, 6.76 oz (200 cc)	AMX10189	\$ 595.00
	Ultra Pag Double End Capped, 100V, 8 oz	AMX10267	\$ 12.00
	Universal Pag Oil, 8 oz	AMX10274	\$ 9.00
 5700, 6700, 7700	Compressor Conversion Kit York to Sanden Includes Compressor, Mounting Brackets, Compressor Manifold, Hoses, O-Rings, Belt and Mounting Hardware Requires Pag Oil 100V, 6.76 oz (200 cc)	AMX10195	\$ 595.00
	Ultra Pag Double End Capped, 100V, 8 oz	AMX10267	\$ 12.00
	Universal Pag Oil, 8 oz	AMX10274	\$ 9.00
 5700, 6710, 8000, 8600, 8700, 9000	Compressor Conversion Kit York Style to Aftermarket Sanden Style Includes Compressor, Mounting Brackets, Compressor Manifold, O-Rings and Mounting Hardware See Manufacturer for Oil Type and Quantity	AMX10263	\$ 459.00
	Premium Synthetic Ester Oil, 100V, 12 oz	AMX10273	\$ 11.00
 6610, 6710, 7710	Compressor Conversion Kit Tecumseh, York Upright to Sanden Includes Compressor, Mounting Bracket, Compressor Manifold, Hoses and Mounting Hardware Requires Pag Oil 100V, 6.76 oz (200 cc)	AMX10194	\$ 595.00
	Ultra Pag Double End Capped, 100V, 8 oz	AMX10267	\$ 12.00
	Universal Pag Oil, 8 oz	AMX10274	\$ 9.00

Ford® / New Holland®—Tractor

Application	Description	Part Number	Retail Price
 7710	Compressor Conversion Kit Rotary Tecumseh HR980 to Sanden Includes Compressor, Mounting Bracket, Hose, O-Rings and Mounting Hardware	AMX10190	\$ 595.00
	Compressor to Condenser Hose	AME9NN19N601CA	\$ 97.00
 7810	Compressor Conversion Kit Rotary Tecumseh HR980 Style to Seltec Style Includes Compressor, Mounting Bracket, Hose, O-Rings and Mounting Hardware	AMX10191	\$ 595.00
 7910, 8210	Compressor Conversion Kit Rotary Tecumseh HR980 Style to Sanden Style Includes Compressor, Mounting Bracket, Hose, O-Rings and Mounting Hardware	AMX10192	\$ 595.00
	Compressor to Condenser Hose	AME9NN19N601CA	\$ 97.00
 8700, 9700, TW5, TW10, TW15, TW20, TW25, TW30, TW35	Compressor Conversion Kit Tecumseh, York Upright to Sanden Includes Compressor, Mounting Bracket, Binary Switch, Hoses, O-Rings and Mounting Hardware For R134a Applications Requires Pag Oil 100V, 6.76 oz (200 cc)	AMX10193	\$ 595.00
	Compressor to Condenser Hose	AME9NN19N601CA	\$ 97.00
	Ultra Pag Double End Capped, 100V, 8 oz	AMX10267	\$ 12.00
	Universal Pag Oil, 8 oz	AMX10274	\$ 9.00
 8700, 9700, TW10, TW20, TW30	Compressor Conversion Kit Tecumseh, York Upright to Sanden Style Includes, Compressor, Mounting Bracket, Binary Switch, Hoses, O-Rings and Mounting Hardware For R12 Applications, Must Use Original Belt Requires Pag Oil 100V, 6.76 oz (200 cc)	AMX10196	\$ 595.00
	Ultra Pag Double End Capped, 100V, 8 oz	AMX10267	\$ 12.00
	Universal Pag Oil, 8 oz	AMX10274	\$ 9.00
 TW5, TW15, TW25, TW35	Compressor Conversion Kit Rotary Tecumseh HR980 to Sanden Includes Compressor, Mounting Bracket, Binary Switch, Hose, O-Rings and Mounting Hardware Requires Pag Oil 100V, 6.76 oz (200 cc)	AMX10188	\$ 475.00
	Compressor to Condenser Hose	AME9NN19N601CA	\$ 97.00
	Ultra Pag Double End Capped, 100V, 8 oz	AMX10267	\$ 12.00
	Universal Pag Oil, 8 oz	AMX10274	\$ 9.00
 Versatile®: 750, 800, 825, 835, 850, 855, 875, 895, 900, 935, 950	Compressor Conversion Kit York Style to Sanden Style Single Groove Long Body Replacement Kit, Replaces York/Tecumseh Single Groove w/ 2.82" Gauge Line (measure from front side mounting hole to center groove of clutch on original York)	AMX10241	\$ 490.00
 5100, 5600, 5700, 6600, 6700, 7700, 8000, 8600, 8700, 9000, 9600, 9700	Compressor, York Style Right Hand Suction, Rotolock Clutch Not Included Requires Synthetic Ester Oil 100V, 9.50 oz (281 cc)	AM54-032	\$ 230.00
	Double Groove Clutch for York Compressor, 7"	AM470	\$ 103.00
	Premium Synthetic Ester Oil, 100V, 12 oz	AMX10273	\$ 11.00
 5600, 5700, 6600, 6700, 7600, 7700, Backhoes: 550, 555, 555A, 555B, 655, 655A, 755A, 755B, Versatile®: 700, 750, 800, 825, 835, 850, 855, 875, 895, 900, 935, 950 Replaces 130222, 618606, D2NN19D623A, D3NN19D623A	Compressor, York Style Left Hand Suction, Rotolock Clutch Not Included Requires Synthetic Ester Oil 100V, See Manufacturer for Oil Quantity	AMX10225	\$ 270.00
	Double Groove Clutch for York Compressor, 7"	AM470	\$ 103.00
	Premium Synthetic Ester Oil, 100V, 12 oz	AMX10273	\$ 11.00

Ford® / New Holland®—Tractor

	Application	Description	Part Number	Retail Price
	5640, 6640, 7740, 7840, 8240, 8340, TS90, TS100, TS110, TS115 - 11/1995 and Later Replaces 82008688, 82016157	Compressor, Sanden SD7H15 12 Volt, w/ Serpentine Belt, 4.68" (119 mm) Clutch Diameter, Vertical #8 and #10 O-Rings, w/o Charge Ports Requires Synthetic Ester Oil 100V, 5.46 oz (135 cc) Premium Synthetic Ester Oil, 100V, 12 oz	AMX10129 AMX10273	\$ 270.00 \$ 11.00
	5640, 6640, 7740, 7840, 8240, 8340 - 11/1991-03/94 Replaces F0NN19D629AB, F0NN19D629AA	Compressor, Sanden SD510 Style 12 Volt, w/ 8-Groove Clutch, 5.25" (133 mm) Clutch Diameter, w/o Charge Ports, Top Pad Mount Requires Synthetic Ester Oil 100V, 10.00 oz (300 cc) Premium Synthetic Ester Oil, 100V, 12 oz	AMX10127 AMX10273	\$ 230.00 \$ 11.00
	5640, 6640, 7740, 7840, 8240, 8340 Replaces F0NN19D629AA, F0NN19D629AB	Compressor, Sanden SD510 Style 12 Volt, With 6-Groove Clutch for Serpentine Belt, 4.90" (125 mm) Clutch Diameter, Top Pad Mount Aftermarket Requires R12 Mineral Oil, 6.12 oz (180 cc)	AMX10209	\$ 265.00
	7710, 7740, 7810, 7910, 8000, 8210, 8530, 8630, 8700, 8730, 8830, 9030, 9710, FW20, TW5, TW15, TW25, TW35	Compressor, Sanden SD7H15 Style 12 Volt, w/ 2-Groove Clutch, 5.19" (132 mm) Clutch Diameter, O-Ring Connections, w/o Charge Ports Requires Pag Oil 100V, 6.76 oz (200 cc) Ultra Pag Double End Capped, 100V, 8 oz Universal Pag Oil, 8 oz	AME8NN19D629AA AMX10267 AMX10274	\$ 250.00 \$ 12.00 \$ 9.00
	8160, 8260, 8360, 8560, TM115, TM120, TM125, TM130, TM135, TM140, TM150, TM155, TM165, TM175, TM190, TV140, TV145 Replaces 82008689, 82002069	Compressor, Sanden SD7H15 Style 12 Volt, w/ 8-Groove Clutch for Serpentine Belt, 4.68" (119 mm) Clutch Diameter, Vertical #8 and #10 O-Ring Requires Synthetic Ester Oil 100V, 4.56 oz (135 cc) Premium Synthetic Ester Oil, 100V, 12 oz	AM82016158 AMX10273	\$ 270.00 \$ 11.00
	8670, 8770, 8870, 8970 - 1993 and Later Replaces 9824775	Compressor w/ Dust Cover, Sanden 12 Volt, w/ Serpentine Clutch, 5.19" (132 mm) Clutch Diameter, Horizontal #8 and #10 O-Ring Requires Synthetic Ester Oil 100V, 9.13 oz (270 cc) Premium Synthetic Ester Oil, 100V, 12 oz	AMX10128 AMX10273	\$ 281.00 \$ 11.00
	9030V, 9184, 9280, 9282, 9384, 9480, 9484, 9682, 9684, Versatile®: 2360, 2375	Compressor, Sanden SD7H15 12 Volt, w/ 2-Groove Clutch, 5.25" (133 mm) Clutch Diameter, Horizontal Tube O-Ring, w/o Charge Ports Requires Synthetic Ester Oil 100V, 10.14 oz (300 cc) Premium Synthetic Ester Oil, 100V, 12 oz	AMX10187 AMX10273	\$ 275.00 \$ 11.00
	FW20 Replaces SFD351224T91	Compressor, Sanden SD508 Style 12 Volt, w/ 2-Groove Clutch, 5.19" (132 mm) Clutch Diameter, Vertical #8 and #10 Flare Fittings, w/ R12 Charge Ports Requires R12 Mineral Oil, 5.91 oz (175 cc)	AMX10178	\$ 260.00
	(T4020, T4030, T4040, T4050 - Deluxe), T4020V, T4030F, T4030N, T4030V, T4040F, T4040N, T4040V, T4050F, T4050N, T4050V, T4060F, T4060N, T4060V, T5040, T5050, T5060, T5070, (T4.65, T4.75 - Non Tier 4A), T4.65V, T4.75F, T4.75V, T4.85F, T4.85V, T4.95F, T4.95V, T4.105F, T4.105V, TD5010, TD5020, TD5030, TD5050	Compressor, Sanden SD7H15 12 Volt, w/ 4-Groove Serpentine Clutch, 4.409" (112 mm) Clutch Diameter Requires Pag Oil 100V, 6.46 oz (190 cc) Ultra Pag Double End Capped, 100V, 8 oz Universal Pag Oil, 8 oz	AM87519620 AMX10267 AMX10274	\$ 260.00 \$ 12.00 \$ 9.00
	T8010, T8020, T8030, T8040, T8050, T9030, T9040, T9050, T9060, T8.330, TG210, TG215, TG230, TG245, TG255, TG275, TG285, TG305, TJ375, TJ425, TJ450, TJ480, TJ500, TJ530 Replaces 504078610, 86992688, 87775469	Compressor, Sanden SD7H15HD 12 Volt, w/ 8-Groove Clutch, 5.98" (152 mm) Clutch Diameter, Horizontal Tube O-Ring, Direct Mount Requires Pag Oil 100V, 9.64 oz (285 cc) Ultra Pag Double End Capped, 100V, 8 oz Universal Pag Oil, 8 oz	AM86993463 AMX10267 AMX10274	\$ 281.00 \$ 12.00 \$ 9.00
	Versatile®: 700, 750, 800, 825, 835, 850, 855, 875, 895, 900, 935, 950	Compressor Clutch SCSA06C Clutch, 4.80" Coil w/ 1/2" Single Groove, Splined-Type Shaft	AM6A671-97310	\$ 173.00











Ford® / New Holland®—Tractor

	Application	Description	Part Number	Retail Price
	Universal Equipment	Low Pressure Switch Normally Open, Opens at 35 PSI, Closes at 46 PSI, Standard 7/16"x20 Thread	AMX10278	\$ 42.00
	Universal Equipment	Low Pressure Switch Normally Open, Opens at 6 PSI, Closes at 45 PSI, Standard 7/16"x20 Thread	AMX10277	\$ 56.00
	TG210, TG230, TG255, TG285, TJ425, TJ430, TJ450, TJ500	Low Pressure Switch Normally Open, Opens at 5 PSI, Closes at 18 PSI, 10 mm Metric Thread	AM87000228	\$ 45.00
	Universal Equipment	High Pressure Switch Normally Open, Opens at 305 PSI, Closes at 395 PSI, 7/16"x20 Thread	AMX10276	\$ 36.00
	233, 333, 2600, 3600, 4100, 4600, 5110, 5600, 5610, 5700, 6410, 6600, 6610, 6700, 6710, 6810, 7410, 7600, 7610, 76100, 7700, 7710, 7810, 7910, 8000, 8210, 8530, 8630, 8700, 8730, 8830, 9000, 9700, TW5, TW10, TW15, TW20, TW25, TW30, TW35	Rotary Adjustable Thermostatic Switch 19 1/2" Capillary Tube Replaces D6NN19N683B	AM87015296	\$ 113.00
	256, 276, 836, 7840, 8000, 8200, 8240, 8340, 8600, 8700, 9000, 9030, 9200, 9600, 9700, 9710 (Replaces D3NN19618A), Ind: 8400, Versatile®: 256, 276, 500, 555, 700, 750, 756, 800, 825, 835, 836, 850, 855, 856, 875, 876, 895, 900, 935, 945, 950, 955, 975, 1150, 1156, D6 (Replaces 9672323)	Rotary Adjustable Thermostatic Switch 36" Capillary Tube	AMX10251	\$ 50.00
	4835, 5635, 6635, 7635, T5040, T5050, T5060, T5070, TD60D, TD70D, TD75D, TD80D, TD90D, TD95D, TD5050, TL70, TL80, TL80A, TL90, TL90A, TL100, TL100A, TN60DA, TN60SA, TN70DA, TN70SA, TN75DA, TN75SA, TN85DA, TN95DA	Receiver Drier w/o High Pressure Switch	AM5165615	\$ 39.00
	Ford®/New Holland® Tractors: (5110, 5610, 6610, 6710, 6810, 7410, 7610, 7710 - 1981-85), (7910, 8210, TW5, TW15, TW25, TW35 - 1982-85), (8700, 9700, TW10, TW20, TW30 - 1981 and Later) Replaces E2NN19825AA, E0NN19825AA14L	Receiver Drier 4" x 9 1/2", Inlet - #6 Female O-Ring, Outlet - #6 Female O-Ring, R12 and R134a Compatible	AMX10157	\$ 39.00
	(5110, 5610, 6610, 6710, 6810, 7410, 7610, 7710, 7910, 8210 - 1985 and Later), 7810 1988 and Later, 8530, 8630, 8730, 8830, (TW5, TW15, TW25, TW35 - 1985 and Later) Replaces E4NN19825AB, E4NN19825AA	Receiver Drier 4" x 7 1/4", Inlet - #6 Male O-Ring, Outlet - #6 Male O-Ring, R12 and R134a Compatible	AMX10158	\$ 38.00
	5600, 5700, 6600, 6700, 7700, 8000, 8700, 9000, 9700, TW10, TW20, TW30 Replaces D6NN19N644B	Receiver Drier 4" x 7 1/2", Side Mount Bracket, R12 and R134a Compatible, Inlet: #8 Quick Coupler, 7/8"-20 Thread, Outlet: #6 Male O-Ring	AMX10179	\$ 29.00
	(5640, 6640, 7740, 7840, 8240, 8340 - 1991-95) Replaces F0NN19825AB, F0NN19825AC, 82000471	Receiver Drier 3" x 15", Inlet - #6, 3/8" Ford Springlock, Outlet - #6, 3/8" Ford Springlock, R12 and R134a Compatible	AMX10159	\$ 45.00
	(5640, 6640, 7740, 7840, 8240 8340 - 1995 and Later), 8160, 8260, 8360, 8560, TM115, TM125, TM135, TM150, TM165, TS90, TS100, TS110, TS115 Replaces 82007131, 82015699, 82012480	Receiver Drier 3" x 10", Inlet - #6 Male O-Ring, Outlet - #6 Female O-Ring, R12 and R134a Compatible	AMX10160	\$ 48.00







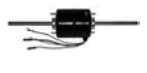



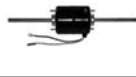

Ford® / New Holland®—Tractor

	Application	Description	Part Number	Retail Price
	8000, 8600, 9000, 9600 Replaces D3NN19825A	Receiver Drier 3" x 6" Male Flare, R12 and R134a Compatible	AMX10211	\$ 22.00
	8970A, 8670, 8670A, 8770, 8770A, 8870, 8970, 8870A Replaces 86508374	Receiver Drier 3" X 10", Inlet - #6 Male O-Ring, Outlet - #6 Female O-Ring R12 and R134a Compatible	AM86026354	\$ 46.00
	9030, 9030E, 9030V, Versatile®: 150, 276, 836, 846, 856, 876, 936, 946, 976 Replaces 9672494, 9827053	Receiver Drier 3" x 10 1/2" Male O-Ring, R12 and R134a Compatible	AMX10218	\$ 27.00
	9030V, 9280, 9282, 9384, 9480, 9482, 9680, 9682, 9684, 9880, 9882, 9884 Reference 9705765	Receiver Drier 3" x 9" Male O-Ring, Male Switch Port, R12 and R134 Compatible	AMX10205	\$ 27.00
	FW20, FW30, FW40, FW60 Replaces SFD605818T3	Receiver Drier 3" x 9 1/2" Male Flare, Male Switch Port, R12 and R134a Compatible	AMX10210	\$ 32.00
	B125A, T6010, T6020, T6030, T6040, T6050, T6060, T6070, T6080, T7030, T7040, T7050, T7060, TM115, TM120, TM125, TM130, TM135, TM140, TM150, TM155, TM165, TM175, TM190, TS100A, TS110A, TS115A, TS130A, TS135A, TV145 Replaces 87374420, 82023593, 87343822	Receiver Drier 2 1/2" x 6" Male and Female O-Ring, R12 and R134a Compatible	AMX10214	\$ 34.00
	Versatile®: (900, 700 1972-12/75), (800, 850 1973-12/75) Replaces V18395, V107619	Receiver Drier 3" x 8 1/4" Male Flare, Female Switch Port - OE Parker, R12 and R134a Compatible	AM72161835	\$ 30.00
	4635, 4835, 5635, 6635, 7635, T4050F, T4050V, T5030, T5040, T5050, T5060, T5070, T7510, T7520, T7530, T7540, T7550, TL70, TL70A, TL80, TL80A, TL90, TL90A, TL100, TL100A, TN55D, TN55S, TN60DA, TN60SA, TN65D, TN65S, TN65V, TN70D, TN70DA, TN70F, TN70S, TN70SA, TN75D, TN75DA, TN75F, TN75FA, TN75S, TN75SA, TN75V, TN80, TN80F, TN85DA, TN85FA, TN90F, TN95DA, TN95F, TN95FA, TN95VA Replaces 82002793	Expansion Valve Flange Type, O-Ring Connection, R12 and R134a Compatible	AMX10260	\$ 26.00
	5510 1985 and Later, (5600, 5700, 6600, 6700, 7700 - 1977 and Later), (5610, 7810 - 1988 and Later), (6610, 6710, 6810, 7410, 7610, 7710 - 1981 and Later), (7910, 8210, TW5, TW25, TW35 - 1982 and Later), (8000, 8600, 9000, 9600 - 1973 and Later), 8530, 8630, (8700, 9700, TW10, TW20 - 1976 and Later), 8730, 8830, TW15 - 1982 and Later, TW30 - 1976 and Later Replaces D3AH19849AA, D6AH19849AA, E7NN198499AA, 83906905, 83960933, 87022814	Expansion Valve Bulb Type, Externally Equalized, R12 and R134a Compatible, 28" Tube Length, O-Ring Connection	AMX10148	\$ 18.00

Ford® / New Holland®—Tractor

	Application	Description	Part Number	Retail Price
	(5640, 6640, 7740, 7840, 8240, 8340 - 1991 and Later), 8160, 8260, 8360, 8560, TM115, TM120, TM125, TM130, TM135, TM140, TM150, TM155, TM165, TM175, TM190, TS90, TS100, TS110, TS115 Replaces F0NN19849AB, 82000932	Expansion Valve Block Type, R12 and R134a Compatible, O-Ring Connection	AMX10149	\$ 40.00
	8670, 8670A, 8770, 8770A, 8870, 8870A, 8970, 8970A, T8010, T8020, T8030, T8040, T8050, T9020, T9030, T9040, T9050, T9060, TG210, TG215, TG230, TG245, TG255, TG275, TG285, TG305, TJ280, TJ330, TJ275, TJ325, TJ375, TJ380, TJ425, TJ430, TJ450, TJ500, TL70, TJ530, TJ480, TL80, TL90, TL100, TV145 Replaces 86505794	Expansion Valve Block Type, R12 and R134a Compatible, O-Ring Connection	AMX10150	\$ 27.00
	FW20, FW30, FW40, FW60 Replaces F3960933, 83906905, 83915986, 83972479	Expansion Valve Internally Regulated w/ 1/2" Capacity Tube w/ Flare Connection, R12 and R134a Compatible	AMX10215	\$ 31.00
	T6010, T6020, T6030, T6050, T6060, T6070, T6080, T6090, T7030, T7040, T7050, T7060, T7070, T7.165, T7.170, T7.175, T7.185, T7.190, T7.195S, T7.200, T7.210, T7.215S, T7.220, T7.225, T7.230, T7.235, T7.245, T7.250, T7.260, T7.270, T7.315, TM120, TM130, TM140, TM155, TM175, TM190, TS100A, TS110A, TS115A, TS130A, TS135A	Trinary Switch 7/16"x20 Female Thread Replaces 82019426, 87699591	AM84233818	\$ 56.00
	TV140, TV145 Replaces ABPN83308011, F1NN19849AA	Expansion Valve Block Type, R12 and R134a Compatible, O-Ring Connection	AMX10151	\$ 24.00
	T8010, T8020, T8030, T8040, T8050, TG215, TG245, TG275, TG305	Condenser to Receiver Drier Hose	AM87312057	\$ 57.00
	T8.380, T8.410, T8.435	Condenser to Receiver Drier Hose	AM84242790	\$ 69.00
	T8.275, T8.300, T8.320, T8.330, T8.350, T8.360, T8.380, T8.390, T8.410, T8.420, T8.435	Receiver Drier to Cab Drier, End Hose	AM47460967	\$ 57.00
	(5640, 6640, 7740 - w/ Sanden Compressor), TS90, TS100, TS110, TS115	Return Line, Front Rubber Suction Hose Replaces Original Steel Line Replaces 82009874, 82013168, 82026275	AMX10283	\$ 65.00
	9280, 9282, 9480, 9482, 9880, 9882, 9884, TV140	Blower Motor Assembly	AM9705742	\$ 260.00
	TG210, TG215, TG230, TG245, TG255, TG275, TG285, TG305, TJ275, TJ280, TJ325, TJ330, TJ375, TJ380, TJ425, TJ430, TJ480, TJ500, TJ530, T9020, T9030, T9040, T9050, T9060	Blower Motor Assembly 12 Volt, Resistor Not Included Replaces 323610A1	AM84222524	\$ 153.00
	233, 333, 1118, 2600, 3600, 4100, 4600, 5110, 5600, 5610, 5700, 6600, 6610, 6700, 6710, 6810, 7410, 7600, 7610, 7700, 7710, (8000, 9000 - 10/1976 and Later), 8600, 9600, (8700, 9700, TW10, TW20, TW30 - 08/76-12/81) Replaces D5NN18527A	Blower Motor 3-Speed, Double Shaft, 4-Wire, Reversible, 3/8" Shaft Diameter, 4 1/4" Long	AMX10120	\$ 82.00

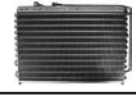

Ford® / New Holland® —Tractor

Application	Description	Part Number	Retail Price
 <p>2600, 3600, 4100, 4600, 5110, 5600, 5610, 5700, 6600, 6610, 6700, 6710, 6810, 7410, 7600, 7610, 7700, 7710, 7810, 7910, 8210, 8530, 8630, 8670, (8700, 9700, TW5, TW10, TW15, TW20, TW25, TW30, TW35 - 1982 and Later), 8730, 8830, 9184, 9280, 9282, 9384, 9480, 9482, 9484, 9680, 9682, 9684, 9880, 9882, 9884, Ind: 233, 333, Versatile®: 276V, 276V-II, 836V, 846V, 856V, 876V, 936V, 946V, 956V, 976V, 1156V, 9030E, 9030V Replaces 86010530</p>	Blower Motor, Vented Single Speed, Double Shaft, 2-Wire, Reversible, 3/8" Shaft Diameter, 4 3/8" Long	AMX10118	\$ 110.00
 <p>8670, 8670A, 8770, 8770A, 8870, 8870A, 8970, 8970A Replaces 86508360</p>	Blower Motor Single Speed, Double Shaft, 2-Wire, Reversible, 5/16" Shaft Diameter, 3 5/8" Long	AMX10111	\$ 56.00
 <p>500, 555, 700, 750, 800, 825, 835, 850, 855, 875, 895, 900, 935, 945, 950, 955, 975 Replaces V56663, N7389</p>	Blower Motor 12 Volt, Vented Motor, Reversible Single Speed, 2-Wire Motor w/ 3/8" Shaft	AMX10221	\$ 115.00
 <p>5640, 6640, 7740, 7840, 8160, 8240, 8260, 8340, 8360, 8560, TM115, TM120, TM125, TM130, TM135, TM140, TM150, TM155, TM165, TM175, TM190, TS90, TS100, TS110, TS115 Replaces 81870361, F0NN18456AA, F0NN18456AB</p>	Blower Motor Double Shaft, 2-Wire, 5/16" Shaft Diameter, 2 1/4" and 2 1/2" Long	AMX10115	\$ 102.00
 <p>FW20, FW30, FW40, FW60 - 1977 and Later Replaces SFD014005T1</p>	Blower Motor 12 Volt, 3-Speed, Single Shaft, 6-Wire, Reversible, Stud or Strap Mount, 5/16" Shaft Diameter, 1 3/4" Long	AMX10106	\$ 77.00
 <p>500, 555, 700, 750, 800, 825, 835, 850, 855, 875, 895, 900, 935, 945, 950, 955, 975 Replaces V56663, N7389</p>	Blower Wheel Reversible, Double Vented, Steel Wheel, 3 3/4" Diameter, 4" Long, 3/8" Shaft	AMX10212	\$ 21.00
 <p>5110, 5610, 6410, 6610, 6710, 6810, 7410, 7610, 7710, 7810, 7910, 8210, 8530, 8630, 8730, 8830, TW5, TW15, TW25, TW35</p>	Blower Wheel, Steel 3.75" Diameter, 4" Long, 0.375" Shaft, Double Vented Replaces 83953316, E5NN18459AA, E5NN18459BA	AMH84107	\$ 13.00
 <p>6610, 6810, 7410, 7610, 7700, 7710, 7810, 7910, 8700, 9700, TW10, TW20, TW30, Backhoes: 555, 550, 555A, 555B Replaces D5NN18459A</p>	Blower Wheel, Right Hand, CW Blower Wheel, Left Hand, CCW Double Vented Steel, 4 1/4" Diameter, 3/8" Shaft, Offset 2 1/4", 3 1/2"	AMX10217 AMX10216	\$ 30.00 \$ 27.00
 <p>2600, 2610, 3600, 3610, 3910, 4100, 4110, 4600, 4610, 5600, 5610, 5640, 5700, 6410, 6600, 6610, 6640, 6700, 6710, 6810, 7410, 7600, 7610, 7700, 7710, 7740, 7810, 7910, 8160, 8210, 8240, 8260, 8340, 8360, 8530, 8560, 8630, 8700, 8730, 8830, 9700, TM115, TM120, TM125, TM130, TM135, TM140, TM150, TM155, TM165, TM175, TM190, TW5, TW10, TW20, TW25, TW30, TW35</p>	Blower Motor Switch 3-Speed	AMD5NN15122A	\$ 19.00
 <p>T2310, T2320</p>	Blower Motor Switch 3-Speed Replaces 168822C1, 168822C2, AH84588	AMX10261	\$ 16.00
 <p>TD80D, TD90D, TD95D</p>	Condenser Core: 18" x 12" x 2.75" Replaces 5094971, 5096603	AM84215855	\$ 295.00
 <p>5110, 6710, 6810, 7410, 7710, 7910, 8210</p>	Condenser w/ Oil Cooler Core: 16 3/8" x 19" x 2"	AME1NN19N656BA15M	\$ 281.00
 <p>5610, 6610, 7610, 7810</p>	Condenser Overall: 15 3/4" x 13 1/2" Core: 13" x 11" x 2 1/2"	AME0NN19710AB	\$ 395.00

Ford® / New Holland®—Tractor

Application	Description	Part Number	Retail Price
 (8530, 8630, 8700, 9700 - 1979 and Later), (TW5, TW10, TW15, TW20, TW25 - 1979 and Later w/ Cooler)	Condenser Overall: 23" x 18" x 19" Core: 18" x 2.75"	AME5NN19N656BA	\$ 390.00
 (8670, 8770, 8870 - w/ Condenser in front of Oil Cooler)	Condenser Core: 21 1/2" x 26" x 1 1/4"	AM86501402	\$ 375.00
 T5040, T5050, T5060, T5070, T4.55, T4.65, T4.75, PowerStar™ 65, PowerStar™ 75	Condenser Serpentine Style Rows Core: 19" x 14" x 1.25"	AM87542953	\$ 245.00
 T6030, T6050, T6070, T6080	Condenser Core: 15.625" x 20.50" x 0.875" Replaces 87574212	AM87641371	\$ 383.00
 T9020, T9030, T9040, T9050, TJ275, TJ280, TJ325, TJ330, TJ380, TJ425, TJ430, TJ450, TJ500	Condenser	AM87315600	\$ 608.00
 (TD70D, TD80D, TD90D, TD95D - Tier 2), TD95DHC, TD5010, TD5020, TD5030, TD5050	Condenser Non-Serviceable Must Use Original Mounting Brackets Serpentine Style Rows Core: 15.50" x 20" x 1.25"	AM84342887	\$ 370.00
 TL70, TL80, TL90, TL100	Condenser Core: 19.25" x 15.75" x 2"	AM5166770	\$ 434.00
 TM120, TM130, TM140, TM155, TM175, TM190 Replaces 82019424, 82019425, 82023592	Condenser Core: 20" x 2 3/4" x 11 3/4"	AM82033407	\$ 315.00
 (TW5, TW15, TW25 - 1983-12/89 w/o Cooler)	Condenser w/o Oil Cooler Overall: 22 1/8" x 9" Core: 17 1/2" x 9" x 2"	AMD8NN19710BB	\$ 315.00
 (5110, 5610, 6610, 6710, 6810, 7410, 7610, 7710, 7910, 8210 - 1981-9/85), 8700, 9700, TW10, TW20, (TW5, TW15, TW25, TW35 - 1982-85)	Evaporator Bulb Type Valve Overall: 30 3/4" x 6 1/4" x 6 1/2" Core: 19" x 6" x 4 3/8"	AME0NN18N315AA	\$ 315.00
 (5110, 5610, 6610, 6710, 6810, 7410, 7610, 7710, 7910, 8210, 8530, 8630, 8730, 8830, TW5, TW15, TW25, TW35 - 10/1985 and Later), 7810 02/1988 and Later	Evaporator w/ Heater Core Bulb Type Valve Core: 19" x 4 1/2" x 6" Overall: 27 1/2" x 6" x 8 1/2"	AME4NN18N315AD	\$ 917.00
 2600, 3600, 4100 After 12/1974, 4600, 4600SU, 5600, 5700, 6600, 6700, 7600, 7700, 8000, 8700, 9000, 9700, TW10, TW20, TW30	Evaporator	AMD5NN18N315C	\$ 350.00
 5640, 6640, 7740, 7840, 8160, 8240, 8260, 8340, 8360, 8560, TS100, TS110	Evaporator Core: 25 1/2" x 5" Replaces 82034855	AM82009238	\$ 350.00
 (8670, 8770, 8870, 8970 - 06/1996 and Later)	Evaporator Block Type Valve Overall: 27 3/4" x 3 1/8" x 6" Core: 23 3/8" x 3 1/8" x 6"	AM86014818	\$ 260.00
 T6010, T6020, T6030, T6040, T6050, T6060, T6070, TS100A, TS110A, TS115A, TS125A, TS130A, TS135A	Evaporator Core: 18 3/4" x 5" x 6 3/4"	AM82033007	\$ 308.00

Ford® / New Holland® —Tractor

Application	Description	Part Number	Retail Price
 T6010, T6020, T6030, T6040, T6050, T6060, T6070, T6080, T6090, T7030, T7040, T7050, T7060, T7070, T6.120, T6.125, T6.140, T6.145, T6.150, T6.155, T6.160, T6.165, T6.175, T6.180, T7.165, T7.170, T7.175, T7.185, T7.190, T7.200, T7.210, T7.220, T7.225, T7.230, T7.235, T7.245, T7.250, T7.260, T7.315, TS100A, TS110A, TS115A, TS125A, TS130A, TS135A	Evaporator Core: 18 1/2" x 3 3/4" x 5"	AM82033008	\$ 265.00
 TD80D, TD90D, TD5030, TD5050, TM115, TM120, TM125, TM130, TM135, TM140, TM150, TM155, TM165, TM175, TM190	Evaporator Core: 25 1/2" x 3 1/8" x 5"	AM82034855	\$ 357.00

Shop Manuals and Collections

I&T Shop Service Manuals provide the information you need to service virtually any make or model of wheel-type farm tractor. Easy-to-follow procedures, detailed illustrations and comprehensive specifications help guide you through complete tractor maintenance and repair with accuracy and efficiency.



Application	Description	Part Number	Retail Price
Series: 2N, 8N, 9N	Ford®	IT-FO-4	\$ 34.00
Models: NAA	Ford®	IT-FO-19	\$ 34.00
Series: 501, 600, 601, 700, 701, 800, 801, 900, 1801, (2000, 4000 - w/ 4 Cylinder Engines)	Ford®	IT-FO-20	\$ 34.00
Series: (2000, 3000, 4000 - w/ 3 Cylinder Engines) Covers Models Prior to 1975	Ford®	IT-FO-31	\$ 34.00
Models: 2310, 2600, 2610, 3600, 3610, 4100 1974 and Later, 4110, 4600, 4610 Prior to 1984, 4600SU, 4610SU Prior to 1984	Ford®	IT-FO-41	\$ 34.00
Series: 5000, 5600, 5610, 6600, 6610, 6700, 6710, 7000, 7600, 7610, 7700, 7710	Ford®	IT-FO-42	\$ 34.00
Models: 1100, 1110, 1200, 1210, 1300, 1310, 1500, 1510, 1700, 1710, 1900, 1910, 2110	Ford®	IT-FO-44	\$ 34.00
Models: TW5, TW15, TW25, TW35	Ford®	IT-FO-45	\$ 34.00
Models: 1120, 1220, 1320, 1520, 1720, 1920, 2120	Ford®	IT-FO-46	\$ 34.00
Models: 3230, 3430, 3930, 4630, 4830	Ford®	IT-FO-47	\$ 34.00
Models: 2000 Super Dexta, 5000 Super Major, Commander 6000, Fordson Dexta, Fordson Super Dexta, Fordson Major Diesel, Fordson Power Major, Fordson Super Major, New Performance Fordson Major, New Performance Super Dexta, TW10, TW20, TW30, Series: 1000, 1600, 6000, 8000, 8600, 8700, 9000, 9600, 9700	Ford Collection®	IT-FO-201	\$ 32.00
Models: 5640, 6640, 7740, 7840, 8240, 8340	Ford®	IT-FO-48	\$ 34.00

Air Conditioning Parts and Components



Blower Motors • Compressors • Condensers
Evaporators • Expansion Valves • Receiver Driers

Rims are Available

For Ford®/New Holland®
Tractors



Single Rims



Dual Rims

Engine Solutions



**We are your super supplier of
HIGH-QUALITY Engine Parts!**

New/Used/Reman Engines
Cylinder Heads
Connecting Rods

Turbochargers
Engine Oil Pumps
Bearings and Seal Kits

Cam and Lifter Kits
Crankshafts
AND MANY MORE!



Overhaul Kits | Cylinder Components | Bearings | Gaskets | Camshaft Components | Crankshaft Components | Head Components | Manifolds | Injection Components | Turbos | Oil and Cooling Systems

**Variety
Quality
Availability**

In kits or individual components
to get your machine
back in the field!

**ADVANTAGE**
ENGINE PARTS®



Engine Overhaul Kits and Parts

To succeed, farms depend on their equipment's ability to perform day-in, day-out. Make sure your engine is up to the task. Whether you need to make a quick repair or want to fine-tune your entire engine, we can help with our extensive inventory of high-quality overhaul kits and engine parts.

Multiple Options

We offer a wide variety of overhaul kits to fit any need. Our kits cover diesel and gas machines and are built to fit most makes, including John Deere®, Case IH®, International®, Ford®, New Holland®, Allis Chalmers® and more. We offer remanufactured shortblocks and longblocks. We also carry inframe and complete remanufactured engines, as well as used engines to fit any need and budget.

Components

Our high-quality component parts are thoroughly tested and competitively priced. Kits range from basic to comprehensive and may include:

- Cylinder kits
- Piston pin bushings
- Rod bearings
- Main bearings
- Camshaft bushings
- Camshaft plug
- Front and rear crankshaft seals
- Gasket set with seals
- Connecting rod bolts

One-Year Warranty

Abilene Machine offers a standard one-year warranty on new, used and remanufactured parts for peace of mind.

Abilene Machine is a family-owned and operated company that's been serving farmers for over 40 years. With an inventory of more than 40,000 parts and four locations across the United States, we'll make sure you get dependable, durable parts shipped fast.

Abilene, Kansas
Bishopville, South Carolina
Sioux Falls, South Dakota
Billings, Montana

785-670-6741
AbileneMachine.com

All parts are new unless designated remanufactured in the description. Products listed are replacement parts only — not original equipment manufacturers. OEM names and brands are used for identification purposes only.

LED Lights

LED kits and single replacement lights available for tractors, combines, harvesters, balers, loaders, skid steers, telehandlers and more.



Grammer® Seats and Suspensions



Abilene Machine LLC

785-670-6741

Kansas | Montana | South Carolina | South Dakota

AbileneMachine.com



Abilene Machine LLC
P.O. Box 129
Abilene, KS 67410
(785) 670-6741

Honest. Personal. Service.

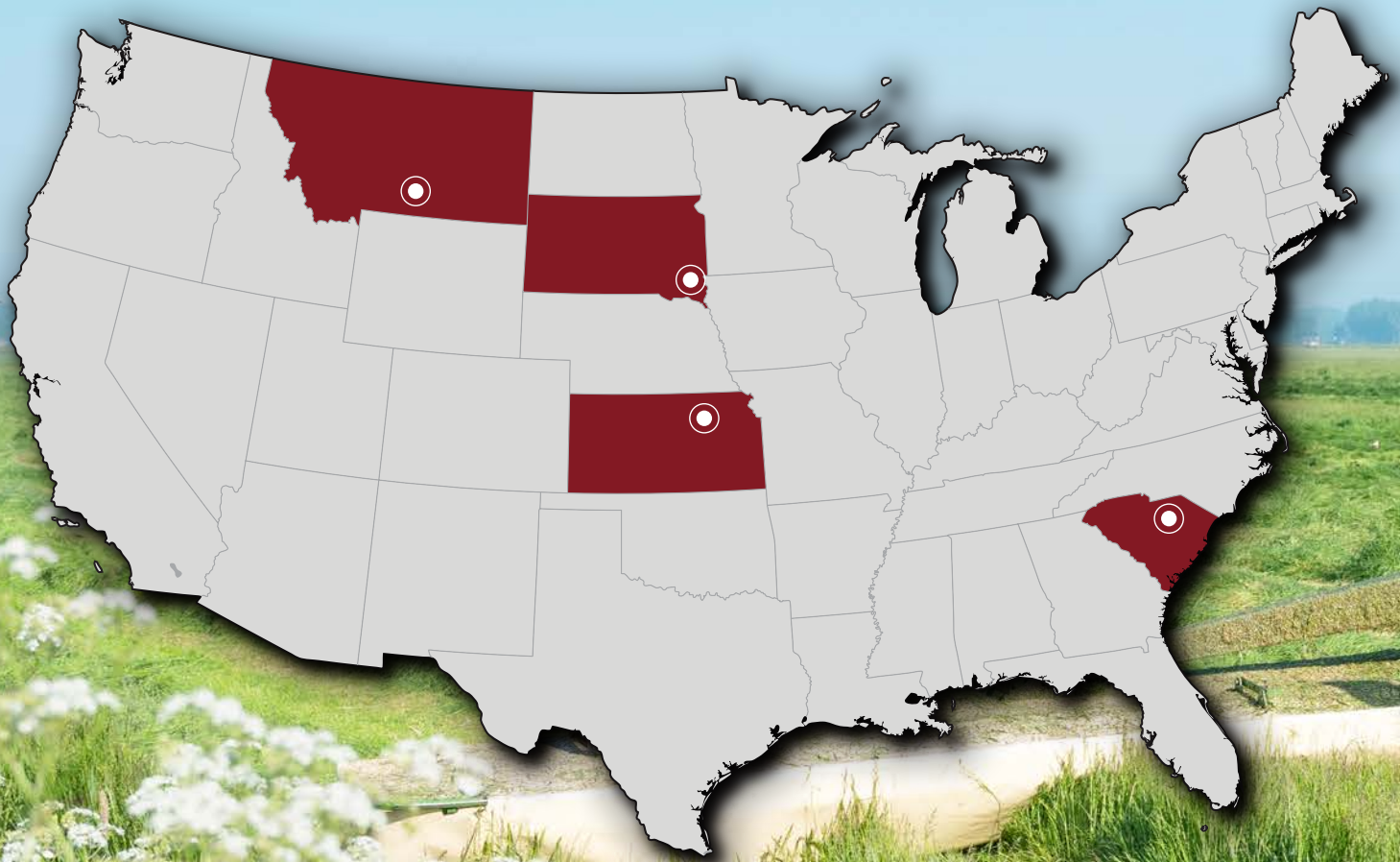

Abilene Machine LLC
(785) 670-6741



AbileneMachine.com



 Follow Abilene Machine on Facebook

©2023 Abilene Machine LLC. Abilene Machine® is a registered trademark of Abilene Machine LLC.

January 2023