



AbileneMachine[®]
Ag Replacement Parts

FOR JOHN DEERE[®]
COMBINES



AbileneMachine.com

NEW My Shed Feature on AbileneMachine.com

A new way to narrow down your parts search geared specifically to your equipment

Select the make, equipment and model of your machine in the dropdown menus located at the top of the home page. Click the "Go" button.

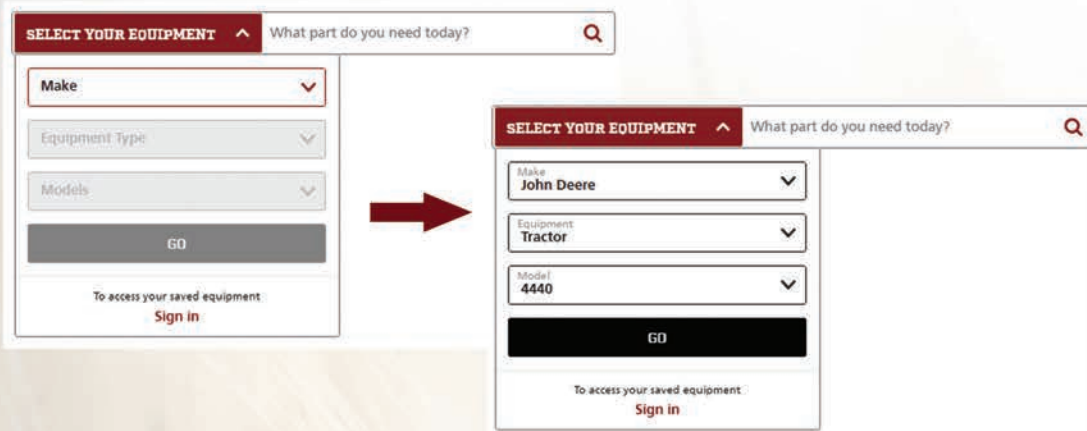

With your equipment selected, enter the product you are searching for (or part number if you have it). Suggested results will be displayed, or press enter to go to a list of all product results for your machine.

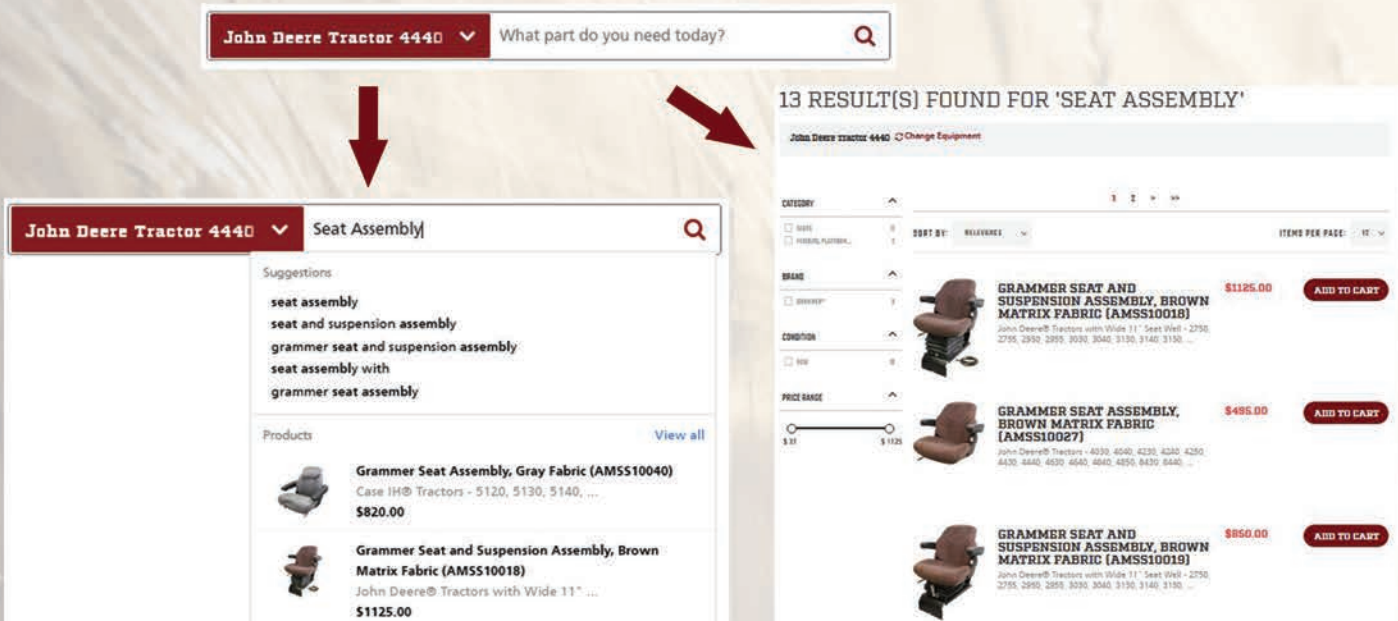

With the My Shed feature, your equipment selections can now be saved to your account to make future searching convenient and easy!

Once you create an account to access "My Shed," your equipment can be saved and you can also view past order history. This makes yearly maintenance easier and faster when it comes to getting the parts you need.

To create an account, select the Account icon to the right of the search bar and select "Create an account."



Follow the next screen to enter your information and create the account. If you made an equipment selection in the parts search, it will automatically be added to "My Shed" and will also be viewable on your Account Dashboard. Additional equipment can be added by clicking the "Add Equipment" button from either screen (prompts the dropdown menu at the top to open again) or by going directly to the parts search at the top of the page and making a new selection. When you hit "Go," this selection is automatically added to your shed.

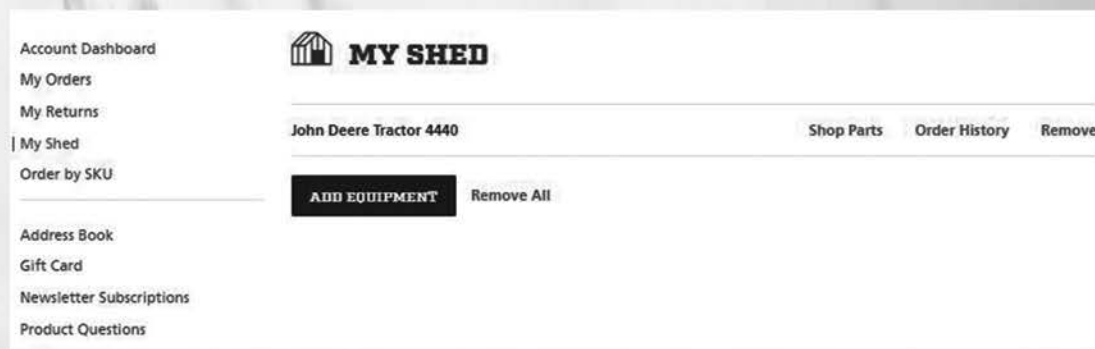

Quickly switch between equipment in your Shed by clicking the dropdown menu at the top of the page and selecting between machines. The page will reload to that selection and is ready to search for the products you need. As a thank you for reading about our new My Shed program, please use the code MYSHED22 for a 5% discount on one order through December 31, 2022.

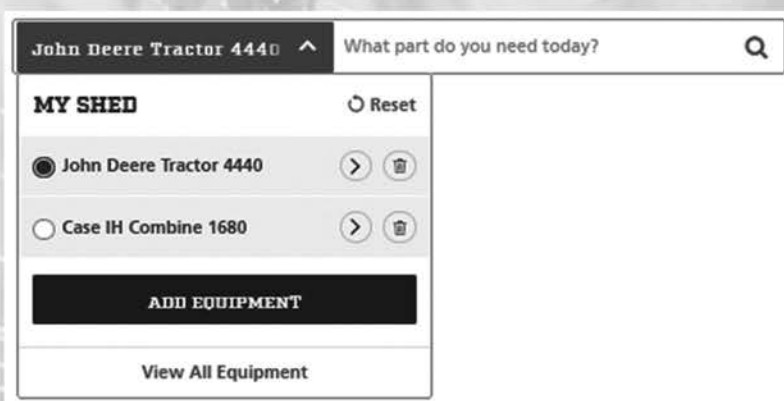

Abilene Machine LLC

Kansas & Montana: 800-255-0337

South Carolina: 800-543-2451

South Dakota: 844-340-4020

AbileneMachine.com

John Deere®—Combine

Table of Contents

Air Conditioning and Components.....	127
Alternators.....	6
Auger Extension Kits.....	71
Auger Tubes—Grain Bin Loading.....	60
Augers & Components—Bare Header / Platform.....	102
Augers & Components—Lower Clean Grain.....	53
Augers & Components—Lower Return.....	55
Augers & Components—Top Tailing Return.....	57
Augers & Tubes—Horizontal Unloading.....	67
Augers & Tubes—Vertical Unloading.....	66
Augers—Bottom Bin Cross.....	64
Augers—Distribution.....	62
Augers—Grain Bin Loading.....	58
Auger Supply Shafts.....	63
Auger Tube Donuts.....	71
Axle Drive Shafts and Couplers.....	13
Beaters and Components.....	51
Belts—3300, 4400.....	150
Belts—4420.....	152
Belts—4425, 4435, 4435 Hydro.....	153
Belts—6600, 7700 – Left Hand View.....	155
Belts—6600, 7700 – Right Hand View.....	154
Belts—6620, 6622, 7720, 7721.....	156
Belts—7722, 8820.....	158
Belts—8000 Series Forage Harvesters.....	174
Belts—9400, 9500, 9500SH, 9501, 9600.....	160
Belts—9410, 9510, 9510SH, 9610.....	162
Belts—9450, 9550, 9550SH, 9560, 9560SH, 9650, 9660.....	163
Belts—9560, 9570, 9650, 9660, 9670, 9750, 9760, 9770, 9860, 9870 – STS.....	165
Belts—9650CTS, 9660CTS, CTS, CTS II, CTS Rice.....	167
Belts—Cotton Pickers & Swathers.....	174
Belts—Platforms.....	175
Belts—S550, S650, S660, S660HM, S670, S670HM, S680, S680HM, S690, S690HM.....	169
Belts—S760, S770, S780, S785, S790.....	171
Belts—T660, T670.....	173
Brakes and Components.....	10
Chaffer and Sieve Frames.....	75
Chaffers—Adjustable Air Foil Top.....	73
Chaffers—Long Finger Top.....	73
Chaffers—Rigid Air Foil.....	74
Chaffers—Short Finger Top.....	72
Clean Grain Elevator Boot and Door.....	50
Cleaning Fan Shafts and Components.....	38
Concaves and Components.....	33
Corn Doors and Wheat Doors.....	98
Cornhead—Auger Liners.....	136
Cornhead—Complete Polytin Kits.....	133
Cornhead—Fenders and Snouts.....	134
Cornhead—Hydraulic Deck Plate Kits.....	138
Cornhead—Row Unit Components.....	138
Auger Drive Components.....	147
Curtain Components.....	144
Gearbox Components.....	138
Roller Chains and Components.....	149
Row Unit Components.....	140
Row Unit Gearboxes.....	138
Cornhead—Stalk Stompers and Components.....	136

Cutter Bar Components.....	96
Cylinder Bars and Components.....	30
Cylinder Drive Components.....	37
Distribution Auger Pans and Components.....	63
Distribution Auger Wood Block Bearing Set.....	63
Draper Belts and Components.....	108
Elevator Chains.....	41
Elevator Chain Sprockets.....	44
Elevator Gearbox.....	45
Elevator Head Shafts.....	46
Elevator Housings and Components.....	42
Feederhouse Chains.....	16
Feederhouse Chain Sprockets.....	18
Feederhouse Components.....	22
Feederhouse Drums and Shafts.....	19
Feederhouse Floor Sheets.....	21
Feed Reverser Assemblies and Components.....	27
Final Drives and Components.....	11
Fuel Tanks and Components.....	125
Gas Struts.....	125
Glass.....	126
Grain Pans and Components.....	77
Grain Tank Auger Floor Liners.....	71
Guards and Cutter Bar Parts.....	97
Header End Shields.....	110
Header Lift Cylinders.....	107
Hoods.....	112
Hydraulic Components.....	15
Hydraulic Oil Coolers.....	14
Hydraulic Pumps.....	15
Hydrostatic Drive Components.....	9
Hydrostat Output Shafts.....	9
Hydrostat Transmissions and Components.....	8
Knife Mount Channels and Parts.....	89
Lighting.....	112
Longblock Assemblies.....	3
Platform Adapter Kits.....	99
Platform Components.....	105
Platform Floor Sheets.....	106
Poly Skid Plate Kits and Components.....	111
Power Steering Cylinders and Components.....	123
Primary Countershafts and Components.....	35
Radiator Hoses and Thermostats.....	5
Radiators and Components.....	3
Rear Deflector (Isolator)	98
Rear Hood, Lower Panels.....	99
Rear Hoods and Components.....	99
Rear Wheel Drive and Components.....	123
Reel Components.....	104
Reel Conversion Kits.....	103
Reel Drive Components.....	103
Rotor Assemblies.....	31
Rotor Components.....	31
Row Crop Dividers.....	107
Row Crop Head Components.....	99

Table of Contents Continued on Next Page

John Deere®—Combine

Table of Contents - Continued

Secondary Countershafts and Components.....	37	Straw Choppers.....	79
Sensors	7	Straw Spreader Components	98
Separator Gearbox Components.....	41	Straw Walkers and Components	77
Sickle Assemblies With Heads	94	Styling Panels.....	125
Sickle Drives and Components	101	Tie Rods and Components.....	122
Sickle Knife Heads	94	Transmission Input Shafts	10
Sieves—Lower	74	Transmissions	10
Spindles.....	124	Unloading Auger Countershafts and Components	54
Steering Wheels and Cap.....	125	Unloading Auger Housings and Components.....	47
Step Components.....	125	Unloading Auger Swing Cylinders	52
Straw Chopper Blades and Components	83	Upper Sprocket Tubes.....	18
Straw Chopper Drive Kits and Components.....	80	Wheel Hubs and Components.....	124
Straw Chopper Floors.....	88	Wide Spread Deflector Assemblies and Components.....	90
Straw Chopper Parts and Components.....	84		
Straw Chopper Rotor Assemblies.....	84		

Longblock Assemblies

Application	Description	Part Number	Retail Price	Core
9400 BSN 337245 w/ 359T 6 Cylinder Diesel Engine	Reman Longblock Assembly	LBJD359TE9400	\$ 8600.00	\$ 1500.00
9400 ASN 337246 w/ 359T 6 Cylinder Diesel Engine	Reman Longblock Assembly	LBJD359TL9400	\$ 8600.00	\$ 1500.00
9500, 9600	Reman Longblock Assembly 190 Horsepower	LBJD60769600W85	\$ 9750.00	\$ 1500.00
	Reman Longblock Assembly 235 Horsepower	LBJD60769600W95	\$ 9750.00	\$ 1500.00
9550	Reman Longblock Assembly	LBJD8.1PT9550	\$ 11500.00	\$ 1500.00
9660	Reman Longblock Assembly	LBJD8.1PT9660	\$ 11500.00	\$ 1500.00
9770	Reman Longblock Assembly	LBJD6090E9770	\$ 12750.00	\$ 6000.00
	Reman Longblock Assembly	LBJD6090L9770	\$ 12750.00	\$ 6000.00
9870STS	Reman Engine, Complete 13.5 Liter	CRJD6135T9870H	\$ 35700.00	\$ 7500.00
Forage Harvester: 7300	Reman Engine, Complete 12.5 Liter, 6125, HH003	CRJD6125T9860L	\$ 33150.00	\$ 7500.00
Sprayers: 4630, 4700, 4710, 4720, 4730, 4830, R4023	Engine Mount Isolator	AMRE60720	\$ 32.13	



Radiators and Components

Application	Description	Part Number	Retail Price	Core
6600 w/ 6404 Engine, 6602 Hillside, 6620, 6622	Radiator Core: 27 3/4" x 32 5/8" 5 Rows, 5 Fins per Inch Replaces AH19911, AH87990, AH112173	AMAH124726	\$ 1051.47	
7700 w/ Factory Rotary Screen, 7720, 8820	Radiator Overall: 31 3/4" x 40 1/2" Core: 27 1/2" x 33" x 3 3/8" 5 Rows, 6 Fins per Inch	AMAH124728	\$ 1071.00	
9400 BSN 640100, 9500 BSN 640200, 9600 BSN 640330 w/o 235HP Engine	Radiator Overall: 42" x 21 3/16"	AMAH137544	\$ 1350.00	

John Deere®—Combine

Application	Description	Part Number	Retail Price	Core
9400 SN 640100-655316, 9500 SN 640200-656269, 9510, 9550, 9600 ASN 640301, 9650 BSN 695300, 9650CTS BSN 695400, CTS BSN 655419, Cotton Pickers: 9976, 9986	Radiator Overall: 41 3/4" x 26" 5 Rows, 5 Standard Fins per Inch Replaces AH133223, AH138940, AH169362	AMAH128257	\$ 1040.50	
9500 ASN 640201, 9510, 9550, 9600 ASN 640301, 9610, 9650 BSN 695300, 9650CTS BSN 695400, CTS, CTS II	Radiator Overall: 42" x 26 1/4" 6 Rows, 4 Wide Fins per Inch Replaces AH144719	AMAH169363	\$ 1219.00	
9550 ASN 700200, 9550SH ASN 700700, 9560, 9560SH, 9560STS, 9650 ASN 695300, 9650CTS ASN 695400, 9660, 9660CTS	Radiator Overall: 27 5/16" x 41 1/4" x 4" 4 Rows	AMAH168350	\$ 1150.00	
9650STS BSN 695600, 9750STS BSN 695500	Radiator Replaces AH145366	AMAH169364	\$ 1595.00	
9940, 9950, 9960 Engine SN 000101-004000	Radiator Overall: 27" x 37 3/8" 5 Rows Replaces AN191241	AMAN190887	\$ 1150.00	
Cotton Pickers: 9960 ASN 004001, 9965, 9970	Radiator Core: 25 7/8" x 29 1/2" x 3 1/4"	AMAN195300	\$ 1245.00	
Sprayer: 4720	Radiator Core: 16" x 25.50" x 3.30" Replaces RE181893	AMRE245236	\$ 1134.00	
Sprayers: 4730, 4830	Radiator Overall: 26" x 33" Core: 26" x 25 3/8" x 3 1/4" 4 Rows, 10 Fins per Inch	AMRE226366	\$ 980.00	
Sprayer: 4920	Radiator Core: 16" x 32 1/8" x 3.30"	AMRE245227	\$ 1163.00	
Sprayer: 4930	Radiator Core: 27 7/8" x 35.00" x 4 1/8" 5 Rows, 10 Fins per Inch Replaces RE242251	AMRE242256	\$ 1663.00	
Sprayer: 4940 w/ Tier 2 Engine	Radiator Overall: 21 1/2" x 46 3/8" Core: 21 1/4" x 38" x 5 1/4" 4 Rows, 10 Fins per Inch	AMRE297780	\$ 1200.00	
Sprayer: 4940 w/ Tier 4 Engine	Radiator Overall: 21 5/8" x 46 1/2" Core: 21 1/2" x 38" x 5 3/16" 5 Rows, 10 Fins per Inch	AMRE330645	\$ 1576.00	
Sprayers: R4030, R4038, R4045	Radiator	AMAN402264	\$ 1845.00	
Swathers: 4890, 4895	Radiator Overall: 22 1/4" x 33 7/8" Core: 22" x 28 1/8" x 3 1/2" 5 Rows, 8 Fins per Inch	AMRE63188	\$ 785.00	
Swathers: A400, D450, R450	Radiator Core: 33 5/8" x 23 3/8" x 5.20"	AMAFH202211	\$ 2219.00	
9400, 9410, 9500, 9500SH, 9510, 9510SH, 9610 ASN 681688, CTS, CTS II	Countershaft, Rotary Screen Drive 20.50" Long	AMH134528	\$ 80.67	
9450, 9550 BSN 700201, 9550SH BSN 700701, 9650 BSN 695301, 9650CTS BSN 695401	Drive Shaft, Rotary Screen 22.22" Long	AMH168256	\$ 93.48	
9560STS ASN 720101, 9570STS, 9650STS, 9660STS, 9670STS, 9750STS, 9760STS, 9770STS, S550 SN 745100-764999, S650 ASN 765000, (S660, S670 ASN 745100), S670HM BSN 765000	Drive Shaft, Rotary Screen 29.75" Long	AMH151146	\$ 97.00	
9550 ASN 700200, 9550SH ASN 700700, 9560, 9560SH, 9860STS, 9870STS, S680, S680HM, S690, S690HM, S780, S785, S790	Drive Shaft, Rotary Screen 52.81" Long	AMH175557	\$ 161.83	
9610	Drive Shaft, Engine Fan 12.63" Long	AMAH151439	\$ 124.09	

John Deere®—Combine

Application	Description	Part Number	Retail Price	Core
Combines: 9600, 9610 BSN 681688, Cotton Picker: 9976 BSN 004000	Countershaft, Rotary Screen Drive 23.62" Long	AMH123653	\$ 132.44	
9450 ASN 690111, 9550 ASN 690240, 9550SH ASN 690701, 9560, 9560SH, 9560STS, 9570STS, 9650 ASN 690338, 9650CTS ASN 690401, 9650STS ASN 690609, 9660, 9660CTS, 9660STS, 9670STS, 9750STS ASN 690662, 9760STS, 9770STS, 9860STS, 9870STS, Forage Harvester: 7250	Idler, Rotary Screen Upper Idler	AMAH169549	\$ 19.00	
8820, 9400, 9410, 9450, (9500, 9500SH ASN 642858), 9600, 9610, 9650, CTS	Idler Pulley, Flanged 2.187" Wide, 5.50" OD, 0.50" Hole Diameter	AMAH96292	\$ 61.00	
9400 ASN 645101, 9450, 9500 ASN 645201, 9510, 9510SH, 9550, 9550SH, 9560, 9560SH, 9570STS, 9600, 9610, 9650, 9650CTS, 9650STS, 9660, 9660CTS, 9660STS, 9670STS, 9750STS, 9760STS, 9770STS, 9860STS, 9870STS, CTS, CTS II, S550, S650, S660, S670, S670HM, S680, S680HM, S690, S690HM, Cotton Picker: 9976	Idler Pulley, Rotary Screen 3.252" OD, 1.102" Overall Width, 0.39" Bore, 0.961" Groove Width Replaces AB4828R, AH140497, RE29879	IPABFI-54-008	\$ 17.00	
3300 ASN 100000, 4400 ASN 101300, 4420, 6600 ASN 011501, 6620, 7700, 7720, 8820	Bearing Flange, Rotary Screen Drive Shaft	AME10018	\$ 2.48	
3300, 4400 Engine ASN 101300, 4420, 6600, 6620, 7720, 8820	Bearing, Rotary Screen Driveshaft 2.4409" OD, 1.125" Bore Diameter	AMJD9246	\$ 23.30	
9400 ASN 640100, 9410, 9450, (9500, 9510 ASN 640200), (9500SH, 9510SH ASN 645200), 9550, 9550SH, 9560, 9560SH, 9560STS, 9570STS, 9600 ASN 640300, 9610, 9650, 9650CTS, 9650STS, 9660, 9660CTS, 9660STS, 9670STS, 9750STS, 9760STS, 9770STS, 9860STS, 9870STS, S550, S650, S660, S670, S670HM, S680, S680HM, S690, S690HM, S770, S780, S785, S790, CTS, CTS II, Cotton Pickers: 7760, 9976, 9986, 9996, CP690, Cotton Stripper: CS690, Forage Harvesters: 6610, 6650, 6710, 6750, 6810, 6850, 6910, 6950, 7180, 7200, 7250, 7280, 7300, 7350, 7380, 7400, 7450, 7480, 7500, 7550, 7580, 7700, 7750, 7780, 7800, 7850, 7950, 7980, 8100, 8200, 8300, 8400, 8500, 8600, 8700, 8800, 9600, 9700, 9800, 9900	Outer Bearing, Rotary Screen Tapered Roller Bearing 1.456" Wide, 2.677" OD, 1.535" Bore	AMAH109788	\$ 54.59	



Radiator Hoses and Thermostats

Application	Description	Part Number	Retail Price	Core
4400	Radiator Hose, Upper 2" & 2.50" ID	AMR43582	\$ 16.88	
Cotton Pickers: 9950 ASN 4000, 9960 SN 0101-4000	Radiator Hose, Upper	AMR88353	\$ 12.45	
Forage Harvesters: (6810, 6910 BSN 502248)	Radiator Hose, Upper 2.25" & 2.50" ID	AMR57388	\$ 10.95	
Sprayers: 4700, 4710	Radiator Hose, Upper 2" & 2.375" ID	AMR130571	\$ 31.50	
Sprayer: 4720	Radiator Hose, Upper 2.50" ID	AMR164844	\$ 29.93	
Sprayers: 4700, 4710	Radiator Hose, Lower 2" ID	AMR128002	\$ 20.23	
3300, 9560STS, 9570STS, 9860STS, Forage Harvesters: 6610, 6710, 6810, 6910, 7300, 7400, 7500, Sprayers: 4700, 4710, 4730, 6000, 6100, 6500, 6600, Swathers: 2360, 2420, 3430, 3830	Thermostat, 180° Replaces AT22961	AMRE33705	\$ 6.00	
4400, 4420, 6600, Cotton Picker: 9900, Cotton Stripper: 484	Thermostat, 195° Replaces AR70601	AMAR77411	\$ 68.70	
6600, 6620, 7700, 7720, 8820, 9400, 9500, 9500SH, 9600, CTS Engine ASN 499999, Cotton Pickers: 9910, 9920, 9930, 9940, 9950, 9960, 9965, 9970, 9976, Cotton Strippers: 7440, 7450, Forage Harvesters: 5200, 5400, 5440, 5460, 5720, 5730, 5820, 5830, 6610, 6650, 6710, 6810, 6910, 7200, 7300, 7400, 7500, Sprayers: 4700, 4920	Thermostat, 180° Replaces RE524562	AMAR48675	\$ 5.50	

John Deere®—Combine

Application	Description	Part Number	Retail Price	Core
9560, 9660STS, 9670STS, 9760STS, 9770STS, 9780CTS, S560, S650, S660, S670, S670HM, S760, S770, T560, T660, T670, Cotton Picker: 7660, Forage Harvesters: 7180, 7250, 8100, 8200, Sprayers: 4930, R4038, R4045, R4060	Thermostat, 180° 2.125" OD Replaces RE540550	AMDZ100553	\$ 19.05	
9560STS, 9570STS, S540, S550, T550, Cotton Picker: 9970, Sprayers: 4730, 4830	Thermostat Replaces RE538806	AMRE538289	\$ 15.49	
S650, S660, S670, S670HM, S680, S680HM, S690, S690HM, S760, S770, S780, S785, S790, T550, T560, T660, T670, Cotton Pickers: CP690, 7760, Cotton Stripper: CS690, Forage Harvesters: 7280, 7380, 7480, 7580, 7780, 8100, 8200, 8300, 8400, 8500, 8600, 9600, Sprayers: R4023, R4030, R4044, R4045, R4060	Thermostat Replaces RE540379	AMRE554015	\$ 25.00	



Alternators

Application	Description	Part Number	Retail Price	Core
9400 ASN 635306, 9410, 9450, 9500, 9510, 9550, 9550SH, 9560, 9600, 9610, 9650, 9650CTS, 9660, 9660CTS, 9750STS, 9780CTS, 9860STS, CTS, CTS II Replaces A187623, AH137883, AT220394, RE36267, RE505895, SE501342, TY6750	Alternator w/o Pulley Bosch, 12 Volt, 95 Amps, IR/EF, CW Rotation	AMA187623	\$ 107.00	
9400 ASN 650101, 9410, 9450, (9500, 9500SH ASN 637628), 9510, 9510SH, 9550, 9550SH, 9560, 9560SH, 9560STS, 9600 ASN 636604, 9610, 9650, 9650CTS, 9650STS, 9660, (9660CTS, 9760STS BSN 715400), 9660STS, 9750STS, 9860STS BSN 715633, CTS, CTS II, Cotton Pickers: (7445, 9930 ASN 12001), 7450, 9960, 9965, Sprayers: 6100, 6500, 6600, Swathers: 3430, 3830	Alternator Bosch, 12 Volt, 95 Amps Replaces ABO0209, AL-6236	AMTY24485	\$ 144.00	
9450, 9550, 9550SH, 9560, 9560SH, 9560CTS, 9560STS BSN 715300, 9650, 9650CTS, 9650STS, 9660, 9660CTS, (9660STS, 9760STS BSN 715400), 9750STS, 9860STS BSN 715633, Cotton Stripper: 7460	Alternator, Delco 28SI Series, 12 Volt, 185 Amps, CW Rotation Replaces 8600307, 8600311	AMAH211398	\$ 332.00	
9560STS ASN 715301, 9570STS, (9660STS, 9760STS ASN 715401), 9670STS, 9770STS, 9860STS ASN 715634, 9870STS, S550, S650, S660, S670, S670HM, S680, S680HM, S690, S690HM, S760, S770, S780, S790	Alternator w/o Pulley 200 Amp Replaces AH212040, AH229090	AMAXE17691	\$ 250.00	
Forage Harvesters: 7950, 7980, 8100, 8200, 8400, 8500, 8600	Alternator, 14 Volt 200 Amps Note: Special Order Item	AMAL170947	\$ 350.00	
Cotton Pickers: 9935, 9970, 9976, 9986, Cotton Stripper: 7445, Sprayer: 6700, Swathers: 4890, 4895, 4990, 4995, A400 w/ 4045HE050 Engine	Alternator 12 Volt, 120 Amps Replaces AT185951, RE533654, SE502628	AMAH165975	\$ 265.00	
Sprayer: 4720	Alternator Denso Type, 12 Volt, 150 Amps, IR/IF Replaces RE186320, SE501837, Nippondenso 104210-3920, 104210-3921	AMRE257541	\$ 480.00	
Sprayers: 4730, 4830, 4940	Alternator w/ Pulley Bosch, 12 Volt, 200 Amps, IR/IF, Uses B+ and D+ post Can be used to replace AH229090, but may require change of pulley Replaces RE555751	AMRE210793	\$ 280.00	
9560STS, 9650STS, 9660STS, 9750STS, 9760STS, Cotton Stripper: 7460, Sprayer: 6700 ASN 773433, Swather: 4895	Belt Tensioner, Alternator 200 PSI Spring Pressure Replaces RE70535, RE70536, RE548027	AMRE518097	\$ 103.00	

John Deere®—Combine

Sensors

Application	Description	Part Number	Retail Price	Core
9410, 9450, 9500, 9500SH, 9510, 9510SH, 9550, 9550SH, 9560STS, 9570STS, 9600, 9610, 9640, 9650, 9650CTS, 9650STS, 9660, 9660CTS, 9660STS, 9750STS, 9760STS, 9780CTS, 9860STS, 9870STS, C670, CTS, CTS II, S550, S660, S670, S670HM, S680, S680HM, S690, S690HM, T550, T560, T660, T670, Cotton Pickers: 7660, 7760, 9935, 9965, 9970, 9976, 9986, Cotton Strippers: 7455, 7460, Forage Harvesters: 7180, 7250, 7280, 7350, 7380, 7450, 7480, 7550, 7580, 7750, 7780, 8100, 8200, 8300, 8400, 8500, 8600, Sprayers: 4630, 4700, 4710, 4720, 4730, 4830, 4920, 4930, 4940, 6700	Engine Speed Sensor	AMRE519144	\$ 20.00	
9410, 9450, 9510, 9510SH, 9550, 9550SH, 9560, 9560SH, 9570STS, 9610, 9650, 9650CTS, 9650STS, 9660CTS, 9660STS, 9670STS, 9770STS, 9780CTS, 9860STS, 9870STS, 9880STS, S550, S560	Sensor, Concave Indicator Replaces RE56165	AMAT333680	\$ 87.00	
9450, 9550, 9550SH, 9560, 9560SH, 9560STS, 9570STS, 9650, 9650STS, 9660, 9660CTS, 9660STS, 9670STS, 9750STS, 9760STS, 9770STS, 9780CTS, 9860STS, 9870STS	Circuit Board Moisture Sensor, 155 GreenStar™, Yield Mapping	AMAH209883	\$ 275.00	
9450, 9550, 9550SH, 9560, 9560SH, 9560STS, 9570STS, 9650CTS, 9650STS, 9660, 9660CTS, 9660STS, 9670STS, 9750STS, 9760STS, 9770STS, 9780CTS, 9860STS, 9870STS, Cotton Pickers: 7660, 7760, Cotton Stripper: CS690, Forage Harvesters: 7180, 7200, 7250, 7280, 7300, 7400, 7450, 7480, 7500, 7550, 7580, 7700, 7750, 7780, 7800, 7950, 7980	Neutral Start Switch	AMAH161154	\$ 31.00	
9550, 9550SH, 9650CTS, Cotton Pickers: 7660, 9970, 9986, 9996, Cotton Strippers: 7450, 7455, Sprayers: 4930, 4940	Potentiometer Sensor	AMRE261354	\$ 100.00	
9560STS, 9570STS, 9660STS, 9670STS, 9760STS, 9770STS, 9870STS, S540, S550, S560, S660, S670, S690, S690HM, S780, S790, T550, T560, T660, T670, Cotton Pickers: 7660, 7760, 9970, Sprayers: 4630, 4730, 4830, 4930, R4023, Forage Harvesters: 7350, 7380, 7450, 7480, 7550, 7580, 7750, 7780, 8100, 8200, 8300, 8400, 8500, 8600	Air Temperature Sensor Replaces 72102514	AMRE525016	\$ 19.09	
9560STS, 9660STS, 9670STS, 9760STS, 9770STS, 9780CTS, S550, S650, S660, S670, S670HM, S760, S770, Cotton Picker: 9970, Forage Harvester: 8100, Sprayer: 4940	Air Temperature Sensor	AMRE522823	\$ 45.00	
9570STS, 9670STS, 9770STS, 9870STS, S550, S650, S660, S670, S680, S680HM, S690, S690HM, S760, S770, S790, Platforms: 625D, 630D, 635D, 635FD, 640D, 640FD, 645FD, 725D, 730D, 735FD, 740D, 740FD, 745FD	Speed Sensor	AMAH228007	\$ 220.00	
9660STS, 9670, 9760STS, 9770, 9780CTS, S650, S660, S670, S670HM, T560, T660, T670, Cotton Picker: 7660, Forage Harvesters: 3520, 7180, 7250, 8100, 8200, Sprayer: 4930	Fuel Filter Moisture Sensor Replaces RE532949	AMRE503590	\$ 60.00	
S550, S650, S660, S670, S670HM, S680, S680HM, S690, S690HM, S785, T550, T560, T660, T670, Forage Harvesters: 8100, 8200, 8300, 8400, 8500, 8600, 8700, 8800, 9600, 9700, 9800, 9900, Sprayers: R4030, R4038, R4045	Wiring Harness, Propulsion Control	AMAL203916	\$ 80.00	
S760, S770, S780, S790	Solenoid Valve For Engine Compressor Solenoid	AMAH229996	\$ 293.00	
S760, S770, Forage Harvesters: 8100, 8200, 8300, 8400, 8500, 8600, 8700, 8800	Pressure Switch Replaces AXE35537	AMAXE72960	\$ 180.00	
Cotton Pickers: 7660, 7760, 9986, CP690, Cotton Strippers: 7460, CS690, Sprayers: 4630, 4720, 4730, 4830, 4930, 4940, R4023	Rotational Position Sensor	AMAN372268	\$ 125.00	
Cotton Pickers: 7760, CP690	Proximity Switch	AMAN372459	\$ 75.00	
Cotton Pickers: 7660, 7760	Sensor	AMAN373340	\$ 88.00	
Cotton Pickers: 7660, 7760, CP690, Cotton Stripper: CS690	Wheel Speed Sensor Replaces RE204888, RE558874	AMRE295929	\$ 87.00	
Sprayers: 4920, 4940	Flowmeter Sensor Replaces AKK23982	AMAN305054	\$ 152.00	
Sprayers: 4720, 4730, 4830	Wheel Speed Sensor	AMAN208025	\$ 375.00	
Sprayers: 4730, 4830	Cylinder Position Sensor Replaces AN302232, AN306617	AMAKK16814	\$ 168.00	

John Deere®—Combine

Application	Description	Part Number	Retail Price	Core
Platforms: (600F, 600R ASN 740101), 615F, 615R, 618F, 618R, 622F, 622R, 625D, 625R, 625F, 630D, 630FD, 630R, 635D, 635F, 635FD, 640D, 640FD, 645FD, 730FD, 735FD, 740FD, 745FD	Reel Resume and Fore/Aft Right Hand Sensor Replaces AXE57249	AMAXE17036	\$ 78.00	

Hydrostat Transmissions and Components

Our hydrostats are remanufactured by a remanufacturing facility recognized by Sauer/Sundstrand. All units are assembled by a factory-trained technician, using genuine new and remanufactured replacement parts. All units are fully tested to factory specifications for maximum performance.



Application	Description	Part Number	Retail Price	Core
6600, 7700	Reman Hydrostat, Sundstrand Replaces AH75517, PG203919	H7700S	\$ 1785.00	\$ 500.00
6620, 7720	Reman Hydrostat, Eaton Replaces AH112682	H7720E	\$ 3417.00	\$ 500.00
6620, 7720	Reman Hydrostat, Sundstrand Replaces AH98889, AH107887, AH119038	H7720S	\$ 3417.00	\$ 500.00
8820	Reman Hydrostat, Eaton Replaces AH130931	H8820E	\$ 3417.00	\$ 500.00
8820	Reman Hydrostat, Sundstrand Replaces AH96664, AH107888, AH119037	H8820S	\$ 3417.00	\$ 500.00
9400, 9500, 9600 w/ Ring and Pinion Final Drive, CTS, CTS II	Reman Hydrostat, Eaton, 2-Piece Replaces Pump AH131305, AH160785, Motor AH128575, AH131310	H9500E-46/46	\$ 5559.00	\$ 750.00
9560STS, 9570STS, 9650, 9650CTS, 9650STS, 9660, 9660CTS, 9660STS, 9670CTS, 9670STS, 9750STS, 9760STS, 9780CTS, 9860STS, 9880STS	Reman Hydrostat, Eaton 6493-036 Hydro Pump, 6433-081 Hydro Motor Replaces AH204424, AXE10219, PG200760	H9760STSE-64/64	\$ 5049.00	\$ 1000.00
9600 w/ Planetary Final Drive, CTS, CTS II	Reman Hydrostat, Eaton, 2-Piece Replaces Pump AH131385, AH204383, Motor AH131390, AH204424	H9600E-64/64	\$ 5450.00	\$ 750.00
9770STS, S660, S670	Reman Hydrostat, Eaton 3-Speed, Confirm Eaton Numbers on Pump and Motor Before Ordering	H9770E-64/64	\$ 4950.00	\$ 1000.00
9770STS, S660, S670	Reman Hydrostat, Eaton Pro Drive, Confirm Eaton Numbers on Pump and Motor Before Ordering	H9770EL-64/64	\$ 5049.00	\$ 1000.00
Cotton Pickers: 9900, 9910, 482, 484	Reman Hydrostat, Sundstrand	H9900S-22/22	\$ 3600.00	\$ 500.00
Cotton Pickers: 9910, 9920, 9960, 484, 7440, 7445	Reman Hydrostat, Eaton	H9900E-39/39	\$ 3800.00	\$ 500.00
Cotton Picker: 9930	Reman Hydrostat, Sundstrand	H9930S2-22/22	\$ 3600.00	\$ 500.00
Cotton Picker: 9976	Reman Hydrostat, Sundstrand, 2-Piece	H9976S-96/51	\$ 8750.00	\$ 500.00
9770STS, 9870STS	Hydrostat Motor 140 cc Replaces AH235084	AMAXE23886	\$ 12976.00	
S660, S670	Hydrostat Motor Replaces AH232682	AMAXE23885	\$ 11913.00	
S680, S680HM, S690, S690HM, (S780, S790 - w/o Drive by Noise Regulation), Cotton Stripper: CP690, Forage Harvesters: 8400, 8500, 8600	Hydrostat Motor 170 cc	AMAXE24902	\$ 13414.00	
Cotton Pickers: 7660, 7760	Hydrostat Motor	AMAN372934	\$ 12975.00	
9770STS, S670 BSN 766253	Hydrostat Pump Replaces AH234462, AXE17831, AXE21873, PG201016	AMAXE17831	\$ 7880.00	
9870STS	Hydrostat Pump Replaces AH233210, AH234461, AXE19716, AXE21874	AMAXE29041	\$ 9197.00	
S660 SN 765172-785000, S670 SN 765253-785000	Hydrostat Pump	AMAXE30234	\$ 7704.00	

John Deere®—Combine

Application	Description	Part Number	Retail Price	Core
(S660, S670 ASN 785000), S760 Excluding SN 1JOS760XXXX, S770 Excluding SN 1JOS770XXXX	Hydrostat Pump	AMAXE62024	\$ 8199.00	
S680 ASN 766006, S690 ASN 765249, S780, S785, S790	Hydrostat Pump	AMAXE30235	\$ 9197.00	
S680 BSN 766007, S680HM, S690 BSN 766250, S690HM	Hydrostat Pump Replaces AXE11598	AMAXE27489	\$ 9197.00	
Cotton Pickers: 7760, CP690, Cotton Stripper: CS690	Hydrostat Pump 180 cc Replaces AN278774, AN375055	AMAN406360	\$ 13532.00	
Forage Harvesters: 7200, 7250, 7280, 7300, 7350, 7380, 7400, 7450, 7480, 7500, 7550, 7580, 7700, 7750, 7780, 7800, 7850, 7950, 7980	Hydraulic Axial Piston Pump Replaces AZ102340	AMAXE23634	\$ 9100.00	

Hydrostatic Drive Components

Application	Description	Part Number	Retail Price	Core
6600, 6602, 6620, 6622, 7700, 7720, 8820	Hydrostatic Drive Oil Cooler	AMAH98812	\$ 835.00	
6600, 7700, Forage Harvesters: 5200, 5400, (5440, 5460 ASN 425000)	Hydro Drive Coupler 19 Spline, 2.50" Long, 1.25" Diameter Replaces H93940	AMH99060	\$ 75.96	
6620, 7720 w/ Eaton Hydrostat ASN 556300 or w/ Sundstrand Hydrostat BSN 556301 & ASN 610500, 8820, Forage Harvesters: 5720, 5730, 5820, 5830	Hydro Drive Coupler 23 Spline, 2.75" Long, 1.519" Diameter Replaces H93940	AMH98238	\$ 75.96	
9400, 9410, 9450 BSN 690100, 9500, 9510, 9510SH, 9550 BSN 690200, 9550SH BSN 690700, 9600, 9610, 9650 BSN 690300, 9650CTS BSN 690400, CTS, CTS II BSN 675952, Forage Harvesters: 6610, 6650, 6710, 6750, 6810, 6850, 6910, 6950	Hydrostatic Pump Shaft 23/23 Spline, 11.23" Long	AMAH133660	\$ 218.05	
Cotton Pickers: 9960, 9965	Driveshaft For Hydrostat Pump Drive	AMAN193853	\$ 505.00	
Cotton Pickers: 9970	Driveshaft For Hydrostat Pump Drive	AMAN274998	\$ 545.00	
Cotton Pickers: 9970, 9976 BSN 4000	Driveshaft For Hydrostat Pump Drive	AMAN273458	\$ 660.00	
Cotton Pickers: (9976, 9986 ASN 4001), 9996	Driveshaft For Hydrostat Pump Drive	AMAN275411	\$ 1325.00	

Hydrostat Output Shafts



Application	Description	Part Number	Retail Price	Core
6600, 7700, Forage Harvesters: (5200, 5400, 5440, 5460 BSN 425000)	Hydro Output Shaft 19/26 Spline, 11.66" Long, 1.48" Diameter For Sundstrand Units,	AMH81605	\$ 291.09	
6620, 7720, 8820, Forage Harvesters: (5200, 5400, 5440, 5460 ASN 425001), 5720, 5730, 5820, 5830	Hydro Output Shaft 26/23 Spline, 12" Long, 1.48" Diameter For 200 Series Sundstrand Units	AMH98071	\$ 466.49	
6600, 6602 BSN 353600, 7700, Forage Harvesters: 5200, 5400, 5440, 5460	Hydrostat Output Shaft, Motor Stub Drive 19 Tooth, 3.06" Long	AMH76111	\$ 78.10	
9560STS, 9570STS, 9650CTS, 9650STS, 9660, 9660CTS, 9660STS, 9670STS, 9750STS, 9760STS, 9770STS, 9780CTS ASN 072800, 9860STS, 9870STS, C670, S550 SN 745100-764999, S650 ASN 765000, (S660, S670 ASN 745100), S760, S770, T550, T560, T660, T670, Forage Harvesters: 6650, 6750, 6850, 6950, 7180, 7200, 7250, 7300, 7400, 7450, 7480, 7500, 7550, 7580, 7700, 7750, 7780, 7800, 7850, (8100, 8200, 8300, 8400, 8500, 8600, 8700, 8800 SN 513822-517999)	Hydrostat Output Shaft 26/23 Spline, 12.39" Long	AMAZ56818	\$ 375.00	

John Deere®—Combine

Transmission Input Shafts

Application	Description	Part Number	Retail Price	Core
6620, 7720, 8820 w/ Hydrostatic Drive	Transmission Input Shaft	AMAH109692	\$ 214.00	
9400, 9410, 9450, 9500, 9510, 9550, 9560, 9560STS, 9570STS, 9600, 9650, 9650CTS, 9650STS, 9660, 9660CTS, 9670STS, 9750STS, 9760STS, 9770STS, 9860STS, 9870STS, CTS, CTS II, S550, S660, S670, S680, Cotton Stripper: 7460, Forage Harvesters: 6610, 6650, 6710, 6750, 6810, 6850, 6910, 6950, 7180, 7200, 7250, 7280, 7300, 7350, 7380, 7400, 7450, 7480, 7500, 7550, 7580, 7700, 7750, 7780, 7800, 7850	Transmission Coupler	AMH129525	\$ 56.50	

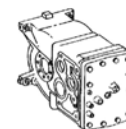

Transmissions

Application	Description	Part Number	Retail Price	Core
6620, 7720	Reman Transmission Units w/ Positorque or Gear Drive	AMT200PT	\$ 2450.00	\$ 400.00
	Reman Transmission Units w/ Hydrostat Drives	AMT200H	\$ 2450.00	\$ 400.00
8820	Reman Transmission Units w/ Hydrostat Drives	AMT8820	\$ 2450.00	\$ 500.00
9400, 9500, 9600	Reman Transmission Units w/ Bull Gear Final Drives Replaces AH168735	AMT9600B	\$ 3150.00	\$ 1500.00
9600, 9610	Reman Transmission Units w/ Planetary Final Drives Replaces AH156881	AMT9600P	\$ 3150.00	\$ 1500.00
9550, 9560, 9560STS, 9570STS, 9650 BSN 700300	Reman Transmission	AMAH203856	\$ 3000.00	\$ 2500.00
9650 ASN 700301, 9650STS ASN 700501, 9660, 9660CTS, 9660STS, 9670STS, 9750STS ASN 700601, 9760STS, 9770STS, 9860STS, 9870STS	Reman Transmission Cast # - AH219499	AMAH202673	\$ 7500.00	\$ 2500.00
9770STS	Reman Transmission Replaces DE20163	AMPG200954	\$ 9500.00	\$ 2500.00
9870STS	Reman Transmission Replaces DE19592	AMPG200876	\$ 9500.00	\$ 2500.00



Brakes and Components

Application	Description	Part Number	Retail Price	Core
6600 ASN 105890, 6620, 7700 ASN 111900, 7720, 8820, Forage Harvesters: 5200, 5400, 5440, 5460, 5720, 5730, 5820, 5830	Transmission Brake Shaft 12.964" Long	AMH85871	\$ 197.52	
6600 ASN 105891, 6620, 7700 ASN 111901, 7720, 8820, Forage Harvesters: (5200, 5400 ASN 160000), 5440, 5460, 5720, 5730, 5820, 5830	Brake Drum Cast Iron	AMH85887	\$ 285.00	
9400, 9410, 9450, 9500, 9510, 9510SH, 9550, 9550SH, 9560, 9560SH, 9560STS, 9570STS, 9600, 9610, 9650, 9650CTS, CTS, CTS II, Cotton Pickers: 7450, (7455, 9970, 9976 BSN 4000), 9935, 9965, Forage Harvesters: (6610, 6710, 6810, 6910 BSN 502211)	Brake Shoe Set Set of 4	AMAH132840	\$ 234.24	
9400, 9410, 9450, 9500, 9500SH, 9510, 9510SH, 9550, 9550SH, 9560, 9560SH, 9560STS, 9570STS, 9600, 9610, 9650, 9650CTS, 9650STS, 9660, 9660CTS, 9660STS, 9670STS, 9750STS, 9760STS, 9770STS, 9860STS, 9870STS, Cotton Pickers: 9935, 9960, 9965, 9970, 9976, 9986, Cotton Strippers: 7450, 7455, 7460, Forage Harvesters: 7180, 7200, 7250, 7280, 7300, 7350, 7380, 7400, 7450, 7480, 7500, 7550, 7580, 7700, 7750, 7780, 7800, Sprayers: 6100, 6500, 6600, 6700	Brake Fluid Reservoir Replaces AH130605, AH208639, AH212578	AMAH215111	\$ 30.04	

John Deere®—Combine

Application	Description	Part Number	Retail Price	Core
Cotton Pickers: 9940, 9950	Brake Plate 16 Tooth, 13.25" OD Use w/ R49427 Brake Shaft	AMR33816	\$ 70.00	
Cotton Pickers: 9940, 9950	Brake Pad 2.50" x 6.50" (6) Pads Required per Side, (12) Total for Tractor Pads Do Not Include Mounting Rivets Replaces R26969, R90085	AMAR28487	\$ 16.00	
Cotton Pickers: 9940, 9950	Brake Pad Rivets 0.135" x 0.203" Includes 36 Rivets (6) Required per pad	AMD1761	\$ 9.00	



Final Drives and Components

Application	Description	Part Number	Retail Price	Core
4400, 4420	Reman Final Drive Standard Duty, 6" Pilot Hole	FD4420	\$ 1208.00	\$ 350.00
	Reman Final Drive, HD 8 5/8" Pilot Hole Replaces AH104872	FD4420HD	\$ 1418.00	\$ 350.00
6600	Reman Final Drive Ratio - 13:89, Small Pinion, Pinion# H75164 Replaces AH86921	FD13-89SP	\$ 1418.00	\$ 350.00
	Reman Final Drive Ratio - 13:89, Big Pinion, Pinion# H85879 Replaces AH106894	FD13-89BP	\$ 1418.00	\$ 100.00
6600, 6620, 7700, 7720	Reman Final Drive 10:82 Ratio, Pinion # - H114203 Replaces AH112972	FD10-82	\$ 1350.00	\$ 350.00
	Reman Final Drive 11:90 Ratio, Big Pinion, Pinion # - H85817	FD11-90BP	\$ 1418.00	\$ 100.00
	Reman Final Drive 10:95 Ratio, Pinion # - H114203	FD10-95	\$ 1575.00	\$ 350.00
	Reman Final Drive 11:104 Ratio, Big Pinion, Pinion # - H85817	FD11-104BP	\$ 1575.00	\$ 350.00
6600, 7700	Reman Final Drive Ratio - 11:90, Small Pinion, Pinion# H75166	FD11-90SP	\$ 1418.00	\$ 350.00
	Reman Final Drive Ratio - 11:104, Small Pinion, Pinion# H75166	FD11-104SP	\$ 1418.00	\$ 350.00
7720, 8820	Reman Final Drive Planetary Type Replaces AH107609	FD8820PT	\$ 2100.00	\$ 350.00
9400, 9410, 9450, 9500, 9510, 9550, 9600, 9610, 9650, 9650CTS, CTS, CTS II	Reman Final Drive Bull Gear Type Replaces AH204987	Right Hand FD9600R	\$ 3675.00	\$ 1000.00
	Reman Final Drive Bull Gear Type Replaces AH204986	Left Hand FD9600L	\$ 3675.00	\$ 1000.00
9600, 9610	Reman Final Drive Planetary Type Replaces AH122742	Right Hand FD9600PTR	\$ 3938.00	\$ 1000.00
	Reman Final Drive Planetary Type Replaces AH122743	Left Hand FD9600PTL	\$ 3938.00	\$ 1000.00

John Deere®—Combine

Application	Description	Part Number	Retail Price	Core
9650, 9650CTS, 9650STS, 9660, 9660CTS, 9660STS, 9670STS, 9750STS, 9760STS, 9770STS, 9860STS, 9870STS	Reman Final Drive Heavy Duty Replaces AH205894, DE31747	Right Hand FD9650R	\$ 3938.00	\$ 2000.00
	Reman Final Drive Heavy Duty Replaces AH205893, DE31746	Left Hand FD9650L	\$ 3938.00	\$ 2000.00
S660, S670	Reman Final Drive 18 Spline Pinion	Right Hand AMAXE10563	\$ 5198.00	\$ 2000.00
		Left Hand AMAXE10562	\$ 5198.00	\$ 2000.00
S670, S680, S690, Cotton Pickers: 7660, 7760, CP690, Cotton Stripper: CS690	Reman Final Drive Extra Heavy Duty 22 Spline Pinion Replaces AN373648	Right Hand AMDE31282	\$ 5198.00	\$ 2000.00
		Left Hand AMDE31283	\$ 5198.00	\$ 2000.00
9400, 9410, 9450, 9500, 9510, 9510SH, 9550, 9550SH, 9560STS, 9600, 9610, 9650, 9650CTS, 9660, 9660CTS, 9660STS, 9760STS, CTS, CTS II, Cotton Pickers: 9970, 9976	Inner Final Drive Housing	Right Hand AMN276474	\$ 905.00	
		Left Hand AMN276475	\$ 905.00	
9400, 9410, 9450, 9500, 9510, 9550, 9560, 9560STS, 9600, 9610, 9650, 9650CTS, 9660, 9660CTS, CTS, CTS II, Forage Harvesters: 7200, 7300, 7400, 7500, 7700, 7800	Outer Final Drive Housing	AMH133092	\$ 650.00	
9410, 9450, 9550, 9550SH, 9560, 9560SH, 9560STS, 9610, 9650, 9650CTS, 9660, 9660STS, 9670STS, 9750STS, 9760STS, 9770STS, 9780STS, 9860STS, 9870STS, 9880STS, CTS, CTS II, S550, S660, S670, S770, S780, S785, S790, Cotton Picker: 9970	Inner Final Drive Housing	Right Hand AMH225885	\$ 1100.00	
		Left Hand AMH225886	\$ 995.00	
9550, 9550SH, 9560STS, 9570STS, 9610, 9650, 9650CTS, 9650STS, 9660, 9660CTS, 9660STS, 9670STS, 9750STS, 9760STS, 9770STS, 9780CTS ASN 072800, 9860STS, 9870STS, C670, CTS II, S550 SN 745100-764999, S650 ASN 765000, (S660, S670, S680, S690 ASN 745100), (S670HM, S680HM BSN 765000), S690HM SN 745101-765000, S760, S770, S780, S785, S790, T550, T560, T660, T670, Cotton Pickers: 7660, 7760, 9970, 9986, 9996, CP690, Cotton Stripper: CS690, Forage Harvesters: 7180, 7200, 7250, 7280, 7300, 7350, 7380, 7400, 7450, 7480, 7500, 7550, 7580, 7700, 7750, 7780, 7800, 7850, 7950, 7980, (8100, 8200, 8300, 8400, 8500, 8600 SN 513822-620999), (8700, 8800 SN 513822-517999), (9600, 9700, 9800, 9900 SN 619000-620999)	Outer Final Drive Housing	AMH163694	\$ 675.00	
S650 ASN 765000, S660 ASN 765172, (S670, S680, S690 ASN 745100), S760, S770, S780, S785, S790, T550, T560, T660, T670, Cotton Pickers: 7660, 7760, 9996, CP690, Cotton Stripper: CS690	Inner Final Drive Housing	Right Hand AMN377018	\$ 825.00	
		Left Hand AMN377019	\$ 775.00	
9500 SideHill, 9550 SideHill, 9560 SideHill	Driveshaft	AMAH137816	\$ 885.00	
9400 ASN 640505, 9410, 9450, 9500 ASN 642630, 9510, 9550, 9560, 9560STS, 9650STS, 9660STS, 9670STS, 9750STS, 9760STS, 9770STS, 9860STS, 9870STS, S550 SN 745100-764999, S660 SN 745100-765171, S670 SN 745100-765252, T550, T560, T660, T670	Final Drive Shaft 17.756" Long Replaces H145553	Right Hand AMH165665	\$ 225.00	
		Left Hand AMH165666	\$ 250.00	
9450, 9550, 9550SH, 9600, 9610, 9650, 9660	Final Drive Shaft	AMH165509	\$ 270.00	
6600, 6620 BSN 553000	Pinion Shaft 11 Tooth, 23 Spline, 6.91" Long Replaces H87638	AMH93884	\$ 329.42	
6600, 6620, 7700, 7720, 8820	Pinion Shaft 11 Tooth, 23 Spline, 8.32" Long For use in 11:104 and 11:90 Big Pinion Final Drives	AMH85817	\$ 143.00	
		Pinion Shaft 10 Tooth, 23 Spline For use w/ 10:82 and 10:95 Final Drives	AMH114203	\$ 165.00
7720, 8820, 9600, 9610	Pinion Shaft 27 & 23 Spline, 8.02" Long	AMH93674	\$ 185.71	

Prices Subject to Change without Prior Notice. The use of original equipment manufacturer (OEM) part numbers or trademarks, e.g. Case® and John Deere®, are for reference purposes only and for indicating product use and compatibility. Our company and the listed replacement parts contained herein are not sponsored, approved or manufactured by the OEM. All parts are New unless designated Reman in the description.

John Deere®—Combine

Application	Description	Part Number	Retail Price	Core
9400, 9410, 9500, 9510, 9600, 9610, CTS II, Cotton Pickers: 9965, 9970, 9976	Pinion Shaft	AMH157014	\$ 195.00	
(9450, 9550, 9650, 9650CTS, 9660, 9660CTS - w/ Heavy Duty Final Drive), 9560, 9560STS, 9650STS, 9660STS, 9750STS, 9760STS, 9860STS, Cotton Pickers: 9970, 9976, 9986, Forage Harvesters: (7180, 7280, 7380, 7480, 7580, 7780, 7950, 7980 - w/ Heavy Duty Final Drive), 7200, 7250, 7300, 7350, 7400, 7450, 7500, 7550, 7700, 7750, 7800, 7850	Pinion Shaft 10 Tooth, 18 Spline, 8.84" Long	AMH167722	\$ 220.00	
Cotton Picker: 7760, Cotton Stripper: CS690 BSN 065000, Forage Harvesters: (8100, 8300, 8400, 8500, 8600, 9800, 9900 BSN 620000), 8200, 8700, 8800	Pinion Shaft 10 Tooth	AMN377016	\$ 195.00	
Cotton Pickers: 9900, 9910, 9920, Cotton Strippers: 7440, 7445 BSN 4001	Pinion Shaft 14 Tooth, 21 Spline, 7.50" Long	AMP48573	\$ 308.97	
9450, 9550, 9550SH, 9560SH, 9560STS, 9650, 9650CTS, 9660, 9660CTS, CTS II, Cotton Pickers: (9970, 9976 ASN 6001), 9986	Pinion 10 Tooth	AMH168899	\$ 295.00	
9400, 9410, 9450, 9500, 9510, 9550, 9560, 9560STS, 9600, 9610, 9650, 9650CTS, 9660, 9660CTS, CTS, CTS II, Forage Harvesters: 7200, 7300, 7400, 7500, 7700, 7800	Axle Spindle Regular Duty	AMH201792	\$ 800.00	
	Spindle Nut - Slotted	AMH129854	\$ 45.00	
9560STS, 9570STS, 9660, 9660STS, 9750STS, 9860STS, CTS II	Axle Spindle 10 Bolt Holes 17.52" Long, 4.328" Diameter, 3.739" Shoulder Diameter	AMH201791	\$ 1124.00	
(S650, S760 BSN 805001 - w/ Heavy Duty Final Drive), S660 ASN 765171, (S670, S770 BSN 805001 - w/ Heavy Duty or Extra Heavy Duty Final Drive), (S680, S690, (S780, S790 BSN 805001) - w/ Extra Heavy Duty Final Drive), Cotton Pickers: 7660, 7760, CP690, Cotton Stripper: CS690	Axle Spindle	AMN380923	\$ 975.00	
9400, 9410, 9450, 9500, 9510, 9550, 9550SH, 9560, 9560SH, 9600, 9610, 9640, 9650CTS, 9650STS, 9660, 9660CTS, 9660STS, 9680, 9750STS, 9760STS, 9860STS, S660, S670, S680, S690, Cotton Pickers: 9970, 9976, 9986, 9996, Forage Harvesters: 6650, 6750, 6850, 6950, 7200, 7300, 7400, 7500, 7700, 7800	Gear 95 Tooth	AMH167723	\$ 995.00	
9410, (9450, 9550, 9650CTS - Heavy Duty), 9560, 9570STS, 9610, 9650, 9650STS, 9660, 9660CTS, 9660STS, 9670STS, 9750STS, 9760STS, 9770STS, 9860STS, 9870STS, S550, S660 SN 745100-765171, S670 SN 745100-765252, Cotton Pickers: 9970, 9976, 9986, 9996, Forage Harvesters: 7180, 7200, 7250, 7280, 7300, 7350, 7380, 7400, 7450, 7480, 7500, 7550, 7580, 7700, 7750, 7780, 7800, 7850, 7950, 7980	Cap	AMH161540	\$ 25.00	



Axle Drive Shafts and Couplers

Application	Description	Part Number	Retail Price	Core
4400 ASN 151501 w/ Heavy Duty Final Drive, 4420	Axle Drive Shaft 21 Spline, 14.688" Long	AMH87165	\$ 135.02	
(6600 ASN 105891, 6620 w/ Hydro Transmissions)	Axle Drive Shaft 23 Spline, 9" Long	Right Hand AMH123619	\$ 114.00	
6600 ASN 105891 w/ Belt Drive Transmission Right or Left Hand, 6620 w/ Posi-Torq™ Transmission Right or Left Hand, 7700 ASN 111901 w/ Posi-Torq™ Transmission Left Hand Only, 7720 w/ Posi-Torq™ Transmission Left Hand Only	Axle Drive Shaft 23 Spline, 14.938" Long	AMH123613	\$ 119.91	
(6600, 6620, 7700, 7720 - w/ 16" Axle Extensions)	Axle Drive Shaft 23 Spline, 15.75" Long Replaces H95197	AMH123630	\$ 75.00	
(6600 ASN 105981, 6620, 7700 ASN 111901, 7720 - w/ Hydro Transmissions)	Axle Drive Shaft 23 Spline, 20.813" Long Replaces H85875, H104542	Left Hand AMH123612	\$ 99.00	
(6600, 6620, 7700, 7720 - w/ 8" Axle Extensions)	Axle Drive Shaft 23 Spline, 7.75" Long	AMH123629	\$ 106.55	

John Deere®—Combine

Application	Description	Part Number	Retail Price	Core
(7700 ASN 111901, 7720 - w/ Hydro Transmissions)	Axle Drive Shaft 23 Splines, 19.875" Long Replaces H85877, H104544	Right Hand AMH123614	\$ 90.00	
7700 ASN 602386 w/ Belt Drive, 7720 w/ Posi-Torq™ Drive	Axle Drive Shaft 23 Spline, 25.813" Long Replaces H85874, H104541	Right Hand AMH123611	\$ 81.00	
8820	Axle Drive Shaft 23 Spline, 30.688" Long	Right Hand AMH123624	\$ 81.00	
9400, 9410, 9450, 9500, 9510, 9550, 9560, 9560STS, 9570STS, 9600, 9610, 9650, 9650CTS, 9650STS, 9660, 9660CTS, 9660STS, 9670STS, 9750STS, 9760STS, 9770STS, 9860STS, 9870STS, CTS, CTS II, S550, (S650, S660, S670 BSN 785001), Cotton Pickers: 9970, 9976, 9986	Axle Drive Shaft 18 Tooth, 15.748" Long, 1.575" ID, 1.772" OD Replaces H133246	AMH165663	\$ 245.92	
9400, 9410, 9450, 9500, 9510, 9550, 9560, 9560STS, 9570STS, 9650STS, 9660STS, 9670STS, 9750STS, 9760STS, 9770STS, 9860STS, 9870STS, S550, S660 BSN 765171, S670 BSN 765252, Cotton Pickers: 9976, 9986	Axle Drive Shaft 18 Spline, 17.874" Long, 1.331" ID, 1.772" OD Replaces H133248	AMH165664	\$ 193.68	
9400, 9410, 9450, 9500, 9510, 9560, 9560SH, 9560STS, 9570STS, 9600, 9610, 9650, 9650CTS, 9650STS, 9660STS, 9670STS, 9750STS, 9760STS, 9770STS, 9860STS, 9870STS, CTS, CTS II, S550, S660 BSN 765172, S670 BSN 765253, Cotton Pickers: 9970, 9976, 9986	Axle Drive Shaft 18 Tooth, 11.811" Long, 1.575" ID, 1.772" OD Replaces H133244	AMH165662	\$ 224.10	
4400 ASN 103931, 4420, 6600 BSN 105891, 7700 BSN 111901	Axle Drive Shaft Coupler 21 Spline, 4" Long Replaces P48679	AMH91808	\$ 68.35	
6600, 6620, 7700, 7720, 7722, 8820, Forage Harvesters: 5440, 5460, 5720, 5820	Axle Drive Shaft Coupler 23 Spline, 4" Long Replaces H106340	AMH106283	\$ 43.00	
9400, 9410, 9450, 9500, 9510, 9550, 9560STS, 9570STS, 9600, 9610, 9650, 9650CTS, 9650STS, 9660, 9660CTS, 9660STS, 9670STS, 9750STS, 9760STS, 9770STS, 9780CTS, 9860STS, 9870STS, CTS, CTS II, S550, S660, S670, S680, S690, S760, S770, S780, S790, Forage Harvesters: 6650, 6750, 6850, 6950, 7180, 7200, 7250, 7280, 7300, 7350, 7380, 7400, 7450, 7480, 7500, 7550, 7580, 7700, 7750, 7780, 7800, 7850, 7950, 7980	Axle Drive Shaft Coupler 18 Spline 4.016" Long, 2.156" OD, Replaces H133230, HXE30611	AMH165510	\$ 30.00	
9400, 9410, 9450, 9500, 9510, 9550, 9550SH, 9560STS, 9600, 9610, 9650, 9650CTS, 9650STS, 9660, 9660CTS, 9660STS, 9670STS, 9750STS, 9760STS, 9770STS, 9860STS, 9870STS, CTS, CTS II, S550 SN 745100-764999, S650 ASN 765000, (S660, S670, S680 ASN 745100), S690 ASN 765250, Forage Harvesters: 6610, 6650, 6710, 6750, 6810, 6850, 6910, 6950, 7180, 7200, 7250, 7280, 7300, 7350, 7380, 7400, 7450, 7480, 7500, 7550, 7580, 7700, 7750, 7780, 7800, 7850, 7950, 7980	Axle Drive Coupler Pin 2.047" Long, 0.394" OD	AMH131754	\$ 3.28	

Hydraulic Oil Coolers

Application	Description	Part Number	Retail Price	Core
9400 ASN 655100, 9410, 9450, (9500, 9500SH ASN 655200), 9510, (9550, 9550SH BSN 700201), 9600 ASN 650301, 9610, 9650 BSN 695301, CTS, CTS II	Hydraulic Oil Cooler Large Hose Fittings at Bottom Core: 26 3/8" x 1" x 2.50" Replaces AH145232	AMAH149588	\$ 655.00	
9400 BSN 6655100, 9500 BSN 556200, 9600, CTS BSN 665400	Hydraulic Oil Cooler Large Hose Fittings at Top Core: 21" x 26.50" x 2 7/8" Replaces AH120854	AMAH140472	\$ 1117.00	
9500, 9500SH, 9510, 9510SH, 9550, 9550SH, 9560, 9560SH, 9560STS, 9570STS, 9600, 9610, 9650, 9650CTS, 9650STS, 9660, 9660CTS, 9660STS, 9670STS, 9750STS, 9760STS, 9770STS, 9860STS, 9870STS, CTS II, S550, S650, S660, S670, S680, S690, S670 HillMaster, S680 HillMaster, S690 HillMaster, S760, S770, S780, S790	Hydraulic Oil Cooler	AMAH150687	\$ 250.00	

John Deere®—Combine

Application	Description	Part Number	Retail Price	Core
9550 ASN 700701, 9560STS, 9570STS, 9650 ASN 695301, 9650CTS ASN 695401, 9650STS ASN 695501, 9660, 9660CTS, 9660STS, 9670STS, 9760STS, 9770STS, 9780CTS ASN 072800, 9860STS, C670, S550 SN 745100-764999, (S660, S670 ASN 745100), T550, T560, T660, T670	Hydraulic Oil Cooler	AMAH168468	\$ 816.00	
Cotton Picker: 9996	Hydraulic Oil Cooler Core: 24" x 26.50" x 2.60"	AMAN278767	\$ 1500.00	
Forage Harvesters: (6750, 6850, 6950 BSN 504392, 6810, 6910 - w/ Hydraulic Oil Cooler), (6750, 6850, 6950 BSN 504392, 6810, 6910 - w/ Hydrostat Oil Cooler)	Hydraulic Oil Cooler Core: 38" x 24" x 3"	AMAZ45114	\$ 3900.00	
Sprayer: 4630	Hydraulic Oil Cooler	AMAT349069	\$ 292.00	
Sprayer: 4720	Hydraulic Oil Cooler Core: 12.75" x 21.50" x 3"	AMRE566108	\$ 1510.00	
Sprayer: 4940	Hydraulic Oil Cooler w/ Fuel Cooler Replaces AN403706	AMAKK12180	\$ 1645.00	
Sprayers: R4030, R4038, R4045	Hydraulic Oil Cooler	AMAN402266	\$ 2100.00	
Swathers: W235, W260	Hydraulic Oil Cooler	AMAFH212196	\$ 1558.00	
9400, 9500, 9500SH, 9600, CTS	Condenser w/ Dual Oil Cooler Core: 22 1/2" x 33" x 5 1/8"	AMAH150219	\$ 790.00	
9550 ASN 700201, 9560, 9560SH, 9560STS, 9570STS, 9650 ASN 695301, 9660, 9660CTS	Condenser w/ Oil Cooler	AMAH168467	\$ 1075.00	
9960, 9965, 9970	Condenser w/ Oil Cooler	AMAN194102	\$ 1585.00	
Cotton Pickers: 9940, 9950	Condenser w/ Oil Cooler Replaces AR75968	AMAR78958	\$ 1675.00	
Swather: A400	Condenser w/ Oil Cooler	AMAFH202216	\$ 2207.00	
Swathers: W235, W260	Condenser w/ Oil Cooler	AMAFH210943	\$ 1015.00	

Hydraulic Pumps

Application	Description	Part Number	Retail Price	Core
Cotton Pickers: 7760, CP690, Cotton Stripper: CS690	Hydraulic Pump, Baler Drive 85 cc	AMAN278775	\$ 5585.00	
Cotton Pickers: 9920, 9930, 9940, 9950, Cotton Strippers: 7440, 7445	Hydraulic Pump Keyed Input Shaft - 8 Pistons	AMAR103033	\$ 515.00	
Cotton Pickers: 9950, 9960, 9965, 9970 BSN 16000	Hydraulic Pump Drive Coupler Replaces T58195	AML34569	\$ 15.00	
Cotton Pickers: 9950, 9960, 9965, 9970	Hydraulic Pump Drive Cushion	AMR78202	\$ 8.00	

Hydraulic Components

Application	Description	Part Number	Retail Price	Core
Cutting Platforms: (615F, 615R, 618F, 618R, 620F, 620R, 622F, 622R, 625F, 625R, 630F, 630R, 635F, 635R - w/ Hydraulic Fore and Aft), (913F, 913R, 915F, 915R, 916F, 916R, 918F, 918R, 922F, 922R, 924F, 924R, 925F, 925R, 930F, 930R ASN 685400 w/ Multi-Coupler Conversion for 60 Series Combines and Hydraulic Fore and Aft), Draper Platforms: (625D, 630D, 630FD, 635D, 635FD, 640FD, 725D, 730D, 730FD, 735D, 735FD, 740D, 740FD, 745FD, 925D, 930D, 936D - w/ Hydraulic Fore and Aft), Cornheads: 493, 494, 594, 692, 693, 694	Hydraulic Coupler Block Plate w/ Couplers Replaces AH201340, AH208706, HXE117551	AMX27551	\$ 760.00	
493, 494, 594, 693, 606, 606C, 608, 608C, 612, 612C, 616, 616C, 618, 618C, 694, 894, 1092, 1290, 1293	Seal Kit, Hydraulic Quick Coupler	AMAH225672	\$ 22.00	
Platforms: 615F, 615R, 618F, 618R, 620F, 622F, 622R, 622X, 625F, 625R, 625X, 630F, 630R, 630X, 635F, 635R, 635X, 640X	Seal Kit, Hydraulic Quick Coupler	AMAH225673	\$ 28.00	

John Deere®—Combine

Feederhouse Chains

Our feederhouse chains for John Deere® combines use high-quality materials to meet exact specifications. Our t-slats are mounted in the middle of the links. Slats are mounted using 3/8" grade 5 plated bolts and locknuts for easy replacement. Chains feature full side plates and high-strength steel for added durability. Call for different slat and chain configurations available to fit your application.



Application	Description	Part Number	Retail Price	Core
4400, 4420	Feederhouse Chain 87 Links - T Slat, Wide Spaced Slats every 2nd and 4th link 3 Chain Assembly	AMAH116711	\$ 475.00	
	T-Slat For 16" Chain Centers	AMH85894	\$ 15.00	
6600, 6620, 6620 Titan II	Feederhouse Chain 87 links - T Slat, Closed Spaced Slats every 2nd link 3 Chain Assembly	AMAH123450	\$ 595.00	
	Feederhouse Chain 87 links - T Slat, Wide Spaced Slats every 2nd and 4th link 3 Chain Assembly	AMAH116713	\$ 475.00	
	Feederhouse Chain 104 links - T Slat, Wide Spaced Slats every 2nd and 4th link 3 Chain Assembly	AMAH116714	\$ 797.36	
	T-Slat For 19" Chain Centers	AMH85895	\$ 15.00	
7700, 7701, 7720, 7720 Titan II, 7721	Feederhouse Chain 87 links - T Slat, Closed Spaced Slats every 2nd link 3 Chain Assembly	AMAH123451	\$ 645.00	
	Feederhouse Chain 87 links - T Slat, Wide Spaced Slats every 2nd and 4th link 3 Chain Assembly	AMAH116716	\$ 449.00	
	Feederhouse Chain 102 links - T Slat, Closed Spaced Slats every 2nd link 3 Chain Assembly	AMAH123536	\$ 1082.43	
	Feederhouse Chain 102 links - T Slat, Wide Spaced Slats every 2nd and 4th link 3 Chain Assembly	AMAH116717	\$ 723.38	
	T-Slat For 24 3/8" Chain Centers	AMH84497	\$ 18.00	
8820, 8820 Titan II	Feederhouse Chain 86 links - T Slat, Closed Spaced Slats every 2nd link 4 Chain Assembly	AMAH123452	\$ 1013.65	
	Feederhouse Chain 86 links - T Slat, Wide Spaced Slats every 2nd and 4th link 4 Chain Assembly	AMAH116718	\$ 607.00	
	Feederhouse Chain 128 links - T Slat, Wide Spaced Slats every 2nd and 4th link 4 Chain Assembly	AMAH116719	\$ 1118.74	
	T-Slat For 19 15/16" Chain Centers	AMH93558	\$ 19.00	

John Deere®—Combine

Application	Description	Part Number	Retail Price	Core
9400, 9500, 9450, 9550, 9410, 9510, CTS, CTS II	Feederhouse Chain 101 links - T Slat, Closed Spaced, chrome pins Slats every 2nd link 3 Chain Assembly	AMAH137845	\$ 755.00	
	T-Slat For 23 3/4" Chain Centers	AMH206436	\$ 18.00	
9400, 9500, 9450, 9550, 9410, 9510, 9560, CTS, CTS II	Feederhouse Chain 101 links - T Slat, Wide Spaced, chrome pins Slats every 2nd & 4th link 3 Chain Assembly, 557 Chain HD Replacement for AH207777	AMAH217634	\$ 795.00	
	Feederhouse Chain 101 links - T Slat, Wide Spaced, chrome pins Slats every 2nd and 4th link 3 Chain Assembly Replaces AH207777	AMAH138187	\$ 725.00	
	T-Slat For 23 3/4" Chain Centers	AMH206436	\$ 18.00	
9500SH, 9510SH, 9550SH, 9560SH	Feederhouse Chain 83 links - T Slat, 23 3/4" Center Spacing	AMAH137604	\$ 743.86	
9560STS, 9570STS, S550	Feederhouse Chain 89 links - T Slat, chrome pins Slats every 2nd and 4th link 3 Chain Assembly - CA557 Chain, 18 3/8" Center-to-Center Replaces AH231006	AMAH219918	\$ 750.00	
	T-Slat For 18.375" Chain Centers	AMH203392	\$ 18.00	
9600, 9610, 9650, 9660	Feederhouse Chain 101 links - T Slat, Wide Spaced, chrome pins Slats every 2nd and 4th link 4 Chain Assembly, CA550 Replaces AH138186	AMAH207778	\$ 1055.00	
	Feederhouse Chain 101 links - T Slat, Closed Spaced, chrome pins Slats every 2nd link 4 Chain Assembly, CA550 Replaces AH143400	AMAH137844	\$ 1095.00	
	Feederhouse Chain 101 links - T Slat, Wide Spaced, chrome pins Slats every 2nd and 4th link 4 Chain Assembly, CA557 Replaces AH138186	AMX28009	\$ 1238.00	
9600, 9610, 9650, 9660, 9660W	T-Slat For 19 3/8" Chain Centers	AMH207776	\$ 7.00	
9650STS, 9660STS BSN 720301, 9750STS, 9760STS BSN 720301, 9860STS BSN 720501	Feederhouse Chain 89 links - T Slat, chrome pins Slats every 2nd and 4th link 3 Chain Assembly - CA557 Chain, 23 3/4" Center-to-Center Replaces AH209913, AH209915, AH212232, AH217632	AMAH217633	\$ 791.00	
(9660STS, 9760STS ASN 720300), 9670STS, 9770STS, 9860STS ASN 720500, 9870STS BSN 730101	Feederhouse Chain 91 links - Cast Slats, High Capacity, Wide Spaced, chrome pins 23.75" Chain Spacing 3 Chain Assembly Replaces AH220517, AH229908, AXE12764	AMAXE17470	\$ 1148.00	
	Cast Slat Replaces H229581	AMHXE24328	\$ 40.00	

John Deere®—Combine

Application	Description	Part Number	Retail Price	Core
(9670STS, 9770STS, 9870STS ASN 730100), (S660, S670, S680, S690 BSN 775001)	Feederhouse Chain 91 links - Cast Slats, High Capacity, Wide Spaced, chrome pins 21.625" Chain Spacing 3 Chain Assembly Replaces AXE17889, AXE17466, AH228592	AMAXE24307	\$ 1148.00	
	Chain Only Kit	AMAXE24307CO	\$ 803.00	
	Cast Slat Replaces H229581	AMHXE24328	\$ 40.00	
9880STS	Feederhouse Chain 101 links - T Slat, chrome pins 3 Chain Assembly, CA557	AMAH217634	\$ 795.00	
(S650, S660, S670, S680, S690 ASN 775000), S760, S770, S780, S790	Feederhouse Chain 91 links - 18 U-Shaped Steel Slats, 9 Cast Slats Slats every 4th and 6th link 4 Chain Assembly	AMAXE27247	\$ 1490.00	
S650, (S660, S670, S680, S690 ASN 775001), S760, S770, S780, S790	Cast Slat Replaces H229581	AMHXE24328	\$ 40.00	

Feederhouse Chain Sprockets

To extend the life of your chain assemblies, always replace the sprockets when installing a new chain.



Application	Description	Part Number	Retail Price	Core
3300, 4400, 4420, 6600, 6601, 6602, 7700	Feederhouse Chain Sprocket 10 Tooth, 1.50" Hex	AMH121435	\$ 35.00	
6600, 6620, 6622, 7700, 7720, 7721, 8820, 9400 ASN 641501, 9500 ASN 643901, 9600 ASN 645301, CTS	Feederhouse Chain Sprocket 10 Tooth, 1.75" Hex Bore	AMH118583	\$ 49.50	
9410, 9450, 9510, 9550, 9560, 9610, 9650, 9650CTS, 9660, 9660CTS, CTS II	Feederhouse Chain Sprocket - Outside 10 Tooth, 2.25" Round (2) Required	AMH159613	\$ 45.00	
9410, 9450, 9510, 9550, 9560, 9610*, 9650*, 9650CTS, 9660*, 9660CTS, CTS II *2 Required On These Models	Feederhouse Chain Sprocket - Inside 10 Tooth, 2.25" Round	AMH159614	\$ 53.00	
9560STS, 9570STS, 9650STS, 9660STS, (9670STS, 9770STS, 9870STS BSN 730100), 9750STS, 9760STS, 9860STS	Feederhouse Chain Sprocket - Outside 13 Tooth, 2.25" Round, (2) Required	AMH159615	\$ 51.00	
	Feederhouse Chain Sprocket - Inside 13 Tooth, 2.25" Round	AMH159616	\$ 57.00	
(9670STS, 9770STS, 9870STS ASN 730101), S650, S660, S670, S680, S690, S690HM, S760, S770, S780, S790	Feederhouse Chain Sprocket 13 Tooth Replaces H227474	AMHXE123463	\$ 85.00	

Upper Sprocket Tubes



Application	Description	Part Number	Retail Price	Core
9400 BSN 641500, 9500 BSN 643900	Sprocket Tube 10 Tooth, 52.18" Long	AMAH125196	\$ 495.00	
9600 BSN 645300	Sprocket Tube 10 Tooth, 63" Long	AMAH125195	\$ 638.00	

John Deere®—Combine



Feederhouse Drums and Shafts

Application	Description	Part Number	Retail Price	Core
(9670STS, 9770STS, 9870STS ASN 730101), (S650, S660, S670, S680, S690 BSN 775000)	Feederhouse Drum Assembly, Narrow	AMAH216876	\$ 432.00	
(9670STS, 9770STS, 9870STS ASN 730101), (S650, S660, S670, S680, S690 BSN 775000)	Feederhouse Drum, Posifeed	AMAH216876-PF	\$ 976.76	
6600, 6620	Feederhouse Drum Replaces AH79392	AMAH84645	\$ 527.28	
9400, 9410, 9450, 9500, 9510, 9550, 9650CTS, 9650STS, 9750STS, CTS, CTS II SN 675101-679050	Feederhouse Drum	AMAH142394	\$ 587.00	
9560STS ASN 720101, 9570STS, S550	Feederhouse Drum	AMAH220243	\$ 725.00	
9560STS ASN 720101, 9570STS, S550	Feederhouse Drum, Posifeed	AMAH220243-PF	\$ 954.87	
9560 ASN 710392, 9660CTS ASN 710408, 9660STS, 9760STS, 9860STS	Feederhouse Drum Replaces AH218323-PF	AMAH218323	\$ 678.00	
9600, 9610, 9650	Feederhouse Drum	AMAH142393	\$ 595.00	
9600, 9610, 9650 Contour-Master™	Feederhouse Drum	AMAH143365	\$ 1011.00	
(9660STS, 9760STS ASN 720301), (9670STS, 9770STS, 9870STS BSN 730100), 9860STS ASN 720501	Feederhouse Drum	AMAH220242	\$ 805.38	
(9660STS, 9760STS ASN 720301), (9670STS, 9770STS BSN 730100), 9860STS ASN 720501, 9870STS BSN 730100	Feederhouse Drum, Posifeed Heavy Duty, Narrow	AMAH220242-PF	\$ 924.78	
(S650, S660, S670, S680, S690 ASN 775000), S760, S770, S780, S785, S790	Feederhouse Drum	AMAXE27254	\$ 716.86	
6600, 6601, 6620	Feederhouse Drum Shaft 42.56" Long	AMH76631	\$ 60.00	
7700, 7701, 7720, 7721	Feederhouse Drum Shaft 53.375" Long	AMH77755	\$ 70.00	
8820	Feederhouse Drum Shaft 64.25" Long	AMH98558	\$ 80.00	
9400, 9410, 9450, 9500, 9510, 9550, 9650CTS, 9650STS, 9750STS, CTS, CTS II SN 675101-679050	Feederhouse Drum Shaft 52" Long	AMH123734	\$ 80.00	
9560 ASN 710391, (9650STS, 9750STS ASN 000808), 9660CTS ASN 710407, (9660STS, 9760STS ASN 711301), (9670STS, 9770STS BSN 730101), 9860STS ASN 710892, 9870STS BSN 730101	Feederhouse Drum Shaft 52.50" Long, 1.25" Hex Diameter	AMH218671	\$ 79.00	
9560STS ASN 710559, 9570STS, S550	Feederhouse Drum Shaft 41.94" Long, 1.25" Hex Diameter	AMH218670	\$ 151.41	
9600, 9610, 9650	Feederhouse Drum Shaft 63.625" Long	AMH123733	\$ 83.00	
3300, 4400, 4420, 6600, 6620, 7700, 7720, 8820	Feederhouse Drum Shaft Arm 16.75" Long Replaces AH79728	AMAH116698	\$ 30.00	
9400, 9410, 9450, 9500, 9510, 9550, 9600, 9610, 9650, 9650CTS, 9650STS, 9750STS, CTS, CTS II	Feederhouse Drum Shaft Arm 16.50 Long	AMAH126091	\$ 33.00	
9560, 9560STS, 9660, 9660CTS, 9660STS, 9760STS, 9860STS	Feederhouse Drum Shaft Arm	AMAH218367	\$ 78.00	
9570STS, 9670STS, 9770STS, 9870STS	Feederhouse Drum Shaft Arm	AMAH226296	\$ 79.06	
4400, 4420 BSN 550001	Upper Feederhouse Shaft 46.375" Long Replaces H77959, H83783, H84329	AMH86092	\$ 199.52	
6600, 6620 BSN 551901	Upper Feederhouse Shaft 52.375" Long, 1 3/4" Hex Diameter Replaces H83784, H84330	AMH86088	\$ 306.71	
6620 ASN 551901	Upper Feederhouse Shaft 52.375" Long	AMH113408	\$ 242.86	

Prices Subject to Change without Prior Notice. The use of original equipment manufacturer (OEM) part numbers or trademarks, e.g. Case® and John Deere®, are for reference purposes only and for indicating product use and compatibility. Our company and the listed replacement parts contained herein are not sponsored, approved or manufactured by the OEM. All parts are New unless designated Reman in the description.

John Deere®—Combine

Application	Description	Part Number	Retail Price	Core
7700, 7720 BSN 556300	Upper Feederhouse Shaft 63.375" Long	AMH86089	\$ 162.62	
7720 ASN 556301, 7722	Upper Feederhouse Shaft 63.875" Long	AMH113407	\$ 206.98	
8820 BSN 564100	Upper Feederhouse Shaft 74.687" Long	AMH98560	\$ 246.96	
8820 ASN 564101	Upper Feederhouse Shaft 74.687" Long	AMH113406	\$ 446.11	
9400 ASN 641500, 9500 ASN 643900, 9500SH, CTS	Upper Feederhouse Shaft 63" Long Replaces H143353	AMH151566	\$ 367.00	
9410, 9450, 9510, 9510SH, 9550, 9550SH, 9560, 9560SH, 9560STS, 9650CTS, 9660STS, 9750STS, 9760STS, 9860STS, CTS II	Upper Feederhouse Shaft 62.94" Long	AMH156576	\$ 544.00	
9560STS	Upper Feederhouse Shaft 53.38" Long	AMH203039	\$ 458.64	
9600 ASN 645301	Upper Feederhouse Shaft 73.81" Long	AMH151567	\$ 332.00	
9610, 9650, 9660	Upper Feederhouse Shaft 73.87" Long	AMH156577	\$ 550.00	
9660STS, (9670STS, 9770STS, 9870STS BSN 730101), 9760STS, 9860STS	Upper Feederhouse Shaft 21 Spline, 63.06" Long	AMH203850	\$ 558.31	
9670STS, 9770STS, 9870STS, S650, S660, S670, S670HM, S680, S680HM, S690, S690HM, S770, S780, S785, S790	Upper Feederhouse Shaft	AMH224510	\$ 1046.00	
S650, S660, S670, S690, S760, S770, S780, S785, S790	Upper Feederhouse Shaft	AMHXE42567	\$ 600.00	
4400, 4420, 6600 w/ Variable Belt Drive or ASN 206201 w/ Fixed Belt Drive, 6620 ASN 615101 w/o Reverser, 7700 w/ Variable Belt Drive or ASN 213301 w/ Fixed Belt Drive, 7720 ASN 615201 w/o Reverser, 8820 BSN 414850 w/ Long Feederhouse	Lower Feederhouse Shaft 91.50" Long Replaces H80922, H80923, H80924	AMH115230	\$ 296.42	
6620 w/ Feed Reverser	Lower Feederhouse Shaft 91.625" Long	AMAH97641	\$ 395.00	
7720 w/ Feed Reverser, 9501, (9400, 9410, 9500, 9510, CTS, CTS II SN 675101-679050 Fixed Speed w/ Reverser or Variable Speed)	Lower Feederhouse Shaft 91.437" Long Does Not Fit Contour Master Combines	AMAH97642	\$ 477.64	
9450, 9550, 9650	Feederhouse Shaft 63.06" Long	AMAH166651	\$ 341.07	
4420 ASN 550000, 6620 ASN 551900 w/ Regular Variable Drive or ASN 615100 w/ Regular Fixed Drive w/o Reverser, 6620SH SN 403300, 7720**, 8820 ASN 564100 w/ Variable Drive or ASN 564100 w/ Long Fixed Drive, 9400 ASN 641500, (9410, CTS, CTS II - w/ Fixed Speed), 9450, 9500, 9510, 9550, 9550SH, 9560, 9560SH, 9560STS, 9570STS, 9600 ASN 645300, 9610, 9650, 9650CTS, 9650STS, 9660, 9660CTS, 9660STS, 9670STS, 9750STS, 9760STS, 9770STS, 9860STS, 9870STS **Will fit a 7720 if the Combine fits one of the following criteria: - ASN 556300 w/ Regular Variable Drive - SN 556301-615200 w/ Regular Fixed Drive - All SN's w/ Fixed Drive w/ Reverser - ASN 615200 w/ Regular Fixed Drive w/o Reverser - ASN 556300 w/ Long Fixed Drive	Ball Bearing, Upper Feederhouse Shaft 3.1496" OD, 1.25" Hex Bore Diameter Replaces 575883, 70575883, 86523785	AMJD9373	\$ 15.00	
6600, 6620, 7700, 7720*, 8820 BSN 564101 *Will fit a 7720 if the Combine fits one of the following criteria: - BSN 556301 w/ Regular Variable Drive - BSN 556301 w/ Regular Fixed Drive w/ Reverser - BSN 409101 w/ Regular Fixed Drive w/o Reverser - BSN 556302 w/ Long Fixed Drive	Bearing, Upper Feederhouse Shaft 1.25" ID, 2.441" OD Replaces JD8545, JD9274	AMJD9452	\$ 27.30	

John Deere®—Combine

Application	Description	Part Number	Retail Price	Core
8820, 9400, 9500, 9600 BSN 637232	Bearing Housing 2.37" ID For Feederhouse Drum Shaft Replaces H93938	AMH97919	\$ 69.05	
9400 ASN 635700, 9410, 9450, (9500, 9500SH, ASN 638058), 9501, 9510, 9510SH, 9550, 9550SH, 9600 ASN 637232, 9610, 9650, 9650CTS, 9650STS, 9750STS, CTS, CTS II	Bearing Housing For Feeder Roller Shaft	AMH138753	\$ 51.70	
9400 BSN 641501, 9500 BSN 643901, 9600 BSN 645301	Bearing, Upper Feederhouse Shaft Tapered Roller Bearing 1.456" Wide, 2.677" OD, 1.535" Bore	AMAH109788	\$ 54.59	
9560, 9560STS ASN 720100, 9570STS, 9650, 9650CTS, 9650STS, (9660STS, 9760STS ASN 720300), 9670STS, 9750STS, 9770STS, 9860STS ASN 720500, 9870STS, S550, S650, S660, S670, S670HM, S680, S680HM, S690, S690HM, S760, S770, S780, S790	Bearing w/ Housing For Feederhouse Drum Shaft	AMAH219987	\$ 79.00	
9560STS ASN 720100, 9570STS, (9660STS, 9760STS ASN 720300), (9670STS, 9770STS, 9870STS BSN 730101), 9860STS ASN 720500, S550	Bearing Cap	AMAH220241	\$ 83.50	



Feederhouse Floor Sheets

Application	Description	Part Number	Retail Price	Core
6600 ASN 5305, 6620 Excluding SideHill	Feederhouse Sheet Lower Front Bottom	AMAH88598	\$ 310.00	
7700 ASN 163900 w/ Regular Feederhouse	Feederhouse Sheet False Bottom 43 3/4" Long, 45 3/4" Wide Replaces AH83329, AH84115, AH86797	AMAH89523	\$ 338.64	
7700, 7720	Feederhouse Sheet Upper Back Bottom Regular Length Feederhouse	AMAH83620	\$ 210.00	
7700 ASN 3642, 7720	Feederhouse Sheet Lower Front Bottom	AMAH88599	\$ 357.00	
7720	Feederhouse Sheet Regular Length Feederhouse 43.50" x 37"	AMAH124954	\$ 240.67	
8820	Feederhouse Sheet Lower Front Bottom	AMAH96439	\$ 417.16	
	Feederhouse Sheet Upper Back Bottom Regular Length Feederhouse	AMAH96541	\$ 295.00	
9400, 9410, 9450, 9500, 9510, 9510SH, 9550, 9550SH, 9650CTS	Feederhouse Sheet, Return For Airflow Retrofit Installation	AMAH155650	\$ 159.96	
9400, 9500	Feederhouse Sheet Bottom Floor Replaces AH159703	AMAH137733	\$ 625.00	
9560, 9660CTS	Feederhouse Sheet, Narrow	AMAH166026	\$ 597.14	
9600, 9610, 9650	Feederhouse Sheet Bottom Floor Replaces AH159704	AMAH137732	\$ 857.00	
9650STS, 9750STS	Feederhouse Sheet Bottom Floor	AMAH147800	\$ 767.71	
9660	Feederhouse Sheet, Wide	AMAH166027	\$ 702.48	













John Deere®—Combine

Application	Description	Part Number	Retail Price	Core
(9660STS, 9760STS ASN 715701), 9670STS, 9770STS, 9860STS ASN 720501, 9870STS, S650 SN 765000-785000, (S660, S670, S680, S690 SN 745100-785000), (S670HM, S680HM BSN 765000), S690HM SN 745101-765000	Feederhouse Sheet Lower Front Bottom	AMH219180	\$ 194.00	
9660STS, 9670STS, 9760STS, 9770STS, 9860STS, 9870STS, S660, (S670, S680, S690 BSN 775000)	Feederhouse Sheet Replaces AXE15498, AXE24554	AMAH218352	\$ 913.00	
9660STS, 9760STS, 9860STS	Feederhouse Sheet, Front	AMH214781	\$ 150.00	
(S660, S670, S680, S690 ASN 775001 w/ Fore/Aft Tilt)	Feederhouse Sheet	AMAXE29353	\$ 760.00	
S660 ASN 765172, S670 ASN 765253, S680 ASN 766007, S690 ASN 765250, S760, S770, S780, S785, S790	Feederhouse Sheet, Floor	AMAXE36568	\$ 975.00	

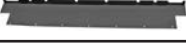







Feederhouse Components

Application	Description	Part Number	Retail Price	Core
6600, 6620	Feederhouse Separator Plate Replaces H82498	AMH102469	\$ 167.77	
 7700, 7720	Feederhouse Separator Plate Replaces H94330	AMH102470	\$ 193.52	
8820	Feederhouse Separator Plate Replaces H99026	AMH102471	\$ 219.59	
 9400 ASN 640101, 9500 ASN 640201, 9600 ASN 640301, CTS, CTS II	Feederhouse Drive Shield, Right Hand	AMAH156377	\$ 325.00	
 9400 BSN 640100, 9500 BSN 640200, 9501 BSN 640400, 9600 BSN 640300	Feederhouse Drive Shield, Right Hand	AMAH130894	\$ 195.00	
 9560STS, (9650STS, 9750STS - South American ASN 000181), 9660STS, 9760STS, 9860STS	Feederhouse Drive Shield, Right Hand	AMH206543	\$ 175.00	
 9560STS, (9650STS, 9750STS - South American ASN 000181), 9660STS, 9760STS, 9860STS	Feederhouse Drive Shield, Left Hand	AMH205822	\$ 155.00	
 9600, 9610	Feederhouse Drive Shield, Left Hand Replaces AH134825, AH139995, AH155245	AMAH156376	\$ 275.00	
 9410, 9450, 9510, 9550, 9610, 9650, 9650CTS, 9650STS, 9750STS, CTS, CTS II	Deflector Shield, Right Hand For Feederhouse Drum, Front Replaces H123636	AMH159533	\$ 55.00	
9410, 9450, 9510, 9550, 9610, 9650, 9650CTS, 9650STS, 9750STS, CTS, CTS II	Deflector Shield, Left Hand For Feederhouse Drum, Front Replaces H123637	AMH159534	\$ 55.00	
 9400, 9410, 9450, 9500, 9510, 9550, 9650CTS, 9650STS, 9750STS, CTS, CTS II SN 675101-679050	Front Shield	AMH123633	\$ 80.00	
 9600, 9610	Front Shield	AMH123632	\$ 90.00	
 7700 ASN 213300, 7720	Stone Trap Support	AMAH90845	\$ 147.78	
9400, 9410, 9500, 9501, 9510, CTS, CTS II	Stone Trap Door 54.50" Wide	AMAH120502	\$ 201.39	
 9600, 9610 BSN 680300	Stone Trap Door 65.375" Wide	AMAH120501	\$ 198.51	
9570STS, S550	Stone Trap Hinge Narrow Version	AMAH227674	\$ 151.99	









John Deere®—Combine

Application	Description	Part Number	Retail Price	Core
 (9660STS, 9760STS ASN 720300), 9670STS, 9770STS, 9860STS ASN 720500, 9870STS, S650, (S660, S670, S680, S690 ASN 795000 w/ Solid Slat Chaffer Element), S670HM, S680HM, S690HM, S760, S770, S780, S785, S790	Stone Trap Hinge Replaces AH219193	AMAH227675	\$ 114.20	
 9610 ASN 680301, 9650, 9660	Feederhouse Plate Assembly, Wide	AMAH160605	\$ 210.21	
 9650STS, 9660STS, 9670STS, 9750STS, 9760STS, 9770STS, 9860STS, 9870STS, S650 ASN 765000, (S660, S670, S690 ASN 745100), S670HM BSN 765000, S680 ASN 745100, S680HM BSN 765000, S690HM SN 745101-765000	Feederhouse Plate	AMAH156157	\$ 245.00	
 9560STS, 9570STS, 9650STS, 9660STS, 9750STS, 9760STS, 9770STS, 9860STS, 9870STS, 9880STS, S660, S670, S680	Feederhouse Floor Plate	AMAH154691	\$ 475.00	
 9400 SN 635243-640100, (9500, 9550, 9650CTS - Rice), CTS	Front Wear Plate	AMH143456	\$ 87.00	
 9400 ASN 640101, 9410, 9450, 9500, 9510, 9550, CTS, CTS II SN 675101-679050	Front Wear Plate	AMH144052	\$ 75.00	
 9600 S/N 635520-640300	Front Wear Plate	AMH143455	\$ 85.00	
 9600 ASN 640301, 9610, 9650	Front Wear Plate	AMH144051	\$ 112.00	
9400, 9410, 9450, 9500, 9500SH, 9510, 9510SH, 9550, 9550SH, 9560, 9560SH, 9560STS, 9570STS, 9600, 9610, 9650, 9650CTS, 9650STS, 9660, 9660CTS, 9660STS, 9670STS, 9750STS, 9760STS, 9770STS, 9780CTS, 9860STS, 9870STS, C670, CTS, CTS II, T550, T560, T660, T670	Feederhouse Wear Plate, Right Hand Lower	AMH149460	\$ 42.62	
	Feederhouse Wear Plate, Left Hand Lower	AMH149459	\$ 42.62	
9400, 9410, 9450, 9500, 9500SH, 9510, 9510SH, 9550, 9550SH, 9560, 9560SH, 9560STS, 9570STS, 9600, 9610, 9650, 9650CTS, 9660, 9660CTS, 9660STS, 9670STS, 9750STS, 9770STS, 9860STS, 9870STS, C670, CTS, CTS II, S550 SN 745100-764999, S650 ASN 765000, (S660, S670, S680, S690 ASN 745100), (S670HM, S680HM BSN 765000), S690HM SN 745101-765000, S760, S770, S780, S785, S790, T550, T560, T660, T670	Feederhouse Wear Plate, Top	AMH149461	\$ 30.43	
 9660STS, 9670STS, 9760STS, 9770STS, 9860STS, 9870STS, S650 ASN 765000, (S660, S670, S680, S690 ASN 745100)	Feederhouse Wear Plate, Front	AMH219091	\$ 89.00	
 9560, 9560STS, 9660CTS, 9660STS	Wear Plate Heavier Gauge than OEM	AMH171372	\$ 67.00	
 9650STS, 9750STS - w/ Contour-Master™	Feederhouse Wear Plate, Front	AMH157112	\$ 100.00	
 9650STS, 9660STS, 9670STS, 9750STS, 9760STS, 9770STS, 9860STS, 9870STS, S660, S670, S670HM, S680, S680HM, S690, S690HM	Isolator Seal, Feederhouse Door	AMH220556	\$ 30.00	
 9610, 9650, 9660	Feed Plate Hinge Assembly, Wide	AMAH162292	\$ 205.82	
9600 ASN 642300, 9610, 9650, 9660	Front Feederhouse Support Channel	AMH143357	\$ 86.05	
9600 ASN 642301, 9610, 9650, 9660	Rear Feederhouse Support Assembly	AMAH141860	\$ 168.10	
9400 ASN 640505, 9410, 9450, 9500 ASN 642578, 9510, 9550, 9550SH, 9560, 9560SH, 9650CTS, 9660CTS, CTS, CTS II	Feederhouse Stripper Plate	AMH145464	\$ 50.00	

John Deere®—Combine

	Application	Description	Part Number	Retail Price	Core
	9400 ASN 650101, 9410, 9450 BSN 685178, (9500, 9500SH ASN 650201), 9510, 9510SH, 9550 BSN 685741, 9550SH ASN 685703, 9600, 9610, 9650 ASN 686075, 9650CTS BSN 685496, 9650STS BSN 685804, 9750STS BSN 685840, CTS ASN 650401, CTS II	Wear Strip, Upper Return	AMH148187	\$ 9.75	
	9450 ASN 685178, 9550 ASN 685741, 9550SH ASN 685704, 9560, 9560SH, 9560STS, 9570STS, 9650 ASN 686075, 9650CTS ASN 685496, 9650STS ASN 685804, 9660, 9660CTS, 9660STS, 9670STS, 9750STS ASN 685841, 9760STS, 9770STS, 9860STS, 9870STS, S550, S650, S660, S670, S670HM, S680, S680HM, S690, S690HM, S760, S770, S770HM, S780, S780HM, S785, S785HM, S790, S790HM	Wear Strip, Upper Return	AMH171960	\$ 8.00	
	4400, 4420, 6600, 6620, 7700, 7720, 8820	Poly Chain Guide	AMX27158	\$ 53.25	
	9400, 9410, 9500, 9510, 9600, 9610	Poly Chain Guide	AMX27157	\$ 53.25	
	6620, 7720, 8820	Feederhouse Pivot Arm, Idler	AMAH93333	\$ 61.63	
	9400, 9410, 9450, 9500, 9501, 9510, 9510SH, 9550, 9550SH, 9560, 9560STS, 9570STS, 9600, 9610, 9650, 9650CTS, 9660, 9660STS, 9670STS, 9750STS, 9760STS, 9770STS, 9860STS, 9870STS, CTS, CTS II, S550 SN 745100-764999, S650 SN 765000-785000, (S660, S670, S680, S690 ASN 745100), (S670HM, S680HM BSN 765000), S690HM SN 745101-765000, S760, S770, S780, S785, S790	Feederhouse Shaft Replaces HXE31772	AMAH125454	\$ 147.34	
	9400 BSN 641500, 9500 BSN 643900, 9600 BSN 645300, CTS, CTS II	Upper Stub Shaft, Right Hand 9.97" Long	AMH129681	\$ 270.05	
	9400 BSN 641500, 9500 BSN 643900, 9600 BSN 645300	Upper Stub Shaft, Left Hand 2.93" Long	AMH129658	\$ 139.27	
	6620, 7720, 8820	Idler Arm For Feederhouse Drive	AMAH97338	\$ 137.07	
	9550, 9550SH, 9560, 9560SH, 9560STS, 9570STS, 9650, 9650CTS, 9650STS, 9660, 9660CTS, 9660STS, 9670STS, 9760STS, 9770STS, 9780CTS ASN 072800, 9870STS, C670, CTS, S550 SN 745100-764999, (S650, S660, S670, S680, S690 ASN 745100), (S670HM, S680HM BSN 765000), S690HM SN 745101-765000, S760, S770, S780, S785, S790, T550, T560, T660, T670, Cotton Pickers: 7260, 7660, 7760, CP690	Idler Pulley, Feed Accelerator Replaces AH166439	AMAH204389	\$ 58.23	
	9400, 9410, 9500, 9500SH, 9510, 9510SH, 9550, 9550SH, 9560, 9560SH, 9560STS, 9570STS, 9600, 9610, 9650, 9650CTS, 9650STS, 9660, 9660CTS, 9660STS, 9670STS, 9760STS, 9770STS, 9860STS, CTS, CTS II, S550, S660, S670, S680, S690	Variable Speed Idler Support	AMAH167579	\$ 214.00	
	6620, 7720, 8820, 9400, 9410, 9450 BSN 695101, 9500, 9500SH, 9510, 9510SH, 9550 BSN 695201, 9550SH BSN 695701, 9560STS, 9600, 9610, 9650 BSN 695301, 9650CTS BSN 695401, 9650STS BSN 695501, 9660, 9750STS BSN 695601, CTS, CTS II	Hydraulic Cylinder	AMAH211577	\$ 256.00	

John Deere®—Combine

Application	Description	Part Number	Retail Price	Core
 Cornheads: 443, 444, 493, 494, 543, 546, 592, 594, 642, 643, 644, 645, 693, 694, 842, 843, 844, 893, 894, 1092, 1293, 1294	Bearing and Support Kit	AMX27553	\$ 155.00	
 9450, 9550, 9550SH, 9560, 9560SH, 9560STS, 9570STS, 9650, 9650CTS, 9650STS, 9660, 9660CTS, 9660STS, 9670STS, 9750STS, 9760STS, 9770STS, 9870STS, S550, S650, S660, S670, S670HM, S680, S680HM, S690, S690HM, S760, S770, S780, S785, S790	Feederhouse Idler Arm	AMAH168397	\$ 126.42	
 6620, 7720, 7722, 8820, 9400, 9410, 9450, 9500, 9501, 9510, 9550, 9560, 9560STS, 9600, 9610, 9650, 9650CTS, 9660, 9660CTS, CTS, CTS II	Feederhouse Slip Clutch Hub	AMH105590	\$ 73.00	
 6620, 6622, 7720, 8820, 9400, 9410, 9450, 9500, 9500SH, 9501, 9510, 9510SH, 9550, 9550SH, 9560, 9560SH, 9560STS, 9600, 9610, 9650, 9650CTS, 9660, 9660CTS, CTS, CTS II	Slip Clutch Jaw	AMH101677	\$ 29.25	
6620, 7720, 8820	Feederhouse Pulley Support	AMAH96092	\$ 271.06	
9400, 9410, 9450, 9500, 9500SH, 9501, 9510, 9510SH, 9550, 9550SH, 9560, 9560SH, 9600, 9610, 9650, 9650CTS, 9660, 9660CTS, 9780CTS ASN 070362, C670, CTS, CTS II, T550, T560, T660, T670	Pulley 4-Groove, 9.46" OD Dual Range Cylinder Drive	AMH125391	\$ 267.43	
9400, 9450, 9500, 9550, 9550SH, 9560, 9560SH, 9600, 9650, 9650CTS, 9660, 9660CTS	Feederhouse Pulley, Dust Fan For Airflow Retrofit Installation 1.95" Wide, 1.336" ID, 5.88" OD	AMAH155706	\$ 58.94	
9560, 9560STS, 9570STS, 9660, 9660STS, 9670STS, 9760STS, 9770STS, S550, S660 SN 745000-764999	Pulley, Fixed Speed 2.128" ID, 11.50" OD	AMAH206934	\$ 275.15	
 6620, 7720, 8820, 9400, 9410, 9450, 9500, 9510, 9510SH, 9550SH, 9560, 9560SH, 9560STS, 9570STS, 9600, 9610, 9650, 9650CTS, 9650STS, 9660, 9660CTS, 9660STS, 9670STS, 9750STS, 9760STS, 9770STS, 9860STS, S550 SN 745100-764999, S650 ASN 765000, (S660, S670 ASN 745100), S680 SN 766007-785000, S690 SN 765250-785000	Inner Hub For Feederhouse Pulley	AMH97378	\$ 104.16	
 6620, 7720, 8820, 9400, 9410, 9450 BSN 390218, 9500, 9500SH, 9510, 9510SH, 9550 BSN 690801, 9600, 9610, 9650 BSN 690821, 9650CTS BSN 690490, 9650STS BSN 691932, 9750STS BSN 691384, CTS, CTS II - w/ Standard Capacity	Feederhouse Sheave Half, Inner 12.50" OD Replaces H93189, H108673	AMH168126	\$ 350.00	
 9450 ASN 690217, 9550 ASN 690800, 9560, 9560SH, 9560STS, 9570STS, (9600, 9610 - w/ AH153339 Gearbox), 9650 ASN 690820, 9650CTS ASN 690489, 9650STS ASN 691931, 9660, 9660CTS, 9660STS, 9670STS, 9760STS, 9770STS - w/ Standard Capacity	Feederhouse Sheave Half, Inner 12.524" OD	AMH201579	\$ 321.01	
 9560, 9560STS, 9570STS, 9660, 9660CTS, 9660STS, 9670STS, 9760STS, 9770STS, 9860STS BSN 715600, S550 SN 745100-764999, S650 ASN 765000, S660 ASN 745100	Feederhouse Sheave Half, Inner 2.127" ID, 14.168" OD	AMH216332	\$ 392.00	
 9560, 9560STS, 9570STS, 9660, 9660CTS, 9660STS, 9670STS, 9760STS, 9770STS, 9860STS BSN 715600, S550 SN 745100-764999, S650 ASN 765000, (S660 S670 ASN 745100), S680 SN 766007-785000, S690 SN 765250-785000	Variable Speed Sheave	AMAH204591	\$ 527.00	

John Deere®—Combine

Application	Description	Part Number	Retail Price	Core
 9660, 9660STS, 9670STS, 9760STS, 9770STS, 9860STS, 9870STS, S650 SN 765000-785000, (S660, S670 ASN 745100), (S680, S690 SN 745100-785000), S760, S770	Variable Speed Sheave	AMH217454	\$ 600.00	
 9770STS, 9870STS	Idler Pulley, Multi-Speed Feederhouse Drive 1.437" Overall Width, 7.992" Diameter, 0.637" Bore Diameter, 1" Groove Width Replaces AH85276, AH165366	AMAH97031	\$ 32.73	
 9560STS, 9660, 9660CTS, 9660STS, 9760STS, 9860STS	Feederhouse Drive Sprocket Double Sprocket, 22 & 26 Tooth, 21 Internal Spline	AMAH203076	\$ 188.31	
(9560STS, 9660, 9660CTS, 9660STS, 9760STS - High-Capacity), 9860STS High Speed	Feederhouse Drive Sprocket Double Sprocket, 26 & 38 Tooth, 21 Internal Spline	AMAH218403	\$ 343.81	
 9650, 9650STS, 9660STS, 9750STS, 9760STS, 9860STS	Feederhouse Drive Sprocket, Upper 34 Tooth, 8.54" Diameter, 2.63" Bore Diameter	AMH119709	\$ 58.00	
 9570STS, 9670STS, 9770STS, 9870STS	Feederhouse Sprocket 34 Tooth	AMH219634	\$ 60.66	
 9400, 9410, 9500, 9501, 9510, 9600, 9610, CTS, CTS II	Sprocket Assembly Front Driveshaft w/ Reverser 60 Chain, 15 & 22 Tooth	AMAH125782	\$ 75.00	
 9400, 9410, 9450, 9500, 9501, 9510, 9550, 9560, 9560STS, 9600, 9610, 9650, 9650CTS, 9660, 9660CTS, CTS, CTS II	Sprocket, Slip Clutch 34 Tooth, 1.752" Bore Diameter, 0.78" Thick For 60 Chain	AMAH116232	\$ 65.00	
 9400, 9410, 9450, 9500, 9500SH, 9501, 9510, 9510SH, 9550, 9550SH, 9560, 9560SH, 9560STS, 9600, 9610, 9650, 9650CTS, 9650STS, 9660, 9660CTS, 9660STS, 9750STS, 9760STS, 9860STS, CTS, CTS II	Cam, Left Hand Shoe Drive Inner, 6 mm Keyway, 1.38" ID	AMH234550	\$ 71.00	
 9400, 9410, 9450, 9500, 9500SH, 9510, 9550, 9550SH, 9560, 9560SH, 9560STS, 9570STS, 9600, 9610, 9650, 9650CTS, 9650STS, 9660, 9660CTS, 9660STS, 9750STS, 9760STS, 9770STS, 9860STS, 9870STS, CTS, CTS II	Bearing Housing	AMH147593	\$ 65.00	
 9600, 9610	Stone Trap Hinge	AMH148020	\$ 93.26	
 9400, 9410, 9450, 9500, 9501, 9510, 9510SH, 9550, 9550SH, 9650, 9650STS, 9750STS, CTS, CTS II SN 675101-679050	Feederhouse Seal Replaces H170737, H169170, H131452	AMH173904	\$ 53.00	
 9600, 9610, 9650	Feederhouse Seal	AMH173903	\$ 60.00	
 6620, 7720, 8820, 9400, 9410, 9450 BSN 695100, 9500, 9500SH, 9510, 9510SH, 9550 BSN 695200, 9550SH BSN 695700, 9560, 9560SH, 9560STS, 9570STS, 9600, 9610, 9650 BSN 695300, (9650CTS, 9650STS BSN 695400), 9660, 9660CTS, 9660STS, 9670STS, 9750STS BSN 695600, 9760STS, 9770STS, 9860STS, 9870STS, CTS, CTS II	Ball Bearing	AMJD10018	\$ 24.89	
9400, 9410, 9500, 9510, 9600, 9610, CTS, CTS II	Feederhouse Drive Tightener Arm	AMAH128903	\$ 79.46	

John Deere®—Combine

	Application	Description	Part Number	Retail Price	Core
	9400, 9410, 9450, 9500, 9500SH, 9510, 9510SH, 9550, 9550SH, 9560, 9560SH, 9560STS, 9610, 9650, 9650CTS, 9650STS, 9660, 9660CTS, 9660STS, 9750STS, 9760STS, 9770STS, 9860STS, 9870STS, CTS, CTS II	Bushing, Feederhouse Drive Tightener 1.005" ID, 1.128" OD, 1" Wide	AMH171061	\$ 5.00	
	9400, 9410, 9450, 9500, 9510, 9550, 9550SH, 9560, 9600, 9610, 9650, 9650CTS, 9660, 9660CTS, CTS, CTS II - w/ existing Feederhouse Airflow or for use w/ Feederhouse Airflow	Return Floor Runner	AMAH157942	\$ 236.89	
	9400 BSN 641501, 9500 BSN 643901, 9600 BSN 645301	Bearing, Feederhouse Slip Clutch Tapered Roller Bearing 1.456" Wide, 2.677" OD, 1.535" Bore	AMAH109788	\$ 54.59	
	(4400, 4420 - Long), (6600, 7700 - Regular), 6620 BSN 502551, 7720 BSN 507351	Roller Chain, Feederhouse Drive 228 Links, Size 50 Chain	AMAH104375	\$ 52.00	
	6620 ASN 502551, 7720 ASN 507351, 8820 Regular	Roller Chain, Feederhouse Drive 228 Links, Size 50 Chain	AMAH104868	\$ 60.00	
	9400, 9410, 9500, 9510, 9600, 9610, CTS II	Roller Chain, Feederhouse Drive 219 Links, Size 60 Chain	AMAH145029	\$ 80.00	
	9450, 9550, 9650, 9650CTS, CTS, CTS II	Roller Chain, Feederhouse Drive 223 Links, Size 60 Chain	AMAH205015	\$ 80.00	
	9500SH, 9510SH, 9550SH	Roller Chain, Feederhouse Drive 229 Links, Size 60 Chain	AMAH135693	\$ 60.00	
	9560STS, 9570STS, 9660STS, 9670STS, 9760STS, 9770STS, 9860STS, 9870STS	Roller Chain, Feederhouse Drive Hi-Speed, 192 Links, Size 60 Chain	AMAH206701	\$ 85.00	
	(9560STS, 9570STS, 9660STS, 9670STS, 9760STS, 9770STS, 9860STS, 9870STS BSN 735100)	Roller Chain, Feederhouse Drive 187 Links, Size 60 Chain	AMAH206862	\$ 76.00	
	(9570STS, 9670STS, 9770STS, 9870STS, S550, S560, S660, S670, S680, S690, S760, S770, S780, S790 ASN 735101)	Roller Chain, Feederhouse Drive 189 Links, Size 60H Chain Replaces AXE80366, AXE72709	AMAH232566	\$ 80.00	
	9650STS, 9750STS	Roller Chain, Feederhouse Drive 195 Links, Size 60 Chain	AMAH205013	\$ 76.00	
	S660, S670, S680, S690, S760, S770, S780, S790	Roller Chain, Feederhouse Drive 181 Links, Size 60H Chain For Hydraulic Fore/Aft Tilt	AMAXE28813	\$ 76.00	
	9500SH, 9510SH, 9550SH	Roller Chain, Lower Feederhouse Drive Shaft 54 Links, Size 60 Chain	AMAH135694	\$ 25.00	

Feed Reverser Assemblies and Components



Application	Description	Part Number	Retail Price	Core
6620	Reman Feed Reverser Assembly	AMAH120068-R	\$ 2100.00	\$ 250.00
7720, 7722, 9400, 9500	Reman Feed Reverser Assembly	AMAH134864-R	\$ 2888.00	\$ 250.00

John Deere®—Combine

Application	Description	Part Number	Retail Price	Core
9550, 9550SH, 9650CTS, 9650STS, 9750STS ASN 700301	Reman Feed Reverser Assembly High Capacity	AMAH204839-R	\$ 3045.00	\$ 500.00
9550 BSN 700200, 9650CTS BSN 700400 High-Capacity, 9650STS BSN 700500, 9750STS BSN 700600	Reman Feed Reverser Assembly 67 1/2" Long	AMAH159170-R	\$ 3150.00	\$ 250.00
8820, 9600	Reman Feed Reverser Assembly	AMAH134863-R	\$ 2888.00	\$ 250.00
9610	Reman Feed Reverser Assembly	AMAH156052-R	\$ 2888.00	\$ 250.00
9650 High-Capacity BSN 700300	Reman Feed Reverser Assembly 78 1/2" Long	AMAH159171-R	\$ 3150.00	\$ 250.00
(9600, 9610 - w/ Contour-Master™), 9650 BSN 700300 w/ Standard Gearbox	Reman Feed Reverser Assembly	AMAH153339-R	\$ 3150.00	\$ 250.00
9770STS, 9870STS	Reman Feed Reverser Assembly High Torque Replaces DE20076	AMDE20517	\$ 4200.00	\$ 500.00
9670STS, 9770STS, S650 ASN 765000, S660 ASN 745100	Reverser, Standard Duty Replaces AH204585, AH204589	AMAH225336	\$ 3250.00	\$ 250.00
6620, 6622, 7700, 7722, 8820, 9400, 9410, 9450, 9500, 9501, 9510, 9550, 9600, 9610, 9650, 9650CTS, CTS, CTS II	Reverser Gearbox Gear	AMH106073	\$ 110.00	
6620, 7720 BSN 626800, 8820 BSN 626300, 9400, 9410, 9450* BSN 700100, 9500, 9510, 9510SH, (9550*, 9550SH* BSN 700200), 9560SH*, 9600, 9610, 9650* BSN 700300, 9650CTS* BSN 700400, 9650STS* BSN 700500, 9750STS* BSN 700600, CTS, CTS II *w/ Standard Gearbox	Shift Collar, Reverser Gearbox 10 Spline, 3.23" Diameter Replaces H98905	AMH132328	\$ 135.00	
6620 ASN 610731, 6622 ASN 507051, 7720 ASN 612194, 7722, 8820 ASN 404351, 9400, 9410, 9450 BSN 700100, 9500, 9501, 9510, 9510SH, (9550, 9550SH BSN 700200), 9560, 9560SH, 9600, 9610, 9650 BSN 700300, 9650CTS BSN 700400, 9650STS BSN 700500, 9750STS BSN 700600, CTS, CTS II	Reverser Ring Gear 73 Tooth	AMAH105040	\$ 265.00	
6620, 6620SH, 6622, 9400, 9410, 9450, 9500, 9500SH, 9510, 9510SH, 9550, 9550SH, 9600, 9610, 9650, 9650CTS, 9650STS, 9750STS, CTS, CTS II	Planetary Input Gear w/ Oil Lube Spots	AMH166216	\$ 163.00	
9400*, 9410*, 9450 SN 690218-700100, 9500*, 9500SH*, 9510*, 9550 SN 690800-700200, 9550SH SN 690720-700200, 9560SH, 9600**, 9610**, 9650 SN 690821-700300, 9650CTS SN 690490-700400, 9650STS SN 691932-700500, 9750STS SN 691384-700600, CTS*, CTS II* *w/ AH153341 Gearbox **w/ AH153339 Gearbox	Planetary Input Gear	AMH201578	\$ 188.00	
6620, 6620SH, 6622, 7720, 7722 HillSide, 8820, 9400, 9410, 9450, 9500, 9500SH, 9510, 9510SH, 9550, 9560SH, 9600, 9610, 9650, 9650CTS, 9650STS, 9750STS, CTS, CTS II	Planetary Gear (3) Required	AMH168994	\$ 102.00	
	Planetary Pin (3) Required	AMR33079	\$ 10.00	
9450, (9550, 9550SH - High Capacity or Standard Capacity ASN 700200), 9560, 9560STS, 9570STS, 9650 High Capacity or Standard Capacity ASN 700300, 9650CTS High Capacity or Standard Capacity ASN 700400, 9650STS High Capacity or Standard Capacity ASN 700500, 9660, 9660CTS, 9660STS, 9670STS, 9750STS, 9760STS, 9770STS, 9860STS, 9870STS w/o Pump	Planetary Pin 3.071" Long, 0.814" Diameter	AMZ61813	\$ 46.95	
9450 ASN 700100, 9550 w/ High Capacity or ASN 700200 w/ Standard Capacity, 9560, 9560STS, 9570STS, 9650 w/ High Capacity or ASN 700300 w/ Standard Capacity, 9650CTS ASN 700400, 9650STS w/ High Capacity or ASN 700500 w/ Standard Capacity, 9660, 9660CTS, 9660STS, 9670STS, 9750STS w/ High Capacity or ASN 700600 w/ Standard Capacity, 9760STS, 9770STS, 9860STS, S550, S650 ASN 785000 or SN 765000-785000 w/ Heavy Duty Variable, S660 ASN 765172 w/ Heavy Duty Variable Speed, S760 w/ Heavy Duty Variable Speed Only	Planetary Pinion Gear 14 Tooth Gear, 24 Tooth Sprocket, 3.071" Height, 0.814" Pin Diameter	AMZ12714	\$ 235.00	
9660, 9660STS, 9670STS, 9760STS, 9770STS ASN 730100, 9860STS, 9870STS, S650, S660, S670, S670HM, S680, S680HM, S690, S690HM, S760, S770, S780, S785, S790	Planetary Gear 14 Tooth, 29 Tooth Sprocket (3) Required	AMCE18522	\$ 225.00	
6620, 9400, 9410, 9450, 9500, 9510, 9550, 9560, 9600, 9610, 9650, 9650CTS, 9650STS	Reverser Pinion Carrier	AMH168125	\$ 750.00	

John Deere®—Combine

Application	Description	Part Number	Retail Price	Core
6620, 7720, 8820, 9400, 9410, 9450 BSN 700101, 9500, 9500SH, 9510, 9510SH, (9550, 9550SH BSN 700201), 9560, 9600, 9610, 9650 BSN 700301, 9650CTS BSN 700401, 9650STS BSN 700501, 9750STS BSN 700601	Ball Bearing	AMJD10010	\$ 40.35	
9450 ASN 700100, 9550, 9560, 9650, 9650CTS, 9650STS, 9660, 9660CTS, 9660STS, 9750STS, 9760STS, 9770STS, 9860STS BSN 715601 w/ Fixed Reverser, S650, S660, S760	Feed Reverser Gearbox Shaft, Standard 18.18" Long, 24 & 21 Spline	AMH177985	\$ 339.40	
9560STS, 9570STS, S550	Feed Reverser Gearbox Shaft 23.48" Long, 24 & 21 Spline	AMH202929	\$ 878.65	
(9660, 9660STS, 9760STS, 9860STS - w/ Variable Speed Drive), (9670STS, 9770STS BSN 730101), (9870STS BSN 730101 w/ High Torque Variable Drive Conversion Only), (S660, S670, S680, S690 BSN 785001 - w/ High Torque Variable Drive Conversion Only)	Feed Reverser Gearbox Shaft 18.18" Long, 24 & 21 Spline	AMH213514	\$ 630.40	
6620, 7720, 8820, 9400, 9450 BSN 700101, 9500, 9500SH, (9550, 9550SH BSN 700201), 9560, 9560SH, 9600, 9610, 9650 BSN 700301, 9650CTS BSN 700401, 9650STS BSN 700501, 9750STS BSN 700601, CTS, CTS II	Ball Bearing, Feed Reverser Gearbox	AMJD10011	\$ 34.97	
8820, 9600, 9610	Lower Feederhouse Shaft 91.44" Long	AMAH97643	\$ 383.00	
(9400 ASN 660100, 9410 BSN 680232, 9450 BSN 700101, 9500, 9510, 9550 BSN 700201 - w/ Contour-Master™), 9650CTS BSN 700401, 9650STS BSN 700501, 9750STS BSN 700601, CTS, CTS II	Lower Feederhouse Shaft 83.69" Long	AMAH152937	\$ 352.00	
9400 ASN 660101, 9410 BSN 680231, 9500, 9510, CTS ASN 660401, CTS II - w/ Contour-Master™	Lower Feederhouse Shaft 83.62" Long	AMAH136873	\$ 970.70	
9450 ASN 700100, 9550 ASN 700200, 9550SH ASN 700200 w/ Standard Reverser, 9560, 9560SH, 9650CTS ASN 700400, 9650STS ASN 700500 w/ Standard or High Capacity Reverser, 9660CTS, 9660STS, (9670STS, 9770STS BSN 730100 w/ High Torque and Variable High Torque Drive or BSN 735100 w/ Fixed Reverser and Variable Drive), 9750STS w/ Standard Reverser or ASN 700600 w/ High Capacity Reverser, 9760STS, 9860STS, 9870STS BSN 730100	Lower Feederhouse Shaft 70.81" Long Replaces H234410, H234555	AMH202940	\$ 404.64	
9670STS SN 730101-735100, (9770STS w/ Standard Multi-Speed Drive or SN 730101-735100 w/ High Torque Multi-Speed Drive), (9870STS w/ Multi-Speed Drive or SN 730101-735100 w/ Fixed Reverser)	Lower Feederhouse Shaft 70.81" Long Replaces H234556	AMH224011	\$ 422.80	
9550, 9650, 9650CTS, 9650STS, 9750STS - w/ High Capacity	Feederhouse Sheave, Inner 2.128" ID, 12.524" OD	AMH158575	\$ 297.50	
9600, 9610, 9650 BSN 700300	Front Shaft, Variable Drive Sheave 94.50" Long	AMAH152939	\$ 738.00	
9560, 9560SH, 9560STS, 9570STS, 9660, 9660CTS, 9660STS, 9670STS, 9760STS, 9770STS, 9780CTS ASN 074502, 9860STS, C670, S550 SN 745100-764999, S650 SN 765000-785000, S660 ASN 745100, S670 SN 105000-109999, S760, T550, T560, T660, T670	Feederhouse Input Gear 21 Tooth, 7.06" Long	AMH207015	\$ 246.00	
9400, 9410, 9450, 9500, 9510, 9510SH, (9550, 9550SH, 9560, 9560SH, 9560STS, 9570STS, 9650, 9650CTS, 9660, 9660CTS, 9660STS, 9670STS, 9760STS, 9770STS - w/ Standard Capacity), 9600, 9610, 9650STS, CTS, CTS II	Pulley Assembly, Variable Speed 4.878" ID, 12.508" OD For Outer Half Sheave Replaces, H97329, H107735, AH15793	AMAH201417	\$ 204.00	
9550, 9650CTS, 9650STS, 9750STS	Pulley Assembly, Variable Speed High Capacity 4.878" ID, 12.51" OD For Outer Half Sheave	AMAH201415	\$ 195.00	
9660STS, 9670STS, 9760STS, 9770STS, 9860STS, 9870STS, S650 SN 765000-785000, (S660, S670 ASN 745100), (S680, S690 SN 745100-785000)	Half Sheave High Torque	AMAH219367	\$ 600.00	
(9560, 9560STS, 9570STS, 9660, 9660CTS, 9660STS, 9760STS - w/ High Capacity), 9860STS BSN 715601	Half Sheave, Variable Speed 4.878" ID, 14.17" OD Replaces AH201889	AMAH204587	\$ 345.00	
9450 ASN 700101, 9550, 9560, 9560STS, 9570STS, 9650, 9650CTS, 9650STS BSN 700500, 9660, 9660CTS, 9660STS, 9670STS, 9750STS BSN 700600, 9760STS, 9770STS, 9860STS, C670, S550 SN 745100-764999, S650 ASN 765000, S660 ASN 745100, T550, T560, T660, T670	Gear 40 Tooth	AMH170781	\$ 545.00	

Prices Subject to Change without Prior Notice. The use of original equipment manufacturer (OEM) part numbers or trademarks, e.g. Case® and John Deere®, are for reference purposes only and for indicating product use and compatibility. Our company and the listed replacement parts contained herein are not sponsored, approved or manufactured by the OEM. All parts are New unless designated Reman in the description.

John Deere®—Combine

Application	Description	Part Number	Retail Price	Core
6620, 7720, 8820, 9400, 9410, 9450 BSN 700101, 9500, 9500SH, 9510, 9510SH, (9550, 9550SH BSN 700201), 9650 BSN 700301, 9650CTS BSN 700401, 9650STS BSN 700501, 9750STS BSN 700601	Needle Bearing, Feed Reverser/Feed Roll Gearbox	AMJD8819	\$ 11.81	
8820, 9600, 9610	Coupler Sprocket 14 Tooth 2.697" Long, 1.172" Bore Diameter For Size 60 Chain	AMAH96938	\$ 37.00	

Cylinder Bars and Components

All bars are carefully checked and sets are matched for equal weight distribution on the cylinder prior to shipment. Grade 8 fasteners are supplied for most models.



Application	Description	Part Number	Retail Price	Core
105	Cylinder Bar Kit	AMAH65107	\$ 368.47	
4400, 4420	Cylinder Bar Kit	AMAH75125	\$ 543.44	
4425, 4435	Cylinder Bar Kit	AMOJD-4425	\$ 533.51	
6600, 6601, 6602, 6620, 6620 Titan II, 6622, 6622 Titan II	Cylinder Bar Kit	Hardened AMAH75104	\$ 619.00	
		Chrome AMAH126545	\$ 763.00	
7700, 7701, 7720, 7720 Titan II, 7721	Cylinder Bar Kit	Hardened AMAH132976	\$ 604.67	
		Chrome AMAH132978	\$ 799.00	
8820, 8820 Titan II	Cylinder Bar Kit	Standard AMOJD-8820	\$ 648.06	
		Hardened AMAH132980	\$ 809.00	
		Chrome AMAH132982	\$ 1035.40	
9400, 9500, 9450, 9550, 9410, 9510, 9650CTS, CTS, CTS II - 2 Rows of Holes	Cylinder Bar Kit	Hardened AMAH139432	\$ 808.75	
		Chrome AMAH134144	\$ 1008.00	
9400, 9410, 9450, 9500, 9510, 9550, 9560, 9650CTS, 9660CTS, CTS, CTS II - 1 Row of Holes	Cylinder Bar Kit	Hardened AMAH205118	\$ 636.69	
		Chrome AMAH205120	\$ 834.40	
9600, 9610, 9650, 9660 - 2 Rows of Holes	Cylinder Bar Kit	Hardened AMAH139430	\$ 940.98	
		Chrome AMAH134142	\$ 1234.04	
9600, 9610, 9650, 9660 - 1 Row of Holes	Cylinder Bar Kit	Hardened AMAH161398	\$ 765.52	
		Chrome AMAH161390	\$ 1000.67	
7700, 7720 BSN 556301	Cylinder Drive Shaft 3 Spline, 65.31" Long	AMH79642	\$ 499.56	
7720 ASN 556301	Cylinder Drive Shaft 29 Tooth, 67.81" Long	AMH110458	\$ 679.90	
7720 ASN 610501	Cylinder Drive Shaft 3 Spline, 65.37" Long	AMH123134	\$ 393.80	
9400, 9410, 9450, 9500, 9500SH, 9510, 9510SH, 9550, 9550SH, 9560, 9560SH, 9650CTS, 9660CTS, CTS, CTS II	Cylinder Filler Plate, Perforated Replaces H150837	AMH150837	\$ 120.00	
9600, 9610, 9650, 9660	Cylinder Filler Plate, Perforated Replaces H150836	AMH150836	\$ 117.00	
9400, 9410, 9450, 9500SH, 9510SH, 9550, 9550SH, 9560, 9560SH, 9650CTS, 9660CTS	Threshing Cylinder Shaft, Dual Range 69.50" Long	AMH140043	\$ 717.77	
9600, 9610, 9650, 9660	Threshing Cylinder Shaft, Dual Range 80.31" Long	AMH140042	\$ 841.64	
9400, 9500, 9510, 9510SH, 9550, 9550SH, 9560, 9560SH, 9650CTS, 9660CTS, CTS, CTS II ASN 655541	Threshing Cylinder Shaft, Single Range 67" Long Replaces H127972	AMH145970	\$ 724.70	









John Deere®—Combine













Rotor Assemblies

Application	Description	Part Number	Retail Price	Core
9650STS, 9660STS, 9670STS, 9750STS, 9760STS, 9770STS, 9860STS, 9870STS, S650, S660, S670, S670HM, S680, S680HM, S690, S690HM	Reman STS Bullet Rotor For Grain & Corn Additional elements and tines required for Rice	AMAXE24832	\$ 7075.00	\$ 500.00



Rotor Components

	Application	Description	Part Number	Retail Price	Core
	9650STS, 9660STS, 9750STS, 9760STS, 9860STS	Front Rotor Flight, Set of 3	AMAH204533	\$ 270.00	
	9650STS, 9660STS, 9750STS, 9760STS, 9860STS	Rear Rotor Flight, Set of 3	AMAH204534	\$ 270.00	
	9660STS, 9670STS, 9760STS, 9770STS, 9860STS, 9870STS, S660, S670, S680, S690, S760, S770, S780, S790	Threshing Element, Set of 3 High Wear, Tungsten Carbide Coated Bullet Rotor 3rd, 4th, 5th Rows, Marked H215532 For Bullet™ or TriStream™ Rotors	AMAH216678	\$ 255.00	
	9650STS, 9660STS, 9670STS, 9750STS, 9760STS, 9770STS, 9860STS, 9870STS, S650, S660, S670, S670HM, S680, S680HM, S690, S690HM, S760, S770, S780, S790	Threshing Element, Set of 3 Tungsten Carbide Coated Bullet Rotor 2nd Row, Marked H212563 For Bullet™ or TriStream™ Rotors for Corn and Grain	AMAH216675	\$ 367.00	
	9650STS, 9660STS, 9750STS, 9760STS BSN 712197, 9860STS BSN 000724	Threshing Element, Set of 3 Standard Rotor, Marked H173240 (5) Sets Required for Corn and Grain (9) Sets Required for Rice	AMAH167739	\$ 143.00	
	9650STS, 9660STS, 9670STS, 9750STS, 9760STS, 9770STS, 9860STS, 9870STS, S650, S660, S670, S670HM, S680, S680HM, S690, S690HM, S760, S770, S780, S790	Threshing Element, Set of 3 High Wear, Tungsten Carbide Coated Bullet Rotor 1st Row, Marked H212563 For Bullet™ or TriStream™ Rotors for Corn and Grain	AMAH216674	\$ 570.00	
	9660STS, 9670STS, 9760STS, 9770STS, 9860STS, 9870STS, S650, S660, S670, S670HM, S680, S680HM, S690, S690HM	Threshing Element, Ribbed, Set of 3 Marked H205999 Bullet Rotor 3rd, 4th, 5th Rows	AMAH216677	\$ 173.00	
	(9660STS, 9760STS BSN 712198), 9860STS BSN 000724	Threshing Element, Set of 3 Standard Rotor, 2-Piece Smooth High Wear, Chrome Plated, Hardened	AMAH209118	\$ 220.94	
	9560STS, 9660STS, 9670STS, 9750STS, 9760STS, 9770STS, 9860STS, 9870STS	Separator Tines, Set of 3 High Wear	AMAH209123	\$ 171.99	
	(9650STS, 9670STS, 9750STS, 9770STS - Rice), 9660STS, 9760STS, 9860STS, 9870STS, S650, (S660, S670, S760, S770 - Excluding Rotors w/o Dense Pack), S680, S680HM, S690, S690HM, S780, S790	Separator Tines, Set of 3 Extended Wear, Tungsten Carbide Coated Marked H230288 For Bullet™ or TriStream™ Rotors Includes Hardware (8) Sets Required for Corn and Grain (9) Sets Required for Rice Replaces AH221387	AMAH228817	\$ 179.00	

John Deere®—Combine

	Application	Description	Part Number	Retail Price	Core
	9650STS, 9660STS, 9750STS, 9860STS, 9880STS, S660, (S670, S680, S690, S760, S770 - w/ TriStream™ Rotor), S670HM, S690HM	Separator Tines, Set of 3 (8) Sets Required for Corn and Grain (9) Sets Required for Rice	AMAH208554	\$ 74.00	
	9560STS, 9570STS, S550	Floor	AMH208676	\$ 190.00	
	9560STS, 9570STS	Vane Transport Cover High Wear Replaces AH213327	AMAH213325	\$ 443.84	
	9560STS, 9570STS	Separator Top Cover High Wear Replaces AH204327	AMAH213327	\$ 1066.87	
	9650STS, 9660STS, 9670STS, 9750STS, 9760STS, 9770STS, 9860STS, 9870STS, S650, S680, S660, S670, S670HM, S680HM, S690, S690HM, S760, S770, S780, S790	Vane Transport Cover Replaces AH168166, AH171320, AH202853	AMAH208966	\$ 630.00	
	9650STS, 9660STS, 9670STS, 9750STS, 9760STS, 9770STS, 9860STS, 9870STS	Separator Top Cover Replaces AH146891	AMAH171322	\$ 854.14	
	9650STS, 9750STS	Separator Top Cover Replaces AH171321, AH202855, AH207382	AMAH235314	\$ 925.67	
	9660STS, 9670STS, 9760STS, 9770STS, 9860STS, 9870STS	Separator Top Cover Replaces AH207683	AMAH208573	\$ 869.86	
	9660STS, 9670STS, 9760STS, 9770STS, 9860STS	Separator Module Rail, Right Hand	AMAH205325	\$ 585.00	
	9650STS BSN 696896, 9750STS BSN 696325	Dust Cover Replaces H173329	AMAH201702	\$ 121.93	
	9650STS, 9660STS, 9670STS, 9750STS, 9760STS, 9770STS, 9860STS, 9870STS, S650, S660, S670, S670HM, S680, S680HM, S690, S690HM, S760, S770, S780, S790	Front Flight Repair Kit, Bullet Rotor Marked H217239 For Bullet™ or TriStream™ Rotors for Corn and Grain	AMAH216568	\$ 459.00	
	9650STS, 9660STS, 9670STS, 9750STS, 9760STS, 9770STS, 9860STS, 9870STS, S650, S660, S670, S670HM, S680, S680HM, S690, S690HM, S760, S770, S780, S790	Rear Flight Repair Kit, Bullet Rotor For Bullet™ or TriStream™ Rotors for Corn and Grain	AMAH216569	\$ 500.00	
	9560STS, 9570STS, 9650STS, 9660STS, 9750STS, 9760STS, 9860STS	Round Nut Retainer Sold in Multiples of 2, Priced Individually	AME80202	\$ 6.02	
	9560, 9560SH, (9650STS, 9750STS ASN 000181), 9660, 9660CTS, 9660STS, 9760STS, 9860STS, 9880STS ASN 705801	Fan Speed Actuator	AMAH170587	\$ 66.00	
	9560STS, 9570STS, 9650STS, 9660STS, 9670STS, 9750STS, 9760STS, 9770STS, 9860STS, 9870STS, S550, S660, S670, S680, S690	Rotor Drive Coupling	AMAH150405	\$ 308.00	

John Deere®—Combine

Application	Description	Part Number	Retail Price	Core
 9560STS, 9570STS, 9650STS, 9660STS, 9670STS, 9750STS, 9760STS, 9770STS, 9860STS, 9870STS, S550, S560, S660, S670, S680, S690	Rubber Seal	AMH226877	\$ 12.04	
 9560STS, 9570STS, 9650STS, 9660STS, 9670STS, 9750STS, 9760STS, 9770STS, 9860STS, 9870STS, S550, S650, S660, S670, S680, S690, S760, S770, S780, S785, S790	Rubber Seal	AMH158766	\$ 4.08	
9650STS, 9660STS, 9670STS, 9750STS, 9760STS, 9770STS, 9860STS, 9870STS, S650, S660, S670, S670HM, S680, S680HM, S690, S690HM, S760, S770, S780, S790	Rotor Nose Spider Repair Kit For Bullet™, TriStream™ or Variable Stream Rotor Replaces AH161700, AH229285	AMKXE10164	\$ 443.96	

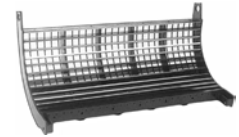

Concaves and Components

Application	Description	Part Number	Retail Price	Core
4400 ASN 9501, 4420* *Retainer Required When Switching 14 to 13 Bar Concave	Concave, 13 Cross Bars	AMAH85396-13	\$ 711.49	
(6600, 6601 ASN 11501), 6602, 6620*, 6620 Titan II*, 6621*, 6622 *AMH116274 Retainer Required When Switching 14 to 13 Bar Concave	Concave, 13 Cross Bars	AMAH108864	\$ 867.00	
	Retainer	AMH116274	\$ 56.50	
(7700, 7701 ASN 8001), 7720*, 7720 Titan II*, 7721* *AMH116275 Retainer Required When Switching 14 to 13 Bar Concave	Concave, 13 Cross Bars	AMAH105066	\$ 905.00	
	Retainer	AMH116275	\$ 58.45	
8820*, 8820 Titan II* *AMH116276 Retainer Required When Switching 14 to 13 Bar Concave	Concave, 13 Cross Bars	AMAH113444	\$ 1195.00	
	Retainer	AMH116276	\$ 76.60	
9400, 9410, 9450, 9500, 9510, 9550, 9560, 9650CTS, 9660CTS, CTS, CTS II	Concave, 13 Cross Bars OEM Style short wire w/ wires in first half of concave - 27 3/4" diameter	AMAH150497	\$ 974.00	
	Concave Front Angle	AMAH151119	\$ 240.00	
9560STS, 9570STS, S550	Concave, Front, Round Bar	AMAH206174	\$ 605.00	
	Concave, Front, Small Wire High Wear	AMAH213234	\$ 1432.47	
	Concave, Middle/Rear, Round Bar High Wear	AMAH206455	\$ 575.00	
	Concave, Middle/Rear, Small Wire High Wear	AMAH213235	\$ 1153.42	
	Concave, Middle/Rear, Large Wire High Wear	AMAH206123	\$ 633.95	
	Concave Set, Small Wire, Set of 3 Replaces AH205488, AH205487	AMAH205488-SET	\$ 2193.00	
	Concave, Front, Large Wire Standard Wear	AMAH206122	\$ 635.00	
	Concave, Front, Small Wire Standard Wear	AMAH205487	\$ 830.00	
9600, 9610, 9650, 9660	Concave, 13 Cross Bars OEM Style short wire w/ wires in first half of concave - 27 3/4" diameter	AMAH150496	\$ 1301.00	
	Concave Front Angle	AMAH151118	\$ 321.00	

John Deere®—Combine

Application	Description	Part Number	Retail Price	Core
9650STS*, 9660STS, 9670STS, 9750STS*, 9760STS, 9770STS, 9860STS, 9870STS, S650, S660, S670, S670HM, S680, S680HM, S690, S690HM, S760, S770, S780, S790 *Requires AMAH210894 Latch Kit to install	Concave, Small Wire, Set of 3	AMBXE10389	\$ 2340.00	
	Concave, Front, Small Wire High Wear	AMAXE28960	\$ 877.00	
	Concave Lip	AMX27517	\$ 80.00	
	Concave, Middle/Rear, Small Wire High Wear	AMAXE28961	\$ 694.00	
	Concaves, Large Wire, Set of 3	AMBXE10391	\$ 2275.00	
	Concave, Front, Large Wire High Wear	AMAXE28965	\$ 890.00	
	Concave Lip	AMX27517	\$ 80.00	
	Concave, Middle/Rear, Large Wire High Wear	AMAXE28966	\$ 690.00	
9650STS*, 9660STS, 9670STS, 9750STS*, 9760STS, 9770STS, 9860STS, 9870STS, S650, S660, S670, S670HM, S680, S680HM, S690, S690HM, S760, S770, S780, S790 *Requires AMAH210894 Latch Kit to install	Concaves, Round Bar, Set of 3	AMBH84226	\$ 1920.00	
	Concave, Front Round Bar	AMAH205261	\$ 709.00	
	Concave Lip	AMX27517	\$ 80.00	
	Concave, Middle/Rear Round Bar	AMAH206456	\$ 638.00	
9650STS*, 9660STS, 9670STS, 9750STS*, 9760STS, 9770STS, 9860STS, 9870STS, S650, S660, S670, S670HM, S680, S680HM, S690, S690HM, S760, S770, S780, S790 *Requires AMAH210894 Latch Kit to install	Helical Concave, Front, Small Wire	AMAH205254H	\$ 1125.00	
9650STS, 9660STS, 9670STS, 9750STS, 9760STS, 9770STS, 9860STS, 9870STS, S650, S660, S670, S670HM, S680, S680HM, S690, S760, (S770, S780, S790 BSN 805001)	Concave Insert Replaces AH158835, AH168438	AMAH204423	\$ 349.45	
9650STS, 9660STS, 9750STS, 9760STS, 9770STS, 9860STS, 9870STS	Concave Cover Plate Set, Set of 3 For Narrow and Wide Concaves	AMBH81876	\$ 194.00	
9650STS, 9660STS, 9670STS, 9750STS, 9760STS, 9770STS, 9860STS, 9870STS	Concave Latch Kit Required when using 60 Series STS Concaves on a 50 Series STS Combine	AMAH210894	\$ 38.00	
	Concave Shock Kit Required when using 60 Series STS Concaves on a 50 Series STS Combine	AMCSK-ST5	\$ 218.02	
9400, 9410, 9450, 9500, 9510, 9510SH, 9550, 9550SH, 9560, 9560SH, CTS II	Concave Grate Use w/ AMAH150497 Concave	AMAH151121	\$ 478.49	
9400, 9410, 9450, 9500, 9500SH, 9510, 9510SH, 9550, 9550SH, 9560, 9560SH, 9650CTS, 9660CTS, CTS, CTS II	Concave Grate, Spike Tooth	AMAH131331	\$ 394.12	
9600, 9610, 9650, 9660	Concave Grate, Spike Tooth	AMAH131330	\$ 441.11	
9650STS, 9660STS, 9670STS, 9750STS, 9760STS, 9770STS, 9860STS, 9870STS, S650, S660, S670, S670HM, S680, S680HM, S690, S690HM	Concave Grate Cover Replaces AXE50778	AMAH170741	\$ 37.50	
S660, S670, S680, S690, S760, S770, S780, S785, S790	Concave Grate Filler Cover Heavy Duty Replaces AXE21144	AMAXE50779	\$ 33.39	
9660STS, 9760STS, 9860STS, 9870STS	Separator Grate Corn and Rice This is the earlier design corn cob mixer grate that uses only two carriage bolts on the replacement fingers	AMAH223656	\$ 1177.29	
9560STS, 9570STS, 9650STS, 9660STS, 9670STS, 9750STS, 9760STS, 9770STS, 9860STS, 9870STS, 9880STS, S540, S550, S560, S650, S660, S670, S680, S690, S760, S770, S780, S785, S790	Concave Latch Mechanism Handle	AMH206715	\$ 28.79	
9400, 9410, 9450, 9500, 9510, 9510SH, 9550, 9550SH, 9560, 9560SH, 9650, 9650CTS, 9660, 9660CTS	Concave Link Replaces H127986, H147484	AMH151484	\$ 36.12	
9400, 9410, 9450, 9500, 9500SH, 9510, 9510SH, 9550, 9550SH, 9560, 9560SH, 9650CTS, 9660CTS, CTS II	Concave Grate Rod Replaces H131002	AMH140803	\$ 56.00	

John Deere®—Combine

Application	Description	Part Number	Retail Price	Core
9650STS, 9660STS, 9670STS, 9750STS, 9760STS, 9770STS, 9860STS, 9870STS, S650, S660, S670, S670HM, S680, S680HM, S690, S690HM, S760, S770, S780, S790	Concave Support Plate Replaces AH146662, AH166173, AH201079, AXE59657	AMAH215091	\$ 240.00	
(S660, S670, S680, S690 ASN 775001)	Concave Support	AMAXE40868	\$ 320.00	
9410, 9450, 9510, 9510SH, 9550, 9550SH, 9560, 9560SH, 9600, 9610, 9650, 9650CTS, 9660, 9660CTS, CTS, CTS II, S660, S670, S670HM, S680, S680HM, S690, S690HM, S760, S770, S780, S790	Concave Actuator Replaces AH134728, AH160107	AMAH170291	\$ 536.00	
9400, 9410, 9450, 9500, 9510, 9510SH, 9550, 9550SH, 9560, 9560SH, 9600, 9610, 9650, 9650CTS, 9660, 9660CTS, CTS, CTS II	Concave Cam, Right Hand Replaces AH133156, H132821	AMH178115	\$ 191.71	
	Concave Cam, Left Hand	AMAH133157	\$ 190.94	
9400, 9410, 9450, 9500, 9500SH, 9510, 9510SH, 9550, 9550SH, 9560, 9560SH, 9650CTS, 9660CTS, CTS, CTS II	Concave Torque Shaft 53.50" Long Replaces H133632	AMH145639	\$ 202.90	
9600, 9610, 9650, 9660	Concave Torque Shaft 64.44" Long	AMH145638	\$ 282.01	
9410, 9450, 9510, 9510SH, 9550, 9550SH, 9560, 9560SH, 9560STS, 9570STS, 9600, 9610, 9650, 9650CTS, 9650STS, 9660, 9660CTS, 9660STS, 9670STS, 9750STS, 9760STS, 9770STS, 9860STS, 9870STS, CTS II	Deck Plate Indicator Shaft	AMR111692	\$ 29.67	
6620, 7720, 8820	Flange Bolt, Adjusting Replaces AH90840, AH127710	AMAH171838	\$ 120.97	
9400, 9410, 9450, 9500, 9510, 9510SH, 9550, 9550SH, 9560, 9560SH, 9600, 9610, 9650, 9650CTS, 9660, 9660CTS, CTS	Concave Insert Replaces AH143744, AH153688, AH171207	AMAH206756	\$ 16.67	
9560STS, 9570STS, 9650STS, 9670STS, 9750STS, 9770STS, 9860STS, 9870STS, S660 SN 765000-785000	Concave Adjusting Actuator	AMAXE13829	\$ 102.00	
9660STS ASN 715739, 9670STS, 9760STS ASN 715819, 770STS, 9870STS, S660, S670, S670HM, S680, S680HM, S690, S690HM, S760, S770, S780, S785, S790	Concave Adjusting Gear 9 Tooth	AMH223940	\$ 52.25	
9560STS, 9570STS, 9650STS, 9660STS ASN 715739, 9750STS, 9760STS ASN 715819, 9860STS, S550	Concave Adjusting Gear 11 Tooth	AMH152305	\$ 155.00	
9560STS, 9570STS, 9660STS, 9670STS, 9760STS, 9770STS, 9860STS, 9870STS, S550 SN 745100-764999, S650 ASN 765000, (S660, S670, S680, S690 ASN 745100), (S670HM, S680HM BSN 765000), S690HM SN 745101-765000, S760, S770, S780, S785, S790	Concave Adjusting Worm Gear Replaces AH171768	AMAH224006	\$ 280.00	

Primary Countershafts and Components



Application	Description	Part Number	Retail Price	Core
4400, 4420	Primary Countershaft 63.25" Long	AMH114617	\$ 422.39	
6600	Primary Countershaft 70.187" Long	AMH89308	\$ 487.59	
6620	Primary Countershaft 66.625" Long	AMH93647	\$ 540.22	
7700	Primary Countershaft 81" Long	AMH89309	\$ 485.07	
7720	Primary Countershaft 77.50" Long	AMH99253	\$ 505.05	
8820	Primary Countershaft 88.375" Long	AMH99739	\$ 556.59	
9400, 9410, 9500, 9500SH, 9510, 9510SH, CTS, CTS II	Primary Countershaft 81.12" Long	AMH147483	\$ 1183.85	
9450, 9550, 9550SH, 9560, 9560SH, 9650CTS, 9660CTS	Primary Countershaft 29 Tooth, 80.19" Long	AMH163279	\$ 771.96	

Prices Subject to Change without Prior Notice. The use of original equipment manufacturer (OEM) part numbers or trademarks, e.g. Case® and John Deere®, are for reference purposes only and for indicating product use and compatibility. Our company and the listed replacement parts contained herein are not sponsored, approved or manufactured by the OEM. All parts are New unless designated Reman in the description.

John Deere®—Combine

Application	Description	Part Number	Retail Price	Core
9560STS, 9570STS, S550	Primary Countershaft 29 Tooth, 61.69" Long	AMH202801	\$ 709.42	
9600, 9610	Primary Countershaft 92" Long	AMAH122240	\$ 1122.00	
9650, 9660	Primary Countershaft 91" Long	AMAH156738	\$ 1348.22	
9650STS*, (9660STS*, 9760STS BSN 710500), 9670STS, 9750STS*, 9770STS, 9860STS* BSN 710700, 9870STS, S650, S660, S670, S670HM, S680, S680HM, S690, S690HM, S760, S770, S780, S790	Primary Countershaft 72.31" Long Replaces H161599	AMH214618	\$ 624.51	
*Will require additional parts to fit: H214619 Bracket, AH213902 Bearing w/ Housing, (4) 19M7793 M16x40 mm Screws and (4) 14M7291 Flange Nuts				
9400, 9410, 9450, 9500, 9500SH, 9510, 9510SH, 9550, 9550SH, 9560, 9560SH, 9600, 9610, 9650, 9650CTS, 9660, 9660CTS, CTS, CTS II	Primary Countershaft Housing 36 Tooth	AMH127196	\$ 442.89	
	Inner Sheave 4.35" Wide, 16.732" OD, 4.952" Bore Diameter	AMH115755	\$ 453.48	
9400, 9410, 9450, 9500, 9510, 9550, 9550SH, 9560, 9560SH, 9600, 9610, 9650, 9650CTS, 9660, 9660CTS, CTS, CTS II	Inner Sheave 36 Spline, 10.87" Long Replaces AH122685	AMAH141820	\$ 704.23	
9560, (9560STS, 9570STS, 9660, 9660CTS, 9670STS - w/ High Capacity), 9760STS, 9860STS, S550, S650, S660, S760	Outer Half Sheave	AMH204872	\$ 663.00	
4425, 4435, 6600, 6620, 7700, 7720	Traction Drive Pulley, Inner	AMH84666	\$ 215.00	
6600 ASN 156501, 6620, 7700 ASN 111901, 7720	Reman Pulley Posi-Torq™ Ground Drive Upper Unit	AMAH86983	\$ 1313.00	\$ 100.00
9400, 9410, 9450, 9500, 9500SH, 9510, 9510SH, 9550, 9550SH, 9560, 9560SH, 9560STS, 9570STS, 9600, 9610, 9650, 9650CTS, 9650STS, 9660STS, 9670STS, 9750STS, 9760STS, 9770STS, 9860STS, 9870STS, S550, S650, S660, S670 BSN 785001	Idler Pulley, Primary Countershaft Drive 7.992" Diameter, 1.437" Overall Width, 0.637" Bore Diameter, 1" Groove Width Replaces AH85276, AH165366	AMAH97031	\$ 32.73	
9400, 9410, (9500, 9500SH ASN 646620), 9510, 9510SH, 9600, 9610, CTS, CTS II	Header Electromagnetic Clutch Pulley 14.567" Diameter, 2.50" Bore, 0.512" Crosshole Diameter, 1.259" Groove Width Replaces AH121657	AMAH139936	\$ 345.19	
9450, 9550, 9550SH, 9560SH, 9560STS, 9570STS, 9650, 9650CTS, 9650STS, 9660, 9660CTS, 9660STS, 9750STS, 9760STS, 9770STS, 9860STS, S550 SN 745100-764999, S650 ASN 765000, (S660, S670 ASN 745100), S680 SN 766007-785000, S690 SN 765250-785000, S760, S770	Hydraulic Cylinder	AMAH213758	\$ 230.00	
3300, 4400, 4420, 6600, 6620, 7700, 7720, 8820, 9400, 9410, 9450, 9500, 9510, 9550, 9560, 9600, 9650CTS, 9660CTS	Ball Bearing	AMJD8669	\$ 150.00	
9400, 9410, 9450, 9501, 9550, 9550SH, 9600, 9610, 9650, 9650CTS, 9660, CTS	Bearing Housing	AMH133618	\$ 97.00	
9400, 9410, 9450, 9500, 9500SH, 9510, 9510SH, 9550, 9550SH, 9560, 9560SH, 9600, 9610, 9650, 9650CTS, 9780CTS ASN 720800, C670, CTS, CTS II, T550, T560, T660, T670	Bushing 4.256" ID, 4.815" OD, 1.181" Long Replaces H123557	AMH148131	\$ 44.32	
9660STS, 9760STS, 9770STS, 9860STS, 9870STS, S650, S660, S670, S680, S680HM, S690, S690HM, S760, S770, S780, S785, S790	Dipstick, Primary Countershaft Gearbox Replaces AH168685, AH173466	AMAXE23425	\$ 45.17	

John Deere®—Combine

Secondary Countershafts and Components



Application	Description	Part Number	Retail Price	Core
6620	Secondary Countershaft 63.75" Long, Splined	AMH94126	\$ 212.42	
7720	Secondary Countershaft 74.625" Long, Splined	AMH94127	\$ 207.87	
8820	Secondary Countershaft 85.437" Long, Splined	AMH93475	\$ 239.88	
6620*, 7720, 8820 *Must Replace both Inner and Outer Sheaves	Inner Sheave	AMH93503	\$ 77.17	
4400, 4420, 6620*, 7720, 8820 *Must Replace both Inner and Outer Sheaves	Outer Sheave	AMH100794	\$ 84.47	
9560STS, 9570STS, 9650STS, 9660STS, 9670STS, 9750STS, 9760STS, 9770STS, 9860STS, 9870STS, S550, S650, S660, S670, S670HM, S680, S680HM, S690, S690HM, S760, S770, S780, S785, S790	Idler 6.50" OD, 2.25" Wide, 0.698" Hole Diameter For Feed Accelerator and Secondary Jackshaft	AMAH150900	\$ 58.40	
9400, 9450, 9500, 9500SH, 9510, 9510SH, 9550, 9550SH, 9560, 9560SH, 9600, 9610, 9650, 9650CTS	Idler Pulley, Secondary Countershaft Drive 7.992" Diameter, 1.437" Overall Width, 0.637" Bore Diameter, 1" Groove Width Replaces AH85276, AH165366	AMAH97031	\$ 32.73	
7720, 8820	Bearing, Secondary Countershaft 2.8346" OD, 1.25" Round Bore Replaces AH10515, JD9316	AMG1104KRRB-I	\$ 25.58	

Cylinder Drive Components

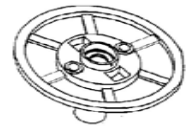

Application	Description	Part Number	Retail Price	Core
9400, 9410, 9450, 9500, 9510, 9510SH, 9550, 9550SH, 9560, 9560SH, 9650, 9650CTS, 9660, 9660CTS, CTS, CTS II	Cylinder Drive Intermediate Shaft 15.75" Long Replaces H115596	AMH148241	\$ 260.31	
6600, 6601, 6602, 7700, 7701	Variable Speed Sheave For Primary Countershaft Includes (2) R27899 Bushings	AMAH84886-N	\$ 325.00	
9400, 9410, 9450, 9500, 9500SH, 9510, 9510SH, 9550, 9550SH, 9560, 9560SH, 9600, 9610, 9650, 9650CTS, 9660, 9660CTS	Half Sheave 16.732" OD, 2" Bore Diameter For Dual Range Cylinder Drive Replaces H115599	AMH145955	\$ 417.38	
9400, 9410, 9450, 9500, 9510, 9550, 9550SH, 9510SH, 9560, 9560SH, 9600, 9650, 9650CTS, 9660, 9660CTS	Inner Sheave 6.07" Long, 16.74" Wide For Dual Range Cylinder Drive Replaces H125530, H144038	AMAH141973	\$ 518.75	
9400, 9410, 9450, 9550, 9550SH, 9650CTS	Outer Sheave Half 17.710" OD For Extended Range Cylinder Drive	AMH137580	\$ 514.39	
9400, 9410, 9500, 9500SH, 9510, 9510SH, 9550, 9550SH, 9560, 9560SH, 9600, 9610, 9650, 9650CTS, 9660, 9660CTS, CTS, CTS II	Cylinder Pulley, Slow Speed 4-Groove, 5.75" OD	AMH118616	\$ 137.04	
6600, 6620, 7700, 7720, 8820, 9400, 9410, 9450, 9500, 9510, 9550, 9560STS, 9570STS, 9600, 9610, 9650CTS, 9650STS, 9660CTS, 9660STS, 9670STS, 9750STS, 9760STS, 9770STS, 9860STS, 9870STS, 9880STS, S550, S650, S660, S670, S680, S690	Bearing Housing Used on feed accelerator and cylinder bar for conventional machines Replaces H75329	AMH203950	\$ 90.00	
9400, 9410, 9450, 9500, 9500SH, 9510, 9510SH, 9550, 9550SH, 9560, 9560SH, 9600, 9610, 9650, 9650CTS, 9660, 9660CTS, CTS, CTS II	Bearing w/ Lock Collar 3.937" OD, 2.105" Bore Diameter Use w/ AMH203950 Bearing Housing	AMJD10343	\$ 36.75	

John Deere®—Combine

Cleaning Fan Shafts and Components

Application	Description	Part Number	Retail Price	Core
6600*, 6620 *On models BSN 310500 fan sheaves must be replaced, See AMH97600 & AMAH100009	Cleaning Fan Shaft 54.75" Long	AMH108571	\$ 128.03	
7700*, 7720 *On models BSN 316000 fan sheaves must be replaced, See AMH97600 & AMAH100009	Cleaning Fan Shaft 65.625" Long	AMH108572	\$ 177.57	
8820	Cleaning Fan Shaft 77" Long	AMH108612	\$ 245.86	
8820	Bearing, Cleaning Fan Shaft Replaces JD9319	AMJD9275	\$ 24.15	
9400, 9410, 9450 BSN 690196, 9500, 9500SH, 9510, 9510SH, 9550 BSN 690669, 9550SH BSN 690701, 9650CTS BSN 690464, CTS, CTS II	Cleaning Fan Shaft 65.87" Long	AMH135396	\$ 442.55	
9400, 9410, 9500, 9510, 9510SH, CTS, CTS II	Cleaning Fan Shaft, Dust Fan 64.31" Long Replaces H164410	AMAH219997	\$ 484.95	
9450 ASN 690193, 9550 ASN 690669, 9550SH ASN 690701, 9560, 9560SH, 9650CTS ASN 690464, 9660CTS	Cleaning Fan Shaft, Narrow 64.19" Long	AMH174045	\$ 266.14	
9560STS, 9570STS	Cleaning Fan Shaft 55.12" Long Replaces AH228558	AMH202372	\$ 271.74	
9560STS, 9570STS, S550	Cleaning Fan Shaft 55.06" Long Replaces H179093	AMH201777	\$ 476.85	
9600, 9610, 9650	Cleaning Fan Shaft 76.75" Long Replaces H171316	AMAH131092	\$ 611.02	
9650STS ASN 690596, 9660STS, 9670STS, 9750STS SN 700602-700631, 9760STS, 9770STS, 9860STS, 9870STS, S650 SN 765000-785000, (S660, S670, S680, S690 SN 745100-785000), (S670HM, S680HM BSN 765000), S690HM SN 745101-765000	Cleaning Fan Shaft, Fan Drive 65.69" Long	AMH173376	\$ 376.31	
9650STS, 9750STS	Cleaning Fan Blade	AMH158420	\$ 55.00	
6600 ASN 301501, 6620, 7700 ASN 316001, 7720, 8820	Inner Fan Shaft Sheave	AMAH100009	\$ 127.94	
9400 ASN 670100, 9410, 9450, 9500 ASN 670200, 9510, 9510SH, 9550, 9550SH, 9560 BSN 705252, 9560SH BSN 705701, 9600 ASN 670300, 9610, 9650, 9650CTS, 9660 BSN 705332, 9660CTS BSN 705403, CTS ASN 670400, CTS II	Inner Fan Shaft Sheave 750-1350 RPM, 18.12" OD, 1.40" Bore	AMAH149356	\$ 392.50	
9400 ASN 670100, 9410, 9450, 9500 ASN 670200, 9510, 9510SH, 9550, 9550SH, 9560, 9560SH, 9600 ASN 670300, 9610, 9650, 9650CTS, 9660, 9660CTS, CTS BSN 670400, CTS II	Inner Fan Shaft Sheave 490-980 RPM, 12.99" OD, 1.37" Bore	AMAH149357	\$ 279.57	
9400 BSN 670100, 9500 BSN 670200, 9600 BSN 670300, CTS BSN 670400	Inner Fan Shaft Sheave 750-1350 RPM, 15.98" OD, 1.38" Bore Replaces H132298	AMAH134873	\$ 265.41	
9450 ASN 690196, 9550 ASN 690669, 9550SH ASN 690701, 9560, 9560SH, 9560STS, 9650 ASN 690730, 9650STS ASN 691595, 9660, 9660CTS, 9660STS, 9750STS ASN 691222, 9760STS, 9860STS, CTS ASN 690464	Inner Fan Shaft Sheave 10.16" OD	AMAH167535	\$ 182.43	
9570STS, 9650STS, 9670STS, 9750STS, 9770STS, 9870STS, S550, S650, (S660, S670, S680, S690 BSN 785001), (S670HM, S680HM, S690HM BSN 765000)	Inner Fan Drive Sheave 12.99" OD	AMH161051	\$ 274.00	
6600 ASN 301501, 6620, 7700 ASN 316001, 7720, 8820	Outer Fan Shaft Sheave	AMH97600	\$ 120.00	
9400, 9410, 9450, 9500, 9510, 9510SH, 9550, 9550SH, 9560, 9560SH, 9600, 9610, 9650, 9650CTS, 9660, 9660CTS, CTS, CTS II	Outer Fan Shaft Sheave 490-980 RPM 12.992" OD, 1.252" Bore Diameter Replaces AH146506	AMAH153040	\$ 238.00	

John Deere®—Combine

Application	Description	Part Number	Retail Price	Core
9400 ASN 670100, 9410, 9450 BSN 690197, 9500 ASN 670200, 9510, 9510SH, 9550 BSN 690670, 9550SH BSN 690701, 9600 ASN 670300, 9650 BSN 690731, 9650CTS BSN 690465, 9650STS BSN 691596, 9750STS BSN 691223, CTS ASN 670400, CTS II	Outer Fan Shaft Sheave 10.16" OD, 1.25" Bore	AMAH146462	\$ 211.43	
9450 ASN 690196, 9550 ASN 690669, 9550SH ASN 690701, 9560, 9560SH, 9560STS, 9570STS, 9650 ASN 690730, 9650CTS ASN 690454, 9650STS ASN 691595, 9660, 9660CTS, 9660STS, 9670STS, 9750STS ASN 691222, 9760STS, 9770STS, 9860STS ASN 700800, 9870STS, S550, S650, S660, (S670, S680, S690 BSN 785001), S670HM, S680HM, S690HM	Outer Fan Shaft Sheave 10.158" OD	AMAH167534	\$ 181.36	
9650STS, 9750STS	Outer Fan Shaft Sheave 12.99" OD	AMAH204179	\$ 348.37	
9400, 9500, 9501, 9600, CTS	Separator Fan Drive Sheave Cast # - H132299	AMAH127496	\$ 248.83	
9400, 9410, 9450, 9500, 9510, 9550, 9550SH, 9560, 9560SH, 9650CTS, 9660CTS	Separator Fan Drive Jackshaft 75.571" Long, 1.376" Diameter Replaces H132208	AMH212308	\$ 307.38	
9600, 9610, 9650, 9660	Separator Fan Drive Jackshaft 86.437" Shaft Length, 1.374" Shaft Diameter, 0.945" Thread Diameter Replaces H132207	AMH212310	\$ 365.30	
9400 ASN 670101, 9500 BSN 670200, 9600 BSN 670300, CTS BSN 670400	Separator Fan Drive Pulley 1.252" ID, 11.37" OD	AMAH131979	\$ 304.64	
9400 BSN 670100, (9500, 9500SH BSN 670200), 9600 BSN 670300, CTS BSN 670400	Separator Fan Drive Pulley 9.118" OD, 1.252" Bore	AMAH131248	\$ 150.00	
9400 ASN 670101, 9410, 9450, (9500, 9500SH ASN 670201), 9510, 9510SH, 9550, 9550SH, 9560 BSN 075251, 9600 ASN 670301, 9610, 9650, 9650CTS, 9660 BSN 705331, 9660CTS BSN 705403, 9780CTS BSN 078555, CTS ASN 670401, CTS II	Sheave Assembly 18.11" OD, 1.25" Bore	AMAH146463	\$ 499.14	
9560STS, 9660STS, 9760STS, 9860STS	Fan Drive Half Sheave, Inner 12.032" OD	AMH206016	\$ 147.68	
9400 ASN 670101, 9450 BSN 690196, 9550 BSN 690669, 9550SH BSN 690701, 9650 BSN 690730, 9650CTS BSN 690464, 9650STS BSN 691595, 9750STS BSN 691222	Sheave Assembly Inner Drive, Separator Fan 10.162" OD, 1.25" Bore Diameter	AMAH157219	\$ 128.00	
7720	Upper Cleaning Fan Housing	AMH97793	\$ 414.27	
9400, 9500, 9501, 9600	Fan Speed Motor Plug on back of Motor	AMAH124567	\$ 85.00	
9660STS, 9670STS, 9760STS, 9770STS, 9860STS, 9870STS, S650, S660, S670, S670HM, S680, S680HM, S690, S690HM, S760, S770, S780, S790	Cleaning Shoe Fan Blade 19.685" Long	AMH206345	\$ 53.00	
9400 BSN 670100, 9500 BSN 670200, 9600 BSN 670300, CTS BSN 670400	Cleaning Fan Drive Pulley 9.125" OD, 1.25" Bore Diameter	AMAH131249	\$ 97.00	
9400, 9410, 9450, 9500, 9501, 9510, 9550, 9550SH, 9560, 9560SH, 9600SH, 9600, 9610, 9640, 9650CTS, 9650, 9660, 9750, 9760STS, 9860STS, 9880STS	Cleaning Fan Sprocket	AMH122372	\$ 29.00	
9400, 9410, 9450, 9500, 9510, 9510SH, 9550, 9550SH, 9560, 9560SH, 9560STS, 9600, 9610, 9650, 9650CTS, 9650STS, 9660, 9660CTS, 9660STS, 9750STS, 9760STS, 9780CTS ASN 072800, 9860STS, 9880STS, CTS, CTS II, S660 SN 765000-785000	Fan Speed Actuator	AMAXE13829	\$ 102.00	
9400, 9410, 9501, 9510, 9510SH, 9550, 9550SH, 9560, 9560STS, 9600, 9610, 9650, 9650STS, 9660, 9660CTS, 9660STS, 9750STS, 9760STS, 9780CTS ASN 072800, 9860STS, 9880STS, CTS, CTS II, Forage Harvesters: 5730, 5830	Fan Speed Actuator Plug under Motor Replaces AA77820	AMAH143903	\$ 60.00	
9400, 9410, 9450, 9500, 9500SH, 9501, 9510, 9510SH, 9600, 9610, 9650, 9650CTS, 9650STS, 9750STS, CTS, CTS II	Fan Drive Speed Shaft 10.31" Long	AMAH128384	\$ 34.96	

Prices Subject to Change without Prior Notice. The use of original equipment manufacturer (OEM) part numbers or trademarks, e.g. Case® and John Deere®, are for reference purposes only and for indicating product use and compatibility. Our company and the listed replacement parts contained herein are not sponsored, approved or manufactured by the OEM. All parts are New unless designated Reman in the description.

John Deere®—Combine

Application	Description	Part Number	Retail Price	Core
9400, 9410, 9450, 9500, 9500SH, 9501, 9510, 9510SH, 9550, 9550SH, 9560, 9560SH, 9560STS, 9570STS, 9600, 9610, 9650, 9650CTS, 9650STS, 9660, 9660CTS, 9660STS, 9670STS, 9750STS, 9760STS, 9770STS, 9780CTS ASN 072800, 9860STS, 9870STS, C670, CTS, CTS II, S550 SN 745100-764999, S650 ASN 765000, (S660, S670, S680 ASN 745100), S670HM BSN 765000, S690 ASN 745100-765249, S760, S770, S780, S785, S790, T550, T560, T660, T670	Thrust Bearing, Separator Fan Drive 3.678" OD, 2.002" Bore Replaces AH229175	AMAH124050	\$ 37.00	
9400, 9410, 9450, 9500, 9500SH, 9510, 9510SH, 9550, 9550SH, 9560, 9560SH, 9560STS, 9570STS, 9600, 9610, 9650, 9650CTS, 9650STS, 9660, 9660CTS, 9660STS, 9670STS, 9750STS, 9760STS, 9770STS, 9860STS, 9870STS, CTS, CTS II	Ball Bearing, Left Hand	AMAH139297	\$ 21.00	
9450 ASN 695100, 9550 ASN 695200, 9550SH ASN 695700, 9560, 9560SH, 9560STS, 9570STS, 9650 ASN 695300, 9650CTS ASN 695400, 9650STS ASN 695500, 9660, 9660CTS, 9660STS, 9670STS, 9750STS ASN 695600, 9760STS, 9770STS, 9860STS, 9870STS, S550, S650, S660, S670, S680, S690, S760, S770	Ball Bearing, Variable Drive Upper Countershaft	AMAH165609	\$ 29.00	
9400, 9410, 9450, 9500, 9500SH, 9510, 9510SH, 9550, 9550SH, 9560, 9560SH, 9560STS, 9570STS, 9600, 9610, 9650, 9650CTS, 9650STS, 9660, 9660CTS, 9660STS, 9670STS, 9750STS, 9760STS, 9770STS, 9860STS, 9870STS, CTS, CTS II, S650, S660, S670, S670HM, S680, S680HM, S690, S690HM, S760, S770, S780, S785, S790	Ball Bearing, Cleaning Fan Shaft 0.984" ID, 2.047" OD Replaces JD9490	AMAH225510	\$ 16.48	
9400, 9410, 9450, 9500, 9500SH, 9510, 9510SH, 9550, 9550SH, 9560, 9560SH, 9600, 9610, 9650, 9650CTS, 9660, 9660CTS, CTS, CTS II	Ball Bearing, Cleaning Fan Shaft 1.5748" ID, 3.1496" OD Use w/ AMH133621 Bearing Flange Replaces 96328C1, 552945	AMJD39109	\$ 21.00	
9560STS, 9650STS, 9660STS, (9670STS, 9770STS, 9870STS - w/ Regular Shoe Only), 9750STS, 9760STS, 9860STS, S550, (S650, S670, S680, S690 BSN 785001), S670HM, S680HM, S690HM	Ball Bearing, Cleaning Shoe Shaft 1.5748" ID, 3.1496" OD Use w/ AMH133621 Bearing Flange Replaces 96328C1, 552945	AMJD39109	\$ 21.00	
9400, 9410, 9450, 9500, 9500SH, 9510, 9510SH, 9550, 9550SH, 9560, 9560SH, 9560STS, 9570STS, 9600, 9610, 9650, 9650CTS, 9650STS, 9660, 9660CTS, 9660STS, (9670STS, 9770STS, 9870STS - w/ Regular Shoe), 9750STS, 9760STS, 9860STS, S550, (S650, S660, S670, S680, S690 BSN 785001), S670HM, S680HM, S690HM, CTS, CTS II	Bearing Flange 2.835" ID, 3.937" Bolt Circle Diameter	AMH133621	\$ 8.40	
9400, 9410, 9450, 9500, 9500SH, 9510, 9510SH, 9550, 9550SH, 9560, 9560SH, 9560STS, 9570STS, 9600, 9610, 9650, 9650CTS, 9650STS, 9660, 9660CTS, 9660STS, 9670STS, 9750STS, 9760STS, 9770STS, 9860STS, 9870STS, CTS, CTS II, S550, S650, S660, S670, S680, S760, S770, S780, S785, S790	Bearing Flange, Cleaning Fan Shaft 4.689" Bolt Circle Diameter	AMH113626	\$ 8.95	
9400, 9410, 9500, 9500SH, 9510, 9510SH, 9550, 9550SH, 9560, 9560SH, 9560STS, 9570STS, 9600, 9610, 9650, 9650CTS, 9650STS, 9660, 9660CTS, 9660STS, 9670STS, 9750STS, 9760STS, 9770STS, 9860STS, 9870STS, CTS, CTS II, S550, S650, S660, S670, S670HM, S680, S680HM, S690, S690HM, S760, S770, S780, S785, S790	Bearing Flange, Cleaning Fan Shaft 4.689" Bolt Circle Diameter	AMH113625	\$ 6.37	
3300, 4400, 4420, 6600, 6620, 7700, 7720, 8820	Bearing, Cleaning Fan Drive Sheave 1.50" ID, 2.507" OD	AMAH87207	\$ 22.77	
6600, 6620, 7700, 7720	Bearing, Cleaning Fan Driveshaft 2.4409" OD, 1.125" Bore Diameter	AMJD9246	\$ 23.30	

John Deere®—Combine

Separator Gearbox Components

Application	Description	Part Number	Retail Price	Core
9400, 9410, 9450, 9500, 9500SH, 9510, 9510SH, 9550, 9550SH, 9560, 9560STS, 9570STS, 9600, 9610, 9650, 9650CTS, 9650STS, 9660, 9660CTS, 9660STS, 9670STS, 9750STS, 9760STS, 9770STS, 9860STS, 9870STS, CTS, CTS II	Gearbox Shaft, Main Engine 28.812" Long	AMH129934	\$ 246.46	
9400, 9410, 9500, 9500SH, 9510, 9510SH, 9600, 9610, CTS	Main Clutch Shaft 8.71" Long, 20, 41 & 23 Tooth Replaces H148768	AMH148768	\$ 322.86	
9400, 9410, 9450, 9500, 9500SH, 9510, 9510SH, 9550 BSN 700200, 9550SH BSN 700700, 9560STS BSN 720100, 9600, 9610, 9660, 9660CTS, 9660STS, 9760STS, 9860STS, 9870STS, CTS, CTS II	Unloader Drive Sheave 2-Groove, 8.534" OD	AMH129935	\$ 185.47	
9570STS, 9650STS, 9660STS, 9670STS, 9750STS, 9760STS, 9770STS, 9860STS, 9870STS, S550, S650, S660, S670 BSN 765253, S670HM, S680, S680HM, S690, S690HM, S770 ASN 1Z0S770XXX110000, S780, S785, S790	Bearing, Separator Drive Variable Speed Replaces AH144150	AMAH209207	\$ 134.01	
6600, 6620, 7700, 7720, 8820	Double Idler Pulley, Separator Drive 3.25" Wide, 8" OD, 0.50" Bore Diameter Replaces AH87119	AMAH93318	\$ 61.45	

Elevator Chains

Elevator chains include rubber paddles attached with 5/16" plated bolts and nuts (unless noted in the individual description). Chains feature full side plates for added strength.



Application	Description	Part Number	Retail Price	Core
3300, 4400, 4420	Clean Grain Elevator Chain 100 links - 4 3/4" x 2 1/2" paddles every 4th link	AMAH87745	\$ 158.00	
	Rubber Paddle 4 3/4" x 2 1/2"	AMH86759	\$ 1.18	
4400, 4420, 6600, 6601, 6620, 7700, 7701, 7720, 7721, 8820	Clean Grain Elevator Chain 108 links - 6" x 3" paddles every 4th link	AMAH87747	\$ 200.00	
	Rubber Paddle 6" x 3"	AMH135235	\$ 2.25	
6600, 6601, 6620, 7700, 7701, 7720, 7721, 8820 BSN 464350	Clean Grain Elevator Chain 128 links - 6" x 3" paddles every 4th link	AMX29002	\$ 180.00	
	Rubber Paddle 6" x 3"	AMH135235	\$ 2.25	
8820 ASN 464350	Clean Grain Elevator Chain 108 links - 3" x 7 3/8" paddles every 4th link	AMAH134818	\$ 210.00	
	Rubber Paddle 3" x 7 3/8"	AMH106323	\$ 2.72	
9400, 9410, 9500, 9510, CTS, CTS II	Clean Grain Elevator Chain 144 links - 6" x 4 3/8" paddles every 4th link	AMAH162441	\$ 214.00	
	Rubber Paddle 6" x 4 3/4"	AMH137276	\$ 2.13	
9450, 9550, 9550SH, 9560, 9560SH, 9560STS, 9570STS, 9650, 9650CTS, 9650STS, 9660, 9660CTS, 9660STS, 9670STS, 9750STS, 9760STS, 9860STS, S550, S650, S660, S670 BSN 765253, S760	Clean Grain Elevator Chain 144 links - 8 3/4" x 4 3/4" paddles every 4th link Replaces AH162058, AXE25091, AXE28559	AMAH162059	\$ 340.00	
	Rubber Paddle 8 3/4" x 4 3/4"	AMH144667	\$ 3.68	
9600, 9610	Clean Grain Elevator Chain 144 links - 7 3/4" x 4 1/4" paddles every 4th link	AMAH162442	\$ 300.00	
	Rubber Paddle 7 3/4" x 4 1/4"	AMH137277	\$ 3.70	

John Deere®—Combine

Application	Description	Part Number	Retail Price	Core
9670STS, 9770STS, 9870STS, S660, S670, S670HM, S680, S680HM, S690HM, S770, S780, S790 w/ High Capacity Chain	Clean Grain Elevator Chain 147 Links - 4 3/4" x 8 7/8" paddles every 4th link CA550 Chain Replaces AH234790, AXE25092	AMAXE28560	\$ 435.00	
	Rubber Paddle 4 3/4" x 8 7/8"	AMH237830	\$ 4.04	
S690 ASN 745100, S790 w/ Extra High Capacity Chain	Clean Grain Elevator Chain 148 Links - 8 3/4" x 4 5/8" paddles every 4th link	AMAXE16681	\$ 585.00	
3300, 4400, 4420, 6600, 6601, 6620 BSN 610300, 7700, 7701, 7720 BSN 610500	Return Grain Elevator Chain 144 links - 4 3/4" x 2 1/2" paddles every 6th link	AMAH96388	\$ 185.00	
	Rubber Paddle 4 3/4" x 2 1/2"	AMH86759	\$ 1.18	
6620 ASN 610300, 7720 ASN 610501, 8820	Return Grain Elevator Chain 144 links - 6" x 3" paddles every 6th link	AMAH98032	\$ 189.00	
	Rubber Paddle 6" x 3"	AMH135235	\$ 2.25	
9400, 9410, 9450, 9500, 9510, 9550, 9600, 9610, 9650, CTS, CTS II	Return Grain Elevator Chain 151 links - 6" x 3" paddles every 6th link	AMAH131074	\$ 225.00	
	Rubber Paddle 6" x 3"	AMH135235	\$ 2.25	
9560STS, 9570STS, 9650STS, 9660STS, 9670STS, 9750STS, 9760STS, 9770STS, 9860STS, 9870STS, S550, S650, S660, S670, S670HM, S760, S770	Return Grain Elevator Chain 113 links - 6" x 3" paddles every 6th link	AMAH148021	\$ 195.00	
	Rubber Paddle 6" x 3"	AMH135235	\$ 2.25	
S680, S680HM, S690, S690HM, S780, S785, S790	Return Grain Elevator Chain 79 Links - 8 3/4" x 3 1/8" paddles every 6th link Replaces AXE10556	AMAXE47615	\$ 257.00	
	Rubber Paddle 8 3/4" x 3 1/8"	AMHXE15520	\$ 5.63	

Elevator Housings and Components



Application	Description	Part Number	Retail Price	Core
6600, 6620 Early, 7700, 7720 Early	Clean Grain Elevator Housing	AMAH96610	\$ 973.60	
6600, 6620 ASN 464350, 7700, 7720 ASN 556301, 8820 BSN 464350	Clean Grain Elevator Housing For Early Update, (2) AH125904 Bearing Plates are Required	AMAH112164	\$ 973.60	
8820 ASN 464350	Clean Grain Elevator Housing	AMAH105850	\$ 1000.00	
9400, 9410, 9500, 9510, 9510SH, CTS, CTS II	Clean Grain Upper Elevator Housing Non-Stainless	AMAH153743	\$ 801.00	
9400, 9500, 9500SH, 9410, 9510, 9510SH, CTS, CTS II	Lower Clean Grain Elevator Housing Non-Stainless	AMAH156594	\$ 918.00	
9450, 9550, 9560, 9640, 9650, 9650CTS, 9660, 9660CTS, 9680	Clean Grain Elevator Housing	AMAH207172	\$ 2304.00	
9600, 9610	Upper Clean Grain Elevator Housing Non-Stainless	AMAH153741	\$ 780.00	
	Lower Clean Grain Elevator Housing Non-Stainless	AMAH156596	\$ 811.00	
9560STS, 9570STS, 9650STS, 9660STS, 9670STS, 9750STS, 9760STS, 9860STS	Clean Grain Elevator Housing Replaces AH149062, AH207168, AH218602	AMAXE12250	\$ 1684.77	
	Clean Grain Elevator Housing Replaces AH221442	AMAXE12248	\$ 2569.00	
9400, 9410, (9500, 9500SH ASN 640200), 9510, 9510SH, CTS, CTS II	Upper Clean Grain Auger Housing Replaces AH149183	AMAH235411	\$ 883.85	
S670, S670HM, S680, S680HM, S690, S690HM	Clean Grain Elevator Housing High Capacity and Regular Wear	AMAXE14370	\$ 3900.00	

John Deere®—Combine

Application	Description	Part Number	Retail Price	Core
9400, 9410, 9500, 9501, 9510, 9510SH	Perforated Door 25 5/8" Long, 7 1/8" Wide For Clean Grain Elevator	AMAH127396	\$ 98.64	
9600, 9610	Perforated Door 26" Long, 10 1/8" Wide, 0.437" Mounting Hole Diameter For Clean Grain Elevator	AMAH127397	\$ 117.42	
6600, 6601, 6602, 6620, 6622, 7700, 7701, 7720, 7721	Return Grain Elevator Housing	AMAH96371	\$ 905.00	
6620 Titan II, 7720 Titan II, 8820 Titan II	Return Grain Elevator Housing	AMAH112077	\$ 871.06	
9400, 9410, 9450, 9500, 9510, 9550, 9560, 9600, 9610, 9650, 9650CTS, 9660, 9660CTS, CTS II	Return Grain Elevator Housing Replaces AR93889	AMAH169233	\$ 1275.00	
9560STS, 9650STS, 9660STS, 9750STS, 9760STS, 9860STS	Solid Door For Return Grain Elevator Housings	AMAH130892	\$ 57.00	
9560STS, 9650STS, 9660STS, 9750STS, 9760STS, 9860STS	Return Grain Elevator Housing	AMAH149536	\$ 1099.34	
9570STS, 9670STS, 9770STS, 9870STS, S550 SN 745100- 764999, S650 SN 765000-785000, (S660, S670 SN 745100- 785000), S670HM BSN 765000	Return Grain Elevator Housing Replaces AH232508	AMAXE14891	\$ 1188.00	
6620 ASN 610300, 7720 ASN 610500, 8820	Solid Door For Return Grain Elevator Housings	AMAH98029	\$ 54.80	
6620 ASN 610301, 7720 ASN 610501, 7721 ASN 610601, 8820	Perforated Door For Return Grain Elevator Housings	AMAH98030	\$ 67.85	
9400, 9410, 9450, 9500, 9501, 9510, 9510SH, 9550, 9550SH, 9560, 9560SH, 9600, 9610, 9650, 9660, 9660CTS, 9780CTS BSN 076057	Perforated Door 12" Long, 7 7/8" Wide For Return Grain Elevator Housing	AMAH130893	\$ 59.03	
S680, S680HM, S690, S690HM, S780, S790	Solid Door For Lower Return Grain Elevator	AMAH234729	\$ 78.86	
9600, 9610, 9650	Tube Assembly For Upper Tailings Auger Replaces AH137303, AH137582, AH141571	AMAH149179	\$ 784.41	
9560STS, 9570STS, 9650STS, 9660STS, 9670STS, 9750STS, 9760STS, 9770STS, 9860STS, 9870STS, S550 SN 745100- 764999, S650 SN 765000-785000, S660 ASN 765172, S670 ASN 765253, S680 ASN 785001	Door Assembly, Perforated 24 3/4" Long, 6 1/4" Wide For Tailings Elevator	AMAH162156	\$ 79.65	
3300, 4400, 3300, 4420, 6600, 6601, 6602, 6620 BSN 610300, 6622, 7700, 7701, 7720 BSN 610500, 7721 BSN 610600	Solid Door For Clean Grain/Tailing Elevator	AMAH12678	\$ 33.47	
9400, 9410, 9450, 9500, 9510, 9510SH, 9550, 9550SH, 9600, 9610, 9650, 9650CTS, 9650STS, 9750STS, CTS, CTS II	Upper Clean Grain Elevator Sheave Hub 1.182" ID	AMH134760	\$ 57.36	
9560STS, 9570STS, 9650STS, 9660STS, 9670STS, 9750STS, 9760STS, 9770STS, 9860STS, 9870STS, S550, S650, S660, S670, S670HM, S760, S770	Slip Clutch Pulley 1.381" ID, 8.892" OD For Tailing Elevator	AMAH173040	\$ 180.76	
9560STS, 9570STS, 9650STS, 9660STS, 9670STS, 9750STS, 9760STS, 9770STS, 9860STS, 9870STS, S560, S650, S660, S670, S760, S770	Slip Clutch Hub 2.047" Long, 3.543" OD, 0.987" Bore, 0.276" Offset	AMH174509	\$ 65.79	
6620, 7700 ASN 163901	Spout	AMAH88989	\$ 367.38	
7720, 8820 BSN 464350	Spout	AMAH97856	\$ 415.00	
8820 ASN 464351	Upper Spout	AMAH105498	\$ 510.00	
S550, S650, S660, S670, S670HM, S680HM, S690HM, S760, S770, (S780, S790 ASN 120S780XXXX109999), S785	Vertical Unloading Auger Lower Drive Shaft Splined Shaft	AMHXE16941	\$ 195.00	
9400, 9410, 9450, 9500, 9500SH, 9510, 9510SH, 9550, 9550SH, 9560, 9560SH, 9560STS, 9610, 9650, 9650CTS, 9650STS, 9660, 9660CTS, 9660STS, 9750STS, 9760STS, 9770STS, 9860STS, 9870STS, CTS II	Bushing, Clean Grain Elevator Drive Tightener 1.005" ID, 1.128" OD, 1" Wide	AMH171061	\$ 5.00	
9560STS, 9570STS, 9650STS, 9660STS, 9670STS, 9750STS, 9760STS, 9860STS, 9870STS, S550, S650, S660, S670, S670HM, S680, S680HM, S690, S690HM, S760, S770	Bearing w/ Collar, Lower Tailings Return Elevator Housing	AMJD10384	\$ 22.00	
S680, S680HM, S690, S690HM, S780, S790	Bearing w/ Collar, Upper and Lower Active Tailings Elevator	AMJD10384	\$ 22.00	

Prices Subject to Change without Prior Notice. The use of original equipment manufacturer (OEM) part numbers or trademarks, e.g. Case® and John Deere®, are for reference purposes only and for indicating product use and compatibility. Our company and the listed replacement parts contained herein are not sponsored, approved or manufactured by the OEM. All parts are New unless designated Reman in the description.

John Deere®—Combine

Elevator Chain Sprockets

To extend the life of your chain assemblies, always replace the sprockets when installing a new chain. Forged carbon steel, induction hardened tooth.



Application	Description	Part Number	Retail Price	Core
3300, 4400, 4420	Clean Grain Elevator Chain Sprocket, Upper 7 Tooth, 1" Shaft	AMH63577	\$ 39.74	
6600 ASN 3701, 6601, 6602, 6620 ASN 610301, 6622, 7700 ASN 2801, 7701, 7720 ASN 610501, 7721, 8820	Clean Grain Elevator Chain Sprocket, Upper 8 Tooth, 1" Shaft	AMH108576	\$ 30.00	
8820 ASN 464351	Clean Grain Elevator Chain Sprocket, Upper 8 Tooth, 1.25" Shaft	AMH91334	\$ 35.00	
9400, 9500, 9510, 9600, 9610, CTS, CTS II	Clean Grain Elevator Chain Sprocket, Upper 8 Tooth, 30 mm Shaft Replaces H177988	AMH128576	\$ 36.00	
9450, 9550, 9550SH, 9560, 9560SH, 9560STS, 9570STS, 9650, 9650CTS, 9650STS, 9660, 9660CTS, 9660STS, 9670STS, 9750STS, 9760STS, 9860STS, (S550, S650, S660, S670 BSN 765253, S760 - Standard Capacity)	Clean Grain Elevator Chain Sprocket, Upper 8 Tooth, 30 mm Shaft	AMH164796	\$ 28.00	
9770STS, 9870STS, S670, S670HM, S680, S680HM, S690HM, (S770, S790 - w/ High Capacity Chain), S780	Clean Grain Elevator Chain Sprocket, Upper Heavy Duty, 10 Tooth, 1.387" ID, 5.84" OD	AMH228385	\$ 41.50	
S690, S790 w/ Extra High Capacity Chain	Clean Grain Elevator Chain Sprocket, Upper	AMHXE22459	\$ 65.00	
3300, 4400, 4420	Clean Grain Elevator Chain Sprocket, Lower 7 Tooth, 1" Shaft	AMH63578	\$ 23.00	
6600 ASN 3701, 6620, 7700 ASN 2801, 7701, 7720, 7721, 8820	Clean Grain Elevator Chain Sprocket, Lower 8 Tooth, 1.25" Shaft	AMH91334	\$ 35.00	
6601, 6602, 6622	Clean Grain Elevator Chain Sprocket, Lower 8 Tooth, 1" Shaft	AMH108576	\$ 30.00	
9400, 9410, 9450, 9500, 9500SH, 9550, 9550SH, 9560, 9560SH, 9560STS, 9570STS, 9600, 9610, 9650, 9650CTS, 9650STS, 9660, 9660CTS, 9660STS, 9670STS, 9750STS, 9760STS, 9770STS, 9860STS, 9870STS, CTS, CTS II, (S550, S650, S660, S670 BSN 765253, S760 - Regular Capacity)	Clean Grain Elevator Chain Sprocket, Lower 8 Tooth, 35 mm Shaft	AMH133143	\$ 33.00	
9770STS, 9870STS, S670, S670HM, S680, S680HM, S690HM, S770, S780 - w/ High Capacity or High Unloading Rate	Clean Grain Elevator Chain Sprocket, Lower 10 Tooth, 1.779" ID, 5.84" OD	AMH228383	\$ 39.25	
S690, S790 w/ Extra High Capacity Chain	Clean Grain Elevator Chain Sprocket, Lower	AMHXE22458	\$ 65.00	
3300, 4400, 4420, 6600 ASN 003701, 6601, 6602, 6620 BSN 610300, 6622, 7700 ASN 002801, 7701, 7720 BSN 610500	Return Grain Elevator Chain Sprocket, Upper 7 Tooth, 1" Shaft	AMH63578	\$ 23.00	
6620 ASN 610301, 7720 ASN 610501, 8820	Return Grain Elevator Chain Sprocket, Upper 8 Tooth, 1" Shaft	AMH108576	\$ 30.00	
9400, 9410, 9450, 9500, 9510, 9550, 9560, 9600, 9610, 9650, 9660, 9660CTS, CTS, CTS II	Return Grain Elevator Chain Sprocket, Upper 8 Tooth, 1" Hex Shaft	AMH134603	\$ 22.00	
9560STS, 9570STS, 9650STS, 9660STS, 9670STS, 9750STS, 9760STS, 9770STS, 9860STS, 9870STS, CTS, CTS II, S550, S650, S660, S670, S670HM, S760, S770	Return Grain Elevator Chain Sprocket, Upper 8 Tooth, 30 mm Shaft Replaces H177988	AMH128576	\$ 36.00	
S680, S680HM, S690, S690HM, S780, S790	Return Grain Elevator Chain Sprocket, Upper 8 Tooth, 30 mm Shaft	AMH164796	\$ 28.00	
3300, 4400, 4420, 6600, 6601, 6602, 6622, 7700, 7701	Return Grain Elevator Chain Sprocket, Lower 7 Tooth, 1" Shaft	AMH63578	\$ 23.00	
6620 BSN 610300, 6622, 7720 BSN 610500, 7721	Return Grain Elevator Chain Sprocket, Lower 7 Tooth, 1.25" Shaft	AMH99472	\$ 41.00	
8820	Return Grain Elevator Chain Sprocket, Lower 8 Tooth, 1" Shaft	AMH108576	\$ 30.00	
9400, 9410, 9450, 9500, 9510, 9550, 9600, 9610, 9650, CTS	Return Grain Elevator Chain Sprocket, Lower 8 Tooth, 1" Hex Shaft	AMH134603	\$ 22.00	
9560STS, 9650STS, 9660STS, 9670STS, 9750STS, 9760STS, 9770STS, 9860STS, 9870STS, S550, S660, S670, S670HM, S680, S680HM, S690, S690HM, S760, S770, S780, S790	Return Grain Elevator Chain Sprocket, Lower 8 Tooth, 35 mm Shaft	AMH133143	\$ 33.00	

John Deere®—Combine



Application	Description	Part Number	Retail Price	Core
3300, 4400 BSN 101300, 4420, 6600, 6620 BSN 502550, 7700 BSN 507350, 7720, 9400, 9410, 9450, 9500, 9501, 9510, 9510SH, 9550, 9600, 9610, 9650, 9650CTS, 9660, 9660CTS, 9780CTS ASN 072800, C670, CTS, CTS II, T550, T560, T660, T670	Idler Sprocket 17 Tooth, 0.50" Shaft Replaces AH87204	AMAH98176	\$ 19.91	
3300, 4400, 4420, 6600, 6601, 6602, 6620, 7700, 7701, 7720	Idler Sprocket 17 Tooth, 0.50" Bore Diameter For Size 50 Chain	AMAH21440	\$ 25.11	
9400, 9410, 9450, 9500, 9500SH, 9501, 9510, 9510SH, 9550, 9550SH, 9560, 9560SH, 9600, 9610, 9650, 9650CTS, 9660, 9660CTS, CTS, CTS II	Upper Tailings Drive Sprocket Assembly 30 Tooth, 1" Hex Bore Diameter For Size 50 Chain	AMAH130571	\$ 35.00	
9400, 9410, 9450, 9500, 9500SH, 9501, 9510, 9510SH, 9550, 9550SH, 9560, 9560SH, 9600, 9610, 9650, 9650CTS, 9660, 9660CTS, CTS, CTS II	Tailings Drive Sprocket Assembly 18 Tooth, 1" Hex Bore Diameter For Size 50 Chain	AMAH130572	\$ 36.00	
9400, 9410, 9450, 9500, 9500SH, 9501, 9510, 9510SH, 9550, 9550SH, 9560, 9560SH, 9600, 9610, 9650, 9650CTS, 9660, 9660CTS, CTS, CTS II	Tailings Drive Sprocket Assembly 18 Tooth, 1.184" Bore Diameter For Size 50 Chain	AMAH121047	\$ 38.00	
9400, 9410, 9450, 9500, 9500SH, 9510, 9510SH, 9550, 9550SH, 9560, 9560SH, 9560STS, 9570STS, 9600, 9610, 9650, 9650CTS, 9650STS, 9660, 9660CTS, 9660STS, 9670STS, 9750STS, 9760STS, 9860STS, CTS, CTS II, S550, S650, S660, S760	Idler Pulley, Clean Grain Elevator Drive 7 15/16" Diameter	AMAN15237	\$ 26.15	
9770STS, 9870STS, S670, S670HM, S680, S680HM, S690, S690HM, S770, S780, S785, S790	Idler Pulley, Clean Grain Elevator Drive	AMAH220915	\$ 125.29	

Elevator Gearbox

Application	Description	Part Number	Retail Price	Core
 4400 ASN 151501, 4420, 6600 ASN 156501, 6620, 6622, 7700 ASN 163901, 7720, 7721, 8820	Reman Bin Loading Auger Gearbox Replaces AH89006, AH96760	AMAH129277	\$ 695.00	\$ 200.00
 4400 ASN 151500, 6620 ASN 620100, 7720 ASN 621219, 8820 ASN 620834	Bin Loading Auger Gearbox Shaft 5.63" Long Replaces H94702	AMH132607	\$ 33.50	
 9400, 9410, 9450, 9510, 9550, 9570STS, 9600, 9610, 9650, 9650STS, 9670STS, 9770STS, 9860STS, CTS, CTS II, S550, S650, S660, S670, S670HM, S680, S680HM, S690HM, S760, S770, S780	Grain Elevator Gearbox Replaces DE19271, DE31853	AMDE20100	\$ 1219.00	
 9400, 9410, 9450, 9500, 9510, 9550, 9560, 9570STS, 9600, 9610, 9650, 9650CTS, 9650STS, 9660, 9660CTS, 9670STS, 9750STS, 9860STS, CTS, CTS II	Gearbox Pulley Use w/ AMDE20100 Gearbox Replaces AH164868	AMAH221847	\$ 82.00	
 9400, 9410, 9450, 9500, 9500SH, 9510, 9510SH, 9550, 9550SH, 9560, 9560SH, 9560STS, 9570STS, 9600, 9610, 9650, 9650CTS, 9650STS, 9660, 9660CTS, 9660STS, 9750STS, 9760STS, 9770STS, 9860STS, 9870STS, CTS, CTS II, S550, S650, S660, S670, S670HM, S680, S680HM, S690, S690HM, S760, S770, S780, S790	Clean Grain Elevator Gearbox Seal	AMAH131860	\$ 19.50	
 (4400, 6600 ASN 151500), 4420, 6620, 7700 ASN 163900, 7720, 8820	Gearbox Input Shaft 5.11" Long	AMH94703	\$ 31.25	
 9400, 9410, 9450, 9500, 9500SH, 9510SH, 9550, 9550SH, 9560, 9560SH, 9560STS, 9570STS, 9600, 9610, 9650, 9650CTS, 9650STS, CTS, CTS II, S650, S660, S670, S680	Gearbox Input Shaft	AMCE18445	\$ 87.00	

Prices Subject to Change without Prior Notice. The use of original equipment manufacturer (OEM) part numbers or trademarks, e.g. Case® and John Deere®, are for reference purposes only and for indicating product use and compatibility. Our company and the listed replacement parts contained herein are not sponsored, approved or manufactured by the OEM. All parts are New unless designated Reman in the description.

John Deere®—Combine

	Application	Description	Part Number	Retail Price	Core
	9400, 9410, 9450, 9500, 9500SH, 9501, 9510, 9510SH, (9550, 9550SH ASN 685956), 9560, 9560SH, 9560STS, 9600, 9610, 9650 BSN 686232, 9650CTS ASN 685523, 9650STS, 9660, 9660CTS, 9660STS, 9670STS, 9750STS, 9760STS, 9770STS, 9860STS, 9870STS, CTS, CTS II	Gearbox Shaft 9.67" Long	AMH170967	\$ 80.00	
	9400, 9410, 9450 BSN 685202, 9500, 9500SH, 9510, 9510SH, 9550 BSN 685955, 9550SH BSN 685735, 9650 BSN 686232, 9650CTS BSN 685522, 9650STS, 9750STS	Clean Grain Elevator Gearbox Shaft 8.74" Long Use w/ AH140127 Gearbox	AMH135452	\$ 37.00	
	9400, 9410, 9500, 9510, 9510SH, 9550, 9550SH, 9560, 9560SH, 9560STS, 9570STS, 9600, 9610, 9650, 9650CTS, 9650STS, 9660, 9660CTS, 9660STS, 9670STS, 9750STS, 9860STS, 9870STS, CTS, CTS II, S550, S650, S660, S670, S670HM, S680, S680HM, S690, S690HM, S760, S770, S780, S785, S790	Gear Kit Includes 46 and 53 Tooth Gears For Clean Grain Elevator Gearbox Replaces H135287, H145316, H145317	AMAH162230	\$ 290.00	
	4400 ASN 151500, 4420, 6600 ASN 156500, 6620, 7700 ASN 163900, 7720, 8820, 9400, 9410, 9450, 9500, 9500SH, 9510, 9510SH, 9550, 9550SH, 9560, 9560SH, 9560STS, 9600, 9610, 9650, 9650CTS, 9650STS, 9660, 9660CTS, 9660STS, 9750STS, 9760STS, 9770STS, 9860STS, 9870STS, CTS, CTS II	Ball Bearing 0.748 Wide, 1.181" ID, 0.835" OD For Clean Grain Elevator Gearbox Replaces 350358X1, 70097088	AMJD7689	\$ 8.00	

Elevator Head Shafts









Application	Description	Part Number	Retail Price	Core
3300, 4400, 4420	Clean Grain Elevator Head Shaft 12" Long	AMH80704	\$ 74.14	
6600, 6601, 6602, 6620, 6622, 7700, 7720, 7721, 8820 BSN 464350	Clean Grain Elevator Head Shaft 13.13" Long	AMH82948	\$ 30.00	
8820 ASN 464351	Clean Grain Elevator Head Shaft 13.44" Long	AMH106314	\$ 35.00	
9400, 9410, 9500, 9501, 9510, 9510SH, CTS, CTS II	Clean Grain Elevator Head Shaft 12.75" Long	AMH135713	\$ 28.00	
9450, 9550, 9550SH, 9560, 9560SH, 9560STS, 9570STS, 9650, 9650CTS, 9660, 9660CTS, 9670STS, 9750STS, 9860STS, S550, S650, S660, S760, S770 w/ Standard Capacity Chain	Clean Grain Elevator Head Shaft 15.68" Long	AMH157043	\$ 59.00	
9600, 9610	Clean Grain Elevator Head Shaft	AMH135714	\$ 48.00	
3300, 4400, 4420, 6600, 6601, 6620 BSN 610300, 6622, 7700, 7701, 7720 BSN 610500, 7721 BSN 610600	Upper Tailings Elevator Head Shaft 10.50" Long	AMH75978	\$ 37.64	
6620 ASN 610300, 7720 ASN 610500, 8820	Lower Tailings Elevator Shaft 11.75" Long	AMH89517	\$ 54.23	
9560STS, 9570STS, 9650STS, 9660STS, 9670STS, 9750STS, 9760STS, 9770STS, 9860STS, 9870STS, S550, S650, S660, S670, S670HM, S760, S770	Top Tailings Elevator Shaft 14" Long	AMH156938	\$ 57.50	
9450, 9550, 9550SH, 9560, 9560SH, 9560STS, 9570STS, 9650, 9650CTS, 9650STS, 9660, 9660CTS, 9660STS, 9670STS, 9750STS, 9760STS, 9860STS, S550, S650, S660, S670 BSN 765253, S760	Bearing w/ Collar, Upper Clean Grain Elevator Shaft	AMJD10384	\$ 22.00	
9560STS, 9570STS, 9650STS, 9660STS, 9670STS, 9750STS, 9760STS, 9770STS, 9860STS, 9870STS, S550, S650, S660, S670, S670HM, S680, S680HM, S690, S690HM, S760, S770	Bearing w/ Collar, Upper Tailings Return Elevator Shaft	AMJD10384	\$ 22.00	

John Deere®—Combine

Application	Description	Part Number	Retail Price	Core
8820, 9400, 9410, 9450, 9500, 9500SH, 9510, 9510SH, 9550, 9560, 9560SH, 9560STS, 9570STS, 9600, 9610, 9650, 9650CTS, 9650STS, 9660, 9660CTS, 9660STS, 9670STS, 9750STS, 9760STS, 9770STS, 9860STS, CTS, CTS II, S550, S650, S660, S670 SN 745100-765252, S670HM, S680 SN 745100-785000, S680HM, S690, S690HM, S760, S770 ASN 1Z0S770XXX110000 and ASN 1H0S770XXX800001, S780, S785, S790	Bearing Flange, Elevator Head Shaft	AME10018	\$ 2.48	







Unloading Auger Housings and Components

Application	Description	Part Number	Retail Price	Core
 9400, 9410, 9450, 9500, 9510, 9550, 9600, 9610, 9650CTS, 9650	Sump Housing	AMAH140713	\$ 1071.00	
 9560STS, 9570STS, 9650STS, 9660STS, 9670STS, 9750STS, 9760STS, S550, S650, S660 BSN 765172	Sump Housing Standard Capacity Replaces AH167618, AH206835, AXE12437	AMAH215720	\$ 1390.00	
9400, 9410, 9450, 9500, 9510, 9510SH, 9550 BSN 695200, 9550SH BSN 695700, 9600, 9610, 9650 BSN 695300, 9650CTS BSN 695400, CTS, CTS II	Unloading Auger Elbow Ring Replaces H129550	AMH137227	\$ 512.04	
9670STS, 9770STS, 9860STS ASN 720688, 9870STS, S660, S670, S670HM, S680, S680HM, S690, S690HM, S760, S780, S785, S790	Unloading Auger Retainer, Lubeless	AMH217909	\$ 36.66	
 9000 Series	Panel Patch	AMX2710105	\$ 53.00	
 9400, 9410, 9450, 9500, 9510, 9510SH, 9550, 9550SH, 9560, 9560SH, 9560STS, 9570STS, 9600, 9610, 9650, 9650CTS, 9650STS, 9660, 9660CTS, 9660STS, 9670STS (Standard Rate), 9750STS, 9760STS, 9770STS (Standard Rate), S550, S650, CTS, CTS II	Horizontal Unloading Auger Gearbox Replaces DE19067	AMAH208345	\$ 842.00	
 9400, 9410, 9450, 9500, 9510, 9550, 9560STS, 9600, 9610, 9650, 9650CTS, 9650STS, 9660, 9660STS, 9660CTS, 9670STS, 9750STS, 9760STS, 9770STS, 9860STS	Reman Vertical Unloading Gearbox, Lower	AMX27287	\$ 995.00	\$ 250.00
 9400, 9410, 9500, 9500SH, 9510, 9510SH, 9550, 9550SH, 9560, 9560SH, 9560STS, 9570STS, 9600, 9610, 9650, 9650CTS, 9650STS, 9660, 9660CTS, 9660STS, 9670STS, 9750STS, 9760STS, 9770STS, 9860STS, 9870STS, CTS, CTS II, S550, S650, S660, S670, S670HM, S680HM, S690HM, S760, S770, S780 ASN 1Z0S780XXX110000, S785, S790 ASN 1Z0S790XXX110000	Vertical Unloading Auger Gearbox Housing	AMH130137	\$ 672.09	
 6620, 7720, 8820, 9400, 9410, 9450, 9500, 9500SH, 9510, 9510SH, 9550, 9550SH, 9560, 9560SH, 9560STS, 9570STS, 9650STS, 9660, 9660CTS, 9660STS, 9670STS, 9750STS, 9760STS, 9770STS, 9870STS, CTS, CTS II	Ball Bearing, Vertical Auger Lower Gearbox	AMAH96585	\$ 14.00	

John Deere®—Combine

	Application	Description	Part Number	Retail Price	Core
	(9660STS, 9670STS, 9770STS - High Unloading Rate), 9760STS, 9860STS, 9870STS, S660, S670, S670HM, S680, S680HM, S690, S690HM, S760, S770, S780, S790	Horizontal Unloading Auger Gearbox	AMDE19353	\$ 1199.00	
	9660STS, 9670STS, 9760STS, 9770STS, 9860STS, 9870STS, S660, S670, S680, S690	Reman Unloading Auger Gearbox	AMDE19353-R	\$ 975.00	\$ 250.00
	6620, 7720, 8820	Horizontal Auger Gearbox Shaft, Lower 14" Long Replaces H98044, H113052	AMH135232	\$ 146.59	
	S680, S690, S770, S780, S785, S790	Horizontal Unloading Auger Shaft	AMCE21382	\$ 220.00	
	6620, 6622, 7720, 7721, 8820, 9400, 9410, 9450, 9500, 9500SH Late, 9501 Late, 9510, 9510SH Late, 9550, 9550SH, 9560, 9560SH, 9560STS, 9570STS, 9600, 9610, 9650, 9650STS, 9650CTS, 9660, 9660CTS, 9660STS, 9670STS, 9750STS, 9760STS, 9770STS, 9860STS, 9870STS, CTS, CTS II	Vertical Auger Drive Shaft Replaces H96169	AMH215085	\$ 95.00	
	9400, 9410, 9450, 9500, 9500SH, 9510, 9510SH, 9550, 9550SH, 9560, 9560SH, 9560STS, 9570STS, 9600, 9610, 9650, 9650CTS, 9650STS, 9660, 9660CTS, 9660STS, 9670STS, 9750STS, 9760STS, 9770STS, 9860STS, 9870STS, CTS, CTS II	Vertical Auger Drive Shaft	AMH129653	\$ 120.00	
	S550, S660, S670, S680, S690, S760, S770, S780, S790	Vertical Auger Drive Shaft Splined Replaces HXE17135	AMCE31099	\$ 184.00	
	S680, S690, S780, S790	Vertical Unloading Auger Drive Shaft, Lower	AMCE21376	\$ 145.00	
	6620, 7720, 8820, 9400, 9410, 9500, 9500SH, 9510, 9510SH, 9600, 9610, CTS, CTS II	Bevel Gear 18 Tooth, 19 Spline, 5.50" Long Replaces H96148 For Unloading Auger Gearbox	AMH149869	\$ 104.00	
	4400 ASN 151501, 4420, 6600 ASN 156501, 6620, 6622 ASN 610401, 7700 ASN 163901, 7701, 7720, 7721, 8820	Gear 17 Tooth, 1.002" ID For Loading Auger	AMH86912	\$ 60.00	
	6620, 6622, 7720, 7721, 8820, 9400, 9410, 9450, 9500, 9500SH, 9510, 9510SH, 9550, 9550SH, 9560, 9560SH, 9560STS, 9570STS, 9600, 9610, 9650, 9650CTS, 9650STS, 9660, 9660CTS, 9660STS, 9670STS, 9750STS, 9760STS, 9770STS, 9860STS, 9870STS, CTS, CTS II	Gear For Vertical Loading Auger	AMH96294	\$ 158.00	
	6620, 7720, 8820, 9400, 9410, 9450, 9500, 9500SH, 9510, 9510SH, 9550, 9550SH, 9560, 9560SH, 9560STS, 9570STS, 9600, 9610, 9650, 9650CTS, 9660, 9660CTS, 9660STS, (9670STS, 9770STS - Standard Unload Rate), 9760STS, CTS, CTS II	Bearing Set, Horizontal Unloading Auger Gearbox	AMAH94661	\$ 39.00	

John Deere®—Combine

	Application	Description	Part Number	Retail Price	Core
	9400, 9410, 9450, 9500, 9500SH, 9510, 9510SH, 9550, 9550SH, 9560, 9560SH, 9560STS, 9570STS, 9600, 9610, 9650, 9650CTS, 9660, 9660CTS, 9660STS, 9670STS, 9760STS, 9770STS, CTS, CTS II, S550, S650, S660 SN 745001-764171	Seal, Single Lip 0.25" Wide, 1.75" ID, 2.378" OD	AMAH98118	\$ 9.00	
	9400, 9410, 9500, 9500SH, 9510, 9510SH, 9550, 9550SH, 9560, 9560SH, 9560STS, 9600, 9610, 9650, 9650CTS, 9650STS, 9660, 9660CTS, 9660STS, 9750STS, 9760STS, 9770STS, CTS, CTS II	Vertical Auger Lower Gearbox Sprocket 46 Tooth, 1.502" Bore	AMAH125080	\$ 88.00	
	(9400, 9410, 9500, 9500SH, 9510, 9510SH, 9550, 9550SH, 9560, 9560SH, 9600, 9610, 9650, 9650CTS, 9650STS BSN 692273, 9660, 9660CTS, 9750STS BSN 691545, CTS ASN 660432, CTS II - Slow Speed or Rice), (9660STS, 9760STS, 9770STS - High Unload Rate), (9860STS, 9870STS - Regular Speed)	Vertical Auger Lower Gearbox Sprocket 40 Tooth, 2.677" Long, 1.502" Bore Diameter For Size 60 Chain	AMAH146352	\$ 76.22	
	9400, 9410, 9450, 9500, 9500SH, 9501, 9510, 9510SH, 9550, 9550SH, 9560, 9560SH, 9560STS, 9600, 9610, 9650, 9650CTS, 9650STS, 9660, 9660CTS, 9660STS, 9750STS, 9760STS, 9780CTS ASN 072800, 9860STS, C670, CTS, CTS II, T550, T560, T660, T670	Unloading Auger Countershaft Drive Sprocket 19 Tooth, 1.819" Long, 1.381" Bore For Size 60 Chain	AMAH128075	\$ 84.09	
	S550, S650, S660 BSN 765172 - w/ 2.20 BPS Unloader Drive	Unloading Auger Drive Sprocket 46 Tooth	AMHXE37870	\$ 102.00	
	9400, 9410, 9450, 9500, 9500SH, 9510, 9510SH, 9550, 9550SH, 9560, 9560SH, 9560STS, 9570STS, 9600, 9610, 9640, 9650, CTS, CTS II	Pinion Shaft Set of 2 17 Tooth, 19 Spline, 5.73" Long For Horizontal Unloading Auger Gearbox Replaces AH94661, AH98118, DE18970	AMDE31419	\$ 212.00	
	9400, 9410, 9450, 9500, 9510, 9510SH, 9550, 9550SH, 9560, 9560SH, 9560STS, 9600, 9610, 9650, 9650CTS, 9650STS, 9660CTS, 9660STS, 9670STS, 9750STS, 9760STS, 9770STS, CTS, CTS II	Pinion Shaft 17 Tooth, 19 Spline, 5.73" Long	AMCE18278	\$ 182.94	
	9670STS, 9770STS, 9860STS, 9870STS, (S660, S670, S680, S690 SN 745100-785000)	Pinion Shaft	AMCE18776	\$ 145.00	
	6620, 7720, 8820, 9400, 9410, 9450, 9500, 9510, 9510SH, 9550, 9550SH, 9560, 9560SH, 9560STS, 9570STS, 9600, 9610, 9650, 9650CTS, 9650STS, 9660, 9660CTS, 9660STS, 9670STS, 9750STS, 9760STS, 9770STS, 9860STS, CTS, CTS II, S550, S650, S660 BSN 765172	Unloading Auger Gearbox Bushing 1.26" ID, 1.625" OD, 1.13" Wide	AMN72989	\$ 11.69	
	6620 BSN 610300, 7720 BSN 610500 w/ 14' Auger Systems, 8820 BSN 610700, (9400, 9450 - w/ 17' Auger System), (9410, 9510, 9510SH, 9550, 9550SH, 9600, 9610 - w/ 17' or 20' 2-Piece Auger Systems), 9500, 9500SH, (9560, 9560SH - w/ 18.50' or 21.50' Auger Systems), 9560STS, 9650, 9650CTS, 9660CTS, (9660STS, 9760STS - Hi-Rate), CTS, CTS II, S550, S650 SN 745100-764999	Splined Coupling	AMH116292	\$ 30.00	

John Deere®—Combine

Application	Description	Part Number	Retail Price	Core
 6620, 7720, 8820, 9400, 9410, 9450, 9500, 9500SH, 9510, 9510SH, 9550, 9560, 9560SH, 9560STS, 9570STS, 9600, 9610, 9650, 9650CTS, 9650STS, 9660, 9660CTS, 9660STS, 9670STS, 9750STS, 9760STS, 9770STS, CTS, CTS II, S550, S650, S660, S670, S670HM, S680HM, S690HM, S760, S770, S780, S785, S790	Seal 1.68" ID, 3.158" OD, 0.28" Wide For Vertical Unloading Gearbox Shaft	AMAH90963	\$ 16.00	

Clean Grain Elevator Boot and Door

Boot kits include outer and inner side boots, front and rear covers, deflector and non-perforated boot door. Kits also include nuts, bolts and washers to assemble the boot.



Application	Description	Part Number	Retail Price	Core
6600, 7700	Boot Complete w/ Solid Door	AMAH83511	\$ 178.89	
6620, 7720, 8820 BSN 464350	Boot Complete w/ Solid Door	AMAH93242	\$ 225.00	
8820 ASN 464351	Boot Complete w/ Solid Door	AMAH105854	\$ 233.90	
9400, 9500	Boot, 3-Bolt Mounting Complete w/ Solid Door	AMAH136484	\$ 525.00	
9400, 9410, 9500, 9510, CTS, CTS II	Boot, 4-Bolt Mounting Complete w/ Solid Door	AMAH149182	\$ 406.00	
9450, 9550, 9550SH, 9560, 9560SH, 9560STS, 9650, 9660, 9660STS, 9650CTS, 9660CTS, 9750STS, 9860STS	Boot	AMAH171008	\$ 357.00	
9570STS, 9670STS, S550, S650, S660, S670 BSN 765253, S760, S770 ASN 1ZOS770XXX110000	Boot Replaces AH222240	AMAXE66789	\$ 890.00	
9600	Boot, 3-Bolt Mounting Complete w/ Solid Door	AMAH136487	\$ 365.00	
9600, 9610	Boot, 4-Bolt Mounting Complete w/ Solid Door	AMAH149181	\$ 500.00	
9770STS, 9870STS, S670	Boot	AMAH219600	\$ 469.00	
9450, 9550, 9550SH, 9560, 9560SH, 9560STS, 9570STS, 9650, 9650STS, 9660, 9660STS, 9670STS, 9750STS, 9760STS, 9770STS, 9860STS, 9870STS, S550, S650, S660, S680, S680HM, S690, S690HM, S760, S770, S780, S790	Door Assembly, Perforated 27.53" Long, 10.938" Wide	AMAH154068	\$ 125.00	
6600, 6620, 7700, 7720, 8820 BSN 464350	Door	AMAH77062	\$ 46.50	
8820 ASN 464351	Door	AMAH105855	\$ 55.00	
9400, 9410, 9500, 9510	Door	AMAH129357	\$ 82.00	
9450, 9550, 9560, 9560STS, 9570STS, 9650, 9650CTS, 9650STS, 9660, 9660CTS, 9660STS, 9670STS, 9750STS, 9760STS, 9770STS, 9860STS, 9870STS, S550, S660, S670, S680, S690	Door	AMAH138426	\$ 71.00	
9600, 9610	Door	AMAH129358	\$ 61.00	
9450, 9550, 9550SH, 9560, 9560SH, 9560STS, 9570STS, 9650, 9650CTS, 9650STS, 9660, 9660CTS, 9660STS, 9670STS, 9750STS, 9760STS, 9860STS, S550, S650, S660, S760	Bearing w/ Collar, Lower Clean Grain Elevator Boot	AMJD10384	\$ 22.00	
6600 ASN 105801, 7700 ASN 111901	Roller Chain, Clean Grain Elevator Drive 58 Links, Size 50 Chain	AMAH87147	\$ 80.00	

John Deere®—Combine

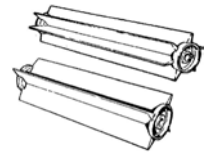

Beaters and Components

Heavy-duty, balanced 4- and 6-wing backbeaters increase stripping action and help prevent backfeeding over the top of the cylinder. Both styles of beaters are welded assemblies and made of heavy-duty, abrasive-resistant steel.

Application	Description	Part Number	Retail Price	Core
7720, 7721	Beater, 1 1/2" Shaft	6 Wing AMAH146170	\$ 975.02	
8820	Beater, 1 1/2" Shaft	6 Wing AMAH146149	\$ 1431.81	
9400, 9500	Beater, 1 1/2" Shaft	8 Wing AMLBJD9400-8	\$ 942.94	
9600, 9610, 9650, 9660CTS	Beater, 1 1/2" Shaft	8 Wing AMLBJD9600-8	\$ 947.47	
3300, 4400, 4420	Bearing Flange, Beater Shaft	AME10018	\$ 2.48	
6600 4 Wing ASN 008907 or 6 Wing, 7700 4 Wing ASN 005688 or 6 Wing	Ball Bearing Replaces H93944	AMJD10007	\$ 18.00	
6620, 7720, 8820, 9400, 9500, 9510, 9510SH, 9600	Idler Pulley, Beater Drive Replaces AH141762	AMAH111447	\$ 58.00	
(9400, 9410, 9450, 9500, 9510, 9550 - 4 Required), (9600, 9650, 9660 - 5 Required)	Beater Curtain	AMH148305	\$ 11.89	
9400, 9410, 9450, 9500, 9500SH, 9501, 9510, 9510SH, 9550, 9550SH, 9560, 9560SH, T550, T560	Beater Blade Replaces H133649	AMH147789	\$ 87.00	
9400, 9410, 9450, 9500, 9500SH, 9510, 9510SH, 9550, 9550SH, 9560, 9560SH	Beater Shaft 61.31" Long	AMH126941	\$ 277.32	
9400, 9410, 9450, 9500, 9500SH, 9510, 9510SH, 9550, 9550SH, 9560, 9560SH, 9600, 9610, 9650, 9650CTS, 9660, 9660CTS, CTS, CTS II	Bearing Flange, Beater Shaft 3.15" Bore Diameter, 4.689" Bolt Circle Diameter	AMH113626	\$ 8.95	
	Bearing Flange, Beater Shaft	AMH113625	\$ 6.37	
9400, 9410, 9450, 9500, 9500SH, 9510, 9510SH, 9550, 9550SH, 9560, 9560SH, 9600, 9650, 9660	Beater Arm Tension Adjustment	AMAH131508	\$ 83.93	
	Beater Drive Hub	AMH128327	\$ 27.00	
9560STS, 9570STS, 9650STS, 9660STS, 9670STS, 9750STS, 9760STS, 9770STS, 9860STS, 9870STS, S550	Idler Pulley, Discharge Beater Drive 1.437" Overall Width, 7.992" Diameter, 0.637" Bore Diameter, 1" Groove Width Replaces AH85276, AH165366	AMAH97031	\$ 32.73	
9560STS, 9570STS, 9650STS, 9660STS, 9670STS, 9750STS, 9760STS, 9770STS, 9860STS, 9870STS, S550 SN 745100-764999, S650 ASN 765000, (S670, S680, S690 ASN 745100)	Front Wear Plate Smooth, Solid, Hardened	AMH166689	\$ 15.33	
9560STS, 9570STS, 9650STS, 9660STS, 9670STS, 9750STS, 9760STS, 9770STS, 9860STS, 9870STS, S550, S660, S670, S680, S690	Feed Accelerator Plate Serrated, Hardened	AMH165407	\$ 14.00	
9560STS, 9570STS, 9650STS, 9660STS, 9670STS, 9750STS, 9760STS, 9770STS, 9860STS, 9870STS, S650 ASN 765000, (S660, S670, S680, S690 ASN 745100)	Front Wear Plate Hardened Angle Serrated	AMH201914	\$ 23.12	
S560, S650, S660, S670, S680, S690, S760, S770, S780, S790	Wear Plate, Feed Accelerator	AMHXE111121	\$ 14.92	
9560STS, 9570STS, S550	Rear Beater Shaft 52.31" Long	AMH202622	\$ 356.47	
	Wear Strip, Discharge Beater	AMH202621	\$ 64.78	
9600, 9610, 9650, 9660	Beater Grate, Wide Body	AMAH151120	\$ 578.83	
	Beater Shaft 72.12" Long	AMH126940	\$ 354.97	
	Beater Blade	AMH147788	\$ 110.00	
9650CTS	Double Idler Pulley, Beater Drive 3.25" Wide, 8" OD, 0.50" Bore Diameter Replaces AH87119	AMAH93318	\$ 61.45	
9650CTS, 9660CTS, 9780CTS, CTS, CTS II	Beater Shaft 66.25" Long	AMH146326	\$ 455.12	
9650STS, 9660STS, 9670STS, 9750STS, 9760STS, 9770STS, 9860STS, 9870STS	Beater Shaft, Rear Discharge 65" Long	AMH161010	\$ 379.72	
	Beater Wing Support	AMH166181	\$ 89.00	

Prices Subject to Change without Prior Notice. The use of original equipment manufacturer (OEM) part numbers or trademarks, e.g. Case® and John Deere®, are for reference purposes only and for indicating product use and compatibility. Our company and the listed replacement parts contained herein are not sponsored, approved or manufactured by the OEM. All parts are New unless designated Reman in the description.

John Deere®—Combine

Application	Description	Part Number	Retail Price	Core
9650STS, 9660STS, 9670STS, 9750STS, 9760STS, 9770STS, 9860STS, 9870STS, S650 ASN 765000, (S660, S670, S690 ASN 745100), S680 HillMaster BSN 765000, S690 HillMaster SN 745101-765000	Backup Strip	AMH165408	\$ 19.00	
9650STS, 9660STS, 9670STS, 9750STS, 9760STS, 9770STS, 9860STS, 9870STS, S650, S660, S670, S680, S690, S760, S770, S780, S785, S790	Front Feed Accelerator Shaft 63.69" Long	AMH158386	\$ 348.38	
9650STS, 9660STS, 9670STS, 9750STS, 9760STS, 9860STS, 9870STS, S650 ASN 750000, (S660, S670, S680, S690, ASN 745100), S680HM BSN 765000, S690HM SN 745101-765000	Beater Wing Support Replaces H166383	AMH221379	\$ 92.00	
9650STS, 9660STS, 9750STS, 9760STS, 9860STS	Rear Beater Fin Discharge Beater Wear Plate, Serrated	AMH209762	\$ 46.00	
9660STS, (9670STS, 9770STS BSN 730200), 9760STS, 9860STS	Wear Strip, Discharge Beater (10) Required Replaces H221355	AMH236279	\$ 40.00	
9670STS, 9770STS, S650, S660, S670, S670HM	Discharge Beater Blade Support	AMH236283	\$ 97.00	
(9670STS, 9770STS ASN 730201), S650 ASN 765000, (S660, S670 ASN 745100)	Wear Strip (10) Required	AMH236284	\$ 33.00	
S670 BSN 785001	Idler Pulley, Overshot Beater Drive 1.437" Overall Width, 7.992" Diameter, 0.637" Bore Diameter, 1" Groove Width Replaces AH85276, AH165366	AMAH97031	\$ 32.73	



Unloading Auger Swing Cylinders

Application	Description	Part Number	Retail Price	Core
(6620, 7720, 7721, 8820 BSN 600000), 6622 BSN 610400	Unloading Auger Swing Cylinder Kit Eyelet Style	AMX27187	\$ 750.00	
(6620, 7720, 7721, 8820 ASN 600001), 9400 BSN 650100, 9500 BSN 650200, 9600 BSN 650300, CTS	Unloading Auger Swing Cylinder Kit Block Style	AMX27186	\$ 600.00	
	Components:			
	Cylinder 1	AMAH132210	\$ 525.00	
	Cylinder End 1	AMH137225	\$ 55.00	
	Nut 1	AMW13288	\$ 2.25	
9400 ASN 650101, 9410, 9450 BSN 695100, 9500 ASN 656569, 9510, 9510SH, 9550, 9550SH, 9600, 9610, 9650 BSN 695300, 9650CTS BSN 695400, CTS, CTS II	Unloading Auger Swing Cylinder Replaces AH145030, AH166484	AMAH176383	\$ 463.00	
9450, 9550, 9550SH, 9560, 9560SH, 9650, 9650CTS, 9660, 9660CTS	Unloading Auger Swing Cylinder	AMAH176381	\$ 520.00	
9560STS, 9570STS, 9650STS ASN 695501, 9660STS, (9670STS, 9770STS, 9870STS BSN 735100), 9750STS ASN 695601, 9760STS, 9860STS	Unloading Auger Swing Cylinder Replaces AH176274	AMAH176382	\$ 520.00	
(9670STS, 9770STS, 9870STS ASN 735101)	Unloading Auger Swing Cylinder	AMAH236427	\$ 480.00	
S550 SN 745100-764999, S650 ASN 765000, S660 SN 745100-785000	Unloading Auger Swing Cylinder	AMAH10669	\$ 520.00	
(S650 BSN 785001, S660, S670 w/ Grain Tank Doors Excluding 26' System, S670HM, S760 Excluding 26' and 28.50' Systems, S770 Excluding 26' and 28.50' Systems - w/ High Unload Rate), S680*, S690*, (S680HM, S690HM - w/ 22' System w/ or w/o Grain Tank Doors), (S780, S790 - w/ 22.50' System w/ or w/o Grain Tank Doors)	Unloading Auger Swing Cylinder	AMAH10618	\$ 520.00	
*Will fit S680 and S690 if they fit the following criteria: - BSN 785001 w/ 22' System w/ or w/o Grain Tank Doors - SN 775001-785000 w/ 26' System w/ Grain Tank Doors - ASN 766006 w/ 22.50' System w/ or w/o Grain Tank Doors				

John Deere®—Combine

Augers & Components—Lower Clean Grain

All augers are made with continuous roll-formed fighting for accuracy and durability.



Application	Description	Part Number	Retail Price	Core
4400, 4420	Lower Clean Grain Auger 63" Long, 6" Right Hand Fighting, 1" Shaft Diameter	AMAH76772	\$ 197.29	
6600	Lower Clean Grain Auger Extended Wear, 70 1/4" Overall Length, Right Hand Fighting, 6 3/4" Fighting Diameter, 1 1/4" Shaft Diameter, 7 1/2" Pitch Bearing	AMAH91468 NPS100RPC	\$ 200.00 \$ 7.00	
6620	Lower Clean Grain Auger Extended Wear, 70 1/4" Overall Length, Right Hand Fighting, 6 3/4" Fighting Diameter, 1 1/4" Shaft Diameter, 7 1/2" Pitch Bearing - (2) Required	AMAH91283 SA207-20	\$ 221.00 \$ 14.40	
7700	Lower Clean Grain Auger Extended Wear, 83" Long Bearing	AMAH91469 NPS100RPC	\$ 334.84 \$ 7.00	
7720	Lower Clean Grain Auger Extended Wear, 72" Overall Length, Right Hand Fighting, 6 3/4" Fighting Diameter, 1 1/4" Shaft Diameter, 7 1/2" Pitch Replaces AH91284 Bearing - (2) Required	AMAH107442 SA207-20	\$ 250.00 \$ 14.40	
8820 BSN 464351	Lower Clean Grain Auger Extended Wear, 84" Overall Length, Right Hand Fighting, 6 3/4" Fighting Diameter, 1 1/4" Shaft Diameter, 7 1/2" Pitch Replaces AH91285 Bearing - (2) Required	AMAH107400 SA207-20	\$ 268.00 \$ 14.40	
8820 ASN 464351	Lower Clean Grain Auger Extended Wear, 84" Overall Length, Right Hand Fighting, 6 3/4" Fighting Diameter, 1 1/4" Shaft Diameter, 7 1/2" Pitch For Wide Elevator Bearing - (2) Required	AMAH105856 SA207-20	\$ 270.00 \$ 14.40	
9400, 9500, 9410, 9510, CTS, CTS II	Lower Clean Grain Auger Extended Wear, 79 3/8" Overall Length, Right Hand Fighting, 8 1/2" Fighting Diameter, Shaft Diameter - 1.181" and 0.984", 6 1/2" Pitch Bearing	AMAH141577 SA206-30MMG	\$ 316.00 \$ 15.00	
9450, 9550 9550SH, 9560, 9560SH, 9650CTS, 9650STS, 9660CTS, 9660STS, 9670STS, 9750STS, 9760STS, 9770STS w/ Standard Load System, 9860STS, S660, S670 Regular Capacity SN 745100-765252, S760	Lower Clean Grain Auger Extended Wear, 82" Overall Length, Right Hand Fighting, 8 1/2" Fighting Diameter, Shaft Diameter - 1 3/8" and 1", 8 1/2" Pitch Bearing	AMAH162154 AMJD39102	\$ 488.00 \$ 11.00	
9560STS, 9570STS	Lower Clean Grain Auger Extended Wear, 71 1/4" Overall Length, Right Hand Fighting, 8 1/2" Fighting Diameter, Shaft Diameter - 1 3/8" and 1", 8 1/2" Pitch Bearing w/ Collar	AMAH218246 AMJD10384	\$ 378.00 \$ 22.00	
9600, 9610	Lower Clean Grain Auger Extended Wear, 78 1/4" Overall Length, Right Hand Fighting, 8 1/2" Fighting Diameter, Shaft Diameter - 1.181" and 1", 8 1/2" Pitch Replaces AH133374 Bearing	AMAH141576 SA206-30MMG	\$ 321.00 \$ 15.00	
9650W, 9660W	Lower Clean Grain Auger Extended Wear, 93" Overall Length, Right Hand Fighting, 8 1/2" Fighting Diameter, Shaft Diameter - 1 3/8" and 1", 8 1/2" Pitch Bearing w/ Collar	AMAH162153 AMJD10384	\$ 499.00 \$ 22.00	

John Deere®—Combine

Application	Description	Part Number	Retail Price	Core
9770STS, 9870STS, S670 High-Rate SN 745100-765252, S680	Lower Clean Grain Auger Extended Wear, 82 1/4" Overall Length, Right Hand Flighting, 9 1/2" Flighting Diameter, Shaft Diameter - 1.769" and 0.984", 9 1/2" Pitch Replaces AXE59539	AMAH219339	\$ 616.00	
	Bearing	AMJD39102	\$ 11.00	
6600, 7700, 7720, 8820	Lower Clean Grain Auger Cover	AMH77058	\$ 70.00	
6620, 7720, 8820	Clean Grain Auger Trough Door	AMH98488	\$ 168.00	
6620 Titan II	Clean Grain Auger Trough Door	AMH98486	\$ 100.00	
7720 Titan II, 8820 Titan II	Clean Grain Auger Trough Door	AMH98487	\$ 125.00	
9400, 9410, 9450, 9500, 9510, 9550, 9650STS, 9660STS, 9670STS, 9750STS, 9760STS, 9770STS, 9860STS, 9870STS	Clean Grain Auger Trough Door	AMAH139388	\$ 190.00	
9400, 9410, 9500, 9500SH, 9510, 9510SH, 9550, 9550SH, 9560, 9560SH, 9650STS, 9660CTS, 9660STS, 9670STS, 9750STS, 9760STS, 9770STS, 9860STS, 9870STS	Clean Grain Auger Trough Door, Perforated Replaces AH117281	AMAH139389	\$ 198.77	
9600, 9610, 9650, 9660	Clean Grain Auger Trough Door Solid w/ Protective Plate	AMAH139390	\$ 347.66	
9600, 9610, 9650W, 9660W	Clean Grain Auger Trough Door	AMAH139386	\$ 298.00	
9600, 9610, 9650, 9660	Lower Clean Grain Auger Trough Door Perforated	AMAH139387	\$ 263.08	
9400, 9410, 9450, 9500, 9510, 9510SH, 9550, 9550SH, 9560, 9560SH, 9650, 9650CTS, 9650STS, 9660CTS, 9660STS, 9670STS, 9750STS, 9760STS, 9770STS, 9860STS, CTS, CTS II	Lower Clean Grain Auger Door Solid w/ Protective Plate Replaces AH118251	AMAH139391	\$ 204.28	
9400, 9500, 9500SH, 9600 BSN 670301, CTS BSN 670401	Bearing Flange, Lower Clean Grain Auger	AME10018	\$ 2.48	
(S650, S660, S670 BSN 775001 and ASN 785000), S670HM, S680, S680HM, S690HM, S760, S770, S780, S790 ASN 1ZHOS790XXXX110000	Lower Clean Grain Auger Trough Door	AMAXE15954	\$ 395.00	

Unloading Auger Countershafts and Components



Application	Description	Part Number	Retail Price	Core
4400 ASN 110151, 4420	Unloading Auger Countershaft 64.66" Long	AMAH86633	\$ 200.53	
	Bearing	WPS100GPC	\$ 15.00	
6600*, 6602 *Can replace AH75330 on models BSN 14301 if you purchase 11H237 key and 14H874 Nut	Unloading Auger Countershaft 75.599" Long	AMAH86634	\$ 100.00	
	Bearing	WPS100GPC	\$ 15.00	
6620	Unloading Auger Countershaft 76" Long	AMAH130467	\$ 315.00	
	Bearing - (2) Required	AMJD9274	\$ 24.07	
7700* *Can replace AH75331 on models BSN 14301 if you purchase 11H237 key and 14H874 Nut	Unloading Auger Countershaft 85.412" Long	AMAH86635	\$ 145.00	
	Bearing	WPS100GPC	\$ 15.00	
7720	Unloading Auger Countershaft 86.88" Long	AMAH130468	\$ 297.07	
	Bearing - (2) Required	AMJD9274	\$ 24.07	
9400, 9410, 9500, 9510, 9510SH, 9600, 9610, CTS, CTS II	Unloading Auger Countershaft 14.38" Long	AMH133024	\$ 97.00	
	Bearing - (2) Required	AMJD39104	\$ 20.00	
9450, 9550, 9550SH, 9560, 9560SH, 9650, 9650CTS, 9660, 9660CTS	Unloading Auger Countershaft 14.38" Long	AMH164212	\$ 207.15	
	Bearing - (2) Required	AMJD39104	\$ 20.00	

John Deere®—Combine

Application	Description	Part Number	Retail Price	Core
9560STS, 9570STS, 9650STS, 9660STS, 9670STS, 9750STS, 9760STS, 9770STS, 9860STS, 9870STS	Unloader Drive Jackshaft 22.12" Long Replaces H208598, H212900, H219352	AMH219352	\$ 187.59	
	Bearing - (2) Required	AMJD39104	\$ 20.00	
9400, 9410, 9500, 9501, 9510, 9600, 9610, CTS, CTS II	Pulley 0.895" Wide, 17.50" OD, 4.504" Bore Diameter For Unloading Auger Countershaft Drive	AMAH106096	\$ 100.78	
9560STS, 9650STS, 9660STS, 9750STS, 9760STS, 9860STS	Unloading Auger Drive Pulley Hub Replaces H150846, H212687	AMH215595	\$ 114.74	
9560STS, 9570STS, 9650STS, 9660STS, 9670STS, 9750STS, 9760STS, 9770STS, 9860STS, 9870STS	Unloading Auger Sprocket Use w/ AMH215595 Unloader Drive Pulley Hub	AMAH215152	\$ 74.67	
9570STS, 9670STS, 9770STS, 9870STS	Unloading Auger Drive Pulley Hub	AMH223290	\$ 102.99	
9400, 9410, 9500, 9500SH, 9510, 9510SH, 9560, 9560SH, 9600, 9610, 9660, 9660CTS, CTS, CTS II	Unloading Auger Drive Hub, 4-Bolt 1.811" Long, 1.378" ID, 3.74" OD	AMH133026	\$ 41.80	
9400, 9410, 9500, 9500SH, 9510, 9510SH, 9600, 9610, CTS, CTS II	Unloading Auger Drive Hub 6.298" OD, 1.38" Bore Diameter	AMH133025	\$ 80.04	
6620, 7720, 8820	Bearing w/ Lock Collar, Unloading Auger Countershaft	AMJD9274	\$ 24.07	
6620, 7720	Bearing Flange, Unloading Auger Countershaft	AME10018	\$ 2.48	
9400 ASN 670636, 9410, 9450, 9500, 9500SH, 9510, 9510SH, 9550, 9550SH, 9560, 9560SH, 9560STS, 9600 ASN 671991, 9610, 9650, 9650CTS, 9650STS, 9660, 9660CTS, 9660STS, 9750STS, 9760STS, 9860STS, CTS ASN 670636, CTS II	Pressed Flanged Housing	AMH161529	\$ 3.15	

Augers & Components—Lower Return

All augers are made with continuous roll-formed fighting for accuracy and durability.



Application	Description	Part Number	Retail Price	Core
4400, 4420	Lower Return Auger 66 1/2" Long	AMAH76130	\$ 188.78	
	Bearing	NPS100RPC	\$ 7.00	
6600	Lower Return Auger 72 3/4" Overall Length, Left Hand Fighting, 4 1/2" Fighting Diameter, Shaft Diameter - 1"-8 UNC Thread and 1", 5" Pitch	AMAH75836	\$ 200.00	
	Bearing	NPS100RPC	\$ 7.00	
6620 BSN 610301	Lower Return Auger Extended Wear, 72 3/4" Long	AMAH93662	\$ 315.50	
	Bearing	NPS100RPC	\$ 7.00	
6620 ASN 610301, 6620 Titan II	Lower Return Auger 75 1/2" Overall Length, Left Hand Fighting, 4 3/4" Fighting Diameter, Shaft Diameter - 1 1/8"-7 UNC Thread and 1 1/4", 5 1/4" Pitch	AMAH122335	\$ 184.00	
	Bearing - (2) Required	SA207-20	\$ 14.40	
7700	Lower Return Auger 83" Long	AMAH76092	\$ 108.50	
	Bearing	NPS100RPC	\$ 7.00	
7720 BSN 610501	Lower Return Auger Extended Wear, 3 1/2" Overall Length, Left Hand Fighting, 4 3/4" Fighting Diameter, Shaft Diameter - 1 1/8"-7 UNC-2A Thread and 1", 5 1/4" Pitch	AMAH93663	\$ 226.00	
	Bearing	WPS100GPC	\$ 15.00	
	Bearing	SA207-20	\$ 14.40	

John Deere®—Combine

Application	Description	Part Number	Retail Price	Core
7720 ASN 610501, 7720 Titan II	Lower Return Auger 86 1/8" Overall Length, Left Hand Flighting, 4 3/4" Flighting Diameter, Shaft Diameter - 1 1/8"-7 UNC Thread and 1 1/4", 5 1/4" Pitch	AMAH122336	\$ 205.00	
	Bearing - (2) Required	SA207-20	\$ 14.40	
8820 BSN 610701	Lower Return Auger 97" Overall Length, Left Hand Flighting, 4 3/4" Flighting Diameter, Shaft Diameter - 1 1/8"-7 UNC Thread and 1 1/4", 5 1/4" Pitch	AMAH96279	\$ 257.00	
	Bearing - (2) Required	SA207-20	\$ 14.40	
9400, 9410, 9500, 9510, CTS	Lower Return Auger Extended Wear, 94 1/2" Overall Length, Left Hand Flighting, 5 1/4" Flighting Diameter, Shaft Diameter - 1.181" and 1.24"-M20X2.50" Spline, 5 1/4" Pitch	AMAH146322	\$ 241.00	
	Bearing - (2) Required	SA206-30MMG	\$ 15.00	
9560STS, 9570STS, S550 745100-764999	Lower Return Auger 61.312" Long, 0.375" Shaft Diameter, 6.50" Right Hand Flighting	AMAH202510	\$ 286.61	
	Bearing	AMJD39102	\$ 11.00	
	Bearing w/ Collar	AMJD10384	\$ 22.00	
9650STS, 9660STS, 9670STS, 9750STS, 9760STS, 9770STS, 9860STS, 9870STS, S650, S660, S670, S670HM, S760, S770	Lower Return Auger Extended Wear, 71 3/4" Overall Length, Right Hand Flighting, 6 1/2" Flighting Diameter, Shaft Diameter - 0.984" and 1.181", 7" Pitch	AMAH147472	\$ 214.00	
	Bearing	AMJD39102	\$ 11.00	
	Bearing w/ Collar	AMJD10384	\$ 22.00	
9600, 9610, 9650	Lower Return Auger 105 3/8" Overall Length, Left Hand Flighting, 5 1/4" Flighting Diameter, Shaft Diameter - 1.1811" and 1 1/4"-M20x2.50" Spline, 5 1/4" Pitch	AMAH146313	\$ 284.00	
	Bearing - (2) Required	SA206-30MMG	\$ 15.00	
S680, S680HM, S690, S690HM, S780, S790	Lower Return Auger, Right Hand	AMAH232830	\$ 415.00	
9650STS, 9750STS	Lower Return Auger Trough Replaces AH149399	AMAH201865	\$ 197.70	
3300, 4400, 4420, 6600, 6620, 7700, 7720	Return Auger Cover, Perforated	AMH75975	\$ 58.00	
6620 Titan II, 7720 Titan II, 8820 Titan II	Return Auger Cover, Solid	AMH118676	\$ 70.00	
8820	Return Auger Cover, Solid	AMH99488	\$ 75.00	
9400, 9410, 9450, 9500, 9510, 9550, 9600, 9610, 9650, 9660, 9650CTS, 9660CTS, CTS, CTS II	Return Auger Cover, Solid	AMH136054	\$ 38.07	
9400, 9410, 9450, 9500, 9500SH, 9510, 9510SH, 9550, 9550SH, 9560, 9560SH, 9650, 9660, 9660CTS, CTS, CTS II	Return Auger Cover, Perforated	AMH136055	\$ 61.63	
9400, 9410, 9450, 9500, 9500SH, 9501, 9510, 9510SH, 9550, 9550SH, 9560, 9560SH, 9560STS, 9600, 9610, 9650, 9650CTS, 9650STS, 9660, 9660CTS, CTS, CTS II	Upper & Lower Tailings Shaft	AMAH130570	\$ 55.00	
	Bearing - (2) Required	AMJD9313	\$ 11.00	
6620, 7720, 8820, 9400, 9410, 9450, 9500, 9500SH, 9510, 9510SH, 9550, 9550SH, 9560, 9560SH, 9600, 9610, 9650, 9650CTS, 9660, 9660CTS, CTS, CTS II	Lower Return Tightener Hub 6.56" OD, 1.129" Bore Diameter	AMH97574	\$ 56.00	
9400 ASN 640100, (9500, 9500SH ASN 640200), 9510, 9510SH, 9600 ASN 640300, 9610	Idler Pulley, Lower Tailings Auger Drive 1.437" Overall Width, 7.992" Diameter, 0.637" Bore Diameter, 1" Groove Width Replaces AH85276, AH165366	AMAH97031	\$ 32.73	
3300 ASN 150000, 4400 ASN 151500, 4420, 6600 ASN 000821, 6620, 7700 ASN 001100, 7720, 8820	Lower Tailings Auger Drive Spring	AMH82072	\$ 12.00	

John Deere®—Combine

Application	Description	Part Number	Retail Price	Core
9400, 9410, 9450, 9500, 9500SH, 9510, 9510SH, 9550, 9550SH, 9560, 9560SH, 9600, 9610, 9650, 9650CTS, 9660, 9660CTS, CTS, CTS II, S680, S680HM, S690, S690HM, S780, S785, S790	Bearing Flange, Lower Return Auger	AME10018	\$ 2.48	
6620 ASN 610301, 7720 ASN 610501, 8820	Roller Chain, Lower Return Auger Drive 41 Links, Size 50 Chain	AMAH141164	\$ 15.00	
9400, 9410, 9450, 9500, 9510, 9550, 9600, 9610, 9650, CTS	Roller Chain, Lower Return Elevator Drive 43 Links, Size 50 Chain	AMAH126239	\$ 17.00	

Augers & Components—Top Tailing Return

All augers are made with continuous roll-formed flighting for accuracy and durability.



Application	Description	Part Number	Retail Price	Core
3300, 4400, 4420	Upper Return Auger 34.125" Long, 0.875" Tube Diameter, 4" Right Hand Flighting	AMAH76573	\$ 178.96	
4400 ASN 151501, 4420, 6600 ASN 156501, 6620, 6622 ASN 610401, 7700 ASN 163901, 7701, 7720, 7721, 8820	Upper Tailing Return Auger, Left Hand 79.875" Long, 4.75" Right Hand Flighting	AMAH75436	\$ 277.52	
	Bearing w/ Locking Collar	AMJD8562	\$ 13.00	
6600, 6620 BSN 610301	Upper Tailing Return Auger 69" Long, 0.875" Tube Diameter, 4.75" Right Hand Flighting	AMAH75435	\$ 188.34	
	Bearing w/ Locking Collar	AMJD8562	\$ 13.00	
6620 ASN 610302	Upper Return Auger 69.562" Long	AMAH127650	\$ 316.22	
	Bearing w/ Locking Collar	AMJD8562	\$ 13.00	
7720 ASN 610502	Upper Return Auger 80.69" Long	AMAH127651	\$ 281.36	
	Bearing w/ Locking Collar	AMJD8562	\$ 13.00	
8820	Upper Return Auger 91.25" Long Replaces AH98031, AH117426, AH127652	AMAH127652	\$ 352.00	
	Bearing	WPS100GPC	\$ 15.00	
9400, 9410, 9450, 9500, 9500SH, 9510SH, 9550, 9550SH, 9560, 9560SH, 9650CTS, 9660CTS, CTS, CTS II	Upper Tailing Return Auger 63.062" Long	AMAH125895	\$ 200.00	
	Bearing - (2 Required)	AMJD39102	\$ 11.00	
9560STS, 9570STS	Upper Return Auger 25.69" Long, 0.983" Shaft Diameter, 5" Flighting Diameter, Left Hand Rotation	AMAH202519	\$ 179.40	
	Bearing - (2) Required	AMAH129451	\$ 17.00	
9570STS, 9650STS, 9660STS, 9670STS, 9750STS, 9760STS, 9770STS, 9860STS, S650, S660, S670, S680, S690, S760, S770	Upper Tailing Return Auger 28.25" Long, 5.75" Left Hand Flighting Replaces AH147529	AMAH209421	\$ 152.00	
	Bearing - (2) Required	AMAH168161	\$ 17.00	
9600, 9610, 9650, 9660	Upper Tailing Return Auger 57.75" Long	AMAH125894	\$ 193.00	
	Bearing - (2) Required	AMJD39102	\$ 11.00	
9400, 9410, 9450, 9500, 9510, 9510SH, 9550, 9550SH, 9560, 9560SH, 9660, 9660CTS, CTS, CTS II	Auger Tube Housing Replaces AH137291, AH137581, AH141572	AMAH149180	\$ 1091.56	
	Bearing - (2) Required	SA206-30MMG	\$ 15.00	
9400, 9410, 9450, 9500, 9500SH, 9501, 9510, 9510SH, 9550, 9550SH, 9560, 9560SH, 9560STS, 9600, 9610, 9650, 9650CTS, 9650STS, 9660, 9660CTS, CTS, CTS II	Upper & Lower Tailings Shaft	AMAH130570	\$ 55.00	

John Deere®—Combine

Application	Description	Part Number	Retail Price	Core
9400, 9410, 9450, 9500, 9500SH, 9501, 9510, 9510SH, 9550, 9550SH, 9560, 9560SH, 9560STS, 9600, 9610, 9650, 9650CTS, 9650STS, 9660, 9660CTS, 9670STS, 9770STS, 9860STS, 9870STS, CTS, CTS II, S550, S660, S670	Upper Tailing Return Drive Sprocket 30 Tooth	AMAH126008	\$ 34.50	
9560STS, 9570STS, 9660STS, 9670STS, 9750STS, 9760STS, 9770STS, 9860STS, 9870STS, S550 SN 745100-764999, S650 ASN 765000, (S660, S670 ASN 745100), S670HM BSN 765000, S680 SN 766007-785000, S690 SN 765250-785000	Upper Tailing Return Drive Sprocket 19 Tooth, 0.987" Bore	AMAH147557	\$ 30.00	
9400, 9410, 9450, 9500, 9500SH, 9510, 9510SH, 9550, 9550SH, 9600, 9610, 9650, 9650CTS, 9660, 9660CTS, 9780CTS ASN 072800, CTS, CTS II	Upper Tailing Return Auger Sprocket 22 Tooth, 0.987" Bore	AMAH121046	\$ 45.00	
9560STS, 9570STS, 9650STS, 9660STS, 9670STS, 9750STS, 9760STS, 9770STS, 9860STS, 9870STS, S550, (S650, S660, S670, S680, S690 BSN 785001), S670HM, S680HM, S690HM, S770	Ball Bearing, Upper Return Auger w/ Lock Collar 0.984" ID, 2.441" OD	AMAH129451	\$ 17.00	
9400, 9410, 9450, 9500, 9500SH, 9510, 9510SH, 9550, 9550SH, 9560, 9560SH, 9560STS, 9570STS, 9600, 9610, 9650, 9650STS, 9660, 9660CTS, 9660STS, 9750STS, 9760STS, 9860STS, CTS, CTS II, S550, S650, S660, S670, 670HM, S680 SN 766007-785000, S690 SN 765250-785000, S760, S770	Bearing Flange, Upper Return Auger	AME10018	\$ 2.48	
6620, 7720, 8820	Roller Chain, Upper Return Auger Drive 52 Links, Size 50 Chain	AMAH141163	\$ 16.00	
9400, 9410, 9450, 9500, 9510, 9550, 9600, 9610, 9650, CTS	Roller Chain, Upper Return Auger Drive 124 Links, Size 50 Chain	AMAH126007	\$ 36.00	

Augers—Grain Bin Loading

All augers are made with continuous roll-formed flighting for accuracy and durability.



Application	Description	Part Number	Retail Price	Core
6600 ASN 156501	Grain Bin Loading Auger Extended Wear, 66 1/2" Overall Length, Left Hand Flighting, 7" Flighting Diameter, 1" Shaft Diameter, 8" Pitch	AMAH90624	\$ 285.00	
	Bearing	WPS100GPC	\$ 15.00	
6620, 7700 ASN 163901	Grain Bin Loading Auger Extended Wear, Single Flight Auger, 72" Overall Length, Left Hand Flighting, 7" Flighting Diameter, Shaft Diameter - 1" and 1 1/2", 8" Pitch	AMAH127728	\$ 260.00	
	Bearing	WPS100GPC	\$ 15.00	
7720	Grain Bin Loading Auger Extended Wear, Double Flight Auger, 75" Overall Length, Left Hand Flighting, 7 3/4" Flighting Diameter, 1" Shaft Diameter, 8 1/2" Pitch	AMAH127729	\$ 338.00	
	Bearing	WPS100GPC	\$ 15.00	
8820	Grain Bin Loading Auger Extended Wear, Double Flight Auger, 76 3/4" Overall Length, Left Hand Flighting, 7 3/4" Flighting Diameter, 1" Shaft Diameter, 8 1/2" Pitch Replaces AH98032, AH106608, AH108171, AH113813	AMAH127730	\$ 326.00	
	Bearing	WPS100GPC	\$ 15.00	
9400 BSN 640101, 9500 BSN 641201	Grain Bin Loading Auger Extended Wear, 48 3/16" Overall Length, Right Hand Flighting, 7 1/4" Flighting Diameter, Shaft Diameter - M12-1.75MM Internal Spline, 7 1/4" Pitch	AMAH136091	\$ 289.00	
	Bearing	SA206-19G	\$ 12.35	





John Deere®—Combine

Application	Description	Part Number	Retail Price	Core
9400 ASN 640101, 9410, 9500 ASN 641201, 9510, 9550, CTS, CTS II	Grain Bin Loading Auger Extended Wear, 50 7/16" Overall Length, Right Hand Flighting, 8 1/4" Flighting Diameter, Shaft Diameter - M12-1.75MM Internal Spline, 8 1/4" Pitch	AMAH136635	\$ 407.00	
	Bearing	SA206-19G	\$ 12.35	
9400, 9410, 9500, 9500SH, 9510, 9510SH, CTS, CTS II	Grain Bin Loading Auger - Upper Extended Wear, Upper Half of 2-Piece Fold Down Grain Bin Loading Auger 28 1/2" Overall Length, Right Hand Flighting, 8 1/4" Flighting Diameter, Shaft Diameter - M12-1.75MM Internal Spline, 8 1/4" Pitch	AMAH146509	\$ 263.00	
	Grain Bin Loading Auger - Lower Extended Wear, Lower Half of 2-Piece Fold Down Grain Bin Loading Auger 23 15/16" Overall Length, Right Hand Flighting 8 1/4" Flighting Diameter, Shaft Diameter - 1.249"-M24x3.00" Internal Spline, 8 1/4" Pitch	AMAH146214	\$ 394.00	
	Bearing - 1 per auger	SA206-19G	\$ 12.35	
9450, 9550, 9550SH, 9560, 9560SH, 9650, 9650CTS, 9650STS, 9660, 9660CTS, 9660STS, 9670STS, 9750STS, 9760STS, 9860STS, S650 BSN 785001, (S660, S670 BSN 765253, S760 BSN 805001 - Regular Capacity)	Grain Bin Loading Auger Extended Wear-Sectional, 56 5/8" Overall Length, Right Hand Flighting, 10" Flighting Diameter, 1.181" Shaft Diameter, 9 1/2" Pitch Replaces AH154330, AH204566, AH205897	AMAH218485	\$ 560.00	
	Bearing w/ Collar	AMJD10384	\$ 22.00	
9450, 9550, 9650, 9650CTS, 9650STS, 9660CTS, 9660STS, 9750STS, 9760STS	Grain Bin Loading Auger Extended Wear-Sectional, Abrasive Resistant, 52 1/8" Overall Length, Right Hand Flighting, 9 1/2" Flighting Diameter, M12-1.75MM Internal Spline Shaft Diameter, 9 1/2" Pitch w/o Bearing Support Replaces AH204563, AH205897	AMAH154330	\$ 552.00	
	Bearing	SA206-19G	\$ 12.35	
9560STS	Grain Bin Loading Auger When replacing the early original auger, AMJD10384 Bearing is required	AMAH205605	\$ 473.00	
	Bearing	SA206-19G	\$ 12.35	
9560STS, 9570STS	Grain Bin Loading Auger 51.875" Long When replacing the early original auger, AMJD10384 Bearing is required	AMAH223220	\$ 624.51	
	Bearing w/ Collar	AMJD10384	\$ 22.00	
9600 BSN 640301	Grain Bin Loading Auger Extended Wear, 57 5/8" Overall Length, Right Hand Flighting, 8 1/4" Flighting Diameter, Shaft Diameter - M12-1.75MM Internal Spline, 8 1/4" Pitch	AMAH136092	\$ 336.00	
	Bearing	SA206-19G	\$ 12.35	
9600 ASN 640301, 9610	Grain Bin Loading Auger Extended Wear, 57 5/8" Overall Length, Right Hand Flighting, 9 1/4" Flighting Diameter, Shaft Diameter - M12-1.75MM Internal Spline, 9 1/4" Pitch	AMAH136636	\$ 338.00	
	Bearing	SA206-19G	\$ 12.35	









John Deere®—Combine

Application	Description	Part Number	Retail Price	Core
9600, 9610	Grain Bin Loading Auger - Upper Extended Wear, 37 1/8" Overall Length, Right Hand Flighting, 9 1/4" Flighting Diameter, M12-1.75MM Internal Spline Shaft Diameter, 9 1/4" Pitch Upper Half of 2-Piece Fold Down Grain Bin Loading Auger	AMAH146553	\$ 245.00	
	Grain Bin Loading Auger - Lower Extended Wear, 30 1/8" Overall Length, Right Hand Flighting, 9 1/4" Flighting Diameter, Shaft Diameter - 1.62" and 24 Internal Spline, 9 1/4" Pitch Lower Half of 2-Piece Fold Down Grain Bin Loading Auger	AMAH146215	\$ 402.00	
	Bearing - 1 per auger	SA206-19G	\$ 12.35	
9770STS, 9870STS, (S670, S760 ASN 785000, S770 - High Capacity)	Grain Bin Loading Auger Extended Wear-Sectional, 57 1/8" Overall Length, Right Hand Flighting, 11" Flighting Diameter, 1.181" Shaft Diameter, 10 1/2" Pitch Replaces AH218258	AMAH230013	\$ 704.00	
	Bearing w/ Collar	AMJD10384	\$ 22.00	
S660, S670, S670HM, S680HM, S690HM, S760, S770	Grain Bin Loading Auger 300 Bushel Power Fold Replaces AXE69564	AMAXE13122	\$ 604.00	
	Bearing w/ Collar	AMJD10384	\$ 22.00	
S670 BSN 765253, S680, S690, S780, S790	Grain Bin Loading Auger 400 Bushel Power Fold and Manual Fold 64" Long, 11" Flighting Replaces AXE69563	AMAH233419	\$ 729.00	
	Bearing w/ Collar	AMJD10384	\$ 22.00	
S670, S680, S690, S780, S790 - w/ 12" Diameter Auger Tube	Auger Liner 12-Gauge Steel, 53 1/4" Long	AMX29179	\$ 535.00	
9550, 9560STS, 9570STS, 9650, 9650STS, 9660, 9660STS, 9670STS, 9750STS, 9760STS, 9860STS, S650, S660, S670 - w/ 11" Diameter Auger Tube	Incline Auger Liner Repair Sleeve 12-Gauge Steel Includes Bolt Kit	AMX29114	\$ 546.00	
(9770STS, 9870STS, 9880STS, S670, S680, S690, S760, S770, S780 - w/ 12" Diameter Auger Tube)	Incline Auger Liner Repair Sleeve	AMX29167	\$ 550.00	

Auger Tubes—Grain Bin Loading



Application	Description	Part Number	Retail Price	Core
 6600 BSN 156501 w/ U-Joint Auger Drive	Grain Bin Loading Auger Tube	AMAH75997	\$ 275.72	
 6620, 7700 ASN 163901	Grain Bin Loading Auger Tube	AMAH88982	\$ 230.00	
 7700 BSN 163901 w/ U-Joint Auger Drive	Grain Bin Loading Auger Tube Replaces AH75997	AMAH77064	\$ 257.00	
 7720, 8820	Grain Bin Loading Auger Tube	AMAH98300	\$ 262.00	
 9400 BSN 640100, 9500 BSN 640200	Grain Bin Loading Auger Tube 23.25" Long, 8.75" ID	AMAH131903	\$ 131.00	

John Deere®—Combine

	Application	Description	Part Number	Retail Price	Core
	9400 ASN 640101, 9500 ASN 640201, 9410, 9510, CTS, CTS II	Grain Bin Loading Auger Tube 22.125" Long	AMAH135444	\$ 134.00	
		Grain Bin Loading Auger Tube Stainless Steel	AMAH135445	\$ 280.00	
		Auger Tube Support, Upper	AMAH135439	\$ 70.00	
	9600 BSN 640300	Grain Bin Loading Auger Tube	AMAH131907	\$ 177.17	
	9600 ASN 640301, 9610	Grain Bin Loading Auger Tube 28.25" Long 10.25" ID	AMAH135563	\$ 154.00	
		Auger Tube Support, Upper	AMAH135558	\$ 53.00	
	9450, 9550, 9560, 9650, 9650CTS, 9660, 9660CTS	Grain Bin Loading Auger Tube, Stainless Steel	AMAH211160	\$ 765.00	
	9560STS, 9570STS, S550	Grain Bin Loading Auger Tube, Stainless Steel	AMAH219095	\$ 763.02	
	9650STS, 9660STS, 9670STS, 9750STS, 9760STS, 9860STS, (S650, S670, S760 BSN 785001), S660	Grain Bin Loading Auger Tube, Stainless Steel High Wear w/o Pressure Flow Compensated Option Replaces AH219094	AMAH219093	\$ 607.00	
	9650STS, 9660STS, 9670STS, 9750STS, 9760STS, 9860STS, S650, (S660, S670 - w/ Standard Auger)	Grain Bin Loading Auger Tube Regular Wear	AMAH219094	\$ 495.00	
	9770STS, 9870STS	Grain Bin Loading Auger Tube High Wear	AMAH217983	\$ 650.00	
	(S660, S670 BSN 785001 w/ Power Fold or All w/ Pressure Flow Compensated), (S670HM, S680HM, S690HM - w/ Power Fold), (S760 BSN 1H0S760XXX805001 & BSN 1Z0S760XXX115000, S770 BSN 1H0S770XXX805001, S780 BSN 1Z0S780XXX115000, S785 BSN 1Z0S785XXX115000, S790 BSN 1Z0S785XXX115000 - w/ Pressure Flow Compensated)	Grain Bin Loading Auger Tube 300 Bushel	AMAXE56593	\$ 2125.00	
	S670	Grain Bin Loading Auger Tube Manual Fold	AMAXE12747	\$ 1152.00	
	S680, S690, (S780, S790 BSN 1H0S780XXX805001 & BSN 1Z0S780XXX115000), S785 BSN 1Z0S785XXX115000	Grain Bin Loading Auger Tube 400 Bushel Power Fold Replaces AH233412	AMAXE56594	\$ 2076.00	
	S680, S690, S780, S790	Grain Bin Loading Auger Tube 400 Bushel Manual Fold Replaces AXE21395	AMAXE56595	\$ 1725.00	

Prices Subject to Change without Prior Notice. The use of original equipment manufacturer (OEM) part numbers or trademarks, e.g. Case® and John Deere®, are for reference purposes only and for indicating product use and compatibility. Our company and the listed replacement parts contained herein are not sponsored, approved or manufactured by the OEM. All parts are New unless designated Reman in the description.

John Deere®—Combine

Application	Description	Part Number	Retail Price	Core
 9400, 9410, 9450, 9500, 9500SH, 9510, 9510SH, 9550, 9550SH, 9560, 9560SH, 9560STS, 9570STS, 9600, 9610, 9650, 9650CTS, 9650STS, 9660, 9660CTS, 9660STS, 9670STS, 9750STS, 9760STS, 9770STS, 9860STS, 9870STS, CTS, CTS II	Grain Bin Loading Auger Driver 1.067" ID	AMH136186	\$ 56.00	
 9450, 9550, 9550SH, 9560, 9560SH, 9560STS, 9570STS, 9650, 9650CTS, 9650STS, 9660, 9660CTS, 9660STS, 9670STS, 9750STS, 9760STS, 9770STS, 9860STS, 9870STS, S550, S650, S660, S670, S670HM, S680, S680HM, S690, S690HM, S760, S770, S780, S790	Bearing w/ Collar, Grain Bin Loading Auger	AMJD10384	\$ 22.00	

Augers—Distribution



All augers are made with continuous roll-formed flighting for accuracy and durability.



Application	Description	Part Number	Retail Price	Core
6600, 6620, 7700, 7720, 8820	Distribution Auger 152 1/4" Overall Length, Right Hand and Left Hand Flighting, 4 5/8" Flighting Diameter, Shaft Diameter - 1" and 1 11/16", 5 1/4" Pitch	Right Hand AMAH95943	\$ 263.00	
	Distribution Auger 152 1/4" Overall Length, Right Hand and Left Hand Flighting, 4 5/8" Flighting Diameter, Shaft Diameter - 1" and 1 11/16", 5 1/4" Pitch	Left Hand AMAH95944	\$ 289.00	
	Bearing - (1) Required per Auger	WPS100GPC	\$ 15.00	
9400, 9500, 9600, 9410, 9510, 9610, CTS, CTS II	Distribution Auger 57 1/2" Overall Length, Right Hand Flighting, 5" Flighting Diameter, 1" Shaft Diameter, 5" Pitch Replaces AH169021	Right Hand AMAH130424	\$ 140.00	
	Distribution Auger 57 1/2" Overall Length, Left Hand Flighting, 5" Flighting Diameter, 1" Shaft Diameter, 5" Pitch	Left Hand AMAH130425	\$ 150.00	
	Bearing - (1) Required per Auger	WPS100GPC	\$ 15.00	
9560STS, 9570STS, 9650STS, 9660STS, 9670STS, 9750STS, 9760STS, 9770STS, 9860STS, 9870STS, S550, S660, S670, S680, S690, S760, S770, S780, S790	Distribution Auger Extended Wear, 40 3/4" Overall Length, 6" Flighting Diameter, 1" Shaft Diameter, 6" Pitch	Right Hand AMAH146787	\$ 102.00	
	Distribution Auger Extended Wear, 40 3/4" Overall Length, 6" Flighting Diameter, 1" Shaft Diameter, 6" Pitch	Left Hand AMAH146786	\$ 124.00	
9650STS, (9660STS, 9760STS BSN 711033), 9750STS, 9860STS BSN 710834	Rear Ball Bearing 2.047" ID, 1" OD Includes Lock Collar	AMAH159863	\$ 30.00	
9560STS, 9570STS, (9660STS, 9760STS ASN 711032), 9670STS, 9770STS, 9860STS ASN 710834, S650, S660, S670, S670HM, S680HM, S690, S690HM, S760, S770, S780, S785, S790	Bearing with Housing, Cleaning Shoe Auger 1" ID	AMAH163056	\$ 24.00	

John Deere®—Combine

Distribution Auger Wood Block Bearing Set

Application	Description	Part Number	Retail Price	Core
 All Models 6600 to 8820	Distribution Auger Wood Block Bearing Set	AMH84838	\$ 12.00	
 9400, 9410, 9450, 9500, 9500SH, 9501, 9510, 9510SH, 9550, 9550SH, 9560, 9560SH, 9600, 9610, 9650, 9650CTS, 9660, 9660CTS, C670, CTS, CTS II, T550, T560, T660, T670	Distribution Auger Wood Block Bearing Set Hardware Not Included	AMH135475	\$ 4.60	
 9400, 9500, 9600, 9410, 9510, 9610, CTS, CTS II	Distribution Auger Wood Block Bearing Set	AMH142188	\$ 6.00	

Distribution Auger Pans and Components



Application	Description	Part Number	Retail Price	Core
6620	Auger Pan, Front	AMAH131234	\$ 964.16	
7720	Auger Pan, Front	AMAH131235	\$ 945.00	
8820	Auger Pan, Front	AMAH131236	\$ 825.00	
9400, 9410, 9500, 9450, 9510, 9550, 9560, 9660CTS, CTS, CTS II	Distribution Pan	AMAH146655	\$ 892.94	
9600, 9610, 9650, 9660	Distribution Pan	AMAH146564	\$ 996.04	
(9660STS, 9760STS ASN 711032), 9670STS, 9770STS, 9860STS, 9870STS, S650 ASN 785000, S660, S670, S670HM, S680, S680HM, S690, S690HM, S760, S770, S780, S790	Distribution Pan Replaces AH218425	AMAXE62534	\$ 783.00	
9400, 9500, 9560, 9600, 9660	Auger Bed Liner, Shoe Supply Pan Stainless Steel	AMX29155	\$ 188.00	
9560STS, 9570STS, S550	Shoe Auger Drive Shaft 54" Long Replaces HXE119428	AMH202378	\$ 187.18	
3300, 4400, 4420, 6600, 6601, 6602, 6620, 6622, 7700, 7701, 7720, 7721, 8820, 9400, 9410, 9450, 9500, 9500SH, 9510, 9510SH, 9550, CTS, CTS II	Bevel Gear Replaces H75406	AMH137215	\$ 21.00	
9560STS, 9570STS, 9650STS, 9660STS, 9670STS, 9750STS, 9760STS, 9770STS, 9860STS, 9870STS, S650, S660, S670, S670HM, S680, S680HM, S690, S690HM, S760, S770, S780, S790	Bevel Gear, Conveyor Auger 13 Tooth Use w/ AMH171186 Drive Shaft Replaces H174745	AMH211285	\$ 32.00	

Auger Supply Shafts

Application	Description	Part Number	Retail Price	Core
4400, 4420	Auger Supply Shaft Replaces H77259	45.375" Long AMH83083	\$ 86.11	
6600, 6601, 6602, 6620	Auger Supply Shaft	52.025" Long AMH84498	\$ 95.00	
7700, 7701, 7720, 7721	Auger Supply Shaft	62.25" Long AMH84499	\$ 80.00	
8820	Auger Supply Shaft	73.75" Long AMH99635	\$ 141.86	
9400, 9410, 9450, 9500, 9500SH, 9510, 9510SH, 9550, 9550SH, 9560, 9560SH, 9650CTS, 9660CTS, CTS, CTS II	Auger Supply Shaft	65.44" Long AMH135422	\$ 195.00	
9600, 9610, 9650, 9660	Drive Shaft, Shoe Grain Supply	76.25" Long AMH135421	\$ 224.00	
9650STS, 9660STS, 9670STS, 9750STS, 9760STS, 9770STS, 9860STS, 9870STS, S650, S660, S670, S670HM, S680, S680HM, S690, S690HM, S760, S770, S780, S785, S790	Drive Shaft, Cleaning Shoe Replaces HXE116497	64.62" Long AMH171186	\$ 189.00	

Prices Subject to Change without Prior Notice. The use of original equipment manufacturer (OEM) part numbers or trademarks, e.g. Case® and John Deere®, are for reference purposes only and for indicating product use and compatibility. Our company and the listed replacement parts contained herein are not sponsored, approved or manufactured by the OEM. All parts are New unless designated Reman in the description.

John Deere®—Combine

Application	Description	Part Number	Retail Price	Core
9870STS, S650, (S660, S670, S680, S690 BSN 785001), S670HM, S680HM, S690HM	Drive Shaft, Cleaning Shoe Replaces H234556	67.69" Long AMH226032	\$ 218.74	
9400, 9410, 9450, 9500, 9500SH, 9510, 9510SH, 9550, 9550SH, 9560, 9560SH, 9560STS, 9600, 9610, 9650, 9650CTS, 9660, CTS, CTS II	Ball Bearing, Auger Supply Shaft w/ Lock Collar 0.984" ID, 2.441" OD	AMAH129451	\$ 17.00	
9560STS, 9650STS, 9660STS, 9750STS, 9760STS, 9860STS	Ball Bearing, Auger Supply Shaft	AMAH168161	\$ 17.00	
9570STS, 9670STS, 9770STS, 9870STS, S550, (S650, S660, S670, S680 BSN 785001), S670HM, S680HM, S690, S690HM	Ball Bearing, Auger Supply Shaft 3.346" ID, 5.118" OD	AMAH125975	\$ 40.00	
9400, 9410, 9450, 9500, 9500SH, 9510, 9510SH, 9550, 9550SH, 9560, 9560SH, 9560STS, 9570STS, 9600, 9610, 9650, 9650CTS, 9650STS, 9660, 9660CTS, 9660STS, 9670STS, 9750STS, 9760STS, 9860STS, CTS, CTS II, S550, (S650, S660, S670, S680, S690 SN 745100-785000), S670HM, S680HM, S690HM	Bearing Flange, Auger Supply Shaft	AME10018	\$ 2.48	

Augers—Bottom Bin Cross

All augers are made with continuous roll-formed fighting for accuracy and durability.



Application	Description	Part Number	Retail Price	Core
6600	Bottom Bin Cross Auger Extended Wear Bearing	AMLABB6600 AM160796C91	\$ 700.00 \$ 13.00	
6620	Front Bottom Bin Cross Auger Extended Wear, 102 1/8" Overall Length, Left Hand Fighting, 7 1/2" Fighting Diameter, 1 1/2" Shaft Diameter, 4 1/2" Pitch Bearing - (2) Required	AMAH98211 SA208-24	\$ 457.00 \$ 21.00	
6620 BSN 600000	Rear Bottom Bin Cross Auger Extended Wear, 89 1/2" Overall Length, Left Hand Fighting, 7 1/2" Fighting Diameter, 1 1/2" Shaft Diameter, 4.50" Pitch Bearing - (2) Required	AMAH103727 SA208-24	\$ 462.00 \$ 21.00	
6620 ASN 600001	Rear Bottom Bin Cross Auger	AMAH114715	\$ 499.41	
7700	Bottom Bin Cross Auger Extended Wear Bearing	AMLABB7700 AM160796C91	\$ 599.00 \$ 13.00	
7720	Front Bottom Bin Cross Auger Extended Wear, 112 3/4" Overall Length, Left Hand Fighting, 7 1/2" Fighting Diameter, 1 1/2" Shaft Diameter, 4 1/2" Pitch Bearing - (2) Required	AMAH98212 SA208-24	\$ 520.00 \$ 21.00	
7720 BSN 600000	Bottom Bin Cross Auger Extended Wear, 100 1/2" Overall Length, Left Hand Fighting, 7 1/2" Fighting Diameter, 1 1/2" Shaft Diameter, 4.50" Pitch	AMAH103728	\$ 478.00	
7720 ASN 600001	Rear Bottom Bin Cross Auger 100.375" Long	AMAH114716	\$ 497.22	
8820	Front Bottom Bin Cross Auger Extended Wear, 123 5/8" Overall Length, Left Hand Fighting, 7 1/2" Fighting Diameter, 1 1/2" Shaft Diameter, 4.50" Pitch Bearing - (2) Required	AMAH107393 SA208-24	\$ 462.00 \$ 21.00	
8820 BSN 600000	Rear Bottom Bin Cross Auger Extended Wear, 111 3/8" Overall Length, Left Hand Fighting, 7 1/2" Fighting Diameter, 1 1/2" Shaft Diameter, 4.50" Pitch Bearing - (2) Required	AMAH103729 SA208-24	\$ 551.00 \$ 21.00	
8820 ASN 600001	Rear Bottom Bin Cross Auger	AMAH114717	\$ 530.11	

John Deere®—Combine

Application	Description	Part Number	Retail Price	Core
9400, 9410, 9450, 9500, 9510, 9510SH, 9550, 9550SH, 9560, 9560SH, 9560STS, 9570STS, 9650CTS, 9650STS, 9660CTS, 9660STS, 9670STS, 9750STS, 9760STS, CTS, CTS II, S550, S650, S660 BSN 765172	Front Bottom Bin Cross Auger Regular Unloading Rate 112 7/16" Overall Length, Right Hand Flighting, 7 1/4" Flighting Diameter, 1 3/8" Shaft Diameter, 2" Tube Diameter, 9" Pitch Replaces AH125645, AH138398, AH154965, AH167847, AH201744	AMAXE18077	\$ 530.00	
	Rear Bottom Bin Cross Auger Regular Unloading Rate 112 7/16" Overall Length, Left Hand Flighting, 7 1/4" Flighting Diameter, 1 3/8" Shaft Diameter, 2" Tube Diameter, 9" Pitch Replaces AH125966, AH138399, AH154966, AH167848, AH201743	AMAXE18078	\$ 562.00	
	Bearing - (2) Required	AMJD39104	\$ 20.00	
9600, 9610, 9650, 9660	Front Bottom Bin Cross Auger Extended Wear-Sectional, Right Hand Flighting 123 5/16" Overall Length, 7 1/4" Flighting Diameter, 1 3/8" Shaft Diameter, 9" Pitch Replaces AH127975, AH138396, AH154697, AH167849	AMAH202875	\$ 536.00	
	Rear Bottom Bin Cross Auger Extended Wear-Sectional, Left Hand Flighting 123 5/16" Overall Length, 7 1/4" Flighting Diameter, 1 3/8" Shaft Diameter, 9" Pitch Replaces AH127976, AH138397, AH154968, AH167850	AMAH202881	\$ 519.00	
	Bearing - (2) Required	AMJD39104	\$ 20.00	
9660STS, (9670STS, 9760STS, 9770STS - High-Rate), 9860STS, 9870STS, S660, S670, S670HM, S680, S680HM, S690, S690HM, S760, S770, S780, S785, S790	Front Bottom Bin Cross Auger Extended Wear-Sectional, Right Hand Flighting 112 3/4" Overall Length, 9 1/2" Flighting Diameter, 1 3/8" Shaft Diameter, 11" Pitch Replaces AXE18081	AMAH202958	\$ 782.00	
	Rear Bottom Bin Cross Auger Extended Wear-Sectional, Left Hand Flighting 112 3/4" Overall Length, 9 1/2" Flighting Diameter, 1 3/8" Shaft Diameter, 11" Pitch Replaces AXE18082	AMAH202959	\$ 725.00	
	Bearing - (2) Required	AMJD39104	\$ 20.00	
9400, 9410, 9450, 9500, 9500SH, 9510, 9510SH, 9550, 9550SH, 9560, 9560SH, 9560STS, 9600, 9610, 9650, 9650CTS, 9650STS, 9660, 9660CTS, 9660STS, 9670STS, 9750STS, CTS, CTS II	Sprocket, Slow Down Rate Front or Rear Bottom Bin Cross Augers 60 Tooth, 1.575" Long, 1.381" Bore Diameter For Size 60 Chain	AMAH140001	\$ 105.00	
9400, 9410, 9450, 9500, 9500SH, 9510, 9510SH, 9550, 9550SH, 9560, 9560SH, 9560STS, 9570STS, 9600, 9610, 9650, 9650CTS, 9650STS, 9660, 9660CTS, 9660STS, 9670STS, 9750STS, 9760STS, CTS, CTS II	Sprocket, Front or Rear Bottom Bin Cross Augers 49 Tooth, 1.575" Overall Length, 1.381" Bore Diameter For Size 60 Chain Replaces AH126705	AMAH125070	\$ 94.33	
9660STS, 9670STS, 9760STS, 9770STS, 9860STS, 9870STS	Sprocket, High-Rate Front or Rear Bottom Bin Cross Augers 60 Tooth, 1.575" Long, 1.381" Bore Diameter For Size 60 Chain	AMAH140001	\$ 105.00	
S550, S650	Sprocket, 2.20 BPS Unloader Drive 49 Tooth, 1.575" Overall Length, 1.381" Bore Diameter For Size 60 Chain Replaces AH126705	AMAH125070	\$ 94.33	
S660, S670, S670HM, S680HM, S690HM, S760, S770	Sprocket, 3.30 and 3.80 BPS Unloader Drive 60 Tooth, 1.575" Long, 1.381" Bore Diameter For Size 60 Chain	AMAH140001	\$ 105.00	
6620, 7720, 7721, 7722, 8820	Roller Chain, Cross Auger Drive, Rear 104 Links, Size 50 Chain	AMAH87248	\$ 30.00	
6620, 7720, 7722, 8820	Roller Chain, Cross Auger Drive 109 Links, Size 60 Chain	AMAH97021	\$ 35.00	

Prices Subject to Change without Prior Notice. The use of original equipment manufacturer (OEM) part numbers or trademarks, e.g. Case® and John Deere®, are for reference purposes only and for indicating product use and compatibility. Our company and the listed replacement parts contained herein are not sponsored, approved or manufactured by the OEM. All parts are New unless designated Reman in the description.

John Deere®—Combine

Application	Description	Part Number	Retail Price	Core
9400, 9410, 9500, 9500SH, 9510, 9510SH, 9600, 9610, CTS, CTS II	Roller Chain, Cross Auger Drive 204 Links, 0.75" Pitch, Size 60H Chain For Slow Down Speed, Rice Replaces AH140004	AMAH146359	\$ 75.00	

Augers & Tubes—Vertical Unloading

All augers are made with continuous roll-formed fighting for accuracy and durability.



Application	Description	Part Number	Retail Price	Core
6620, 7720, 8820	Vertical Unloading Auger Extended Wear, Double Flight Auger 64 1/2" Overall Length, Left Hand Fighting, 13" Fighting Diameter, Shaft Diameter - 1 1/4"-19 Internal Spline and 1 3/4"-13 Internal Spline, 9" Pitch	AMAH123929	\$ 488.00	
9400, 9410, 9450 BSN 695101, 9500, 9500SH, 9510, 9510SH, 9550 BSN 695201, 9550SH BSN 695701, 9600, 9610, 9650 BSN 695301, 9650CTS BSN 695401, CTS, CTS II	Vertical Unloading Auger Extended Wear 43 7/16" Overall Length, Left Hand Fighting, 13" Fighting Diameter, Shaft Diameter - 1 1/4"-19 Internal Spline and 1 3/4"-13 Internal Spline, 9" Pitch Replaces AH171554	AMAH124852	\$ 482.00	
9450 ASN 695100, 9550 ASN 695200, 9550SH ASN 695700, 9560, 9560SH, 9650 ASN 695300, 9650CTS ASN 695400, 9660, 9660CTS	Vertical Unloading Auger Extended Wear, 40 1/2" Overall Length, Left Hand Fighting, 13" Fighting Diameter, Shaft Diameter - 1 1/4"-19 Internal Spline and 1 3/4"-13 Internal Spline, 9" Pitch	AMAH171550	\$ 448.00	
9560STS, 9650STS, (9660STS, 9760STS - w/ Standard Rate Unload), 9750STS	Vertical Unloading Auger Extended Wear, Double Flight Auger 30 4/2" Overall Length, Left Hand Fighting, 13" Fighting Diameter, Shaft Diameter - 1 1/4"-19 Internal Spline and 1 3/4"-13 Internal Spline, 9" Pitch	AMAH146840	\$ 455.00	
(9660STS, 9670STS, 9760STS - High Unloading Rate), 9770STS, 9860STS, 9870STS	Vertical Unloading Auger Extended Wear-Sectional 32" Overall Length, Left Hand Fighting, 15 1/4" Fighting Diameter, Shaft Diameter - 4 1/4"-25 Internal Spline and 1 3/4"-13 Internal Spline, 10 3/4" Pitch Replaces AXE12921	AMAH202956	\$ 883.00	
S550, S650, S660 BSN 765172 - w/ High Wear 1.90 and 2.20 BPS Unloading Systems	Vertical Unloading Auger 31.06" Long, Left Hand Fighting, 13" Fighting Diameter, 4.50" Tube Diameter Replaces AXE17156	AMAXE53849	\$ 900.04	
S660 (High-Rate), S670, S670HM, S680, S680HM, S690, S690HM, S760, S770, S780, S790	Vertical Unloading Auger Extended Wear-Sectional 32 1/4" Overall Length, Left Hand Fighting, 15 1/4" Fighting Diameter, Shaft Diameter - 4.063"-25 Internal Spline and 4.063"-20 Internal Spline, 10 1/2" Pitch	AMAXE18070	\$ 791.00	
9400, 9410, 9450, 9500, 9500SH, 9510, 9510SH, 9550, 9550SH, 9600, 9610, 9650, 9650STS, 9660, 9660CTS, 9660STS, 9750STS, 9760STS, 9860STS, CTS, CTS II	Vertical Unloading Auger Clean Out Spout	AMAH167433	\$ 122.97	
S550 SN 745100-764999, S650 ASN 765000, (S660, S670, S680, S690 ASN 745100), S670HM BSN 765000, S680HM BSN 765000, S690HM SN 745101-76500, S760, S770, S780, S785, S790, T550, T560, T670	Auger Gear Set, Vertical Unloading Includes (2) 23 Tooth Gears	AMDE20711	\$ 337.00	
9400, 9410, 9450, 9510, 9510SH, 9550, 9550SH, 9560, 9560SH, 9600, 9610, 9650, 9650CTS, 9660, 9660CTS, CTS, CTS II	Splined Coupler, Vertical Unloading Auger Lower	AMAH124878	\$ 104.00	
S550, S650, S660 BSN 765172	Roller Chain, 2.20 BPS Unloader Drive 258 Links, Size 60H Chain	AMAH144891	\$ 115.00	
S660 ASN 765171, S670, S670HM, S680HM, S690HM, S760, S770	Roller Chain, 3.30 and 3.80 BPS Unloader Drive 264 Links, Size 60H Chain Replaces AH161460, AH202176	AMAXE53952	\$ 125.00	

John Deere®—Combine

Application	Description	Part Number	Retail Price	Core
9560STS, 9570STS, 9650STS, 9660STS, 9670STS, 9750STS, 9760STS, 9770STS	Roller Chain, Standard Rate Unloader Drive 258 Links, Size 60H Chain	AMAH144891	\$ 115.00	
9560STS, 9570STS, 9650STS, 9660STS, 9670STS, 9750STS, 9760STS, 9770STS, 9860STS, 9870STS	Roller Chain, High Rate Unloader Drive Slow Down Speed 264 Links, Size 60H Chain Replaces AH161460, AH202176	AMAXE53952	\$ 125.00	
3300, 4400, 4420, 6600, 6602, 7700	Roller Chain, Unloading Auger Drive 122 Links, Size 50 Chain	AMAH141170	\$ 30.00	
9400, 9410	Roller Chain, Unloading Auger Drive 198 Links, Size 60 Chain	AMAH126836	\$ 60.00	
9400, 9410, 9500, 9500SH, 9510, 9510SH, 9600, 9610, CTS, CTS II	Roller Chain, Unloading Auger Drive 204 Links, 0.75" Pitch, Size 60H Chain For Slow Down Speed, Rice Replaces AH140004	AMAH146359	\$ 75.00	
9550, 9550SH, 9560, 9560SH, 9650, 9650CTS, 9660, 9660CTS	Roller Chain, Unloading Auger Drive 196 Links, 0.75" Pitch, Size 60H Chain For Regular Speed	AMAH157083	\$ 80.00	
9450, 9550, 9550SH, 9560, 9560SH, 9650, 9650CTS, 9660, 9660CTS	Roller Chain, Unloading Auger Drive 200 Links, 0.75" Pitch, Size 60H Chain Slow Speed, Rice	AMAH157084	\$ 75.00	
(9500, 9500SH - w/ 6076 Engine), 9510, 9510SH, 9600, 9610, CTS, CTS II	Roller Chain, Unloading Auger Drive 198 Links, 0.75" Pitch, Size 60H Chain For Regular Speed	AMAH126837	\$ 80.00	
S680, S690, S780, S790	Roller Chain, Unloading Auger Drive 197 Links, Size 80 Chain	AMAXE15956	\$ 150.00	
6620, 6622, 7720, 7721, 7722, 8820	Roller Chain, Vertical Auger Drive 132 Links, Size 60 Chain	AMAH141166	\$ 40.00	

Augers & Tubes—Horizontal Unloading

All augers are made with continuous roll-formed flighting for accuracy and durability.



Application	Description	Part Number	Retail Price	Core
6600, 7700	Horizontal Unloading Auger Extended Wear	144" AMAH99394	\$ 553.00	
	Bearing	NPS100RPC	\$ 7.00	
6620, 7720, 8820	Horizontal Unloading Auger Tube (Outer)	144" AMAH145049	\$ 725.00	
	Horizontal Unloading Auger Extended Wear, Left Hand Flighting, 11 1/2" Flighting Diameter, Shaft Diameter - 1" and 1 1/4"-19 Internal Spline, 13" Pitch For 14' System Replaces AH97026, AH112451, AH116107, AH123436, AH132032	166 1/4" AMAH143731	\$ 707.00	
	Bearing	NPS100RPC	\$ 7.00	
	Horizontal Unloading Auger Tube (Outer)	180" AMAH145050	\$ 852.00	
	Horizontal Unloading Auger Extended Wear, Left Hand Flighting, 11 1/2" Flighting Diameter, Shaft Diameter - 1" and 1 1/4"-19 Internal Spline, 13" Pitch For 17' System Replaces AH96555, AH113501, AH116108, AH123437, AH132033	202 1/4" AMAH143729	\$ 825.00	
	Bearing	NPS100RPC	\$ 7.00	

John Deere®—Combine

Application	Description	Part Number	Retail Price	Core
9400, 9410, 9500, 9510, 9600, 9610	Horizontal Unloading Auger Tube (Outer)	144" AMAH145049	\$ 725.00	
	Horizontal Unloading Auger (Outer) Extended Wear, Left Hand Flighting, 11 1/2" Flighting Diameter, Shaft Diameter - 1" and 1 1/4"-19 Internal Spline, 13" Pitch For 14' Single Auger System Replaces AH97026, AH112451, AH116107, AH123436, AH132032	166 1/4" AMAH143731	\$ 707.00	
	Bearing	NPS100RPC	\$ 7.00	
	Horizontal Unloading Auger Tube (Outer)	180" AMAH145050	\$ 852.00	
7700 BSN 008001	Horizontal Unloading Auger (Outer) Extended Wear, Left Hand Flighting, 11 1/2" Flighting Diameter, Shaft Diameter - 1" and 1 1/4"-19 Internal Spline, 13" Pitch For 17' System Replaces AH96555, AH113501, AH116108, AH123437, AH132033	202 1/4" AMAH143729	\$ 825.00	
	Bearing	NPS100RPC	\$ 7.00	
	Horizontal Unloading Auger (Inner) Replaces AH76507	117.62" AMAH85410	\$ 685.05	
	Horizontal Unloading Auger Tube (Outer)	144" AMAH145049	\$ 725.00	
8820, 9400, 9410, 9450, 9500, 9500SH, 9510, 9510SH, 9550, 9550SH, 9600, 9610, 9650, 9650CTS, 9650STS BSN 690501, 9750STS BSN 690601, CTS, CTS II - w/ 2-Piece Auger	Horizontal Unloading Auger (In Elbow) Extended Wear, Left Hand Flighting, 11 7/8" Flighting Diameter, Shaft Diameter - 1 1/4"-19 Spline and 1 1/4"-19 Internal Spline, 13" Pitch	68 1/4" AMAH112435	\$ 509.00	
	Horizontal Unloading Auger (Outer) Extended Wear, Left Hand Flighting, 11 1/2" Flighting Diameter, Shaft Diameter - 1" and 1 1/4"-19 Internal Spline, 13" Pitch For 17' 2-Piece System	130.50" AMAH143727	\$ 568.00	
	Bearing	NPS100RPC	\$ 7.00	
	Horizontal Unloading Auger Tube (Outer)	180" AMAH145050	\$ 852.00	
	Horizontal Unloading Auger (In Elbow) Extended Wear, Left Hand Flighting, 11 7/8" Flighting Diameter, Shaft Diameter - 1 1/4"-19 Spline and 1 1/4"-19 Internal Spline, 13" Pitch	68 1/4" AMAH112435	\$ 509.00	
	Horizontal Unloading Auger (Outer) Extended Wear, Left Hand Flighting, 11 1/2" Flighting Diameter, Shaft Diameter - 1" and 1 1/4"-19 Internal Spline, 13" Pitch For 20' 2-Piece Auger System Replaces AH97026, AH112451, AH116107, AH123436, AH132032	166 1/4" AMAH143731	\$ 707.00	
	Horizontal Unloading Auger Tube (Outer)	144" AMAH210024	\$ 1195.00	
	Horizontal Unloading Auger (Outer) For 18.50' System	120" AMAH173593	\$ 1069.54	
	Horizontal Unloading Auger (In Elbow) Extended Wear, Left Hand Flighting, 11 7/8" Flighting Diameter, Shaft Diameter - 1 1/4"-19 Spline and 1 1/4"-19 Internal Spline, 13" Pitch	68 1/4" AMAH112435	\$ 509.00	
	Horizontal Unloading Auger Tube (Outer)	180" AMAH210023	\$ 1171.00	
9560STS	Horizontal Unloading Auger (Outer) Extended Wear, Left Hand Flighting, 11 1/2" Flighting Diameter, Shaft Diameter - 1" Hex Shaft and 1 1/4"-19 Internal Spline, 13" Pitch For 21.50' Systems	160 7/8" AMAH173595	\$ 793.00	
	Ball Bearing	AMJD9373	\$ 15.00	
	Unloading Auger Sheet	AMH211327	\$ 26.76	

John Deere®—Combine

Application	Description	Part Number	Retail Price	Core
9650STS ASN 690500, 9750STS ASN 690600	Horizontal Unloading Auger (In Elbow) Extended Wear, Left Hand Flighting, 11 7/8", Flighting Diameter, Shaft Diameter - 1 1/4" Hex x 1 1/4"-19 Spline and 1 1/4"-19 Internal Spline, 13° Pitch	83" AMAH169061	\$ 525.00	
	Ball Bearing	AMJD9373	\$ 15.00	
	Horizontal Unloading Auger Tube (Outer)	144" AMAH145049	\$ 725.00	
	Horizontal Unloading Auger (Outer) Extended Wear, Left Hand Flighting, 11 1/2" Flighting Diameter, Shaft Diameter - 1" and 1 1/4"-19 Internal Spline, 13° Pitch For 17' System	130.50" AMAH143727	\$ 568.00	
	Horizontal Unloading Auger (In Elbow) Extended Wear, Left Hand Flighting, 11 7/8", Flighting Diameter, Shaft Diameter - 1 1/4" Hex x 1 1/4"-19 Spline and 1 1/4"-19 Internal Spline, 13° Pitch	83" AMAH169061	\$ 525.00	
	Ball Bearing	AMJD9373	\$ 15.00	
	Horizontal Unloading Auger Tube (Outer)	180" AMAH145050	\$ 852.00	
	Horizontal Unloading Auger (Outer) Extended Wear, Left Hand Flighting, 11 1/2" Flighting Diameter, Shaft Diameter - 1" and 1 1/4"-19 Internal Spline, 13° Pitch For 20' System Replaces AH97026, AH112451, AH116107, AH123436, AH132032	166 1/4" AMAH143731	\$ 707.00	
9560, 9560STS, 9570STS, 9660CTS, S550, S650, S660	Horizontal Unloading Auger Tube (Outer)	144" AMAH210024	\$ 1195.00	
	Horizontal Unloading Auger (Outer) For 18.50' System	120" AMAH173593	\$ 1069.54	
	Horizontal Unloading Auger Tube (Outer)	180" AMAH210023	\$ 1171.00	
	Horizontal Unloading Auger (In Elbow) Extended Wear, Left Hand Flighting, 11 7/8" Flighting Diameter, Shaft Diameter - 1 1/4"-19 Spline and 1 1/4"-19 Internal Spline, 13° Pitch	68 1/4" AMAH112435	\$ 509.00	
	Horizontal Unloading Auger (Outer) Extended Wear, Left Hand Flighting, 11 1/2" Flighting Diameter, Shaft Diameter - 1" Hex Shaft and 1 1/4"-19 Internal Spline, 13° Pitch For 21.50' Systems	160 7/8" AMAH173595	\$ 793.00	
	Ball Bearing	AMJD9373	\$ 15.00	
	(9660STS, 9760STS, 9860STS - Hi-Rate), 9670STS, 9770STS, 9870STS, S660, S670, S680, S690	Horizontal Unloading Auger Tube (Outer)	184" AMAH203020	\$ 1473.00
Horizontal Unloading Auger (In Elbow) Extended Wear, Left Hand Flighting, 14" Flighting Diameter, Shaft Diameter - 1 1/4" Hex x 1 1/4"-19 Spline and 1 5/8"-25 Internal Spline, 16° Pitch		95 7/16" AMAH201797	\$ 798.00	
Ball Bearing		AMJD9373	\$ 15.00	
Horizontal Unloading Auger (Outer) Extended Wear, Left Hand Flighting, 15" Flighting Diameter, Shaft Diameter - 1 1/4" Hex Shaft and 1 1/4"-19 Internal Spline, 16° Pitch For 22.50' System		163 1/2" AMAH203021	\$ 1157.00	

John Deere®—Combine

Application	Description	Part Number	Retail Price	Core
9670STS, 9770STS, 9870STS, S660, S670, S680, S690	Horizontal Unloading Auger (Middle) Extended Wear, Left Hand Flighting, 15" Flighting Diameter, Shaft Diameter - 1 1/4" Hex Shaft and 1 1/4"-19 Internal Spline, 16" Pitch	95 7/15" AMAH234554	\$ 911.00	
	Horizontal Unloading Auger (Outer) Extended Wear-Sectional, Left Hand Flighting, 15" Flighting Diameter, Shaft Diameter - 1 1/4" Hex Shaft and 1 1/4"-19 Internal Spline, 16" Pitch	114 3/4" AMAH235525	\$ 1066.00	
	Horizontal Unloading Auger (In Elbow) Extended Wear, Left Hand Flighting, 14" Flighting Diameter, Shaft Diameter - 1 1/4" Hex x 1 1/4"-19 Spline and 1 5/8"-25 Internal Spline, 16" Pitch	95 7/16" AMAH201797	\$ 798.00	
	Auger Tube (Outer) For 26' or 7.9m Non-Folding Systems	112" AMAXE26714	\$ 1015.00	
	Ball Bearing	AMJD9373	\$ 15.00	
9560STS*, 9650STS, 9660STS, 9670STS, 9750STS, 9760STS, 9770STS, 9860STS*, 9880STS* *Requires (3) H217909 Retainers, (2) H217859 Wear Rings and H209009 Ring	Horizontal Unloading Auger Tube w/ Elbow (Inner) Ball Style Pivot 15" Tube Diameter	AMAH215721	\$ 2240.00	
9650STS, 9750STS, S650 ASN 765000	Horizontal Unloading Auger Tube (Inner)	AMAXE27514	\$ 2240.00	
9660STS, 9670STS, 9760STS, 9770STS, 9860STS, 9870STS, S660, S670, S680, S690	Horizontal Unloading Auger 15.25" Left Hand Flighting OD	60.50" AMAH211828	\$ 656.00	
	Ball Bearing	AMJD9373	\$ 15.00	
9660STS, 9670STS, 9760STS, 9770STS, 9860STS, 9870STS, S660 SN 765172-775001, S670 SN 765253-775001, S680 SN 766007-785001, S690 SN 765250-785001, S760 ASN 1ZOS760XXX110000 & 1JZOS760XXX110000, S770 ASN 1ZOS770XXX110000 & 1JZOS770XXX110000, (S780, S790 ASN 1ZOS770XXX110000)	Horizontal Unloading Auger Tube (Outer) 17" Diameter, 2-Piece Folding 22.50" High Rate System Replaces AH202040	AMAXE36427	\$ 850.00	
9670STS, 9770STS, 9870STS, S660, S670, S680, S690	Horizontal Unloading Auger (Inner) Extended Wear-Sectional, Left Hand Flighting, 15" Flighting Diameter, Shaft Diameter - 1 1/4" Hex Shaft and 1 1/4"-19 Internal Spline, 16" Pitch For 22.5' Folding System	100 9/16" AMAH226068	\$ 921.00	
	Ball Bearing	AMJD9373	\$ 15.00	
(S660, S670, S680, S690 ASN 775701), S760, S770, S780, S790	Horizontal Unloading Auger (Outer) For 28.50' System	AMAXE41770	\$ 1633.00	
	Ball Bearing	AMJD9373	\$ 15.00	
(S660, S670, S680, S690 ASN 775000), S760, S770, S780, S785, S790	Horizontal Unloading Auger Tube For 26' Non-Folding System Replaces AXE29044, AXE47450	112.25" AMAXE68700	\$ 1602.31	
	Horizontal Unloading Auger Tube For 28.50' System Replaces AXE25770, AXE47447	130.875" AMAXE68702	\$ 2820.00	
	Horizontal Unloading Auger Tube For 26' and 28.50' Non-Folding Systems Replaces AXE41983, AXE47451	93.375" AMAXE68701	\$ 1058.71	
(S760, S770 ASN 1ZOS760XXXX110000 & 1JZOS760XXXX110000), (S780, S790 ASN 1ZOS760XXXX110000)	Horizontal Unloading Auger Tube (Middle) For 22.50' Folding System	AMAXE38891	\$ 1920.00	
6620, 6622, (9400, 9600 ASN 651468), 9410, 9450, 9500, 9500SH, 9501, 9510, 9510SH, 9550, 9550SH, 9610, 9650, 9650CTS, 9650STS, 9750STS, CTS ASN 650418, CTS II	Rubber Spout	AMH149780	\$ 48.75	
9660STS, 9670STS, 9760STS, 9770STS, 9860STS, 9870STS, S660, S670, S680, S685, S690, S760, S770, S780, S785, S790	Rubber Spout	AMH208234	\$ 29.73	

John Deere®—Combine

Application	Description	Part Number	Retail Price	Core
(8820, 9400, 9410, 9450, 9500, 9500SH, 9510, 9510SH, 9550, 9550SH, 9560, 9560SH, 9560STS, 9570STS, 9600, 9610, 9650, 9650CTS, 9650STS, 9660, 9660CTS, 9660STS, 9670STS, 9750STS, 9760STS, 9770STS, 9860STS, 9870STS, CTS, CTS II - w/ 2-Piece System), S660, S670, S680, S690, S760, S770, S785, S790	Ball Bearing, Horizontal Unloading Auger 3.1496" OD, 1.25" Hex Bore Diameter Replaces 575883, 70575883, 86523785	AMJD9373	\$ 15.00	
3300, 4400, 4420, 6601, 6620, 6622, 7720, 7721, 8820, 9400, 9500, 9600, CTS, CTS II	Bearing Flange 2.047" (52 mm) OD	AMH103264	\$ 3.00	
9450, 9550, 9550SH, 9560, 9560SH, 9560STS, 9570STS, 9650, 9650CTS, 9650STS, 9660, 9660CTS, 9660STS, 9670STS, 9750STS, 9760STS, 9770STS, 9780CTS, 9860STS, 9870STS, S550, S650, S660, S670, S670HM, S680, S680HM, S690, S690HM, S760, S770, S780, S790	Unloader Elbow Pivot Bushing 2 Required	AMH202433	\$ 14.50	

Auger Extension Kits

These kits extend the length of your unloading auger approximately three feet and increase your clearance for larger platforms and grain carts. Includes spring-loaded grain saver. Replacement for OEM auger and tube. Pieces are sold separately, but must be used together.



Application	Description	Part Number	Retail Price	Core
6620, 7720, 8820, 9400, 9410, 9450, 9500, 9510, 9550, 9600, 9610, 9650, 9650CTS, 9650STS, 9750STS, CTS, CTS II - w/ 3.50" Auger Tube	Unloading Auger Extension Kit, 3' For 12" Diameter Auger	AMJD3EXT	\$ 811.00	
6620, 7720, 8820, 9400, 9410, 9500, 9510, 9550, 9600, 9610, 9650, 9650CTS, 9650STS, 9660CTS, 9660STS, 9670STS, 9750STS, 9760STS, 9770STS, CTS, CTS II	Snout For JD Extenders - Poly Auger Flighting, 36" Long Use on AMJD3EXT	AMJDEXT-PS AMX27500	\$ 145.00 \$ 75.00	
9560STS, 9660STS, 9760STS, 9770STS, 9860STS, 9870STS, S670, S680, S690	Unloading Auger Extension Kit High-Rate, For 17" Diameter Auger Adds 4' to Length	AMJD3EXT-HF	\$ 1046.00	
6620, 7720, 8820, 9400, 9500, 9600	Grain Saver Door	AMX27236	\$ 330.00	
6620, 7720, 8820, 9400, 9410, 9450, 9500, 9510, 9550, 9600, 9610, 9650, 9650CTS, 9650STS, 9660CTS, 9750STS, CTS, CTS II	Spring Kit, Grain Saver Door	AMX29019	\$ 50.00	

Auger Tube Donuts

Application	Description	Part Number	Retail Price	Core
6620, 7720, 8820, 9400, 9410, 9450, 9500, 9500SH, 9510, 9510SH, 9550, 9550SH, 9560, 9560SH, 9600, 9610, 9650, 9650STS, 9660, 9660CTS, 9660STS, 9750STS, 9760STS, CTS, CTS II	Splined Coupling (Donut), 4.275" OD Used at top of the vertical unloading auger to connect the drive end of the horizontal auger	AMH128861	\$ 60.00	
6620, 7720, 8820	Quick Coupler Socket (Donut), 4.275" OD Used at the bottom end of the vertical auger	AMAH123930	\$ 80.00	

Grain Tank Auger Floor Liners

Application	Description	Part Number	Retail Price	Core
9400, 9410, 9450, 9500, 9510, 9550 BSN 695201, 9550SH BSN 295701, 9560, 9560SH, 9600, 9610, 9650, 9650CTS, 9660, 9660CTS, CTS, CTS II	Grain Tank Auger Floor Liner Kit Includes Stainless Steel Panels for both Grain Tank Auger Troughs, Rivets and Installation Instructions	AMAH168093	\$ 831.00	
9400, 9410, 9500, 9510	Grain Tank Auger Floor Liner Kit	AMX27141	\$ 445.00	
9450, 9550, 9560, 9600, 9610, 9650, 9660	Grain Tank Auger Floor Liner Kit	AMX27142	\$ 443.00	
9560STS, 9570STS, 9650STS, 9750STS	Grain Tank Auger Floor Liner Kit	AMX27394	\$ 453.00	

John Deere®—Combine

Application	Description	Part Number	Retail Price	Core
9660STS, 9670STS, 9760STS, 9770STS, 9860STS, 9870STS, 9880STS, S550, S650, S660, S670, S680, S690	Grain Tank Auger Floor Liner Kit Includes Stainless Steel Panes for both Grain Tank Auger Troughs, Rivets and Installation Instructions Replaces AH207238	AMX29144	\$ 587.00	
9660STS, 9670STS, 9760STS, 9770STS, 9860STS, 9870STS, S550, S660, S670, S680, S690	Grain Tank Auger Floor Liner Kit	AMX27395	\$ 403.25	
9650STS, 9660STS, 9670STS, 9750STS, 9760STS, 9770STS	Grain Tank Auger Floor Liner Stainless Steel 2 Required	AMAH202864	\$ 335.00	

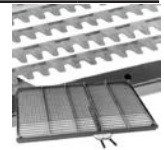

Chaffers—Short Finger Top

Adjustable short finger chaffer with 1 1/8" wire spacing. For use in cereal and fine seed crops.

Application	Description	Part Number	Retail Price	Core
4400, 4420	Short Finger Top Chaffer	36.07" x 50.63" AMAH87874	\$ 675.00	
6600, 6620	Short Finger Top Chaffer	42.01" x 60.76" AMAH99748	\$ 510.00	
6620 Titan II	Short Finger Top Chaffer	42.01" x 66.88" AMAH130378	\$ 755.56	
7700, 7720	Short Finger Top Chaffer	52.87" x 60.91" AMAH106770	\$ 663.00	
7720 Titan II	Short Finger Top Chaffer	52.87" x 66.88" AMAH130381	\$ 867.00	
8820	Short Finger Top Chaffer	63.73" x 61.65" AMAH96770	\$ 755.00	
8820 Titan II	Short Finger Top Chaffer	63.73" x 67.62" AMAH130384	\$ 765.00	
9400, 9500, 9510, 9450, 9550, CTS, CTS II	Short Finger Top Chaffer (2) Required Replaces AH172949	25.67" x 35.71" AMAH132785	\$ 291.00	
	Short Finger Top Chaffer Extension, 1-Piece	52.05" x 17.92" AMAH172953	\$ 320.00	
	Short Finger Top Chaffer Precleaner (2) Required	25.67" x 35.71" AMAH130151	\$ 275.00	
9560STS, 9570STS	Short Finger Top Chaffer Land Level (General Purpose)	AMAH212255	\$ 605.00	
9570STS Touchset, S550	Short Finger Top Chaffer	AMAXE20451	\$ 1951.37	
9600, 9610, 9650, 9660	Short Finger Top Chaffer (2) Required	31.10" x 35.71" AMAH132784	\$ 332.00	
	Short Finger Top Chaffer Extension, 1-Piece	62.91" x 17.92" AMAH172952	\$ 745.82	
	Short Finger Top Chaffer Precleaner (2) Required	31.10" x 35.71" AMAH172941	\$ 332.00	
9600, 9610, 9650, 9660, CTS	Short Finger Top Chaffer Precleaner 1/8" Wire Spacing	35.729" x 31.228" AMAH131214	\$ 421.03	
9650STS, 9660STS, 9670STS, 9750STS, 9760STS, 9770STS, 9860STS, 9870STS	Short Finger Top Chaffer Touchset	51.87" x 63.25" AMAH212239	\$ 842.00	
9650STS, 9660STS, 9750STS, 9760STS, 9770STS	Short Finger Top Chaffer, Manual Adjust Replaces AH154460, AH168338, AH211936	51.87" x 63.25" AMAH208291	\$ 796.00	
	Chaffer Adjustment Mechanism	AMX27423	\$ 175.00	
9650STS, 9660STS, 9750STS, 9760STS, 9860STS	Short Finger Top Chaffer Precleaner Flat Adjustable	51.50" x 34.00" AMAH201930	\$ 1699.62	
9660STS, 9670STS, 9760STS, 9770STS, 9860STS, 9870STS	Short Finger Top Chaffer Precleaner Humped Non-Adjustable Replaces AH217044, AH205609, AH212423	51.50" x 34.00" AMAH217044	\$ 893.00	
(S650, S660, S670, S680, S690 ASN 785000), S760, S770, S780, S785, S790	Short Finger Top Chaffer Level Land (General Purpose) Replaces AXE47216, AXE57966, AXE60614	AMAXE62796	\$ 1525.00	
(S650, S660, S670, S680, S690 BSN 785001), S670HM, S680HM, S690HM	Short Finger Top Chaffer Dual Adjust, 1 3/16" Wire Spacing Replaces AXE20447	51.57" x 80.875" AMAXE28477	\$ 913.00	

John Deere®—Combine

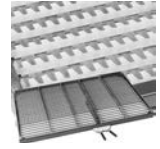

Chaffers—Long Finger Top

Adjustable long finger chaffers with 1 5/8" wire spacing. For use in large seed crops such as corn and beans.

Application	Description	Part Number	Retail Price	Core
4400, 4420	Long Finger Top Chaffer	36.07" x 50.63" AMAH87876	\$ 730.18	
6600, 6620	Long Finger Top Chaffer	42.01" x 60.76" AMAH99750	\$ 515.00	
6620 Titan II	Long Finger Top Chaffer	42.01" x 66.88" AMAH130380	\$ 689.00	
7700, 7720	Long Finger Top Chaffer	52.87" x 60.91" AMAH106772	\$ 581.00	
7720 Titan II	Long Finger Top Chaffer	52.87" x 66.88" AMAH130383	\$ 673.00	
8820	Long Finger Top Chaffer	63.73" x 61.65" AMAH97998	\$ 665.00	
8820 Titan II	Long Finger Top Chaffer	63.73" x 67.62" AMAH130386	\$ 975.00	
9400, 9410, 9450, 9500, 9500SH, 9510, 9510SH, 9550, 9550SH, 9560, 9560SH, 9660CTS, CTS	Long Finger Top Chaffer Precleaner Deep Tooth, 1 5/8" Wire Spacing	AMAH172945DT	\$ 297.00	
9400, 9410, 9450, 9500, 9510, 9550, 9560, 9660CTS, CTS, CTS II	Long Finger Top Chaffer (2) Required	25.67" x 35.71" AMAH172951	\$ 310.00	
	Long Finger Top Chaffer Extension, 1-Piece	52.05" x 17.92" AMAH127435	\$ 352.00	
	Long Finger Top Chaffer Precleaner (2) Required Replaces AH172942	25.67" x 35.71" AMAH172945	\$ 300.00	
9560, 9560SH, 9570STS, 9660, 9660CTS, 9660STS, 9670STS, 9760STS, 9770STS, 9860STS, 9870STS	Long Finger Top Chaffer Precleaner, Raised	AMAXE13768	\$ 1142.00	
9600, 9610, 9650, 9660	Long Finger Top Chaffer (2) Required	31.10" x 35.71" AMAH172950	\$ 316.00	
	Long Finger Top Chaffer Extension, 1-Piece	62.91" x 17.92" AMAH127434	\$ 643.11	
	Long Finger Top Chaffer Precleaner (2) Required	31.10" x 35.71" AMAH172944	\$ 350.00	
	Long Finger Top Chaffer Precleaner Deep Tooth, 1 5/8" Wire Spacing	AMAH172944DT	\$ 385.00	
9650STS, 9660STS, 9670STS, 9750STS, 9760STS, 9770STS	Long Finger Top Chaffer, Manual Adjust Replaces AH161895, AH208288	51.87" x 63.25" AMAH212248	\$ 811.00	
	Chaffer Adjustment Mechanism	AMX27423	\$ 175.00	
9650STS, 9660STS, 9670STS, 9750STS, 9760STS, 9770STS, 9860STS, 9870STS	Long Finger Top Chaffer Touchset Replaces AXE20457	51.87" x 63.25" AMAH212245	\$ 903.00	
9650STS, 9660STS, 9750STS, 9760STS, 9860STS	Long Finger Top Chaffer Precleaner	AMAH201411	\$ 875.00	
S650, S660, S670, S680, S690 BSN 785001	Long Finger Top Chaffer Deep Tooth, Dual Adjust	81.00" x 51.89" AMAXE28478	\$ 1015.00	
(S650, S660, S670, S680, S690 ASN 785000), S760, S770, S780, S790	Long Finger Top Chaffer Replaces AXE61277	AMAXE63073	\$ 1275.00	



Chaffers—Adjustable Air Foil Top

Application	Description	Part Number	Retail Price	Core
6600, 6620	Adjustable Air Foil Top Chaffer	42.01" x 60.76" AMAH99748P	\$ 1341.55	
7700, 7720	Adjustable Air Foil Top Chaffer	52.87" x 60.91" AMAH106770P	\$ 1391.38	
7720 Titan II	Adjustable Air Foil Top Chaffer	52.87" x 66.88" AMAH130381P	\$ 1766.55	
8820	Adjustable Air Foil Top Chaffer	63.73" x 61.65" AMAH96770P	\$ 1769.26	
9400, 9450, 9500, 9510, 9550, CTS, CTS II	Adjustable Air Foil Top Chaffer (2) Required	25.67" x 35.71" AMAH132785P	\$ 445.44	

John Deere®—Combine

Application	Description		Part Number	Retail Price	Core
9400, 9500, 9510, 9450, 9550, CTS, CTS II	Adjustable Air Foil Top Chaffer Precleaner (2) Required	25.67" x 35.31"	AMAH130151P	\$ 532.60	
9600, 9610, 9650	Adjustable Air Foil Top Chaffer Extension, 1-Piece	62.91" x 17.92"	AMAH172952P	\$ 397.85	
9650STS, 9660STS, 9670STS, 9750STS, 9760STS, 9770STS, 9860STS, 9870STS	Adjustable Air Foil Precleaner Humped Style	51.50" x 34"	AMPJDPC9660	\$ 1334.75	

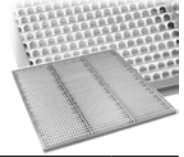

Chaffers—Rigid Air Foil

Rigid air foil chaffers are made of galvanized material. Dividers are included for even distribution and extra strength. These chaffers are preset for maximum performance at normal conditions.

Application	Description		Part Number	Retail Price	Core
6600, 6620	Rigid Air Foil Chaffer	42.01" x 60.76"	AMAH128754	\$ 702.27	
7700, 7720	Rigid Air Foil Chaffer	52.87" x 60.91"	AMAH128755	\$ 872.66	
6620 Titan II	Rigid Air Foil Chaffer	42.01" x 66.88"	AMAH144637	\$ 773.85	
7720 Titan II	Rigid Air Foil Chaffer	52.87" x 66.88"	AMAH144638	\$ 1009.65	
8820	Rigid Air Foil Chaffer	63.73" x 61.65"	AMAH128756	\$ 1079.98	
8820 Titan II	Rigid Air Foil Chaffer	63.73" x 66.81"	AMAH144639	\$ 1218.40	
9400, 9400, 9450, 9500, 9510, 9550, 9560, 9660CTS, CTS, CTS II	Rigid Air Foil Chaffer (2) Required	25.67" x 35.74"	AMAH130486	\$ 355.53	
9600, 9610, 9650, 9660	Rigid Air Foil Chaffer (2) Required	31.10" x 35.71"	AMAH130485	\$ 363.30	

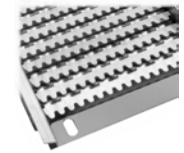

Sieves—Lower

Adjustable, blunt and short finger bottom sieves with 1 1/8" wire spacing. Use in cereal and fine seed grain crops.

Application	Description		Part Number	Retail Price	Core
4400, 4420	Blunt Finger Bottom Sieve	35.88" x 42.63"	AMAH85351	\$ 867.62	
6600, 6620	Blunt Finger Bottom Sieve	41.87" x 46.05"	AMAH85352	\$ 415.00	
6620 Titan II	Blunt Finger Bottom Sieve	41.87" x 52.31"	AMAH130387	\$ 625.00	
7700, 7720	Blunt Finger Bottom Sieve	52.72" x 46.83"	AMAH96771	\$ 561.00	
7720 Titan II	Blunt Finger Bottom Sieve	52.72" x 52.43"	AMAH130389	\$ 638.00	
8820	Blunt Finger Bottom Sieve	63.63" x 46.86"	AMAH96772	\$ 622.00	
8820 Titan II	Blunt Finger Bottom Sieve	63.63" x 53.50"	AMAH130391	\$ 625.00	
9400, 9500, 9510, 9550, CTS, CTS II	Blunt Finger Bottom Sieve (2) Required	25.69" x 48.63"	AMAH130160	\$ 296.00	
9600, 9610, 9650	Blunt Finger Bottom Sieve (2) Required	31.00" x 48.50"	AMAH130159	\$ 321.00	
9650STS, 9660STS, 9670STS, 9750STS, 9760STS, 9770STS	Blunt Finger Bottom Sieve Replaces AH148909, AH211944	51.87" x 54.75"	AMAH208290	\$ 740.00	
Will Not Fit SideHill Models	Will Not Fit SideHill Models		AMX27423	\$ 175.00	
9650STS, 9660STS, 9670STS, 9750STS, 9770STS, 9860STS, 9880STS	Blunt Finger Bottom Sieve Touchset	51.87" x 54.75"	AMAH212241	\$ 811.00	
(S650, S660, S670, S680, S690 ASN 785000), S760, S770, S780, S790	Blunt Finger Bottom Sieve Level Land (General Purpose) Replaces AXE47218, AXE57970, AXE60449		AMAXE62797	\$ 1525.00	
S650 ASN 765000, (S660, S670, S680, S690 ASN 745100), (S670 HillMaster, S680 HillMaster BSN 765000), S690 HillMaster SN 745101-765000	Blunt Finger Bottom Sieve	51.89" x 63.90"	AMAXE20448	\$ 913.00	
9650STS, 9660STS, 9670STS, 9750STS, 9760STS, 9770STS	Long Finger Bottom Sieve Deep Tooth, 1 1/8" Wire Spacing Replaces AH162605, AH208286		AMAH212249	\$ 920.00	

John Deere®—Combine

Application	Description	Part Number	Retail Price	Core
9650STS, 9660STS, 9670STS, 9750STS, 9760STS, 9770STS, 9870STS	Long Finger Bottom Sieve Touchset Replaces AH208129	51.81" x 54.75" AMAH212247	\$ 1697.70	
(S650, S660, S670, S680, S690 BSN 785001)	Long Finger Bottom Sieve Deep Tooth Replaces AXE20449	51.89" x 63.90" AMAXE20450	\$ 913.00	
(S650, S660, S670, S680, S690 ASN 785000), S760, S770, S780, S785, S790	Long Finger Bottom Sieve Deep Tooth Replaces AXE60451	AMAXE62801	\$ 1190.00	



Chaffer and Sieve Frames

Application	Description	Part Number	Retail Price	Core
S550, S660, S670, S670HM, S680, S680HM, S690, S690HM	Chaffer Frame Kit Includes Right and Left Hand Frames Replaces KXE10322, KXE10355, KXE10581	AMKXE10605	\$ 2450.00	
(S660, S670, S680, S690 BSN 745100-785000), (S670HM, S680HM BSN 765000), S690HM BSN 745101-765000	Sieve Frame Kit Includes Right and Left Hand Frames	AMKXE10161	\$ 2000.00	
9570STS, 9670STS, 9770STS, 9870STS	Chaffer Shoe Frame, Right Hand Replaces AH164487, AH165502	AMAH222863	\$ 875.00	
	Chaffer Shoe Frame, Left Hand Replaces AH164488, AH165503	AMAH222862	\$ 1015.00	
6600, 6620, 6622	Chaffer Frame	AMAH97752	\$ 1351.40	
	Sieve Shoe Frame	AMAH112543	\$ 824.70	
6620 Titan II, 6622 Titan II	Chaffer Frame	AMAH115198	\$ 1528.57	
	Sieve Shoe Frame	AMAH116659	\$ 1026.64	
7700*, 7720	Chaffer Frame	AMAH97751	\$ 1175.00	
*Requires (1) AH99760 Door and (1) H99004 Angle	Sieve Shoe Frame	AMAH112544	\$ 920.56	
7720 Titan II	Chaffer Frame	AMAH115199	\$ 1125.00	
	Sieve Shoe Frame	AMAH116660	\$ 1018.77	
8820	Chaffer Frame	AMAH97715	\$ 1350.00	
	Sieve Shoe Frame	AMAH112545	\$ 1302.87	
8820 Titan II	Chaffer Frame	AMAH114417	\$ 1830.00	
	Sieve Shoe Frame	AMAH116661	\$ 1218.50	
9400, 9410, 9500, 9510, 9450, 9550, 9560, 9650CTS, 9660CTS, CTS, CTS II	Chaffer Frame	AMAH204976	\$ 1352.56	
	Chaffer Precleaner Frame	AMAH153808	\$ 1800.79	
	Sieve Shoe Frame	AMAH149701	\$ 1070.00	
9560STS, 9650STS, 9660STS, 9750STS, 9760STS, 9860STS	Sieve Shoe Frame, Right Hand	AMAH218675	\$ 506.27	
	Sieve Shoe Frame, Left Hand	AMAH218676	\$ 506.27	
9600, 9610, 9650, 9660	Chaffer Frame	AMAH204975	\$ 1505.00	
	Chaffer Precleaner Frame	AMAH153807	\$ 1500.00	
	Sieve Shoe Frame	AMAH149702	\$ 1015.00	
9660STS, 9670STS, 9760STS, 9770STS, 9870STS, S650 SN 765000-785000, (S660, S670, S680, S690 SN 745100-785000), (S670HM, S680HM BSN 765000), S690HM SN 745101-765000	Chaffer Air Deflector Replaces AH218191	AMAXE17210	\$ 605.00	
9400, 9410, 9450, 9500, 9500SH, 9510, 9510SH, 9550, 9550SH, 9560, 9560SH, 9650CTS, 9650STS, 9660CTS, 9750STS, CTS, CTS II	Cleaning Shoe Drive Shaft 65.81" Long	AMH133598	\$ 263.00	
9600, 9610, 9650, 9660	Cleaning Shoe Drive Shaft 76.69" Long	AMH133597	\$ 420.82	

John Deere®—Combine

Application	Description	Part Number	Retail Price	Core
9400, 9410, 9450, 9500, 9500SH, 9501, 9510, 9510SH, 9550, 9550SH, 9560, 9560SH, 9560STS, 9570STS, 9600, 9610, 9650, 9650CTS, 9650STS, 9660, 9660CTS, 9660STS, 9670STS, 9750STS, 9760STS, 9770STS, 9860STS, 9870STS, C670, CTS, CTS II, S550 SN 745100-764999, S650 ASN 765000, (S660, S670, S680 ASN 745100), S690 ASN 745100, S670HM, S680HM BSN 765000, S690HM SN 745101-765000, T550, T560, T660, T670	Housing Flange, Pre-Cleaner Chaffer Drive	AMH134118	\$ 15.06	
9400, 9410, 9450, 9500, 9501, 9510, 9510SH, 9550, 9550SH, 9560, 9560SH, 9600, 9610, 9650, 9650CTS, 9780CTS ASN 072800, C670, CTS, CTS II, T550, T560, T660, T670	Outer Cam, Right Hand 1.379" ID, 6 mm Keyway For Shoe Drive	AMH133602	\$ 72.88	
	Outer Cam, Left Hand 1.261" ID, 6 mm Keyway For Shoe Drive	AMH133599	\$ 73.39	
9560STS, 9570STS, 9650STS, 9660STS, 9670STS, 9750STS, 9760STS, 9770STS, 9860STS, 9870STS, S550, (S650, S660, S670, S670 BSN 785001)	Idler Pulley, Shoe and Conveyor Auger Drive 1.437" Overall Width, 7.992" Diameter, 0.637" Bore Diameter, 1" Groove Width Replaces AH85276, AH165366	AMAH97031	\$ 32.73	
9560STS ASN 705604, 9570STS, 9650STS, 9660STS ASN 706997, 9670STS, 9760STS ASN 706955, 9770STS, 9860STS ASN 706195, 9870STS, S550, (S650, S660, S670, S680, S690 BSN 785001), S670HM, S680HM, S690HM	Rear Seal, Bottom Sieve Frame w/ Center Pilot Hole	AMH214184	\$ 15.56	
9400 BSN 645513, 9410, (9500, 9500SH (BSN 646967), 9510, 9510SH, 9600, CTS BSN 645656	Bushing, Hanger Arm 0.532" ID	AMAH125200	\$ 6.59	
9400, 9410, 9500, 9500SH, 9501, 9510, 9510SH, 9600, 9610, 9780CTS ASN 072800, C670, CTS, CTS II, S550 SN 745100-764999, T550, T560, T660, T670	Bushing, Chaffer Frame 0.687" ID	AMAH125201	\$ 24.00	
9650STS, 9660STS, 9750STS, 9760STS, 9860STS, 9880STS	Chaffer Frame Curtain	AMH177907	\$ 73.71	
9660STS, 9670STS, 9760STS, 9770STS, 9860STS, 9870STS	Chaffer Curtain Replaces H215519	AMH230279	\$ 23.78	
9670STS, 9770STS, 9870STS	Chaffer Pan Limit Curtain	AMHXE27152	\$ 63.01	
9400, 9410, 9450, 9500, 9510, 9510SH, 9550, 9550SH, 9560, 9560SH, 9570STS, 9600, 9610, 9650, 9650CTS, 9650STS, 9660, 9660CTS, 9660STS, 9670STS, 9750STS, 9760STS, 9770STS, 9860STS, 9870STS, CTS, CTS II	Sieve Adjuster Crank	AMAH149543	\$ 88.57	
9400, 9410, 9450, 9500, 9510, 9510SH, 9550, 9550SH, 9560, 9560SH, 9560STS, 9570STS, 9650, 9650CTS, 9650STS, 9660STS, 9750STS, 9760STS, 9860STS	Cleaning Shoe Drive Hub	AMH133603	\$ 32.73	
7720 ASN 610500, 8820 ASN 610700	Double Sprocket, Cleaning Shoe 18 & 15 Tooth	AMAH115268	\$ 36.00	
9400, 9410, 9450, 9500, 9500SH, 9510, 9510SH, 9550, 9550SH, 9560STS, 9600, 9610, 9650, 9650CTS, 9650STS, 9660, 9660CTS, 9660STS, 9750STS, 9760STS, 9860STS, CTS, CTS II	Ball Bearing, Chaffer Hanger 3.346" ID, 5.118" OD	AMAH125975	\$ 40.00	
6600 ASN 003700, 7700 ASN 002800	Bearing, Shoe Pitman Shaft 2.4409" OD, 1.125" Bore Diameter	AMJD9246	\$ 23.30	
6600, 7700	Bearing Flange, Shaker Shoe Shaft	AME10018	\$ 2.48	
3300, 4400, 4420	Roller Chain, Shoe Drive 136 Links, Size 50 Chain	AMAH76933	\$ 35.00	
6600 BSN 105801, 7700 BSN 111901	Roller Chain, Shoe Drive 122 Links, Size 50 Chain	AMAH141170	\$ 30.00	
6600 ASN 105801, 7700 ASN 111901	Roller Chain, Shoe Drive 104 Links, Size 50 Chain	AMAH87248	\$ 30.00	
	Roller Chain, Shoe Drive 61 Links, Size 50 Chain	AMAH87247	\$ 80.00	
6620 ASN 610301, 7720, 8820	Roller Chain, Shoe Drive 57 Links, Size 60 Chain	AMAH115329	\$ 25.00	

John Deere®—Combine

Application	Description	Part Number	Retail Price	Core
7720, 8820	Roller Chain, Shoe Drive 99 Links, Size 60 Chain	AMAH90208	\$ 35.00	

Grain Pans and Components

Application	Description	Part Number	Retail Price	Core
9400, 9410, 9450, 9500, 9501, 9510, 9510SH, 9550, 9550SH, 9560, 9560SH, CTS	Grain Pan	AMAH128909	\$ 1011.97	
9600, 9610, 9650, 9660	Grain Pan	AMAH128908	\$ 1069.20	
9650STS, 9660STS, 9670STS, 9750STS, 9760STS, 9770STS, 9860STS, 9870STS, (S650, S660, S670, S680, S690 BSN 785001), S670HM, S680HM, S690HM	Return Pan Shaker, Wide Replaces AH216253, AH229379, AXE17166	AMAXE10046	\$ 1356.00	
9400, 9410, 9450, 9500, 9510, 9550, 9600, 9610, 9650, 9650CTS, 9660, 9660CTS, CTS, CTS II	Shaker Pan Arm, Right Hand	AMAH125970	\$ 226.75	
	Shaker Pan Arm, Left Hand	AMAH125969	\$ 229.66	
9560STS, 9570STS, 9650STS, 9660STS, 9670STS, 9750STS, 9760STS, 9770STS, 9860STS, 9870STS, S550 SN 745100-764999, S650 SN 765000-785000, S660 SN 745000-785000, (S670HM, S680HM BSN 765000), (S680, S690 SN 745100-785000), 690HM SN 745101-765000	Shaker Arm, Right Hand Replaces AH146570, AH170778	AMAH219846	\$ 194.00	
	Shaker Arm, Left Hand Replaces AH146569, AH170777	AMAH219844	\$ 211.00	
9400, 9410, 9450, 9500, 9500SH, 9501, 9510, 9510SH, 9550, 9550SH, 9560, 9560SH, 9560STS, 9570STS, 9600, 9610, 9650, 9650CTS, 9650STS, 9660, 9660CTS, 9660STS, 9750STS, 9760STS, 9780CTS, 9860STS, C670, CTS, CTS II, T550, T560, T660, T670	Sieve to Grain Pan Link	AMAH138230	\$ 46.00	
9570STS, S550, (S650, S660, S670, S680, S690 BSN 785001), S670HM, S680HM, S690HM	Front Seal, Return Pan	AMHXE59223	\$ 15.00	
9560STS, 9570STS, 9650STS, 9660STS, 9670STS, 9750STS, 9760STS, 9770STS, 9860STS, 9870STS, S550, (S650, S660, S670, S680, S690 BSN 785001), S670HM, S680HM, S690HM	Rear Seal, Shaker Pan w/ Offset Pilot Hole	AMH239920	\$ 16.00	
9560STS, 9660STS, 9760STS, 9860STS	Rear Seal, Shaker Pan w/ Center Pilot Hole	AMH214184	\$ 15.56	

Straw Walkers and Components



Application	Description	Part Number	Retail Price	Core
6600, 7700	Straw Walker	AMAH93701	\$ 960.83	
6620, 7720, 8820	Straw Walker	AMAH94469	\$ 685.00	
9400, 9410, 9450	Straw Walker	AMAH135381	\$ 1201.57	
9500, 9510, 9550, 9600, 9610, 9650	Straw Walker	AMAH135380	\$ 1015.00	
9400, 9410, 9450, 9500, 9510, 9550	Straw Walker Crank - Front	AMAH151332	\$ 587.00	
9600, 9610, 9650	Straw Walker Crank - Front	AMAH151331	\$ 587.00	
6600, 6620, 7700	Straw Walker Wood Block Bearing Set Set of 2 w/ hardware, 1 1/4" Shaft	AMH119613S	\$ 23.00	
7720, 8820	Straw Walker Wood Block Bearing Set Set of 2 w/ hardware, 1 1/2" Shaft	AMH119614S	\$ 23.00	
9400 BSN 635181, 9500 BSN 636926, 9600 BSN 636084 - Series One	Straw Walker Wood Block Bearing Set Set of 2 Includes Upper Half, Lower Half and Hardware	AMH140070S	\$ 36.00	
9400 SN 635181-650100, 9500 SN 636926-650200, 9600 SN 636084-650300 - Series Two	Straw Walker Wood Block Bearing Set Set of 2, Vertical 2-Bolt Mount Includes Upper Half, Lower Half and Hardware	AMH140677	\$ 30.00	

John Deere®—Combine

Application	Description	Part Number	Retail Price	Core
9400 ASN 650101, 9500 ASN 650201, 9510, 9600 ASN 650301, 9610 - Series Three	Straw Walker Wood Block Bearing Set Set of 2 w/ Hardware Replaces Aluminum Blocks	AMAH168158S	\$ 41.00	
	Straw Walker Wood Block Bearing Set Set of 2 w/ Hardware (0.002 Undersize) Replaces Aluminum Blocks	AMAH168158SU	\$ 51.00	
9400, 9410, 9500, 9510, 9600, 9610, 9650	Straw Walker Wood Block Bearing Set Set of 2 w/ Hardware 2-Groove, Fits around rings like OEM Aluminum Block	AMAH168158S2	\$ 46.00	
9400, 9410, 9500, 9501, 9510, 9510SH, 9560, 9560SH, 9610, 9650, 9650CTS, 9660, 9660CTS, CTS, CTS II	Hub-Sheave 7.29" OD, 0.985" Bore For Auger Drive	AMH135423	\$ 97.00	
9400, 9410, 9450, 9500, 9510, 9510SH, 9550, 9550SH, 9560, 9560SH, 9560STS, 9570STS, 9610, 9650, 9650CTS, 9650STS, 9660, 9660CTS, 9660STS, 9750STS, 9760STS, 9860STS, 9870STS, CTS, CTS II, S550, S650, S660, S670, S680, S690, S760, S770, S780, S785, S790	Slip Clutch Hub Used on Straw Walker, Conveyor Auger and Chaffer/Sieve Drives	AMH131098	\$ 31.25	
6600, 6601, 6602, 7700, 7701	Chain Sprocket 49 Tooth, 2.253" ID, 10.11" OD For Straw Walker Drive	AMH86128	\$ 48.00	
6600 BSN 105801, 7700 BSN 111901	Chain Sprocket 15 Tooth, 1.125" ID, 3.265" OD For Size 50 Chain For Straw Walker and Shoe Drive Replaces H80389	AMAH84243	\$ 24.02	
6600 ASN 105800, 7700 ASN 111900	Chain Sprocket 15 and 15 Tooth, 1.127" ID, 3.316" OD For Size 50 Chain For Walker and Shoe Drive	AMAH87249	\$ 21.00	
6620 BSN 610301	Chain Sprocket 15 and 18 Tooth, 19 Internal Spline, 3.316" & 2.592" OD For Size 50 Chain For Straw Walker Drive	AMAH93152	\$ 71.66	
7720 BSN 610500, 7721 BSN 610600, 8820 BSN 610700	Chain Sprocket 15 Tooth Double Sprocket, 3.979" Diameter, For Straw Walker Drive	AMAH92689	\$ 45.00	
6620	Drive Sprocket 49 Tooth, 2.877" ID, 10.09" OD For Size 50 Chain	AMH100778	\$ 41.00	
6620 ASN 610300	Drive Sprocket, Straw Walker/Cleaning Shoe 18 & 15 Tooth, 19 Internal Spline, 4.703" & 3.316" OD For Size 60/50 Chain	AMAH115267	\$ 50.00	
6620 ASN 610300, 7720, 8820	Drive Sprocket, Straw Walker 28 Tooth, 3.685" ID, 7.11" OD For Size 60 Chain	AMH93477	\$ 21.40	
7720, 8820	Drive Sprocket, Straw Walker 49 Tooth, 2.872" ID, 12.115" OD For Size 60 Chain	AMH93463	\$ 62.00	
Forage Harvesters: 5200, 5400, 5440, 5460, 5720, 5730, 5820, 5830, 6610, 6650, 6710, 6750, 6810, 6850, 6910, 6950	Idler Sprocket 15 Tooth, 0.638" ID For Size 60 Chain	AMAE27909	\$ 29.38	
7720 ASN 610500, 8820 ASN 610700	Double Sprocket, Straw Walker 18 & 15 Tooth	AMAH115268	\$ 36.00	
9400, 9410, 9450, 9500, 9500SH, 9510, 9510SH, 9550, 9550SH, 9560, 9560SH, 9650, 9650CTS, 9660, 9660CTS, CTS, CTS II	Pulley 8.882" Diameter, 1.378" Bore, 0.394" Hole Diameter For Chaffer and Sieve Drive	AMH131170	\$ 175.00	

John Deere®—Combine

Application	Description	Part Number	Retail Price	Core
6600, 6620, 7700, 7720, 8820	Bearing w/ Lock, Rear Straw Walker Crank	AMJD9274	\$ 24.07	
7700	Bearing w/ Lock, Front Straw Walker Crank	AMJD9274	\$ 24.07	
9400, 9410, 9450, 9500, 9500SH, 9510, 9510SH, 9550, 9550SH, 9560, 9560SH, 9600, 9610, 9650, 9660	Ball Bearing, Straw Walker Gearbox	AMJD10011	\$ 34.97	
9400, 9410, 9450, 9500, 9510, 9510SH, 9550, 9550SH, 9560, 9560SH, 9600, 9610, 9650, 9660	Ball Bearing, Front, Right Hand For Straw Walker Crank	AMAH132823	\$ 33.00	
7720, 8820	Roller Chain, Straw Walker Drive 99 Links, Size 60 Chain	AMAH90208	\$ 35.00	
6600 ASN 105801, 7700 ASN 111901	Roller Chain, Straw Walker Drive 104 Links, Size 50 Chain	AMAH87248	\$ 30.00	

Straw Choppers

Assembly includes rotor, side sheets, knife bank, flanges and hardware.











Application	Description	Part Number	Retail Price	Core
7700 Late, 7720	Straw Chopper Assembly w/ Used Drive Kit	Corn AMC7720-CD	\$ 3900.00	
		Wheat AMC7720-WD	\$ 3900.00	
	Straw Chopper Assembly w/o Drive Kit	AMC7720-N	\$ 3350.00	
8820	Straw Chopper Assembly w/ Used Drive Kit	Corn AMC8820-CD	\$ 4250.00	
		Wheat AMC8820-WD	\$ 4250.00	
	Straw Chopper Assembly w/o Drive Kit	AMC8820-N	\$ 3750.00	
9400, 9410, 9450, 9500, 9510, 9550	Straw Chopper Assembly w/o Drive Kit	AMC9500-N	\$ 3570.00	
9500, 9510, 9550	Straw Chopper Assembly w/ Used Drive Kit	Corn AMC9500-CD	\$ 4000.00	
9560STS BSN 700500, 9750STS BSN 700600	Straw Chopper Assembly w/o Drive Kit w/ 12 Vane Deflector	AMC9750STS-N12	\$ 6195.00	
		AMC9750STS-N	\$ 4950.00	
9560STS BSN 715300	Straw Chopper Assembly w/ Drive Kit	AMC9560STS-E	\$ 9950.00	
9560STS	Straw Chopper Assembly w/o Drive Kit w/ 10 Vane Deflector	AMC9560STS-N10	\$ 5710.00	
		AMC9560STS-N	\$ 4675.00	
9560STS ASN 715301	Straw Chopper Assembly w/ Drive Kit	AMC9560STS-L	\$ 9950.00	
9570STS	Straw Chopper Assembly w/o Drive Kit w/ 10 Vane Deflector	AMC9570STS-N10	\$ 5710.00	
		AMC9570STS-N	\$ 4715.00	
9570STS, S550	Straw Chopper Assembly w/ Drive Kit	AMC9570STS	\$ 10000.00	
9600, 9610, 9650	Straw Chopper Assembly w/ Used Drive Kit	Corn AMC9600-CD	\$ 4250.00	
		AMC9600-N	\$ 3825.00	
9650STS BSN 700500, 9750STS BSN 700600	Straw Chopper Assembly w/ Drive Kit	AMC9750STS-E	\$ 10425.00	
9650STS ASN 700501, 9660STS, 9750STS ASN 700601, 9760STS, 9860STS	Straw Chopper Assembly w/o Drive Kit w/ 12 Vane Deflector	AMC9650STS-N12	\$ 6250.00	
		AMC9650STS-N	\$ 5065.00	
9650STS ASN 700501, 9750STS ASN 700601	Straw Chopper Assembly w/ Drive Kit	AMC9750STS-L	\$ 10425.00	
9660STS BSN 715400, 9760STS BSN 715500	Straw Chopper Assembly w/ Drive Kit	AMC9760STS-E	\$ 10700.00	
9660STS ASN 715401, 9760STS ASN 715501	Straw Chopper Assembly w/ Drive Kit	AMC9760STS-L	\$ 10700.00	







John Deere®—Combine

Application	Description	Part Number	Retail Price	Core
9670STS	Straw Chopper Assembly w/ Drive Kit	AMC9670STS	\$ 10900.00	
	Straw Chopper Assembly w/o Drive Kit w/ 12 Vane Deflector	AMC9670STS-N12	\$ 6250.00	
	Straw Chopper Assembly w/o Drive Kit w/o 12 Vane Deflector	AMC9670STS-N	\$ 5065.00	
9770STS, 9870STS	Straw Chopper Assembly w/o Drive Kit w/ 12 Vane Deflector	AMC9870STS-N12	\$ 6300.00	
	Straw Chopper Assembly w/o Drive Kit w/o 12 Vane Deflector	AMC9870STS-N	\$ 5125.00	
9860STS BSN 705797	Straw Chopper Assembly w/ Drive Kit	AMC9860STS-E	\$ 10975.00	
9860STS ASN 705797	Straw Chopper Assembly w/ Drive Kit	AMC9860STS-L	\$ 10975.00	











Straw Chopper Drive Kits and Components

Application	Description	Part Number	Retail Price	Core
 9400, 9410, 9450, 9500, 9510, 9550, 9560, 9600, 9610, 9650, 9660	Straw Chopper Drive Kit	AMX27118	\$ 1000.00	
 6620, 7720, 8820, 9400, 9410, 9500, 9510, 9600, 9610	Straw Chopper Drive Pulley Replaces AH119770	AMAH95486	\$ 150.00	
 9400 ASN 640100, 9410, 9450, 9500, 9501, 9510, 9510SH, 9600, 9610	Straw Chopper Drive Pulley 2-Groove 11.104" ID, 1.375" OD	AMAH127602	\$ 274.11	
9450 BSN 700100, 9550 BSN 700200, 9550SH BSN 700700, 9650 BSN 700300	Straw Chopper Drive Pulley 2-Groove 4.134" ID, 10.915" OD	AMH139986	\$ 212.69	
 9450, 9550, 9550SH, 9560, 9560SH, 9660	Straw Chopper Drive Pulley, Standard 2-Groove 1.378" ID, 12.275" OD	AMAH162529	\$ 280.54	
 9450, 9550, 9650, 9650, 9660	Straw Chopper Drive Pulley	AMAH162528	\$ 125.00	
 9560STS, 9570STS, 9650STS, 9660STS, 9670STS, 9750STS, 9760STS, 9770STS, 9860STS, 9870STS, S550	Straw Chopper Drive Pulley 2-Groove	AMH161983	\$ 400.00	
9560STS, 9570STS, 9650STS, 9660STS, 9670STS, 9750STS, 9760STS, S550 SN 745100-764999	Straw Chopper Drive Pulley	AMAH163887	\$ 270.00	
9400, 9410, 9450, 9500, 9500SH, 9510, 9510SH, 9550, 9550SH, 9560, 9560SH, 9600, 9610, 9650, 9660	Double Idler Pulley, Straw Chopper Drive 3.25" Wide, 8" OD, 0.50" Bore Diameter Replaces AH87119	AMAH93318	\$ 61.45	
 9560STS, 9660STS, 9670STS, 9760STS, 9770STS, 9860STS, 9870STS	Straw Chopper Pivot Bracket, Right Hand	AMAH218278	\$ 50.00	
	Straw Chopper Pivot Bracket, Left Hand	AMAH226899	\$ 75.00	
 9560STS, 9660STS, 9670STS, 9760STS, 9770STS, 9860STS, 9870STS, 9880STS	Straw Chopper Pivot Bracket Bushing	AMH213638	\$ 15.00	

John Deere®—Combine

	Application	Description	Part Number	Retail Price	Core
	9400, 9410, 9450, 9500, 9510, 9510SH, 9550, 9550SH, 9560, 9560SH, 9600, 9610, 9650, 9660	Straw Chopper Drive Pulley Arm Bracket	AMH132976	\$ 42.00	
	9400, 9410, 9450, 9500, 9510, 9550, 9560, 9600, 9610, 9650, 9660	Straw Chopper Bracket	AMH132901	\$ 35.00	
	9400, 9410, 9450, 9500, 9510, 9550, 9560, 9600, 9610, 9650, 9660	Straw Chopper Rear Drive Arm	AMAH169220	\$ 95.00	
	9400, 9410, 9450, 9500, 9500SH, 9510, 9510SH, 9550, 9550SH, 9560, 9560SH, 9600, 9610, 9650, 9660	Straw Chopper Drive Pulley Arm Strap	AMH129125	\$ 22.00	
	9450, 9550, 9550SH, (9560, 9560SH BSN 705261), 9650, 9660 BSN 705331	Straw Chopper Jackshaft Drive 14.34" Long	AMH169065	\$ 162.94	
	9650STS, 9660STS, 9670STS, 9750STS, 9760STS, 9870STS	Straw Chopper Jackshaft 18.50" Long Replaces H157539	AMH222676	\$ 159.74	
	9500, 9500SH, 9510, 9510SH, (9600, 9610 - w/ Straw Chopper and/or Chaff Spreader w/ Tapped End)	Straw Chopper Jackshaft Drive 8.51" Long M20x2.50" Thread For Fine Cut Straw Choppers Replaces H157687	AMH169712	\$ 169.98	
	9560STS, 9570STS, 9650STS, 9660STS, 9670STS, 9750STS, 9760STS, 9860STS, 9870STS, S550 SN 745100-764999	Pin, Jackshaft Arm Pivot 10" Long, 1" OD M16x20 Right Hand Thread	AMH201324	\$ 39.55	
	9400, 9410, 9500, 9510, 9600, 9610	Straw Chopper Front Drive Arm	AMAH135342	\$ 70.00	
	9560STS, 9570STS, (9660STS, 9760STS ASN 710501), 9670STS, 9770STS, 9860STS ASN 705798, 9870STS, S550 SN 745100-764999	Arm Assembly	AMAH210883	\$ 176.00	
	9560STS, 9570STS, (9660STS, 9760STS ASN 710501), 9670STS, 9770STS, 9860STS ASN 705798, 9870STS, S550 SN 745100-764999	Arm Assembly Replaces AH220821, AH222044	AMAH223728	\$ 237.00	
	9560STS BSN 715300, 9650STS, 9660STS, 9750STS, 9760STS, 9860STS	Arm Assembly Replaces AH160596, AH201042, AH206671	AMAH211558	\$ 218.00	
	9650STS, (9660STS, 9760STS BSN 710500), 9750STS	Arm Assembly	AMAH155256	\$ 128.00	
	9400, 9410, 9450, 9500 BSN 643457, 9510, 9550, 9550SH, 9560, 9560SH, 9560STS, 9570STS, 9600 BSN 642112, 9610, 9650, 9650CTS, 9650STS BSN 695788, 9660, 9660CTS, 9660STS, 9670STS, 9750STS BSN 695706, 9750STS, 9760STS, 9770STS, 9780CTS BSN 74501, 9860STS, 9870STS, S550 SN 745100-764999, S650 ASN 7656000, S660 SN 745100-785000 & ASN 7451001, (S670, S680 ASN 7451000), (S670 HillMaster, S680 HillMaster BSN 765000), S690 SN 765250-785000, S690 HillMaster SN 745101-765000, Cotton Picker: 7260, Cotton Stripper: 9460	Pin 3.354" Long, 0.315" Thick, 1" Diameter, 2.756" Hole Diameter	AMAH212002	\$ 28.00	

John Deere®—Combine

	Application	Description	Part Number	Retail Price	Core
	9400, 9410, 9450, 9500, 9510, 9550, 9560, 9600, 9610, 9650, 9660	Idle Arm Pin	AMAH172214	\$ 49.00	
	9400, 9410, 9450, 9500, 9500SH, 9501, 9510, 9510SH, 9550, 9550SH, 9560, 9560SH, 9600, 9610, 9650, 9660	Straw Chopper Bracket	AMH133812	\$ 47.00	
	9400, 9410, 9450, 9500, 9500SH, 9510, 9510SH, 9550, 9550SH, 9560, 9560SH, 9560STS, 9610, 9650, 9650CTS, 9650STS, 9660, 9660CTS, 9660STS, 9750STS, 9760STS, 9770STS, 9860STS, 9870STS, CTS, CTS II	Bushing, Straw Chopper Drive Tightener and Idler Arms 1.005" ID, 1.128" OD, 1" Wide	AMH171061	\$ 5.00	
	3300, 4400, 4420, 6600, 6620, 7700, 7720, 8820, 9400, 9410, 9500, 9500SH, 9510, 9510SH, 9600, 9610, CTS, CTS II	Idle Pulley, Straw Chopper Drive 7 15/16" Diameter	AMAN15237	\$ 26.15	
	6620, 7700, 7720, 8820, CTS, CTS II, (S670 BSN 765253 w/o Dual Chopper Drive and SN 765253-785000 w/ Standard and Extra Fine Cut Dual Chopper Drive)	Idle Pulley, Straw Chopper Drive 1.437" Overall Width, 7.992" Diameter, 0.637" Bore Diameter, 1" Groove Width Replaces AH85276, AH165366	AMAH97031	\$ 32.73	
	9560STS ASN 715300, 9570STS, (9660STS, 9760STS ASN 710500), 9670STS, 9770STS	Idle Pulley Replaces AH171385	AMAH210922	\$ 98.00	
	9560STS, (9660STS, 9760STS ASN 710500), 9670STS, 9770STS, 9860STS ASN 705797, 9870STS, S550	Idle Pulley	AMAH211639	\$ 93.00	
	9650STS ASN 700500, 9660STS BSN 710501, 9750STS ASN 700600, 9760STS BSN 700501, 9860STS BSN 705798	Idle Pulley	AMAH170234	\$ 91.00	
	9650STS SN 695501-700500, 9750STS SN 695501-700600	Idle Pulley	AMAH171385	\$ 70.00	
	9400, 9410, 9450, 9500, 9510, 9550, 9560, 9600, 9610, 9650, 9660	Stud Shaft	AMH164756	\$ 30.00	
	9560STS, 9570STS, (9660STS, 9760STS ASN 710501), 9770STS, 9860STS ASN 705798, 9870STS, S550 SN 745100-764999, (S670, S680 ASN 745100), S690 ASN 745100	Spring Gauge	AMH211566	\$ 7.00	
	9560STS, 9570STS, 9650STS, 9660STS, 9670STS, 9750STS, 9760STS, 9770STS, 9860STS, 9870STS, S550 SN 745100-764999	Spacer	AMH211141	\$ 8.00	
	9560STS, 9570STS, 9660STS ASN 710501, 9670STS, 9770STS, 9860STS ASN 705798, 9870STS, S550 SN 745100-764999	Yoke Replaces AH209881	AMAH222033	\$ 45.00	
	9560STS, 9570STS, 9660STS, 9670STS, 9750STS, 9760STS, 9860STS, S550 SN 745100-764999	Flange Bearing w/ Collar 1.687" Wide, 1.501" Bearing ID, 3.15" Bearing OD	AMAH163595	\$ 73.00	
	9650STS ASN 696539, 9660STS BSN 710500, 9750STS, 9760STS ASN 710500, 9860STS BSN 705797	Hookbolt	AMH208405	\$ 26.00	

John Deere®—Combine

Application	Description	Part Number	Retail Price	Core
9650STS, (9660STS, 9760STS BSN 710500), 9750STS, 9860STS BSN 705797	Spring Gauge 1.378" Long, 0.394" Wide, 7.323" Tall, 0.063" Thick, 0.512" Hole Diameter	AMH173262	\$ 6.00	
 9770STS, 9860STS ASN 715601, 9870STS	Flange Bearing w/ Collar Replaces AH212944	AMAH232668	\$ 70.00	



Straw Chopper Blades and Components

Application	Description	Part Number	Retail Price	Core
3300 (Requires 3 Sets), (4400, 4420, 6600, 6620 - Requires 4 Sets)	Straw Chopper Blade Set Set of 6 Harden Steel Blades w/o Hardware 9.25" Long Replaces AH172022, P48066	Straight Edge AMAH126851	\$ 30.00	
(7700, 7720, 7721, 9400, 9410, 9450, 9500, 9510, 9550, CTS, CTS II - Requires 5 Sets), (8820, 9600, 9610, 9650, 9650CTS - Requires 6 Sets)	Straw Chopper Blade Set Set of 6 w/o Hardware 8.375" Long	Straight Edges	AMAH124635	\$ 31.50
		Single Bevel	AMAH124635SB	\$ 24.00
		Double Bevel	AMAH124635DB	\$ 26.00
9500, 9500SH, 9510, 9510SH, 9550, 9550SH, 9560, 9560SH, 9560STS, 9600, 9610, 9650, 9650CTS, 9650STS, 9660, 9660CTS, 9660STS, 9750STS, 9760STS, 9860STS, CTS, CTS II	Straw Chopper Blade Set, Paddle Type Set of 8 Includes (4) Right Hand and (4) Left Hand Straw Chopper Blade Bushing For paddled blade Use w/ AMAH205909	AMAH205909	\$ 56.00	
9500, 9500SH, 9510, 9510SH, 9550, 9550SH, 9560, 9560SH, 9600, 9610, 9650, 9650CTS, 9650STS, 9660, 9660CTS, 9660STS, 9750STS, 9760STS, 9860STS, CTS, CTS II	Straw Chopper Blade Set, Fine Cut Set of 8 w/o Hardware Replaces H156098 Chopper Blade Bushing Use w/ AMAH205910	Double Bevel	AMAH205910	\$ 40.00
			AMH156100	\$ 5.00
9570STS, 9670STS, 9770STS, 9870STS, S550	Straw Chopper Blade Set, Scoop Type Set of 8 6.19" Long, 1.97" Wide	AMAH225940	\$ 138.00	
(7700, 7720, 9400, 9500 - Requires 5 Sets), (8820, 9600 - Requires 6 Sets)	Straw Chopper Blade Set Set of 6 Hardened Steel Blades w/ Hardware 8.375" Long Replaces AH124635, H88809 Straw Chopper Blade Set Set of 6 w/ Hardware 8.375" Long Replaces AH124635, H88809	Straight Edges	AMAH171588	\$ 46.00
		Single Bevel	AMAH171588SB	\$ 46.00
S650, S660, S670, S670HM, S680, S680HM, S690, S690HM	Straw Chopper Blade Set Set of 8 w/o Hardware	Serrated Edges	AMKXE10256	\$ 143.00
(7700, 7720, 9400, 9500 - Requires 5 Sets), (8820, 9600 - Requires 6 Sets)	Straw Chopper Blade Set Set of 6 w/ Hardware 8.375" Long Replaces AH124635, H88809	Double Bevel	AMAH171588DB	\$ 60.74
6600, 6620	Straw Chopper Rotor Rod (3) Required for New Style "Tri-Rotor" Assemblies	AMH139500	\$ 55.00	
7700, 7720, 9400 BSN 645110, 9410, 9450, 9500 BSN 646108, 9510, 9550	Straw Chopper Rotor Rod (3) Required for New Style "Tri-Rotor" Assemblies	AMH139600	\$ 60.00	
8820, 9600 BSN 645300	Straw Chopper Rotor Rod (3) Required for New Style "Tri-Rotor" Assemblies	AMH132122	\$ 108.57	

John Deere®—Combine

Application	Description	Part Number	Retail Price	Core
9400, 9410, 9450, 9500, 9500SH, 9501, 9510, 9510SH, 9550SH, 9560SH, 9560STS, 9570STS, 9600, 9610, 9650, 9650CTS, 9650STS, 9660, 9660CTS, 9660STS, 9670STS, 9750STS, 9760STS, 9770STS, 9860STS, 9870STS, CTS, CTS II, (S550, S690HM SN 745101-765000), S650 (ASN 765000), (S660, S670, S680, S690 ASN 745100), (S670HM, S680HM BSN 765000), S760, S770, S780, S785, S790	Straw Chopper Blade, 7.50" Stationary Double Bevel Blade 0.988" hole, 2-Hole For Late Models, Hardware Not Included	AMH215004	\$ 5.00	
(9400, 9410, 9500, 9510 - Requires 29 Blades), (9600, 9610 - Requires 35 Blades)	Straw Chopper Blade, 8.50" Stationary Single Bevel Blade Sold Individually, Hardware Not Included	AMH142141FC	\$ 8.00	
6620, 7720, 8820, 9400 BSN 640101, 9500 BSN 640201, 9600 BSN 640301	Sickle Knife Bracket Assembly, Straw Chopper Single Blade Bracket	AMAP23601	\$ 8.98	
3300, 4400, 6620, 6622, 7720, 7721, 8820, 9400, 9500, 9501, 9600	Stationary Knife	AME76372	\$ 2.00	
6620, 7720, 8820, 9400 BSN 640100, 9500 BSN 640200, 9600 BSN 640300	Straw Chopper Bracket Assembly w/ Knife Sections	AMAH89918	\$ 11.75	
8820	Straw Chopper Knife Bar	AMH100419	\$ 220.00	
8820 ASN 620962, 9400 SN 650101-655100, 9410, 9500, 9500SH, 9510, 9510SH, CTS BSN 655400, CTS II - w/ Tri-Rotor Straw Chopper	Straw Chopper Rotor Shaft 62.94" Long Replaces H141580, H141582	AMH145275	\$ 303.41	
9570STS, 9670STS, 9770STS, 9870STS, S550 SN 745100-764999	Trunnion Bushing (1) Required per Blade	AMH218499	\$ 8.00	
3300 ASN 200000, 4400 ASN 201250, 4420, 6600 ASN 206200, 6620, 7700 ASN 213300, 7720, 8820, 9400 BSN 650101, 9500, 9500SH, 9600	Straw Chopper Bushing 0.38" ID, 0.75" OD	AMH88783	\$ 7.41	
S650 ASN 765000, (S660, S670, S680, S690 ASN 745100), (S670HM, S680HM BSN 765000), S690HM SN 745101-765000	Straw Chopper Bushing Straw Chopper Spacer	AMHXE59496 AMHXE15909	\$ 5.50 \$ 6.50	

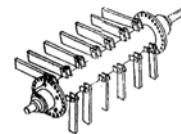

Straw Chopper Rotor Assemblies

These rotor assemblies are balanced and ready for installation. For a new style "Tri-Rotor."













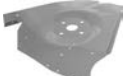

Application	Description	Part Number	Retail Price	Core
7700, 7720, 9400, 9500, 9410, 9510, 9450, 9550, 9650CTS, CTS, CTS II	Straw Chopper Rotor Assembly	AMAH143426	\$ 1632.00	
8820, 9600, 9610, 9650	Straw Chopper Rotor Assembly	AMAH143424	\$ 1700.00	













Straw Chopper Parts and Components

Application	Description	Part Number	Retail Price	Core
	4400, 4420, 6600, 6620, 7700, 7720, 8820	Side Sheet Right Hand	AMAH112271	\$ 130.00
		Side Sheet Left Hand	AMAH112272	\$ 130.00
	9400, 9410, 9500, 9510, 9550, 9600, 9610, 9650, CTS, CTS II	Side Sheet Right Hand	AMAH138157	\$ 185.00
		Side Sheet Left Hand	AMAH138156	\$ 185.00
	9400 BSN 640100, 9500 BSN 640200, 9600 BSN 640300	Side Sheet Replaces AH131979	AMAH131865	\$ 230.34
	9560STS, 9650STS ASN 700501, 9660STS, 9750STS ASN 700601, 9760STS, 9860STS	Side Sheet Right Hand	AMH204974	\$ 240.00
		Side Sheet Left Hand	AMH204973	\$ 240.00
	9570STS, 9670STS, S550 SN 745100-764999	Side Sheet Left Hand	AMH223995	\$ 142.01











John Deere®—Combine

	Application	Description		Part Number	Retail Price	Core
	9650STS BSN 700500, 9750STS BSN 700600	Side Sheet	Right Hand	AMH157481	\$ 200.00	
		Side Sheet	Left Hand	AMH157480	\$ 200.00	
	9660STS ASN 715400, 9760STS ASN 715501	Side Sheet	Right Hand	AMAH217814	\$ 225.00	
		Side Sheet	Left Hand	AMAH217813	\$ 245.00	
	9770STS, 9870STS	Side Sheet	Right Hand	AMH223543	\$ 215.00	
		Side Sheet	Left Hand	AMH223542	\$ 215.00	
	9500, 9500SH, 9510, 9550, 9600, 9610, 9650, CTS, CTS II SN 675101-679050	Side Rail	Right Hand	AMAH139679	\$ 138.00	
	9500, 9500SH, 9510, 9550, 9600, 9610, 9650, CTS, CTS II SN 675101-679050	Side Rail	Left Hand	AMAH139680	\$ 138.00	
	9500 ASN 640199, 9600 ASN 640299	Side Rail	Left Hand	AMAH130482	\$ 291.03	
	9560STS, 9570STS	Chopper Panel, Rear		AMH215050	\$ 250.00	
	9560STS, 9570STS, S550 SN 745100-764999	Chopper Panel, Rear		AMH205348	\$ 258.00	
	9650STS BSN 700500, 9750STS BSN 700600	Chopper Panel, Rear		AMH157482	\$ 290.00	
	9650STS, 9660STS, 9670STS, 9750STS, 9760STS, 9770STS, 9860STS, 9870STS	Cob Deflector		AMAH201004	\$ 215.00	
	9650STS, 9660STS, 9670STS, 9750STS, 9760STS, 9770STS, 9860STS, 9870STS	Deflector Sheet, Top		AMH172614	\$ 203.00	
	9570STS, 9670STS, 9770STS, 9870STS, S550 SN 745100-764999	Filler Plate Replaces H223927	Right Hand	AMH236844	\$ 23.00	
		Filler Plate Replaces H223938	Left Hand	AMH236843	\$ 23.00	
	9560STS, 9570STS, 9650STS BSN 700500, 9660STS, 9670STS, 9750STS, 9760STS, 9770STS, 9860STS, 9870STS, S550 SN 745100-764999	Handle		AMAH201026	\$ 50.00	
	4400, 4420, 6600, 6620, 7700, 7720, 8820	Inner Hanger	Right Hand	AMH113983	\$ 35.00	
			Left Hand	AMH113984	\$ 35.00	
	4400, 4420, 6600, 6620, 7700, 7720, 8820	Outer Hanger	Right Hand	AMAH111646	\$ 45.00	
			Left Hand	AMAH111647	\$ 45.00	
	9560STS, 9650STS ASN 700501, (9660STS, 9760STS BSN 715400), 9750STS, 9860STS BSN 715600	Hanger	Right Hand	AMAH215919	\$ 215.00	
	9570STS, S550 SN 745100-764999	Hanger	Right Hand	AMAH223140	\$ 171.00	
			Left Hand	AMAH222816	\$ 182.00	
	9650STS ASN 700501, (9660STS, 9760STS BSN 715400), 9750STS, 9860STS BSN 715600	Hanger	Left Hand	AMAH205104	\$ 227.00	
	9650STS BSN 700500, 9750STS BSN 700600	Hanger	Right Hand	AMH157502	\$ 170.00	
			Left Hand	AMAH149959	\$ 185.00	



John Deere®—Combine

	Application	Description	Part Number	Retail Price	Core
	9570STS, 9670STS, 9770STS, 9870STS, S550 SN 745100-764999	Housing	Right Hand	AMAH224940	\$ 83.00
			Left Hand	AMAH224939	\$ 83.00
	9560STS, 9570STS, 9650STS BSN 700500, 9660STS, 9670STS, 9750STS, 9760STS, 9770STS, 9860STS, 9870STS, S550 SN 745100-764999	Plate	AMH201116	\$ 18.00	
	9560STS, 9570STS, 9650STS BSN 700500, 9660STS, 9670STS, 9750STS, 9760STS, 9770STS, 9860STS, 9870STS, S550 SN 745100-764999	Plate	AMAH201027	\$ 66.00	
	9560STS, 9570STS, 9650STS, 9660STS, 9670STS, 9750STS, 9760STS, 9770STS, 9860STS, 9870STS, 9880STS European BSN 715700, S540 South America, S550, (S560, S690 European)	Rubber Air Chute Flap	AMH204853	\$ 12.87	
	9650STS, 9660STS, 9670STS, 9750STS, 9760STS, 9770STS, 9860STS, 9870STS, 9880STS European BSN 715700	Rubber Hood Seal	AMH157528	\$ 18.45	
	(9660STS, 9760STS ASN 715401), 9670STS, 9770STS, 9860STS ASN 715604, 9870STS	Seal 54.528" Long For Rear Panel	AMH229546	\$ 21.00	
	9560STS, 9570STS, S550 SN 745100-764999	Seal 4.724" Long For Rear Panel	AMH203963	\$ 18.00	
	9400, 9410, 9450, 9500, 9510, 9550, CTS, CTS II	Shield	AMH146308	\$ 50.00	
	9600, 9610, 9650	Shield	AMH146307	\$ 40.00	
	9600 ASN 640300 w/ Standard Straw Chopper or SN 645301-655300 w/ Tri-Rotor Straw Chopper, 9610	Straw Chopper Rotor Shaft 73.87" Long	AMH145276	\$ 320.42	
	S650 ASN 765000, (S660, S670, S680, S690 ASN 745100), S670HM BSN 765000	Straw Chopper Outlet Housing For PowerCast™ Straw Chopper	AMAXE20855	\$ 791.00	
	S550, S650, S660, S670, S680, S690, S760, S770, S780, S790	Tailboard Trash Tube	AMX29126	\$ 168.00	
	9560STS, 9570STS, 9650STS, 9660STS, 9670STS, 9750STS, 9760STS, 9770STS, 9860STS, 9870STS, S550	Straw Chopper Actuator Replaces AH149880, AXE23606	AMAH209992	\$ 459.00	
	S650 ASN 765000, (S660, S670, S680, S690 ASN 745100), (S670HM, S680HM BSN 765000), S690HM SN 745101-765000, S760, S770, S780, S785, S790	Straw Chopper Actuator 12 Volt	AMAXE12904	\$ 965.00	
	9400, 9410, 9450, 9500, 9510, 9550, CTS, CTS II	Straw Chopper Adjuster Shaft	AMAH135837	\$ 147.00	
	9600, 9610, 9650, 9660	Straw Chopper Adjuster Shaft	AMAH135836	\$ 145.00	
	9400, 9410, 9450, 9500, 9500SH, 9501, 9510, 9510SH, 9550, 9550SH, 9560, 9560SH, 9600, 9610, 9650, 9660	Straw Chopper Adjuster Shaft Shield	AMH141388	\$ 10.00	

John Deere®—Combine

	Application	Description	Part Number	Retail Price	Core
	9650STS, 9660STS, 9670STS, 9750STS, 9770STS, 9860STS, 9870STS	Straw Chopper Door	AMAH168277	\$ 556.00	
	9400, 9410, 9450, 9500, 9510, 9600, 9610	Straw Chopper Jackshaft	AMH137570	\$ 49.08	
	S660, S670	Straw Chopper Strip Electric Tailboard	AMH207023	\$ 80.00	
	9560STS, 9570STS, S550 SN 745100-764999	Straw Chopper Strip For Rear Panel	AMH203964	\$ 24.00	
	9650STS BSN 700500, 9660STS, 9670STS, 9750STS, 9760STS, 9770STS, 9860STS, 9870STS	Straw Chopper Strip For Rear Panel	AMH168323	\$ 30.00	
	9560STS ASN 715301, 9570STS, (9660STS, 9760STS ASN 715401), 9670STS, 9770STS, 9860STS BSN 715600, 9870STS, S550 SN 745100-764999	Bracket	AMAH220827	\$ 47.00	
	9560STS BSN 715300, 9570STS, 9650STS ASN 700501, (9660STS, 9760STS BSN 715400), 9750STS, 9860STS BSN 715600, S550 SN 745100-764999	Bracket	AMH204769	\$ 32.00	
	9560STS, 9570STS, 9650STS BSN 700500, 9660STS, 9670STS, 9750STS, 9760STS, 9770STS, 9860STS, 9870STS, S550 SN 745100-764999	Bracket For Rear Panel	AMH208584	\$ 32.00	
	9560STS, 9650STS BSN 700500, (9660STS, 9760STS BSN 715400), 9750STS, 9860STS	Bracket	AMAH201984	\$ 24.00	
	9400, 9410, 9450, 9500, 9510, 9550, CTS, CTS II	Chopper Rail Bracket	AMH145778	\$ 70.00	
	9600, 9610, 9650	Chopper Rail Bracket	AMH145779	\$ 70.00	
	3300, 4400, 4420, 6600, 6601, 6602, 6620, 6622, 7700, 7701, 7720, 7721, 8820, 9400, 9500, 9500SH, 9501, 9600	Knife Bar Adjuster	AMH84992	\$ 10.00	
	9670STS, 9770STS, 9870STS	Hanger Bracket	Right Hand Left Hand	AMAH223141 AMAH222462	\$ 161.00 \$ 162.00
	(9560STS, 9660STS, 9760STS, 9860STS ASN 715601), 9670STS, 9770STS, 9870STS	Lower Bracket	Right Hand Left Hand	AMH209928 AMH209929	\$ 42.00 \$ 42.00
	9560STS BSN 715300, 9570STS, 9650STS ASN 700501, (9660STS, 9760STS BSN 715400), 9750STS ASN 700601, 9860STS BSN 715600, S550 SN 745100-764999	Lower Bracket Replaces H175499	Right Hand Left Hand	AMH207703 AMH175500	\$ 31.00 \$ 30.00
	9560STS ASN 715301, (9660STS, 9760STS ASN 715401), 9860STS ASN 715601	Mounting Bracket	Left Hand	AMAH218277	\$ 115.00
	9560STS BSN 715300, 9570STS, 9650STS BSN 700500, (9660STS, 9760STS BSN 715400), 9750STS, 9860STS BSN 715600, S550 SN 745100-764999	Mounting Bracket	Right Hand	AMAH165095	\$ 110.00
	9570STS, S550 SN 745100-764999	Mounting Bracket	Left Hand	AMAH226898	\$ 122.00
	9400 BSN 655100, 9610, 9650, 9660	Retaining Rod, Wide 62.756" Long Replaces H141135, H149993	AMH172440	\$ 35.47	

John Deere®—Combine

Application	Description	Part Number	Retail Price	Core
9450, 9550, 9550SH, 9560, 9560SH, 9650CTS, 9650STS BSN 700501, 9660CTS, 9660STS, 9670STS, 9750STS BSN 700601, 9760STS, 9770STS, 9860STS, 9870STS, CTS	Retaining Rod, Narrow 52.756" Long Replaces H141138, H149992, H172439	AMH206215	\$ 52.03	
 9560STS, 9570STS, 9650STS BSN 700500, 9660STS, 9670STS, 9750STS, 9760STS, 9770STS, 9860STS, 9870STS, S550 SN 754100-764999	Pin 5.344" Long, 0.675" Diameter, 0.161" Hole Diameter	AMH165584	\$ 21.00	
9570STS, 9670STS, 9770STS, 9860STS ASN 715601, 9870STS, S550 SN 745100-764999	Dowel Pin	AMH213314	\$ 29.00	
9560STS BSN 715300, 9570STS, 9650STS ASN 700501, 9660STS BSN 715400, 9750STS, 9760STS, 9860STS BSN 715600, S550 SN 745100-764999	Bushing w/ Large Hole	AMH176787	\$ 18.00	
9560STS, 9570STS, 9650STS, 9670STS, 9750STS, 9770STS, 9860STS, 9870STS, S650, S660, S670, S680, S690	Bushing	AMR117879	\$ 19.00	
9650STS BSN 700500, 9750STS BSN 700600	Bushing w/ Small Hole	AMH157507	\$ 18.00	
 9400 ASN 640100, 9410, 9450, 9500 ASN 640201, 9510, 9510SH, 9550, 9550SH, 9560, 9560SH, 9600 ASN 640300, 9610, 9650, 9650CTS, 9660, 9660CTS, CTS, CTS II	Drive Sprocket Bearing w/ Housing	AMAH139260	\$ 60.00	
 3300 ASN 200000, 4400 ASN 201251, 4420, 6600 ASN 206200, 6620, 7700 ASN 213300, 7720, 8820	Bearing, Straw Chopper Rotor Replaces JD9319	AMJD9275	\$ 24.15	
S670, S680, S690	Chop-To-Drop Actuator Replaces AN276545	AMAN272297	\$ 641.50	

Straw Chopper Floors



Application	Description	Part Number	Retail Price	Core
4400, 4420	Straw Chopper Floor	AMH149830	\$ 200.00	
6600, 6620	Straw Chopper Floor	AMH149831	\$ 210.00	
7700, 7720	Straw Chopper Floor	AMH149832	\$ 275.00	
8820	Straw Chopper Floor	AMH149833	\$ 285.00	
9400 BSN 655100, 9500 BSN 604200	Straw Chopper Floor For Early Combines w/ Sickle Section Knives	AMAH123012	\$ 385.00	
9400 ASN 655101, 9410, 9450, 9500 ASN 640200, 9510, 9550, 9650CTS	Straw Chopper Floor For Combines w/ Straw Chopper Knives	AMAH143048	\$ 576.00	
9560STS	Straw Chopper Floor	AMAH205006	\$ 515.00	
9570STS	Straw Chopper Floor	AMAH226920	\$ 535.00	
9600 BSN 640300	Straw Chopper Floor For Early Combines w/ Sickle Section Knives	AMAH123011	\$ 415.00	
9600 ASN 640300, 9610, 9650	Straw Chopper Floor For Combines w/ Straw Chopper Knives Replaces AH138154	AMAH143047	\$ 551.00	
(9650STS, 9750STS ASN 700501), 9660STS, 9760STS, 9860STS	Straw Chopper Floor Replaces Bottom w/ 35 Knives	AMAH214452	\$ 434.00	
(9650STS, 9750STS BSN 700500)	Straw Chopper Floor Replaces Bottom w/ 29 Knives	AMAH149878	\$ 490.00	
9670STS, 9770STS, 9870STS	Straw Chopper Floor	AMAH218187	\$ 474.00	
S550, S650, S660, S670, S680, S690, S760, S770, S780, S790	Straw Chopper Floor	AMAXE14857	\$ 576.00	

John Deere®—Combine

Knife Mount Channels and Parts



Application	Description	Part Number	Retail Price	Core
9400, 9410, 9450, 9500, 9510, 9550	Knife Mount Channel	AMAH140129	\$ 160.00	
9510, 9510SH, 9550, 9550SH, 9560, 9560SH, 9650, 9650CTS, 9650STS, 9660CTS, 9750STS, CTS	Knife Mount Channel For Fine Cut Choppers Requires (27) Knives	AMAH158821	\$ 161.48	
9560STS	Knife Mount Channel	AMAH205921	\$ 161.00	
9570STS, S550 SN 745100-764999	Knife Mount Channel	AMAH218230	\$ 174.00	
9600, 9610, 9650	Knife Mount Channel	AMAH140128	\$ 300.00	
9600, 9610, 9650, 9660	Knife Mount Channel For Fine Cut Choppers Requires (35) Knives	AMAH158820	\$ 196.23	
(9660STS, 9760STS ASN 715401), 9860STS ASN 715601	Knife Mount Channel	AMAH218313	\$ 180.00	
9670STS, 9770STS, 9870STS	Knife Mount Channel	AMAH218189	\$ 208.00	
9560STS	Knife Bar Kit Single Point Adjustment Includes (35) Stationary Knives	AMAH219258	\$ 345.00	
9560STS, 9650STS, 9660STS, 9750STS, 9760STS, 9860STS	Knife Bar Kit Single Point Adjustment Includes (35) Stationary Knives	AMAH219257	\$ 400.00	
6600, 6620	Knife Bar	AMH88798	\$ 105.00	
7700, 7720	Knife Bar	AMH88804	\$ 115.00	
9560STS ASN 715301, 9570STS, 9650STS, (9660STS, 9760STS ASN 715401), 9670STS, 9750STS, 9770STS, 9860STS ASN 715601, 9870STS, S550 SN 745100-764999	Lift Arm	AMAH214384	\$ 38.00	
3300, 4400, 4420	Bracket	AMH88801	\$ 9.00	
6600, 6620, 6622, 7700, 7720, 8820, 9400 BSN 640100, 9500 BSN 640200, 9600 BSN 640300	Bracket	AMH88800	\$ 4.55	
(9400, 9500SH ASN 655101), 9450, 9500 ASN 955101, 9501 ASN 640401, 9510, 9510SH, 9550, 9550SH, 9560, 9560SH, 9600 ASN 650301, 9610, 9650, 9650CTS, 9660, 9660CTS, CTS BSN 655400	Support Bracket, Right Hand Support Bracket, Left Hand	AMH149026 AMH149027	\$ 29.22 \$ 29.22	
9560STS ASN 715301, 9570STS	Adjuster Assembly	AMAH223998	\$ 98.00	
9650STS, (9660STS, 9760STS ASN 715401), 9670STS, 9750STS, 9770STS, 9860STS ASN 715601, 9870STS	Adjuster Assembly	AMAH223985	\$ 102.00	
9560STS ASN 715301, 9570STS, S550 SN 745100-764999	Adjuster Rod	AMAH217972	\$ 47.00	
9650STS, (9660STS, 9670STS, 9760STS, 9860STS ASN 715601), 9750STS, 9770STS, 9870STS, S650 ASN 765000, (S660, S670, S680, S690 ASN 745100)	Adjuster Rod Replaces AH214385	AMAH234779	\$ 54.00	
9560, 9560SH, 9560STS, 9570STS, 9650STS BSN 700500, 9660, 9660STS, 9670STS, 9750STS, 9760STS, 9770STS, 9860STS BSN 715600, S550 SN 745100-764999	Bushing	AMN110219	\$ 10.00	
9560STS ASN 715301, 9570STS, 9650STS, (9660STS, 9760STS, 9860STS ASN 715601), 9670STS, 9750STS, 9770STS, 9870STS, S550 SN 745100-764999	End Plate	AMH215015	\$ 8.00	
9560STS ASN 715301, 9570STS, 9650STS, (9660STS, 9760STS ASN 715401), 9670STS, 9750STS, 9770STS, 9860STS ASN 715601, 9870STS, S550 SN 745100-764999	Wing Nut	AMAH214386	\$ 10.00	

John Deere®—Combine



Wide Spread Deflector Assemblies and Components

Application	Description	Part Number	Retail Price	Core
4400, 4420	Wide Spread Deflector Assembly	AMJDDA4400	\$ 500.00	
	Components:			
	Short Fin, Right Hand	3 AMH114537	\$ 15.00	
	Short Fin, Left Hand	3 AMH114538	\$ 15.00	
	Back	1 AMH113330	\$ 90.00	
	Tail Board	1 AMAH125071	\$ 220.00	
	Tail Support Rod Kit	1 AMH138800	\$ 40.00	
	<hr/>			
6600, 6620	Wide Spread Deflector Assembly	AMJDDA6600	\$ 570.00	
	Components:			
	Long Wide Fin, Right Hand	1 AMH130949	\$ 28.00	
	Long Wide Fin, Left Hand	1 AMH130948	\$ 29.00	
	Long Narrow Fin, Right Hand	1 AMH114535	\$ 25.00	
	Long Narrow Fin, Left Hand	1 AMH114536	\$ 25.00	
	Short Fin, Right Hand	1 AMH114537	\$ 15.00	
	Short Fin, Left Hand	1 AMH114538	\$ 15.00	
	Back	1 AMH113331	\$ 110.00	
	Tail Board	1 AMAH125072	\$ 275.00	
	Tail Support Rod Kit	1 AMH138800	\$ 40.00	
	<hr/>			
	7700, 7720	Wide Spread Deflector Assembly	AMJDDA7700	\$ 680.00
Components:				
Long Wide Fin, Right Hand		1 AMH130949	\$ 28.00	
Long Wide Fin, Left Hand		1 AMH130948	\$ 29.00	
Long Narrow Fin, Right Hand		1 AMH114535	\$ 25.00	
Long Narrow Fin, Left Hand		1 AMH114536	\$ 25.00	
Short Fin, Right Hand		1 AMH114537	\$ 15.00	
Short Fin, Left Hand		1 AMH114538	\$ 15.00	
Back		1 AMH113332	\$ 125.00	
Tail Board		1 AMAH125073	\$ 315.00	
Tail Support Rod Kit		1 AMH138800	\$ 40.00	
<hr/>				
8820		Wide Spread Deflector Assembly	AMJDDA8820	\$ 770.00
	Components:			
	Long Wide Fin, Right Hand	1 AMH130949	\$ 28.00	
	Long Wide Fin, Left Hand	1 AMH130948	\$ 29.00	
	Long Narrow Fin, Right Hand	2 AMH114535	\$ 25.00	
	Long Narrow Fin, Left Hand	2 AMH114536	\$ 25.00	
	Short Fin, Right Hand	1 AMH114537	\$ 15.00	
	Short Fin, Left Hand	1 AMH114538	\$ 15.00	
	Back	1 AMH113333	\$ 145.00	
	Tail Board	1 AMAH125074	\$ 320.00	
	Tail Support Rod Kit	1 AMH138800	\$ 40.00	

John Deere®—Combine

Application	Description	Part Number	Retail Price	Core	
9400, 9410, 9450, 9500, 9510, 9550	Wide Spread Deflector Assembly OEM Standard	AMJDDA9500	\$ 580.00		
	Components:				
	Long Wide Fin, Right Hand	1 AMH130949	\$ 28.00		
	Long Wide Fin, Left Hand	1 AMH130948	\$ 29.00		
	Long Narrow Fin, Right Hand	1 AMH114535	\$ 25.00		
	Long Narrow Fin, Left Hand	1 AMH114536	\$ 25.00		
	Short Fin, Right Hand	1 AMH114537	\$ 15.00		
	Short Fin, Left Hand	1 AMH114538	\$ 15.00		
	Back	1 AMAH139791	\$ 110.00		
	Tail Board	1 AMAH125999	\$ 245.00		
	Tail Support Rod Kit	1 AMH138800	\$ 40.00		
	9400, 9410, 9500, 9510, 9550	Wide Spread Deflector Assembly OEM Wide	AMJDDA9550	\$ 640.00	
Components:					
Long Wide Fin, Right Hand		2 AMH150401	\$ 33.00		
Long Wide Fin, Left Hand		2 AMH150402	\$ 33.00		
Short Wide Fin, Right Hand		1 AMH150403	\$ 19.00		
Short Wide Fin, Left Hand		1 AMH150404	\$ 19.00		
Back		1 AMAH144478	\$ 100.00		
Tail Board		1 AMAH125999	\$ 245.00		
Tail Support Rod Kit		1 AMH138800	\$ 40.00		
9600, 9610, 9650		Wide Spread Deflector Assembly OEM Standard	AMJDDA9600	\$ 645.00	
		Components:			
		Long Wide Fin, Right Hand	1 AMH130949	\$ 28.00	
	Long Wide Fin, Left Hand	1 AMH130948	\$ 29.00		
	Long Narrow Fin, Right Hand	1 AMH114535	\$ 25.00		
	Long Narrow Fin, Left Hand	1 AMH114536	\$ 25.00		
	Short Fin, Right Hand	2 AMH114537	\$ 15.00		
	Short Fin, Left Hand	2 AMH114538	\$ 15.00		
	Back	1 AMAH139790	\$ 125.00		
	Tail Board	1 AMAH125998	\$ 250.00		
	Tail Support Rod Kit	1 AMH138800	\$ 40.00		
	9600, 9610, 9650	Wide Spread Deflector Assembly OEM Wide	AMJDDA9650	\$ 755.00	
Components:					
Long Wide Fin, Right Hand		2 AMH150401	\$ 33.00		
Long Wide Fin, Left Hand		2 AMH150402	\$ 33.00		
Short Wide Fin, Right Hand		2 AMH150403	\$ 19.00		
Short Wide Fin, Left Hand		2 AMH150404	\$ 19.00		
Back		1 AMAH144477	\$ 175.00		
Tail Board		1 AMAH125998	\$ 250.00		
Tail Support Rod Kit		1 AMH138800	\$ 40.00		

John Deere®—Combine

Application	Description	Part Number	Retail Price	Core
9670STS, 9770STS, 9870STS	Wide Spread Deflector Assembly	AMX2710106	\$ 1315.00	
	Components:			
	Long Curved Vane, Right Hand	2 AMHXE80254	\$ 35.75	
	Long Curved Vane, Left Hand	2 AMHXE36443	\$ 36.00	
	Straight Vane, Right Hand	1 AMHXE80252	\$ 37.00	
	Straight Vane, Left Hand	1 AMHXE36439	\$ 36.00	
	Cupped Vane, Right Hand	2 AMHXE80255	\$ 49.00	
	Cupped Vane, Left Hand	2 AMHXE36445	\$ 47.00	
	Vane, Right Hand	2 AMHXE80253	\$ 32.00	
	Vane, Left Hand	1 AMHXE36441	\$ 36.00	
	Tail Board	1 AMAH218490	\$ 581.00	
	Tail Board Support	2 AMAH220019	\$ 65.00	
6600, 6620, 7700, 7720, 9400, 9410, 9500, 9510	Wide Spread Fin Kit	AMAH138803	\$ 160.00	
	Components:			
	Long Wide Fin, Right Hand	1 AMH130949	\$ 28.00	
	Long Wide Fin, Left Hand	1 AMH130948	\$ 29.00	
	Long Narrow Fin, Right Hand	1 AMH114535	\$ 25.00	
	Long Narrow Fin, Left Hand	1 AMH114536	\$ 25.00	
	Short Fin, Right Hand	1 AMH114537	\$ 15.00	
	Short Fin, Left Hand	1 AMH114538	\$ 15.00	
9400, 9410, 9500, 9510, 9550	Wide Spread Fin Kit OEM Wide	AMX2710104	\$ 230.00	
	Components:			
	Long Wide Fin, Right Hand	2 AMH150401	\$ 33.00	
	Long Wide Fin, Left Hand	2 AMH150402	\$ 33.00	
	Short Wide Fin, Right Hand	1 AMH150403	\$ 19.00	
	Short Wide Fin, Left Hand	1 AMH150404	\$ 19.00	
9600, 9610, 9650	Wide Spread Fin Kit OEM Standard	AMX2710102	\$ 196.00	
	Components:			
	Long Wide Fin, Right Hand	1 AMH130949	\$ 28.00	
	Long Wide Fin, Left Hand	1 AMH130948	\$ 29.00	
	Long Narrow Fin, Right Hand	1 AMH114535	\$ 25.00	
	Long Narrow Fin, Left Hand	1 AMH114536	\$ 25.00	
	Short Fin, Right Hand	2 AMH114537	\$ 15.00	
	Short Fin, Left Hand	2 AMH114538	\$ 15.00	
9600, 9610, 9650	Wide Spread Fin Kit Deep & Wide Spread	AMX2710103	\$ 275.00	
	Components:			
	Long Wide Fin, Right Hand	2 AMH150401	\$ 33.00	
	Long Wide Fin, Left Hand	2 AMH150402	\$ 33.00	
	Short Wide Fin, Right Hand	2 AMH150403	\$ 19.00	
	Short Wide Fin, Left Hand	2 AMH150404	\$ 19.00	

John Deere®—Combine

Application	Description	Part Number	Retail Price	Core
9560STS, 9570STS, 9650STS ASN 696468, 9660STS, 9670STS, 9750STS ASN 696058, 9760STS, 9770STS, 9860STS, 9870STS, S550 SN 745100-764999, (S650, S660, S670, S680, S690 ASN 745100), S670HM BSN 765000	Vane, Right Hand Cupped, 7.049" Wide Fins in #4 and #5 Positions Replaces HXE80255	AMH204777	\$ 46.81	
	Vane, Left Hand Cupped, 7.049" Wide Fins in #4 and #5 Positions Replaces HXE36445	AMH204776	\$ 47.50	
9570STS, 9670STS, 9770STS, 9870STS, S550 SN 745100-764999, S650 ASN 765000, (S660, S670, S680, S690 ASN 745100)	Vane, Right Hand Tailboard	AMH236607	\$ 40.00	
	Vane, Tailboard, Left Hand Long Curved Replaces H236606	AMHXE36443	\$ 37.00	
9560STS, 9570STS, 9650STS ASN 696468, 9660STS, 9670STS, 9750STS ASN 696068, 9760STS, 9770STS, 9860STS, 9870STS, S550 SN 745100-764999, S650 ASN 765000, (S660, S670, S680, S690 ASN 745100), S670HM, S680HM, S690HM, S760, S770, S780, S790	Vane, Right Hand Straight Replaces H204218, H223218	AMHXE80252	\$ 35.00	
	Vane, Left Hand Straight Replaces H223216	AMHXE36439	\$ 37.00	
9650STS BSN 696468, 9750STS BSN 696058	Vane, Right Hand Straight, 5.906" Wide	AMH167216	\$ 23.37	
	Vane, Left Hand Straight, 5.906" Wide	AMH167215	\$ 23.37	
9650STS BSN 696467, 9750STS BSN 696058	Vane, Right Hand Deep, 6.024" Wide	AMH167320	\$ 23.37	
	Vane, Left Hand Deep, 6.024" Wide	AMH167319	\$ 23.37	
S550 SN 745100-764999, S650 ASN 765000, (S660, S670, S680, S690 ASN 745100)	Vane, Right Hand Fins in #2 Position	AMHXE80253	\$ 35.00	
	Vane, Left Hand Fins in #2 Position	AMHXE36441	\$ 37.00	
	Vane, Right Hand Tailboard, Cupped Fins in #4 and #5 Positions	AMHXE80255	\$ 45.00	
	Vane, Left Hand Tailboard, Cupped Fins in #4 and #5 Positions	AMHXE36445	\$ 48.00	
S650 ASN 765000, (S660, S670, S680, S690 ASN 745100)	Vane, Right Hand Long Curved	AMHXE80254	\$ 36.00	
	Vane, Tailboard, Left Hand Long Curved Replaces H236606	AMHXE36443	\$ 37.00	
S660 SN 745100-765171, S670 SN 745100-765252	Vane Link	AMH205541	\$ 11.00	
9560STS, 9650STS BSN 696467, 9660STS, 9750STS BSN 696057, 9760STS, 9860STS	Bracket	AMH162520	\$ 22.00	
9560STS, 9570STS, 9650STS BSN 700500, 9660STS, 9670STS, 9750STS, 9760STS, 9770STS, 9860STS, 9870STS, S550 SN 745100-764999	Bracket	AMH174305	\$ 23.00	
9400, 9410, 9500, 9500SH, 9510, 9510SH, 9550, 9550SH, 9560, 9560SH, 9650CTS, 9660CTS, CTS, CTS II	Straw Chopper Deflector Sheet, Standard 54.188" Long, 6.89" Wide	AMH157109	\$ 95.96	
9400, 9410, 9450, 9500, 9500SH, 9510, 9510SH, 9550, 9550SH, 9560, 9560SH, 9650CTS, 9660CTS, CTS, CTS II	Straw Chopper Deflector Sheet, Wide Spread 54.188" Long, 3.937" Wide	AMH150408	\$ 78.10	
9560STS, 9570STS, S550 SN 745100-764999	Cob Deflector	AMAH204812	\$ 210.00	
	Deflector Sheet, Top	AMH205980	\$ 198.00	
9560STS, 9570STS, S550 SN 745100-764999	Door	AMAH201237	\$ 450.00	

John Deere®—Combine

Application	Description	Part Number	Retail Price	Core
9400, 9410, 9450, 9500, 9510, 9550, 9560, 9570STS, 9600, 9610, 9650, 9650STS, 9660, 9670STS, 9750STS, 9770STS, 9860STS, 9870STS, CTS, CTS II, S550, S660, S670, S680, S690	Pin	AMH136179	\$ 11.36	
9560STS, 9570STS, 9650STS BSN 700500, 9660STS, 9670STS, 9750STS, 9760STS, 9770STS, 9860STS, 9870STS, S550 SN 745100-764999	Plate	AMH157499	\$ 19.00	
9670STS, 9770STS, 9870STS	Tail Board	AMAH218490	\$ 658.00	
S650, S660, S670, S680, S690, S760, S770, S780, S790	Tail Board	AMBXE10176	\$ 1560.00	
9570STS, S550	Tail Board	AMAH222834	\$ 610.00	
9570STS, 9670STS, 9770STS, 9870STS, S550	Tail Board Support	AMAH220019	\$ 69.00	



Sickle Knife Heads

Application	Description	Part Number	Retail Price	Core
Platforms: 213, 215, 216, 218, 220, 222, 224, 230, 314, 315, 319, 323, 325, 913F, 913R, 915F, 915R, 918F, 918R, 920F, 920R, 922F, 922R, 924F, 924R, 925F, 925R, 930F, 930R	Sickle Knife Head	AMAH89498	\$ 92.00	
Platforms: 615F, 615R, 618F, 618R, 620F, 620R, 622F, 622R, 625D, 625F, 625R, 630D, 630F, 630FD, 630R, 635D, 635F, 635FD, 635R, 640D, 640FD, 725D, 730D, 730FD, 735D, 735FD, 740D, 740FD, 745FD, (925D, 930D, 936D ASN 710101)	Sickle Knife Head, Drive Block Replaces DE19294, AXE79102	AMAXE24816	\$ 216.79	
Platforms: 615F, 615R, 618F, 618R, 620F, 620R, 622F, 622R, 625F, 625R, 630F, 630R, 635F, 635R	Sickle Knife Head	AMAH205916	\$ 117.00	
Platforms: 625D, 630D, 635D, 640D	Sickle Knife Head	AMAH231841	\$ 91.00	
Platforms: 630FD, 635FD, 645FD	Sickle Knife Head	AMAH231842	\$ 73.00	
Draper Platforms: 925D, 930D, 936D	Sickle Knife Head	AMAH220050	\$ 135.00	



Sickle Assemblies With Heads

Application	Description	Part Number	Retail Price	Core
Platforms: 213, 913	Sickle Assembly w/ Head, Coarse	13'	AMAH121076	\$ 330.00
Platforms: 215, 915	Sickle Assembly w/ Head, Coarse 60 Sections	15'	AMAH121077	\$ 362.00
Platform: 216	Sickle Assembly w/ Head, Coarse	16'	AMAH125752	\$ 366.00
Platforms: 218, 918	Sickle Assembly w/ Head, Coarse	18'	AMAH121079	\$ 440.00
Platforms: 220, 920	Sickle Assembly w/ Head, Coarse	20'	AMAH121081	\$ 439.00
Platforms: 222, 922	Sickle Assembly w/ Head, Coarse	22'	AMAH121083	\$ 496.00
Platform: 224	Sickle Assembly w/ Head, Coarse	24'	AMAH121085	\$ 515.00
Platforms: 230, 930	Sickle Assembly w/ Head, Coarse	30'	AMAH121087	\$ 591.00
Platform: 615	Sickle Assembly w/ Head, Coarse	15'	AMX29008	\$ 390.00
Platform: 618	Sickle Assembly w/ Head, Coarse	18'	AMX29009	\$ 449.00
Platform: 620	Sickle Assembly w/ Head, Coarse	20'	AMX29010	\$ 490.00
Platform: 622	Sickle Assembly w/ Head, Coarse	22'	AMX29011	\$ 529.00
Platform: 625	Sickle Assembly w/ Head, Coarse	25'	AMX29012	\$ 582.00

John Deere®—Combine

Application	Description		Part Number	Retail Price	Core
Platform: 630	Sickle Assembly w/ Head, Coarse	30'	AMX27333	\$ 710.00	
	Sickle Assembly w/ Head, Fine Plated, Serrated Includes Splice Kit and Installation Instructions Replaces AH213011, AH219604	30'	AMX34134	\$ 690.00	
Platforms: 635, 635R	Sickle Assembly w/ Head, Coarse	35'	AMX27334	\$ 845.00	
Platforms: 635F, 635R	Sickle Assembly w/ Head, Fine Plated, 14 Teeth per Inch Top Serrated Features bolt-together, bolt-on coarse sections Replaces AH213011, AH219604		AMX34135	\$ 825.00	
Platform: 925R, 925F	Sickle Assembly w/ Head, Coarse	25'	AMAH121221	\$ 505.00	
Draper Platform: 925D	Sickle Assembly w/ Head, Coarse Plated, 7 Teeth per Inch Includes Splice Kit Features bolt-together, bolt-on coarse sections Convenient to transport and store	25'	AMX29064	\$ 595.00	
	Sickle Assembly w/ Head, Fine Plated, 14 Teeth per Inch Includes Splice Kit Features bolt-together, bolt-on fine sections Convenient to transport and store	25'	AMX29065	\$ 595.00	
Platform: 930D	Sickle Assembly w/ Head, Coarse Plated, 7 Teeth per Inch Includes Splice Kit Features bolt-together, bolt-on coarse sections Convenient to transport and store	30'	AMX29066	\$ 700.00	
	Sickle Assembly w/ Head, Fine Plated, 14 Teeth per Inch Includes Splice Kit Features bolt-together, bolt-on fine sections Convenient to transport and store	30'	AMX29067	\$ 695.00	
Draper Platform: 600R Double Drive	Sickle Assembly w/ Head, Fine Plated, 14 Teeth per Inch Features bolt-together, bolt-on fine sections Convenient to transport and store	25' Right Hand	AMX29080	\$ 410.00	
		25' Left Hand	AMX29079	\$ 409.00	
	30' Right Hand	AMX29082	\$ 425.00		
		30' Left Hand	AMX29081	\$ 425.00	
		35' Right Hand	AMX29084	\$ 485.00	
		35' Left Hand	AMX29083	\$ 535.00	
		40' Right Hand	AMX29086	\$ 490.00	
		40' Left Hand	AMX29085	\$ 490.00	
Draper Platform: 630FD, 730FD - Double Drive	Sickle Assembly w/ Head, Coarse Plated, 7 Teeth per Inch, Top Serrated	30' Right Hand	AMX29071	\$ 468.00	
	Features bolt-together, bolt-on coarse sections Convenient to transport and store	30' Left Hand	AMX29070	\$ 484.00	
Draper Platform: 635FD, 745FD - Double Drive	Sickle Assembly w/ Head, Coarse Plated, 7 Teeth per Inch, Top Serrated Features bolt-together, bolt-on coarse sections Convenient to transport and store	35' Right Hand	AMX29073	\$ 505.00	
		35' Left Hand	AMX29072	\$ 577.00	
Draper Platform: 640FD, 740FD - Double Drive	Sickle Assembly w/ Head, Coarse Plated, 7 Teeth per Inch, Top Serrated Features bolt-together, bolt-on coarse sections Convenient to transport and store	40' Right Hand	AMX29075	\$ 607.00	
		40' Left Hand	AMX29074	\$ 654.00	
Draper Platform: 645FD, 745FD - Double Drive	Sickle Assembly w/ Head, Coarse Features bolt-together, bolt-on coarse sections Convenient to transport and store	45' Right Hand	AMX29077	\$ 631.00	
		45' Left Hand	AMX29076	\$ 651.00	

John Deere®—Combine

Application	Description	Part Number	Retail Price	Core
Draper Platform: 936D	Sickle Assembly w/ Head, Coarse Plated, 7 Teeth per Inch Includes Splice Kit Features bolt-together, bolt-on coarse sections Convenient to transport and store	36' AMX29068	\$ 972.00	
	Sickle Assembly w/ Head, Fine Plated, 14 Teeth per Inch Includes Splice Kit Features bolt-together, bolt-on fine sections Convenient to transport and store	36' AMX29069	\$ 820.00	
Platforms: 213, 215, 216, 218, 220, 222, 224, 230, 913, 915, 918, 920, 922, 925, 930	Splice Kit Includes (10) Countersunk Bolts, (10) Metric Flange Nuts and Installation Instructions	AMX29060	\$ 29.00	
Platforms: 600F, 600R, 625D, 630D, 635D, 635FD, 640D, 640FD, 925D, 930D, 936D	Splice Kit Replaces AH166962	AMAH205715	\$ 30.00	
Draper Platforms: 600F, 600R, 635FD, 640FD, 645FD	Splice Kit Includes (8) Countersunk Bolts, (8) Metric Flange Nuts and Installation Instructions	AMAH205918	\$ 30.00	

Cutter Bar Components

The Gold'N Cut section utilizes a coarse serration that sharpens itself as wearing occurs, giving you the longest wear for your money. All sickle sections feature bolt-on convenience and are heat-treated for superior cutting life.

Application	Description	Part Number	Retail Price	Core
Platforms: 213, 215, 216, 218, 220, 222, 224, 230, 913F, 913R, 915F, 915R, 918F, 918R, 920F, 920R, 922F, 922R, 924F, 924R, 925F, 925R, 930F, 930R	Section, 3" Fine 14 Tooth Sold in Multiples of 25, Priced Individually Replaces H207929	AMH136807	\$ 2.25	
	Section, 3" Course Sold in Multiples of 25, Priced Individually	AMH168316	\$ 2.00	
	Sickle Section Half, End Smooth Replaces H81499	AMH125894	\$ 3.40	
Platforms: 213, 215, 216, 218, 220, 222, 224, 230, 615F, 615R, 618F, 618R, 620F, 620R, 622F, 622R, 625F, 625R, 630F, 630R, 635F, 635R, 913F, 913R, 915F, 915R, 918F, 918R, 920F, 920R, 922F, 922R, 924F, 924R, 925F, 925R, 930F, 930R, RD30F, RD35F, RD40F, RD45F, Draper Platforms: 625D, 630D, 630FD, 635D, 635FD, 640D, 640FD, 645FD, 725D, 730D, 730FD, 735D, 735FD, 740D, 740FD, 745FD, 925D, 930D, 936D	Section, 4" Fine Double Tooth, 14 Tooth	AMH153329	\$ 3.40	
	Section, 4" Course Double Tooth, 7 Tooth	AMH163131	\$ 2.15	
Platforms: 213, 215, 216, 218, 220, 222, 224, 230, 615F, 615R, 618F, 618R, 620F, 620R, 622F, 622R, 625F, 625R, 630F, 630R, 635F, 635R, 913F, 913R, 915F, 915R, 918F, 918R, 920F, 920R, 922F, 922R, 924F, 924R, 925F, 925R, 930F, 930R, RD30F, Platforms: 625D, 630D, 630FD, 635D, 635FD, 640D, 640FD, 645FD, 725D, 730D, 730FD, 735D, 735FD, 740D, 740FD, 745FD, 925D, 930D, 936D	Section Half, Fine 14 Tooth	AMH161242	\$ 2.15	
213, 215, 216, 218, 220, 222, 224, 230, 615F, 615R, 618F, 618R, 620F, 620R, 622F, 622R, 625F, 625R, 630F, 630R, 635F, 635R, 913F, 913R, 915F, 915R, 918F, 918R, 920F, 920R, 922F, 922R, 924F, 924R, 925F, 925R, 930F, 930R, Draper Platforms: 630FD, 730FD	Section Half, Coarse 7 Tooth	AMH163132	\$ 3.60	
Platforms: 630FD, 635FD, 640FD, 645FD	Section, End	AMH226352	\$ 3.75	
Platforms: 213, 215, 216, 218, 220, 222, 224, 230, 615F, 615R, 618F, 618R, 620F, 620R, 622F, 622R, 625F, 625R, 630F, 630R, 635F, 635R, 913F, 913R, 915F, 915R, 918F, 918R, 920F, 920R, 922F, 922R, 924F, 924R, 925F, 925R, 930F, 930R	Section Bolt and Nut Kit Package of 50 Replaces H158341, 14M7303	AMX27520	\$ 24.00	
Platforms: 913F, 913R, 915F, 915R, 918F, 918R, 920F, 920R, 922F, 922R, 924F, 924R, 925F, 925R, 930F, 930R	Section Bolt and Nut Kit Package of 50 Replaces H125891, H125892	AMX27521	\$ 15.00	

John Deere®—Combine



Guards and Cutter Bar Parts

Application	Description	Part Number	Retail Price	Core
Platforms: 213, 215, 216, 218, 220, 222, 224, 230, 913, 915, 916, 918, 920, 922, 924, 925, 930	Knife Guard Non-Clog	AME59625	\$ 12.00	
Platforms: 615F, 615R, 618F, 618R, 620F, 620R, 622F, 622R, 625F, 625R, 630F, 630R, 635F, 635R, RD35F, RD40F, RD45F, Draper Platforms: 630FD, 635FD, 640FD, 645FD, 730FD, 735FD, 740FD, 745FD	Knife Guard, Blunt Points Short/Long/Short Blunt Points 2.75" Long Middle Point Marked 615 Replaces AH205482, AH213055, H213400, H229538	AMH213507	\$ 13.00	
	Knife Guard, Blunt Points Long/Short/Long Blunt Points 2.75" Long Outside Points Marked 610 Replaces H213398, H205448, H205992, H229537	AMH213398	\$ 13.00	
Platforms: 625D, 630D, 635D, 640D, 630FD, RD35F, RD40F, RD45F, Draper Platforms: 635FD, 640FD, 645FD, 730FD, 735FD, 740FD, 745FD	Knife Guard End, Single Prong (1) Required per Head	AMH228526	\$ 10.00	
	Knife Guard Left Middle-Overlap 4" Non-Clog Dual Knife, Open (1) Required per Head	AMHXE18172	\$ 25.00	
Platforms: RD35F, RD40F, RD45F, Draper Platforms: 630FD, 635FD, 640FD, 645FD, 730FD, 735FD, 740FD, 745FD	Knife Guard Right Middle-Overlap 4" Non-Clog, Open (1) Required per Head	AMHXE19625	\$ 26.00	
Platforms: 213, 215, 216, 218, 220, 222, 224, 230, 913F, 913R, 915F, 915R, 918F, 918R, 920F, 920R, 922F, 922R, 924F, 924R, 925F, 925R, 930F, 930R	Knife Guard, Double Pronged Heat Treated Replaces H113571, H145791, H153719, H171031	AMH75386	\$ 9.00	
Platforms: 213, 215, 216, 218, 220, 222, 224, 230, 913F, 913R, 915F, 915R, 918F, 918R, 920F, 920R, 922F, 922R, 924F, 924R, 925F, 925R, 930F, 930R, Quik-Tatch™ Combine Platforms	Knife Guard, 3 Tine	AMH25603	\$ 15.00	
Platforms: 615R, 618R, 620R, 622R, 625R, 630R, 635R, Draper Platforms: 625D, 630D, 635D, 640D, 725D, 730D, 735D, 740D, 925D, 930D, 936D	Knife Guard, Long Point Short/Long/Short Points, Standard Wear 4" Long Middle Point Marked 630 Replaces AH159209, AH164123, AH206088, AH213056, H229540	AMH213508	\$ 16.00	
	Knife Guard, Long Points Long/Short/Long Points, High Wear 4" Long Outside Points Marked 635 Replaces H162565, H170338, H206177, H229539	AMH213405	\$ 15.00	
Platforms: 913F, 913R, 915F, 915R, 918F, 918R, 920F, 920R, 922F, 922R, 924F, 924R, 925F, 925R, 930F, 930R	Sickle Section, 3" Coarse 7 Tooth, Chrome Replaces H160251	AMH207930	\$ 2.25	
Platforms: 213, 215, 216, 218, 220, 222, 224, 230, Quik-Tatch™ Combine Platforms	Knife Clip, Low Profile Adjustable Replaces 1307280C3, 71346158, 86630786, H84412	AMX29115	\$ 13.70	
	Knife Clip, Low Profile Replaces 1307280C3, 71346158, 86630786, H84412	AMX27554	\$ 6.50	
Platforms: 213, 215, 216, 218, 220, 222, 224, 913, 915, 916, 918, 920, 922, 924, 925, 930	Wear Plate	AME47954	\$ 2.50	
Platforms: 213, 215, 216, 218, 220, 222, 224, 230, 913F, 913R, 915F, 915R, 918F, 918R, 920F, 920R, 922F, 922R, 924F, 924R, 925F, 925R, 930F, 930R, Quik-Tatch™ Combine Platforms	Wear Plate Replaces H153157	AMH141546	\$ 2.50	

John Deere®—Combine

Application	Description	Part Number	Retail Price	Core
Platforms: (213, 215, 216, 218, 220, 222, 224, 230 ASN 620300), 218, 915, 918, 920, 922, 925, 930, (314F, 314R, 316F, 316R, 319F, 319R, 323F, 325F ASN 024398), Draper Platform: 918	Hold Down Clip, Cast, Left Hand Use w/ Bolt-On Sickle Sections For Platforms w/ Sectionalized Knife Assemblies	AMH129024	\$ 5.01	
Platforms: (213, 215, 216, 218, 220, 222, 224, 230 ASN 620301), (316, 319, 325 ASN 024399), (620F, 620R, 622F, 622R, 625F, 625R, 630F, 630R, 635F, 635R ASN 710101), (913F, 913R, 915F, 915R, 918F, 918R, 920F, 920R, 922F, 922R, 924F, 924R, 930F, 930R 625301-685400), Draper Platforms: 218D, 918D, 920D	Hold Down Clip	AMH127801	\$ 3.15	
Platforms: 620F, 620R, 625F, 625R, 630F, 630R, 635F, 635R, 925D, 930D, 936D, RD30F, RD35F, RD40F, RD45F, Draper Platforms: 625D, 630D, 630FD, 635D, 635FD, 640D, 640FD, 645FD, 725D, 730D, 730FD, 735D, 735FD, 740D, 740FD, 745FD	Hold Down Clip, Hi-Arch Adjustable Replaces AH213058	AMAH218548	\$ 5.00	
	Hold Down Clip, Low Adjustable	AMAH218547	\$ 6.25	
Platforms: 630FD, 635FD, 640FD, 645FD	Hold Down Clip (2) Required on Double Drive Platforms	AMAH226928	\$ 17.50	

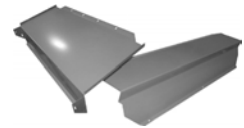

Rear Deflector (Isolator)

Application	Description	Part Number	Retail Price	Core
6620	Rear Deflector (Isolator), For Corn	AMH99507	\$ 210.00	
7720	Rear Deflector (Isolator), For Corn	AMH99508	\$ 240.00	
9500 BSN 640200	Rear Deflector (Isolator), For Corn	AMH136133	\$ 240.00	
9600 BSN 640200	Rear Deflector (Isolator), For Corn	AMH136134	\$ 245.00	

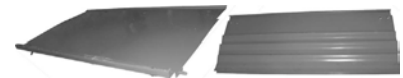

Corn Doors and Wheat Doors

Application	Description	Part Number	Retail Price	Core
6620	Corn Door	AMH85165	\$ 290.00	
8820	Corn Door	AMH112675	\$ 335.00	
9500, 9510, 9550	Corn Door	AMAH142778	\$ 280.00	
9600, 9610, 9650	Corn Door	AMAH142777	\$ 280.00	
All Straw Chopper Corn Doors	Corn Door Latch	Right Hand	AMAH86590	\$ 30.00
		Left Hand	AMAH86591	\$ 30.00
7700, 7720	Wheat Door	AMAH85665	\$ 295.00	
8820	Wheat Door	AMAH99304	\$ 290.00	

Straw Spreader Components

Application	Description	Part Number	Retail Price	Core
(S660, S670, S680, S690 ASN 745100), S760, S770, S780, S790	Spreader Shaft	AMHXE42909	\$ 175.00	
9650STS, 9660STS, 9750STS, 9760STS, 9770STS, 9860STS, 9870STS, S650, S660, S670, S680, S690, S760, S770, S780, S790	Straw Spreader Disc	AMH171890	\$ 133.29	
6620, 7720, 8820	Spreader Blade	AMH76933	\$ 11.00	
6600 ASN 7501, 6620, 7700 ASN 5001, 7720, 8820, 9400, 9500, 9600, 9410, 9510, 9610, 9450, 9550, 9650	Straw Spreader Bevel Gear 13 Tooth, 1" Bore For Dual Style Spreaders Only Sold in Multiples of 2, Priced Individually	AMH91796	\$ 29.50	

John Deere®—Combine

Application	Description	Part Number	Retail Price	Core
9650STS, 9660STS, 9670STS, 9750STS, 9760STS, 9770STS, 9860STS, 9870STS, S660, S670, S680, S690, S760, S770, S780, S790	Hub, Wide Straw Spreader Disc 1.006" ID, 0.04" OD	AMH211288	\$ 75.00	
9560STS, 9570STS, 9650STS, 9660STS, 9670STS, 9750STS, 9770STS, 9860STS, 9870STS, S550	Spreader Limited Curtain	AMH171649	\$ 114.00	
9570STS, 9650STS, 9660STS, 9670STS, 9750STS, 9760STS, 9770STS, 9860STS, 9870STS	Spreader Limited Curtain For Spreaders w/ Hitch	AMHXE27148	\$ 81.00	
9650STS, 9660STS, 9670STS, 9750STS, 9770STS, 9860STS, 9870STS	Spreader Limited Curtain Seal	AMH169618	\$ 35.73	

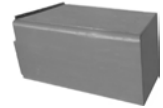

Rear Hoods and Components

Application	Description	Part Number	Retail Price	Core
8820	Separator Limit Curtain	AMAH91680	\$ 148.60	

Rear Hood, Lower Panels

Application	Description	Part Number	Retail Price	Core
6620, 7720, 8820	Hood Panel, Lower Rear Inner Right Hand	AMAH96734	\$ 375.00	
8820	Hood Panel, Lower Rear SMV decal fits on panel	AMAH96710	\$ 350.00	

Platform Adapter Kits

Application	Description	Part Number	Retail Price	Core
Cornheads and Platforms	Driveline Adapter Kit Adapts earlier model cornheads and platforms w/ hex back shafts to the newer John Deere® 50, 60 and 70 Series Combines that are either Rigid or Contour-Master™	AMX27555	\$ 1285.00	
Cornheads: 243, 244, 343, 344, 443, 444, 444SH, 493, 494, 543, 546, 592, 594, 642, 643, 643SH, 644, 645, 692, 693, 694, 842, 843, 844, 892, 893, 894, 1243	Cornhead Adapter Kit Shroud Not Included Replaces, AN102010, H147547, H153308	AMBH81399	\$ 73.00	



Row Crop Head Components

Application	Description	Part Number	Retail Price	Core
50 Series Early Style	Row Crop Belt	AMAE27079	\$ 194.00	
50A Series Late Style	Row Crop Belt	AMAH101172	\$ 153.00	
50A Series	Gathering Chain Drive Bearing Bearing # - 88506-R8 (4) Required Per Row	AMJD10091	\$ 15.00	
50 & 50A Series	Stationary Knife Hardfaced Replaces H101607	AMH139066	\$ 29.00	
50 & 50A Series	Rotating Knife Heat-treated Uses square-head, countersunk bolts to install (not included) Replaces H10167	AMH147109	\$ 7.00	

John Deere®—Combine

Application	Description	Part Number	Retail Price	Core
50A Series	Rotating Knife Drive Bearing Right and Left Hand, Bearing # - CSA206-18 (2) Required Per Row	AMJD10092	\$ 11.00	
50 & 50A Series	Row Unit Drive Bearing Bearing # - 206KRRB6 (2) Required Per Row	AMJD9313	\$ 11.00	
50 & 50A Series	Idler Sprocket Bearing, Press In Bearing # - 203KRR2	AMX27284	\$ 6.00	
50A Series	Gathering Chain Guide Sprocket Right Hand, 11 Tooth, 19 Spline, Ref# 1	AMAH101339	\$ 40.00	
50A Series	Gathering Chain Idler Sprocket 11 Tooth	AMAH103303	\$ 21.00	
50A Series	Gathering Chain Sprocket 11 & 12 Tooth, 19 Spline	AMAH101340	\$ 75.00	
50A Series	Chain Sprocket 13 Tooth, 1.756" ID, 3.475" OD	AMAH143100	\$ 69.00	
50A Series	Row Crop Drive Gear 18 Tooth, 1 1/8" Splined ID, Ref# 2	AMH101668	\$ 44.00	
50 & 50A Series	Row Crop Drive Gear 18 Tooth, 1" Hex Bore ID, Ref# 3	AMN14393	\$ 39.00	
50 Series, 50A Series, Forage Harvesters: 5440 w/ Double Auger, 5460, 5720, 5730, 5820, 5830	Auger Drive Gear 15 Tooth, 1.006" Hex Bore Diameter	AME63258	\$ 74.07	
50 & 50A Series	Finger Holder	AMAH171884	\$ 5.00	
50 & 50A Series	Finger Guide, Poly	AMH179000	\$ 3.00	
Platforms: 453, 453A BSN 655100, 454, 454A, 554, 653, 653A, 654, 654A, 853, 853A, (854A, 1253A BSN 630101)	Finger Guide Screw For Rigid or Flex Platforms	AMH86918	\$ 1.00	
50 & 50A Series	Finger Guide Plate, Steel	AMH87192	\$ 1.25	
50 & 50A Series	Finger Guide For Steel Finger	AMH87044	\$ 2.00	
50A Series	Finger Guide Kit Includes (2) AMH87044 Guides (for H87069 Finger), (2) AMH87192 Hold Down Plates and (4) Self-Tapping Screws	AMX27389	\$ 9.00	
50A Series ASN 655100	Shaft, Right Hand For gather chain drive on row crop bean head	AMH149665	\$ 55.00	
50A Series ASN 655100	Shaft, Left Hand For gather chain drive on row crop bean head	AMH149666	\$ 55.00	
50A Series	Coupler Sprocket 14 Tooth	AMAN102382	\$ 87.00	
50A Series ASN 685101	Deck Plate Indicator Shaft	AMR111692	\$ 29.67	
653, (653A, 853A, 1253A BSN 525351), 853, 1253	Wear Tip For Steel Center Snout Replaces H135290	AMH84480	\$ 23.00	
(653A, 853A, 1253A ASN 655100)	Access Hole Cover	AMH203897	\$ 20.54	
50A Series	Bearing Flange, Cross Auger Shaft	AME10018	\$ 2.48	
50 & 50A Series	Roller Chain, Auger Drive 99 Links, Size 60 Chain	AMAH90208	\$ 35.00	
443 ASN 620251, 444 ASN 620305, 493, 494 BSN 660200, 543 ASN 576762, 546 ASN 620401, 592, 594, 643 ASN 620537, 644 ASN 620575, 645 ASN 620601, 693, 694, 843 ASN 620716, 844 ASN 620710, 893, 894, 1092 BSN 659999	Roller Chain, Row Unit Drive 89 Links, Size 60 Chain	AMAH124998	\$ 40.00	

John Deere®—Combine

Application	Description	Part Number	Retail Price	Core
453A, 454A, 653A, 654A, 655A, 853	Roller Chain, Knife Drive 74 Links, Size 60 Chain	AMAH112546	\$ 30.00	
453A, 454A, 653A, 654A, 655A, 853A, 854A	Roller Chain, Row Unit Drive 130 Links, Size 60 Chain	AMAH94439	\$ 40.00	
854A, 1253A	Roller Chain, Knife Drive 77 Links, Size 60 Chain	AMAH112714	\$ 40.00	



Sickle Drives and Components

Application	Description	Part Number	Retail Price	Core
Platforms: 600F, 600R Replaces DE19409	Wobble Box	AMDE19785	\$ 1831.00	
Platforms: 625D, 630D, 630FD, 635D, 635FD, 640D, 640FD, 645FD	Wobble Box	AMDE21086	\$ 3009.00	
Platforms: 890 Heavy Duty, (895, 896 - Right and Left Hand), 918, 920, 922, 925, 930	Wobble Box, HD	AMAH206402	\$ 1301.00	
Platforms: 925D, 930D, 936D	Wobble Box Assembly	AMDE19786	\$ 1760.00	
Auger Platform: 890 Standard, Platforms: 213, 215, 216, 218, 220, 222, 224, 230, 913F, 913R, 915F, 915R, 918F, 918R, 920F, 920R, 922F, 922R, 924F, 924R, 925F, 925R, 930F, 930R	Wobble Box Assembly 4-Bolt Mounting	AMAE41481	\$ 913.00	
Platforms: 213, 215, 216, 218, 220, 222, 224, 230, 314, 316, 319, 323, 325, 913F, 913R, 915F, 915R, 918F, 918R, 920F, 920R, 922F, 922R, 924F, 924R, 925F, 925R, 930F, 930R	Wobble Box Fork w/ Bushings	AMAE38050	\$ 230.00	
	Wobble Box Housing	AMAE46307	\$ 150.00	
	Wobble Box Yoke Shaft	AME60129	\$ 215.00	
	Wobble Box Shaft Nut	AME59303	\$ 16.50	
	Pin Fastener Use w/ AMAE46307 Wobble Box Housing (2) Required	AME56839	\$ 17.00	
Platforms: 213, 215, 216, 218, 220, 224, 230, 240, 913, 915, 915F, 918, 918F, 918R, 920, 920F, 920R, 922, 924, 925, 925D, 925F, 925R, 930, 930D, 930F, 930R, 936D	Wobble Box Housing	AMAE35151	\$ 212.00	
Platforms: 78, (213, 215, 216, 218, 220, 222, 224, 230 ASN 375527), 325, 913, 915, 915F, 918, 918F, 918R, 920, 920F, 920R, 922, 922F, 925, 925F, 925R, 930, 930F, 930R, Draper Platforms: 925D, 930D, 936D	Wobble Box Housing Cover	AMAE38566	\$ 82.00	
Platforms: 218, 220, 230, 240, 314, 316, 319, 323, 325, 890, 895, 896 w/ Heavy Duty Knife Drive, (900F, 900R 2000-02), 918, 920	Needle Bearing, Wobble Box Housing 0.875" ID, 1.188" OD, 1" Wide Outer Race	AMJD9977	\$ 10.12	
6602, 6622, Platforms: 213, 215, 216, 218, 220, 222, 224, 230, 314, 316, 319, 323, 325, (913F, 913R, 915F, 915R, 916F, 916R, 918F, 918R, 920F, 920R, 922F, 922R, 924F, 924R, 925F, 925R, 930F, 930R ASN 685401)	Wobble Box Repair Kit	AMAE57735	\$ 660.00	
Platforms: 913F, 913R, 915F, 915R, 918F, 918R, 920F, 920R, 922F, 922R, 924F, 924R, 925F, 925R, 930F, 930R	Wobble Box Repair Kit, HD	AMAE71003	\$ 782.09	
Platforms: (213, 215, 216, 218, 220, 222, 224, 230 BSN 530050)	Knife Drive Arm	AMH86911	\$ 92.00	
Platforms: (213, 215, 216, 218, 220, 222, 224, 230 ASN 530051), 218E, 220E, 224E, 314R, 316R, 319R, (913, 915, 918, 920, 922, 925, 930 BSN 638500), Draper Platforms: 78, 218 ASN 611151, 918, 920	Knife Drive Arm 12 Spline	AME52444	\$ 126.12	
Platforms: (915F, 918F, 920F, 922F, 924F, 925F, 930F ASN 638501)	Sickle Drive Arm	AMH136758	\$ 140.00	
Cutting Platforms: (913R, 915R, 918R, 922R, 924R, 925R, 930R ASN 638500), 916R, 920R	Sickle Drive Arm	AMH136757	\$ 181.25	
Platforms: 213, 215, 216, 218, 220, 222, 224, 230, 918, 920	Pillow Block	AMH98780	\$ 30.00	

Prices Subject to Change without Prior Notice. The use of original equipment manufacturer (OEM) part numbers or trademarks, e.g. Case® and John Deere®, are for reference purposes only and for indicating product use and compatibility. Our company and the listed replacement parts contained herein are not sponsored, approved or manufactured by the OEM. All parts are New unless designated Reman in the description.

John Deere®—Combine

Application	Description	Part Number	Retail Price	Core
Cutting Platforms: 913F, 913R, 915F, 915R, 916F, 916R, 918F, 918R, 920F, 920R, 922F, 922R, 924F, 924R, 925F, 925R, 930F, 930R Draper Platforms: 918, 920	Idler Pulley, Knife Drive 7 15/16" Diameter	AMAN15237	\$ 26.15	
Cutting Platforms: 913F, 913R, 915F, 915R, 918F, 918R, 920F, 920R, 922F, 922R, 924F, 924R, 925F, 925R, 930F, 930R	Wobble Box Tension Bracket Kit w/ 5/8" Rod For Rotary Wobble Box Can Replace Early Assemblies Replaces H82418, H161835, H161836	AMAH155154	\$ 104.00	

Augers & Components—Bare Header / Platform



Application	Description	Part Number	Retail Price	Core
Platform: 625	Header Auger, Full Finger, 25'	AMAH223185	\$ 4850.00	
Platform: 630	Header Auger, Full Finger, 30'	AMAH223184	\$ 5406.00	
Platform: 925	Header Auger, Full Finger, 25'	AMAH202558	\$ 4600.00	
	Bearing	SA207-22	\$ 15.00	
Platform: 930	Header Auger, Full Finger, 30'	AMAH202562	\$ 4700.00	
Platforms: (615F, 615R, 618F, 618R, 620F, 620R, 622F, 622R, 625F, 625R, 630F, 630R, 635F, 635R ASN 716465 w/ 1 3/8" Hex Bore)	Auger Drive Pulley Replaces H221000	AMHXE22628	\$ 280.00	
Platforms: 615F, 615R, 618F, 618R, 620F, 620R, 622F, 622R, 625F, 625R, 630F, 630R, 635F, 635R	Idler Pulley	AMAH201252	\$ 120.00	
Platforms: 213, 215, 216, 218, 220, 222, 224, 230, 300, 913F, 913R, 915F, 915R, 918F, 918R, 920F, 920R, 922F, 922R, 924F, 924R, 925F, 925R, 930F, 930R	Auger Finger, Steel Replaces H102724, H150050, H102724, H87069	AMH162662	\$ 4.50	
Platforms: 213, 215, 216, 218, 220, 222, 224, 230, 913F, 913R, 915F, 915R, 918F, 918R, 920F, 920R, 922F, 922R, 924F, 924R, 925F, 925R, 930F, 930R	Auger Finger, Poly 10.25" Long Replaces H202806, H205318	AMX27285	\$ 9.00	
Platforms: 615F, 615R, 618F, 618R, 620F, 620R, 622F, 622R, 625F, 625R, 630F, 630R, 635F, 635R	Auger Finger, Poly Sold Individually	AMAH214869	\$ 4.25	
Platforms: 625D, 630D, 630FD, 635D, 635FD, 640D, 640FD, 645FD, 725D, 730D, 730FD, 735D, 735FD, 740D, 745FD	Auger Finger Kit For 16" Drum	AMAH228229	\$ 17.50	
Platforms: 200, 900, 900F, 900R	Finger Holder	AMAH171884	\$ 5.00	
Platforms: 213, 215, 216, 218, 220, 222, 224, 230, 913F, 913R, 915F, 915R, 918F, 918R, 920F, 920R, 922F, 922R, 924F, 924R, 925F, 925R, 930F, 930R	Finger Guide Kit Includes (2) AMH87044 Guides (for H87069 Finger), (2) AMH87192 Hold Down Plates and (4) Self-Tapping Screws	AMX27389	\$ 9.00	
	Finger Guide For Steel Finger	AMH87044	\$ 2.00	
Platforms: 913F, 913R, 915F, 915R, 918F, 918R, 920F, 920R, 922F, 922R, 924F, 924R, 925F, 925R, 930F, 930R	Finger Guide, Poly	AMH179000	\$ 3.00	
Platforms: 213, 215, 216, 218, 220, 222, 913F, 913R, 915F, 915R, 918F, 918R, 922F, 922R, 925F, 925R, 930F, 930R, Draper Platforms: 918, 920	Finger Guide Screw For Rigid or Flex Platforms	AMH86918	\$ 1.00	
Platforms: 213, 215, 216, 218, 220, 222, 224, 230, 913F, 913R, 915F, 915R, 918F, 918R, 920F, 920R, 922F, 922R, 924F, 924R, 925F, 925R, 930F, 930R	Finger Guide Plate, Steel	AMH87192	\$ 1.25	
Platforms: 213, 215, 216, 218, 220, 222, 224, 230, 615F, 615R, 618F, 618R, 620F, 620R, 622F, 622R, 625F, 625R, 630F, 630R, 635F, 635R, 913F, 913R, 915F, 915R, 918F, 918R, 920F, 920R, 922F, 922R, 924F, 924R, 925F, 925R, 930F, 930R	Finger Guide Cap For Plastic and Fiberglass Fingers	AMH202409	\$ 5.00	
Draper Platforms: 625D, 630D, 630FD, 635D, 635FD, 640D, 640FD, 645FD, 725D, 730D, 730FD, 735D, 735FD, 740D, 740FD, 745FD	Finger Guide Ball 1" Diameter, 0.65" Bore Diameter	AMH217266	\$ 1.15	

John Deere®—Combine

Application	Description	Part Number	Retail Price	Core
Platforms: 614, 616, 618, 620, 622, 625, 630, 635, (913, 915, 918, 920, 922, 925, 930 ASN 705218)	Bearing	AMAH171602	\$ 5.00	
	Retainer	AMH172459	\$ 1.95	
Auger Platforms: 220, 230, 240, Platforms: (213, 215, 216, 218, 220, 222, 224, 230 ASN 317200), (913, 915, 918, 920, 922, 924, 925, 930 BSN 635101), Draper Platform: 218	Bearing, Cross Auger Driveshaft 2.8346" OD, 1.25" Round Bore Replaces AH10515, JD9316	AMG1104KRRB-I	\$ 25.58	
Cutting Platforms: 615F, 615R, 618R, 618F, 618R, 620F, 620R, 622F, 622R, 625F, 625R, 625D, 630F, 630D, 630R, 630FD, 635D, 635F, 635FD, 635R, 640D, 640FD, 645FD, 725D, 730D, 730FD, 735D, 735FD, 740D, 740FD, 745FD, 918F, 918R, 920F, 920R, 922F, 922R 925F, 925R, 930F, 930R	Access Hole Cover	AMH203897	\$ 20.54	
Cutting Platforms: 200, 213, 215, 216, 218, 220, 222, 224, 230 BSN 317201	Bearing w/ Lock Collar, Cross Auger Driveshaft	AMJD9274	\$ 24.07	
Cutting Platforms: 200, 213, 215, 216, 218, 220, 222, 224, 230 BSN 317201	Bearing w/ Lock Collar, Cutterbar Driveshaft	AMJD9274	\$ 24.07	
Platforms: (213, 215, 216, 218, 220, 222, 224, 230 ASN 317200), (913, 915, 918, 920, 922, 924, 925, 930 BSN 635101), Draper Platforms: 218, 918 BSN 635101	Bearing, Cutterbar Driveshaft 2.8346" OD, 1.25" Round Bore Replaces AH10515, JD9316	AMG1104KRRB-I	\$ 25.58	
Platform: (213, 215, 216, 218, 220, 222, 224, 230, 300 ASN 620300), (913F, 913R, 915F, 915R, 918F, 918R, 920F, 920R, 922F, 922R, 924F, 924R, 925F, 925R, 930F, 930R BSN 635101), Draper Platforms: 218, (918, 920 BSN 635101)	Bearing Flange, Cross Auger Shaft	AME10018	\$ 2.48	

Reel Conversion Kits

This kit will convert your old wooden board / metal finger pick-up reel to the new metal pipe / plastic (hi-visibility) reel. Kit includes reel bars, plastic tines and hardware. Bearings and outside tines are not included.



Application	Description	Part Number	Retail Price	Core
Platforms: 925	Reel Conversion Kit, 25' Header	AMRKJD-25	\$ 2350.00	

Reel Drive Components

Application	Description	Part Number	Retail Price	Core
Cutting Platforms: 625D, 630D, 630FD, 635D, 635FD, 640D, 640FD, 640X, 725D, 730D, 730FD, 735D, 735FD, 740D	Reel Drive Gear 85 Tooth	AMH228674	\$ 475.00	
9450 ASN 690243, 9550 ASN 695200, 9550SH ASN 695700, 9560, 9560SH, 9560STS, 9570STS, 9650 ASN 690876, 9650CTS ASN 690504, 9650STS ASN 695500, 9660, 9660CTS, 9660STS, 9670STS, 9750STS ASN 695600, 9760STS, 9770STS, 9860STS - w/ Standard Capacity	Reel Pump Drive Sheave 9.925" OD	AMH179093	\$ 337.92	
9550 ASN 695200, 9550SH ASN 695700, 9560, 9560SH, 9560STS, 9570STS, 9650 ASN 690876, 9650CTS ASN 690504, (9650STS, 9750STS ASN 695500), 9660, 9660CTS, 9660STS, 9670STS, 9760STS, 9770STS, 9860STS, 9870STS, (S550, S650, S660, S670, S670HM, S680, S680HM, S690, S690HM, S760, S770, S780, S785, S790 - w/ Heavy Duty Front End Drive) - w/ High Capacity	Reel Pump Drive Sheave 9.21" OD	AMH179058	\$ 277.68	
9550, 9550SH, 9650 BSN 695300, 9650CTS BSN 695400, 9650STS, 9750STS - w/ High Capacity	Reel Pump Drive Sheave 9.21" OD	AMH157101	\$ 345.76	
9400, 9410, 9450 BSN 690243, 9500, 9500SH, 9510, 9510SH, 9550, 9550SH, 9600, 9610, 9650 BSN 690876, 9650CTS BSN 690504, 9650STS BSN 695500, 9750STS BSN 695600 - w/ Standard Capacity	Reel Pump Drive Pulley 5.059" Long, 9.803" Diameter, 1.259" Groove Width, 0.75" Bore	AMH132937	\$ 140.00	
9400, 9410, 9450, 9500, 9500SH, 9510, 9510SH, 9550, 9550SH, 9560, 9560SH, 9560STS, 9570STS, 9600, 9610, 9650, 9650CTS, 9650STS ASN 695500, 9660, 9660CTS, 9660STS, 9670STS, 9750STS ASN 695600, 9760STS, 9770STS, 9860STS, 9870STS, CTS, CTS II, S550, S650, S660, S670, S670HM, S680, S680HM, S690, S690HM, S760, S770, S780, S790	Bearing, Reel Pump Drive Sheave 0.787" Wide, 3.543" OD, 1.969" Bore Diameter Replaces JD10312	AMAH201531	\$ 41.23	

John Deere®—Combine

Reel Components

Application	Description	Part Number	Retail Price	Core
9660STS, 9670STS, 9760STS, 9770STS, 9860STS, 9870STS, 9880STS, S660, S670, S680, S690, S760, S770, S780, S785, S790	Tine Wear Plate, Feed Accelerator Package of 10 For Fast Tine Feed Accelerator	AMAH216018	\$ 206.70	
Platforms: (913, 915, 918, 920, 922, 924, 925, 930 BSN 645300), Draper Platforms: 918, 920 Replaces H127035	Reel Tine For Platforms w/ Tear Drop Bats and Tines Mounted to Rear of the Steel Bat	AM1970586C1	\$ 2.00	
Platforms: (913, 915, 918, 920, 922, 924, 925, 930 ASN 625300) Replaces AH136689, AH153175	Reel Tine Nylon, 3-Piece Double Wing Unit 4.50" Spacing Includes Hardware Sold in Multiples of 25, Priced Individually Replaces center tine, some modification required for right and left hand sides	AMTINE	\$ 2.25	
Platforms: 615F, 615R, 618F, 618R, 620F, 620R, 622F, 622R, 625F, 625R, 630F, 630R, 635F, 635R, (913F, 913R, 915F, 915R, 916F, 916R, 918F, 918R, 920F, 920R, 922F, 922R, 924F, 924R, 925F, 925R, 930F, 930R ASN 685401), Draper Platforms: 625D, 630D, (630FD, 635FD, 640FD BSN 785000), 635D, 640D, 725D, 730D, 735D, 925D, 930D, 936D Replaces AH166489, AH166493	Reel Tine Nylon, Double Wing Unit, 6" Spacing Includes Hardware Sold in Multiples of 25, Priced Individually	AMX27222	\$ 2.40	
Platforms: 615F, 615R, 618F, 618R, 620F, 620R, 622F, 622R, 625F, 625R, 630F, 630R, 635F, 635R, (913F, 913R, 915F, 915R, 916F, 916R, 918F, 918R, 920F, 920R, 922F, 922R, 924F, 924R, 925F, 925R, 930F, 930R ASN 685401), Draper Platforms: 625D, 630D, (630FD, 635FD, 640FD BSN 785000), 635D, 640D, 725D, 730D, 735D, 925D, 930D, 936D Replaces AH166491	Reel Tine, Right Hand Wing 6" Spacing, Includes Hardware	AMX29057	\$ 4.00	
Platforms: 615F, 615R, 618F, 618R, 620F, 620R, 622F, 622R, 625F, 625R, 630F, 630R, 635F, 635R, (913F, 913R, 915F, 915R, 916F, 916R, 918F, 918R, 920F, 920R, 922F, 922R, 924F, 924R, 925F, 925R, 930F, 930R ASN 685401), Draper Platforms: 625D, 630D, (630FD, 635FD, 640FD BSN 785000), 635D, 640D, 725D, 730D, 735D, 925D, 930D, 936D Replaces AH166490	Reel Tine, Left Hand Wing Nylon, 6" Spacing Includes Hardware	AMX29056	\$ 4.00	
Platforms: (622X, 625X, 630X, 635X, 640X ASN 053000), 625D, 630D, 630FD, 635D, 635FD, 640D, 640FD, 645FD, 725D, 730D, 730FD, 735D, 735FD, 740D, 740FD, 745FD	Reel Tine Sold in Multiples of 10, Priced Individually Replaces HXE81790, HXE96538, KXE10316	AMKXE10423	\$ 5.00	
Platforms: 600R, 600F, 925D, 930D, 936D	Reel Finger, Wide Use w/ 4" and 6" Reel Tines	AMH207933	\$ 4.64	
Platforms: 615F, 615R, 618F, 618R, 620F, 620R, 622F, 622R, 625F, 625R, 630F, 630R, 635F, 635R, 913F, 913R, 915F, 915R, 918F, 918R, 920F, 920R, 922F, 922R, 924F, 924R, 925F, 925R, 930F, 930R	Quick Fingers, Package of 10	AMX27550	\$ 22.00	
Platforms: 314, 316, 319, 323, 325, 600F, 600R, 615F, 615R, 618F, 618R, 620F, 620R, 622F, 622R, 625D, 625F, 625R, 625X, 630D, 630F, 630FD, 630R, 630X, 635D, 635F, 635FD, 635R, 635X, 640D, 640FD, 640X, 645FD, 725D, 730D, 730FD, 735D, 735FD, 740D, 740FD, 745FD, (913, 915, 918, 920, 922, 924, 925, 930 ASN 625301), (913F, 913R, 915F, 915R, 916, 916F, 916R, 918F, 918R, 920F, 920R, 922F, 922R, 924F, 924R, 925F, 925R, 930F, 930R ASN 685401), 925D, 930D, 936D	Roller Bearing, Reel Cam Follower 1.738" Overall Length, 0.875" Wide, 1.50" OD, 0.739" Thread Length, 0.394" (10 mm) Thread Size	AMAH169497	\$ 34.58	
Platforms: 615F, 615R, 618F, 618R, 620F, 620R, 622F, 622R, 625F, 625R, 630F, 630R, 635F, 635R, (913F, 913R, 915F, 915R, 918F, 918R, 920F, 920R, 922F, 922R, 924F, 924R, 925F, 925R, 930F, 930R ASN 645300) Replaces AXE28803, H175727	Reel Bearing	AMH136954	\$ 3.35	
Platforms: 615F, 615R, 618F, 618R, 620F, 620R, 622F, 622R, 625F, 625R, 630F, 630R, 635F, 635R, 913F, 913R, 915F, 915R, 918F, 918R, 920F, 920R, 922F, 922R, 924F, 924R, 925F, 925R, 930F, 930R Replaces H136956	Bearing Clamp Set of 2	AMH175603	\$ 2.00	
Platforms: 316, 319, 325, 614, 616, 618, 620, 622, 625, 630, 635, (913, 915, 918, 920, 922, 925, 930 ASN 705218)	Strap	AMH175436	\$ 5.50	
Platforms: 625D, 630D, 630FD, 635D, 635FD, 640D, 640FD, 645FD, 725D, 730D, 730FD, 735D, 735FD, 740D, 745FD	Reel Drive Gear 21 Tooth Replaces H228673	AMHXE102049	\$ 275.00	

John Deere®—Combine

Platform Components

Application	Description	Part Number	Retail Price	Core
Platforms: 218F, 218R, (918F, 918R SN 625301-635101)	Drive Shaft, Right Hand 61.31" Long	AMH87351	\$ 228.92	
Platforms: 220F, 220R, (920F, 920R SN 625301-635101)	Drive Shaft 73.43" Long	AMH87352	\$ 306.84	
Platforms: 224F, 224R, (924F, 924R SN 625301-635101)	Drive Shaft 97.31" Long	AMH87353	\$ 383.53	
Platforms: (213, 215, 216, 218, 220, 222, 224, 230 ASN 317200), 913F, 913R, 915F, 915R, 918F, 918R, 920F, 920R, 922F, 922R, 924F, 924R, 925F, 925R, 930F, 930R	Drive Sprocket 14 Tooth, 3.483" OD, 1.13" Hex Hub Diameter For Row Unit	AMAH91784	\$ 67.99	
Platforms: 913, 915, 918, 920, 922, 925, 930	Drive Sprocket 40 Tooth, 1.791" Long, 1.379" Hex Bore For Size 60 Chain	AMAH148573	\$ 156.13	
3300, 4400, 4420, 6600, 6620, 7700, 7720, 8820, 9400, 9410, 9500, 9510, 9600, 9610, CTS, CTS II	Coupler Sprocket 14 Tooth	AMAN102382	\$ 87.00	
Platforms: 615F, 615R, 618F, 618R, 620F, 620R, 622F, 622R, 625F, 625R, 630F, 630R, 635F, 635R	Platform Sprocket	AMAH220303	\$ 78.00	
Platforms: 913F, 913R, 915F, 915R, 916F, 916R, 918F, 918R, 920F, 920R, 922F, 922R, 924F, 924R, 925F, 925R, 930F, 930R, Draper Platforms: 918, 920	Platform Sprocket	AMAH138180	\$ 50.00	
Platforms: (900F, 900R ASN 685056)	Deck Plate Indicator Shaft	AMR111692	\$ 29.67	
Platforms: 314, 316, 319, 323, 325, (913F, 913R, 915F, 915R, 916F, 916R, 918F, 918R, 920F, 920R, 922F, 922R, 924F, 924R, 925F, 925R, 930F, 930R SN 625301-685400), Draper Platforms: 918, 920, 925D, 930D, 936D	Slip Clutch Jaw	AMH101677	\$ 29.25	
Draper Platforms: 925D, 930D, 936D	Slip Clutch Hub, Feed Auger 3.618" OD, 2.835" Long, 1.154" Bore Diameter, 0.661" Offset	AMH101678	\$ 124.44	
Row Crop Heads: 453A, 454A, 653A, 654A, 655A, 853A, 854A, 1253A	Slip Clutch Hub, Auger Drive 3.618" OD, 2.835" Long, 1.154" Bore Diameter, 0.661" Offset	AMH101678	\$ 124.44	
Platforms: 213, 215, 216, 218, 220, 222, 224, 230, 316, 319, 325, 600F, 600R, 630FD, 635FD, 640FD, 645FD, 913, 915, 918, 920, 922, 925F, 930, 930F	Bushing 0.6325" Bore	AMAH154697	\$ 4.97	
Draper Platforms: 625D, 630D, 630FD, 635D, 635FD, 640D, 640FD, 645FD, 725D, 730D, 730FD, 735D, 735FD, 740D, 745FD	Finger Guide Top Retainer For Center Feed Drum	AMH217264	\$ 1.11	
	Finger Guide Bottom Retainer For Center Feed Drum	AMH217265	\$ 1.11	
Platforms: 213, 215, 216, 218, 220, 222, 224, 230, 314, 316, 319, 323, 325, 913F, 913R, 915F, 915R, 918F, 918R, 920F, 920R, 922F, 922R, 924F, 924R, 925F, 925R, 930F, 930R, Draper Platforms: 120, (130, 135 ASN 765000), 218, 918 BSN 635901, 920 ASN 646300	Knife Driven Pulley 11" OD For Standard Duty Knife Drive Case Replaces E48349	AME78705	\$ 204.85	
Platforms: 314, 316, 319, 323, 325, 625D BSN 785000, (913, 915, 918, 920, 922, 924, 925, 930 SN 625301-685400)	Eccentric Shield, Platform Reel Replaces H136957	AMH175610	\$ 33.00	
Cutting Platforms: 615F, 615R, 618F, 618R, 620F, 620R, 622F, 622R, 625F, 625R, 630F, 630R, 635F, 635R	Idler Pulley, Cutterbar Drive 1.437" Overall Width, 7.992" Diameter, 0.637" Bore Diameter, 1" Groove Width Replaces AH85276, AH165366	AMAH97031	\$ 32.73	
3300, 4400, 4420, 4425, 4435, 6600, 6620, 7700, 7701, 7720, 7721, 8820, 9400, 9410, 9500, 9500SH, 9510SH, 9600, 9610, CTS, CTS II	Chain Coupler	AMAN102383	\$ 22.00	
Platforms: 630FD, 635FD, 640FD, 645FD	Ramp, Right Hand	AMHXE17296	\$ 6.38	
	Ramp, Left Hand	AMHXE20152	\$ 6.38	
Platforms: (615F, 615R, 618F, 618R, 620F, 620R, 622F, 622R, 625F, 625R, 630F, 630R, 635F, 635R - w/ Standard Shoe or ASN 720100 w/ Raised Shoe)	Float Arm Stabilizer	AMAH221194	\$ 635.00	
Platforms: 615F, 615R, 618F, 618R, 620F, 620R, 622F, 622R, 625F, 625R, 630F, 630R	Ball Joint, Float Arm Stabilizer	AMAH210858	\$ 140.00	

Prices Subject to Change without Prior Notice. The use of original equipment manufacturer (OEM) part numbers or trademarks, e.g. Case® and John Deere®, are for reference purposes only and for indicating product use and compatibility. Our company and the listed replacement parts contained herein are not sponsored, approved or manufactured by the OEM. All parts are New unless designated Reman in the description.

John Deere®—Combine

Application	Description	Part Number	Retail Price	Core
Platforms: 615, 618, 620, 622, 625, 630	Roller Chain, Auger Drive 104 Links, Size 60H Chain	AMAH162957	\$ 55.00	
Cutting Platforms: 615F, 615R, 618F, 618R, 620F, 620R, 622F, 622R, 625F, 625R, 630F, 630R, 635F, 635R	Roller Chain, Auger Drive 78 Links, Size 80H Chain	AMAH220304	\$ 78.00	
Cutting Platforms: (913F, 913R, 915F, 915R, 916F, 916R, 918F, 918R, 920F, 920R, 922F, 922R, 924F, 924R, 925F, 925R, 930F, 930R ASN 685401)	Roller Chain, Auger Drive 87 Links, Size 60H Chain	AMAH141274	\$ 35.00	

Platform Floor Sheets

Application	Description	Part Number	Retail Price	Core
Flex Cutting Platforms: 913, 915, 918, 922	Bottom Floor Sheet, Stainless Steel 75 5/16" Long Replaces AH118969, AH137719	Right Hand AMAH151632	\$ 208.00	
	Bottom Floor Sheet, Stainless Steel 75 5/16" Long Replaces AH118970, AH137720	Left Hand AMAH151633	\$ 208.00	
Flex Cutting Platforms: 915, 918, 920, 922, 925, 930	Bottom Floor Sheet, Stainless Steel 31 7/16" Long Replaces AH118964, AH137714	Center AMAH151627	\$ 112.00	
Flex Cutting Platform: 920	Bottom Floor Sheet, Stainless Steel 66 7/16" Long Replaces AH118967, AH137717	Right Hand AMAH151630	\$ 170.00	
	Bottom Floor Sheet, Stainless Steel 66 7/16" Long Replaces AH118968, AH137718	Left Hand AMAH151631	\$ 170.00	
Flex Cutting Platforms: 920, 924, 925	Bottom Floor Sheet, Stainless Steel 43 7/16" Long Replaces AH118966, AH137716	Center AMAH151629	\$ 145.00	
Flex Cutting Platforms: 922, 930	Bottom Floor Sheet, Stainless Steel 40 7/16" Long Replaces AH118965, AH137715	Center AMAH151628	\$ 123.00	
Flex Cutting Platforms: 924, 925, 930	Bottom Floor Sheet, Stainless Steel 78 7/16" Long Replaces AH118971, AH137721	Right Hand AMAH151634	\$ 230.00	
	Bottom Floor Sheet, Stainless Steel 78 7/16" Long Replaces AH118972, AH137722	Left Hand AMAH151635	\$ 230.00	
Draper Platforms: (630FD, 635FD, 640FD ASN 785000), 645FD, 730FD, 735FD, 740FD, 745FD	Center Feed Section Floor	AMHXE41585	\$ 340.00	

John Deere®—Combine

Row Crop Dividers

Eliminate costly grain loss from knocked down plants. Change from short to long dividers in minutes. Safer transportation and easy storage. Sectional design allows you to replace only the damaged piece which saves you money.



Application	Description	Part Number	Retail Price	Core
Platforms: 213, 215, 216, 218, 220, 222, 224, 230, 913F, 913R, 915F, 915R, 918F, 918R, 920F, 920R, 922F, 922R, 924F, 924R, 925F, 925R, 930F, 930R	Complete Set of Dividers, Long	AMSCD400JD	\$ 1350.00	
	Components:			
	Rear Divider, Right Hand	1 AMSCD100JD-RH	\$ 550.00	
	Rear Divider, Left Hand	1 AMSCD100JD-LH	\$ 550.00	
	Divider Front Wing Section, Long	2 AMSCD200	\$ 550.00	
	Divider Nose Bar	2 AMSCD300	\$ 50.00	
	Complete Set of Dividers, Short	AMSCD500JD	\$ 1199.00	
	Components:			
	Rear Divider, Right Hand	1 AMSCD100JD-RH	\$ 550.00	
	Rear Divider, Left Hand	1 AMSCD100JD-LH	\$ 550.00	
	Short Divider Tip	2 AMSCD250	\$ 75.00	
	Divider Nose Bar	2 AMSCD300	\$ 50.00	
Flex Platforms: 200, 900 Series	Short Divider Tip	AMSCD250	\$ 77.00	
Cutting Platforms: 615F, 615R, 618F, 618R, 620F, 620R, 622F, 622R, 625F, 625R, 630F, 630R, 635F, 635R, Draper Platforms: 625D, 630D, 635D, 640D, 725D, 730D, 735D, 740D, 925D, 930D, 936D	Crop Lifter Assembly	AMAH159210	\$ 28.41	
Platforms: 600F, 600R, 615F, 615R, 618F, 618R, 620F, 620R, 622F, 622R, 625F, 625R, 630F, 630FD, 630R, 635F, 635FD, 635R, 640FD	Wear Tip For Row Crop Divider Point	AMH174618	\$ 17.00	

Header Lift Cylinders



Application	Description	Part Number	Retail Price	Core
9410, 9510, 9600, 9610, 9650, 9650CTS, CTS II	Header Lift Cylinder	AMAH155265	\$ 673.00	
9560STS, 9660STS, 9760STS, 9860STS	Header Lift Cylinder 70 mm Replaces AH166921	AMAH234608	\$ 855.00	
9570STS, 9660STS, 9670STS, 9760STS, 9770STS, 9860STS, 9870STS, S550 SN 745100-764999, S650 ASN 765000, (S660, S670 ASN 745100), (S670HM, S680HM BSN 765000), S690HM SN 745101-765000, S760, S780, S785, S790	Hydraulic Cylinder Seal Kit For Header Lift Cylinder	AMAH167021	\$ 52.25	
9400, 9410, 9500, 9510, 9600, 9610, 9650, 9650CTS, CTS, CTS II	Hydraulic Cylinder Seal Kit For Header Lift Cylinder Replaces AH155265	AMAH162432	\$ 35.00	
Draper Platforms: 625D, 630D, 635D, 640D, 725D, 730D, 735D, 740D	Hydraulic Cylinder Seal Kit For Header Tilt Cylinder	AMAH161589	\$ 31.02	
Draper Platforms: 640D, 740D	Hydraulic Cylinder Seal Kit For Float Cylinder Replaces AH231937	AMAH164325	\$ 21.03	
Sprayer: 4730	Hydraulic Cylinder Seal Kit For Boom Cylinder	AMAH161589	\$ 31.02	

John Deere®—Combine



Draper Belts and Components

Application	Description	Part Number	Retail Price	Core
Platforms: 110, 132, 212, 214, 912, 914	Draper Belt 22.00" x 67.00", Pickup Belt, 60 Tooth	AMAH147909	\$ 237.00	
Platforms: 110, 132, 212, 214, 912, 914 Replaces AH92200	Draper Belt 22.00" x 66.53", Pickup Belt w/o Teeth	AMAH147908	\$ 127.00	
Platform: 625D Replaces AH228214, AXE111465, AXE15007	Draper Side Belt 25' Right and Left Hand, 39.54" x 237.13"	AMAXE12531	\$ 689.00	
Platforms: 625D, 630D, 635D, 640D Replaces AXE12117	Draper Center Feeder Belt 25', 30', 35' or 40', 55.30" x 58.01"	AMAXE12533	\$ 436.00	
Platforms: 625D, 630D, 635D, 640D	Draper Belt Repair Kit For 39.54" Belt Includes 34" Repair Section of RAPTOR Material, Pre-Punched for Connector, (2) Steel Tube Connectors and Hardware	AM1014723	\$ 214.00	
Platform: 630D Replaces AH229394, AXE11896, AXE15008	Draper Side Belt 30' Right and Left Hand, 39.54" x 297.13"	AMAXE14731	\$ 690.00	
Platform: 630FD	Endless Draper Belt 30' Right and Left Hand, 39.93" x 430.80"	AMAXE36429	\$ 1935.00	
Platform: 630FD ASN 785000	Endless Draper Belt 30' Right and Left Hand, 39.93" x 295.00" (2) Required	AMAXE31445	\$ 1917.00	
Platforms: 630FD, 635FD ASN 740831, 640FD ASN 740835 - w/ Center Delivery	Draper Center Feeder Belt 30', 35' or 45', 58.10" x 51.85" Double V-Guide	AMAXE17364	\$ 622.00	
Platforms: 630FD, 635FD, 640FD, 645FD ASN 785000	Draper Center Feeder Belt 30', 35', 40' or 45', 69.80" x 51.85" Double V-Guide (1) Required	AMHXE49231	\$ 667.00	
	Draper Center Feeder Belt 30', 35', 40' or 45', 69.80" x 51.85" Crescent Pattern Option Replaces HXE124019	AMAXE71261	\$ 635.00	
Platform: 635D Replaces AH225872, AXE11897, AXE14603	Draper Side Belt 35' Right and Left Hand, 39.54" x 357.13"	AMAXE12532	\$ 829.00	
Platform: (635FD, 640FD BSN 740835) - w/ Center Delivery	Draper Center Feeder Belt 40', 58.10" x 51.85" Single V-Guide	AMAXE12572	\$ 429.00	
Platforms: (635FD*, 640FD Short** BSN 784999) *4 Required **2 Required (Outside Belts) Replaces AXE22775	Endless Draper Belt 35' or 40' Right and Left Hand, 39.96" x 185.40"	AMAXE35348	\$ 1351.00	
Platforms: (635FD*, 640FD** ASN 785000) *4 Required **2 Required (Outside Belts)	Endless Draper Belt 35' or 40', Right and Left Hand, 39.93" x 180.00"	AMAXE36550	\$ 1302.00	
Platform: 640D Replaces AXE15009	Draper Side Belt 40' Right and Left Hand, 39.54" x 417.13"	AMAXE16051	\$ 980.00	
Platform: 640FD Long BSN 784999 Replaces AXE22776	Endless Draper Belt 40' Right and Left Hand, 39.93" x 245.40" (2) Required (Inside Belts)	AMAXE35349	\$ 1558.00	
Platforms: 640FD** ASN 785000, 645FD* *4 Required **2 Required (Inside Belts)	Endless Draper Belt 40' or 45', Right and Left Hand, 39.93" x 239.75"	AMAXE36551	\$ 1571.00	
Platforms: 730FD, RD30F	Endless Draper Belt 30' Right and Left Hand, 39.93" x 296.86"	AMAXE36557	\$ 1850.00	

John Deere®—Combine

Application	Description	Part Number	Retail Price	Core
Platforms: 735FD*, 740FD** *4 Required **2 Required (Outside Belts)	Endless Draper Belt 30' or 40' Right and Left Hand, 39.93" x 180.00"	AMAXE36558	\$ 1425.00	
Platform: 740FD	Endless Draper Belt 40' Right and Left Hand (2) Required (Inside Belts)	AMAXE36559	\$ 1669.00	
Platform: 925D Replaces AXE39582	Draper Side Belt 25' Right and Left Hand, 36.00" x 244.00"	AMAH159533	\$ 562.00	
Platforms: 925D, 930D, 936D Replaces AH159538, AH173119, AXE12053	Center Feeder Belt 25', 30' or 36', 60.00" x 63.56"	AMAH203047	\$ 429.00	
Platform: 930D	Draper Side Belt 30' Right and Left Hand, 36.00" x 304.00" Replaces AXE39583	AMAH159534	\$ 678.00	
Platform: 930D w/ Windrow Option	Draper Side Belt 30' Fixed, 36.00" x 86.00" Replaces AXE39586	AMAH159557	\$ 230.00	
Platforms: 930D, 936D - w/ Windrow Option	Draper Side Belt 30' or 36' Movable, 36.00" x 218.00" Replaces AXE39587	AMAH159558	\$ 545.00	
Platform: 936D	Draper Belt, HD 36' Right Hand, 36.00" x 420.00" Replaces AXE39585	AMAH159536	\$ 962.00	
	Draper Belt, HD 36' Left Hand, 36.00" x 332.00" Replaces AXE39584	AMAH159535	\$ 742.00	
Platform: 936D Short w/ Windrow Option	Draper Side Belt 36' Right Hand, 36.00" x 202.00" Replaces AXE39588	AMAH159537	\$ 505.00	
Platforms: 925D, 930D, 936D	Draper Belt Repair Kit For 36" Belt Includes 34" Repair Section of RAPTOR Material, Pre-Punched for Connector, (2) Steel Tube Connectors and Hardware	AM1014722	\$ 214.00	
Platforms: Most Models	Steel Tube Connector 7 Holes, 35" Long	AM1003863	\$ 30.25	
Platforms: 630FD, 635FD, 640FD, 645FD	Rubber Deflector For Center Feed Section	AMHXE119425	\$ 41.61	
Platforms: 625D, 630D, 635D, 640D, 725D, 730D, 735D, 740D	Knife Drive Belt 3-Banded Belt 53.02" Long	AMAH232955	\$ 89.00	
Draper Platform: 78	Draper Belt 9' Right or Left Hand, 40.00" x 73.00" Single V-Guide	AMAE25972	\$ 223.00	
	Draper Belt 11' Right or Left Hand, 40.00" x 97.00" Single V-Guide	AMAE23714	\$ 273.00	
	Draper Belt 11' Right or Left Hand, 42.00" x 94.00" Single V-Guide	AMAE24257	\$ 260.00	
	Draper Belt 36' Right Hand or Left Hand, 42.00" x 377.00" Single V-Guide	AMAE33360	\$ 889.00	
Draper Platform: 78 - w/ Narrow Platform	Draper Belt 10' Right or Left Hand, 40.00" x 86.00" Single V-Guide	AMAE20966	\$ 225.00	
Draper Platforms: 78, 88, 118	Draper Belt 12' Right or Left Hand, 42.00" x 110.00" Single V-Guide	AMAH18491H	\$ 278.00	

Prices Subject to Change without Prior Notice. The use of original equipment manufacturer (OEM) part numbers or trademarks, e.g. Case® and John Deere®, are for reference purposes only and for indicating product use and compatibility. Our company and the listed replacement parts contained herein are not sponsored, approved or manufactured by the OEM. All parts are New unless designated Reman in the description.

John Deere®—Combine

Application	Description	Part Number	Retail Price	Core
Draper Platforms: (78, 88, 118 - w/ Narrow Platform), 120	Draper Belt 14' Right or Left Hand, 42.00" x 134.00" Single V-Guide	AMAE20968	\$ 328.00	
Draper Platforms: 78, 88, 118, 120, 130, 135	Draper Belt 12' Right or Left Hand, 42.00" x 110.00" Single V-Guide	AMAE20967	\$ 280.00	
Draper Platforms: 78, 130 - w/ Narrow Platform	Draper Belt 15' Right or Left Hand, 40.00" x 138.00" Single V-Guide	AMAE34797	\$ 332.00	
Draper Platforms: 78, 130	Draper Belt 25' Right or Left Hand, 42.00" x 258.00" Single V-Guide	AMAE36834	\$ 609.00	
Draper Platform: 88	Draper Belt 14' Right or Left Hand, 42.00" x 134.00" Single V-Guide	AMAH18492H	\$ 336.00	
Draper Platforms: 88, 118	Draper Belt 10' Right or Left Hand, 42.00" x 86.00" Single V-Guide	AMAH18490H	\$ 254.00	
Draper Platform: 88	Draper Belt 16' Right or Left Hand, 42.00" x 158.00" Single V-Guide	AMAH18493H	\$ 392.00	
Draper Platforms: 118 w/ Narrow Platform	Draper Belt 16' Right or Left Hand, 42.00" x 157.00" Single V-Guide	AMAE20969	\$ 377.00	
Draper Platform: 130 Twin Swath	Draper Belt 21' Right or Left Hand, 42.00" x 186.00" Single V-Guide	AMAE38140	\$ 440.00	
Draper Platform: 130 (Twin Swath, Right Hand Short)	Draper Belt 40.00" x 47.00" Single V-Guide Replaces AE38276	AMAE24847	\$ 145.00	
Draper Platforms: 130, 135 - w/ Narrow Platform	Draper Belt Extension 12' or 15', 40.00" x 16.00" Narrow Extension Single V-Guide	AMAE32333	\$ 76.00	
	Draper Belt Extension 41.50" x 15.00", Regular Platform Extension Single V-Guide Replaces 1069543M91	AMAE36767	\$ 64.00	
Draper Platform: 420D	Draper Belt 20' Right or Left Hand, 41.60" x 157.24" Single V-Guide	AMAFH209068	\$ 469.00	

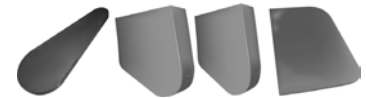

Header End Shields

Application	Description	Part Number	Retail Price	Core
Platforms: 213, 215, 216, 218, 220, 222, 224, 230, (912, 913, 914, 915, 918, 920, 922, 924, 925, 930, 936 BSN 635101), Pickup Platforms: 912, 914	Header End Shield Right Hand	AMAH88889	\$ 275.00	
Platforms: 213, 215, 216, 218, 220, 222, 224, 230	Reel Drive Shield	AMAH95481	\$ 245.00	

John Deere®—Combine

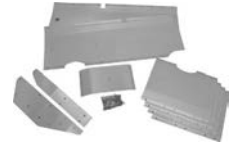

Poly Skid Plate Kits and Components

Application	Description	Part Number	Retail Price	Core
Platform: 213F	Poly Skid Plate Kit	13' CS13JD	\$ 399.00	
Platform: 215F	Poly Skid Plate Kit	15' CS15JD	\$ 430.00	
Platforms: 216F	Poly Skid Plate Kit	16' CS16JD	\$ 445.00	
Platform: 218F	Poly Skid Plate Kit	18' CS18JD	\$ 520.00	
Platform: 220F	Poly Skid Plate Kit	20' CS20JD	\$ 540.00	
Platform: 222F	Poly Skid Plate Kit	22' CS22JD	\$ 750.00	
Platform: 224F	Poly Skid Plate Kit	24' CS24JD	\$ 795.00	
Platform: 620F	Poly Skid Plate Kit	20' CS20JD6	\$ 760.00	
Platform: 625F	Poly Skid Plate Kit	25' CS25JD6	\$ 960.00	
Platform: 630F	Poly Skid Plate Kit	30' CS30JD6	\$ 1163.00	
Platform: 635F	Poly Skid Plate Kit	35' CS35JD6	\$ 1362.00	
Platform: 913F	Poly Skid Plate Kit	13' CS13JD9	\$ 520.00	
Platform: 915	Poly Skid Plate Kit	15' CS15JD9	\$ 455.00	
Platform: 918F	Poly Skid Plate Kit	18' CS18JD9	\$ 540.00	
Platform: 920F	Poly Skid Plate Kit	20' CS20JD9	\$ 615.00	
Platform: 922	Poly Skid Plate Kit	22' CS22JD9	\$ 670.00	
Platform: 924	Poly Skid Plate Kit	24' CS24JD9	\$ 820.00	
Platform: 925F	Poly Skid Plate Kit	25' CS25JD9	\$ 867.00	
Platform: 930F	Poly Skid Plate Kit	30' CS30JD9	\$ 826.00	
Platforms: 618F, 620F, 622F, 625F, 630F, 635F	Poly Skid Plate, Float Arm Standard Height Option	AMAH204994	\$ 54.97	
Platforms: 620F, 622F, 625F, 630F, 635F	Poly Skid Plate, Left End	AMH208626	\$ 15.00	
Platforms: 620F, 622F, 625F, 630F, 635F, 635FD, 640FD BSN 784999	Poly Skid Plate, Center	AMH205344	\$ 10.50	
Platforms: 620F, 625, 625F, 630F, 635, 635F, 640FD	Poly Skid Plate, Rear Right End	AMH170501	\$ 26.00	
	Poly Skid Plate, Left End	AMH170502	\$ 56.00	
Platforms: 620F, 625F, 630F, 635F, 640FD	Poly Skid Plate, Front Right End Standard Height	AMH209696	\$ 18.00	
Platforms: 630FD, 635FD, 640FD BSN 784999	Poly Skid Plate, Right End	AMHXE59505	\$ 87.00	
	Poly Skid Plate, Left End	AMHXE59506	\$ 87.00	
Platforms: (630FD, 635FD, 640FD BSN 784999)	Poly Skid Plate, Center Feed	AMHXE16408	\$ 209.00	
Platforms: (630FD, 635FD, 640FD ASN 785000), 645FD	Poly Skid Plate, Right End	AMHXE87670	\$ 87.00	
	Poly Skid Plate, Left End	AMHXE87669	\$ 87.00	
Platforms: 630FD, 635FD ASN 765000, 640FD BSN 784999, 645FD BSN 784999	Poly Skid Plate, Center	AMH231690	\$ 17.50	
Platforms: (630FD, 635FD ASN 785000), 640FD, 645FD	Poly Skid Plate, Rear, Small	AMHXE81731	\$ 9.00	
Platforms: 630FD*, 635FD**, 640FD*** *(38) Required **(44) Required ***(52) Required BSN 784599 and (50) Required ASN 785000	Poly Skid Plate Cover	AMHXE10959	\$ 15.00	
Platforms: 630FD, 635FD, 640FD, 645FD, 730FD, 740FD, 745FD	Poly Skid Plate, Clean Out Door	AMHXE54477	\$ 245.00	



John Deere®—Combine

Application	Description	Part Number	Retail Price	Core
Cutting Platforms: 615F, 615R, 618F, 618R, 620F, 620R, 622F, 622R, 625F, 625R, 630F, 630R, 635F, 635R	Poly Skid Plate, Front, Right Hand Raised Rivets Not Included	AMH204243	\$ 32.67	
	Poly Skid Plate, Rear, Right Hand Raised	AMH204244	\$ 56.16	
	Poly Skid Plate, Left Hand	AMH218047	\$ 76.79	
	Poly Skid Plate, Left Hand Raised For Float Arm Stabilizer	AMH211864	\$ 44.23	
	Poly Skid Plate, Left Hand For Standard Height Float Arm Stabilizer	AMH215075	\$ 62.12	
	Poly Skid Plate, Center Raised For Float Arm w/ Increased Height Option	AMH204221	\$ 17.60	
	Poly Skid Plate, Float Arm Raised For Float Arm w/ Increased Height Option	AMH204225	\$ 33.99	
Draper Platforms: 645FD ASN 785000, 730FD, 735FD, 740FD, 745D	Poly Skid Plate, Cutterbar For Standard Cut Height	AMHXE87738	\$ 18.40	
For John Deere® Poly Skid Plates	Poly Skid Plate Rivet, Aluminum Sold in Multiples of 25, Priced Individually Replaces HXE52669	AMRVT531	\$ 0.35	





Hoods

Application	Description	Part Number	Retail Price	Core
Sprayer: 4920	Hood Fiberglass Construction, Pre-Painted Replaces RE169901, RE194633	AMRE215791	\$ 4200.00	



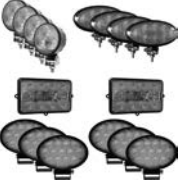

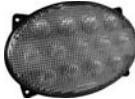

Lighting

Application	Description	Part Number	Retail Price	Core
 9560SH, 9570STS, 9660, 9670STS, 770STS, 9860STS, Forage Harvesters: 7200, 7300, 7400, 7500, Sprayers: 710, 4920, 4930	Replacement Bulb	AMRE179326	\$ 6.30	
 9560, 9560SH, 9560STS, 9570STS, 9650STS, 9660, 9660STS, 9670STS, 9750STS, 9760STS, 9770STS, 9860STS, 9870STS, Cotton Pickers: 7460, 7660, 7760, 9960, CP690, CS690, Sprayers: 4720, 4730, 4830, 4920, 4930, Swathers: 4895, 4995, A400, D450, R450	LED Floodlight Conversion Kit (2) 6.50" x 4.50" Oval Lights, Each Light is 5000 Lumens, 60 Watts, 5 Amps For 12 Volt to 24 Volt Systems Includes Mounting Brackets, Stainless Steel Hardware and Wiring Harness (Plug-and-Play)	AMTL8320-KIT	\$ 368.00	
 9450, 9500, 9510, 9550, 9550SH, 9560, 9560SH, 9560STS, 9570STS, 9600, 9610, 9650, 9650STS, 9660, 9660CTS, 9660STS, 9670STS, 9750STS, 9760STS, 9770STS, 9870STS, CTS	LED Floodlight/Spotlight Combo Kit Includes (6) Combo Lights, Stainless Steel Hardware and Connector 4" x 6" Rectangle Combo Lights Each Light is 3500 Lumens, 60 Watts, 5 Amps For 12 Volt to 24 Volt Systems Uses Original Mount and Wiring	AMX34185	\$ 599.00	







John Deere®—Combine

Application	Description	Part Number	Retail Price	Core
 <p>9560, 9560SH, 9560STS, 9570STS, 9650STS, 9660, 9660STS, 9670STS, 9750STS, 9760STS, 9770STS, 9860STS, 9870STS</p>	<p>LED Light Kit Includes (6) Cab Mount LED Floodlights*, (2) Cab Mount LED Floodlight/Spotlight Combo Lights**, (6) LED Work Lights***, Connectors and Stainless Steel Mounting Hardware Uses Original Mount and Wiring *5200 Lumens, 65 Watts, 5.40 Amps **3500 Lumens, 60 Watts, 5 Amps ***2900 Lumens, 35 Watts, 2.90 Amps</p>	AMX34160	\$ 1544.00	
 <p>S550, S650, S660, S670, S670HM, S680, S680HM, S690, S690HM, S760, S770, S780, S790, T550, T560, T660, T670</p>	<p>LED Light Kit Includes (4) Cab Mount LED Headlights*, (4) Cab Mount LED Floodlight/Spotlight Combo Lights**, (2) Cab Mount LED Floodlight/Spotlight Combo Lights***, (6) LED Work Lights****, Connectors and Stainless Steel Mounting Hardware *2200 Lumens, 30 Watts, 2.50 Amps **3000 Lumens, 40 Watts, 3.30 Amps ***3500 Lumens, 60 Watts, 5 Amps ****2900 Lumens, 35 Watts, 2.90 Amps</p>	AMX34161	\$ 1523.00	
 <p>9560, 9560SH, 9560STS, 9570STS, 9650STS, 9660, 9660CTS, 9660STS, 9670STS, 9750STS, 9760STS, 9770STS, 9860STS, 9870STS Replaces R198623</p>	<p>LED Conversion Light Stubble Light 5.75" x 3.75" Oval Light 2900 Lumens, 35 Watts, 2.90 Amps For 12 Volt to 24 Volt Systems Includes Bracket and Connectors</p>	AMTL5650	\$ 100.00	
	<p>LED Conversion Light Stubble Light 5.75" x 3.75" Oval Light 2900 Lumens, 35 Watts, 2.90 Amps For 12 Volt to 24 Volt Systems Includes Bracket and Connectors</p>	AMAH207788	\$ 90.00	
 <p>Sprayers: 4720, 4730, 4830</p>	<p>LED Headlight Hood Mount 7.12" x 4.75" x 3" Oval Light Dual Hi/Lo Beam 5000 Lumens, 65 Watts, 5.40 Amps For 12 Volt to 24 Volt Systems Plug-and-Play, Uses Original Hardware Replaces RE181963, RE181964, RE205360</p>	AMTL7820	\$ 131.00	
 <p>Sprayers: 4720, 4730, 4830</p>	<p>LED Headlight Hood Mount 7" x 4.75" x 3.25" Oval Light Dual Hi/Lo Beam 5000 Lumens, 65 Watts, 5.40 Amps For 12 Volt to 24 Volt Systems Uses Original Mount and Hardware, Plug-and-Play Replaces RE181963, RE181964, RE205360</p>	AMRE181963	\$ 117.00	
 <p>S550 SN 745100-764999, (S650, S670HM, S680HM ASN 765000), (S660, S670, S680, S690 ASN 745100), S690HM SN 745101-765000, S760, S770, S780, S785, S790, T550, T560, T660, T670, Forage Harvesters: (8100, 8200, 8300, 8400, 8500, 8600, 8700, 8800 SN 513822-619999), (9600, 9700, 9800, 9900 SN 619000-619999)</p>	<p>LED Headlight 3.30" Round Light 2200 Lumens, 30 Watts, 2.50 Amps For 12 Volt to 24 Volt Systems Includes Swivel Mounting Bracket and Hardware Plug-and-Play for Direct Replacement</p>	AMTL8090	\$ 95.00	
	<p>LED Headlight 3.30" Round Light 2200 Lumens, 30 Watts, 2.50 Amps For 12 Volt to 24 Volt Systems Includes Swivel Mounting Bracket and Hardware Plug-and-Play</p>	AMAXE20661	\$ 85.00	



John Deere®—Combine

	Application	Description	Part Number	Retail Price	Core
	Forage Harvesters: 6650, 6750, 6850, 6950, 7180, 7200, 7250, 7280, 7300, 7350, 7380, 7400, 7450, 7480, 7500, 7550, 7580, 7700, 7750, 7780, 7800, 7850, 7950, 7980 Replaces 3713134M91, AZ41570	LED Headlight Floodlight/Spotlight Combo 7.25" x 3.25" x 3.25" Rectangle Light 3500 Lumens, 40 Watts, 3.30 Amps For 12 Volt to 24 Volt Systems	AMTL9090	\$ 110.00	
		LED Headlight Floodlight/Spotlight Combo 7.25" x 3.25" x 3.25" Rectangle Light 3500 Lumens, 40 Watts, 3.30 Amps For 12 Volt to 24 Volt Systems	AMAX41570	\$ 99.00	
	Sprayers: 4720, 4730, 4830	LED Headlight, Right Hand Outside Corner Mount 6.50" x 4.75" x 2.75" Oval Light 2000 Lumens, 30 Watts, 2.50 Amps For 12 Volt to 24 Volt Systems Uses Original Mount and Wiring, Plug-and-Play Replaces RE205362	AMTL7830R	\$ 121.00	
		LED Headlight, Left Hand Outside Corner Mount 6.50" x 4.75" x 2.75" Oval Light 2000 Lumens, 30 Watts, 2.50 Amps For 12 Volt to 24 Volt Systems Uses Original Mount and Wiring, Plug-and-Play Replaces RE205361	AMTL7830L	\$ 121.00	
		LED Headlight, Right Hand Outside Corner Mount 6.50" x 4.75" x 2.75" Oval Light 2000 Lumens, 30 Watts, 2.50 Amps For 12 Volt to 24 Volt Systems Uses Original Mount and Wiring, Plug-and-Play Replaces RE205362	AMRE181913	\$ 117.00	
		LED Headlight, Left Hand Outside Corner Mount 6.50" x 4.75" x 2.75" Oval Light 2000 Lumens, 30 Watts, 2.50 Amps For 12 Volt to 24 Volt Systems Uses Original Mount and Wiring, Plug-and-Play Replaces RE205361	AMRE181916	\$ 117.00	
	4400, 6620, 6622, 7720	Halogen Floodlight, Sealed Beam 4.50" Diameter Round Light 2-Terminal Connection For 12 Volt Systems Replaces A47179, AR104119, E3NN15330AA	AMH7606	\$ 10.00	
	Universal Equipment	LED Floodlight All-Position Light 4.25" x 4.25" Square Light 2650 Lumens, 48 Watts, 4 Amps For 12 Volt to 24 Volt Systems Includes Mounting Bracket and Stainless Steel Hardware	AMTL105F	\$ 74.00	
	Universal Equipment	LED Floodlight All-Position Light 6.25" x 1.75" Rectangle Light 1300 Lumens, 18 Watts, 1.50 Amps For 12 Volt to 24 Volt Systems Includes Mounting Bracket and Stainless Steel Hardware	AMTL118F	\$ 53.00	
	Universal Equipment	LED Floodlight All-Position Light 5" Round Light 3200 Lumens, 40 Watts, 3.30 Amps For 12 Volt to 24 Volt Systems Includes Mounting Bracket and Stainless Steel Hardware	AMTL180	\$ 95.00	





John Deere®—Combine

Application	Description	Part Number	Retail Price	Core
 Universal Equipment	LED Floodlight All-Position Light Round Light 6900 Lumens, 50 Watts, 4.10 Amps For 9 Volt to 32 Volt Systems Includes Mounting Bracket and Stainless Steel Hardware	AMTL500F	\$ 126.00	
	LED Floodlight All-Position Light 4.30" Round Light 5040 Lumens, 50 Watts, 4.10 Amps For 12 Volt to 24 Volt Systems Includes Stainless Steel Adjustable Mounting Bracket	AMAT305931	\$ 113.00	
 Universal Equipment	LED Floodlight All-Position Light 4.25" Round Light 2650 Lumens, 42 Watts, 3.50 Amps For 12 Volt to 24 Volt Systems Includes Mounting Bracket and Stainless Steel Hardware	AMTL115F	\$ 62.00	
 Sprayers: 4700, 4710, Swathers: 4890, 4895, 4990, 4995 Replaces RE154898, RE154900, RE154901, RE154902, RE154903, RE154904, RE154906	LED Floodlight Rectangle Light 3200 Lumens, 40 Watts, 3.20 Amps For 12 Volt to 24 Volt Systems Includes Interchangeable Mounts	AMTL8400	\$ 104.00	
	LED Floodlight 6" x 4" Rectangle Light 3200 Lumens, 40 Watts, 3.20 Amps For 12 Volt to 24 Volt Systems	AMRE154908	\$ 93.00	
 9560, 9560SH, 9560STS, 9570STS, 9660, 9660CTS, 9660STS, 9760STS, 9770STS, 9860STS, 9870STS, S550, S650 ASN 765000, (S660, S670, S680, S690 ASN 745100), (S670HM, S680HM BSN 765000), S690HM SN 745101-765000, S760, S770, S780, S785, S790, T550, T560, T660, T670 Replaces AH207788, AXE16947, AXE40244	LED Floodlight 5.75" x 3.75" x 3" Oval Light 2900 Lumens, 35 Watts, 2.90 Amps For 12 Volt to 24 Volt Systems Includes Stainless Steel Mounting Hardware and Mounting Bracket	AMTL5655	\$ 100.00	
 Universal Equipment	LED Wide Floodlight All-Position Light 5" x 7" Rectangle Light 3800 Lumens, 35 Watts For 12 Volt to 24 Volt Systems Replaces AT135485, AT135486, AT305931, AT443223, AT443224	AMX34171	\$ 60.00	
 Universal Equipment	LED Floodlight, Sealed Beam Fender Mount 4.50" Diameter Round Light 1250 Lumens, 18 Watts, 1.50 Amps Trapezoid Pattern For 12 Volt to 24 Volt Systems Replaces AF3892R, AT25451, RE285628, RE336111, RE561116, RE561117	AMTL3010	\$ 42.00	
	LED Floodlight Fender Mount 4.50" Diameter Sealed Beam Round Light 1250 Lumens, 18 Watts, 1.20 Amps Trapezoid Pattern For 12 Volt to 24 Volt Systems Lasts 50 times longer than halogen lighting, vibration resistant w/ no filament failures, uses original mount and wiring, Operating temperature of -40°F to 140°F / -40°C to 60°C Replaces AF3892R, AT25451, RE285628, RE336111, RE561116, RE561117	AMRE336111	\$ 37.00	







John Deere®—Combine

Application	Description	Part Number	Retail Price	Core
 Universal Equipment	LED Floodlight Fender Mount 4.50" Diameter Sealed Beam Round Light 1440 Lumens, 18 Watts, 1.60 Amps Lasts 50 times longer than halogen lighting, vibration resistant w/ no filament failures, 2-terminal connection, Operating temperature of -40°F to 140°F / -40°C to 60°C Replaces RE285628	AMRE336112	\$ 68.00	
 Sprayers: 4720, 4730, 4830, 4920, 4930 Replaces RE173600, RE260102	LED Floodlight Hood Mount 6.50" x 4.50" x 4" Oval Light Dual Hi/Lo Beam 6000 Lumens, 65 Watts, 5.40 Amps For 12 Volt to 24 Volt Systems Uses Original Mount and Wiring, Plug-and-Play	AMTL8520S	\$ 131.00	
 Sprayers: 4920, 4930 Replaces RE180613, RE181282, RE271573, RE271574	LED Floodlight Hood Mount 5.50" x 3.75" Oval Light 3000 Lumens, 35 Watt, 2.90 Amps For 12 Volt to 24 Volt Systems Use Original Mount and Wiring, Plug-and-Play	AMTL8220	\$ 121.00	
	LED Floodlight Hood Mount 5.50" x 3.75" Oval Light 3000 Lumens, 39 Watts, 2.90 Amps For 12 Volt to 25 Volt Systems Includes Connector for Plug-and-Play Installation Replace 86038024, RE180613, RE181282, RE271573	AMRE271574	\$ 108.00	
 Cotton Stripper: 7460	LED Floodlight Replacement Hood and Cab Mount 2.49" x 5.44" Rectangle Light 1440 Lumens, 12 Watts, 1 Amp For 12 Volt to 24 Volt Systems Uses Original Mount and Wiring Replaces R161288, RE37450, RE306510	AMX34182	\$ 47.00	
	LED Floodlight Replacement Hood and Cab Mount 2.49" x 5.44" Rectangle Light 1440 Lumens, 12 Watts, 1 Amp For 12 Volt to 24 Volt Systems Replaces RE161288, RE37450, RE37849	AMRE306510	\$ 32.00	
 9780CTS, C670, T550, T560, T660, T670, Forage Harvesters: 7180, 7200, 7250, 7280, 7300, 7350, 7380, 7400, 7450, 7480, 7500, 7550, 7580, 7700, 7750, 7780, 7800, 7850, 7950, 7980, Sprayers: 4630, R4023, R4030, R4038, R4045	LED Floodlight 4.25" x 4.50" x 3.00" Oval Light 3200 Lumens, 40 Watts, 3.20 Amps For 12 Volt to 24 Volt Systems Housing Has Powder Coat Finish Includes 2-Terminal Connector, Mounting Bracket and Stainless Steel Hardware Replaces AL150478, AL174341, AL175528, AL175529, AL202742, AL202743, AL205375, RE219708, RE233263, RE567623	AMTL5670	\$ 110.00	
	LED Floodlight 4.25" x 4.50" x 3" Oval Light 3200 Lumens, 40 Watts, 3.20 Amps For 12 Volt to 24 Volt Systems Housing Has Powder Coat Finish Includes 2-Terminal Connector, Mounting Bracket and Stainless Steel Hardware Replaces AL150478, AL174341, AL175528, AL175529, AL202742, AL202743, AL205375, RE219708, RE233263	AMRE567623	\$ 99.00	





John Deere®—Combine

Application	Description	Part Number	Retail Price	Core
 <p>Forage Harvesters: 7200, 7300, 7400, 7500, 7700, 7800</p>	<p>LED Floodlight Cab Mount 4.25" x 4.50" Oval Light 3600 Lumens, 40 Watts, 3.20 Amps For 12 Volt to 24 Volt Systems Replaces RE567623, AL150478, AL156627, AL174341, AL175528, AL175529, AL202742, AL202743, AL205375</p>	AMRE219708	\$ 99.00	
 <p>Universal Equipment</p>	<p>LED Floodlight Cab and Fender Mount 3.50" x 6" Rectangle Light 3600 Lumens, 40 Watts, 3 Amps</p>	AMX34146	\$ 65.00	
 <p>9560, 9560SH, 9560STS, 9570STS, 9650STS, 9660, 9660STS, 9670STS, 9750STS, 9760STS, 9770STS, 9860STS, 9870STS, Cotton Pickers: 7660, 7760, 9996, CP690, CS690, Cotton Stripper: 7460, Sprayers: 4710, 4720, 4730, 4830, 4920, 4930, 4940, Swathers: 4895, 4995, A400, D450, R450 Replaces AH212522, AH212576, RE181281</p>	<p>LED Floodlight Upper Front and Rear Cab, Rear Fender and Mid Mount 6.50" x 4" Oval Light 5200 Lumens, 65 Watts, 5.40 Amps For 12 Volt to 24 Volt Systems Housing Has Powder Coat Finish Includes Mounting Bracket and Stainless Steel Hardware</p>	AMTL5680	\$ 131.00	
	<p>LED Floodlight Upper Front and Rear Cab, Rear Fender and Mid Mount 6.50" x 4" Oval Light 5500 Lumens, 65 Watts For 12 Volt to 24 Volt Systems Housing Has Powder Coat Finish Includes Connector and Bracket for Plug-and-Play Installation</p>	AMAH212523	\$ 117.00	
 <p>Forage Harvesters: 6610, 6650, 6710, 6750, 6810, 6850, 6910, 6950, Sprayers: 4700, 4710, 4720, 6500, 6600, 6700</p>	<p>LED Floodlight/Spotlight Combo Grille Mount 6" x 4" Rectangle Light 3500 Lumens, 60 Watts, 5 Amps For 12 Volt to 24 Volt Systems Includes Connector, Adapter and Stainless Steel Hardware Replaces AL75338</p>	AMTL6700	\$ 116.00	
	<p>LED Floodlight/Spotlight Combo Grille Mount 6" x 4" Rectangle Light 3500 Lumens, 60 Watts, 5 Amps For 12 Volt to 24 Volt Systems Includes Connector, Adapter and Mounting Hardware</p>	AMAL75338	\$ 104.00	
 <p>9400, 9410, 9450, 9500, 9510, 9550, 9560, 9570STS, 9600, 9610, 9650, 9660, 9670STS, 9750STS, 9760STS, 9860STS, 9870STS, 9880STS, CTS, Cotton Picker: 9986, Forage Harvesters: 7200, 7300, 7400, 7500, 7700, 7800, Swathers: 4895, 4990, 4995 Replaces AH128328, AH159332, AH159333, AH170565</p>	<p>LED Floodlight/Spotlight Combo Cab Mount 4" x 6" Rectangle Light 3500 Lumens, 60 Watts, 5 Amps (4) Required For 12 Volt to 24 Volt Systems Connector Included, Plug-and-Play</p>	AMTL9000	\$ 104.00	
	<p>LED Floodlight/Spotlight Combo Cab Mount 4" x 6" Rectangle Light 3500 Lumens, 60 Watts, 5 Amps (4) Required For 12 Volt to 24 Volt Systems Includes Connector, Plug-and-Play</p>	AMAH128327	\$ 93.00	



John Deere®—Combine

Application	Description	Part Number	Retail Price	Core
 <p>S550, S650, S660, S670, S670HM, S680, S680HM, S690, S690HM, S760, S770, S780, T550, T560, T660, T670, Forage Harvesters: 8100, 8200, 8300, 8400, 8500, 8600, 8700, 8800, Sprayers: R4023, R4030, R4038, R4045, Swathers: W235, W260</p>	<p>LED Floodlight/Spotlight Combo Cab Mount 6" x 3" x 3.25" Oval Light 3000 Lumens, 40 Watts, 3.30 Amps For 12 Volt to 24 Volt Systems Plug-and-Play for Direct Replacement Replaces RE269640, RE331643, RE573609</p>	AMTL8060	\$ 100.00	
	<p>LED Floodlight/Spotlight Combo Cab Mount 6" x 3" x 3.25" Oval Light 3000 Lumens, 40 Watts, 3.30 Amps For 12 Volt to 24 Volt Systems Plug-and-Play for Direct Replacement Replaces AL207359, RE269640, RE331643, RE573609</p>	AMRE269638	\$ 90.00	
 <p>Universal Equipment</p>	<p>LED Spotlight All-Position Light 4.25" x 4.25" Square Light 1400 Lumens, 27 Watts, 2.20 Amps For 12 Volt to 24 Volt Systems</p>	AMTL100S	\$ 47.00	
 <p>Universal Equipment</p>	<p>LED Spotlight All-Position Light 6.25" x 1.75" Rectangle Light 1300 Lumens, 18 Watts, 1.50 Amps For 12 Volt to 24 Volt Systems Includes Mounting Bracket and Stainless Steel Hardware</p>	AMTL118S	\$ 53.00	
 <p>Universal Equipment</p>	<p>LED Spotlight All-Position Light Round Light 6900 Lumens, 50 Watts, 4.10 Amps For 9 Volt to 32 Volt Systems Includes Mounting Bracket and Stainless Steel Hardware</p>	AMTL500S	\$ 126.00	
 <p>3300, 4400, 4420, 6600, 6602, 6620, 6622, 7700, 7720, 7721, 8820</p>	<p>LED Trapezoid Light Fender Mount 4.50" Sealed Beam Round Light 2200 Lumens, 24 Watts, 2 Amps For 12 Volt to 24 Volt Systems Uses Original Mount and Wiring Replaces RE336111</p>	AMTL3015	\$ 52.00	
 <p>Universal Equipment</p>	<p>LED Trapezoid Light Cab and Fender Mount 4.50" Diameter Round Light 2800 Lumens, 40 Watts, 3.30 Amps Trapezoid Pattern For 12 Volt to 24 Volt Systems Bottom Mount w/ Built-In Heat Sink Includes Mounting Bracket, Long and Short Rubber Bezels, and Stainless Steel Hardware Replaces AR85260, RE19079</p>	AMTL2080	\$ 100.00	
	<p>LED Trapezoid Light Cab and Rear Fender Mount 4.50" Diameter Round Light 2800 Lumens, 40 Watts, 3.30 Amps Trapezoid Pattern For 12 Volt to 24 Volt Systems Bottom Mount w/ Built-In Heat Sink Includes Mounting Bracket, Long and Short Rubber Bezels and Stainless Steel Hardware Replaces AR85260, RE19079</p>	AMX33121	\$ 90.00	

John Deere®—Combine

Application	Description	Part Number	Retail Price	Core
 Universal Equipment	LED Warning Light Cab, Header or Swather Mount Can be used for Turn Signal, Brake or Running Lights 4.125" Diameter Round Light Double Sided, Amber Lenses 25 Bulbs per Side For 12 Volt to 24 Volt Systems	AMTLFL2	\$ 58.00	
	LED Warning Light Cab, Header or Swather Mount Can be used for Turn Signal, Brake or Running Lights 4.125" Diameter Round Light Double Sided, Amber Lenses 25 Bulbs per Side For 12 Volt to 24 Volt Systems	AMX1910149	\$ 52.00	
 Universal Equipment	LED Warning Light Cab, Header or Swather Mount Can be used for Turn Signal, Brake or Running Lights 4.125" Diameter Round Light Double Sided, Red and Amber Lenses 25 Bulbs per Side For 12 Volt to 24 Volt Systems	AMTLFL3	\$ 58.00	
	LED Warning Light Cab, Header or Swather Mount Can be used for Turn Signal, Brake or Running Lights 4.125" Diameter Round Light Double Sided, Red and Amber Lenses 25 Bulbs per Side For 12 Volt to 24 Volt Systems	AMX33126	\$ 52.00	
 Cotton Pickers: 9900, 9910, 9920, 9930, 9940, 9950, 9960, 9965, 9970, Cotton Stripper: 484 - All w/ Sound-Gard™ Cab	LED Warning Light Cab Mount 2" x 7.75" Rectangle Light Amber Lens 9 Watts, 0.75 Amp For 12 Volt to 24 Volt Systems Requires 6 Ohm Load Resistor if 4 Lights are installed	AMX34184	\$ 53.00	
	LED Warning Light Cab Mount 2" x 7.75" Rectangle Light Amber Lens 9 Watts, 0.75 Amp For 12 Volt to 24 Volt Systems Requires 6 Ohm Load Resistor if 4 Lights are installed	AMAR60250	\$ 40.00	
 Universal Equipment	LED Magnetic Warning Light All-Position Light 360° Flashing Light, Multiple Patterns 9.50" x 6.75" Rectangle Light Magnetic Base or Solid Mount For 12 Volt to 24 Volt Systems Includes Cigarette Lighter Adapter, Wiring and Switch	AMTL1100	\$ 179.00	
 Universal Equipment	LED Magnetic Warning Light All-Position Light 360° Flashing Light, Multiple Patterns 14" x 6.75" Rectangle Light Magnetic Base or Solid Mount For 12 Volt to 24 Volt Systems Includes Cigarette Lighter Adapter, Wiring and Switch	AMTL1200	\$ 200.00	
Universal Equipment	Warning Beacon 360° Flashing Beacon, Amber Lens For 0.9435" Diameter Pipe Replaces 84337818, AZ44705, AZ101891	AM82018390	\$ 52.48	

John Deere®—Combine

	Application	Description	Part Number	Retail Price	Core
	Universal Equipment	LED Warning Beacon 360° Flashing Beacon 2.75" x 5.25" Light Polycarbonate Amber Lens and Housing For 12 Volt to 24 Volt Systems Includes Solid Mounting Pad and Stainless Steel Hardware	AMTL2100	\$ 32.00	
	Universal Equipment	LED Warning Beacon 360° Flashing Beacon, 3 Different Patterns 5" x 10" Light Amber Lens, 48 Watts, 4 Amps For 12 Volt to 24 Volt Systems Brackets Sold Separately	AMX33131	\$ 79.00	
	Universal Equipment	Warning Beacon Bracket	AMX33132	\$ 16.00	
	Universal Equipment	Warning Beacon Bracket	AMX33133	\$ 16.00	
	Universal Equipment	Warning Beacon Bracket	AMX33137	\$ 16.00	
	Universal Equipment	Warning Beacon Bracket	AMX33135	\$ 16.00	
	9660, (S650, S670 BSN 785001), S660 SN 765172-785000, S680, S690 SN 765250-785000, (S760, S770, S780, S790 ASN 1Z0S760XXX110000), Cotton Pickers: 7760, CP690, Cotton Stripper: CS690, Forage Harvesters: 6650, 6750, 6850, 6950, 7180, 7200, 7250, 7280, 7300, 7350, 7380, 7400, 7450, 7480, 7500, 7550, 7580, 7700, 7750, 7780, 7800, 7850, 7950, Sprayers: 4940, R4023, R4030, R4038, R4045, R4060	Tail Light Assembly	AMAL112964	\$ 46.23	
	Cotton Pickers: 9900, 9910, 9920, 9930, 9940, 9950, 9960, 9965, 9970, Cotton Strippers: 484, 7440, 7445, Forage Harvesters: 5440, 5460, 5720, 5730, 5820, 5830, Sprayers: 6100, 6500, 6600	LED Tail Light Oval Light, Red Lens 9 Watts, 0.75 Amp For 12 Volt to 24 Volt Systems Replaces RE39223	AMAR78825	\$ 46.00	









John Deere®—Combine

Application	Description	Part Number	Retail Price	Core
 Universal Equipment	LED Light Bar 4" Long, 1260 Lumens, Cree Bulbs	AMLED4	\$ 45.00	
	LED Light Bar Flood/Spotlight Combo 10" Long, 5700 Lumens, 50 Watts, 4.20 Amps For 12 Volt to 24 Volt Systems Includes Mounting Bracket and Stainless Steel Hardware	AMTL10SRC	\$ 135.00	
	LED Light Bar Floodlight/Spotlight Combo 14" Long, 5400 Lumens, 72 Watts, 6 Amps Die Cast Aluminum Housing, Polycarbonate Lens For 12 Volt to 24 Volt Systems Includes Mounting Bracket and Heavy Duty Stainless Steel Hardware	AMTLB410C	\$ 158.00	
	LED Light Bar Floodlight/Spotlight Combo 30" Long, 13600 Lumens, 150 Watts, 12.50 Amps For 12 Volt to 24 Volt Systems Includes Mounting Bracket and Stainless Steel Hardware	AMTL30SRC	\$ 242.00	
	LED Light Bar 30" Long, 13860 Lumens, Cree Bulbs	AMLED30	\$ 130.00	
	LED Light Bar Floodlight/Spotlight Combo 40" Long, 17300 Lumens, 200 Watts, 16.70 Amps For 12 Volt to 24 Volt Systems Includes Mounting Brackets and Stainless Steel Hardware	AMTL40SRC	\$ 315.00	
	LED Light Bar 40" Long, 18200 Lumens, Cree Bulbs	AMLED40	\$ 160.00	
	LED Light Bar Floodlight/Spotlight Combo 42" Long, 14500 Lumens, 240 Watts, 19 Amps For 12 Volt to 24 Volt Systems Includes Mounting Bracket and Stainless Steel Hardware Replaces 1163691	AMTLB440C	\$ 291.00	
	LED Light Bar, Curved 50" Long, 21500 Lumens, Cree Bulbs	AMLED50C	\$ 194.00	
 Sprayers: 4700, 4710	LED Corner Floodlight Cab Mount 8.75" x 4" Flashing Corner Light, Polycarbonate Amber Lens 18 Watts, 1.50 Amps For 12 Volt to 24 Volt Systems	AMTL8045	\$ 62.00	
 Universal Equipment	LED Magnetic Work Light All-Position Light 3.25" Square Floodlight 900 Lumens Magnetic Base Includes Lithium Ion Battery, Cigarette Lighter and DC Charger	AMTL2460	\$ 83.00	
 Universal Sprayers	LED Blue Work Light 4.25" x 4.50" x 3.00" Rectangle Light 2650 Lumens, 42 Watts, 3.50 Amps For 12 Volt to 24 Volt Systems Includes Stainless Steel Hardware and Mounting Bracket	AMTLFL5	\$ 62.00	

John Deere®—Combine

Application	Description	Part Number	Retail Price	Core
3300 ASN 100000, 4400 ASN 101300, 4420, 6600 ASN 105800, 6620, 7700 ASN 111900, 7720, 8820, Cotton Pickers: 9910, 9920, 9930, 9935, 9940, 9950, 9960, 9965, 9970, 9976, Cotton Strippers: 484, 7440, 7445, 7450, 7455, Forage Harvesters: (5440, 5460 BSN 490001), 5720, 5730, 5820, 5830, Sprayers: 6100, 6500, 6600, Swathers: 2320, 2420, 3430, 3830	Control Switch, Turn Signal Replaces AR67398	AMAR64422	\$ 64.26	
Cotton Pickers: 9900, 9910, 9940, 9950, 9960, Forage Harvesters: 5200, 5400, Sprayer: 6000, Swathers: 2280, 2360	Control Switch, Flashing Warning Light Replaces AR67398	AMAR64422	\$ 64.26	

Tie Rods and Components

Application	Description	Part Number	Retail Price	Core
 6620, 7720, 8820	Tie Rod 7" Long, 1" Diameter Right Hand, 16 Thread	AMAH101187	\$ 30.00	
 6620, 7720, 8820	Tie Rod 4.875" Long, 1" Diameter Left Hand, 16 Thread	AMAH101186	\$ 29.00	
 (6620, 7720 - w/ Adjustable Rear Axle), 8820, Cotton Pickers: 9940, 9950, 9965	Tie Rod Clamp	AMM2301T	\$ 6.00	
7700 ASN 036467	Tie Rod Tube 46.19" Long, 1 1/8" ID 12 UNF Right and Left Hand Internal Thread	AMR131288	\$ 231.40	
 9400, 9410, 9450, 9500, (9500SH, 9510SH, 9560SH - w/ Adjustable Rear Axle Only), 9510, 9550, 9560, 9600, 9610, 9650, 9660, 9660CTS, 9680, 9780CTS, CTS, CTS II	Inner Tie Rod 5.875" Long, 1.125" Diameter Right Hand Thread	AMRE12325	\$ 51.00	
 9400, 9410, 9450, 9500, (9500SH, 9510SH, 9560SH - w/ Adjustable Rear Axle Only), 9510, 9550, 9560, 9600, 9610, 9650, 9660, 9660CTS, 9680, 9780CTS, CTS, CTS II	Outer Tie Rod 5.875" Long, 1.125" Diameter Left Hand Thread	AMRE12326	\$ 55.00	
9400, 9410, 9450, 9500, 9510, 9550, 9550SH, 9560, 9560SH, 9600, 9610, 9650, 9650CTS, 9660, 9660CTS - w/ Adjustable Rear Axle	Tie Rod Tube, Right Hand 33.75" Long, 1 1/8" Diameter 12 Right Hand Thread	AMH130228	\$ 181.66	
9400, 9410, 9450, 9500, 9510, 9550, 9550SH, 9560, 9560SH, 9600, 9610, 9650, 9650CTS, 9660, 9660CTS - w/ Adjustable Rear Axle	Tie Rod Tube, Left Hand 33.75" Long, 1 1/8" Diameter 12 Left Hand Thread	AMH130227	\$ 181.66	
9560STS, 9570STS	Tie Rod	AMAH212899	\$ 97.00	
 (9560STS, 9570STS, 9650STS, 9660STS, 9670STS, 9750STS, 9760STS, 9770STS, 9860STS, 9870STS - 2WD)	Tie Rod	AMAH154441	\$ 97.00	
 (9560STS, 9570STS, 9650STS, 9660STS, 9670STS, 9750STS, 9760STS, 9770STS, 9860STS, 9870STS - 4WD)	Tie Rod	AMAH229183	\$ 128.00	
 9560STS, 9570STS, 9650STS, 9660STS, 9670STS, 9750STS, 9760STS, 9770STS, 9860STS, 9870STS, S550, S660, S670, S680, S690	Ball Joint	AMAH155001	\$ 97.00	
9570STS, 9670STS, 9770STS, 9870STS, S550, S660, S670	Tie Rod	AMAH231494	\$ 128.00	
2WD: (S550, S650, S660, S670, S680, S690 - w/ Standard Rear Axle), 4WD: (9570STS, 9670STS, 9770STS, 9870STS ASN 730100 w/ 2-Speed Rear Axle)	Tie Rod	AMAH231496	\$ 128.00	
S660, S670	Tie Rod	AMAH230771	\$ 128.00	

John Deere®—Combine

Application	Description	Part Number	Retail Price	Core
S660, S670, S680, S690	Tie Rod	AMAH230775	\$ 97.00	
Cotton Picker: 9920 w/ Wide Axle	Tie Rod Tube 20.50" Long	AMR54965	\$ 55.00	

Power Steering Cylinders and Components

Application	Description	Part Number	Retail Price	Core
3300, 4400, 4420, 6600, 6620, 7700, 7720, Cotton Strippers: 7440, 7445, Forage Harvesters: 5200, 5400, 5440, 5460, 5720, 5730, 5820, 5830, Sprayers: 6500, 6600	Power Steering Cylinder End 2.25" Long, 0.6875" ID 18 Right Hand Thread	AMAH75396	\$ 31.00	
(3300, 4400, 4420, 6600, 7700, 7720 - w/ Fixed or Adjustable Axle), Cotton Strippers: 7440, 7445, Forage Harvesters: 5200, 5400, 5440, 5460, 5720, 5730, 5820, 5830, Sprayers: 6500, 6600, 6700	Power Steering Cylinder End 2" Long, 11/16" Diameter 18 Right Hand Thread	AMAH75397	\$ 53.14	
(6602 ASN 353601, 6620, 6622, 7720, 7722, 8820 - w/ Heavy Duty and 4WD Rear Axles), Cotton Pickers: 9930 w/ Wide Axle and Dual Wheels, 9960, 9965, 9970 BSN 022001, Cotton Stripper: 7445 ASN 4001 w/ Wide Axle	Power Steering Cylinder End 3.75" Long, 1" Diameter 16 Right Hand Thread	AMAH94057	\$ 66.12	
9400, 9410, 9450, 9500, 9500SH, 9510, 9510SH, 9550, 9550SH, 9650, 9650SH, 9600, 9610, 9650, 9650CTS, 9660, 9660CTS, CTS, CTS II	Power Steering Cylinder End 2.75" Long, 0.875" Diameter 14 Right Hand Thread	AMAH204612	\$ 45.00	
9400, 9410, 9450, 9500, 9510, 9550, 9550SH, 9560, 9560SH, 9600, 9610, 9650, 9650CTS, 9660, 9660CTS	Power Steering Cylinder 19.035" Closed Length, 0.984" Rod Diameter, 1.969" Bore Diameter Replaces AH125658	AMAH166833	\$ 362.62	
Cotton Picker: 9970 ASN 020000	Power Steering Cylinder Replaces RE178676	AMRE247841	\$ 700.00	
Sprayers: 4630, 4700, 4710, 4720, 4730, 4830, 4920, 4930, R4023	Power Steering Cylinder End External Thread Replaces AN203649, AN203822	AMAN209415	\$ 78.00	
	Power Steering Cylinder End Internal Thread Replaces AN203648, AN203821	AMAN209414	\$ 80.00	



Rear Wheel Drive and Components

Application	Description	Part Number	Retail Price	Core
9450, 9550, 9550SH, 9560, 9560SH, 9560STS, 9650, 9650CTS, 9650STS, 9660, 9660CTS, 9660STS, 9670STS, 9750STS, 9760STS, 9770STS, 9860STS, 9880STS, S670, S690	Reman Motor, Right Hand Rear Wheel Assist, Cam Lobe Motor, 2-Speed Replaces AH218391, PG200938	AMAH210374	\$ 7500.00	\$ 1000.00
	Reman Motor, Left Hand Rear Wheel Assist, Cam Lobe Motor, 2-Speed Replaces AH218390, AXE13854, PG200937	AMAH210373	\$ 7500.00	\$ 1000.00
9500, 9500SH, 9510, 9510SH, 9550, 9550SH, 9600, 9610, 9650, 9650CTS, CTS, CTS II	Reman Motor, Right Hand Rear Wheel Drive, Cam Lobe Motor, 1600 cc	AMRE33338	\$ 7500.00	\$ 1000.00
	Reman Motor, Left Hand Rear Wheel Drive, Cam Lobe Motor, 1600 cc	AMRE33339	\$ 6790.00	\$ 1000.00
Cotton Pickers: 7660, 7760, CP690, Cotton Stripper: CS690, Forage Harvesters: (7200, 7300, 7400, 7500, 7700, 7800 BSN 508099)	Hydraulic Wheel Motor, Rear 107 cc Replaces AN372513	AMAZ59182	\$ 9500.00	
Forage Harvesters: 7180, (7200, 7300, 7400, 7500, 7700, 7800 ASN 508099), 7250, 7280, 7350, 7380, 7450, 7480, 7550, 7580, 7750, 7780, 7850	Hydraulic Wheel Motor 140 cc Replaces AZ71318	AMAZ104009	\$ 11914.00	
Forage Harvesters: 7200, 7250, 7280, 7300, 7350, 7380, 7400, 7450, 7480, 7500, 7550, 7580, 7700, 7750, 7780, 7800, 7850, 7950, 7980	Hydraulic Wheel Motor 140 cc Replaces AZ65955	AMAZ102511	\$ 11914.00	

Prices Subject to Change without Prior Notice. The use of original equipment manufacturer (OEM) part numbers or trademarks, e.g. Case® and John Deere®, are for reference purposes only and for indicating product use and compatibility. Our company and the listed replacement parts contained herein are not sponsored, approved or manufactured by the OEM. All parts are New unless designated Reman in the description.

John Deere®—Combine

Application	Description	Part Number	Retail Price	Core
Forage Harvesters: 7280, 7350, 7380, 7450, 7480, 7550, 7580, 7750, 7780, 7850, 7950, 7980	Hydraulic Wheel Motor 160 cc	AMAZ104083	\$ 12977.00	



Spindles

Spindles are forged from high grades of alloy steel, machined and assembled to exact specifications.

Application	Description	Part Number	Retail Price	Core
6600 ASN 254050, 6620, 7700, 7720 BSN 507351, Cotton Stripper: 484 ASN 776, Forage Harvesters: 5720, 5820	Spindle	Right Hand	AMAH87540	\$ 386.67
		Left Hand	AMAH87542	\$ 400.56
6620, 7720, 8820 - w/ Heavy Duty Axle	Spindle	Right Hand	AMAH94019	\$ 180.00
		Left Hand	AMAH94018	\$ 275.00
9400, 9410, 9500, 9500 SideHill, 9510, 9510 SideHill, 9600, 9610, CTS, CTS II	Spindle	Right Hand	AMAH125655	\$ 350.00
		Left Hand	AMAH125654	\$ 350.00
9450, 9550, 9550SH, 9560, 9560SH, 9560STS, 9570STS, 9650, 9650CTS, 9650STS, 9660, 9660CTS, 9660STS, 9670STS, 9750STS, 9760STS, 9770STS, 9860STS, 9870STS, S550, S650, S660, S670, S760, S770, Cotton Picker: 9996	Spindle 9.268" OD, M36x2.00" Right Hand Thread Replaces H164559, H201109	AMH201111	\$ 494.84	
9400, 9410, 9500, 9500 SideHill, 9510, 9510 SideHill, 9600, 9610, CTS, CTS II	Spindle Housing	AMAH156821	\$ 295.00	
9450, 9550, 9560, 9560STS, 9650, 9650CTS, 9660, 9660CTS	Spindle Housing For Regular Duty Axles, Fixed and Adjustable	AMAH162576	\$ 368.09	
9400, 9410, 9500, 9500 SideHill, 9510, 9510 SideHill, 9600, 9610, CTS, CTS II	Spindle Housing Bushing	AMH158884	\$ 20.07	
9400, 9410, 9450, 9500, 9500SH, 9550, 9560, 9600, 9610, 9650, 9650CTS, 9660, 9660CTS, CTS	Rear Axle Support Pivot Bushing 2" Wide, 5" ID, 5.20" OD Replaces H114473	AMH146281	\$ 63.52	
9450, 9550, 9560, 9560SH, 9560STS, 9570STS, 9650, 9650CTS, 9650STS, 9660, 9660CTS, 9660STS, 9670STS, 9750STS, 9760STS, 9770STS, 9860STS, 9870STS, S550, S650, S660, S670, S760, S770, Cotton Picker: 9996 w/ Non-Powered Axle	Rear Spindle Bushing 1.624" Long, 2.002" ID, 2.191" OD	AMH201736	\$ 11.69	
9450, 9550, 9550SH, 9560, 9560SH, 9560STS, 9570STS, 9650CTS, 9650STS, 9660, 9660CTS, 9660STS, 9750STS, 9760STS, 9860STS, 9870STS, S550, S650, S660, S670, S760, S770, Cotton Picker: 9996 w/ Non-Powered Axle	Spindle Pin, Rear	AMH164561	\$ 61.63	



Wheel Hubs and Components

Application	Description	Part Number	Retail Price	Core
(6620, 7720, 8820 - w/ Heavy Duty Axle), 9400, 9410, 9500, 9510, 9600, 9610, CTS, CTS II	Wheel Hub	AMH94814	\$ 135.00	
7700, Cotton Pickers: 9900, 9910, 9920, 9930, Cotton Stripper: 7445, Sprayers: 6000, 6500	Wear Sleeve	AMR26632	\$ 4.00	
Cotton Pickers: 9920, 9930, Cotton Stripper: 7445	Wheel Hub, 8-Bolt Use w/ R50992 Press-On Hub Cap	AMR49841	\$ 87.00	
Platforms: 930, 936D, Swathers: 4895, 4995	Hub Assembly, 6-Bolt Replaces AN150825	AMAN183318	\$ 82.39	

John Deere®—Combine

Step Components

Application	Description	Part Number	Retail Price	Core
9400, 9410, 9450, 9500, 9500SH, 9510, 9510SH, 9550, 9550SH, 9560, 9560SH, 9560STS, 9570STS, 9600, 9610, 9650, 9650CTS, 9650STS, 9660, 9660CTS, 9660STS, 9670STS, 9750STS, 9760STS, 9770STS, 9860STS, 9870STS, CTS, CTS II	Plastic Hanger For Bottom Step	AMH136126	\$ 35.67	
	Rubber Hanger For Bottom Step	AMH136126R	\$ 28.54	
S550, S650, S660, S670, S670HM, S680, S680HM, S690, S690HM, T550, T560, T660, T670	Rubber Hanger 22" Long	AMHXE41289	\$ 70.00	
	Rubber Hanger 23 5/8" Long	AMHXE41292	\$ 70.00	

Styling Panels

Application	Description	Part Number	Retail Price	Core
9560STS ASN 720100, 9570STS, (9660STS, 9760STS ASN 715400), 9670STS, 9770STS, 9860STS ASN 715600, 9870STS, S550	Rear Wall Panel	AMAH213310	\$ 3000.00	

Gas Struts



Application	Description	Part Number	Retail Price	Core
Sprayer: 4630	Gas Strut, Hood	AMAL174087	\$ 33.00	
Sprayer: 4630	Gas Strut, Door Replaces AL78435, AL110629, AL151278	AMAL174358	\$ 19.00	
Sprayers: 4700, 4710 Replaces RE58715, RE234998	Gas Strut, Door	AM1343825C1	\$ 19.00	
9400, 9410, 9450, 9500, 9510, 9550, 9560, 9570STS, 9600, 9610, 9650, 9660, 9670STS, 9750STS, 9760STS, 9770STS, 9860STS, 9870STS, CTS, CTS II, S650, S660, S670, S680, S690	Gas Strut, Gullwing Door Service Access Shield and Rear Corner Sheet Replaces AH128598, AH128597	AMAH161391	\$ 19.00	
9560, 9570STS, 9650, 9660, 9670STS, 9750STS, 9760STS, 9770STS, 9860STS, 9870STS, S550, S660, S670, S680, S690	Gas Strut, Gullwing Door Replaces AH128597	AMAH161392	\$ 30.00	
Cutting Platforms: 600F, 600R	Gas Strut, End Shield	AMRE70191	\$ 19.00	
Forage Harvesters: 8100, 8200, 8300, 8400, 8500, 8600, 8700, 8800, 9600, 9700, 9800, 9900	Gas Strut, Rotary Screen Door	AMAL57946	\$ 23.15	

Fuel Tanks and Components

Made of high-quality polyethylene material

Application	Description	Part Number	Retail Price	Core
9400 w/ 6068HH050 Engine ASN 701276, Cotton Pickers: 9930 ASN 14000, 9935 BSN 766837, Cotton Strippers: 7445 ASN 16000, 7455 BSN 766837, Sprayers: 4700 BSN 780979, 6100, 6500, 6600, Swathers: 4890 BSN 706489, 4990	Fuel Filter Head Assembly	AMRE500160	\$ 71.11	
9400, 9410, 9450, Cotton Picker: 9935, Cotton Strippers: 7455, 7460, Sprayers: 4700, 4710, 6100, 6500, 6600, 6700, Swather: 4995	Fuel/Water Separator Replaces RE52987, RE53400, RE62418	AMRE62419	\$ 15.00	







Steering Wheels and Caps

Application	Description	Part Number	Retail Price	Core
45, 55, 95, 105	Steering Wheel Rubber Covered Steel Core, 3 Spokes, 18" Diameter, 36 Spline Hub For 7/8" Steering Shaft	AMAF3856R	\$ 77.00	

John Deere®—Combine







Application	Description	Part Number	Retail Price	Core
3300, 4400, 4420, 6600, 6602, 6620, 6622, 7700, 7720, 8820, Cotton Pickers: 299, 9900, 9910, 9920, Cotton Strippers: 484, 7440	Steering Wheel Flat-Style, Low-Profile Steering Wheel w/ 3 Covered Spokes, 16" Diameter, 7/8" Splined Hub	AMAR26625	\$ 50.00	
9400, 9410, 9500, 9510, 9600, 9610, CTS, CTS II, Cotton Pickers: 9930, 9935, 9940, 9950, 9960, 9965, 9970, 9976, Cotton Strippers: 7445, 7450, 7455	Steering Wheel Smooth-finish, Dished Steering Wheel w/ 3 Covered Spokes, 16" Diameter, 7/8" Splined Hub	AMAR78405	\$ 65.00	

Glass









Application	Description	Part Number	Retail Price	Core
 9400, 9410, 9450, 9500, 9510, 9550, 9550SH, 9560, 9560STS, 9570STS, 9600, 9610, 9650, 9650CTS, 9650STS, 9660, 9660CTS, 9660STS, 9670STS, 9750STS, 9760STS, 9770STS, 9870STS, CTS, CTS II, Cotton Picker: 9986, Cotton Stripper: 7460, Swathers: 4890, 4895, 4990	Windshield Glass Replaces AH141412	AMAH166648	\$ 706.34	
 9400, 9410, 9450 BSN 700101, 9500, 9510, 9550, 9550SH, 9560 ASN 715100, 9560SH ASN 715100, 9560STS ASN 715300, 9600, 9610, 9650 BSN 700301, 9650CTS BSN 700401, 9650STS BSN 700501, 9660, 9660CTS, 9750STS BSN 700601, 9860STS ASN 715600, CTS, CTS II, Cotton Picker: 9986, Swathers: 4890, 4895 BSN 181001, 4990, 4995 BSN 183001	Door Glass Replaces AH125963, AH154280, H206852	AMAH168703	\$ 184.00	
 Sprayer: 4630	Door Glass, Right Hand	AMR198625	\$ 351.00	
	Door Glass, Left Hand	AMR198624	\$ 420.00	
 Sprayer: 4630	Upper Rear Glass Tinted	AMR206835	\$ 192.00	
 Sprayers: 4700, 4710, 4720, 4920, 4930	Weatherstrip 240" Long For Front Windshield	AMR115196	\$ 41.00	
 Sprayers: 4700, 4710, 4730, 4830, 4920, 4930, 4940	Weatherstrip 52" Long For Rear Cab Window Replaces R111684, R117033	AMR234302	\$ 14.43	

John Deere®—Combine











Air Conditioning and Components

Application	Description	Part Number	Retail Price	Core
 484, 4420, 4400, 6600, 7440, Cotton Pickers: 9910, 9920 - All w/ 329 CID Engine	Compressor Conversion Kit A6 to Sanden Brackets Mount to Original A6 Mounting Brackets Includes Compressor, Mounting Brackets, Support Bracket, Compressor Manifold, Hex Shafts, Hi-Lo Pressure Switches, Wiring Harness for Hi-Lo Switches, Retrofit Adapters, O-Ring, Belt and Mounting Hardware Requires Pag Oil 100V, 6.76 oz (200 cc)	AMX10206	\$ 362.00	
	Ultra Pag Double End Capped, 100V, 8 oz	AMX10267	\$ 12.00	
	Universal Pag Oil, 8 oz	AMX10274	\$ 9.00	
 4420 ASN 610101, 4425, 4435, (6620, 6622, 7720, 7722 ASN 600001), 8820 ASN 615401, 9400 BSN 650100, 9500 BSN 650200, 9600 BSN 650300, CTS BSN 650400, Cotton Pickers: 7440 ASN 001001, 7445 BSN 16000, 9920 ASN 381, 9930 BSN 14000, 9960, 9965 BSN 2000, Forage Harvesters: (5720, 5820 ASN 680001), 5730, 5830, (6610, 6710, 6810, 6910 BSN 500923), Swathers: 3430 BSN 985000, 3830 BSN 978856	Compressor Conversion Kit Nippondenso to Sanden Includes Compressor, Mounting Brackets, Compressor Manifold, Retrofit Adapters, O-Rings and Mounting Hardware Requires Synthetic Ester Oil 100V, 6.42 oz (190 cc)	AMX10167	\$ 505.00	
	Premium Synthetic Ester Oil, 100V, 12 oz	AMX10273	\$ 11.00	
 6600, 6620, 6622, 7700, 7720, 7722, Cotton Picker: 9940, Forage Harvesters: 5200, 5400, 5440, 5460, 5720	Compressor Conversion Kit A6 to Sanden Includes Compressor, Mounting Brackets, Compressor Manifold, Retrofit Adapters, O-Rings and Mounting Hardware Requires Pag Oil 100V, 6.76 oz (200 cc)	AMX10164	\$ 362.00	
	Ultra Pag Double End Capped, 100V, 8 oz	AMX10267	\$ 12.00	
	Universal Pag Oil, 8 oz	AMX10274	\$ 9.00	
	Compressor, Sanden Requires Pag Oil 100V, 6.76 oz (200 cc)	AMX10236	\$ 250.00	
	Ultra Pag Double End Capped, 100V, 8 oz	AMX10267	\$ 12.00	
	Universal Pag Oil, 8 oz	AMX10274	\$ 9.00	
 9640	Compressor Conversion Kit A6 Style to Sanden Style Includes Compressor, Mounting Brackets, Compressor Manifold, Binary Switch, Retrofit Adapters, O-Rings and Mounting Hardware Requires Pag Oil 100V, 6.76 oz (200 cc)	AMX10168	\$ 362.00	
	Ultra Pag Double End Capped, 100V, 8 oz	AMX10267	\$ 12.00	
	Universal Pag Oil, 8 oz	AMX10274	\$ 9.00	
 484, 1055, 1065, 1085, 3300, 4400, 4420, 6600, 6620, 6622, 7440, 7700, 7720, 7722, 8820, Cotton Pickers: 9900, 9910, 9920, 9940, Swathers: 2250, 2270, 2280, 2320, 2420 Replaces SE501456, SE501457, TY6665, TY6770	Compressor w/ Dust Cover, HD Superheat Compressor, 12 Volt, w/ Single Groove Clutch, 5.58" (142 mm) Clutch Diameter, Can be used for 2 o'clock and 10 o'clock Positions, Must use Original Hoses and Belts, Replaces A6 Style w/ 10 Cylinder Nippondenso 10PA20 Style, Uses Less Power for Greater Efficiency Requires Pag Oil 46V, 7.00 oz (207 cc)	AMX10223	\$ 470.00	
	Ultra Pag Double End Capped, 46V, 8 oz	AMX10266	\$ 12.00	
 3300, 4400, 6600, 7700, Cotton Picker: 9900 Replaces AH84826, TY6788	Reman York Compressor Flange Head, Right Hand Suction, Clutch Not Included	AMX10176	\$ 235.00	

John Deere®—Combine

Application	Description	Part Number	Retail Price	Core
 (3300, 4400, 6600, 7700 - 1975 and Later), 4420 BSN 610100, (6620, 6622, 7720, 7722 BSN 600000), 8820 BSN 615400, Cotton Pickers: 9910, 9920 BSN 380, 9930 BSN 14000, 9940, Forage Harvesters: 5440, 5460, (5720, 5820 SN 550001-680000), Swathers: 2250, 2270, 2280, 2320, 2420	Compressor, A6 Style Superheat Compressor w/ Superheat Switch, 12 Volt, w/ Single Groove Clutch, 5.10" (130 mm) Clutch Diameter, Coil Mounted at 10 o'clock Position, Must use Original Manifold Requires Synthetic Ester Oil 100V, See Manufacturer for Oil Quantity	AMX10142	\$ 610.00	
	Premium Synthetic Ester Oil, 100V, 12 oz	AMX10273	\$ 11.00	
 (3300, 4400, 6600, 7700 - 1975 and Later), 4420 BSN 610100, (6620, 6622, 7720, 7722 BSN 600000), 8820 BSN 615400, Cotton Pickers: 9910, 9920 BSN 380, 9930 BSN 14000, 9940, Forage Harvesters: 5440, 5460, (5720, 5820 SN 550001-680000), Swathers: 2250, 2270, 2280, 2320, 2420 Replaces TY6665, TY6770	Reman Frigidaire A6 Compressor Superheat Compressor, Superheat Switch Not Included, 12 Volt, w/ Single Groove Clutch, 5.58" (142 mm) Clutch Diameter, 0.50" Belt Width See Manufacturer for Oil Type and Quantity	AM50-014	\$ 350.00	\$ 100.00
 4420 ASN 610101, 4425, 4435, (6620, 6622, 7720, 7722 ASN 600001), 8820 ASN 615401, 9400 BSN 650100, 9500 BSN 650200, 9600 BSN 650300, CTS BSN 650400, Cotton Pickers: 7440 ASN 001001, 7445 BSN 16000, 9920 ASN 381, 9930 BSN 14000, 9960, 9965 BSN 2000, Forage Harvesters: (5720, 5820 ASN 680001), 5730, 5830, (6610, 6710, 6810, 6910 BSN 500923), Swathers: 3430 BSN 985000, 3830 BSN 978856 Replaces RE501460, SE501464, SE503051, TY6626, TY6766	Nippondenso Replacement Compressor 12 Volt, w/ Single Groove Clutch, 5.76" (146 mm) Clutch Diameter, Must use Original Manifold Requires Pag Oil 46V, 8.00 oz (236 cc)	AMX10203	\$ 450.00	
	Ultra Pag Double End Capped, 46V, 8 oz	AMX10266	\$ 12.00	
 4420, 4425, 4435, 6620 ASN 600001, 6622 ASN 610401, 7720 ASN 600001, 8820 ASN 615401, 9400 BSN 650100, 9500 BSN 650200, 9600 BSN 6650300, CTS BSN 650400, Cotton Pickers: 9920, 9930, 9950, 9960, 9965, Cotton Strippers: 7440, 7445 BSN 16000, Forage Harvesters: 5720, 5730, 5820, 5830, 6610, 6710, 6810, 6910 Replaces RE10980, RE10981	Nippondenso Manifold Kit Includes Suction Manifold, Discharge Manifold and Pressure Relief Valve Use w/ AMX10203 Compressor	AMX10253	\$ 77.00	
 6600, 7700	Compressor, York Style Left Hand Suction, Rotolock Clutch Not Included Requires Synthetic Ester Oil 100V, See Manufacturer for Oil Quantity	AMX10225	\$ 270.00	
	Double Groove Clutch for York Compressor, 7"	AM470	\$ 103.00	
	Premium Synthetic Ester Oil, 100V, 12 oz	AMX10273	\$ 11.00	
 9400 ASN 650101, 9500 ASN 650201, 9600 ASN 650301, CTS ASN 650401, Cotton Picker: 9930 BSN 14000 Replaces RE46657, TY6765	Compressor, Nippondenso Style 12 Volt, w/ Single Groove Clutch, 5.75" (146 mm) Clutch Diameter, Must use Original Manifold Requires Pag Oil 46V, 7.77 oz (230 cc)	AMX10141	\$ 332.00	
	Ultra Pag Double End Capped, 46V, 8 oz	AMX10266	\$ 12.00	
 9410, 9450, 9510, 9550, 9610, 9650, 9770STS, Swather: 4890 Replaces RE46609, TY6764, TY24304, RE69716	Compressor, Nippondenso Style 12 Volt, w/ 8-Groove Clutch for Serpentine Belt, 5.75" (146 mm) Clutch Diameter, Must use Original Manifold Requires Pag Oil ND8, 7.77 oz (230 cc)	AMX10139	\$ 255.00	
	Denso ND8 Pag Oil, 46V, 8.50 oz	AMX10272	\$ 31.00	
 Cotton Pickers: 9965 ASN 2001, 9970, 9976, Cotton Strippers: 7445 ASN 16001, 7450, Swathers: 3430 ASN 985001, 3830 ASN 978857 Replaces RE52454, RE55422, TY6784	Compressor, Nippondenso 10PA17C Style 12 Volt, w/ Single Groove Clutch, 5.748" (146 mm) Clutch Diameter, Must use Original Manifold Requires Pag Oil ND8, 7.77 oz (230 cc)	AMX10137	\$ 250.00	
	Denso ND8 Pag Oil, 46V, 8.50 oz	AMX10272	\$ 31.00	

John Deere®—Combine

	Application	Description	Part Number	Retail Price	Core
	Forage Harvesters: (6610, 6710, 6810, 6910 - w/ ASN 500922), 6650, 6750, 6850, 6950, (7200, 7300, 7400, 7500, 7700, 7800 - w/ BSN 507478)	Compressor, Nippondenso 10PA15C Style 12 Volt, w/ 2-Groove Clutch, 5.33" (135 mm) Clutch Diameter	AMAZ44541	\$ 585.00	
	Swather: 2360 Replaces AW23886, AW24173	Compressor, Sanden SD510HD Style 12 Volt, w/ 2-Groove Clutch, 5.19" (132 mm) Clutch Diameter, Vertical #8 and #10 Flare Fittings, w/ R12 Charge Ports Requires Pag Oil 100V, 4.56 oz (135 cc)	AMX10126	\$ 204.00	
		Ultra Pag Double End Capped, 100V, 8 oz	AMX10267	\$ 12.00	
		Universal Pag Oil, 8 oz	AMX10274	\$ 9.00	
	Cotton Pickers: 7455, 7460, 9935, 9976 ASN 4001, 9986, 9996, Sprayer: 6700, Swathers: 4890, 4895 BSN 330015, 4990, 4995 BSN 330539	Compressor Manifold Use w/ RE52454 Compressor Includes Cap and Pressure Valve	AMRE69715	\$ 100.00	
	4420, 4425, 4435, 6620, 6622, 7720, 9500, 9600, CTS, Cotton Pickers: 9920, 9930, 9950, 9960, 9965, Sprayers: 6000, 6500, Swathers: 3430, 3830, Forage Harvesters: 5720, 5820, 5730, 5830, 6610, 6710, 6810, 6910	Compressor Clutch 5.75" w/ 12 Volt Coil, Single Groove, Standard 6E171, w/o Dust Cover	AMRE10975	\$ 128.00	
	9410, 9450, 9510, 9510SH, 9550, 9550SH, 9560, 9560SH, 9610, 9640, 9650, 9650CTS, 9650STS, 9660, 9660CTS, 9660STS, 9680, 9750STS, 9760STS, 9860STS, CTS, CTS II, Cotton Pickers: 9935, 9986, 9996, Cotton Stripper: 7455, 7460, Forage Harvesters: (7200, 7300, 7400, 7500, 7700, 7800 ASN 507479), Sprayers: 4700, 4710, 4720, 4920, 6700, Swathers: 3430, 4890, 4895, 4990, 4995	Compressor Clutch w/ Pulley 10PA17C Clutch w/ 12 Volt Coil, 5.70" 8-Groove Pulley w/o Dust Cover	AMRE52508	\$ 122.00	
	Cotton Picker: 9965, Swathers: 3430, 3830	Compressor Clutch w/ Pulley 10PA17C Clutch w/ 12 Volt Coil, 5.74" Single Groove Pulley	AMRE58348	\$ 110.00	
	Universal Equipment	High Pressure Switch Normally Open, Opens at 305 PSI, Closes at 395 PSI, 7/16"x20 Thread	AMX10276	\$ 36.00	
	Universal Equipment	Low Pressure Switch Normally Open, Opens at 6 PSI, Closes at 45 PSI, Standard 7/16"x20 Thread	AMX10277	\$ 56.00	
	Universal Equipment	Low Pressure Switch Normally Open, Opens at 35 PSI, Closes at 46 PSI, Standard 7/16"x20 Thread	AMX10278	\$ 42.00	
	6600, 6620, 7700, 7720, 8820, Cotton Pickers: 9900, 9910, 9920, 9930, 9935, 9940, 9950, 9960, 9965, 9970, 9976, Cotton Strippers: 7440, 7445, 7450, 7455, Sprayer: 6600 Replaces AR59779	Rotary Adjustable Thermostatic Switch 36" Capillary Tube	AMX10251	\$ 49.00	
	6600, 6620, 6622, 7700, 7720, 7722, 9940, Forage Harvesters: 5200, 5400, 5440, 5460, 5720, 5820	Clutch Saver Kit Protects Clutch from Slipping Due to Low Voltage, Maintains Adequate Voltage to Clutch Coil at all Times	AMX10252	\$ 26.00	

John Deere®—Combine













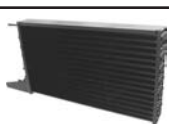

	Application	Description	Part Number	Retail Price	Core
	3300, 4400, 4420, 6600, 6620, 6622, 7700, 7720, 8820, Cotton Pickers: 9900 w/ Stolper Cab, 9910, 9920, 9930, 9935, Cotton Strippers: 7440, 7445, 7450, 7455 Replaces AH234098, AL77581, AR59780, AR59870, AR74486, RE49169, RE214439, RE291794	Receiver Drier Receiver Drier, Import 4" x 7 1/2", Inlet - #6 Female O-Ring, Outlet - #6 Male O-Ring, R12 and R134a Compatible	AMX10154 AMX10208	\$ 26.00 \$ 22.00	
	4425, 6620, 6620 Titan II, 6622, 7720, 7720 Titan II, 7722, 8820, 8820 Titan II, 9400, 9410, 9450, 9500, 9510, 9550, 9600, 9610, 9650, 9670STS, 9770STS, 9860STS, 9870STS, Cotton Pickers: 9940, 9950, 9960, 9970, 9976 Replaces AH234099, AT125596, AT162848, AXE53638	Receiver Drier 4" x 9", Inlet - #6 3/8" Female O-Ring, Outlet - #6 3/8" Male O-Ring, R12 and R134a Compatible	AMX10156	\$ 37.00	
	Sprayers: 4710, 4720, 4920	Receiver Drier 3" x 11 1/2", Inlet - #6 3/8" Female O-Ring, Outlet - #6 3/8" Male O-Ring, R12 and R134a Compatible	AMRE214440	\$ 29.00	
	484, Cotton Pickers: 9900, 9910 Replaces AR45882	Expansion Valve Internally Regulated w/ 12" Capacity Tube w/ Flare Connection, R12 and R134a Compatible	AMX10215	\$ 31.00	
	3300, 4400, 4420, 6600, 7700, Forage Harvesters: 5200, 5400, 5440, 5460, Swathers: 2250, 2270, 2280	Expansion Valve Bulb Type, R12 and R134a Compatible, 19" Tube Length, Flare Connection	AMX10146	\$ 20.00	
	4425, 4435, 6620, 6622, 7440, 7445, 7450, 7455, 7720, 7722, 8820, Cotton Pickers: 9920, 9930, 9935, 9940, 9950, 9960, 9965, 9970, 9976, Swathers: 3430, 3830	Expansion Valve, OEM Bulb Type Externally Equalized 9" Capillary Tube, R12 and R134a Compatible	AMRE206757	\$ 20.00	
	4425, 4435, 6620, 6622, 7720, 7722, 8820, Cotton Pickers: 9920, 9930, 9935, 9940, 9950, 9960, 9965, 9970, 9976, Cotton Strippers: 7440, 7445, 7450, 7455, Forage Harvesters: 5720, 5730, 5820, 5830, Swathers: 2320, 2420, 3430, 3830 Replaces AR58482, AH140818, RE206757	Expansion Valve Bulb Type, Externally Equalized, R12 and R134a Compatible, 14" Tube Length, O-Ring Connection	AMX10145	\$ 20.00	
	9400, 9410, 9450, 9500, 9510, 9550, (9560STS, 9560STS BSN 720100), 9600, 9610, 9650, 9650STS, 9660STS BSN 720300, 9750STS, 9760STS BSN 720400, CTS, Swather: 4890 Replaces AH122867, AH137702, AH203871	Expansion Valve Block Type, R12 and R134a Compatible, O-Ring Connection	AMX10150	\$ 27.00	
	9560STS ASN 720100, 9570STS, 9650STS, (9660STS, 9760STS ASN 720300), 9670STS, 9750STS, 9770STS, 9860STS ASN 720500, 9870STS, Cotton Pickers: 7660, 7760, CP690, Cotton Stripper: CS690, Forage Harvesters: 7180, 7250, 7280, 7350, 7380, 7450, 7480, 7550, 7580, 7750, 7780, 7850, 7950, 7980, Swathers: D450, R450	Expansion Valve	AMAH222255	\$ 40.00	
	Sprayers: 4700, 4710, 4720, 4730 BSN 014148, 4830 Early, 4920, 4930, 4940, R4030, R4038, R4044, R4045, R4060 Replaces AL160578, RE283957	Expansion Valve Flange Style, R12 and R134a Compatible	AMRE174764	\$ 20.00	
	Swather: 2360 Replaces CMX30213, AW23878	Expansion Valve Bulb Type, Externally Equalized, R12 and R134a Compatible, 28" Tube Length, O-Ring Connection	AMX10148	\$ 18.00	

John Deere®—Combine





	Application	Description	Part Number	Retail Price	Core
	484, 1032, 1042, 1052, 1055, 1065, 1072, 1075, 1085, 2254, 4425, 6620, 6622, 7440, 7445, 7450, 7455, 7720, 7722, 8820, 9940, 9950, 9960, 9965, 9970, Forage Harvesters: 5720, 5730, 5820, 5830, Sprayers: 6000, 6100, 6500, 6600, 6700, Swathers: 2320, 2420, 3430, 3830	Blower Motor Update Kit Complete Assembly w/ Resistor Includes One Assembly for Models w/ Single Blower Motor 12 Volt, Mounting Base: 21" x 6 5/8"	AMAR82006	\$ 275.00	
	3300, 4400, 4420, 6600 1971-74, 7700, Forage Harvesters: 5200, 5400, (5440, 5460 BSN 490000), Swathers: 2250, 2270, 2280 Replaces AH80194	Blower Motor 3-Speed, Double Shaft, 4-Wire, Reversible, 3/8" Shaft Diameter, 4 1/4" Long	AMX10120	\$ 82.00	
	3300, 4400 1971 and Later, 6600, 7700, Cotton Picker: 9900 Excel Cab, Forage Harvesters: 5200, 5400, Swathers: 2250, 2270 Replaces AH80698, AH81609, AH84394, AH88519	Blower Motor 12 Volt, Single Speed, Single Shaft, 2-Wire, Reversible, 5/16" Shaft Diameter, 1 1/2" Long	AMX10104	\$ 63.00	
	4425 ASN 017001, 4435 Replaces AL39043, AL110881, AL80700	Blower Motor	AMX10173	\$ 117.00	
	4425 BSN 017001, 6620, 6622, 7720, 8820, Cotton Pickers: 9910, 9920, 9930, 9935, 9940, 9950, 9960, 9965, 9970, 9976, Cotton Strippers: 7445, 7450, 7455, Forage Harvesters: 5720, 5730, 5820, 5830, Swathers: 2320, 2420, 3430, 3830 Replaces RE25160, AR82010, AR82005, RE13882, RE251028	Blower Motor Single Speed, Double Shaft, 2-Wire, Reversible, 3/8" Shaft Diameter, 5" Long	AMX10119	\$ 61.00	
	Swather: 2280, Forage Harvesters: 5440, 5460 Replaces AE40466	Blower Motor 12 Volt, Vented Motor, Reversible Single Speed, 2-Wire Motor w/ 3/8" Shaft	AMX10221	\$ 115.00	
	9400, 9410, 9450, 9500, 9510, 9550, 9600, 9610, 9650, Swathers: 4890, 4895, 4990, 4995 Replaces AH128926	Evaporator Heater Motor 12 Volt, Single Speed, Single Double Flat Shaft, 2-Wire, Reversible, 5/16" Shaft Diameter, 1 9/16" Long	AMX10174	\$ 92.00	
	Cotton Picker: 9986, Cotton Stripper: 7460, Forage Harvesters: 7200, 7300, 7400, 7500, 7700, 7800, Swathers: 4895, 4990, 4995 Replaces AH167731	Pressurizer Motor Single Speed, Single Shaft, 2-Wire, CW, 5/16" Shaft Diameter, 1 3/8" Long	AMX10171	\$ 92.00	
	3300, 4400, 4420, 6600, 7700, Forage Harvesters: 5200, 5400, 5440, 5460, Swathers: 2250, 2270, 2280 BSN 490001	Blower Wheel, Steel 3.75" Diameter, 4" Long, 0.375" Shaft, Double Vented Replaces 83953316, E5NN18459AA, E5NN18459BA	AMH84107	\$ 13.00	
	4425, 6620, 6622, 7720, 8820, Cotton Pickers: 9910, 9920, 9930, 9935, 9940, 9950, 9960, 9965, 9970, 9976, Cotton Strippers: 7440, 7445, 7450, 7455, Sprayers: 6000 Hi-Cycle, 6100, 6500, 6600, 6700, Swathers: 2320, 2420, 3830, 3430, Forage Harvesters: 5720, 5730, 5820, 5830	Blower Wheel, Plastic 4" Diameter, 3/8" Shaft, Reversible, Double Vented, Clamps Not Included	AMR81111	\$ 26.00	
	484, 1032, 1042, 1052, 1055, 1065, 1072, 1075, 1085, 2254, 3300, 4400, 4420, 4425, 6600, 6602, 6620, 6622, 7440, 7445, 7450, 7455, 7700, 7720, 7722, 8820, 9940, 9950, 9960, 9965, 9970	Blower Motor Switch 3-Speed Replaces 168822C1, 168822C2, AH84588	AMX10261	\$ 16.00	
	4425, 4435, 6600, 6620, 7700, 7720, 8820, Swathers: 2250, 2270, 2280, Forage Harvesters: 5440, 5460, 5720, 5730, 5820, 5830	Condenser Core: 25 1/2" x 16" x 1 3/4"	AMAH87966	\$ 208.00	
	7720, 7820, 7920, Sprayer: 4720	Condenser w/ Fuel Cooler	AMRE181894	\$ 875.00	

Prices Subject to Change without Prior Notice. The use of original equipment manufacturer (OEM) part numbers or trademarks, e.g. Case® and John Deere®, are for reference purposes only and for indicating product use and compatibility. Our company and the listed replacement parts contained herein are not sponsored, approved or manufactured by the OEM. All parts are New unless designated Reman in the description.

John Deere®—Combine

	Application	Description	Part Number	Retail Price	Core
	9400, 9410, 9450, 9500, 9510, 9550, 9600, 9610, 9650, 9660, 9660CTS, CTS, CTS II	Condenser Core: 26 1/2" x 13" x 3"	AMAH149618	\$ 459.00	
	9400, 9500, 9500SH, 9600, CTS	Condenser w/ Dual Oil Cooler Core: 22 1/2" x 33" x 5 1/8"	AMAH150219	\$ 790.00	
	9550, 9550SH, 9560, 9560SH, 9560STS, 9570STS, 9650, 9650CTS, 9650STS, 9660, 9660CTS, 9660STS, 9670STS, 9750STS, 9760STS, 9770STS, 9780CTS ASN 072800, 9860STS, 9870STS, C670, S550 SN 745100-764999, (S660, S670 ASN 745100), T550, T560, T660, T670, Cotton Pickers: 9976 ASN 006001, 9986, 9996	Condenser w/ Fuel Cooler	AMAH163522	\$ 550.00	
	9550 ASN 700201, 9560, 9560SH, 9560STS, 9570STS, 9650 ASN 695301, 9660, 9660CTS	Condenser w/ Oil Cooler	AMAH168467	\$ 1075.00	
	9960, 9965, 9970	Condenser w/ Oil Cooler	AMAN194102	\$ 1585.00	
	Cotton Pickers: 9940, 9950	Condenser w/ Oil Cooler Replaces AR75968	AMAR78958	\$ 1675.00	
	Forage Harvesters: 6610, 6650, 6710, 6750, 6850, 7250, 7300, 7350, (7400, 7500, 7700, 7800 ASN 507479), 7450, 7550, 7750, 7850, 7950	Condenser	AMRE28764	\$ 546.00	
	Forage Harvesters: 6750, 6810, 6850, 6910, 6950	Condenser	AMAZ43873	\$ 1818.00	
	Sprayers: 4730, 4830	Condenser w/ Fuel Cooler	AMRE226365	\$ 425.00	
	Sprayer: 4920	Condenser w/ Fuel and Oil Cooler Overall: 26" x 31" x 4" Core: 25 3/8" x 25" x 3 7/8" Replaces RE218194	AMRE222984	\$ 1200.00	
	Sprayer: 4940	Condenser	AMRE297792	\$ 825.00	
	Swather: A400	Condenser w/ Oil Cooler	AMAFH202216	\$ 2207.00	
	Swathers: W235, W260	Condenser w/ Oil Cooler	AMAFH210943	\$ 1015.00	
	9400, 9410, 9450, 9500SH, 9500, 9510, 9510SH, 9550 BSN 700200, 9550SH BSN 700700, 9600	Charge Air Cooler Replaces AH136360, AH140474	AMAH151139	\$ 1285.00	
	9550 ASN 700201, 9550SH ASN 700701, 9560, 9560SH, 9560STS BSN 720100, 9650 ASN 695301, 9650CTS ASN 695401, 9660, 9660CTS	Charge Air Cooler Core: 34" x 12.50" x 5.20"	AMAH168353	\$ 2244.00	

John Deere®—Combine

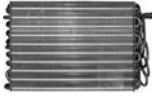
Application	Description	Part Number	Retail Price	Core
 9560STS ASN 695501, (9660STS, 9760STS BSN 715400), Cotton Picker: 9996	Charge Air Cooler Replaces AH168324	AMAH219315	\$ 2091.00	
 9600 ASN 645301, 9610, 9650 BSN 695300, CTS, CTS II	Charge Air Cooler Replaces AH140473	AMAH149229	\$ 1855.00	
(9650STS, 9750STS BSN 695500)	Charge Air Cooler	AMAH145389	\$ 1450.00	
 Sprayers: 4730, 4830	Charge Air Cooler Core: 21 1/4" x 11 5/8" x 4"	AMRE226367	\$ 1525.00	
Sprayer: 4940	Charge Air Cooler Core: 10" x 38 1/8" x 5"	AMRE297789	\$ 1318.00	
	Charge Air Cooler Core: 10 1/4" x 38 1/4" x 5"	AMRE330648	\$ 1150.00	
 6620, 6622, 7720, 7722, 8820, Cotton Pickers: 9910, 9920, 9930, 9940, 9960, 9965, Forage Harvesters: 5720, 5730, 5820, 5830, Swathers: 2320, 2420, 3430, 3830	Evaporator Overall: 33 1/4" x 12 1/2" x 5" Core: 29" x 5" x 3 1/8" Replaces Evaporator on Early Models w/ Separate Heater Core Tractors w/ separate heater core Must Remove Roof Panel Spacer for Clearance	AMAR88076	\$ 153.00	
 Sprayers: 4730, 4830, 4930, 4940	Evaporator Flange Mount, O-Ring Connection Overall: 18" x 4 3/8" x 10" Core: 13 1/2" x 3 3/4" x 10" Replaces RE187311, RE286345, RE292236	AMRE327083	\$ 345.00	

Cornhead—Complete Polytin Kits



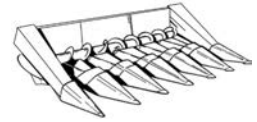



Mounting hardware is included with kits. Kits include snouts, dividers and fenders in light weight poly that never need paint.



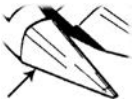
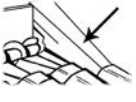
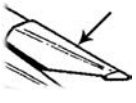















Application	Description	Part Number	Retail Price	Core
443	4 Row - 30" Complete Assembly	AMPTJD430	\$ 2865.00	
643	6 Row - 30" Complete Assembly	AMPTJD630	\$ 4106.00	
843	8 Row - 30" Complete Assembly	AMPTJD830	\$ 5289.00	
1243	12 Row - 30" Complete Assembly	AMPTJD1230	\$ 7500.00	
444	4 Row - 36" Complete Assembly	AMPTJD436	\$ 3100.00	
643	6 Row - 36" Complete Assembly	AMPTJD636	\$ 4400.00	
844	8 Row - 36" Complete Assembly	AMPTJD836	\$ 5695.00	
1243	12 Row - 36" Complete Assembly	AMPTJD1236	\$ 7585.00	
444	4 Row - 38" Complete Assembly	AMPTJD438	\$ 3200.00	
644	6 Row - 38" Complete Assembly	AMPTJD638	\$ 4555.00	
844	8 Row - 38" Complete Assembly	AMPTJD838	\$ 6018.00	
444	4 Row - 40" Complete Assembly	AMPTJD440	\$ 3225.00	
644	6 Row - 40" Complete Assembly	AMPTJD640	\$ 4702.00	
844	8 Row - 40" Complete Assembly	AMPTJD840	\$ 6018.00	

John Deere®—Combine

Cornhead—Fenders and Snouts

	Application	Description		Part Number	Retail Price	Core
	(243, 244, 343, 344, 443, 444, 543, 546, 643, 644, 645, 843, 1243 - Low-Profile ASN 380601)	Outer Fender, Right Hand	Poly	AMAH118342P	\$ 505.00	
			Steel	AMAH118342	\$ 1000.00	
	(243, 244, 343, 344, 443, 444, 543, 546, 643, 644, 645, 842, 843 - High-Profile BSN 380600)	Outer Fender, Right Hand	Steel	AMAH82434	\$ 835.00	
	(243, 244, 343, 344, 443, 444, 483, 543, 546, 583, 642, 643, 644, 645, 683, 842, 843, 844, 883, 1243 - Low-Profile ASN 380601)	Outer Snout w/ Point, Right Hand	Poly	AMAH115402P	\$ 210.00	
			Steel	AMAH115402	\$ 285.00	
			Steel	AMAH109666	\$ 255.00	
	(243, 244, 343, 344, 443, 444, 483, 484, 543, 546, 642, 643, 644, 842, 843, 1243 - High-Profile BSN 380600), Row Crop Heads: (50, 50A, 453, 453A, 454, 454A, 554, 653, 654, 654A, 655A, 853, 853A, 854A, 1253A BSN 655099)	Outer Snout w/o Point, Right Hand	Steel	AMAH109666	\$ 255.00	
	(243, 244, 343, 344, 443, 444, 543, 546, 643, 644, 645, 843, 1243 - Low-Profile ASN 380601)	Outer Fender, Left Hand	Poly	AMAH118343P	\$ 430.00	
			Steel	AMAH118343	\$ 880.00	
	(243, 244, 343, 344, 443, 444, 543, 546, 643, 644, 645, 842, 843 - High-Profile BSN 380600)	Outer Fender, Left Hand	Steel	AMAH82435	\$ 1000.00	
	(243, 244, 343, 344, 443, 444, 483, 543, 546, 583, 642, 643, 644, 645, 683, 842, 843, 844, 883, 1243 - Low-Profile ASN380601)	Outer Snout w/ Point, Left Hand	Poly	AMAH115403P	\$ 195.00	
			Steel	AMAH115403	\$ 285.00	
			Steel	AMAH109667	\$ 255.00	
	(243, 244, 343, 344, 443, 444, 483, 484, 543, 546, 642, 643, 644, 842, 843, 1243 - High-Profile BSN 380600), Row Crop Heads: (50, 50A, 453, 453A, 454, 454A, 554, 653, 654, 654A, 655A, 853, 853A, 854A, 1253A BSN 655099)	Outer Snout w/o Point, Left Hand	Steel	AMAH109667	\$ 255.00	
	243, 244, 343, 344, 443, 444, 543, 546, 642, 643, 644, 645, 842, 843, 844, 1243 - 30"	Narrow Row Center Snout w/ Point Poly to Replace Steel	Poly	AMAH129764P	\$ 220.00	
			Poly	AMAH129764PK	\$ 220.00	
			Steel	AMAH129764	\$ 184.00	
	(493, 494, 594, 693, 694, 893, 894, 1290, 1291, 1293, 1294 ASN 695301)	Narrow Row Center Snout	Poly	AMAH168313	\$ 265.00	
	(493, 693, 893, 1293 BSN 695300)	Narrow Row Center Snout w/ Stainless Steel Wear Strips Replaces AH141626	Poly	AMAH146577	\$ 439.00	
	600 BSN 745100, 606, 606C, 608, 608C, 608FC ASN 129189, 612, 612C, 612FC, 616, 616C, 706C, 708C, 708FC, 712C, 712FC, 716C, C6R, C8R, C12F, C12R, C16F, C16R	Narrow Row Center Snout	Poly	AMAXE10905	\$ 291.00	
	243, 244, 343, 344, 443, 444, 543, 546, 642, 643, 644, 645, 842, 843, 844, 1243 - 36", 38", 40"	Wide Row Center Snout w/ Point	Poly	AMAH129766P	\$ 250.00	
Poly on Poly			AMAH129766PK	\$ 250.00		
Steel			AMAH129766	\$ 175.00		
	Models w/ Polytin Snouts	Wear Plate, Stainless Steel	Right Hand	AMX27289	\$ 25.00	
			Left Hand	AMX27288	\$ 25.00	
	(493, 693, 893, 1293 BSN 695300)	Wear Strip, Stainless Steel For Inner Gathering Point	Right Hand	AMAH146577WSR	\$ 42.00	
			Left Hand	AMAH146577WSL	\$ 43.00	

John Deere®—Combine

	Application	Description	Part Number	Retail Price	Core
	600, 606, 606C, 608, 608C, 612, 612C, 612FC, 616, 616C, 618, 618C, 706C, 708C, 708FC, 712C, 712FC, 718C	Wear Strip (4) Required on Inner Snouts (2) Required on Outer Snouts	AMH228917	\$ 2.75	
	244, 343, 344, 443, 444, 493, 494, 543, 546, 594, 606, 606C, 608, 608C, 608FC, 612, 612C, 612FC, 616, 616C, 618, 618C, 642, 643, 644, 645, 692, 693, 693SH, 694, 706C, 708C, 708FC, 712C, 712FC, 716C, 718C, 842, 843, 844, 892, 893, 894, 1092, 1243, 1290, 1291, 1293 - w/ Perm-Glide™	Wear Tip Replaces H115596	AMH148121	\$ 28.48	
	243 BSN 1001, 244 BSN 5501, (343, 643 BSN 4001), 344 BSN 2001, 443 BSN 4501, 444 BSN 11001, (546, 644, 645, 843 BSN 1501)	Wear Tip For Steel Center Snout Replaces H135290	AMH84480	\$ 23.00	
	(244, 343, 344, 443, 444, 543, 546, 642, 643, 644, 645, 842, 843, 844, 1243 - w/ Perm-Glide™), 493, 494, 594, 606, 606C, 608, 608C, 608FC, 612, 612C, 612FC, 616, 616C, 618, 618C, 692, 693, 693SH, 694, 706C, 708C, 708FC, 712C, 712FC, 716C, 718C, 892, 893, 894, 1092, 1290, 1291, 1293	Poly Replacement Tip	AMH148121P	\$ 19.00	
	443, 444, 444SH, 543, 546, 642, 643, 643SH, 644, 645, 842, 843, 844, 894, 1243	Wear Tip For Polylin	Poly AM71364963NP	\$ 28.00	
			Cast AM71364963A	\$ 21.50	
		Wear Tip For Steel Divider Point	Cast AM71364963	\$ 40.00	
	443, 444, 444SH, 543, 546, 642, 643, 643SH, 644, 645, 842, 843, 844, 894, 1243	Center Divider, Wide	Right Hand AMAH118340	\$ 190.00	
		Center Divider, Narrow	Right Hand AMAH118338	\$ 300.00	
	443, 444, 444SH, 543, 546, 642, 643, 643SH, 644, 645, 842, 843, 844, 894, 1243	Center Divider, Narrow	Left Hand AMAH118339	\$ 262.00	
	Poly Models Prior to 1998	Ear Saver, Poly	Inside AMX27174	\$ 12.75	
		Ear Saver, Poly (1) Inside and (1) Outside Required per Row	Outside AMX27175	\$ 12.75	
	606C, 608C, 608FC, 612C, 612FC, 616C, 618C, 706C, 708C, 708FC, 712C, 712FC, 716C, 718C - 1998 and Later	Ear Saver, Poly (2) Required per Row Replaces H226324, HXE33313	AMX27176	\$ 12.75	
	243, 244, 343, 344, 443, 444, 543, 546, 642, 643, 644, 645, 842, 843, 844, 1243	Ear Saver, Poly (2) Required per Row	AMX27178	\$ 12.75	
	243, 244, 343, 344, 443, 444, 493, 494, 543, 546, 594, 642, 643, 644, 645, 692, 693, 693SH, 694, 842, 843, 844, 892, 893, 894, 1092, 1243, 1290, 1291, 1293	Ear Saver, Rubber	Inside AMH166582	\$ 3.57	
	493, 494, 594, 692, 693, 693SH, 694, 892, 893, 894, 1092, 1290, 1291, 1293	Ear Saver Rubber (2) per Machine on Fender	AMH148223	\$ 3.57	
	493, 494, 594, 692, 693, 693SH, 694, 892, 893, 894, 1092, 1290, 1291, 1293	Ear Saver	AMH166581	\$ 4.76	
	493, 494, 594, 692, 693, 694, 892, 893, 894, 1092, 1290, 1291, 1293, 1294 BSN 676000	Ear Saver	Outside AMH148222	\$ 4.09	
	(606, 608, 612 BSN 745100)	Ear Saver	Inside AMHXE33313	\$ 3.57	
	(606, 608, 612 BSN 745100)	Ear Saver	Outside AMHXE38892	\$ 5.80	

Prices Subject to Change without Prior Notice. The use of original equipment manufacturer (OEM) part numbers or trademarks, e.g. Case® and John Deere®, are for reference purposes only and for indicating product use and compatibility. Our company and the listed replacement parts contained herein are not sponsored, approved or manufactured by the OEM. All parts are New unless designated Reman in the description.

John Deere®—Combine

Application	Description	Part Number	Retail Price	Core
 606, 608, 612	Ear Saver Replaces HXE33313	Inner AMH226324	\$ 4.82	
606, 608, 612, 616, 618	Ear Saver	Outer AMH226325	\$ 5.05	
 Models w/ Metal Heads For Narrow Rows Only	Poly Skid Bubble Tip	Outside Snout AMX27144	\$ 18.50	
		Inside Snout AMX27145	\$ 18.50	
 Models w/ Poly Snout For Narrow Rows Only	Poly Skid Bubble Tip	Outside Snout AMX27150	\$ 18.50	
 Models w/ Poly Snout For Narrow Rows Only	Poly Skid Bubble Tip	Inside Snout AMX27151	\$ 19.00	
 Most Models	Poly Gathering Chain Guard Green, 8.90" x 23" Includes Hardware	AMX27154	\$ 22.50	
 Models w/ Polytin Kits	Wear Strip, Stainless Steel For Fender Snout	Right Hand AMX27314	\$ 23.00	
		Left Hand AMX27313	\$ 27.00	
 Models w/ Polytin Kits - 40" Row	Divider, Center	Poly on Poly AMX27322PK	\$ 470.00	
 443, 643, 843, 1243 - 30"	Divider Assembly, Center Poly on Poly	AMX27185	\$ 434.00	
 493, 693, 893, 1293	Divider, Center Rear Replaces AH141628	AMAH160065	\$ 428.00	

Cornhead—Auger Liners

Application	Description	Part Number	Retail Price	Core
30" Row	4 Row Poly Auger Liner	AMX27129	\$ 260.00	
30" Row	6 Row Poly Auger Liner	AMX27130	\$ 305.00	
30" Row	8 Row Poly Auger Liner	AMX27131	\$ 374.00	
30" Row	12 Row Poly Auger Liner	AMX27132	\$ 578.00	

Cornhead—Stalk Stompers and Components

600 and 700 Series kits include header mounting brackets (accommodates 5" - 6" main beam), 12" stalk stomper shoes, stalk stomper torsion mounts, end support kit, u-bolts and mounting hardware. 40 and 90 Series kits (excluding Quick Disconnect) include header mounting brackets, 12" stalk stomper shoes, stalk stomper torsion mounts, u-bolts and mounting hardware. All kits (excluding Quick Disconnect) require 2" x 2" square tool bar.

Application	Description	Part Number	Retail Price	Core
642, 643, 644, 645, 693, 694, 842, 843, 893, 1092, 1243, 1293 - Excluding 8 Row w/ 36" or Wider Row Widths	Stalk Stomper Kit, Quick Disconnect	AMX27329	\$ 706.50	

John Deere®—Combine

Application	Description	Part Number	Retail Price	Core
606, 606C, 608, 608C, 612, 612C, 616, 618, 618C, 708C, 712C, 716C, 718C	Stalk Stomper Kit, 2 Row Covers 1 Row on Each Side of Cornhead For Optional End Support Kit See AMX30016	AMX31018	\$ 1200.00	
	Stalk Stomper Kit, 4 Row Covers 2 Rows on Each Side of Cornhead For Optional End Support Kit See AMX30016	AMX31019	\$ 1600.00	
	Stalk Stomper Kit, 6 Row Covers 3 Rows on Each Side of Cornhead For Optional End Support Kit See AMX30016	AMX31020	\$ 2225.00	
608, 608C, 612, 612C, 616, 618, 618C, 708C, 712C, 716C, 718C	Stalk Stomper Kit, 8 Row Covers 4 Rows on Each Side of Cornhead	AMX31021	\$ 2775.00	
612, 612C	Stalk Stomper Kit, 12 Row Kit Mounts in 3 Sections	AMX31022	\$ 3650.00	
612FC	Stalk Stomper Kit, 12 Row Folding Head Kit Mounts in 3 Sections	AMX31023	\$ 3975.00	
616, 618, 618C, 716C, 718C	Stalk Stomper Kit, 16 Row Kit Mounts in 3 Sections	AMX31024	\$ 4225.00	
618, 618C, 718C	Stalk Stomper Kit, 18 Row	AMX31025	\$ 4875.00	
344, 443, 444, 493, 494, 594, 642, 643, 644, 645, 693, 694, 842, 843, 844, 893, 894, 1243, 1290, 1293	Stalk Stomper Kit, 2 Row Covers 2 Outer Rows of Cornhead	AMX31026	\$ 950.00	
443, 444, 493, 494, 594, 642, 643, 644, 645, 693, 694, 842, 843, 844, 893, 894, 1243, 1290, 1293	Stalk Stomper Kit, 4 Row Covers 4 Outer Rows of Cornhead	AMX31027	\$ 1450.00	
642, 643, 644, 645, 693, 694, 842, 843, 844, 893, 894, 1243, 1290, 1293	Stalk Stomper Kit, 6 Row Covers 2 Inner Rows and 4 Outer Rows of Cornhead	AMX31028	\$ 2025.00	
	Stalk Stomper Kit, 6 Row Covers 6 Outer Rows of Cornhead	AMX31029	\$ 1950.00	
842, 843, 844, 893, 894, 1243, 1290, 1293	Stalk Stomper Kit, 8 Row Covers 2 Inner Rows and 6 Outer Rows of Cornhead	AMX31030	\$ 2575.00	
1243, 1290, 1293	Stalk Stomper Kit, 12 Row Covers 2 Inner Rows and 10 Outer Rows of Cornhead	AMX31031	\$ 3625.00	
606, 606C, 608, 608C, 612, 612C, 616, 618, 618C, 708C, 712C, 716C, 718C	Header Mounting Bracket Use w/ AMX30015 Vertical Bracket	AMX30014	\$ 120.00	
	Vertical Bracket Use w/ AMX30014 Header Mounting Bracket	AMX30015	\$ 72.00	
344, 443, 444, 493, 494, 594, 606, 606C, 608, 608C, 612, 612C, 616, 618, 618C, 642, 643, 644, 645, 693, 694, 708C, 712C, 716C, 718C, 842, 843, 844, 893, 894, 1243, 1290, 1293	Single Row Shoe, 12" Includes Torsion Mounting Bracket	AMX30000	\$ 320.00	
	Replacement Shoe, 12" Torsion Mounting Bracket Not Included	AMX30002	\$ 125.00	
	Stalk Stomper Torsion Unit	AMX30005	\$ 160.00	
	Tool Bar 2" x 2" Square, 72" Long, 3/16" Sidewall Thickness	AMX30003	\$ 75.00	
606, 606C, 608, 608C, 612, 612C, 616, 618, 618C, 708C, 712C, 716C, 718C, 1243, 1290, 1293	Tool Bar 2" x 2" Square, 102" Long, 3/16" Sidewall Thickness	AMX30004	\$ 105.00	
608, 608C, 612, 612C, 616, 618, 618C, 708C, 712C, 716C, 718C, 1243, 1290, 1293	Tool Bar Splice Bracket Use to splice 2 tool bars together to add extended length for various row spacing and additional rows	AMX30006	\$ 42.00	
606, 606C, 608, 608C, 612, 612C, 616, 618, 618C, 708C, 712C, 716C, 718C	End Support Kit	AMX30016	\$ 130.00	

John Deere®—Combine



Cornhead—Hydraulic Deck Plate Kits

Kits include components to connect your cornhead to adjustable hydraulic deck plates.





Application	Description	Part Number	Retail Price	Core
443	Hydraulic Deck Plate Kit 40 Series, 4 Row 30"	AMX27512	\$ 2050.00	
493	Hydraulic Deck Plate Kit 90 Series, 4 Row 30"	AMX27504	\$ 1975.00	
643	Hydraulic Deck Plate Kit 40 Series, 6 Row 30"	AMX27513	\$ 2800.00	
693	Hydraulic Deck Plate Kit 90 Series, 6 Row 30"	AMX27505	\$ 2850.00	
843	Hydraulic Deck Plate Kit 40 Series, 8 Row 30"	AMX27514	\$ 3700.00	
893	Hydraulic Deck Plate Kit 90 Series, 8 Row 30"	AMX27506	\$ 3700.00	
1243	Hydraulic Deck Plate Kits 40 Series, 12 Row 30"	AMX27511	\$ 5400.00	
1293	Hydraulic Deck Plate Kit 90 Series, 12 Row 30"	AMX27503	\$ 5450.00	

Cornhead—Row Unit Components

Row Unit Gearboxes

Application	Description	Part Number	Retail Price	Core
 443, 444, 444SH, 493, 494, 543, 546, 592, 594, 642, 643, 643SH, 644, 645, 692, 693, 694, 842, 843, 844, 892, 893, 894, 1092, 1243, 1290, 1291, 1293	Gearbox, Complete	AMAH209794	\$ 1403.00	
600, 606, 606C, 608, 608C, 612, 612C BSN 745100	Row Unit Gearbox Replaces DE20087	AMDE30412	\$ 3835.00	



Gearbox Components

Application	Description	Part Number	Retail Price	Core
243, 244, 343, 344, 443, 444, 493, 494, 543, 546, 594, 642, 643, 644, 645, 693, 694, 842, 843, 844, 892, 893, 894, 1243, 1290, 1291, 1293	Bearing Cap Includes Bushings For Row Unit Gearbox Replaces AN102512	AMAH87787	\$ 40.37	
 693, 694, 893, 894, 1293, 1693	Drive Shaft For Row Unit Gearbox	AMAH148769	\$ 104.00	
 243, 244, 343, 344, 443, 444, 493, 494, 543, 546, 594, 642, 643, 644, 645, 843, 844, 1243, 1290, 1291, 1293	Gear Assembly For Stalk Roll Drive Replaces AN102004	AMAH146441	\$ 265.00	
 243, 244, 343, 344, 443, 444, 493, 493, 543, 546, 594, 642, 643, 644, 645, 692, 693, 693SH, 694, 842, 843, 844, 892, 893, 894, 1243, 1290, 1291, 1293	Input Gear 17 Tooth	AMH107779	\$ 97.00	
 243, 244, 343, 344, 443, 444, 493, 494, 543, 594, 642, 643, 644, 645, 692, 693, 694, 842, 843, 844, 892, 893, 894, 1243, 1290, 1291, 1293	Row Unit Countershaft 0.872" Diameter, 7.87" Long	AMN102024	\$ 26.87	

Cornhead—Row Unit Components

John Deere®—Combine





Cornhead—Row Unit Components

	Application	Description	Part Number	Retail Price	Core
	243, 244, 343, 344, 443, 444, 493, 494, 543, 546, 594, 642, 643, 644, 645, 692, 693, 694, 842, 843, 844, 892, 893, 894, 1243, 1290, 1291, 1293	Row Unit Gearbox Housing Replaces AH144191, AN102014, AN102430	AMH220669	\$ 431.72	
	243, 244, 343, 344, 443, 444, 483, 493, 494, 543, 546, 583, 594, 642, 643, 644, 645, 683, 692, 693, 693SH, 694, 842, 843, 844, 883, 892, 893, 894, 1092, 1243, 1290, 1291, 1293	Stalk Roll Barrel, Binocular	AMAH84853	\$ 270.00	
	443, 444, 444SH, 493, 494, 543, 546, 592, 594, 642, 643, 643SH, 644, 645, 692, 693, 694, 842, 843, 844, 892, 893, 894, 1092, 1243, 1290, 1291, 1293	Stalk Roll Shaft Replaces AN102001	AMAH143881	\$ 77.00	
	(493, 494, 594, 692, 693, 694, 892, 893, 894, 1092, 1290, 1291, 1293 ASN 705101), (606C, 608C, 612C BSN 745101)	Slip Clutch Hub 12 Tooth, 2.14" Wide, 3.57" OD, 1 1/4" Hex Bore	AMH206755	\$ 121.82	
	(592, 693, 694, 893, 894, 1092, 1290, 1291, 1293 ASN 665401)	Slip Clutch Hub	AMH154122	\$ 131.87	
	443, 444, 444SH, 493, 494, 543, 546, 592, 594, 642, 643, 643SH, 644, 645, 692, 693, 694, 842, 843, 844, 892, 893, 894, 1092, 1243, 1290, 1291, 1293	Slip Clutch Hub 1 1/8" Hex Bore	AMN102036	\$ 46.00	
	243, 244, 343, (444, 543, 643, 644, 645, 843 ASN 322700), (592, 693, 694, 893, 894, 1092, 1290, 1291, 1293 BSN 665200), (606C, 608C, 612C BSN 745101), 1243 ASN 471047	Slip Clutch Jaw	AMN102023	\$ 37.19	
	(493, 494, 594, 692, 693, 694, 892, 893, 894, 1092, 1290, 1291, 1293 ASN 705100)	Slip Clutch Quick Coupler	AMH206870	\$ 52.06	
	243, 244, 343, 344, 443, 444, 494, 543, 642, 643, 644, 692, 693, 694, 842, 843, 844, 892, 893, 894, 1290, 1291, 1293	Slip Clutch Quick Coupler	AMN102040	\$ 69.57	
	443, 444, 643, 644, 693, 694, 843, 844, 893, 894, 1243, 1293, 1294,	Clutch Assembly	AMAH146250	\$ 224.00	
	243, 244, 343, 344, 443, 444, 493, 494, 543, 546, 594, 642, 643, 644, 645, 693, 693SH, 694, 842, 843, 844, 892, 893, 894, 1092, 1243, 1290, 1291, 1293	Ball Bearing, Stalk Roll Pinion Shaft	AMJD9415	\$ 17.00	
	443, 444, 444SH, 493, 494, 543, 546, 592, 594, 642, 643, 643SH, 644, 645, 692, 693, 694, 842, 843, 844, 892, 893, 894, 1092, 1243, 1290, 1291, 1293	Drive Sprocket Shaft Oil Seal	AMAN71326	\$ 3.00	
	243, 244, 343, 344, 443, 444, 493, 494, 543, 546, 594, 642, 643, 644, 645, 692, 693, 694, 842, 843, 844, 892, 893, 894, 1243, 1290, 1291, 1293	Idler Gear	AMAH93577	\$ 145.00	
	(243, 244, 343, 344, 443, 444, 642, 643, 644, 645, 842, 843, 844 BSN 416851), 493, 494, 594, 692, 693, 694, 892, 893, 894, 1243 ASN 470496, 1290, 1291, 1293	Input Cap Shim, 0.01"	AMN102008	\$ 1.89	
	243, 244, 343, 344, 443, 444, 483, 493, 494, 543, 546, 583, 642, 643, 644, 645, 683, 692, 693, 694, 842, 843, 844, 883, 892, 893, 894, 1092, 1243, 1290, 1293	Input Spur Gear Oil Seal	AMAN102006	\$ 10.00	
	243, 244, 343, 344, 443, 444, 493, 494, 543, 546, 594, 642, 643, 644, 645, 692, 693, 694, 842, 843, 844, 892, 893, 894, 1243, 1290, 1291, 1293	Input Spur Gear Thrust Washer	AMN102032	\$ 11.85	









Prices Subject to Change without Prior Notice. The use of original equipment manufacturer (OEM) part numbers or trademarks, e.g. Case® and John Deere®, are for reference purposes only and for indicating product use and compatibility. Our company and the listed replacement parts contained herein are not sponsored, approved or manufactured by the OEM. All parts are New unless designated Reman in the description.

John Deere®—Combine

Cornhead—Row Unit Components

	Application	Description	Part Number	Retail Price	Core
	243, 244, 343, 344, 443, 444, 493, 494, 543, 594, 642, 643, 644, 645, 692, 693, 694, 842, 843, 844, 892, 893, 894, 1243, 1290, 1291, 1293	Needle Bearing 2" ID, 2.378" OD, 0.995" Wide For Row Unit Gearbox	AMJD8896	\$ 20.00	
	243, 244, 343, 344, 443, 444, 493, 494, 543, 594, 642, 643, 644, 645, 692, 693, 694, 842, 843, 844, 892, 893, 894, 1243, 1290, 1291, 1293	Needle Bearing 1" ID, 1.3125" OD, 0.75" Wide For Row Unit Gearbox Replaces JD9974	AMJD8877	\$ 8.00	
	443, 444, 444SH, 493, 494, 543, 546, 592, 594, 642, 643, 643SH, 644, 645, 692, 693, 694, 842, 843, 844, 892, 893, 894, 1092, 1243, 1290, 1291, 1293	Stalk Roll Barrel Bearing & Seal Kit Includes (2) Needle Bearings, (2) Ball Bearings and (2) Seals	AMX27109	\$ 45.50	
	443, 444, 444SH, 493, 494, 543, 546, 592, 594, 642, 643, 643SH, 644, 645, 692, 693, 694, 842, 843, 844, 892, 893, 894, 1092, 1243, 1290, 1291, 1293	Stalk Roll, Seal	AMAN102266	\$ 6.00	

















Row Unit Components

	Application	Description	Part Number	Retail Price	Core
	243, 244, 343, 344, 443, 444, 483, 493, 494, 543, 546, 583, 594, 642, 643, 644, 645, 683, 692, 693, 693SH, 694, 842, 843, 844, 883, 892, 893, 894, 1092, 1243, 1290, 1291, 1293	Chain and Sprocket Kit Includes Chain, Hex Drive Sprocket and Greaseable Idler	AMX27128	\$ 51.00	
		Chain and Sprocket Kit Includes Chain, Hex Drive Sprocket and Non-Greaseable Idler	AMX27126	\$ 51.00	
	443, 444, 444SH, 493, 494, 543, 546, 592, 594, 642, 643, 643SH, 644, 645, 692, 693, 694, 842, 843, 844, 892, 893, 894, 1092, 1243, 1290, 1291, 1293	Chain Paddle Kit (32) Paddles, Hardware and Instructions Replaces H209897, H209898	AMH201762	\$ 66.00	
	243, 244, 343, 344, 443, 444, 483, 493, 494, 543, 546, 583, 594, 642, 643, 644, 645, 683, 692, 693, 693SH, 694, 842, 843, 844, 883, 892, 893, 894, 1092, 1243, 1290, 1291, 1293	Gathering Chain Sprocket 8 Tooth, 1" Hex Bore	AMH85252	\$ 14.00	
	243, 244, 343, 344, 443, 444, 483, 493, 494, 543, 546, 583, 594, 642, 643, 644, 645, 683, 692, 693, 693SH, 694, 842, 843, 844, 883, 892, 893, 894, 1092, 1243, 1290, 1291, 1293 Replaces AN102009	Gathering Chain, Black 48 Links, 8 Lug 2.63" Wide Attachment Links	AMCHG-100	\$ 36.00	
	243, 244, 343, 344, 443, 444, 483, 493, 494, 543, 546, 583, 594, 642, 643, 644, 645, 683, 692, 693, 693SH, 694, 842, 843, 844, 883, 892, 893, 894, 1092, 1243, 1290, 1291, 1293, 1693	Idler Sprocket, Greaseable 8 Tooth, 0.65" ID	AMAH101219	\$ 13.00	
		Idler Sprocket, Non-Greaseable 8 Tooth, 0.65" ID	AMAN102448	\$ 13.00	
	243, 244, 343, 344, 443, 444, 493, 494, 543, 546, 594, 642, 643, 644, 645, 692, 693, 694, 842, 843, 844, 892, 893, 894, 1092, 1243, 1290, 1291, 1293	Cap w/ Grease Zerk	AMAH204016	\$ 7.02	
	(606, 606C, 608, 608C, 612, 612C BSN 745100)	Chain and Sprocket Kit Includes AMAH208978 Cornhead Chain (Chrome Pins), AMH233287 Drive Sprocket and AMAH231386 Idler Sprocket	AMX27283	\$ 122.00	
	(606, 606C, 608, 608C, 612, 612C ASN 745101), (608FC, 706C, 708C, 708FC, 712C, 712FC, 716C, 718C ASN 129189), 612FC, 616, 616C, 618, 618C	Drive Sprocket Kit Includes Drive Sprocket and V-Ring Seals	AMKXE10488	\$ 40.76	
	(606, 608, 612 BSN 745100)	Gathering Chain Black Pin	AMAH233138	\$ 90.00	

Prices Subject to Change without Prior Notice. The use of original equipment manufacturer (OEM) part numbers or trademarks, e.g. Case® and John Deere®, are for reference purposes only and for indicating product use and compatibility. Our company and the listed replacement parts contained herein are not sponsored, approved or manufactured by the OEM. All parts are New unless designated Reman in the description.

















John Deere®—Combine

Cornhead—Row Unit Components

	Application	Description	Part Number	Retail Price	Core
	(606, 606C, 608, 608C, 612, 612C BSN 745100)	Idle Sprocket	AMAH231386	\$ 43.00	
	(606, 606C, 608, 608C, 612C ASN745101), 608FC ASN129189, 616, 616C, 618, 618C	Idle Sprocket Replaces AXE18770	AMAXE63766	\$ 31.00	
	(606, 608, 612, 616, 618 BSN 756330)	Sprocket 6 Tooth For Row Unit	AMAXE36872	\$ 44.64	
	(606, 606C, 608, 608C, 612, 612C BSN 745100)	Cornhead Chain, Chrome Pins	AMAH208978	\$ 51.00	
	(606, 606C, 608, 608C, 612, 612C ASN 745100), 608FC ASN 129188, 612FC, 616, 616C, 618, 618C, 706C, 708, 708FC, 712, 712FC, 716C, 718C	Chain Guide Latch, Right Hand	AMH237841	\$ 40.81	
		Chain Guide Latch, Left Hand	AMH237885	\$ 40.81	
	(606, 606C, 608, 608C, 612, 612C BSN 745100)	Drive Sprocket	AMH233287	\$ 38.00	
	(606, 608, 612, 616, 618 ASN 745101)	Chain and Sprocket Kit	AMX29123	\$ 117.00	
	(606C, 608C, 612C ASN 745100), 612FC, 616, 616C, 618, 618C, 706C, 708C, 708FC, 712C 712FC, 716C, 718C	Gathering Chain Chrome Pins Replaces AXE61091	AMAH234578	\$ 66.00	
	(606, 606C, 608, 608C, 612, 612C ASN 745101), 612FC, 616, 616C, 618, 618C, 706C, 708C, 708FC, 712C, 712FC, 716C, 718C	Gathering Chain RowMax™ Chrome Pin	AMAXE62423	\$ 94.00	
	(606, 606C, 608, 608C, 612, 612C ASN 745100 w/ RowMax™), 12FC, 706C, 708C, 708FC, 712C, 712FC, 716C, 718C, (616, 616C, 618, 618C - w/ RowMax™)	Idle Sprocket 8 Tooth, 0.512" Bore Diameter	AMAXE62424	\$ 30.81	
	(606, 608, 612, 616, 618 ASN 756331)	Sprocket Kit Includes (1) Sprocket and (2) V-Ring Seals For Row Unit Drive	AMKXE10258	\$ 42.00	
	(243, 244, 343, 344, 443, 444, 483, 543, 546, 583, 642, 643, 644, 645, 683, 842, 843, 844, 883, 1243 ASN 466451)	Deck Plate, Right and Left Hand 27 1/2" Long	AMH94952	\$ 19.00	
	(243, 244, 343, 344, 443, 444, 543, 546, 642, 643, 644, 645, 842, 843, 844, 1243 BSN 466451)	Deck Plate, Right Hand 25 3/16" Long	AMN102068	\$ 22.00	
		Deck Plate, Left Hand 25 3/16" Long	AMN102069	\$ 22.00	
	493, 592, 594, 692, 693, 694, 892, 893, 894, 1092, 1290, 1291, 1293	Deck Plate, Right and Left Hand	AMH154270	\$ 54.00	
	493, 592, 594, 692, 693, 694, 892, 893, 894, 1092, 1290, 1291, 1293	Deck Plate, Left Hand Hydraulic Adjust	AMAH147773	\$ 66.00	
	493, 592, 594, 692, 693, 694, 892, 893, 894, 1092, 1290, 1291, 1293	Deck Plate Cover, Left Hand Hydraulic Adjust	AMAH140825	\$ 50.00	











John Deere®—Combine

Cornhead—Row Unit Components

Application	Description	Part Number	Retail Price	Core
606, 608, 612	Deck Plate Knife, Right Hand	AMH234210	\$ 61.79	
	Deck Plate Knife, Left Hand	AMH234211	\$ 56.22	
 (606, 606C, 608, 608C, 612, 612C BSN 745100)	Deck Plate w/ Lip - Adjustable	AMAXE17618	\$ 65.00	
 (606, 606C, 608, 608C, 612, 612C BSN 745100)	Deck Plate w/ Lip - Fixed	AMHXE24566	\$ 45.00	
 (606, 608, 608C, 612, 612C ASN 745101), 606C, 612FC, 616, 616C, 618, 618C, 706C, 708C, 708FC, 712C, 712FC, 716C, 718C	Deck Plate, Adjustable	AMAH234656	\$ 76.00	
 606, (606C, 608C, 612, 612C ASN 745100), 608, 608FC ASN 129188, 612FC, 616, 616C, 618, 618C, 706C, 708C, 708FC, 712C, 712FC, 716C, 718C	Deck Plate, Fixed	AMH237437	\$ 53.00	
 (606, 606C, 608, 608C, 612, 612C BSN 745100)	Deck Plate, Hardfaced - Adjustable	AMAH232250	\$ 71.00	
 (606, 606C, 608, 608C, 612, 612C BSN 745100)	Deck Plate, Hardfaced - Fixed	AMH225719	\$ 46.00	
 606, 608, 612, 693, 694, 893, 894, 1293, 1693	Deck Plate Indicator Shaft	AMR111692	\$ 29.67	
 443, 444, 444SH, 493, 494, 543, 546, 592, 594, 642, 643, 643SH, 644, 645, 692, 693, 694, 842, 843, 844, 892, 893, 894, 1092, 1243, 1290, 1291, 1293	Stalk Roll, Right Hand Straight Roll, 1-Bolt Mounting	AMH104090	\$ 87.00	
	Stalk Roll, Left Hand Straight Roll, 1-Bolt Mounting	AMH104091	\$ 87.00	
 493, 494, 594, 643, 692, 693, 694, 892, 893, 894, 1092, 1290, 1291, 1293	Stalk Roll, Right Hand	AMH148320	\$ 87.00	
	Stalk Roll, Left Hand	AMH148321	\$ 87.00	
 493, 592, 594, 692, 693, 694, 892, 893, 894, 1092, 1290, 1291, 1293 - w/ Straight Cast Rolls	Stalk Roll, Right Hand 2-Bolt Mounting	AMH150138	\$ 92.00	
	Stalk Roll, Left Hand 2-Bolt Mounting	AMH150139	\$ 89.00	
 443, 444, 643, 644, 693, 694, 843, 844, 893, 894, 1243, 1293, 1693	Stalk Roll Knife, Right Hand	AMH150690	\$ 112.00	
	Stalk Roll Knife, Left Hand	AMH150691	\$ 112.00	
 606C, 608C, 612C, 616C, 618C, 706C, 708C, 708FC, 712C, 712FC, 716C, 718C	Stalk Chopping Knife Heat Treated, Tungsten Carbide	AMHXE36504	\$ 23.50	
 606C, 608C, 612C, 616C, 618C, 706C, 708C, 708FC, 712C, 712FC, 716C, 718C	Bushing, Chopping Gearbox Blades	AMHXE24237	\$ 10.65	
 243, 244, 343, 344, 443, 444, 483, 493, 494, 543, 546, 583, 594, 642, 643, 644, 645, 683, 692, 693, 693SH, 694, 842, 843, 844, 883, 892, 893, 894, 1092, 1243, 1290, 1291, 1293	Cast Chain Guide	AMH151211	\$ 24.00	
 243, 244, 343, 344, 443, 444, 543, 546, 642, 643, 644, 645, 842, 843, 844, 1243	Steel Chain Guide	AMH118945	\$ 17.50	
 606, 606C, 608, 608C, 612, 612C, 612FC, 616, 616C, 706C, 708C, 708FC, 712C, 716C, 718C	Chain Guide, Right Hand RowMax™	AMHXE111768	\$ 12.00	
	Chain Guide, Left Hand RowMax™	AMHXE111724	\$ 12.00	
 (606, 606C, 608, 608C, 612, 612C ASN 745101), 608FC ASN 129189, 612FC, 616, 616C, 618, 618C	Chain Guide, Right Hand	AMAH235033	\$ 34.00	
	Chain Guide, Left Hand	AMAH235031	\$ 33.00	

John Deere®—Combine

Cornhead—Row Unit Components

	Application	Description	Part Number	Retail Price	Core
	(606, 606C, 608, 608C, 612, 612C ASN 745101), 612FC, 616, 616C, 618, 618C, 706C, 708C, 712C, 712FC, 716C, 718C	Guide Plate Replaces HXE13268	AMHXE78964	\$ 29.00	
	(606, 606C, 608, 608C, 612, 612C ASN 745101), 608FC ASN 129189, 612FC, 616, 616C, 618, 618C, 706C, 708C, 708FC, 712C, 712FC, 716C, 718C	Guard Deflector	AMAXE18146	\$ 175.00	
	443, 444, 444SH, 493, 494, 543, 546, 592, 594, 642, 643, 643SH, 644, 645, 692, 693, 694, 842, 843, 844, 892, 893, 894, 1092, 1243, 1290, 1291, 1293	Idler Strap	AMH144503	\$ 37.00	
	493, 592, 594, 692, 693, 694, 892, 893, 894, 1092, 1290, 1291, 1293	Lower Idler Support	AMH153898	\$ 28.00	
	443, 444, 444SH, 543, 546, 642, 643, 643SH, 644, 645, 842, 843, 844, 894, 1243	Lower Idler Support	AMH84479	\$ 18.00	
	606, 608, 612	Support For Deck Plate Sensor	AMR86457	\$ 2.21	
	443, 444, 444SH, 493, 494, 543, 546, 592, 594, 642, 643, 643SH, 644, 645, 692, 693, 694, 842, 843, 844, 892, 893, 894, 1092, 1243, 1290, 1291, 1293	Tension Spring Bolt	AM08H4219	\$ 5.00	
	443, 444, 444SH, 493, 494, 543, 546, 592, 594, 642, 643, 643SH, 644, 645, 692, 693, 694, 842, 843, 844, 892, 893, 894, 1092, 1243, 1290, 1291, 1293	Tension Spring Flat Washer	AM24H1373	\$ 1.20	
	243, 244, 343, 344, 443, 444, 493, 494, 543, 546, 642, 643, 644, 693, 693SH, 694, 843, 844, 893, 894, 1243, 1293	Stalk Roll Shim 0.010" Thick Sold in Multiples of 2, Priced Individually	AMN102004	\$ 2.84	
	443, 444, 444SH, 493, 494, 543, 546, 592, 594, 642, 643, 643SH, 644, 645, 692, 693, 694, 842, 843, 844, 892, 893, 894, 1092, 1243, 1290, 1291, 1293	Tension Spring, Lower Idler Support	AMN61703	\$ 4.50	
	606, 608, 612	Spring For Auger Slip Clutch Drive	AMH101276	\$ 17.92	
	606, 608, 612	Tensioner Strap For Gathering Chain	AMH215634	\$ 29.35	
	443, 444, 444SH, 493, 494, 543, 546, 592, 594, 642, 643, 643SH, 644, 645, 692, 693, 694, 842, 843, 844, 892, 893, 894, 1092, 1243, 1290, 1291, 1293	Bushing Spring Cover	AMN104096	\$ 7.00	
	(600, 606, 606C, 608, 608C, 612, 612C BSN 745100)	Rotary Sensor Automatic Header Height Replaces AH228517, AH230475	AMAH233087	\$ 85.00	
	600, 606, 606C, 608, 608C, 612, 612C	Header Height Sensor, Contour-Master™ Left Hand Replaces AXE57249	AMAXE17036	\$ 78.00	

John Deere®—Combine

Curtain Components

Application	Description	Part Number	Retail Price	Core
 606C BSN 745100 - 30"	StalkMaster™ Rubber Curtain Kit Includes AMH227177 (29" x 9"), AMH228482 (40.44" x 17.75"), AMH228483 (42.62" x 17.75") and (2) AMH227178 (9" x 5") Rubber Shields	AMX28040	\$ 219.00	
 606C ASN 745101 - 30"	StalkMaster™ Rubber Curtain Kit Includes (2) AMHXE89078 (31.56" x 9.50") and (2) AMHXE30386 (54.06" x 9.50") Rubber Shields	AMX28041	\$ 185.00	
 608C BSN 745100 - 30"	StalkMaster™ Rubber Curtain Kit Includes AMH227180 (41.62" x 17.75"), AMH227181 (43.62" x 17.62"), (2) AMH227178 (9" x 5") and (3) AMH227177 (29" x 9") Rubber Shields	AMX28042	\$ 265.00	
 608C ASN 745101 - 30"	StalkMaster™ Rubber Curtain Kit Includes (2) AMHXE21077 (18.50" x 9.50"), (2) AMHXE89079 (42.50" x 9.50") and (2) AMHXE30386 (54.06" x 9.50") Rubber Shields	AMX28043	\$ 265.00	
 612C BSN 745100 - 22"	StalkMaster™ Rubber Curtain Kit Includes AMH228513 (31.19" x 17.75"), AMH228514 (33.50" x 17.62"), (2) AMH227178 (9" x 5"), (2) AMH227184 (26.25" x 9") and (3) AMH227177 (29" x 9") Rubber Shields	AMX28045	\$ 330.00	
 612C BSN 745100 - 30"	StalkMaster™ Rubber Curtain Kit Includes AMH227182 (21" x 18"), (2) AMH227178 (9" x 5"), (2) AMH227185 (16" x 9"), (2) AMH227184 (26.25" x 9") and (3) AMH227177 (29" x 9") Rubber Shields	AMX28048	\$ 425.00	
 612C ASN 745101, 712C - 20"	StalkMaster™ Rubber Curtain Kit Includes (2) AMHXE21077 (18.50" x 9.50"), (2) AMHXE89083 (42.62" x 9.50") and (2) AMHXE30386 (54.06" x 9.50") Rubber Shields	AMX28044	\$ 280.00	
 612C SN 745101-774999 - 22"	StalkMaster™ Rubber Curtain Kit Includes (2) AMHXE21077 (18.50" x 9.50"), (2) AMHXE30386 (54.06" x 9.50") and (2) AMHXE89085 (59.25" x 9.50")	AMX28046	\$ 285.00	
 612C ASN 775000, 712C - 22"	StalkMaster™ Rubber Curtain Kit Includes (2) AMHXE89077 (18.50" x 9.50") and (2) AMHXE30386 (54.06" x 9.50")	AMX28047	\$ 290.00	
 612C ASN 745101, 712C - 30"	StalkMaster™ Rubber Curtain Kit Includes (2) AMHXE30386 (54.06" x 9.50"), (2) AMHXE89082 (59.25" x 9.50") and (2) AMHXE17918 (67.50" x 9.50") Rubber Shields	AMX28049	\$ 385.00	
 612FC, 712FC - 30"	StalkMaster™ Rubber Curtain Kit Includes (2) AM5XB00758 (30.50" x 9.50"), (2) AM5XB00763 (34.12" x 9.50"), (2) AM5XB00759 (50.75" x 9.37") and (2) AMHXE30386 (54.06" x 9.50") Rubber Shields	AMX28050	\$ 695.00	
 616C, 716C - 30"	StalkMaster™ Rubber Curtain Kit Includes (2) AMHXE21077 (18.50" x 9.50"), (2) AMHXE17919 (39.50" x 7.50"), (2) AMHXE20821 (48.75" x 9.50") and (2) AMHXE89084 (74.44" x 9.50") Rubber Shields	AMX28051	\$ 535.00	

Cornhead—Row Unit Components

John Deere®—Combine

Cornhead—Row Unit Components

Application	Description	Part Number	Retail Price	Core
 618C, 718C - 20"	StalkMaster™ Rubber Curtain Kit Includes (2) AMHXE21077 (18.50" x 9.50"), (2) AMHXE20821 (48.75" x 9.50"), (2) AMHXE30386 (54.06" x 9.50") and (2) AMHXE89085 (59.25" x 9.50") Rubber Shields	AMX28052	\$ 365.00	
 618C, 718C - 22"	StalkMaster™ Rubber Curtain Kit Includes (2) AMHXE21077 (18.50" x 9.50"), (2) AMHXE20821 (48.75" x 9.50"), (2) AMHXE30386 (54.06" x 9.50") and (2) AMHXE89086 (76" x 9.50") Rubber Shields	AMX28053	\$ 425.00	
 (606, 606C, 608, 608C BSN 745100), 612, 612C, 712C, C12R	StalkMaster™ Rubber Curtain, Rear 23.25" Long, 9.50" Wide	AMHXE89077	\$ 41.00	
 (606, 606C, 608, 608C BSN 745100), 612, 612C, 712C, C12R	StalkMaster™ Rubber Curtain, Rear 49.62" Long, 9.50" Wide	AMHXE89083	\$ 88.00	
 (606, 606C, 608C ASN 745100), 612, 612C, 712C, C12R	StalkMaster™ Rubber Curtain, Rear 53.25" Long, 9.50" Wide	AMHXE89082	\$ 60.00	
 (606, 606C, 612, 612C ASN 745100), 608, 608C, 708C, C8R	StalkMaster™ Rubber Curtain, Rear 42.50" Long, 9.50" Wide	AMHXE89079	\$ 77.00	
 606, 606C, 608, 608C, 612, 612FC, 616, 616C, 618, 618C, 706C, 708C, 712C, 716C, C6R, C8R, C12R, C16R, C18R	StalkMaster™ Rubber Curtain, Rear 54.06" Long, 9.50" Wide	AMHXE30386	\$ 60.00	
 606, 606C, 706C, C6R, (608, 608C, 612, 612C BSN 745100)	StalkMaster™ Rubber Curtain, Rear 31.56" Long, 9.50" Wide	AMHXE89078	\$ 54.00	
 612FC, 712FC	StalkMaster™ Rubber Curtain, Rear 30.50" Long, 9.50" Wide	AM5XB00758	\$ 114.13	
 612FC, 712FC	StalkMaster™ Rubber Curtain, Rear 50.75" Long, 9.37" Wide	AM5XB00759	\$ 133.00	
 612FC, 712FC	StalkMaster™ Rubber Curtain, Rear 34.12" Long, 9.50" Wide	AM5XB00763	\$ 67.00	
 616, 616C, 618, 618C, 716C, 718C, C16R, C18R	StalkMaster™ Rubber Curtain, Rear 18.50" Long, 9.50" Wide	AMHXE21077	\$ 40.42	
 616, 616C, 618, 618C, 716C, 718C, C16R, C18R	StalkMaster™ Rubber Curtain, Rear 48.75" Long, 9.50" Wide	AMHXE20821	\$ 80.84	
 618, 618C, 718C, C18R	StalkMaster™ Rubber Curtain, Rear 59.25" Long, 9.50" Wide	AMHXE89085	\$ 64.20	
 618, 618C, 718C, C18R	StalkMaster™ Rubber Curtain, Rear 76" Long, 9.50" Wide	AMHXE89086	\$ 78.47	
 616, 616C, 716C, C16R	StalkMaster™ Rubber Curtain, Rear 74.44" Long, 9.50" Wide	AMHXE89084	\$ 74.90	
 (606, 606C ASN 745100), 608, 608C, 612, 612C, 708C, 712C, C8R, C12R	StalkMaster™ Rubber Shield 40.31" Long, 9.50" Wide	AMHXE89081	\$ 122.45	
 (606C, 608C BSN 745101 - 30", 36", 38"), (612C BSN 745101 - 20", 22", 30")	StalkMaster™ Rubber Shield 9" Long, 5" Wide	AMH227178	\$ 36.00	
 (606C, 608C BSN 745101 - 30", 36", 38"), (612C BSN 745101 - 20", 22", 30")	StalkMaster™ Rubber Shield 29" Long, 9" Wide	AMH227177	\$ 34.48	





John Deere®—Combine

Cornhead—Row Unit Components

	Application	Description	Part Number	Retail Price	Core
	612C BSN 745101 - 20", 22", 30"	StalkMaster™ Rubber Shield 26.25" Long, 9" Wide	AMH227184	\$ 39.24	
	612C BSN 745101 - 30"	StalkMaster™ Rubber Shield 16" Long, 9" Wide	AMH227185	\$ 44.00	
	606C BSN 745101 - 30", 36", 38"	StalkMaster™ Rubber Shield, End 40.44" Long, 17.75" Wide	AMH228482	\$ 72.52	
	608C BSN 745101 - 30", 36", 38"	StalkMaster™ Rubber Shield, End 41.62" Long, 17.75" Wide	AMH227180	\$ 66.58	
	606C BSN 745101 - 30", 36", 38"	StalkMaster™ Rubber Shield, End 42.62" Long, 17.75" Wide	AMH228483	\$ 73.71	
	608C BSN 745101 - 30", 36", 38"	StalkMaster™ Rubber Shield, End 43.62" Long, 17.62" Wide	AMH227181	\$ 60.63	
	612C BSN 745101 - 22"	StalkMaster™ Rubber Shield, End 31.19" Long, 17.75" Wide	AMH228513	\$ 63.00	
	612C BSN 745101 - 22"	StalkMaster™ Rubber Shield, End 33.50" Long, 17.62" Wide	AMH228514	\$ 61.82	
	612C BSN 745101 - 30"	StalkMaster™ Rubber Shield, End 21" Long, 18" Wide	AMH227182	\$ 78.00	
	612C BSN 745101 - 30"	StalkMaster™ Rubber Shield, End 43.75" Long, 17.87" Wide	AMH227183	\$ 76.09	
	(606, 606C, 608, 608C, 612, 612C BSN 745100)	StalkMaster™ Rubber Divider Shield 29.87" Long, 7" Wide	AMHXE26384	\$ 30.00	
	(606, 606C, 608, 608C, 612, 612C BSN 745100), 712C, C12R	Rubber Curtain, Rear 67.50" Long, 9.50" Wide	AMHXE17918	\$ 89.17	
	616, 616C, 716C, C16R	Rubber Curtain, Rear 39.50" Long, 7.50" Wide	AMHXE17919	\$ 96.00	
	(606, 606C, 608, 608C, 612, 612C BSN 745100)	Rubber Side Curtain 22.50" Long, 8.50" Wide	AMH219002	\$ 36.86	
	(606, 606C, 608, 608C, 612, 612C BSN 745100)	Rubber Divider Shield 11" Long, 6" Wide	AMH227244	\$ 71.00	
	(606, 606C, 608, 608C, 612, 612C BSN 745100)	Rubber Divider Shield "14.50" Long, 6" Wide"	AMHXE27218	\$ 33.00	
	(606, 606C, 608, 608C, 612, 612C BSN 745100)	Rubber Divider Shield "9" Long, 9" Wide"	AMHXE33997	\$ 52.00	
	(606, 606C, 608, 608C, 612, 612C BSN 745100)	Rubber Divider Shield "13" Long, 10" Wide"	AMHXE34386	\$ 40.42	

John Deere®—Combine









Auger Drive Components

Application	Description	Part Number	Retail Price	Core
(493, 494 BSN 655200), (594, 693, 893, 894, 1293 BSN 655400)	Chain Sprocket 64 Tooth, 13.11" OD, 1.13" Hex Bore For Size 50 Chain	AMAH145940	\$ 157.30	
(493, 494 BSN 660200), 592, 594, 692, 693, 694, 892, 893, 894, 1092	Drive Sprocket 34 Tooth, 8.508 OD, 1.13" Hex Hub Diameter For Size 60 Chain	AMAH111501	\$ 72.04	
 (493, 494 ASN 665201), (594, 693, 893, 1290, 1291, 1293 ASN 665401)	Drive Sprocket 52 Tooth, 12.848" OD, 1.13" Hex Hub Diameter For Size 60 Chain	AMAH147693	\$ 175.33	
 (493, 693, 694, 893, 894 1092, 1290, 1291 ASN 665401), (494, 592 ASN 665201), 1293 ASN 705101	Chain Sprocket 13 Tooth, 1.756" ID, 3.475" OD	AMAH143100	\$ 69.00	
443 ASN 620252, 444 ASN 620307, (493, 494 ASN 660199), 543 ASN 620306, 546 ASN 620401, 592, 594, 643 ASN 620537, 644 ASN 620576, 645 ASN 620602, 692, 693, 843 ASN 620717, 844 ASN 620711, 893, 894, 1243	Chain Sprocket 28 Tooth, 7.196" OD, 1.13" Hex Hub Diameter For Size 60 Chain	AMAH124999	\$ 60.82	
 (493, 494 BSN 655200), (592, 693, 694, 893, 894, 1092, 1290, 1291 BSN 655400), 1243, 1293 BSN 705100	Drive Sprocket 17 Tooth, 1.942" ID, 3.711" OD For Size 50 Chain	AMAH143227	\$ 110.96	
 243, 244, 343, 344, 443, 444, 483, 493 SN 665201-670356, (494, 692, 693, 693SH, 694, 892, 893, 894 BSN 670356), 543, 546, 583, (592, 1092, 1290, 1291, 1293 BSN 659999), 594, 642, 643, 644, 645, 683, 842, 843, 883, 1243 BSN 630750	Idler Sprocket 15 Tooth, 0.638" ID For Size 60 Chain	AMAE27909	\$ 29.38	
493, 494, 594, 643 ASN 620449, 644 ASN 620549, 645 ASN 620600, 693, 694, 893, 894, 1293	Drive Sprocket 14 Tooth, 3.483" OD, 1.13" Hex Hub Diameter For Row Unit	AMAH91784	\$ 67.99	
692 BSN 705250, 693 BSN 705437, 694 BSN 705420, 892 BSN 705500, 893 BSN 705984, 894 BSN 705667	Chain Sprocket 25 Tooth, 6.367" OD, 1.13" Hex Bore For Size 60 Chain	AMAH145983	\$ 73.30	
 344 BSN 569762, 443 BSN 620251, (493, 494 SN 660201-705437), (543, 546, 642, 643, 644, 645, 842, 843 BSN 332701), 692 BSN 705250, 693 BSN 705437, 694 BSN 705420, 892 BSN 705500, 894 BSN 705667	Drive Sprocket 30 Tooth, 1.13" ID, 7.59" OD For Size 60 Chain	AMAN102027	\$ 74.73	
592, 693, 694, 893, 894	Drive Sprocket 33 Tooth, 8.288" OD, 1.13" Hex Bore Diameter For Size 60 Chain For Row Unit	AMAH215181	\$ 112.56	
592, 693, 694, 893, 894	Drive Sprocket 24 Tooth, 6.139" OD, 1.13" Hex Hub Diameter For Size 60 Chain For Row Unit	AMAH215182	\$ 99.85	
592, 693, 694, 893, 894, 1092, 1291, 1293	Drive Sprocket 19 Tooth, 8.245" OD, 1.264" Hex Bore Diameter For Size 100 Chain For Row Unit	AMAH223489	\$ 80.10	
(1092, 1290, 1291, 1293 BSN 710100), 1243	Chain Sprocket 23 Tooth, 7.857" OD, 1.13" Hex Hub Diameter For Size 80 Chain	AMAH114830	\$ 124.97	
1092, 1290, 1291, 1293	Drive Sprocket 24 Tooth, 8.203" OD, 1.263" Hex Bore Diameter For Size 80 Chain For Row Unit	AMAH215519	\$ 70.11	



Cornhead—Row Unit Components

John Deere®—Combine











Cornhead—Row Unit Components

Application	Description	Part Number	Retail Price	Core
1092, 1290, 1291, 1293	Drive Sprocket 17 Tooth, 5.938" OD, 1.262" Hex Bore Diameter For Size 80 Chain For Row Unit	AMAH215521	\$ 53.04	
1092, 1290, 1291, 1293	Drive Sprocket 17 Tooth, 5.912" OD, 1.13" Hex Bore Diameter For Size 80 Chain For Row Unit	AMAH215495	\$ 53.67	
1293 ASN 705100	Drive Sprocket 18 Tooth, 6.269" OD, 1.255" Hex Bore Diameter For Size 80 Chain	AMAH206761	\$ 99.52	
1293 ASN 705100	Drive Sprocket 22 Tooth, 7.585" OD, 1.257" Hex Bore Diameter For Size 80 Chain	AMAH206760	\$ 111.82	
(606, 608, 612, 1092, 1290, 1291, 1293 - w/ StalkMaster™), 612	Chain Sprocket 12 Tooth, 0.637" ID, 4.334" OD For Auger Drive	AMAH216239	\$ 74.24	
 493, 494, 592, 594, 606, 608, 612, 693, 694, 893, 894, 900 Series, 1092, 1290, 1291, 1293	Pressed Flanged Housing	AMH161529	\$ 3.15	
(444, 543, 546, 643, 644, 645, 843 ASN 382700), (493, 494 BSN 665201), (592, 693, 694, 893, 894, 1092, 1290, 1291, 1293 SN 660000-665401), 844 ASN 380600, 1243 ASN 471047	Slip Clutch Hub	AMH135198	\$ 141.05	
592, 606, 608, 612, 693, 694, 893, 894, 1092, 1290, 1291, 1293	Slip Clutch Housing For Auger Drive	AMH209926	\$ 109.85	
 (592, 693, 694, 863, 894, 1092, 1290, 1291, 1293 ASN 665401), 606, 608, 612	Slip Clutch Jaw	AMH101677	\$ 29.25	
 (592, 693, 694, 863, 894, 1092, 1290, 1291, 1293 ASN 665401), 606, 608, 612	Washer For Auger Drive	AMH99303	\$ 4.91	
 606, 608, 612	Slip Clutch Drive Sprocket 10 Tooth, 1.756" ID, 3.674" OD For Auger Drive	AMAH222303	\$ 79.87	
606, 608, 612 w/ StalkMaster™	Slip Clutch Drive Sprocket 10 Tooth, 1.875" ID, 3.674" OD For Auger Drive	AMAH227660	\$ 126.34	
 493, 494, 592, 594, 606, 608, 612, 693, 694, 893, 894, 1092, 1290, 1291, 1293	Ball Bearing Hex Bore For Auger Drive	AMAN102010	\$ 15.00	
 606, 608, 612	Ball Bearing For Gathering Chain Idler Sprocket	AMAA61722	\$ 4.00	
 606, 608, 612	Ball Bearing	AMJD10018	\$ 24.89	
 606, 608, 612 - w/ StalkMaster™	Ball Bearing 1.50" Hex Bore	AMAE40895	\$ 37.00	
 606, 608, 612, 693, 694, 893, 894, 1293, 1693	Ball Bearing 1.251" ID, 2.835" OD	AMJD9420	\$ 28.09	
(606, 608, 612 BSN 745100)	Bearing Cap	AMHXE25730	\$ 10.00	

John Deere®—Combine

	Application	Description	Part Number	Retail Price	Core
	606, 608, 612	Bearing Cap For Gathering Chain	AMH233285	\$ 6.55	
	606, 608, 612	Bushing For Chopper Blade	AMH233284	\$ 8.88	





Roller Chains and Components

	Application	Description	Part Number	Retail Price	Core
	344, 443 BSN 620250, 444	Roller Chain, Row Unit Drive 85 Links, Size 60 Chain	AMAN102498	\$ 35.00	
	493, 494 ASN 665201, 592, 693, 694, 893, 894 ASN 665401	Roller Chain, Auger Drive 69 Links, Size 60 Chain	AMAH147697	\$ 35.00	
	493, 494 BSN 660200, 1293 BSN 659999	Roller Chain, Auger Drive 77 Links, Size 50 Chain	AMAH98784	\$ 25.00	
	493, 494 SN 660201-665200, 592, 594, 693, 694, 893, 894 SN 660000-665400, 1092, 1290, 1291 BSN 659999	Roller Chain, Auger Drive Slowdown 83 Links, Size 50 Chain	AMAH145941	\$ 30.00	
	493, 494 ASN 670357, 692, 693, 694, 892, 893, 894 ASN 705101	Roller Chain, Row Unit Drive 94 Links, Size 60H Chain	AMAH208711	\$ 59.00	
	493, 494 SN 660201-670356, 692, 693, 694, 892, 893, 894 SN 695301-705100	Roller Chain, Row Unit Drive 94 Links, Size 60 Chain	AMAH201472	\$ 45.00	
	692, 693, 694, 892, 893, 894 ASN 705101	Roller Chain, Row Unit Drive 88 Links, Size 60H Chain	AMAH208710	\$ 60.00	
	692, 693, 694, 892, 893, 894 SN 695301-705100	Roller Chain, Row Unit Drive 86 Links, Size 60 Chain	AMAH145991	\$ 41.00	
	592, 693, 694, 893, 894	Roller Chain, Row Unit Drive 86 Links, Size 60 Chain	AMAH215232	\$ 35.00	
	594 BSN 659999	Roller Chain, Auger Drive 76 Links, Size 50 Chain	AMAN102499	\$ 35.00	
	594, 693, 694, 893, 894 SN 660000-695300	Roller Chain, Row Unit Drive 88 Links, Size 60 Chain	AMAH145984	\$ 41.00	
	594, 693, 694, 893, 894 SN 660000-695300	Roller Chain, Row Unit Drive 83 Links, Size 60 Chain	AMAH145985	\$ 45.00	

Cornhead—Row Unit Components

John Deere®—Combine

Combine—Row Unit Components

Application	Description	Part Number	Retail Price	Core
 1092, 1290, 1291, 1293	Roller Chain, Row Unit Drive 64 Links, Size 80 Chain	AMAH215490	\$ 45.00	
1092, 1290, 1291, 1293 SN 660000-695300	Roller Chain, Row Unit Drive 67 Links, Size 80 Chain	AMAH145986	\$ 60.00	
1092, 1290, 1291, 1293 SN 660000-695300	Roller Chain, Row Unit Drive 63 Links, Size 80 Chain	AMAH145987	\$ 60.00	
1092, 1290, 1291, 1293 SN 695301-705100	Roller Chain, Row Unit Drive 67 Links, Size 80 Chain	AMAH201469	\$ 65.00	
1092, 1290, 1291, 1293 SN 695301-705100	Roller Chain, Row Unit Drive 65 Links, Size 80 Chain	AMAH201470	\$ 60.00	
1290, 1291, 1293 ASN 705100	Roller Chain, Row Unit Drive 64 Links, Size 80 Chain	AMAH209912	\$ 50.00	
1290, 1291, 1293 ASN 705100	Roller Chain, Row Unit Drive 68 Links, Size 80 Chain	AMAH209914	\$ 50.00	
1243 ASN 630751, 1290, 1291, 1293 BSN 659999	Roller Chain, Row Unit Drive 65 Links, Size 80 Chain	AMAH114886	\$ 60.00	
 1243 BSN 630750	Roller Chain, Row Unit Drive 87 Links, Size 60H Chain	AMAH141274	\$ 35.00	
 606, 606C, 608, 608C, 608FC ASN 129189, 612, 612C, 612FC, 616, 616C, 618, 618C, 706C, 708C, 708FC, 712C, 712FC, 716C, 718C	Roller Chain, Auger Drive 74 Links, Size 80 Chain	AMAH222291	\$ 55.00	
 606, 606C, 608, 608C, 608FC ASN 129189, 612, 612C, 612FC, 616, 616C, 618, 618C, 706C, 708C, 708FC, 712C, 712FC, 716C, 718C - w/ StalkMaster™	Roller Chain, Row Unit Drive 66 Links, Size 100 Chain Endless Type Chain w/o Connecting Link	AMAH222151	\$ 90.00	
 606, 606C, 608, 608C, 612, 612C, 706C, 708C, 712C	Roller Chain, Row Unit Drive 82 Links, Size 80 Chain Endless Type Chain w/o Connecting Link	AMAH224034	\$ 60.00	

Belts—3300, 4400

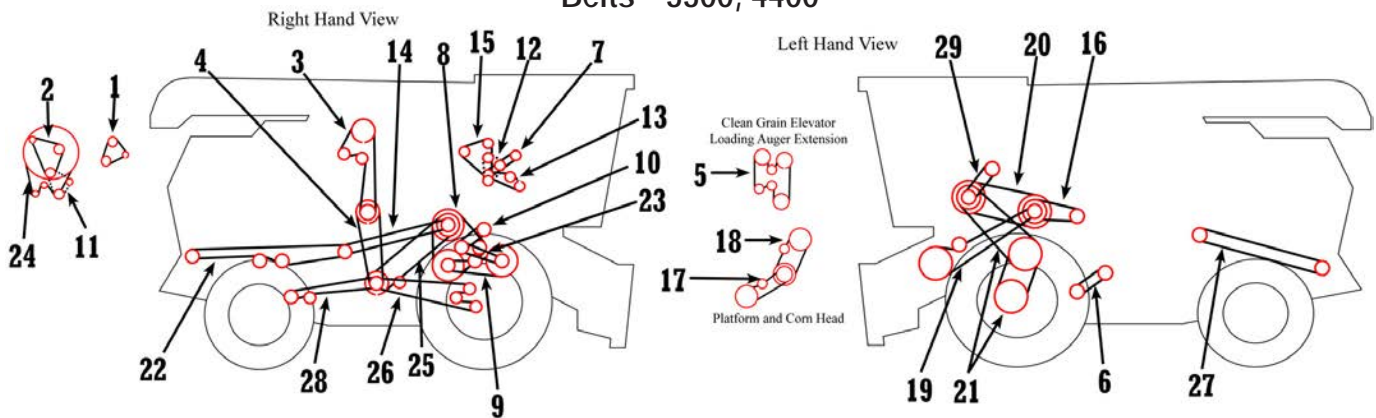

Application	Description	Part Number	Retail Price
1 4400	Alternator & Water Pump - 292 Gas	AMH30634	\$ 9.04
2 3300	Alternator & Water Pump	AMH80897	\$ 12.37
2 4400 BSN 202603	Alternator & Water Pump - 329Dh-02	AMH80896	\$ 8.00
2 4400 ASN 202604	Alternator & Water Pump - 329Dh-02&03	AMH82724	\$ 5.92
3 3300 BSN 101300, 4400 BSN 151200	Clean Grain Elevator, U-Joint Loading Auger	AME60212	\$ 34.00

John Deere®—Combine

Application	Description	Part Number	Retail Price
3 3300 ASN 101300, 4400 ASN 151201	Clean Grain Elevator	AMH87648	\$ 44.00
4 3300, 4400	Clean Grain Elevator Countershaft	AMH23817	\$ 53.00
5 4400	Clean Grain Elevator & Loading Auger Extension	AMH81222	\$ 42.00
6 3300, 4400	Cleaning Fan	AMH80726	\$ 53.00
7 4400 S/N 101301-151500	Compressor, A/C - 329 Diesel	AMH77683	\$ 10.00
7 3300 BSN 100000, 4400 Gas BSN 151500, 4400 Diesel BSN 101300	Compressor, A/C - 292 Gas, 329 Diesel	AMH80896	\$ 8.00
7 3300 BSN 100000	Compressor, A/C	AMH81742	\$ 8.50
7 3300 S/N 100001-101300	Compressor, A/C	AMH63772	\$ 19.53
7 3300 BSN 150001	Compressor, A/C	AMH86273	\$ 7.33
7 4400 ASN 151500	Compressor, A/C - 6329DH-01	AMH86275	\$ 10.00
8 3300, 4400	Cylinder Intermediate Shaft	AMH75816	\$ 82.00
9 3300, 4400	Cylinder Set of 3	AMAH80500	\$ 62.00
10 3300, 4400	Cylinder Tachometer	AMH83078	\$ 6.70
11 3300	Engine Fan and Rotary Screen Drive Shaft	AMH86273	\$ 7.33
11 4400	Engine Fan and Rotary Screen Drive Shaft	AMH86275	\$ 10.00
12 3300 BSN 101300, 4400 BSN 151500	Engine Fan	AMH79236	\$ 9.00
12 3300, 4400 BSN 250500	Engine Fan, Cab w/ AC	AMH86271	\$ 7.29
12 4400 ASN 250501	Engine Fan	AMH94373	\$ 7.00
13 3300 BSN 101300, 4400 BSN 151500	Engine Fan Countershaft	AMH79235	\$ 7.05
14 3300, 4400	Front Straw Chopper	AMH20407	\$ 39.00
15 4400	Governor	AMH82479	\$ 14.40
16 3300, 4400	Hydrostatic Reel Pump	AMH77683	\$ 10.00
17 4400 Long Feederhouse	Platform and Corn Head Set of 3	AMAH76154	\$ 73.00
17 4400	Platform and Corn Head, Lower, Variable	AMAH87197	\$ 37.00
18 4400	Platform and Corn Head, Middle, Variable	AMP46553	\$ 92.00
19 3300, 4400	Platform and Feederhouse, Upper	AMH76028	\$ 82.00
20 3300, 4400	Primary Countershaft Set of 2	AMAH98052	\$ 53.00
21 3300	Propulsion (Requires 2 - Upper and Lower)	AMH75911	\$ 149.66
21 4400	Propulsion (Requires 2 - Upper and Lower)	AMH75847	\$ 105.00
22 3300, 4400	Rear Straw Chopper	AMH79787	\$ 60.00
23 3300 S/N 853-100000, 4400 BSN 101300	Rotary Deflector	AMH86060	\$ 10.70
23 3300 ASN 100001, 4400 ASN 101301	Rotary Deflector	AMH86039	\$ 16.00
24 3300 ASN 100001, 4400	Rotary Screen	AMH86259	\$ 15.00
25 3300, 4400	Secondary Countershaft	AMH138762	\$ 56.00
26 3300, 4400	Shoe Grain Supply Augers	AMH79285	\$ 31.00
27 3300, 4400	Straw Spreader	AMH80159	\$ 26.00
28 3300, 4400	Tailings Lower Auger	AME63031	\$ 33.00
29 3300, 4400	Unloading Auger Countershaft	AMH76136	\$ 20.00

John Deere®—Combine

Belts—4420

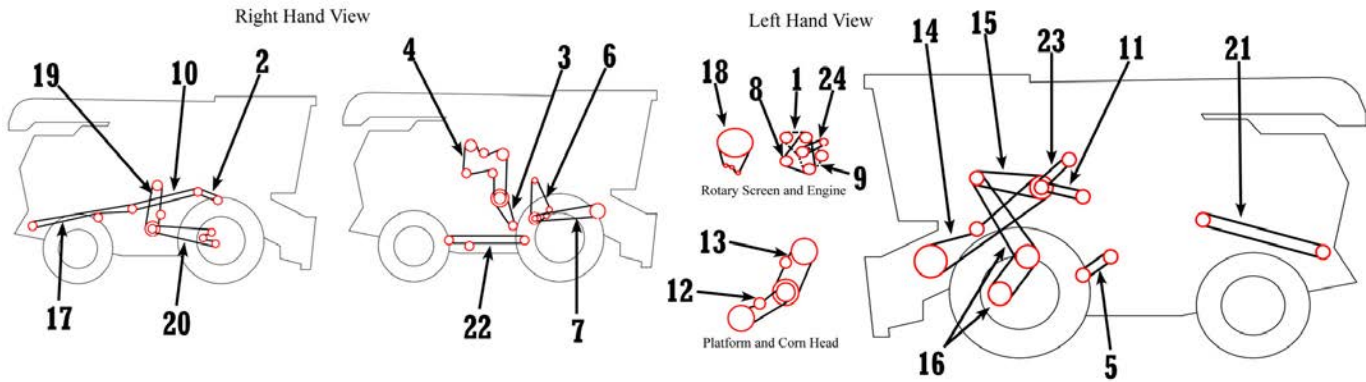

Application	Description	Part Number	Retail Price
1 4420 BSN 550000	Alternator & Water Pump	AMH82724	\$ 5.92
1 4420 ASN 550001	Alternator & Water Pump	AMH101813	\$ 13.00
2 4420	Beater (100% Beater Speed)	AMH86039	\$ 16.00
2 4420	Beater (150% Beater Speed)	AMH101352	\$ 11.23
3 4420	Clean Grain Elevator Countershaft	AMH23817	\$ 53.00
4 4420	Clean Grain Elevator & Loading Auger	AMH81222	\$ 42.00
5 4420	Cleaning Fan	AMH80726	\$ 53.00
6 4420	Cylinder Intermediate Shaft	AMH75816	\$ 82.00
7 4420	Cylinder Set of 3	AMAH80500	\$ 62.00
8 4420	Engine Fan, Cab w/o AC	AMH86271	\$ 7.29
8 4420	Engine Fan, Cab w/ AC	AMH94373	\$ 7.00
9 4420	Engine Fan & Rotary Screen Drive Shaft	AMH86275	\$ 10.00
10 4420	Front Straw Chopper	AMH20407	\$ 39.00
11 4420	Hydrostatic Reel Pump	AMH77683	\$ 10.00
12 4420	Platform Rice, Grain, Long Corn, Variable Set of 3	AMAH76154	\$ 73.00
12 4420	Platform and Corn Head, Lower, Variable	AMAH87197	\$ 37.00
13 4420	Platform and Corn Head, Middle, Variable	AMP46553	\$ 92.00
14 4420	Platform and Feederhouse, Upper	AMH76028	\$ 82.00
15 4420	Primary Countershaft Set of 2	AMAH98052	\$ 53.00
16 4420	Propulsion (Belt Drive)	AMH75847	\$ 105.00
17 4420	Rear Straw Chopper	AMH79787	\$ 60.00
18 4420	Rotary Screen	AMH86259	\$ 15.00
19 4420	Secondary Countershaft	AMH138762	\$ 56.00
20 4420	Shoe Grain Supply Augers	AMH79285	\$ 31.00
21 4420	Straw Spreader	AMH80159	\$ 26.00
22 4420	Tailings Lower Auger	AME63031	\$ 33.00
23 4420	Unloading Auger Countershaft	AMH76136	\$ 20.00
24 4420	AC Compressor	AMH86275	\$ 10.00

John Deere®—Combine

Belts—4425, 4435, 4435 Hydro

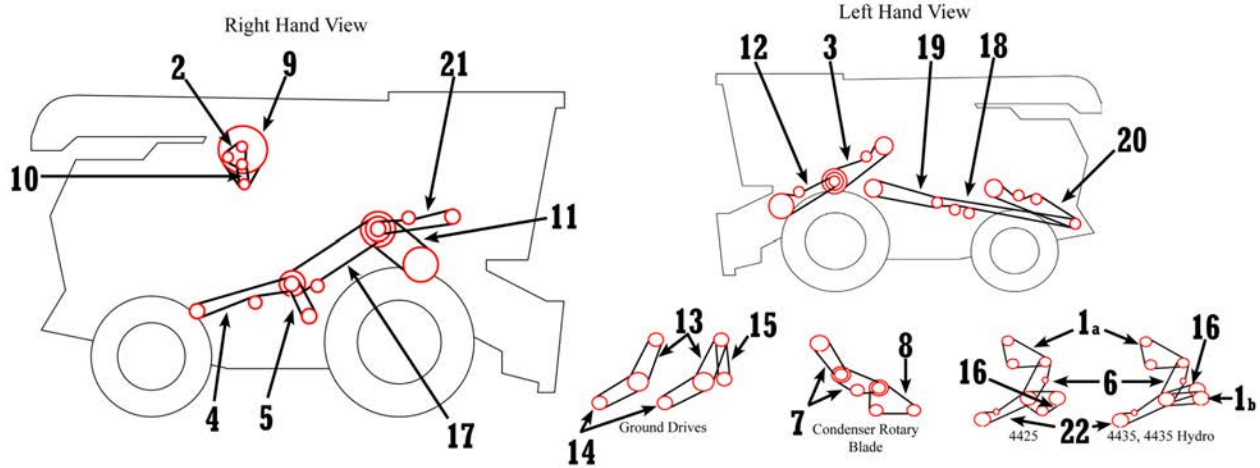

Application	Description	Part Number	Retail Price
1a 4425, 4435 Hydro	A/C Compressor	AMZ42756	\$ 15.00
1b 4435, 4435 Hydro	A/C Compressor	AMZ46759	\$ 12.00
2 4425, 4435, 4435 Hydro	Alternator / Water Pump	AMAR72036	\$ 29.27
3 4425, 4435, 4435 Hydro	Beater	AMZ33790	\$ 207.79
4 4435, 4435 Hydro	Clean Grain Elevator	AMZ47912	\$ 42.00
5 4425	Cleaning Fan	AMZ41178	\$ 26.65
5 4435, 4435 Hydro	Cleaning Fan	AMZ46365	\$ 37.95
6 4425, 4435 Hydro	Condenser Fan	AMZ45482	\$ 17.80
7 4435 Hydro	Condenser Rotary Blade, Upper (2)	AMZ43863	\$ 6.76
8 4435 Hydro	Condenser Rotary Blade, Lower	AMZ38704	\$ 16.44
9 4425, 4435 Hydro	Countershaft to Rotary Screen	AMZ34786	\$ 25.00
9 4435	Countershaft to Rotary Screen	AMZ46764	\$ 20.00
10 4425, 4435, 4435 Hydro	Crankshaft to Countershaft	AMZ32190	\$ 7.29
11 4425, 4435, 4435 Hydro	Cylinder Drive	AMZ65924	\$ 251.99
12 4425, 4435, 4435 Hydro	Feederhouse	AMZ38186	\$ 103.74
13 4425	Ground Drive, Upper	AMA35635	\$ 246.80
13 4435	Ground Drive, Upper	AMAZ37807	\$ 238.27
14 4425, 4435	Ground Drive, Lower	AMZ34099	\$ 263.91
15 4435 Hydro	Hydrostatic Drive	AMZ53290	\$ 213.00
16 4425, 4435, 4435 Hydro	Main Hydro Pump	AMZ34828	\$ 19.00
17 4425	Separator	AMZ34405	\$ 37.00
17 4435, 4435 Hydro	Separator	AMZ46366	\$ 41.71
18 4425	Straw Chopper, Rear	AMZ44930	\$ 216.69
18 4435, 4435 Hydro	Straw Chopper, Rear	AMZ55645	\$ 322.63
19 4425, 4435, 4435 Hydro	Straw Chopper, Front	AMZ44761	\$ 140.29
20 4425	Straw Spreader	AMZ33774	\$ 58.00
20 4435, 4435 Hydro	Straw Spreader	AMZ32041	\$ 50.00
21 4425, 4435, 4435 Hydro	Tailings Elevator	AMZ45026	\$ 22.51
22 4425	Unloading Auger	AMZ47911	\$ 48.89
22 4435, 4435 Hydro	Unloading Auger	AMZ51212	\$ 103.77

John Deere®—Combine

Belts—6600, 7700 – Right Hand View

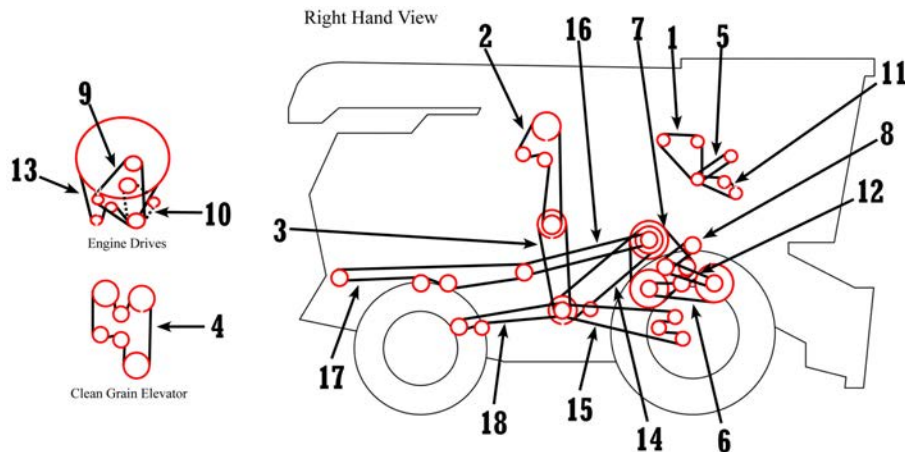

Application	Description	Part Number	Retail Price
1 6600 BSN 105800	Alternator & Water Pump	AMH80897	\$ 12.37
1 6600: 6329DH BSN 208510, 6329GH-02 BSN 156500	Alternator & Water Pump	AMH80896	\$ 8.00
1 6600 ASN 208511, 7700 S/N 2801-8001	Alternator & Water Pump - 6329DH-01	AMH82724	\$ 5.92
1 6600 BSN 605672	Alternator & Water Pump - 6404DH, SH	AMH85377	\$ 8.76
1 6600 ASN 305673, 7700 ASN 163901	Alternator & Water Pump - 6404TH, SH	AMH79236	\$ 9.00
1 7700 BSN 2800	Alternator & Water Pump - Gas Set of 2	AMAR41628	\$ 12.50
1 7700 BSN 2800	Alternator & Water Pump - Diesel Set of 2	AMAR41576	\$ 26.84
1 7700 ASN 8001	Alternator & Water Pump - 404DH-04	AMR52507	\$ 13.00
1 7700 S/N 8001-163900	Alternator & Water Pump - 404TH-01	AMR70871	\$ 8.00
2 6600, 7700	U-Joint Loading Auger	AMH23950	\$ 44.00
3 6600, 7700	Clean Grain Elevator Countershaft	AMH27433	\$ 29.00
4 6600, 7700	Clean Grain Elevator	AMH77766	\$ 44.00
5 6600 BSN 105800, 7700 404TH-01 S/N 8001-163900	Compressor, A/C	AMH80896	\$ 8.00
5 7700 Gas BSN 111900, 404DH-01 BSN 8000	Compressor, A/C	AMH80897	\$ 12.37
5 6600 S/N 105801-156500	Compressor, A/C - 329 Diesel	AMH77683	\$ 10.00
5 6600 ASN 156501	Compressor, A/C - 6329DH-01	AMH86275	\$ 10.00
5 6600 BSN 305672, 7700 BSN 163901 - w/ 6404DH-04	Compressor, A/C - 6404DH & SideHill 39.50" Long	AMH87459	\$ 5.00
5 6600 ASN 310500, 7700 6404TH-01 ASN 163901	Compressor, A/C - 6404TH & SideHill	AMR71603	\$ 6.00
5 7700 S/N 8001-163900	Compressor, A/C - 6404DH-04	AMH81742	\$ 8.50
6 6600 BSN 821, 7700 BSN 8000	Cylinder, 280-845 RPM Set of 3	AMAH80505	\$ 89.00
6 6600, 7700 ASN 8801	Cylinder, 287-873 RPM	AMH96423	\$ 102.00
6 6600 BSN 821, 7700 BSN 8000	Cylinder, 407-828 RPM Set of 3	AMAH80503	\$ 72.00
6 7700 ASN 8001	Cylinder, 414-1250 RPM	AMH96408	\$ 80.00
7 6600 BSN 310500, 7700	Cylinder, Intermediate Shaft	AMH113749	\$ 115.00
7 6600, 7700	Cylinder, Intermediate Shaft, Heavy Duty	AMH161339	\$ 137.00
8 6600, 7700	Cylinder Tachometer	AMH83077	\$ 5.00
9 6600	Engine Fan - 6329GH-02 & 6329DH-01	AMH86272	\$ 7.54
9 6600 BSN 105800, 7700 BSN 8000	Engine Fan - 6404DH-01	AMH86271	\$ 7.29
9 7700 S/N 8001-111900	Engine Fan - 6404DH-04, TH-01	AMH84740	\$ 19.43
10 6600 & SideHill BSN 305672, 7700 6404DH-04	Engine Fan & Rotary Screen Drive Shaft	AMH137207	\$ 12.00

John Deere®—Combine

Application	Description	Part Number	Retail Price
10 6600 & SideHill ASN 305673, 7700 404TH-01	Engine Fan & Rotary Screen Drive Shaft	AMH86273	\$ 7.33
10 6600 w/ 6329GH-02 BSN 156500 or 6329GH-01 Engine	Engine Fan & Rotary Screen Drive Shaft	AMH86274	\$ 13.00
11 6600 w/ 6329GH-02 or 6404DH-01 BSN 105800 Engine, 7700 w/ Gas BSN 111900 or 6404DH-01 BSN 8000 Engine	Engine Fan Countershaft	AMH79235	\$ 7.05
11 6600, 7700 6404DH-04 SN 8001-111900	Engine Fan Countershaft - 6404DH	AMH85377	\$ 8.76
11 7700 S/N 8001-111900	Engine Fan Countershaft - 6404TH-01	AMH84745	\$ 9.30
12 6600 BSN 105800, 7700 SN 1278-111900	Rotary Deflector	AMH86061	\$ 14.00
12 6600 ASN 105801, 7700 ASN 111901	Rotary Deflector	AMH86039	\$ 16.00
13 6600, 7700	Rotary Screen	AMH86259	\$ 15.00
14 6600, 7700	Secondary Countershaft	AMH77019	\$ 69.00
15 6600, 7700	Shoe Grain Supply Augers	AMH77010	\$ 48.00
16 6600, 7700	Straw Chopper	AMH138762	\$ 56.00
17 6600, 7700	Straw Chopper, Rear	AMH79789	\$ 65.00
18 6600 BSN 7500, 7700 BSN 5000	Tailings Lower Auger	AMN110085	\$ 56.00

Belts—6600, 7700 – Left Hand View

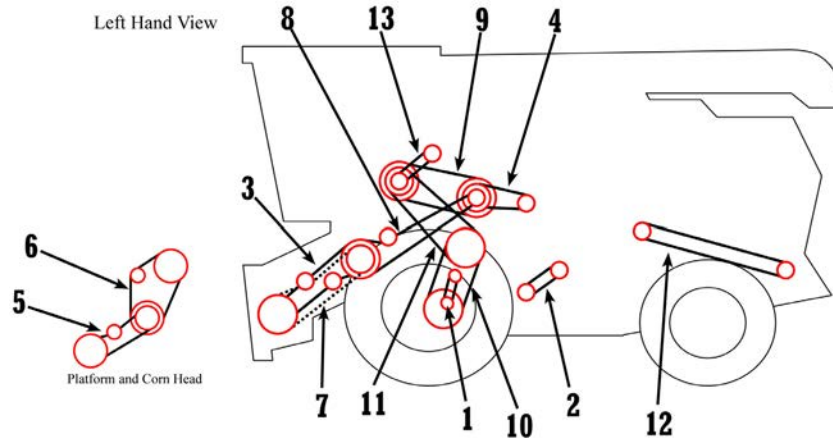

Application	Description	Part Number	Retail Price
1 6600 BSN 9582	Charge Pump, Hydrostatic Drive	AMT12042	\$ 17.00
1 7700 ASN 006208	Charge Pump, Hydrostatic Drive	AMT199T	\$ 9.00
2 6600	Cleaning Fan	AMH108668	\$ 41.00
3 6600 ASN 156501	Feed Conveyor (Regular Feederhouse)	AMH77766	\$ 44.00
3 6600, 7700	Feed Conveyor (Long Feederhouse)	AMH125380	\$ 62.00
4 6600	Hydrostatic Reel Pump	AMH77683	\$ 10.00
5 6600	Platform and Cornhead Set of 3	AMAH76154	\$ 73.00
5 6600 SideHill	Platform and Cornhead, Lower Variable Set of 3	AMAH89436	\$ 92.00
6 6600 BSN 254350	Platform and Cornhead, Middle, Variable	AMP46553	\$ 92.00
6 6600 ASN 254251	Platform and Cornhead, Middle, Variable	AMH84441	\$ 90.00
7 6600	Platform and Feederhouse, Lower, Regular	AMH77765	\$ 90.00
7 7700	Platform and Feederhouse, Lower Long	AMH79796	\$ 97.00
8 6600 Excluding Corn Variable Speed	Platform and Feederhouse, Upper	AMH76030	\$ 66.00
8 6600 ASN 254501	Platform and Feederhouse, Vari-Speed Upper	AMH23927	\$ 61.00
9 7700 BSN 5000	Primary Countershaft Set of 2	AMAH75638	\$ 115.00

John Deere®—Combine

Application	Description	Part Number	Retail Price
9 6600SH BSN 305672, 6600 ASN 11501	Primary Countershaft	AMH84462	\$ 110.00
9 7700 404TH-01 ASN 8001	Primary Countershaft	AMH108175	\$ 112.00
10 6600 ASN 156501	Propulsion Hydrostatic Drive, Lower	AMH88576	\$ 115.00
10 7700	Propulsion Hydrostatic Drive, Lower Set of 2	AMAH84633	\$ 104.00
10 6600, 7700 BSN 115000	Propulsion Belt Drive, Lower	AMH75846	\$ 129.00
10 6600	Propulsion Belt Drive, Lower	AMH75847	\$ 105.00
11 6600 BSN 165600	Propulsion Hydrostatic Drive, Upper	AMH88576	\$ 115.00
11 7700	Propulsion Hydrostatic Drive, Upper Set of 2	AMAH84633	\$ 104.00
11 7700 ASN 111901 404D	Propulsion Posi-Torq™, Upper Set of 2	AMAH21301	\$ 155.00
11 6600 SideHill ASN 305673	Propulsion Posi-Torq™, Upper Set of 2	AMAH87127	\$ 124.00
11 6600	Propulsion Belt Drive, Upper	AMH75847	\$ 105.00
11 7700 BSN 115000	Propulsion Belt Drive, Upper	AMH75846	\$ 129.00
12 7700	Straw Spreader	AMH26858	\$ 27.00
13 6600 SideHill BSN 305672	Unloading Auger Countershaft	AMH76150	\$ 34.00
13 6600 SideHill ASN 605673	Unloading Auger Countershaft	AMH84424	\$ 63.91

Belts—6620, 6622, 7720, 7721

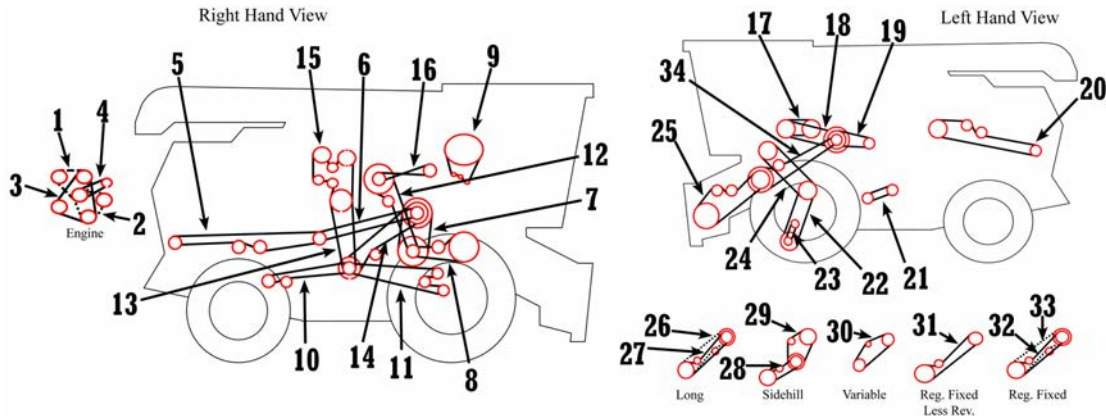

Application	Description	Part Number	Retail Price
1 6620 (6466DH-1 & 6466TH-01), 6622	Alternator & Water Pump	AMH79236	\$ 9.00
1 7720 (6466TH & 6466TH-02)	Alternator & Water Pump	AMH79236	\$ 9.00
2 6620, 6622, 7720	Rotary Screen Drive Shaft	AMH86273	\$ 7.33
3 6620, 6622	Engine Fan	AMH86272	\$ 7.54
3 7720	Engine Fan	AMH86271	\$ 7.29
4 6620 ASN 600001, 7720 ASN 600001	Compressor, A/C	AMH113565	\$ 8.00
4 6620 BSN 615401, 6622, 7720 BSN 615401	Compressor, A/C	AMR71603	\$ 6.00
5 6620, 6622, 7720, 7721	Rear Straw Chopper Drive	AMH103344	\$ 77.00
6 6620, 6622, 7720, 7721	Straw Chopper Drive	AMH101436	\$ 43.00
7 6620, 6622, 7720, 7721	Countershaft Drive, Torq-Sensing	AMH113749	\$ 115.00
7 6620	Countershaft Drive, Heavy Duty	AMH161339	\$ 137.00
8 6620 ASN 551901, 6622 ASN 556001, 7720 ASN 556301, 7721 ASN 562901	Cylinder, 4-Band (Std) 350-700 & 620-1240 RPM	AMH110375	\$ 125.00
8 6620 BSN 551901, 7720 BSN 556301	Cylinder, 3-Band 390-1030 or 450-1200 RPM	AMH96408	\$ 80.00

John Deere®—Combine

	Application	Description	Part Number	Retail Price
8	6620 ASN 551901, 6622, 7720 ASN 556301, 7721 ASN 562901	Cylinder, 4-Band (Opt) 380-560 & 500-1000 RPM	AMH96422	\$ 123.00
8	7721 BSN 562901	Cylinder, 4-Band 390-1030 or 450-1200 RPM	AMH96422	\$ 123.00
8	6620 BSN 551901, 6622, 7720 BSN 8001	Cylinder, 3-Band 315-830 RPM	AMH96423	\$ 102.00
8	7721 BSN 562901	Cylinder 160-320 & 285-570 RPM	AMH96421	\$ 120.00
9	6620, 7720	Rotary Screen	AMH86259	\$ 15.00
10	6620, 6622, 7720, 7721	Tailings Auger Drive	AMH118730	\$ 43.00
11	6620, 6622, 7720, 7721	Shoe Supply Auger Drive	AMH77010	\$ 48.00
12	6620, 6622, 7720, 7721	Beater (150% Speed), Grain & Rice	AMH101469	\$ 19.00
12	6620, 7720, 7721	Beater (100% Speed), Beans & Corn	AMH96414	\$ 22.00
13	6620, 6622, 7720, 7721	Clean Grain Elevator Countershaft	AMH27433	\$ 29.00
14	6620 BSN 551901, 6622 BSN 556001, 7720 BSN 556301	Secondary Countershaft Drive	AMH81222	\$ 42.00
14	6620 ASN 551901, 6622 BSN 556001, 7720 ASN 556301	Secondary Countershaft Drive	AMH110300	\$ 45.00
15	6620, 6622 ASN 610401, 7720, 7721	Clean Grain Elevator, Loading Auger	AMH77766	\$ 44.00
15	7721	Hydraulic Reel Pump Drive	AMH23950	\$ 44.00
16	6620, 6622, 7720	Cylinder Tachometer O-Ring	AMH83077	\$ 5.00
17	6620, 6622, 7720	Unloading Auger Drive Set of 2	AMAH96300	\$ 43.00
18	6620, 6622, 7720	Separator Drive	AMH108175	\$ 112.00
19	6620 BSN 625101, 6622, 7720 BSN 625201	Hydraulic Reel Pump Drive	AMH86275	\$ 10.00
19	6620 ASN 625101, 7720 ASN 625201	Hydraulic Reel Pump Drive	AMH137207	\$ 12.00
19	7721	Hydraulic Reel Pump Drive	AMH86274	\$ 13.00
20	6620, 6622, 7720, 7721	Straw Spreader Drive	AMH112421	\$ 31.00
21	6620, 6622	Cleaning Fan Drive	AMH108668	\$ 41.00
21	7720, 7721	Cleaning Fan Drive	AMH108669	\$ 50.00
22	6620, 7720	Hydro, Lower Ground Drive Set of 2	AMAH84633	\$ 104.00
22	6620, 7720	Posi-Torq™, Lower Ground Drive	AMH75846	\$ 129.00
23	6620 BSN 610301, 7720 BSN 556301	Hydro Charge Pump	AMT199T	\$ 9.00
23	6620 ASN 610301, 7720 ASN 556301	Hydro Charge Pump	AMT32517	\$ 10.00
23	6622	Hydro Charge Pump	AMH86273	\$ 7.33
24	6620, 7720	Hydro, Upper Ground Drive Set of 2	AMAH84633	\$ 104.00
24	6622	Hydro, Ground Drive Set of 3	AMAH79627	\$ 256.51
24	6620, 7720	Posi-Torq™, Upper Ground Drive Set of 2	AMAH87127	\$ 124.00
25	6620 S/N 502551-615100, 7720 ASN 507351	Feederhouse Drive, Regular Lower	AMH111519	\$ 84.00
25	6620 ASN 403301, 7720 ASN 409101	Feederhouse Drive, Long Lower	AMH97929	\$ 95.00
26	6620 BSN 403301, 7720 BSN 409101	Feederhouse Conveyor Drive, Long	AMH125380	\$ 62.00
27	6620 BSN 403301, 7720 BSN 409101	Feederhouse Conveyor Drive, Long Lower	AMH79796	\$ 97.00
28	6620 BSN 610301	Platform and Cornhead, Lower, Variable Set of 3	AMAH89436	\$ 92.00
29	6620 BSN 610301	Feederhouse Drive, Upper, SideHill Only	AMH84441	\$ 90.00
30	6620, 7720	Feederhouse, Variable Conveyor Drive	AMH110921	\$ 125.00
30	6620 SideHill ASN 610301	Feederhouse, Lower, Fixed Less Reverser	AMH116422	\$ 185.00
31	6620 ASN 615101, 7720 ASN 615201	Feederhouse Drive, Lower, Fixed Less Reverser	AMZ30130	\$ 100.00
31	6620 BSN 502551, 7720 BSN 507351, 7721	Feederhouse Drive, Lower, Reg Fixed	AMZ30130	\$ 100.00
32	6622 BSN 507051	Feederhouse Drive, Lower	AMH33885	\$ 134.00

Prices Subject to Change without Prior Notice. The use of original equipment manufacturer (OEM) part numbers or trademarks, e.g. Case® and John Deere®, are for reference purposes only and for indicating product use and compatibility. Our company and the listed replacement parts contained herein are not sponsored, approved or manufactured by the OEM. All parts are New unless designated Reman in the description.

John Deere®—Combine

Application	Description	Part Number	Retail Price
32 6622 ASN 507051	Feederhouse Drive, Lower	AMH77765	\$ 90.00
33 6620 BSN 502551, 7720 BSN 507351, 7721	Feederhouse Conveyor Drive, Reg Fixed	AMH77766	\$ 44.00
33 6622 BSN 507051	Feederhouse Conveyor Drive	AMH81222	\$ 42.00
34 6620 SideHill BSN 610301, 6622	Feederhouse Drive	AMH23927	\$ 61.00
34 6620 BSN 403301, 6622 BSN 507051, 7720 BSN 4091001, 7721	Feederhouse Drive	AMH76030	\$ 66.00
34 6620 BSN 502551, 7720 BSN 507351	Feederhouse Drive, Reg Fixed	AMH76030	\$ 66.00
34 6620, 7720	Feederhouse Drive Unloading Auger, Long Reg	AMH23927	\$ 61.00
34 6620 ASN 615101, 7720 ASN 615201	Feederhouse Drive, Less Reverser	AMH76030	\$ 66.00
NI 6620, 7720	Dip and Pour Elevator Drive, Upper Countershaft	AMP49415	\$ 46.61
NI 6620, 7720	Dip and Pour Elevator, Lower Countershaft	AME60212	\$ 34.00
NI 6622	Sickle Drive	AMH81524	\$ 54.00
NI 7721	Primary Countershaft	AMH94508	\$ 305.00

Belts—7722, 8820

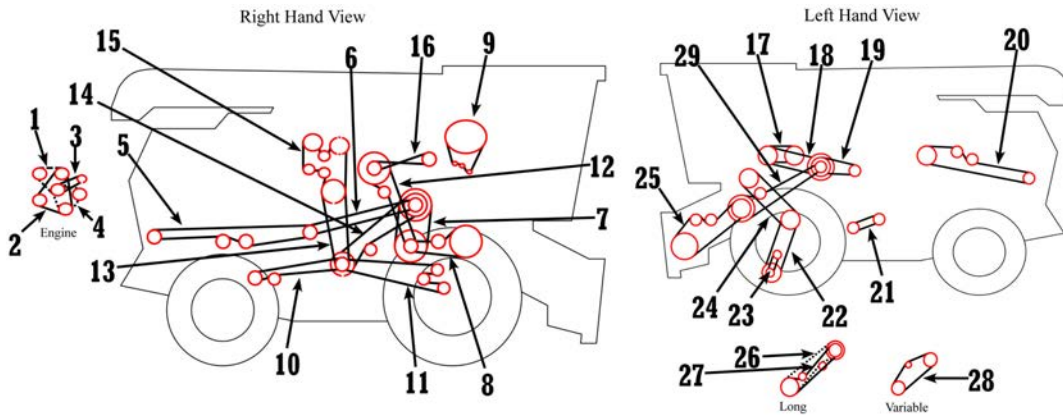

Application	Description	Part Number	Retail Price
1 8820 BSN 464351	Alternator & Water Pump	AMH79236	\$ 9.00
1 7722, 8820 SN 464351-620400	Alternator & Water Pump	AMH86271	\$ 7.29
2 7722, 8820	Rotary Screen	AMH86273	\$ 7.33
3 7722, 8820 ASN 615401	Compressor, A/C	AMH122189	\$ 10.52
3 8820 BSN 615401	Compressor	AMR71603	\$ 6.00
4 7722, 8820	Fan & Hydraulic Pump Set of 2	AMAH96333	\$ 37.00
5 8820	Rear Straw Chopper Drive	AMH103344	\$ 77.00
6 8820	Straw Chopper Drive	AMH101436	\$ 43.00
7 8820	Torq-Sensing Countershaft Drive	AMH113749	\$ 115.00
7 8820	Heavy Duty Countershaft Drive	AMH161339	\$ 137.00
8 8820 BSN 564101	Cylinder (4V) 315-830 RPM	AMH96421	\$ 120.00
8 8820 ASN 564101	Cyl. (4V)(Std) 350-700 & 620-1240 RPM	AMH110375	\$ 125.00
8 8820	Cyl. (4V) 390-1030 & 450-1200 RPM	AMH96422	\$ 123.00
8 8820 ASN 564101	Cylinder, 4-Bnd (Opt) 280-560 & 500-1000 RPM	AMH96422	\$ 123.00
9 8820	Rotary Screen	AMH86259	\$ 15.00
10 8820	Tailings Auger Drive	AMH118730	\$ 43.00
11 8820	Shoe Supply Augers	AMH77010	\$ 48.00
12 8820	Beater (150% Speed), Grain & Rice	AMH101469	\$ 19.00

John Deere®—Combine

Application	Description	Part Number	Retail Price
12 8820	Beater (100% Speed), Beans & Corn	AMH96414	\$ 22.00
13 8820	Clean Grain Elevator	AMH27433	\$ 29.00
14 8820 BSN 556101	Secondary Countershaft Drive	AMH81222	\$ 42.00
14 8820 ASN 556101	Secondary Countershaft Drive	AMH110300	\$ 45.00
15 8820	Clean Grain & Loading Auger	AMH77766	\$ 44.00
16 8820	Cylinder, Tachometer O-Ring	AMH83077	\$ 5.00
17 8820	Unloading Auger Drive Set of 2	AMAH96300	\$ 43.00
18 8820	Separator Drive (3V)	AMH108175	\$ 112.00
19 8820 BSN 625401	Hydraulic Reel Pump Drive	AMH86275	\$ 10.00
19 8820 ASN 625401	Hydraulic Reel Pump Drive	AMH137207	\$ 12.00
20 8820	Straw Spreader Drive	AMH112421	\$ 31.00
21 8820	Cleaning Fan Drive	AMH108669	\$ 50.00
22 7722	Hydro Ground Drive, Lower	AMHAN1220	Call for Price
22 8820	Hydro Ground Drive, Lower Set of 2	AMAH84633	\$ 104.00
23 7722, 8820	Hydro Charge Pump	AMT32517	\$ 10.00
24 7722, 8820	Hydro Ground Drive, Upper Set of 2	AMAH84633	\$ 104.00
25 7722	Feederhouse Drive, Lower	AMH111519	\$ 84.00
25 8820	Feederhouse Drive, Lower, Reg Fixed w/o Reverser	AMH79796	\$ 97.00
25 8820 ASN 414851	Lower Feederhouse Drive, Long	AMH97929	\$ 95.00
26 8820 BSN 409101	Feederhouse Conveyor, Long	AMH125380	\$ 62.00
27 8820 BSN 409101	Lower Feederhouse Conveyor Drive, Long	AMH79796	\$ 97.00
28 8820	Feederhouse, Variable Conveyor Drive	AMH110921	\$ 125.00
29 7722, 8820	Feederhouse Drive w/ Rev & Vari-Drive	AMH23927	\$ 61.00
29 8820 BSN 409101	Feederhouse Drive, Upper, Long	AMH76030	\$ 66.00
29 8820 BSN 414851	Feederhouse Drive, Less Reverser	AMH76030	\$ 66.00
NI 7722 Hillside	Cutterbar Drive	AMH136881	\$ 51.00

John Deere®—Combine

Belts—9400, 9500, 9500SH, 9501, 9600

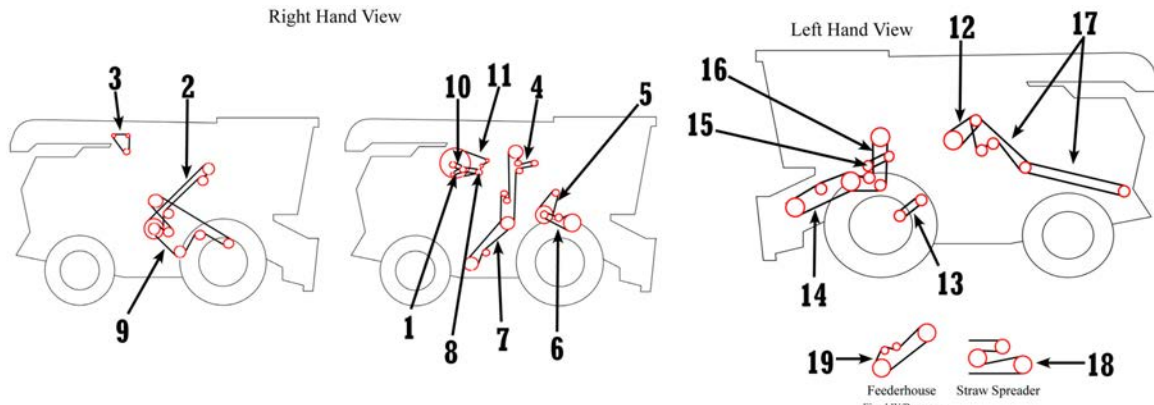

Application	Description	Part Number	Retail Price
1 9400 SN 630201-635100	Air Conditioning Compressor	AMH134772	\$ 11.25
1 9400 SN 635101-636600	Air Conditioning Compressor	AMH101813	\$ 13.00
1 9500 SN 630301-631100, 9600 BSN 631201	Air Conditioning Compressor	AMH134437	\$ 13.00
1 9500-9500SH SN 635201-648500, 9600 SN 631201-647500	Air Conditioning Compressor	AMH81742	\$ 8.50
1 9400 ASN 650101, 9500-9500SH ASN 650201, 9600 ASN 647501	Air Conditioning Compressor	AMH80896	\$ 8.00
2 9400, 9500, 9500SH, 9600	Secondary Countershaft	AMH128010	\$ 63.00
3 9400 BSN 635101, 9600 BSN 631201	Alternator	AMRE44538	\$ 17.00
3 9400 ASN 635101, (9500, 9500SH ASN 635201), 9600 ASN 631201	Alternator	AMH101813	\$ 13.00
3 9500, 9500SH	Alternator, Low Power	AMH134344	\$ 12.00
3 9500-9500SH SN 635201-645200	Alternator	AMR73189	\$ 6.00
4 9400 BSN 640101, 9500-9500SH BSN 640200, 9501	Clean Grain Elevator	AMH137830	\$ 111.00
4 9400 ASN 640101, 9500-9500SH ASN 640201	Clean Grain Elevator	AMH141167	\$ 122.00
4 9600 BSN 640301	Clean Grain Elevator	AMH135458	\$ 118.00
4 9600 ASN 640301	Clean Grain Elevator	AMH141166	\$ 128.00
5 9400, 9500, 9500SH, 9501, 9600	Cylinder, Intermediate Drive	AMH210476	\$ 265.00
5 9400	Cylinder, Intermediate Drive, Ext Range	AMH137670	\$ 250.00
6 9400, 9500, 9500SH, 9501, 9600	Cylinder Drive, Reg Dual & Single Range	AMH115881	\$ 165.00
6 9400	Cylinder Drive, Extended Range	AMH145994	\$ 139.00
6 9400, 9500, 9500SH, 9600	Cylinder Drive, Slow Speed	AMH118618	\$ 153.00
7 9400, 9500, 9500SH, 9501, 9600	Tailings Auger & Elevator, Lower	AMN110085	\$ 56.00
8 9400 BSN 640506, 9500-9500SH BSN 642579	Rotary Screen Drive	AMH134216	\$ 21.00
8 9600 BSN 641922	Rotary Screen Drive, Round Belt	AMH133577	\$ 22.50
8 9600 BSN 641922	Rotary Screen Drive	AMH146636	\$ 10.00
9 9400, 9500, 9500SH, 9501, 9600	Shoe, Straw Walker and Conveyor Augers	AMH131169	\$ 112.00
10 9500, 9600 BSN 641717	Cooling Fan, Lower Power	AMH132808	\$ 15.00
10 9400	Cooling Fan	AMH132809	\$ 12.50
10 9500, 9500SH, 9600 ASN 641717	Cooling Fan, High Power	AMH153297	\$ 51.00
11 9400 BSN 640506, 9500-9500SH ASN 642579, 9600 BSN 641716	Rotary Screen	AMH143869	\$ 55.00
11 9400 ASN 640506, 9500-9500SH ASN 642579, 9600 ASN 641717	Rotary Screen	AMH145158	\$ 40.00
12 9400, 9500, 9500SH, 9501, 9600	Unloading System Set of 2	AMAH158880	\$ 58.00

John Deere®—Combine

	Application	Description	Part Number	Retail Price
13	9400 BSN 670101, 9500-9500SH BSN 670201, 9501, 9600 BSN 670301	Separator Fan, 490-980 RPM Slow Speed	AMH137264	\$ 67.00
13	9400 ASN 670101, 9500-9500SH ASN 670201, 9600 ASN 670301	Fan Drive, 490-980 RPM, Slow Speed	AMH152180	\$ 72.00
13	9400 BSN 670101, 9500-9500SH BSN 670201, 9501, 9600 BSN 670301	Separator Fan, Regular Speed	AMH140404	\$ 68.00
13	9400 ASN 670101, 9500-9500SH ASN 670201, 9600 ASN 670301	Fan Drive, 750-1350 RPM, Regular Speed	AMH152146	\$ 77.00
14	9400, 9500SH, 9501, 9600	Feederhouse, Variable Speed	AMH161648	\$ 173.00
15	9400, 9500SH, 9500, 9600	Beater Drive (75% Beater Speed) Set of 2	AMAH163931	\$ 75.00
15	9400, 9500, 9500SH, 9501, 9600	Beater Drive (100% Beater Speed) Set of 2	AMAH139436	\$ 62.00
16	9400 BSN 635101, 9500-9500SH BSN 635201, 9600 BSN 635301	Header and Reel Pump, Powershift	AMH125565	\$ 101.00
16	9400 ASN 635101, 9500-9500SH ASN 635201, 9501, 9600 ASN 635301	Header and Reel Pump, Powershift	AMH151952	\$ 104.00
17	9400, 9500, 9500SH, 9501, 9600	Front Chopper Drive	AMH125380	\$ 62.00
17	9400 BSN 640101	Chopper in Windrow or Forward Position	AME46113	\$ 32.00
17	9400 ASN 640101	Chopper in Windrow or Forward Position	AMH27433	\$ 29.00
17	9500-9500SH BSN 640201, 9501	Chopper in Windrow or Forward Position	AMP47885	\$ 38.00
17	9500-9500SH ASN 640201, 9600	Chopper in Windrow or Forward Position	AMH23950	\$ 44.00
17	9400	Chopper in Rear Operating Position	AMH101436	\$ 43.00
17	9500, 9500SH, 9501, 9600	Chopper in Rear Operating Position	AMH125381	\$ 58.00
17	9600	Chopper in Rear Operating Position, Fine Cut 2V Belt	AMH175434	\$ 148.00
18	9400	Straw Spreader	AMZ33774	\$ 58.00
18	9500, 9500SH, 9501, 9600	Straw Spreader	AMH128234	\$ 47.00
19	9400, 9500, 9500SH, 9501, 9600	New Feederhouse, w/ Reverser Fixed	AMH126345	\$ 115.00

John Deere®—Combine

Belts—9410, 9510, 9510SH, 9610

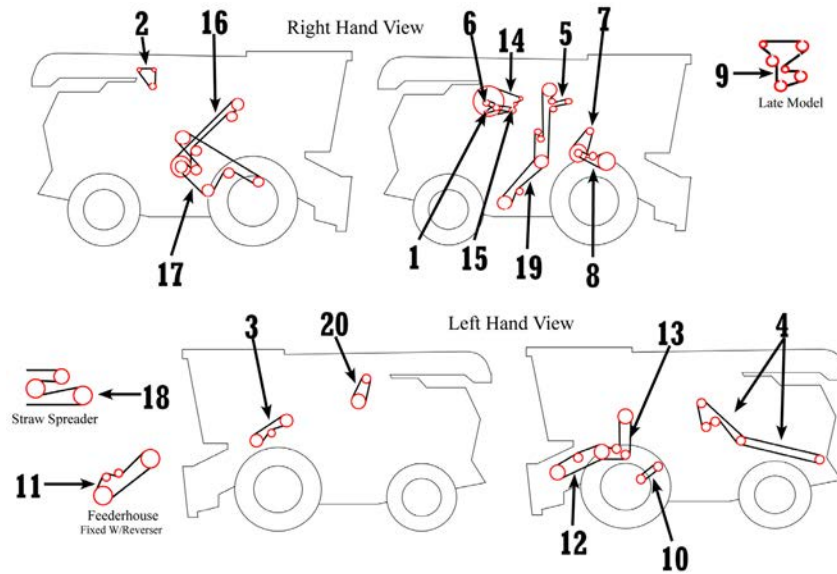

Application	Description	Part Number	Retail Price
1 9410, 9510, 9510SH	A/C Compressor	AMH80896	\$ 8.00
1 9610	A/C Compressor	AMH163515	\$ 49.00
2 9410, 9510, 9510SH	Alternator	AMH101813	\$ 13.00
2 9610	Alternator	AMH163515	\$ 49.00
3 9410, 9510, 9510SH, 9610	Beater Drive (75% Beater Speed) Set of 2	AMAH163931	\$ 75.00
3 9410, 9510, 9510SH, 9610	Beater Drive (100% Beater Speed) Set of 2	AMAH139436	\$ 62.00
4 9410, 9510, 9510SH, 9610	Chopper, Front	AMH125380	\$ 62.00
4 9610	Chopper, Front - Fine Cut	AMH22529	\$ 29.98
4 9410	Chopper, Windrow or Forward Position	AMH27433	\$ 29.00
4 9510, 9510SH, 9610	Chopper, Windrow or Forward Position	AMH23950	\$ 44.00
4 9410	Chopper, Rear Operating Position	AMH101436	\$ 43.00
4 9410, 9510, 9610	Chopper, Rear Operating Position - Fine Cut 2V Belt	AMH175434	\$ 148.00
4 9510, 9510SH, 9610	Chopper, Rear Operating Position	AMH125381	\$ 58.00
4 9610	Front Chopper Drive, Fine Cut	AMH157726	\$ 117.00
5 9610	Clean Grain Elevator	AMH141167	\$ 122.00
5 9410, 9410, 9510SH	Clean Grain Elevator	AMH160171	\$ 145.00
5 9610	Clean Grain Elevator	AMH135458	\$ 118.00
5 9610	Clean Grain Elevator	AMH141166	\$ 128.00
6 9410	Cooling Fan, High Power	AMH132808	\$ 15.00
6 9510, 9510SH	Cooling Fan, High Power	AMH160405	\$ 44.01
6 9410	Cooling Fan, Low Power	AMH132809	\$ 12.50
6 9510, 9510SH	Cooling Fan, Low Power	AMH161795	\$ 23.87
6 9510, 9510SH	Cooling Fan, Low Power	AMH132808	\$ 15.00
6 9610	Cooling Fan, High Power	AMH153297	\$ 51.00
7 9410	Cylinder, Intermediate Drive, Ext Range	AMH137670	\$ 250.00
7 9410, 9510, 9510SH, 9610	Cylinder, Intermediate Drive	AMH210476	\$ 265.00
8 9410	Cylinder Drive, Extended Range	AMH145994	\$ 139.00
8 9410, 9510, 9510SH, 9610	Cylinder Drive, Reg Dual & Single Range	AMH115881	\$ 165.00

John Deere®—Combine

Application	Description	Part Number	Retail Price
8 9410, 9510, 9510SH, 9610	Cylinder Drive, Slow Speed	AMH118618	\$ 153.00
9 9610	Alternator	AMH163515	\$ 49.00
10 9410, 9510, 9510SH, 9610	Fan Drive, 490-980 RPM, Slow Speed	AMH152180	\$ 72.00
10 9410, 9510, 9510SH, 9610	Fan Drive, 750-1350 RPM, Regular Speed	AMH152146	\$ 77.00
11 9410, 9510, 9510SH, 9610	Feederhouse, Fixed Speed w/ Reverser	AMH126345	\$ 115.00
12 9410, 9510, 9510SH, 9610	Feederhouse, Variable Speed	AMH161648	\$ 173.00
13 9410, 9510, 9510SH, 9610	Header and Reel Pump, Powershift	AMH151952	\$ 104.00
14 9410, 9510, 9510SH, 9610	Rotary Screen	AMH145158	\$ 40.00
15 9410, 9510, 9510SH, 9610	Rotary Screen Drive	AMH146636	\$ 10.00
16 9410, 9510, 9510SH, 9610	Secondary Countershaft	AMH128010	\$ 63.00
17 9410, 9510, 9510SH, 9610	Shoe, Straw Walker and Conveyor Augers	AMH131169	\$ 112.00
18 9410	Straw Spreader	AMZ33774	\$ 58.00
18 9510, 9510SH, 9610	Straw Spreader	AMH128234	\$ 47.00
18 9510, 9510SH	Straw Spreader, Deck Drive	AMM95728	\$ 45.02
19 9410, 9510, 9510SH, 9610	Tailings Auger and Elevator, Lower	AMN110085	\$ 56.00
20 9410, 9510SH, 9610	Unloading System Set of 2	AMAH158880	\$ 58.00
NI 9410, 9510, 9510SH, 9610	Air Flow Drive	AMH164452	\$ 14.00

Belts—9450, 9550, 9550SH, 9560, 9560SH, 9650, 9660

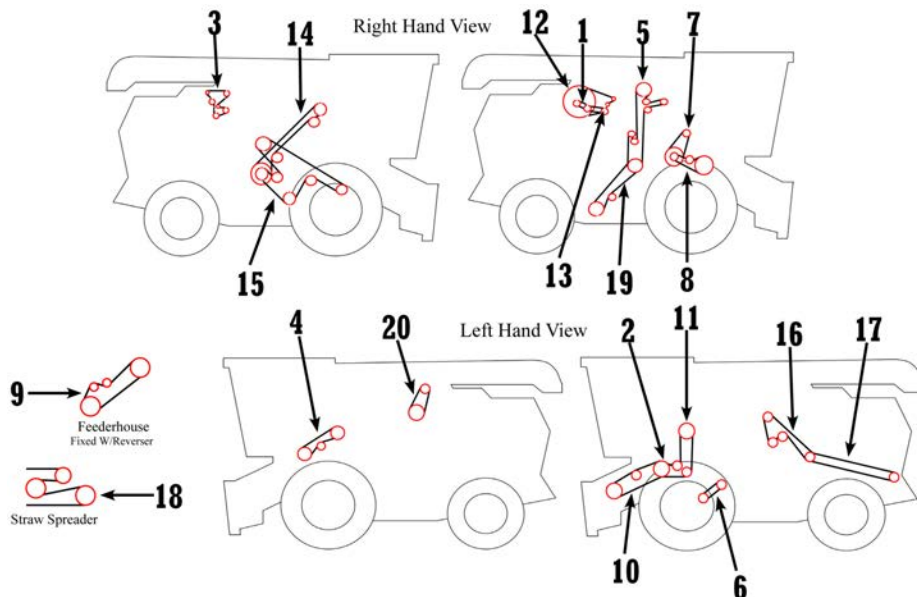

Application	Description	Part Number	Retail Price
1 9450	Air Conditioning Compressor	AMH101813	\$ 13.00
1 9450	Cooling Fan	AMH132808	\$ 15.00
1 9450, 9550SH	Cooling Fan	AMH160405	\$ 44.01
1 9650	Cooling Fan	AMH175467	\$ 26.40
1 9650 BSN 695300	Cooling Fan	AMH153297	\$ 51.00
1 9650 ASN 695301, 9660	Cooling Fan	AMH177186	\$ 40.34
2 9450, 9550, 9560, 9650, 9660	Air Flow Drive	AMH171386	\$ 25.14
3 9450	Alternator - 95 AMP	AMR502418	\$ 48.31
3 9550SH, 9650, 9660	Alternator - 95 AMP	AMH163515	\$ 49.00

Prices Subject to Change without Prior Notice. The use of original equipment manufacturer (OEM) part numbers or trademarks, e.g. Case® and John Deere®, are for reference purposes only and for indicating product use and compatibility. Our company and the listed replacement parts contained herein are not sponsored, approved or manufactured by the OEM. All parts are New unless designated Reman in the description.

John Deere®—Combine

Application	Description	Part Number	Retail Price
3 9560SH	Alternator - 95 AMP	AMR500380	\$ 51.11
3 9450	Alternator - 185 AMP	AMR502417	\$ 46.98
3 9550SH, 9650 BSN 695300	Alternator - 185 AMP	AMH166870	\$ 50.58
3 9560SH	Alternator - 185 AMP	AMH205240	\$ 49.68
3 9650 ASN 695301, 9660	Alternator - 185 AMP	AMR164820	\$ 26.93
4 9560SH, 9660	Beater Drive (75% Beater Speed) Set of 2	AMAH163931	\$ 75.00
4 9450, 9550SH, 9560SH, 9650, 9660	Beater Drive (100% Beater Speed) Set of 2	AMAH139436	\$ 62.00
5 9450, 9550SH, 9560SH, 9650, 9660	Clean Grain Elevator	AMH141166	\$ 128.00
6 9450, 9550SH, 9560SH, 9650, 9660	Fan Drive, 490-980 RPM	AMH152180	\$ 72.00
6 9450, 9550SH, 9560SH, 9650, 9660	Fan Drive, 750-1350 RPM	AMH152146	\$ 77.00
7 9450 (150-980 RPM), 9550SH, 9560SH, 9650, 9660	Cylinder, Intermediate Drive	AMH210476	\$ 265.00
7 9450 (300-1000 RPM)	Cylinder, Intermediate Drive	AMH137670	\$ 250.00
8 9450, 9550SH, 9560SH, 9650, 9660	Cylinder Drive, 240-960 RPM	AMH115881	\$ 165.00
8 9550, 9550SH, 9560, 9560SH, 9650, 9660	Cylinder Drive, 150-500 RPM	AMH118618	\$ 153.00
9 9450, 9550 SN 700200, 9550SH BSN 700700, 9650	Feederhouse w/ Reverser, Fixed Speed	AMH126345	\$ 115.00
9 9550 BSN 700200, 9550SH BSN 700700, 9650	Feederhouse w/ Reverser, Fixed Speed	AMH156796	\$ 143.00
9 9660	Feederhouse w/ Reverser, Fixed Speed	AMH203473	\$ 109.28
9 (9560, 9560SH ASN 710311), 9660	Feederhouse, Fixed Speed	AMH174885	\$ 250.00
10 9450, 9550 BSN 700200, 9550SH BSN 700700, 9650	Feederhouse, Variable Speed	AMH161648	\$ 173.00
10 9550 BSN 700200, 9550SH BSN 700700, 9650	Feederhouse, Variable Speed - Standard Capacity	AMH205167	\$ 215.00
10 9560SH, 9660	Feederhouse, Variable Speed - Standard Capacity	AMH203393	\$ 215.00
10 9550, 9560, 9650, 9660	Feederhouse, Variable Speed - High Capacity	AMH218728	\$ 239.00
11 9450, 9550SH, 9560SH, 9650, 9660	Header and Reel Pump - Standard Capacity	AMH151952	\$ 104.00
11 9550, 9560, 9650, 9660	Header and Reel Pump - High Capacity	AMH155998	\$ 142.00
12 9450, 9550SH, 9650	Rotary Screen	AMH145158	\$ 40.00
12 9560SH, 9660	Rotary Screen	AMH175632	\$ 20.87
13 9450, 9650, 9660	Rotary Screen Drive	AMH146636	\$ 10.00
13 9550SH	Rotary Screen Drive	AMH160406	\$ 9.60
13 9560SH	Rotary Screen Drive	AMH177589	\$ 11.02
14 9450, 9550SH, 9560SH, 9650, 9660	Secondary Countershaft	AMH128010	\$ 63.00
15 9450, 9550SH, 9560SH, 9650, 9660	Shoe, Straw Walker and Conveyor Augers	AMH131169	\$ 112.00
16 9450, 9550SH, 9560SH, 9650, 9660	Straw Chopper, Front	AMH157726	\$ 117.00
17 9450	Straw Chopper, Long Rear	AMH101436	\$ 43.00
17 9450	Straw Chopper, Short Rear	AMH27433	\$ 29.00
17 9550SH, 9560SH, 9650, 9660	Straw Chopper, Rear Operating Position, Fine Cut 2V Belt	AMH175434	\$ 148.00
17 9550SH, 9560SH, 9650, 9660	Straw Chopper, Standard	AMH160654	\$ 64.00
17 9550SH, 9560SH, 9650, 9660	Straw Chopper, Standard Baling	AMH23950	\$ 44.00
17 9560SH, 9650, 9660 (Fine Cut Baling)	Straw Chopper, Windrow	AMH22529	\$ 29.98
18 9450	Straw Spreader	AMZ33774	\$ 58.00
18 9550SH, 9560SH, 9650, 9660	Straw Spreader	AMH128234	\$ 47.00
19 9450, 9550SH, 9560SH, 9650, 9660	Tailings Auger & Elevator, Lower	AMN110085	\$ 56.00
20 9450, 9550SH, 9560SH, 9650, 9660	Unloading System Set of 2	AMAH158880	\$ 58.00

John Deere®—Combine

Belts—9560, 9570, 9650, 9660, 9670, 9750, 9760, 9770, 9860, 9870 – STS

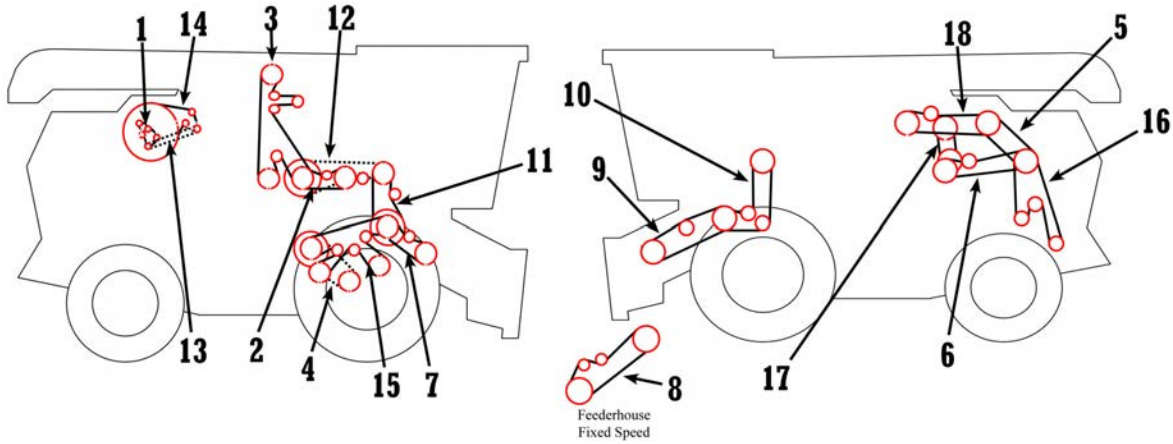

Application	Description	Part Number	Retail Price
1 9560, 9650, 9660, 9750, 9760	Alternator - 95 AMP	AMR135606	\$ 39.00
1 9560, 9650, 9660, 9750, 9760	Alternator - 185 AMP	AMR135609	\$ 49.00
1 9560	Alternator - 200 AMP	AMR135607	\$ 48.00
1 9570	Alternator - 200 AMP	AMR521053	\$ 54.00
1 9660, 9670, 9760, 9770	Alternator - 200 AMP	AMAT262958	\$ 66.00
1 9860, 9870	Alternator	AMR503505	\$ 43.91
1 9860, 9870	Engine Fan	AMR503312	\$ 66.36
2 9560, 9570, 9650, 9660, 9670, 9750, 9760, 9770, 9860, 9870	Tailings Auger and Elevator	AMH154731	\$ 37.00
2 9560, 9570, 9660, 9670, 9760, 9770, 9860, 9870	Edible Bean	AMCP72	\$ 24.27
3 9560, 9570, 9650, 9660, 9670, 9750, 9760, 9860	Clean Grain Elevator	AMH206738	\$ 120.00
3 9770, 9870	Clean Grain Elevator	AMH223230	\$ 211.00
4 9650, 9750	Cleaning Fan	AMH165072	\$ 72.00
4 9560, 9660, 9670, 9760, 9770, 9860	Cleaning Fan	AMH206048	\$ 69.00
4 9570STS, 9870STS	Cleaning Fan	AMH230909	\$ 73.00
4 9560, 9660, 9760, 9860	Cleaning Fan, Slow Speed	AMH211601	\$ 75.00
4 9570, 9670, 9770, 9870	Cleaning Fan, Slow Speed	AMH215389	\$ 69.00
5 9560, 9570, 9650, 9660, 9670, 9750, 9760, 9770, 9860, 9870	Countershaft, Discharge Beater and Chopper 2 Banded Belt	AMHXE15671	\$ 102.00
5 9670, 9770, 9870 - Standard Duty	Countershaft, Discharge Beater and Chopper 2 Banded Belt	AMHXE10556	\$ 145.00
5 9770, 9870 - Heavy Duty	Countershaft, Discharge Beater and Chopper 3 Banded Belt	AMHXE10501	\$ 219.00
5 9860 Heavy Duty	Countershaft, Discharge Beater & Chopper 3 Banded Belt	AMH201596	\$ 171.00
6 9560, 9570, 9650, 9660, 9670, 9750, 9760, 9770, 9860, 9870	Discharge Beater	AMH168301	\$ 64.00
7 9560 BSN 715301, 9650, 9660 BSN 715401, 9750, 9760 BSN 715501, 9860 BSN 715601	Feed Accelerator, Standard Speed	AMH204133	\$ 111.67
7 9560 ASN 715301, 9570, 9660 ASN 715401, 9670, 9760 ASN 715501, 9770, 9860 ASN 715601, 9870	Feed Accelerator, Standard Speed Replaces H211581, H236472	AMHXE95511	\$ 130.00
7 9560, 9570, 9650, 9660, 9670, 9750, 9760, 9770, 9860, 9870	Feed Accelerator, Slow Speed Replaces H221732	AMH216026	\$ 128.00
7 9560STS, 9650STS, 9660STS BSN 715401, 9670STS, 9750STS, 9760STS BSN 715501, 9770STS, 9860STS BSN 715601, 9870STS	Feed Accelerator Drive, Standard Speed Replaces H211581, H236475	AMH221731	\$ 125.00
7 9660, 9670, 9760, 9770, 9860, 9870 BSN 730101	Feed Accelerator, High Speed 2V Belt Replaces H205209, H216027	AMH221733	\$ 135.00

John Deere®—Combine

Application	Description	Part Number	Retail Price
7 (9670, 9770, 9870 ASN 730101), 9860	Feed Accelerator, High Speed 3V Belt Replaces H230230	AMHXE54503	\$ 148.00
8 9650-9750 BSN 695601	Feederhouse, Fixed Speed	AMH111519	\$ 84.00
8 9650-9750 ASN 695601	Feederhouse, Fixed Speed	AMH125565	\$ 101.00
8 9560	Feederhouse, Fixed Speed	AMH126345	\$ 115.00
8 9560, 9570, 9660, 9670, 9760, 9770	Feederhouse, Fixed Speed For Standard Duty or Standard Capacity	AMH203474	\$ 95.00
8 9670, 9770, 9870	Feederhouse, Fixed Speed - Multi Speed Drive	AMH229019	\$ 281.00
8 9560, 9660, 9760, 9770, 9860, 9870	Feederhouse, Fixed Speed	AMH174885	\$ 250.00
9 9650-9750 BSN 695601	Feederhouse, Variable Speed - Standard Capacity	AMH157732	\$ 207.00
9 9650-9750 ASN 695601	Feederhouse, Variable Speed - Standard Capacity	AMH205169	\$ 199.00
9 9560, 9570, 9660	Feederhouse, Variable Speed - Standard Capacity	AMH201334	\$ 192.00
9 (9560, 9570, 9660, 9750, 9760 - Heavy Duty or High Capacity), (9670, 9770 - Standard or High Capacity), 9860 Standard Capacity	Feederhouse, Variable Speed	AMH218726	\$ 275.00
9 9660, 9670, 9760, 9770, 9860 High Speed - w/o Hydraulic Fore/Aft Tilt	Feederhouse, Variable Speed, High Torque	AMH220911	\$ 344.00
10 9560, 9570	Header and Reel Pump - Standard Capacity	AMH126345	\$ 115.00
10 9650, 9660, (9670, 9770 Fixed Speed), 9750, 9760, 9860	Header and Reel Pump, Fixed Spd Drive - Standard Capacity	AMH156796	\$ 143.00
10 9560, 9570	Header and Reel Pump - High Capacity	AMH209507	\$ 238.00
10 9650, 9660, (9670, 9770 - Variable Speed), 9750, 9760, 9860, 9870	Header and Reel Pump - High Capacity	AMH156541	\$ 230.00
10 9670, 9770, 9870 (Multi Speed)	Header and Reel Pump	AMH229018	\$ 306.00
11 9650, 9660, 9670, 9750, 9760, 9770, 9860, 9870	RH Jackshaft - Front Set of 2	AMAH150678	\$ 107.00
11 9560, 9570	RH Jackshaft - Front Set of 2	AMAH202773	\$ 102.00
11 9570, 9660, 9670, 9760, 9770, 9860	Edible Bean - Front	AMCP144	\$ 47.81
12 9560, 9570, 9650, 9660, 9670, 9750, 9760, 9770, 9860, 9870	RH Jackshaft - Rear	AMH154723	\$ 82.00
12 9870	RH Jackshaft, Edible Bean - Rear	AMCP144	\$ 47.81
13 9650-9750 BSN 695601	Rotary Screen Drive - Engine Side	AMH157104	\$ 15.08
13 9560	Rotary Screen Drive - Engine Side	AMH201498	\$ 13.38
13 9570, 9660 ASN 715401, 9670, 9760 ASN 715501, 9770, 9860 ASN 715601, 9870	Rotary Screen Drive - Engine Side	AMH213353	\$ 22.00
13 9650 ASN 695601, 9660 BSN 715401, 9750 ASN 695601, 9760 BSN 715501, 9860 BSN 715601	Rotary Screen Drive - Engine Side	AMH206807	\$ 16.00
14 9650-9750 BSN 695601	Rotary Screen Drive - Screen Side	AMH157105	\$ 48.00
14 9560	Rotary Screen Drive - Screen Side	AMH175632	\$ 20.87
14 9570, 9670, 9770, 9870	Rotary Screen Drive - Screen Side	AMH221273	\$ 32.50
14 9650 ASN 695601, 9660 BSN 715401, 9750 ASN 695601, 9760 BSN 715501, 9860 BSN 715601	Rotary Screen Drive - Screen Side Replaces HXE82335	AMH175628	\$ 30.00
14 9660 ASN 715401, 9760 ASN 715501, 9860 ASN 715601	Rotary Screen Drive - Screen Side	AMH214241	\$ 31.74
15 9560, 9570, 9650, 9660, 9670, 9750, 9760, 9770, 9860, 9870	Shoe Fan & Conveyor Augers	AMH175587	\$ 153.00
16 9560, 9570, 9650 ASN 700501, 9660, 9670 (CIS), 9750 ASN 700501, 9760, 9770 (CIS), 9870 (CIS)	Straw Chopper	AMH235564	\$ 143.00
16 (9650, 9750 BSN 700501)	Straw Chopper	AMH201571	\$ 115.00
16 9670	Straw Chopper	AMH232997	\$ 112.00
16 9770, 9870	Straw Chopper	AMH223212	\$ 163.00
16 9860 (Premium Grain)	Straw Chopper	AMH174368	\$ 205.00
16 9860	Straw Chopper Drive	AMH220747	\$ 178.00
17 9560, 9570, 9650, 9660, 9670, 9750, 9760	Variable Rotor Drive	AMH221498	\$ 413.00

John Deere®—Combine

Application	Description	Part Number	Retail Price
17 9860 BSN 705798	STS Variable Drive	AMH207851	\$ 699.00
17 9770, 9860 ASN 705798, 9870	STS Variable Drive Replaces H208431	AMHXE63990	\$ 638.00
17 9660, 9670, 9760 - w/ Regular Sheaves	Rotor Drive	AMHXE46027	\$ 454.00
18 9560, 9570, 9650, 9660, 9670, 9750, 9760, 9770, 9860, 9870	Unloading Auger System Set of 2	AMAH160080	\$ 87.00

Belts—9650CTS, 9660CTS, CTS, CTS II, CTS Rice

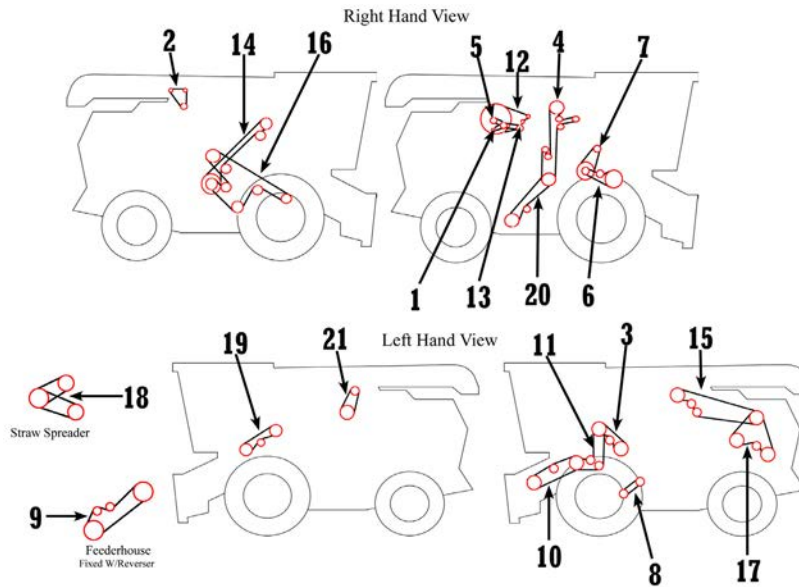

Application	Description	Part Number	Retail Price
1 CTS, CTS Rice, CTS II	Air Conditioning Compressor 58" OD	AMH134437	\$ 13.00
2 CTS, CTS Rice, CTS II	Alternator	AMH101813	\$ 13.00
2 9650CTS BSN 695401	Alternator - 95 AMP	AMH163515	\$ 49.00
2 9650CTS BSN 695401	Alternator - 185 AMP	AMH166870	\$ 50.58
2 9650CTS ASN 695401	Alternator - 185 AMP	AMR164820	\$ 26.93
3 CTS, CTS Rice, CTS II	Beater Drive	AMH143700	\$ 25.00
3 9650CTS	Overshot Beater Drive, 740-1170 RPM	AMH165708	\$ 85.00
3 9650CTS	Overshot Beater Drive, 400 RPM Slow Down Kit	AME16774	\$ 37.00
3 9650CTS	Overshot Beater Drive, 700 RPM Slow Down Kit	AMN121116	\$ 33.45
3 9650CTS	Overshot Beater Drive	AMH139963	\$ 15.13
4 9650CTS, 9660CTS	Clean Grain Elevator	AMH141166	\$ 128.00
4 CTS, CTS Rice	Clean Grain Elevator	AMH141167	\$ 122.00
4 CTS II	Clean Grain Elevator	AMH160171	\$ 145.00
5 CTS, CTS Rice	Cooling Fan, High Power	AMH153297	\$ 51.00
5 9650CTS BSN 695401, CTS II	Cooling Fan	AMH160405	\$ 44.01
5 9650CTS ASN 695401	Cooling Fan	AMH177186	\$ 40.34
6 9650CTS	Cylinder Drive - 109" OD	AMH145994	\$ 139.00
6 9650CTS, 9660CTS, CTS, CTS Rice, CTS II	Cylinder Drive, Reg Dual & Single Range - 111.50" OD	AMH115881	\$ 165.00
6 9650CTS, 9660CTS, CTS, CTS Rice, CTS II	Cylinder Drive, Slow Speed - 107" OD	AMH118618	\$ 153.00
7 9650CTS, 9660CTS, CTS, CTS Rice, CTS II	Cylinder, Intermediate Drive - 2.50" Wide	AMH210476	\$ 265.00
7 9650CTS	Cylinder, Intermediate Drive - 3" Wide	AMH137670	\$ 250.00
8 CTS BSN 670401	Fan Drive, Regular, 750-1350 RPM	AMH140404	\$ 68.00

Prices Subject to Change without Prior Notice. The use of original equipment manufacturer (OEM) part numbers or trademarks, e.g. Case® and John Deere®, are for reference purposes only and for indicating product use and compatibility. Our company and the listed replacement parts contained herein are not sponsored, approved or manufactured by the OEM. All parts are New unless designated Reman in the description.

John Deere®—Combine

Application	Description	Part Number	Retail Price
8 9650CTS, 9660CTS, CTS ASN 670401, CTS II	Fan Drive, Regular, 750-1350 RPM	AMH152146	\$ 77.00
8 CTS BSN 670401	Fan Drive, Slow Speed, 490-980 RPM	AMH137264	\$ 67.00
8 9650CTS, 9660CTS, CTS ASN 670401, CTS II	Fan Drive, Slow Speed, 490-980 RPM	AMH152180	\$ 72.00
9 9650CTS BSN 700401, CTS, CTS Rice, CTS II	Feederhouse, Fixed Speed w/ Reverser	AMH126345	\$ 115.00
9 9650CTS ASN 700401	Feederhouse, Fixed Speed w/ Reverser	AMH156796	\$ 143.00
10 9650CTS BSN 700401, CTS, CTS II, CTS Rice (w/ Rev)	Feederhouse, Variable Speed - Standard	AMH161648	\$ 173.00
10 9650 ASN 700401	Feederhouse, Variable Speed - Standard Capacity	AMH205167	\$ 215.00
10 9660CTS	Feederhouse, Variable Speed - Standard	AMH203393	\$ 215.00
10 9650CTS, 9660CTS	Feederhouse, Variable Speed - High Capacity	AMH218728	\$ 239.00
11 9650CTS, 9660CTS, CTS, CTS Rice, CTS II	Header and Reel Pump - Standard Capacity	AMH151952	\$ 104.00
11 9650CTS, 9660CTS	Header and Reel Pump - High Capacity	AMH155998	\$ 142.00
12 CTS, CTS Rice	Rotary Screen	AMH143869	\$ 55.00
12 9650CTS BSN 695401, CTS II	Rotary Screen	AMH145158	\$ 40.00
12 9650CTS ASN 695401	Rotary Screen	AMH175632	\$ 20.87
13 CTS, CTS Rice	Rotary Screen Drive	AMH134216	\$ 21.00
13 9650CTS ASN 695401, CTS II	Rotary Screen Drive	AMH146636	\$ 10.00
13 9650CTS BSN 695401	Rotary Screen Drive	AMH160406	\$ 9.60
14 9650CTS, 9660CTS, CTS, CTS Rice, CTS II	Secondary Countershaft	AMH128010	\$ 63.00
15 CTS, CTS Rice, CTS II	Separator Fan Drive	AMH141429	\$ 281.00
15 9650CTS	Tine Separator Drive	AMH163106	\$ 290.50
16 9650CTS, 9660CTS, CTS, CTS Rice, CTS II	Shoe, Straw Walker and Conveyor Augers	AMH131169	\$ 112.00
17 CTS II	Straw Chopper, Front - Fine Cut	AMH155525	\$ 129.76
17 CTS, CTS Rice, CTS II	Straw Chopper, Front	AMH168301	\$ 64.00
17 9650CTS	Straw Chopper Drive	AMH162727	\$ 155.23
18 CTS, CTS Rice, CTS II	Straw Spreader - 53" OD	AME61326	\$ 14.65
18 9650CTS, CTS, CTS Rice, CTS II	Straw Spreader, Lower	AMP49604	\$ 25.90
18 9650CTS	Straw Spreader, Upper	AMH164870	\$ 17.83
18 CTS II	Chaff Spreader Drive	AMM95728	\$ 45.02
19 CTS, CTS Rice, CTS II	Stripper Beater Drive	AMH139963	\$ 15.13
19 9650CTS	Stripper Beater Drive	AMH165708	\$ 85.00
20 9650CTS, 9660CTS, CTS, CTS Rice, CTS II	Tailings Auger and Elevator, Lower	AMN110085	\$ 56.00
21 9650CTS, 9660CTS, CTS, CTS Rice, CTS II	Unloading System Set of 2	AMAH158880	\$ 58.00
NI 9660CTS	Air Flow Drive	AMH164452	\$ 14.00

John Deere®—Combine

Belts—S550, S650, S660, S660HM, S670, S670HM, S680, S680HM, S690, S690HM

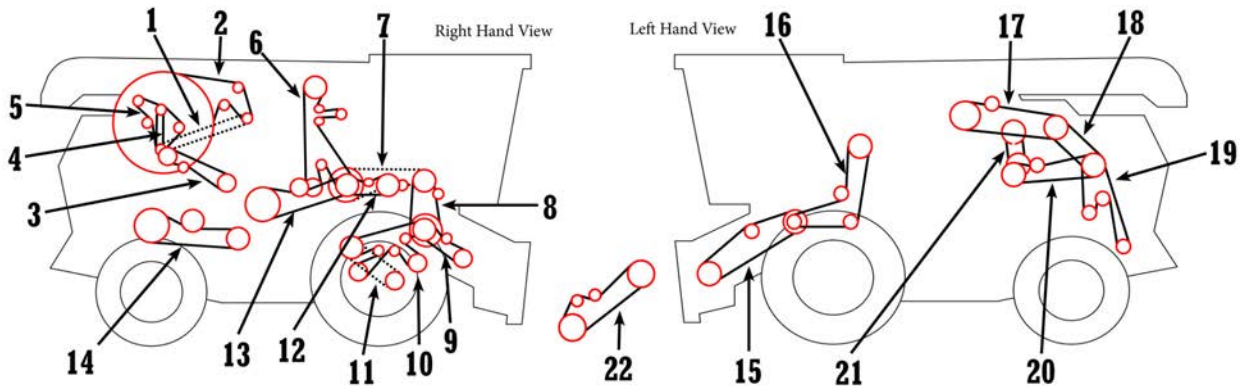

Application	Description	Part Number	Retail Price
1 S550 MY18	Air Screen Drive, Engine Side	AMH213353	\$ 22.00
1 S650, S660, S670, S670HM, S680, S680HM, S690, S690HM - MY18	Air Screen Drive, Engine Side	AMH238867	\$ 20.00
2 S550, S650, S660, S670, S670HM, S680, S680HM, S690, S690HM - MY18	Air Screen Drive, Screen Side	AMH221273	\$ 32.50
3 S650, S660, S670, S670HM - MY18	Vacuum Fan Drive, Upper Replaces HXE24085	AMHXE68015	\$ 16.77
3 S660, S670, S670 - MY18	Vacuum Fan, Lower	AMHXE24086	\$ 16.00
3 S680, S680HM, S690, S690HM - MY18	Vacuum Fan Drive	AMHXE38073	\$ 13.73
4 S550 MY18	Fan and Alternator	AMR521053	\$ 54.00
4 S650, S660, S670, S670HM - MY18	Fan Belt	AMHXE22617	\$ 52.05
4 S680, S680HM, S690, S690HM - MY18	Fan Belt	AMHXE32548	\$ 34.06
5 S650, S660, S670, S670HM - MY18	Alternator	AMH238822	\$ 34.00
5 S680, S680HM, S690, S690HM - MY18	Alternator	AMH238831	\$ 31.35
6 S550, S650, S660 - MY18	Clean Grain Elevator	AMH206738	\$ 120.00
6 S670, S670HM, S680, S680HM, S690HM - MY18	Clean Grain Elevator	AMH223230	\$ 211.00
6 S690 MY18	Clean Grain Elevator	AMHXE20763	\$ 195.00
7 S550, S650, S660, S670, S670HM, S680, S680HM, S690, S690HM - MY18	RH Separator Jackshaft, Rear	AMH154723	\$ 82.00
8 S550 MY18	RH Separator Jackshaft, Front Set of 2	AMAXE13650	\$ 105.00
8 S650, S660, S670, S670HM, S680, S680HM, S690, S690HM - MY18	RH Separator Jackshaft, Front Set of 2	AMAH150678	\$ 107.00
9 S550, S650, S660, S670, S670HM, S680, S680HM, S690, S690HM - MY18	Feed Accelerator, STD Speed Replaces H211581, H236472	AMHXE95511	\$ 130.00
9 S550, S650, S660, S670, S670HM, S680, S680HM, S690, S690HM - MY18	Feed Accelerator, Slow Speed Replaces H221732	AMH216026	\$ 128.00
9 S660 SN 745100-765171, (S670, S680, S690 SN 745100-785000), (S670HM, S680HM BSN 765000), S690HM SN 745101-765000 - All MY18	Feed Accelerator, High Speed 3V Belt Replaces H230230	AMHXE54503	\$ 148.00
10 S550, S650, S660, S670, S670HM, S680, S680HM, S690, S690HM - MY18	Shoe Fan & Conveyor Augers	AMH175587	\$ 153.00
11 S550, (S650, S660, S670, S680, S690 BSN 785000), S670HM, S680HM, S690HM - All MY18	Cleaning Fan Drive	AMHXE15594	\$ 80.00
11 (S650, S660, S670, S680 ASN 785001), S690 - All MY18	Cleaning Fan Drive	AMHXE99294	\$ 85.00
12 S550, S650, S660, S670, S670HM - MY18	Tailings Elevator Drive	AMH154731	\$ 37.00
13 S680, S680HM, S690, S690HM - MY18	Tailings Retresher Drive	AMH240895	\$ 62.00
14 S670, S670HM, S680, S680HM, S690, S690HM - MY18	Overshot Beater Drive	AMH240895	\$ 62.00

John Deere®—Combine

Application	Description	Part Number	Retail Price
15 S550, S650, S660	Feederhouse, Variable Speed, Heavy Duty or High Capacity	AMH218726	\$ 275.00
15 S660, S670, S670HM, S680 SN 766007-785000 - w/o Hydraulic Fore/Aft Tilt	Feederhouse, Variable Speed, High Torque	AMH220911	\$ 344.00
16 S550 MY18	Front End Dr Clutch to Feederhouse, STD Duty	AMHXE16928	\$ 155.00
16 S550 MY18	Front End Dr Clutch to Feederhouse, Heavy Duty	AMHXE16927	\$ 160.00
16 S650, S660, S670, S670HM, S680, S680HM, S690 ASN 745100-765252, S690HM - MY18	Front End Dr Clutch to Feederhouse, Heavy Duty	AMH156541	\$ 230.00
16 S670, S680, S690 - MY18	Front End Dr 5 Spd to Feederhouse	AMH229018	\$ 306.00
17 S550, S650, S660, S670, S670HM - MY18	Unloading Auger System Set of 2	AMAH160080	\$ 87.00
17 S680, S680HM, S690, S690HM - MY18	Unloader Drive Set of 2	AMAH233198	\$ 128.00
18 S550 MY18	Chopper Drive, Upper 2 Banded Belt	AMHXE15671	\$ 102.00
18 S650, S660, S670, S670HM, S680, S680HM, S690, S690HM - MY18	Chopper Drive, Upper Fine Cut Replaces HXE124868	AMHXE124868	\$ 350.00
18 S670, S670HM - MY18	Chopper Drive, Upper Extra Fine Cut	AMH241000	\$ 243.00
18 S680, S680HM, S690, S690HM - MY18	Chopper Drive, Upper Extra Fine Cut	AMH240888	\$ 305.00
19 S550 MY18	Chopper Drive, Lower	AMH235564	\$ 143.00
19 S650, S660, S670, S670HM, S680, S680HM, S690, S690HM - MY18 w/ Manual or Powercast Tail Board	Chopper Drive, Lower Fine Cut (2) Required Replaces HXE124869	AMHXE124869	\$ 342.00
19 S650, S660, S670, S670HM, S680, S680HM, S690, S690HM - MY18	Chopper Drive, Lower Extra Fine Cut	AMH240974	\$ 235.00
19 S650, S660, S670HM, S670HM, S680, S680HM, S690, S690HM - MY18	Chopper Drive, Lower Extra Fine Cut	AMH240972	\$ 73.00
20 S550 MY18	Discharge Beater Drive	AMH168301	\$ 64.00
20 S650, S660 - MY18	Discharge Beater Drive	AMHXE15556	\$ 89.00
20 S660, S670, S680, S680HM, S690, S690HM - MY18	Discharge Beater Drive Fine Cut	AMHXE124870	\$ 219.00
20 S670, S670HM, S680, S680HM, S690, S690HM - MY18	Discharge Beater Drive Set of 2	AMAH236689	\$ 168.00
21 S550, S560 - MY18	Rotor Drive	AMH221498	\$ 413.00
21 S650, S660, S670 ASN 765252, S760 - MY18 w/ Regular Sheaves	Rotor Drive	AMHXE46027	\$ 454.00
21 S670, S670HM, S680, S680HM, S690, S690HM - MY18	Rotor Drive Replaces H208431	AMHXE63990	\$ 638.00
22 S550, S650 BSN 785001, S660 BSN 765172	Feederhouse, Fixed Speed For Standard Duty or Standard Capacity	AMH203474	\$ 95.00
22 S650 Heavy Duty and High Torque, (S660 Standard and Heavy Duty BSN 765172 or High Torque w/o Hydraulic Fore/Aft Tilt), (S670, S670HM, S680, S680MH, S690, S690HM - High Torque w/o Hydraulic Fore/Aft Tilt)	Feederhouse, Fixed Speed	AMH174885	\$ 250.00
22 S670, S680, S690 - MY18	Feederhouse, Fixed 5 Speed	AMH229019	\$ 281.00

John Deere®—Combine

Belts—S760, S770, S780, S785, S790

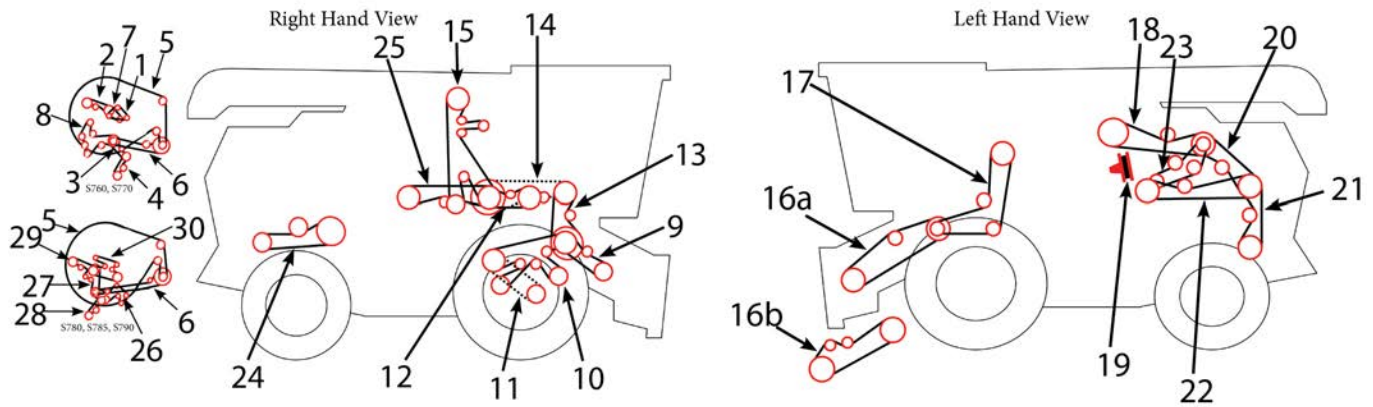

Application	Description	Part Number	Retail Price
1 S760, S770 - MY18	Air Compressor Drive (Tier 2)	AMR307304	\$ 31.00
2 S760, S770 - MY18	Air Compressor Drive (Tier 4)	AMHXE71043	\$ 32.00
3 S760, S770 - MY18	Vacuum Fan Drive, Upper Replaces HXE24085	AMHXE68015	\$ 16.77
4 S760, S770 - MY18	Vacuum Fan Drive, Lower	AMHXE68016	\$ 16.00
5 S760, S770, S780, S785, S790 - MY18	Air Screen Drive, Screen Side	AMH221273	\$ 32.50
6 S760, S770, S780, S785, S790 - MY18	Air Screen Drive, Engine Side	AMH238867	\$ 20.00
7 S760, S770 - MY18	Fan Belt, Variable Speed (Tier 4)	AMHXE22617	\$ 52.05
8 S760, S770 - MY18	Engine Front Drive (Tier 2)	AMHXE32806	\$ 43.00
8 S760, S770 - MY18	Engine Front Drive (Tier 4)	AMH238822	\$ 34.00
9 S760, S770, S780, S785, S790 - MY18	Feed Accelerator Stone Trap Drive, Standard Speed	AMHXE95511	\$ 130.00
9 S760, S770, S780, S785, S790 - MY18	Feed Accelerator Stone Trap Drive, High Speed 3V Belt Replaces H230230	AMHXE54503	\$ 148.00
9 S760, S770, S780, S790 - MY18	Feed Accelerator Stone Trap Drive, Slow Speed Replaces H221732	AMH216026	\$ 128.00
10 S760, S770, S780, S785, S790 - MY18	Conveyor Auger Drive	AMHXE102288	\$ 418.00
11 S760, S770, S780, S785, S790 - MY18	Cleaning Fan Drive	AMHXE99294	\$ 85.00
12 S760, S770 - MY18	Tailings Elevator Drive	AMH154731	\$ 37.00
13 S760, S770, S780, S785, S790 - MY18	Separator Jackshaft Drive, Front	AMHXE88564	\$ 163.00
14 S760, S770, S780, S785, S790 - MY18	Separator Jackshaft Drive, Rear	AMH154723	\$ 82.00
15 S760, S770 ASN 1JZS770110000 - MY18	Clean Grain Elevator Drive	AMH206738	\$ 120.00
15 S770 ASN 1HOS770800001, S780, S785, S790 ASN 1ZOS790110000 - MY18	Clean Grain Elevator Drive	AMH223230	\$ 211.00
15 S790 ASN 1HOS790800001 - MY18	Clean Grain Elevator Drive	AMHXE20763	\$ 195.00
16a S760 w/o Hydraulic Fore/Aft Tilt	Feeder House, Variable Speed, Heavy Duty	AMH218726	\$ 275.00
16a S760, S770 - MY18	Feeder House, Variable Speed High Torque w/ Fore-Aft Tilt	AMHXE50399	\$ 393.00
16a S760, S770 - w/o Hydraulic Fore/Aft Tilt	Feederhouse, Variable Speed High Torque w/o Fore-Aft Tilt	AMH220911	\$ 344.00
16a S770, S780, S785, S790 - MY18	Feeder House, Fixed 5-Speed w/ Fore-Aft Tilt	AMHXE47152	\$ 367.00
16a S770, S780, S785, S790 - MY18	Feeder House, Fixed 5-Speed w/o Fore-Aft Tilt	AMH229019	\$ 281.00
16b S760, S770, S780, S785, S790 - MY18	Feeder House, Fixed Speed High Torque w/ Fore-Aft Tilt	AMHXE50398	\$ 405.00
16b S760, S770, S780, S790	Feeder House, Fixed Speed High Torque w/o Fore-Aft Tilt	AMH174885	\$ 250.00

Prices Subject to Change without Prior Notice. The use of original equipment manufacturer (OEM) part numbers or trademarks, e.g. Case® and John Deere®, are for reference purposes only and for indicating product use and compatibility. Our company and the listed replacement parts contained herein are not sponsored, approved or manufactured by the OEM. All parts are New unless designated Reman in the description.

John Deere®—Combine

Application	Description	Part Number	Retail Price
17 S760, S770, S780, S785, S790 - MY18	Feederhouse Front End Drive, Heavy Duty	AMH156541	\$ 230.00
17 S770, S780, S785, S790 - MY18	Feederhouse Front End Drive, 5-Speed	AMH229018	\$ 306.00
18 S760, S770 - MY18	Grain Tank Auger Drive Set of 2	AMAH160080	\$ 87.00
18 S780, S785, S790 - MY18	Grain Tank Auger Drive Set of 2	AMAH233198	\$ 128.00
19 S760, S770 - MY18	Separator Rotor Drive	AMHXE46027	\$ 454.00
19 S780, S785, S790 - MY18 w/ Large Sheaves	Separator Rotor Drive Replaces H208431	AMHXE63990	\$ 638.00
20 S760, S770, S780, S790 - MY18	Straw Spreader and Dual Chopper Drive Fine Cut Replaces HXE124868	AMHXE124868	\$ 350.00
20 S770 MY18	Dual Chopper Drive Extra Fine Cut, 3 Banded	AMH241000	\$ 243.00
20 S780, S785, S790 - MY18	Dual Chopper Drive Extra Fine Cut, 4 Banded	AMH240888	\$ 305.00
21 S760, S770, S780, S790 - MY18 w/ Manual or Powercast Tail Board	Dual Chopper Drive Fine Cut (2) Required Replaces HXE124869	AMHXE124869	\$ 342.00
21 S770, S780, S785, S790 - MY18	Dual Chopper Drive Extra Fine Cut, Single Belt	AMH240972	\$ 73.00
21 S770, S780, S785, S790 - MY18	Dual Chopper Drive Extra Fine Cut, Banded Belt	AMH240974	\$ 235.00
22 S760 MY18	Discharge Beater Drive	AMHXE15556	\$ 89.00
22 S760, S770, S780, S785, S790 - MY18	Discharge Beater Drive Fine Cut	AMHXE124870	\$ 219.00
22 S770 ASN 1Z0S770XXXX109999, S780 ASN 1Z0S780XXXX109999, S785 ASN 1Z0S790XXXX109999 - MY18	Discharge Beater Drive Extra Fine Cut	AMHXE124870	\$ 219.00
23 S760, S770 - MY18	After Treatment Blower Drive	AMHXE69280	\$ 24.00
23 S780, S785, S790 - MY18	After Treatment Blower Drive	AMHXE69281	\$ 21.80
24 S770, S780, S785, S790 - MY18	Overshot Beater Drive	AMH240895	\$ 62.00
25 S780, S785, S790 - MY18	Tailings Rethresher Drive	AMH240895	\$ 62.00
26 S780, S790 - MY18	Engine Front Drive (Tier 2)	AMR503505	\$ 43.91
26 S780, S785, S790 - MY18	Engine Front Drive (Tier 4)	AMH238831	\$ 31.35
27 S780, S790 - MY18	Fixed Fan Drive (Tier 2)	AMR503312	\$ 66.36
27 S780, S785, S790 - MY18	Fixed Fan Drive (Tier 4)	AMHXE32548	\$ 34.06
28 S780, S785, S790 - MY18	Vacuum Fan Drive (Tier 4)	AMHXE38073	\$ 13.73
29 S780, S785, S790 - MY18	Engine Front Drive (Tier 4)	AMHXE71061	\$ 18.25
30 S780, S790 - MY18	Air Compressor Drive (Tier 2)	AMHXE80480	\$ 46.00

John Deere®—Combine

Belts—T660, T670

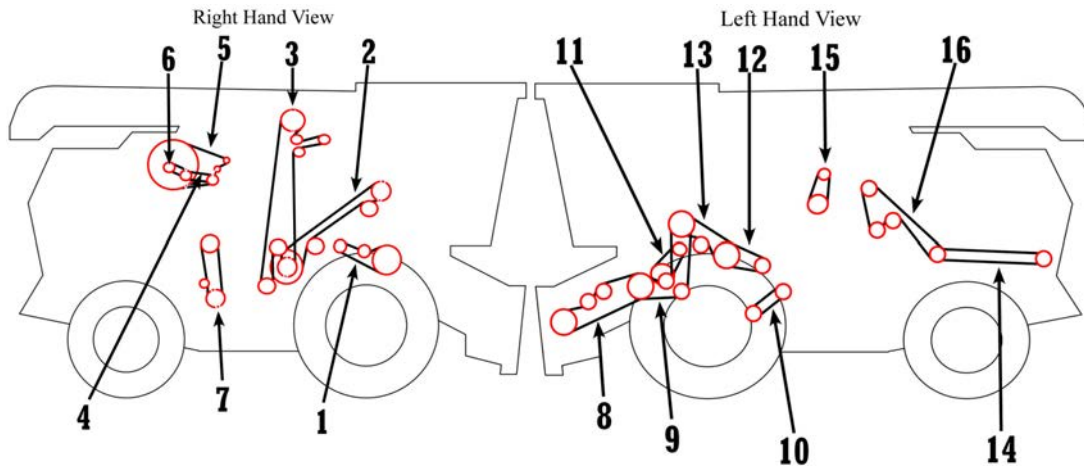

Application	Description	Part Number	Retail Price
1 T660, T670	Cylinder Drive	AMH115881	\$ 165.00
2 T660, T670	Secondary Countershaft	AMH128010	\$ 63.00
3 T660, T670	Clean Grain Elevator	AMH141166	\$ 128.00
4 T660, T670	Rotary Screen Drive	AMH146636	\$ 10.00
5 T660, T670	Rotary Screen Drive - Screen Side Replaces HXE82335	AMH175628	\$ 30.00
6 T660, T670	Cooling Fan	AMH174455	\$ 56.27
7 T660, T670	Tailings Auger and Elevator, Lower	AMZ59557	\$ 52.00
8 T660, T670	Feederhouse Drive, 108.11"	AMH176766	\$ 164.78
8 T660-T670 (Hillmaster)	Feederhouse Drive, 112.05"	AMH202821	\$ 188.59
8 (T660-T670 ASN 85500)	Feederhouse Drive, 111.81"	AMHXE12426	\$ 293.89
8 (T660-T670 ASN 85500)	Feederhouse Drive, 107.87"	AMHXE12427	\$ 186.00
9 T660, T670	Header and Reel Pump	AMH176765	\$ 287.90
9 T660, T670	Header and Reel Pump, 900 RPM	AMHXE12425	\$ 311.27
10 T660, T670	Cleaning Fan	AMH152146	\$ 77.00
11 T660, T670	Stripper Beater	AMH139963	\$ 15.13
12 T660, T670	Overshot Beater Drive	AMZ103845	\$ 83.49
13 T660, T670	Beater Drive	AMZ103844	\$ 95.80
14 T660, T670	Straw Chopper/Spreader, For Corn	AMH177178	\$ 230.88
14 T660, T670	Straw Chopper/Spreader	AMZ59286	\$ 212.58
15 T660, T670	Unloading System Set of 2	AMAH158880	\$ 58.00
16 T660, T670	Separator Fan Drive	AMH177177	\$ 233.00

John Deere®—Combine

Belts—Cotton Pickers & Swathers

Application	Description	Part Number	Retail Price
NI 9900, 9910, 9920, 9930	Unit Drive, RH	AMN121116	\$ 33.45
NI 9960 BSN 4000	Unit Drive, RH	AMAN194750	\$ 67.00
NI 9960 ASN 4001	Unit Drive, RH Set of 2	AMAN194916	\$ 82.81
NI 9900, 9910, 9920, 9930	Unit Drive, LH	AMN111527	\$ 29.68
NI 9960	Unit Drive, LH	AMAN194917	\$ 85.00
NI 9940, 9950	Unit Drive	AMAN190948	\$ 91.00
NI 9930, 9920	Hydraulic Pump	AME61326	\$ 14.65
NI 9930	Lube Pump	AMM41592	\$ 13.00
NI 9900	Hydraulic Pump Cushion Mount	AMN115368	\$ 19.72
NI 9900, 9910	Hydraulic Pump Solid Mount	AMN117398	\$ 13.92
NI 9940, 9950	Hydrostat Charge Pump	AMN190043	\$ 12.13
NI 4895, 4990, 4995	Fan	AMR500244	\$ 64.00
NI 9900, 9910 BSN 3055	Fan	AMN124460	\$ 55.87
NI 9910 ASN 3056, 9920, 9930	Fan	AMN129368	\$ 55.59
NI 9940, 9950	Fan	AMN193822	\$ 90.37
NI 2280	Platform Drive	AME50873	\$ 117.00
NI 2280 BSN 490000	Sickle Drive 230 Platform	AME37905	\$ 40.75
NI 2280 ASN 490001	Sickle Drive 230 Platform	AME63036	\$ 44.66
NI Swathers: 800, 830	Platform Drive	AME48061	\$ 138.00
NI Swathers: (2250, 2270, 2280 ASN 490000)	Platform Drive 1000 RPM Speed Up Belt	AME58967	\$ 150.00

Belts—8000 Series Forage Harvesters

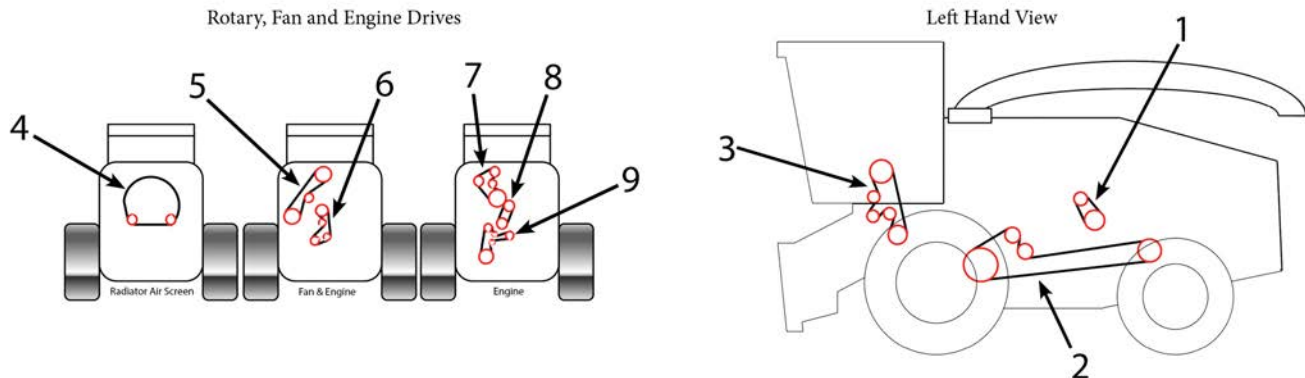

Application	Description	Part Number	Retail Price
1 8100, 8200, 8300, 8400, 8500, 8600, 8700, 8800	Vacuum Fan Drive	AMHXE64200	\$ 16.18
2 8100, 8200, (8300, 8400, 8500 SN 516000-517999), (8600, 8700, 8800 SN 517000-517999)	Main Drive	AMAXE37395	\$ 655.00
2 (8300, 8400, 8500 SN 513822-515999)	Main Drive	AMAXE51063	\$ 903.00
2 (8300, 8400, 8500 SN 513822-515999), 8600 SN 513822-516999	Main Drive, 1100 RPM	AMAXE17662	\$ 695.00
2 8600 SN 513822-516999	Main Drive, 1200 RPM	AMAXE51063	\$ 903.00
2 (8700, 8800 SN 513822-516999)	Main Drive, 1100 RPM	AMAXE41286	\$ 1075.00
2 (8700, 8800 SN 513822-516999)	Main Drive, 1200 RPM	AMAXE51876	\$ 1265.00

John Deere®—Combine

Application	Description	Part Number	Retail Price
3 8100, 8200, 8300, 8400, 8500, (8600, 8700, 8800 SN 517000-517999)	Kernel Processor	AMHXE39119	\$ 158.00
3 8100, 8200, 8300, 8400, 8500, (8600, 8700, 8800 SN 517000-517999)	Kernel Processor, KernelStar™	AMHXE93098	\$ 135.00
3 (8600, 8700, 8800 SN 513822-516999)	Kernel Processor Set of 2	AMAXE25334	\$ 248.00
3 (8600, 8700, 8800 SN 513822-516999)	Kernel Processor, KernelStar™ Set of 2	AMAXE52471	\$ 212.00
4 (8100, 8200, 8300, 8400, 8500, 8600, 8700, 8800 SN 517000-517999)	Radiator Air Screen	AMZ103479	\$ 33.00
5 8100, 8200, 8300, 8400, 8500, 8600, 8700 SN 517000-517999, (8800 SN 513822-515999 & 517000-517999)	Fan Drive	AMAXE33760	\$ 98.00
5 8800 SN 516000-516999	Fan Drive	AMCQ40222	\$ 108.00
6 8100, 8200, (8300, 8400, 8500 SN 516000-517999), (8600, 8700, 8800 SN 517000-517999)	Engine Drive (Non-EGR Engine)	AMHXE43428	\$ 32.00
6 8100, 8200, (8300, 8400, 8500 SN 516000-517999), (8600, 8700, 8800 SN 517000-517999)	Engine Drive (FT4 Engine)	AMHXE90896	\$ 36.00
6 (8300, 8400, 8500 SN 513822-515999), 8600 SN 513822-516999	Engine Drive (Non-EGR Engine)	AMHXE41402	\$ 40.00
6 (8300, 8400, 8500 SN 513822-515999), 8600 SN 513822-516999	Engine Drive (FT4 Engine)	AMHXE79106	\$ 32.00
7 (8700, 8800 SN 513822-516999)	Engine Drive, Air Compressor/Alternator	AMHXE24688	\$ 33.00
8 (8700, 8800 SN 513822-516999)	Engine Drive, Alternator 24 Volt	AMREC541298700	\$ 14.00
9 (8700, 8800 SN 513822-516999)	Engine Drive, Air Compressor (Tier 2)	AMHXE81232	\$ 56.00

Belts—Platforms

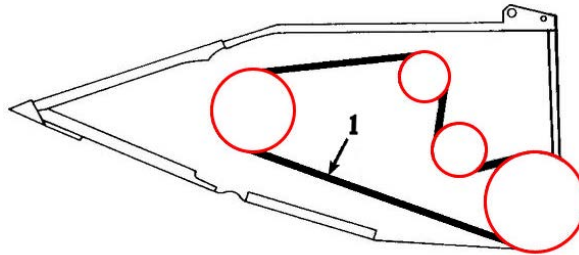

Application	Description	Part Number	Retail Price
1 213, 215, 216, 218, 220, 222, 224, 230, 920, 922, 925, 930	Platform 128" Long, Use w/ 11.50" or 12" Sheaves	AMH136881	\$ 51.00
1 600R	Platform Retracted and Middle Cutterbar, 111.25" Long	AMH210003	\$ 48.00
1 600R	Platform Extended Cutterbar, 121.45" Long Replaces H210001	AMH221324	\$ 52.82
1 918, 920, 922, 925, 930	Platform Belt 131" Long	AMH202647	\$ 52.00
NI 600F, 600R	Flex Drive 118.307" Long Replaces H201794	AMH220884	\$ 56.00
NI 925D, 930D, 936D	Knife Drive 117.00" Long	AMH166077	\$ 58.00

New, Used and Remanufactured

Honest. Personal. Service.

Draper Belts

Abilene Machine is proud to offer the Q-Power® line of heavy-duty draper belts to keep up with the demands of harvest. These best-selling products are comparable to OEM parts in tensile strength, tear strength and puncture resistance. They are exceptional replacements for many makes, including John Deere®, New Holland®, Case IH® and MacDon®.

Features and Benefits

Teardrop Cleats for Better Durability

Our draper belts are reinforced with teardrop-shaped fiberglass rods for increased cross-directional strength and durability.

Teardrop vs Diamond Cleat



Filament Fibers for Increased Tensile Strength

The patented design is made with filament fibers — long, continuous, uniform fibers — that consistently outperform belts made from typical spun fiber in strength tests. They stand up better to stretching and pulling than the competition.

Coated for Enhanced Tear and Puncture Resistance

Q-Power® Draper Belts feature both skim and friction coating for enhanced performance. This rubber reinforcement is applied to the top (skim) and bottom (friction) of the belt, increasing durability and fabric protection, while reducing drag and belt weight.

Abilene Machine is a family-owned and operated company that's been serving farmers for over 40 years. With an inventory of more than 40,000 parts and four locations across the United States, we'll make sure you get dependable, durable parts shipped fast.

Q-Power® is 29.5% stronger



Q-Power® is 18.1% more tear resistant

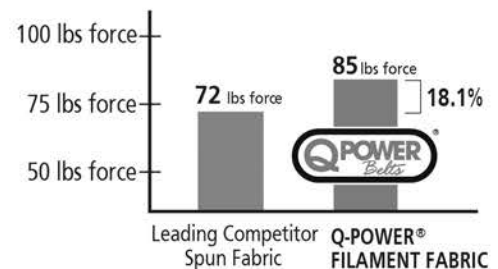

Q-Power® is 81.7% more puncture resistant

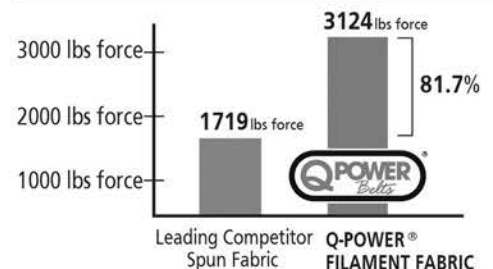

Abilene, Kansas
Bishopville, South Carolina
Sioux Falls, South Dakota
Billings, Montana

785-670-6741
AbileneMachine.com

All parts are new unless designated remanufactured in the description. Products listed are replacement parts only — not original equipment manufacturers. OEM names and brands are used for identification purposes only.

Extended Wear Augers

Abilene Machine carries the best-built augers in the industry. Our in-house facility includes state-of-the-art equipment that balances, calibrates and tests our augers. These durable parts feature cupped flighting for longer life and greater grain-handling capacity.



Features and Benefits

Greater grain retention

Cupped Super-Edge™ Helicoid Flighting with enhanced edge thickness and up to 30° lean from vertical allows for increased grain-handling capability.

Increased wear resistance

Key edges of the Super-Edge™ Helicoid Flighting are up to 50% thicker (and a guaranteed minimum of 30% thicker) than standard augers. The tapered edges have targeted reinforcement, so our augers are stronger at the exact spots that tend to wear more easily, giving them a longer life in the field.

Improved strength and durability

Advancements in the Super-Edge™ Helicoid Flighting mean farmers have a stronger auger without extra weight and a more durable part.

Optimized output

With a longer life and higher grain capacity, our augers provide productivity gains over a much longer period, significantly reducing the cost per bushel.

Abilene Machine is a family-owned and operated company that's been serving farmers for over 40 years. With an inventory of more than 40,000 parts and four locations across the United States, we'll make sure you get dependable, durable parts shipped fast.



Abilene Machine LLC
P.O. Box 129
Abilene, KS 67410
(785) 670-6741

Honest. Personal. Service.

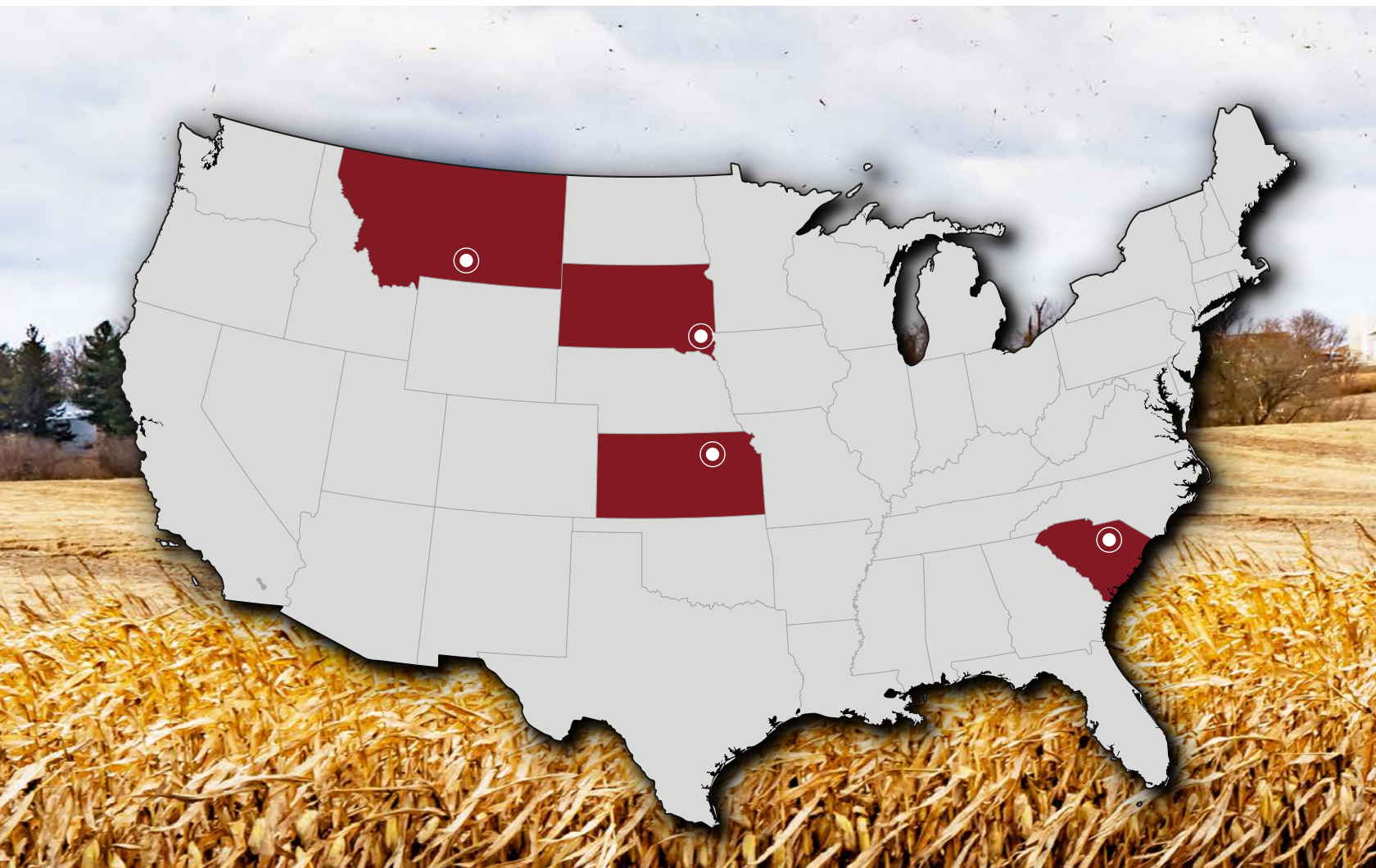

Abilene Machine LLC
(785) 670-6741



AbileneMachine.com



 Follow Abilene Machine on Facebook