



AbileneMachine®
Ag Replacement Parts

**2022
PARTS
CATALOG**



AbileneMachine.com

Upholstery

Table of Contents

Cab Upholstery Foam Material.....	13	Corner Post Kits	9
Floor Mat Material.....	13	Floor Mats, Fenders and Misc	10
Upholstery Kits—Allis Chalmers®	1	Headliners	7
Upholstery Kits—Case®	2	Upholstery Kits	6
Upholstery Kits—Case IH®	2	Upholstery Kits—Massey Ferguson®	12
Upholstery Kits—Ford® / New Holland®	4	Upholstery Kits—White® / Oliver® / M&M®	12
Upholstery Kits—International®	4		
Upholstery Kits—John Deere®	5		
Cab Kits	5		

Upholstery Kits—Allis Chalmers®

Application	Description	Part Number	Retail Price
6060, 6070, 6080	Upholstery Kit, 16 Pc. Includes Post Kit	Black AMAC6060UK	\$ 359.00
	Headliner Kit Ships Truck Freight Only Replaces 70275680, 71505372	AMAC6060HLK	\$ 288.00
	Floor Mat	AMAC6080FM	\$ 89.00
7010, 7020, 7040, 7045, 7060, 7080	Upholstery Kit, 16 Pc. For Black Belly Tractors Includes Headliner and Post Kit Replaces 70575936, 70590361	Black AMAC7020UK	\$ 317.00
	Floor Mat	AMAC7000FM	\$ 93.00
7030, 7040, 7050, 7060, 7080	Upholstery Kit, 10 Pc. For Maroon Belly Tractors Includes Headliner	Black AMAC7030UK	\$ 186.00
7580, 8580	Upholstery Kit, 14 Pc. Includes Headliner Replaces 70592520, 70595597	Black AMAC7580UK	\$ 322.00
8010, 8030, 8050, 8070	Upholstery Kit, 7 Pc. Includes Post Kit	Tan AMAC8010UK	\$ 261.00
	Headliner Kit Replaces 70275053, 71503970 Ships Truck Freight Only	Tan AMAC8010HLK	\$ 270.00
	Floor Mat	AMAC8000FM	\$ 140.00
Combines: F2, L, M, M2, M3, N5	Upholstery Kit, 2 Pc. Includes Headliner Replaces 70587158, 71500687, 71500688	Black AMACUK-BL	\$ 224.00
		Brown AMACUK-BR	\$ 225.00
Combines: F2, L, M, M2, M3, N5	Formed Headliner Kit, 1 Pc. Precut Replaces 70587158, 71500687, 71500688	Black Vinyl AMACGHLK	\$ 101.00
		Brindle Brown Vinyl AMACGHLKBR	\$ 143.00

Upholstery

Upholstery Kits—Case®

Application	Description	Part Number	Retail Price
1896, 2094, 2096, 2294, 3294	Qwik Fit Lower Cab Kit, 6 Pc. Includes Headliner, Post Kit and Silicone Sealant Replaces F66022, F66137 Ships Truck Freight Only	Gray AMSS20007	\$ 420.00
2394, 2594, 3394, 3594	Qwik Fit Lower Cab Kit, 6 Pc. Includes Headliner, Post Kit and Silicone Sealant Replaces F66137 Ships Truck Freight Only	Gray AMSS20008	\$ 438.00
770, 870, 970, 1070, 1170, 1175	Upholstery Kit, 11 Pc. Includes Headliner and Post Kit Replaces F63326, F63416 Ships Truck Freight Only	Black AMC970UK	\$ 394.00
	Floor Mat	AMC870FM	\$ 80.00
1270, 1370, 1570	Upholstery Kit, 9 Pc. Includes Headliner and Post Kit Replaces F63416	Black AMC1370UK	\$ 335.00
	Floor Mat	AMC1270FM	\$ 109.00
1896, 2096, 2094, 2294, 3294	Upholstery Kit, 6 Pc. Includes Headliner and Post Kit Replaces F66022, F66137	Gray AMC2094UK	\$ 350.00
	Floor Mat	AMC2094FM	\$ 122.00
2090, 2290	Upholstery Kit, 6 Pc. Includes Headliner and Post Kit Replaces F64434	Black AMC2090UK	\$ 350.00
	Floor Mat	AMC2090FM	\$ 119.00
2394, 2594, 3394, 3594	Upholstery Kit, 6 Pc. Includes Headliner and Post Kit Replaces F66137	Gray AMC2394UK	\$ 350.00
2390, 2590	Upholstery Kit, 4 Pc. Includes Headliner and Post Kit Replaces F64434	Black AMC2390UK	\$ 348.00
2470, 2670	Upholstery Kit, 2-Door, 10 Pc. Includes Headliner and Post Kit Replaces F63416, F64434	Black AMC2470UK-E	\$ 290.00
	Upholstery Kit, 1-Door, 8 Pc. Includes Headliner and Post Kit Replaces F63416, F64434	Black AMC2470UK-L	\$ 358.00
	Floor Mat	AMC2470FM	\$ 112.00
2870, 4490, 4690, 4890	Upholstery Kit, 9 Pc. Includes Headliner and Post Kit Replaces F64434 Ships Truck Freight Only	Black AMC4690UK	\$ 388.00
4494, 4694, 4894, 4994	Upholstery Kit, 8 Pc. Includes Headliner and Post Kit Replaces F66022, F66137, F64782	Gray AMC4494UK	\$ 397.00

Upholstery Kits—Case IH®

Application	Description	Part Number	Retail Price
5120, 5130, 5140, 5150, 5220, 5230, 5240, 5250	Formed Headliner Kit, 1 Pc. Precut Replaces 106303A2, 106303A3 Ships Truck Freight Only	OEM Color AMSS4536	\$ 276.00

Upholstery

Application	Description	Part Number	Retail Price
7110, 7120, 7130, 7140, 7150	Upholstery Kit, 6 Pc.	Gray AMCIH7110UK	\$ 225.00
	Qwik Fit Lower Cab Kit, 5 Pc.	Gray AMSS20003	\$ 270.00
	Lower Panel, Right Hand Plastic Replaces 97076C2	AM1987285C1	\$ 140.00
7110, 7120, 7130, 7140, 7150, 7210, 7220, 7230, 7240, 7250, 8910, 8920, 8930, 8940, 8950	Headliner Kit Mounts w/o glue by snapping into a seal around the ceiling Replaces 96753C1, 97267C4, 97267C5, 240873A1, 1975781C1 Ships Truck Freight Only	OEM Color AMCIH7110HLK	\$ 255.00
	Door Panel Thermoformed gray plastic liner with foam insulation pre-formed pieces, cloth center covering, fastens to the tractor using existing hardware Replaces 97082C5	OEM Gray/Black Matrix Cloth AM97082C6	\$ 211.00
7110, 7120, 7130, 7140, 7150, 7210, 7220, 7230, 7240, 7250, 8910, 8920, 8930, 8940, 8950	Front Lower Panel, Right Hand Below Cab Primer Coated, Ready for Paint	AM1348226C1	\$ 192.00
	Front Lower Panel, Left Hand Below Cab Primer Coated, Ready for Paint	AM96764C2	\$ 192.00
7110, 7120, 7130, 7140, 7150, 7210, 7220, 7230, 7240, 7250, 8910, 8920, 8930, 8940, 8950	Front Lower Cab Post, Right Hand Primer Coated, Ready for Paint	AM96710C1	\$ 192.00
	Front Lower Cab Post, Left Hand Primer Coated, Ready for Paint	AM96709C1	\$ 192.00
7110, 7120, 7130, 7140, 7150, 7230, 7240, 7250, 8910, 8920, 8930, 8940, 8950 - Early w/ 2-Speed Reverse	Corner Post Kit, 6 Pc.	AMCIH7110CPK-E	\$ 260.00
7110, 7120, 7130, 7140, 7150, 7230, 7240, 7250, 8910, 8920, 8930, 8940, 8950 - Late w/ 4-Speed Reverse	Corner Post Kit, 7 Pc. OEM Color	OEM Color AMCIH7110CPK-L	\$ 260.00
7110, 7120, 7130, 7140, 7150, 7230, 7240, 7250, 8910, 8920, 8930, 8940, 8950	Floor Mat	AMCIH7110FM	\$ 73.00
7210, 7220, 7230, 7240, 7250, 8910, 8920, 8930, 8950	Upholstery Kit, 6 Pc.	Gray AMCIH7210UK	\$ 225.00
	Qwik Fit Lower Cab Kit, 6 Pc. Includes Silicone Sealant	Gray AMSS20004	\$ 270.00
7210, 7220, 7230, 7240, 7250, 8910, 8920, 8930, 8940, 8950	Lower Panel, Right Hand	Gray Vinyl AM123399A1	\$ 284.00
9110, 9130, 9150, 9170, 9180, 9190	Upholstery Kit, 5 Pc. Includes Headliner Replaces 60-1853T1, 60-5921T1, 60-5924T1 Ships Truck Freight Only	Gray AMCIH9100UK	\$ 295.00
	Floor Mat	AMCIH9100FM	\$ 144.00
9210, 9230, 9240, 9250, 9260, 9270, 9280, 9310, 9330, 9350	Upholstery Kit, 11 Pc. Includes Headliner and Post Kit Replaces 60-6351T1, 60-5924T1	Gray AMCIH9300UK	\$ 425.00
MX80C, MX90C, MX100, MX100C, MX110, MX120, MX135, MX150, MX170	Upholstery Kit, 3 Pc. Includes Spray Adhesive Headliner Not Included Replaces 241964A2, 248865A4, 292069A2	Gray AMSS4099	\$ 161.00
Combines: 1420, 1440, 1460, 1480	Upholstery Kit, 3 Pc. Includes Headliner Replaces 183682C91	Black AMIH1420UK	\$ 227.00
	Floor Mat	AMIH1420FM	\$ 59.00

Prices Subject to Change without Prior Notice. The use of original equipment manufacturer (OEM) part numbers or trademarks, e.g. Case® and John Deere®, are for reference purposes only and for indicating product use and compatibility. Our company and the listed replacement parts contained herein are not sponsored, approved or manufactured by the OEM. All parts are New unless designated Reman in the description.

Upholstery

Application	Description	Part Number	Retail Price
Combines: 1620, 1640, 1660, 1666, 1680, 1688	Upholstery Kit, 3 Pc.	AMIH1600UK	\$ 101.00
	Floor Mat	AMIH1660FM	\$ 59.00
Combines: 1620, 1640, 1660, 1680, 1688	Headliner Glue Included Replaces 1276232C93, 1329973C93 Ships Truck Freight Only	Gray AMSS4541	\$ 270.00

Upholstery Kits—Ford® / New Holland®

Application	Description	Part Number	Retail Price
5700, 6700, 7700, 7710, 8210, 8700, 9700, TW5, TW10, TW15, TW20, TW25, TW30, TW35	Upholstery Kit, 9 Pc. Tool Box on Left Side of Fender	Black AMF6700UK-BL	\$ 353.00
5700, 6700, 7700, 8700, 9700, TW10, TW20, TW30	Upholstery Kit, 9 Pc. Tool Box on Left Side of Fender Includes Can of Glue	Blue AMF6700UK	\$ 330.00
2600, 3600, 4100, 4600, 5600, 5610, 5700, 6600, 6610, 6700, 6710, 7600, 7700, 7710, 7810, 8210, 8700, 9700, TW5, TW10, TW15, TW20, TW25, TW30, TW35	Headliner Kit Replaces D8NN9451968BB Ships Truck Freight Only	Blue AMF6700HLK	\$ 312.00
5700, 6700, 7700, 7710, 8210, 8700, 9700, TW5, TW10, TW15, TW20, TW25, TW30, TW35	Floor Mat	AMF6700FM	\$ 75.00

Upholstery Kits—International®

Application	Description	Part Number	Retail Price
86 & 88 Series, Hydro 186	Headliner Kit w/ Plastic Backing Replaces 117631C1, 118194C2, 1262101C1 Ships Truck Freight Only	Black AMIH86HLK1	\$ 250.00
	Headliner Kit w/o Plastic Backing	AMIH86HLK	\$ 178.00
766, 866, 966, 1066, 1466, 1566, 1568	Upholstery Kit, 5 Pc. Fits Deluxe Cab, Includes Headliner	AMIH66UK	\$ 241.00
	Cowl Cover, 1 Pc.	AMIH66CC	\$ 148.00
	Floor Mat, Fits Deluxe Cab	AMIH66FM	\$ 112.00
786, 886, 986, 1086, 1486, 1586, 3388, 3588, 3788, Hydro 186	Upholstery Kit, 8 Pc.	Black AMIH86UK	\$ 180.00
	Floor Mat	AMIH86FM	\$ 90.00
886, 986, 1086, 1486, 1586, 3388, 3588, 3788, Hydro 186	Door Handle Pieces Original Western Pattern	Brown AMIH88DHP-W	\$ 175.00
986, 1086, 1486, 1586, 786, 886, 3388, 3588, 3788, Hydro 186	Upholstery Kit Original Western Pattern	Brown AMIH86UK-OW	\$ 210.00
3088, 3288, 3488, 3688, 5088, 5288, 5488, 6388, 6588, 6788	Upholstery Kit, 7 Pc.	Brown AMIH88UKBR	\$ 152.00
	Floor Mat	AMIH88FM	\$ 88.00
5088, 5288, 5488, 3088, 3288, 3488, 3688, 6388, 6588, 6788	Upholstery Kit, 10 Pc. Original Western Pattern	Brown AMIH88UK-OW	\$ 180.00
3088, 3288, 3488, 3688, 6088, 6288, 6488, 6388, 6588, 6788, 7288, 7488	Front Lower Panel, Right Hand	AM143173C3	\$ 212.00
	Front Lower Panel, Left Hand	AM143172C3	\$ 212.00

Upholstery

Upholstery Kits—John Deere®

Upholstery

Cab Kits

Application	Description	Part Number	Retail Price
4030, 4230 BSN 063649, 4430 BSN 063624, 4630 BSN 063329 - w/ Narrow 7" Seat Well	Cab Reconditioning Kit Ships Truck Freight Only	AMJD30CABK-E	\$ 425.00
	Components:		
	Upholstery Kit, 7 Pc.	Black AMJD30UK-E	\$ 185.00
	Formed Headliner Kit, 3 Pc.	Black AMJDHK	\$ 335.00
	Spray Adhesive, 18 oz.	AMGLUE	\$ 32.00
4030, 4230 ASN 063650, 4430 ASN 063625, 4630 ASN 063330 - w/ Wide 11" Seat Well	Cab Reconditioning Kit Ships Truck Freight Only	AMJD30CABK-L	\$ 465.00
	Components:		
	Upholstery Kit, 10 Pc.	Black AMJD40UK	\$ 225.00
	Formed Headliner Kit, 3 Pc.	Black AMJDHK	\$ 335.00
	Spray Adhesive, 18 oz.	AMGLUE	\$ 32.00
4040, 4240, 4440, 4640, 4840 - 1978-80 w/ Cab BSN 4-185706* *Open Face Cabs with Turn Down Door Handle	Cab Reconditioning Kit Ships Truck Freight Only	AMJD40CABK-E	\$ 550.00
	Components:		
	Upholstery Kit, 10 Pc.	Black AMJD40UK	\$ 225.00
	Formed Headliner Kit, 3 Pc.	Black AMJDHK	\$ 335.00
	Corner Post Kit, 4 Pc.	Black AMJD40CPK	\$ 120.00
4040, 4240, 4440, 4640, 4840 - 1981-82 w/ Cab ASN 4-185706* *Closed Face Cabs with Push Button Door Handle	Cab Reconditioning Kit Ships Truck Freight Only	AMJD40CABK-L	\$ 550.00
	Components:		
	Upholstery Kit, 9 Pc.	Black AMJD40UK-L	\$ 225.00
	Formed Headliner Kit, 3 Pc.	Black AMJDHK	\$ 335.00
	Corner Post Kit, 4 Pc.	Black AMJD40CPK	\$ 120.00
4050, 4250, 4450, 4650, 4850	Cab Reconditioning Kit Ships Truck Freight Only	AMJD50CABK	\$ 560.00
	Components:		
	Upholstery Kit, 10 Pc.	Brown AMJD50UK	\$ 255.00
	Formed Headliner Kit, 3 Pc.	Brown AMJD50HLK2W	\$ 325.00
	Corner Post Kit, 4 Pc.	Brown AMJD50CPK	\$ 120.00
4055, 4255, 4455, 4555, 4560, 4755, 4760, 4855, 4955, 4960	Cab Reconditioning Kit Ships Truck Freight Only	AMJD55CABK	\$ 670.00
	Components:		
	Upholstery Kit, 9 Pc.	Tan AMJD55UK-T	\$ 265.00
	Formed Headliner Kit, 3 Pc.	Tan AMJD55HLK	\$ 390.00
	Corner Post Kit, 4 Pc.	Tan AMJD55CPK	\$ 125.00
(6100, 6200, 6300, 6400, 6500 BSN 131952)	Cab Kit, Early, 7 Pc. Thermoformed Plastic	Tan AMSS4605	\$ 750.00
	(6100, 6200, 6300, 6400, 6500 SN 131952-146608)	Cab Kit, Mid, 7 Pc. Thermoformed Plastic	Tan AMSS4606
(6100, 6200, 6300, 6400, 6500 ASN 146608)		Cab Kit, Late, 5 Pc. Thermoformed Plastic	Tan AMSS4607

Upholstery Kits for John Deere®

Upholstery

Upholstery Kits

Application	Description	Part Number	Retail Price
2355, 2555, 2755, 2955, 3055, 3155, 3255, Utility: 2155	Qwik Fit Lower Cab Kit, 8 Pc. Includes Silicone Sealant	Brown AMSS20010	\$ 315.00
	Qwik Fit Lower Cab Kit, 8 Pc. Includes Silicone Sealant	Tan AMSS20011	\$ 315.00
2950, 2955, 3055, 3140, 3150, 3155, 3255	Qwik Fit Lower Cab Kit, 10 Pc. Includes Silicone Sealant	Brown Vinyl AMSS4148	\$ 364.00
4030, 4230, 4430, 4630	Qwik Fit Lower Cab Kit, 11 Pc. Includes Silicone Sealant Ships in 2 Cartons	Black Vinyl AMSS4142	\$ 315.00
(4030, 4230, 4430, 4630 ASN 63623 - w/ 11" Seat Well), (4040*, 4240*, 4440*, 4640*, 4840* BSN 185707) *One piece marked on the back will need to be cut out for correct fit	Qwik Fit Lower Cab Kit, 11 Pc. Includes Silicone Sealant Ships in 2 Cartons	Black Vinyl AMSS4143	\$ 315.00
(4040, 4240, 4440, 4640, 4840 - 1981-82 w/ Cab ASN 4-185706 and All SG22 Cabs)	Qwik Fit Lower Cab Kit, 11 Pc. Includes Silicone Sealant Ships in 2 Cartons	Black Vinyl AMSS4144	\$ 315.00
4050, 4250, 4450, 4650, 4850	Qwik Fit Lower Cab Kit, 11 Pc. Includes Silicone Sealant	Brown Vinyl AMSS4145	\$ 315.00
4055, 4255, 4455, 4555, 4560, 4755, 4760, 4855, 4955, 4960	Qwik Fit Lower Cab Kit, 10 Pc. Includes Silicone Sealant Ships in 2 Cartons	Multi-Brown Vinyl AMSS4146	\$ 315.00
	Qwik Fit Lower Cab Kit, 9 Pc. Includes Silicone Sealant Ships in 2 Cartons	Tan AMSS20009	\$ 390.00
7200, 7210, 7400, 7410, 7510, 7600, 7610, 7700, 7710, 7800, 7810	Qwik Fit Lower Cab Kit, 5 Pc.	Multi-Brown AMSS20016	\$ 310.00
1640, 3040, 2350, 2440, 2550, 2640, 2750, 2840, 2940, 2950, 3140, 3150, Utility: 2240	Upholstery Kit, 8 Pc. Includes Can of Glue	Brown AMJDU50UK	\$ 275.00
2355, 2555, 2755, 2955, 3055, 3155, 3255, Utility: 2155	Upholstery Kit, 8 Pc.	Tan AMJDU55UK-T	\$ 325.00
	Upholstery Kit, 8 Pc.	Brown AMJDU55UK-BR	\$ 325.00
4030, 4230 BSN 063649, 4430 BSN 063624, 4630 BSN 063329 - w/ Narrow 7" Seat Well	Upholstery Kit, 7 Pc. Includes Can of Glue	Black AMJD30UK-E	\$ 185.00
(4030, 4230 ASN 063650, 4430 ASN 063625, 4630 ASN 063330 - w/ Wide 11" Seat Well), (4040, 4240, 4440, 4640 - 1978- 80 w/ Cab BSN 4-185706*) *Open Face Cabs with Turn Down Door Handle	Upholstery Kit, 10 Pc. Includes Can of Glue	Black AMJD40UK	\$ 225.00
4040, 4240, 4440, 4640, 4840 - 1981-82 w/ Cab ASN 4-185706* *Closed Face Cabs with Push Button Door Handle	Upholstery Kit, 9 Pc. Includes Can of Glue	Black AMJD40UK-L	\$ 225.00
4050, 4250, 4450, 4650, 4850	Upholstery Kit, 10 Pc.	Brown AMJD50UK	\$ 255.00
4055, 4255, 4455, 4555, 4560, 4755, 4760, 4855, 4955, 4960	Upholstery Kit, 9 Pc.	Brown AMJD55UK	\$ 265.00
	Upholstery Kit, 9 Pc.	Tan AMJD55UK-T	\$ 265.00
7200, 7210, 7400, 7410, 7510, 7600, 7610, 7700, 7710, 7800, 7810	Upholstery Kit, 6 Pc.	Multi-Brown AMSS4212	\$ 160.00
8430, 8630	Upholstery Kit, 6 Pc. Includes Can of Glue	Black AMJD8430UK	\$ 205.00
8440, 8640	Upholstery Kit, 9 Pc. Includes Can of Glue Ships Truck Freight Only	Black AMJD8640UK4	\$ 360.00
8450, 8650, 8850	Upholstery Kit, 13 Pc. Includes 2 Cans of Glue	Brown AMJD504WDUK	\$ 455.00

Upholstery Kits for John Deere®

Upholstery

Application	Description	Part Number	Retail Price
8560, 8570, 8760, 8770, 8870, 8960, 8970	Upholstery Kit, 11 Pc.	Sailcloth Multi-Brown/Tan AMJD604WDUK	\$ 490.00
Combines: 6600, 7700	Upholstery Kit, 11 Pc. Includes Headliner and Can of Glue	Black AMJD6600UK	\$ 200.00
Combines: 6620, 7720, 8820	Upholstery Kit, 8 Pc. Includes 1 Can of Glue	Black AMJD6620UK	\$ 150.00
Combines: 9400, 9410, 9450, 9500, 9500SH, 9510, 9510SH, 9550, 9550SH, 9560, 9560STS, 9600, 9610, 9650, 9650CTS, 9660STS, 9600CTS, 9660STS, 9750STS, 9760STS, 9860STS, CTS, CTS II	Upholstery Kit, 3 Pc.	Camel Hair Tan Cloth AMSS4193	\$ 275.00

Headliners

Application	Description	Part Number	Retail Price
1640, 2040, 2140, 2350, 2355, 2440, 2550, 2555, 2640, 2750, 2755, 2840, 2940, 2950, 3040, 3055, 3140, 3150, 3155, 3255, 4050, 4250, 4450, 4650, 4850, Utility: 2240	Formed Headliner Kit, 3 Pc. Replaces AL56234, AR97386, RE10595 Ships Truck Freight Only	Brown AMJD50HLK2W	\$ 325.00
2355, 2555, 2755, 2955, 3055, 3155, 3255, Utility: 2155	Formed Headliner Kit, 3 Pc. Precut, Square Speaker Holes Ships Truck Freight Only	Sailcloth Tan Vinyl AMJD55HLK-E	\$ 357.00
2355, 2555, 2755, 2955, 3055, 3155, 3255, 4055, 4255, 4455, 4555, 4650, 4650, 4755, 4760, 4955, 4960	Formed Headliner Kit, 3 Pc. Precut, Round Speaker Holes Replaces AL69687, RE10595, RE37757, RE37820 Ships Truck Freight Only	Tan AMJD55HLK	\$ 390.00
4030, 4040, 4230, 4240, 4430, 4440, 4630, 4640, 4840	Formed Headliner Kit, 3 Pc. Replaces AR84216, AR56683, AR78419, RE223616, RE223614 Ships Truck Freight Only	Black AMJDHK	\$ 335.00
6100, 6110, 6200, 6210, 6300, 6310, 6400, 6410, 6500, 6510	Formed Headliner Kit, 1 Pc. Precut, Perforated Replaces AL111939, L113585, L113378 Ships Truck Freight Only	Sailcloth Tan Vinyl AMJD6100HLK	\$ 290.00
	Formed Headliner Kit, 1 Pc. Precut Replaces L113584, L113378 Ships Truck Freight Only	Camel Hair Tan Cloth AMSS4548	\$ 297.00
7200, 7210, 7400, 7410, 7510, 7600, (7610, 7710, 7810 BSN 089999), 7700, 7800	Formed Headliner Kit, 1 Pc. Precut, Perforated Replaces RE43477, RE56824 Ships Truck Freight Only	Sailcloth Tan Vinyl AMJD7200HLK	\$ 300.00
	Formed Headliner Kit, 1 Pc. Precut, Non-Perforated Replaces RE183605 Ships Truck Freight Only	Camel Hair Tan Cloth AMSS4549	\$ 300.00
8100, 8100T, 8110, 8110T, 8120, 8200, 8200T, 8210, 8210T, 8220, 8300, 8300T, 8310, 8310T, 8320, 8400, 8400T, 8410, 8410T, 8420, 9100, 9120, 9200, 9220, (9230, 9320, 9330, 9430, 9530, 9630 - w/ Manual Shift Transmission), 9300, 9300T, 9320T, 9400, 9400T, 9410, 9420, 9420T, 9520, 9520T, 9620, 9620T, Sprayers: 4700, 4710	Formed Headliner Kit, 1 Pc. Precut, Perforated Replaces RE183607, R190667, R193110, R193111, R231286 Ships Truck Freight Only	Sailcloth Tan Vinyl AMSS4571	\$ 315.00

Upholstery Kits for John Deere®

Upholstery

Application	Description	Part Number	Retail Price
8100, 8100T, 8110, 8110T, 8120, 8200, 8200T, 8210, 8210T, 8220, 8300, 8300T, 8310, 8310T, 8320, 8400, 8400T, 8410, 8410T, 8420, (9100, 9220, 9320, 9420, 9520, 9620 BSN 039999), 9120, 9200, 9300, 9300T, 9320T, 9400, 9400T, 9410, 9420T, 9520T, 9620T, Sprayers: 4700, 4710	Formed Headliner Kit, 1 Pc. Precut, Non-Perforated Replaces R124252, R134109, RE183606, RE183607 Ships Truck Freight Only	Camel Hair Tan Cloth AMSS4572	\$ 315.00
8430, 8440, 8630, 8640	Headliner Kit, 3 Pc. Replaces AR69710, AR70126, AR78420, AR84261, RE223614, RE223618 Ships Truck Freight Only	Black AMJD304WDHLK	\$ 335.00
8450, 8650, 8850 - 4WD	Headliner Kit, 3 Pc. Replaces AR96455, RE10595 Ships Truck Freight Only	Brown AMJD50HLK	\$ 335.00
8560, 8570, 8760, 8770, 8870, 8960, 8970	Headliner Kit, 1 Pc. Replaces RE24542, RE47052 Ships Truck Freight Only	Sailcloth Tan AMJD60HLK	\$ 375.00
9100, 9120, 9200, 9220, (9230, 9320, 9330, 9430, 9530, 9630 - w/ Manual Shift Transmission), 9300, 9300T, 9320T, 9400, 9400T, 9420, 9420T, 9520, 9520T, 9620, 9620T	Formed Headliner Kit, 1 Pc. Precut Ships Truck Freight Only Replaces RE183607, R190667, R193111, R231286	Camel Hair Tan Cloth AMSS20014	\$ 310.00
Combines: 6600, 7700	Headliner Kit, 3 Pc. Replaces AH86562, AH86827, AH86826, AH86828, AH96288	Black AMJD6600HLK	\$ 188.00
Combines: 6620, 7720, 8820	Headliner Kit, 2 Pc. Replaces H96824, H97222 Ships Freight Truck Only	Black AMJD6620HLK	\$ 310.00
2355, 2555, 2755, 2955, 3055, 3155, 3255, Utility: 2155	Formed Headliner, Front Panel Replaces AL37216	Sailcloth Tan Vinyl AMSS4539	\$ 135.00
2040, 2350, 2355, 2440, 2550, 2555, 2640, 2750, 2840, 2940, 2950, 3150, 4050, 4250, 4450, 4650, 4850, 8450, 8650, 8850, Utility: 2240	Formed Headliner, 1 Pc. Precut, Main Panel Replaces RE10595 Ships Truck Freight Only	Multi-Brown Vinyl AMSS4515	\$ 225.00
4055, 4255, 4455, 4555, 4560, 4755, 4760, 4955, 4960	Formed Headliner, Front Panel Replaces RE33512, RE37865, RE50168	Sailcloth Tan Vinyl AMSS4531	\$ 145.00
6120, 6220, 6230, 6420, 6320, 6330, 6430, 7130, 7220, 7230, 7320, 7330, 7420, 7430, 7520, 7530	Headliner For Premium Cabs w/ Radio in Front, Centered Between Speakers Ships Truck Freight Only Replaces AL160596, AL181842	Tan Cloth AMAL207905	\$ 425.00
8130, 8230, 8230T, 8330, 8330T, 8430, 8430T, 8530, 9230, 9330, 9430, 9430T, 9530, 9530T, 9630, 9630T, Sprayers: 4720, 4730, 4830, 4930	Headliner Ships Truck Freight Only	Camel Hair Tan Cloth AMR244138	\$ 350.00
Combines: 9400, 9410, 9450, 9500, 9500SH, 9510, 9510SH, 9550, 9550SH, 9560, 9560STS, 9600, 9610, 9650, 9650CTS, 9650STS, 9660, 9660CTS, 9660STS, 9750STS, 9760STS, 9860STS, CTS, CTS II	Formed Headliner, Front Panel For Models w/o Factory Visor Ships Truck Freight Only	Sailcloth Tan Vinyl AMSS4558	\$ 181.00
Combines: 9400, 9410, 9500, 9510, 9510SH, 9550, 9550SH, 9560, 9560STS, 9600, 9610, 9650, 9650CTS, 9650STS, 9660, 9660CTS, 9660STS, 9750STS, 9760STS, CTS, CTS II	Formed Headliner, Front Panel w/ Visor Replaces AH120887	Camel Hair Tan Cloth AMSS4561	\$ 195.00
9660STS, 9750STS, 9760STS, 9860STS, CTS, CTS II	Formed Headliner, Front Panel w/ Visor Replaces AH153911, AH159238, AH207961	Camel Hair Tan Cloth AMSS4562	\$ 195.00

Upholstery Kits for John Deere®

Upholstery

Application	Description	Part Number	Retail Price
Combines: 9400, 9410, 9500, 9500SH, 9510, 9510SH, 9600, 9610, CTS, CTS II - Early	Formed Headliner, Main Panel For models w/o a factory visor, w/ dome light directly above operator's head Replaces AH120888, AH136326, AH152873 Ships Truck Freight Only	Camel Hair Tan Cloth AMSS4559	\$ 360.00
Combines: 9400, 9410, 9500, 9500SH, 9510, 9510SH, 9600, 9610, CTS, CTS II - Late	Formed Headliner, Main Panel For models w/ a factory visor, w/ dome light offset to the front right of the cab Replaces AH149882 Ships Truck Freight Only	Camel Hair Tan Cloth AMSS4560	\$ 360.00
Combines: 9450, 9550, 9550SH, 9560, 9560STS, 9650, 9650CTS, 9650STS, 9660, 9660CTS, 9660STS, 9750STS, 9760STS, 9860STS - Late	Headliner, Main Panel Replaces AH159236, AH207960 Ships Truck Freight Only	Camel Hair Tan Cloth AMSS4568	\$ 360.00
Combines: 9400, 9410, 9450, 9500, 9500SH, 9510, 9510SH, 9500, 9550SH, 9560, 9560SH, 9600, 9610, 9650, 9560CTS, 9650STS, 9660CTS, 9660STS, 9750STS, 9760STS, CTS, CTS II	Formed Headliner, Rear Panel Replaces AH120889, AH146852, AH149883, AH207955	Camel Hair Tan Cloth AMSS4563	\$ 210.00
2WD: 4030, 4040, 4230, 4240, 4430, 4440, 4630, 4640, 4840, 4WD: 8430, 8440, 8630, 8640	Headliner Filter Door Panel Replaces AR58153, AR83435, RE223615	Black AMSS4505	\$ 58.00
4050, 4250, 4450, 4650, 4850, 8450, 8650, 8850	Headliner Filter Door Panel, Brown	Brown AMSS4516	\$ 55.00

Corner Post Kits

Application	Description	Part Number	Retail Price
2040, 2350, 2355, 2440, 2550, 2555, 2640, 2750, 2755, 2840, 2950, 2955, 3055, 3150, 3155, 3255, Utility: 2155, 2240	Qwik Fit Corner Post Kit, 4 Pc. Silicone Sealant Included	Brown Vinyl AMSS4153	\$ 160.00
(4030, 4040, 4230, 4240, 4430, 4440, 4630, 4640, 4840 BSN 185707)	Qwik Fit Corner Post Kit, 4 Pc. Silicone Sealant Included	Black Vinyl AMSS4149	\$ 160.00
(4040, 4240, 4440, 4640, 4840 - w/ Cab ASN 4-185707, 1981-82)	Qwik Fit Corner Post Kit, 4 Pc. Silicone Sealant Included	Black Vinyl AMSS4150	\$ 160.00
4050, 4250, 4450, 4650, 4850	Qwik Fit Corner Post Kit, 4 Pc. Silicone Sealant Included	Brown Vinyl AMSS4151	\$ 160.00
4055, 4255, 4455, 4555, 4560, 4755, 4760, 4855, 4955, 4960	Qwik Fit Corner Post Kit, 4 Pc. Silicone Sealant Included	Brown Vinyl AMSS4152	\$ 160.00
7200, 7210, 7400, 7410, 7510, 7600, 7610, 7700, 7710, 7800, 7810	Qwik Fit Corner Post Kit, 6 Pc. Includes Silicone Sealant Ships in 2 Cartons	Brown AMSS20001	\$ 182.00
8430, 8630	Qwik Fit Corner Post Kit, 5 Pc. Includes Silicone Sealant	Black AMSS20005	\$ 175.00
8440, 8640	Qwik Fit Corner Post Kit, 5 Pc. Includes Silicone Sealant	Black AMSS20006	\$ 156.00
8450, 8650, 8850	Qwik Fit Corner Post Kit, 5 Pc. Includes Silicone Sealant	Brown AMSS20000	\$ 175.00
1640, 2040, 2350, 2355, 2440, 2450, 2550, 2555, 2640, 2650, 2750, 2755, 2840, 2850, 2940, 2950, 2955, 3040, 3050, 3055, 3140, 3150, 3155, 3255, 3350, 3640, 3650, Utility: 2240	Corner Post Kit, 5 Pc. Includes 1 Can of Glue	Brown AMJDU50CPK	\$ 110.00
4040, 4240, 4440, 4640, 4840	Corner Post Kit, 4 Pc.	Black AMJD40CPK	\$ 120.00

Upholstery

Application	Description	Part Number	Retail Price
4030, 4040, 4230, 4240, 4430, 4440, 4630, 4640, 4840 - 2WD	Corner Post Kit, 5 Pc. Includes 1 Can of Glue	Black AMJD30CPK	\$ 110.00
4050, 4250, 4450, 4650, 4850	Corner Post Kit, 4 Pc.	Brown AMJD50CPK	\$ 120.00
4055, 4255, 4455, 4555, 4560, 4755, 4760, 4855, 4955, 4960	Corner Post Kit, 4 Pc. Includes 1 Can of Glue	Tan AMJD55CPK	\$ 125.00
6100, 6200, 6300, 6400, 6500	Corner Post Kit, 6 Pc. Thermoformed Plastic	Tan AMSS4604	\$ 280.00
7200, 7210, 7400, 7410, 7510, 7600, 7610, 7700, 7710, 7800, 7810	Corner Post Kit, 6 Pc.	Brown AMSS4213	\$ 125.00
(8100, 8200, 8300, 8400 ASN 010000), 8100T, 8110, 8110T, 8120, 8120T, 8200T, 8210, 8210T, 8220, 8220T, 8300T, 8310, 8310T, 8320, 8320T, 8400T w/ Air Vent Only, 8410, 8410T, 8420, 8420T, 9100, 9200, 9300, 9300T, 9400, 9400T	Corner Post Kit, Rear Replaces R257815	Tan Vinyl AMR127857	\$ 120.00
(8100, 8200, 8300, 8400 BSN 010001), 9100, 9120, 9200, 9220, 9300, 9320, 9400, 9400T, 9420, 9520, 9620	Corner Post Kit, Rear	Tan Vinyl AMSS20012	\$ 100.00
8130, 8230, 8230T, 8330, 8330T, 8430, 8430T, 8530	Corner Post Kit, Rear Replaces R127858, R257815, R257816	Tan Vinyl AMSS20013	\$ 100.00
8430, 8630	Corner Post Kit, 5 Pc. Includes 1 Can of Glue	Black AMJD304WDCPK	\$ 139.00
8440, 8640	Corner Post Kit, 4 Pc. Includes 1 Can of Glue	Black AMJD40CPK4	\$ 100.00
8450, 8650, 8850 - 4WD	Corner Post Kit, 4 Pc. Includes 1 Can of Glue	Brown AMJD50CPK4WD	\$ 100.00
8560 BSN 003100 or w/ Cab BSN 002288, 8760 BSN 005100 or w/ Cab BSN 002288, 8960 BSN 004100 or w/ Cab BSN 002288	Corner Post Kit, 6 Pc. Right Hand Post Covers Do Not Include Holes for Plastic Plugs or Monitor Bracket	Tan Cloth AMSS20018	\$ 285.00
8560 ASN 003101 or w/ Cab ASN 002289, 8570, 8760 ASN 005101 or w/ Cab ASN 002289, 8770, 8870, 8960 ASN 004101 or w/ Cab ASN 002289, 8970	Corner Post Kit, 6 Pc. Right Hand Post Covers Include 2 Holes for Plastic Plugs or Monitor Brackets	Tan Cloth AMSS20019	\$ 285.00

Floor Mats, Fenders and Misc

Application	Description	Part Number	Retail Price
2355, 2555, 2755, 2955, 3155, 3255, 4055, 4255, 4455, 4555, 4560, 4755, 4760, 4855, 4955, 4960, Utility: 2155	Cowl Cover, 1 Pc.	Multi-Brown AMJD55CC	\$ 190.00
	Cowl Cover 1 Pc.	Sailcloth Tan AMSS4176	\$ 185.00
(2350, 2355, 2440, 2550, 2555, 2640, 2750, 2755, 2840, 2940, 2950, 2955, 3040, 3140, 3150, 3155, 3255, 4050, 4250, 4450, 4650, 4850 - 2WD and 4WD), (8450, 8650, 8850 - 4WD)	Cowl Cover, 1 Pc.	Brown AMJD50CC	\$ 193.00
4030, 4040, 4230, 4240, 4430, 4440, 4630, 4640, 4840, 8430, 8440, 8630, 8640	Cowl Cover, 1 Pc.	Black AMJD40CC	\$ 205.00
8560, 8570, 8760, 8770, 8960, 8970	Cowl Cover, 1 Pc.	Black AMSS4553	\$ 75.00
	Cowl Cover, 1Pc. Premium Plastic	Black AMSS20017	\$ 225.00
4030, 4040, 4050, 4055, 4230, 4240, 4250, 4255, 4430, 4440, 4450, 4455, 4560, 4630, 4640, 4650, 4755, 4760, 4840, 4850, 4955, 4960	Floor Mat	AMJD30FM	\$ 85.00
4030, 4230, 4430, 4630	MudMat 0.70" Thick Replaces R50761	AMSS20020	\$ 120.00

Upholstery Kits for John Deere®

Upholstery

Upholstery

Upholstery Kits for John Deere®

Application	Description	Part Number	Retail Price
4040, 4050, 4240, 4250, 4440, 4450, 4640, 4650, 4840, 4850	MudMat 0.09" Thick Replaces R98135	AMSS20021	\$ 120.00
4050, 4055, 4250, 4255, 4450, 4455, 4555, 4650, 4755, 4850, 4955	MudMat 0.09" Thick Replaces R98135	AMSS20022	\$ 120.00
6110, 6200, 6210, 6300, 6310, 6310S, 6400, 6410, 6410S, 6500, 6510S, 6605	MudMat 0.125" Thick Replaces L79044	AMSS20023	\$ 125.00
7110, 7120, 7130, 7140, 7150, 7230, 7240, 7250, 8910, 8920, 8930, 8940, 8950	MudMat Replaces 1340289C1	AMSS20028	\$ 125.00
7200, 7210, 7400, 7410, 7510, 7600, 7610 BSN 089999, 7700, 7710, 7800, 7810	MudMat 0.09" Thick Replaces R111634, R118025, R170498 Ships Truck Freight Only	AMSS20024	\$ 125.00
8100, 8100T, 8110, 8110T, 8120, 8120T, 8200, 8200T, 8210, 8210T, 8220, 8220T, 8300, 8300T, 8310, 8310T, 8320, 8320T, 8400, 8400T, 8410, 8410T, 8420, 8420T, 8520, 8520T, Sprayers: 4700, 4710, 4720, 4730, 4830, 4920, 4930	MudMat 0.09" Thick Replaces R155817	AMSS20025	\$ 125.00
Combines: 9400, 9410, 9450, 9500, 9500SH, 9510, 9510SH, 9550, 9550SH, 9600, 9610, 9650, 9650CTS, 9650STS, 9750STS, CTS, CTS II, Cotton Picker: 9986	MudMat 0.125" Thick Replaces AH159079, AH165073	AMSS20027	\$ 125.00
5055E, 5065E, 5075E, 9100, 9120, 9200, 9220, 9300, 9300T, 9320, 9320T, 9400, 9400T, 9420, 9420T, 9520, 9520T, 9620, 9620T	Right Console Replaces RE70203, RE190696	Multi-Brown AMRE221582	\$ 205.00
8100, 8110, 8110T, 8120, 8120T, 8200, 8200T, 8210, 8210T, 8220, 8220T, 8300, 8300T, 8310, 8310T, 8320, 8320T, 8400, 8400T, 8410, 8410T, 8420, 8420T	Right Console Larger 5" x 6" cutout	Multi-Brown AMR124207	\$ 120.00
	Right Console For Vent Only	AMR221552	\$ 180.00
8110, 8120, 8120T, 8210, 8220, 8220T, 8310, 8320, 8320T, 8410, 8420, 8420T	Right Console Smaller 2" x 4.25" cutout w/ divot	Multi-Brown AMSS4233	\$ 125.00
8130, 8230, 8230T, 8330, 8330T, 8430, 8430T, 8530, 9230, 9330, 9430, 9430T, 9530, 9530T, 9630, 9630T	Right Console Replaces RE227865	Multi-Brown Vinyl AMRE226720	\$ 240.00
6100, 6110, 6200, 6210, 6300, 6310, 6400, 6410, 6500, 6510	Fender Panel, Left Hand Thermoformed Plastic	Multi-Brown AMSS4242	\$ 246.00
7200, 7210, 7400, 7410, 7510, 7600, 7610, 7700, 7710, 7800, 7810	Fender Panel, Left Hand Thermoformed Plastic	Multi-Brown AMSS4201	\$ 249.00
7630, 7720, 7730, 7820, 7830, 7920, 7930, 8130, 8230, 8230T, 8330, 8330T, 8430, 8430T, 8530, 9430, 9430T, 9530T, 9630T	Fender Panel, Left Hand For use w/ Buddy Seat	Multi-Brown AMRE221542	\$ 265.00
7630, 7720, 7730, 7820, 7830, 7920, 7930, 8130, 8230, 8230T, 8330, 8330T, 8430, 8430T, 8530, 9430T, 9530T, 9630T	Fender Panel, Left Hand For use w/ Field Office	Multi-Brown Vinyl AMRE221543	\$ 265.00
7630, 7720, 7730, 7820, 7830, 7920, 7930, 8130, 8230, 8230T, 8330, 8330T, 8430, 8430T, 8530, 9430T, 9530T, 9630T, Sprayer: 4940	Fender Panel, Left Hand w/ Cup Holder	Multi-Brown AMRE221541	\$ 265.00
8100, 8100T, 8110, 8110T, 8120, 8120T, 8200, 8200T, 8210, 8210T, 8220, 8220T, 8300, 8300T, 8310, 8310T, 8320, 8320T, 8400, 8400T, 8410, 8410T, 8420, 8420T, 8520, 8520T, 9300T, 9320T, 9400T, 9420T, 9520T, 9620T	Fender Panel, Left Hand For use w/ Buddy Seat Replaces RE166409, RE174406	Multi-Brown AMRE221551	\$ 280.00
	Fender Panel, Left Hand w/ Cup Holder	Multi-Brown AMRE221549	\$ 284.00
	Fender Panel, Left Hand For use w/ Field Office	Multi-Brown AMRE174405	\$ 282.00
	Fender Panel, Left Hand Generic	Multi-Brown AMSS4229	\$ 288.00

Upholstery

Application	Description	Part Number	Retail Price
9100, 9120, 9200, 9220, 9300, 9320, 9400, 9420, 9520, 9620	Fender Panel, Left Hand For use w/ Buddy Seat Replaces RE177544	Multi-Brown AMRE221581	\$ 245.00
	Fender Panel, Left Hand w/ Cup Holder Replaces RE166406, RE177542	Multi-Brown AMRE221579	\$ 245.00
	Fender Panel, Left Hand For use w/ Field Office Replaces RE129095, RE166405, RE177543	Multi-Brown Vinyl AMRE221580	\$ 245.00
9230, 9330, 9430, 9430T, 9530, 9530T, 9630, 9630T	Fender Panel, Left Hand For use w/ Buddy Seat	Multi-Brown AMRE227856	\$ 235.00
9230, 9330, 9430, 9530, 9630	Fender Panel, Left Hand w/ Cup Holder	Multi-Brown AMRE227858	\$ 195.00
	Fender Panel, Left Hand For use w/ Field Office	Multi-Brown AMRE227857	\$ 235.00
8100, 8100T, 8200, 8200T, 8300, 8300T, 8400, 8400T, 9100, 9200, 9300, 9300T, 9400, 9400T	Rear Panel Mid-Style, 1-Hole	Multi-Brown AMR151327	\$ 155.00
	Rear Panel Early Style, 2-Hole	Multi-Brown AMR124191	\$ 155.00
8110, 8110T, 8120, 8120T, 8210, 8210T, 8220, 8220T, 8310, 8310T, 8320, 8320T, 8410, 8410T, 8420, 8420T, 8520, 8520T, 9120, 9220, 9300T, 9320, 9400T, 9420, 9520, 9620, Sprayer: 4700	Rear Panel Late, Bulged or Curved Rear Panel Replaces RE168878	Multi-Brown AMRE221548	\$ 165.00
8110, 8120, 8120T, 8210, 8220, 8220T, 8310, 8320, 8320T, 8410, 8420, 8420T	Rear Panel	Multi-Brown AMSS4234	\$ 170.00
8130, 8230, 8230T, 8330, 8330T, 8430, 8430T, 8530, 9230, 9330, 9430, 9430T, 9530, 9530T, 9630, 9630T	Rear Panel	Multi-Brown AMR227863	\$ 185.00

Upholstery Kits—Massey Ferguson®

Application	Description	Part Number	Retail Price
1085, 1105, 1135, 1155	Upholstery Kit, 3 Pc. Includes Headliner Kit Replaces 529286M1	Black AMMF1105UK	\$ 178.00
2475, 2675, 2705, 2770, 2775, 2800, 2805	Upholstery Kit, 5 Pc. Includes Headliner Kit Replaces 1627476M2	Black AMMF2705UK	\$ 238.00

Upholstery Kits—White® / Oliver® / M&M®

Application	Description	Part Number	Retail Price
White®: 2-85, 2-105	Floor Mat	AMW2-85FM	\$ 80.00
White®: 2-85, 2-105, 2-150	Upholstery Kit, 6 Pc. Includes Headliner Ships Truck Freight Only	Red Vinyl AMW2-105UK	\$ 293.00
White®: 2-135, 2-155, 2-180	Upholstery Kit, 9 Pc. Includes Headliner Replaces 30-3173526	Red AMW2-135UK	\$ 480.00
White®: 2-88, 2-110, 2-135, 2-155, 2-180 - Series III	Upholstery Kit, 15 Pc. Includes Post Kit	Red AMW2-110UKIII	\$ 460.00
White®: 2-88, 2-110, 2-135, 2-155, 2-180 - Series III	Headliner Kit, 1 Pc. Ships Freight Truck Only	Red AMW2-110HLKIII	\$ 325.00

Upholstery

Cab Upholstery Foam Material

Application	Description	Part Number	Retail Price
	Bulk Cab Upholstery Foam 54" Wide - Small Perforation 1" Thick, Priced Per Foot	Black FM0153	\$ 18.00
	Bulk Cab Upholstery Foam 54" Wide - Small Perforations, 1" Thick, Priced Per Foot	Western Brown AMSS20002	\$ 18.00
	Spray Adhesive, 18 oz.	AMGLUE	\$ 32.00

Floor Mat Material

Application	Description	Part Number	Retail Price
	Bulk Floor Mat Material 60" Wide, Priced Per Foot	Black AM9500BFM	\$ 39.00

Seats and Suspensions

Table of Contents

Allis Chalmers®—Seats and Suspensions.....	15	John Deere®—Seats and Suspensions	61
Seats	15	Seats	61
Complete Seats	15	Buddy Seats	68
Seat and Suspension Components	20	Complete Seats	61
Seat Tops and Cushions.....	16	Seat and Suspension Components	79
Suspensions	18	Seat Cushions	72
Case®—Seats and Suspensions	21	Seat Tops.....	70
Seats	21	Suspensions	75
Complete Seats	21	Kubota®—Seats and Suspensions	87
Seat and Suspension Components	25	Seats	87
Seat Tops and Cushions.....	22	Complete Seats	87
Suspensions	23	Seat and Suspension Components	90
Case IH®—Seats and Suspensions.....	26	Seat Tops.....	87
Seats	26	Suspensions	89
Buddy Seats	32	Massey Ferguson®—Seats and Suspensions	92
Complete Seats	26	Seats	92
Seat and Suspension Components	38	Complete Seats	92
Seat Cushions	35	Seat and Suspension Components	98
Seat Tops.....	33	Seat Tops and Cushions.....	94
Suspensions	36	Suspensions	96
Ford® / New Holland®—Seats and Suspensions	42	White® / Oliver® / M&M®—Seats and Suspensions.....	99
Seats	42	Seats	99
Complete Seats	42	Complete Seats	99
Seat and Suspension Components	50	Seat and Suspension Components	104
Seat Cushions	47	Seat Tops and Cushions.....	101
Seat Tops.....	44	Suspensions	102
Suspensions	48	Industrial / Construction / Turf.....	105
International®—Seats and Suspensions.....	53	Seats	105
Seats	53	Complete Seats	105
Complete Seats	53	Seat and Suspensions Components	111
Seat and Suspension Components	59	Seat Tops and Cushions.....	107
Seat Tops and Cushions.....	54	Suspensions	110
Suspensions	56		
Suspension—560	60		

Allis Chalmers®—Seats and Suspensions

Seats

Complete Seats

	Application	Description		Part Number	Retail Price
	8010, 8030, 8050, 8070	Seat and Suspension Assembly <ul style="list-style-type: none"> • Plug-and-play • Grammer MSG95 air suspension • Durable black/gray matrix fabric covering • Armrests • Backrest extension for extra backrest height • Suspension stroke of 100 mm • Weight adjustment from 110 to 285 lbs • Fore/aft adjustment • Height adjustment • Operator presence switch Includes Grammer 731 Seat, Grammer MSG95 Air Suspension, Mounting Hardware and Installation Instructions	Black/Gray Matrix Fabric	AMSS10035	\$ 1024.00
	8010, 8030, 8050, 8070	Seat and Suspension Assembly <ul style="list-style-type: none"> • Grammer MSG85 compact mechanical suspension • Durable black/gray matrix fabric covering • Armrests • Backrest extension for extra backrest height • Suspension travel of 4" • Fore/aft isolator • Suspension stroke up to 7" • Flip-handle weight adjustment from 110 to 285 lbs • Weight indicator • Three-position height adjustment of 3" • Frame width of 11.75" Includes Grammer 731 Seat, Grammer MSG85 Compact Mechanical Suspension, Mounting Hardware and Installation Instructions	Black/Gray Matrix Fabric	AMSS10036	\$ 847.00
	6060, 6080, 7000, 7010, 7020, 7030, 7040, 7045, 7050, 7060, 7080, Deutz-Allis®: 7085	Seat and Suspension Assembly <ul style="list-style-type: none"> • Plug-and-play • Grammer MSG95 air suspension • Durable black/gray matrix fabric covering • Armrests • Backrest extension for extra backrest height • Suspension stroke of 100 mm • Weight adjustment from 110 to 285 lbs • Fore/aft adjustment • Height adjustment • Operator presence switch Includes Grammer 731 Seat, Grammer MSG95 Air Suspension, Pedestal, Mounting Hardware and Installation Instructions	Black/Gray Matrix Fabric	AMSS10033	\$ 1024.00
	6060, 6080, 7000, 7010, 7020, 7030, 7040, 7045, 7050, 7060, 7080, Deutz-Allis®: 7085	Seat and Suspension Assembly <ul style="list-style-type: none"> • Grammer MSG85 compact mechanical suspension • Durable black/gray matrix fabric covering • Armrests • Backrest extension for extra backrest height • Suspension travel of 4" • Fore/aft isolator • Suspension stroke up to 7" • Flip-handle weight adjustment from 110 to 285 lbs • Weight indicator • Three-position height adjustment of 3" • Frame width of 11.75" Includes Grammer 731 Seat, Grammer MSG85 Compact Mechanical Suspension, Pedestal, Mounting Hardware and Installation Instructions	Black/Gray Matrix Fabric	AMSS10034	\$ 847.00





Allis Chalmers®—Seats

Seats and Suspensions

Allis Chalmers®—Seats and Suspensions









Application	Description		Part Number	Retail Price	
	Most Models	Seat and Suspension Assembly	Black/Gray Matrix Fabric	AMSS11063	\$ 965.00
		• Grammer MSG83 compact mechanical suspension	Black Vinyl	AMSS11064	\$ 914.00
		• Black/gray matrix fabric option includes backrest extension			
		• Black/vinyl option does not include backrest extension			
	• Armrests				
	• Front weight indicator				
	• Flip-handle weight adjustment				
	• Suspension travel of 3.10"				
	• Frame width of 8.92"				
	• Three-position height adjustment				
	Includes Grammer 721 Seat and Grammer MSG83 Mechanical Suspension				
	Backrest Extension		Black Vinyl	AM1092126	\$ 89.00
	Seat Belt, Retractable			AM902133	\$ 103.00
For Grammer DS44/1HB Seat Assemblies	Seat and Suspension Assembly		Black Vinyl	AM2049435	\$ 316.00

Seat Tops and Cushions

Application	Description		Part Number	Retail Price	
	For Grammer Suspensions	Seat Assembly	Black/Gray Matrix Fabric	AMSS11052	\$ 730.00
		• Grammer 742 tall back seat			
	• Durable black/gray matrix fabric covering				
	• Armrests				
	• Operator presence switch				
	Seat Assembly w/ Swivel		Black/Gray Matrix Fabric	AMSS11054	\$ 790.00
	For Grammer Suspensions	Seat Assembly	Black/Gray Matrix Fabric	AMSS11051	\$ 657.00
		• Grammer 741 seat			
	• Durable black/gray matrix fabric covering				
	• Armrests				
	• Backrest extension for extra backrest height				
	• Operator presence switch				
	Seat Assembly w/ Swivel		Black/Gray Matrix Fabric	AMSS11053	\$ 724.00
	For Grammer Suspensions	Seat Assembly	Black/Gray Matrix Fabric	AMSS11007	\$ 526.00
		• Grammer 731 seat			
	• Durable black/gray matrix fabric covering				
	• Armrests				
	• Backrest extension for extra backrest height				
	Seat Assembly w/ Swivel		Black/Gray Matrix Fabric	AMSS11033	\$ 675.00
	For Grammer Suspensions	Seat Assembly	Black/Gray Matrix Fabric	AM1205873	\$ 354.00
		• Grammer 731 seat			
	• Durable black/gray matrix fabric covering				
	For Grammer Suspensions	Seat Assembly	Black Vinyl	AMSS11025	\$ 523.00
		• Grammer 731 seat			
	• Durable black vinyl covering				
	• Armrests				
	• Adjustable lumbar support				

Allis Chalmers®—Seats and Suspensions

Allis Chalmers®—Seats



	Application	Description		Part Number	Retail Price
	For Grammer Suspensions	Seat Assembly • Grammer 731 seat • Durable black vinyl covering • Adjustable lumbar support	Black Vinyl	AM1205871	\$ 322.00
	For Grammer Suspensions	Seat Assembly • Grammer 731 seat • Durable gray vinyl covering • Armrests • Adjustable lumbar support • Slide rails • Operator presence switch	Gray Vinyl	AM1110258	\$ 443.00
	7000, 7010, 7020, 7030,	Seat Assembly	Black Vinyl	AMAC7001BLV	\$ 526.00
	7040, 7045,	Seat Back	Black Vinyl	AMAC7001BV	\$ 105.00
	7050, 7060,	Seat Cushion	Black Vinyl	AMAC7001SV	\$ 195.00
	7080, 8550	Armrests (Pair), Flat Base Plate Not for luxury seat suspension	Black Vinyl	AMAC7002ARV	\$ 184.00
	200 ASN 655,	Seat Assembly	Black Fabric	AMAC7001BLF	\$ 453.00
	175, 185 ASN 6001, 7000,	Seat Back	Black Fabric	AMAC7001BF	\$ 133.00
	7010, 7020, 7030, 7040,	Seat Cushion	Black Fabric	AMAC7001SF	\$ 181.00
	7045, 7050, 7060, 7080, 8550				
	160, 170, 175,	Seat Back	Black Vinyl	AMAC210B	\$ 181.00
	180, 185, 190, 200, 210, 220, 7000, 7010, 7020, 7030, 7040, 7045, 7050, 7060, 7080, 7580	Seat Cushion, Angled Base Plate	Black Vinyl	AMAC210S	\$ 155.00
	170, 180, 185,	Small Seat Back	Black & White Vinyl	AMAC180SB	\$ 70.00
	190, 200, 210, 220, D21	Large Seat Back	Black & White Vinyl	AMAC180LB	\$ 238.00
		Seat Cushion	Black & White Vinyl	AMAC180S	\$ 143.00
	160, 170, 175,	Seat Back	Black & White Vinyl	AMACD17B	\$ 68.66
	180, 190, 200, 220, D10, D12, D14, D15, D17, D19, D21	Seat Cushion	Black & White Vinyl	AMACD17S	\$ 97.23
	5030, 5040, 5050, 6040, 6060, 6080	Universal Seat Bolt pattern: front to back - 11" center-to-center left to right - 11.25" center-to-center Blow-molded plastic bucket, non-sewn covers, will not crack or peel away from foam. Waterproof w/ drain hole.	Gray Vinyl	AMSS6777T	\$ 166.00
	For Grammer S7X2 High Back Seat Assemblies	Seat Frame, High Back S7X2 Frame Only, Cushions Not Included Includes Seat Frame, Mechanical Lumbar, Slide Rails and Literature Box		AM1125651	\$ 245.00

Seats and Suspensions

Allis Chalmers®—Seats and Suspensions

	Application	Description		Part Number	Retail Price
	For Grammer 741 and 742 Seat Assemblies	Seat Cushion	Black/Gray Matrix Fabric	AM1344872	\$ 122.00







Suspensions

	Application	Description		Part Number	Retail Price
	For Grammer Seat Assemblies	Suspension, Air • Grammer MSG97G air suspension • Front controls • Suspension stroke up to 7" • Adjustable to suit driver's weight from 110 to 485 lbs • Fore/aft adjustment • Height adjustment up to 3.10" • Shock absorber		AM1378253	\$ 699.25
	For Grammer Seat Assemblies	Suspension, Air For 24 Volt Systems • Grammer MSG97G air suspension • Self-contained 24-volt compressor • Front controls • Suspension stroke up to 7" • Adjustable to suit driver's weight from 110 to 485 lbs • Fore/aft adjustment • Height adjustment up to 3.10" • Shock absorber		AM1338593	\$ 681.75
	For Grammer Seat Assemblies	Suspension, Air For 24 Volt Systems • Grammer MSG97 low-frequency air suspension • Self-contained 24-volt compressor • Frame width of 17" • Front controls • Fore/aft isolator • Suspension stroke up to 7" • Height adjustment up to 3.10" • Adjustable to suit driver's weight from 100 to 400 lbs • Weight indicator • Shock absorber		AM1241742	\$ 470.00
	For Grammer Seat Assemblies	Suspension w/ Wiring Harness, Air • Grammer MSG95GL DDS air suspension • Suspension stroke of 100 mm • Fore/aft adjustment		AMSS11016	\$ 619.00
	8745, 8765, Gleaner® Combines: R40, R42, R50, R52, R60, R62, R70, R72	Suspension, Air • Grammer MSG95GL DDS air suspension • Suspension stroke of 100 mm • Fore/aft adjustment • Height adjustment		AM1292594	\$ 598.97

Allis Chalmers®—Seats and Suspensions



Allis Chalmers®—Seats

Seats and Suspensions

Application	Description	Part Number	Retail Price
 For Grammer Seat Assemblies	Suspension, Air For 24 Volt Systems <ul style="list-style-type: none"> • Grammer MSG95G air suspension • Self-contained 24-volt compressor • Frame width of 11.75" • Side controls • Fore/aft isolator • Air suspension with suspension travel of 4" • Suspension stroke up to 7" • Adjustable to suit driver's weight from 110 to 285 lbs • Weight indicator • Shock absorber 	AM1319709	\$ 583.00
 For Grammer Seat Assemblies	Suspension, Air <ul style="list-style-type: none"> • Grammer MSG95G air suspension • Frame width of 11.75" • Front controls • Fore/aft isolator • Air suspension w/ suspension travel of 4" • Suspension stroke up to 7" • Adjustable to suit driver's weight from 110 to 285 lbs • Weight indicator • Shock absorber 	AM1319705	\$ 617.00
 9635	Suspension, Air <ul style="list-style-type: none"> • Grammer MSG95G air suspension • Frame width of 11.75" • Side controls • Fore/aft isolator • Air suspension w/ suspension travel of 4" • Suspension stroke up to 7" • Adjustable to suit driver's weight from 110 to 285 lbs • Weight indicator • Shock absorber 	AM1319704	\$ 536.51
 For Grammer Seat Assemblies	Suspension, Air <ul style="list-style-type: none"> • Grammer MSG93 compact air suspension • Frame width of 8.92" • Front controls • Manual weight adjustment w/ push-pull switch control 	AM1225983	\$ 528.27
 For Grammer Seat Assemblies	Suspension, Mechanical <ul style="list-style-type: none"> • Grammer MSG87 mechanical suspension • Height adjustment up to 3.10" • Suspension stroke up to 7" • Adjustable to suit driver's weight from 110 to 400 lbs • Weight indicator 	AM1347434	\$ 683.08
 6060, 6070, 6080, 8010, 8030, 8050, 8070, 4WD: 4W-220, 4W-305, Most other models w/ modifications Replaces 70272936	Suspension, Mechanical <ul style="list-style-type: none"> • Grammer MSG85 mechanical suspension • Frame width of 11.75" • Suspension travel of 4" • Suspension stroke up to 7" • Flip-handle weight adjustment from 110 to 285 lbs • Weight indicator • Three-position height adjustment of 3" 	AM1201579	\$ 354.00
 For Grammer Seat Assemblies	Suspension, Mechanical <ul style="list-style-type: none"> • Grammer MSG83 compact mechanical suspension • Flip-handle weight adjustment • Front weight indicator • Three-position height adjustment • Frame width of 8.92" 	AM1225985	\$ 364.00

Allis Chalmers®—Seats and Suspensions



Seat and Suspension Components

Application	Description	Part Number	Retail Price
 For Grammer MSG85, MSG95 and MSG95DDS Suspensions	Side-to-Side Isolator	AM1139345	\$ 294.00
 For Grammer MSG97 12 Volt Suspensions Will not work on 24 Volt Suspensions	Heated Switch Kit	AM1250169	\$ 70.00
 Universal Equipment	Seat Belt, Retractable 55" long from bolt hole to hold hole when extended out	AMX6824	\$ 44.00
 For Grammer 721, 731 and 741 Seat Assemblies	Literature Box Kit	AMAL117363	\$ 28.00
 For Grammer MSG85 Mechanical Suspensions	Suspension Rebuild Kit Includes Adjusting Shaft, Clevis, Spindle, Springs, Weight Indicator and Hardware	AM1163691	\$ 68.00
 For Grammer MSG85, MSG95G, MSG95GL DDS and MSG97 Suspensions	Shock Absorber Replacement Shock Absorber for Grammer Side-to-Side Isolator	AM1019014	\$ 23.00
 For Grammer MSG85, MSG95G, MSG95GL DDS and MSG97 Suspensions	Shock Absorber Kit Replacement Shock Absorber for Grammer AM1139345 Side-to-Side Isolator	AMAL151004	\$ 49.00
 D10, D12, D14, D15, D17, D19, D21, 170, 175, 180, 185, 190, 190XT, 200, 210, 220, 7000, 7010, 7020, 7030, 7040, 7045, 7050, 7060, 7080, 7580	Shock Absorber 8 1/8" center-to-center compressed length, 11 3/4" center-to-center extended length Includes spring and rubber bushings	AM70225764	\$ 115.00
 6060 BSN 002602 & ASN 004239, 6070, 6080 BSN 003173 & ASN 004964, 8010, 8030, 8050, 8070, 4WD: 4W-220, 4W-305, Combines: F2 SN 046201-048200, F3 ASN 051000, L2, L3 ASN 013000, M2, M3 SN 022101-25900, N5 ASN 006100, N6 ASN 007300, N7 ASN 001700	Fork and Bearing Kit For Grammer MSG85 Suspensions	AM9704956	\$ 34.00

Case®—Seats and Suspensions

Seats

Complete Seats

	Application	Description		Part Number	Retail Price
	2394, 2594, 3394, 3594	Seat and Suspension Assembly <ul style="list-style-type: none"> • Plug-and-play • Grammer MSG95 air suspension • Durable black/gray matrix fabric covering • Armrests • Backrest extension for extra backrest height • Suspension stroke of 100 mm • Weight adjustment from 110 to 285 lbs • Fore/aft adjustment • Height adjustment • Operator presence switch Includes Grammer 731 Seat, Grammer MSG95G Air Suspension, Seat Adapter Plate, Wire Adapter, Mounting Hardware and Installation Instructions Replaces 222395A1, 241196A1, 1981855C1	Black/Gray Matrix Fabric	AMSS10006	\$ 1250.00
		Swivel Kit		AM134958	\$ 169.00
		Side-to-Side Isolator		AM1139345	\$ 294.00
		Seat Belt, Retractable		AM902133	\$ 103.00
	Most Models	Seat and Suspension Assembly <ul style="list-style-type: none"> • Grammer MSG83 compact mechanical suspension • Black/gray matrix fabric option includes backrest extension • Black/vinyl option does not include backrest extension • Armrests • Front weight indicator • Flip-handle weight adjustment • Suspension travel of 3.10" • Frame width of 8.92" • Three-position height adjustment Includes Grammer 721 Seat and Grammer MSG83 Mechanical Suspension	Black/Gray Matrix Fabric	AMSS11063	\$ 965.00
			Black Vinyl	AMSS11064	\$ 914.00
		Backrest Extension	Black Vinyl	AM1092126	\$ 89.00
		Seat Belt, Retractable		AM902133	\$ 103.00
	For Grammer DS44/1HB Seat Assemblies	Seat and Suspension Assembly	Black Vinyl	AM2049435	\$ 316.00
	1190, 1194, 1290, 1294, 1390, 1394, 1490, 1494, 1594, 1690	Seat and Suspension Assembly <ul style="list-style-type: none"> • Wrap-around style backrest • Adjustable to suit driver's weight up to 265 lbs • Slide rails provide fore/aft adjustment • Adjustable base angle • Mechanical suspension • Multiple mounting patterns Replaces K307863	Black Vinyl	AMSS8093	\$ 90.00

Case®—Seats

Seats and Suspensions





Case®—Seats and Suspensions

Seat Tops and Cushions

	Application	Description		Part Number	Retail Price
	For Grammer Suspensions	Seat Assembly	Black/Gray Matrix Fabric	AMSS11052	\$ 730.00
		• Grammer 742 tall back seat			
		• Durable black/gray matrix fabric covering			
		• Armrests			
		• Operator presence switch			
		Seat Assembly w/ Swivel	Black/Gray Matrix Fabric	AMSS11054	\$ 790.00
	For Grammer Suspensions	Seat Assembly	Black/Gray Matrix Fabric	AMSS11051	\$ 657.00
		• Grammer 741 seat			
		• Durable black/gray matrix fabric covering			
		• Armrests			
		• Backrest extension for extra backrest height			
		• Operator presence switch			
		Seat Assembly w/ Swivel	Black/Gray Matrix Fabric	AMSS11053	\$ 724.00
	For Grammer Suspensions	Seat Assembly	Black/Gray Matrix Fabric	AMSS11007	\$ 526.00
		• Grammer 731 seat			
		• Durable black/gray matrix fabric covering			
		• Armrests			
		• Backrest extension for extra backrest height			
		Seat Assembly w/ Swivel	Black/Gray Matrix Fabric	AMSS11033	\$ 675.00
	For Grammer Suspensions	Seat Assembly	Black/Gray Matrix Fabric	AM1205873	\$ 354.00
		• Grammer 731 seat			
		• Durable black/gray matrix fabric covering			
	For Grammer Suspensions	Seat Assembly	Black Vinyl	AMSS11025	\$ 523.00
		• Grammer 731 seat			
		• Durable black vinyl covering			
		• Armrests			
		• Adjustable lumbar support			
	For Grammer Suspensions	Seat Assembly	Black Vinyl	AM1205871	\$ 322.00
		• Grammer 731 seat			
		• Durable black vinyl covering			
		• Adjustable lumbar support			
	For Grammer Suspensions	Seat Assembly	Gray Vinyl	AM1110258	\$ 443.00
		• Grammer 731 seat			
		• Durable gray vinyl covering			
		• Armrests			
		• Adjustable lumbar support			
		• Slide rails			
		• Operator presence switch			
	1070, 1090, 1170, 1175, 1200, 1270, 1370, 1470, 1570, 1896, 2090, 2096, 2290, 2294, 2390, 2470, 2590, 2670, 2870, 3394, 3594, 4490, 4690, 4890 - w/ Presidential Seats	Seat Back	Black Vinyl	AMIH1086BV	\$ 125.00
		Seat Cushion	Black Vinyl	AMIH1086SV	\$ 131.00
		Armrests (Pair), 1 1/4" hole	Black Vinyl	AMIH1086ARV	\$ 147.00

Case®—Seats and Suspensions

Case®—Seats





	Application	Description		Part Number	Retail Price
	1070, 1090, 1170,	Seat Back	Black Fabric	AMIH1086BF	\$ 125.00
	1175, 1200, 1270,	Seat Cushion	Black Fabric	AMIH1086SF	\$ 125.00
	1370, 1470, 1570,	Armrests (Pair), 1 1/4" hole	Black Fabric	AMIH1086ARF	\$ 127.00
	1896, 2090, 2096,				
	2290, 2294, 2390,				
2470, 2590, 2670,					
2870, 3394, 3594,					
4490, 4690, 4890 -	w/ Presidential Seats				
	770, 870, 1070,	5-Piece Seat Kit	Black Vinyl	AMC1170BLV	\$ 482.00
	1090, 1170, 1175,	Kits do not include frame	Black Fabric	AMC1170BLF	\$ 431.00
	1200, 1370, 1470,				
1570, 2470, 2590,					
2670, 2870 - Units	w/ Agri-King Seat				
	300, 311, 400, 411, 430, 470, 500, 530, 570, 580, 600, 611, 630, 800, 830, 930, David Brown®: 1390, 1394, 1410, 1490	Universal Seat Bolt pattern: front to back - 11" center-to-center left to right - 11.25" center-to-center Blow-molded plastic bucket, non-sewn covers, will not crack or peel away from foam. Waterproof w/ drain hole.	Gray Vinyl	AMSS6777T	\$ 166.00
	For Grammer S7X2 High Back Seat Assemblies	Seat Frame, High Back S7X2 Frame Only, Cushions Not Included Includes Seat Frame, Mechanical Lumbar, Slide Rails and Literature Box		AM1125651	\$ 245.00
	For Grammer 741 and 742 Seat Assemblies	Seat Cushion	Black/Gray Matrix Fabric	AM1344872	\$ 122.00

Suspensions



Application	Description	Part Number	Retail Price
For Grammer Seat Assemblies	Suspension, Air • Grammer MSG97G air suspension • Front controls • Suspension stroke up to 7" • Adjustable to suit driver's weight from 110 to 485 lbs • Fore/aft adjustment • Height adjustment up to 3.10" • Shock absorber	AM1378253	\$ 699.25
For Grammer Seat Assemblies	Suspension, Air For 24 Volt Systems • Grammer MSG97G air suspension • Self-contained 24-volt compressor • Front controls • Suspension stroke up to 7" • Adjustable to suit driver's weight from 110 to 485 lbs • Fore/aft adjustment • Height adjustment up to 3.10" • Shock absorber	AM1338593	\$ 681.75

Seats and Suspensions







Case®—Seats and Suspensions

Application	Description	Part Number	Retail Price
For Grammer Seat Assemblies	Suspension, Air For 24 Volt Systems • Grammer MSG97 low-frequency air suspension • Self-contained 24-volt compressor • Frame width of 17" • Front controls • Fore/aft isolator • Suspension stroke up to 7" • Height adjustment up to 3.10" • Adjustable to suit driver's weight from 100 to 400 lbs • Weight indicator • Shock absorber	AM1241742	\$ 470.00
 For Grammer Seat Assemblies	Suspension w/ Wiring Harness, Air • Grammer MSG95GL DDS air suspension • Suspension stroke of 100 mm • Fore/aft adjustment	AMSS11016	\$ 619.00
 For Grammer Seat Assemblies	Suspension, Air • Grammer MSG95G air suspension • Frame width of 11.75" • Side controls • Fore/aft isolator • Air suspension w/ suspension travel of 4" • Suspension stroke up to 7" • Adjustable to suit driver's weight from 110 to 285 lbs • Weight indicator • Shock absorber	AM1319704	\$ 536.51
 For Grammer Seat Assemblies	Suspension, Air • Grammer MSG95G air suspension • Frame width of 11.75" • Front controls • Fore/aft isolator • Air suspension w/ suspension travel of 4" • Suspension stroke up to 7" • Adjustable to suit driver's weight from 110 to 285 lbs • Weight indicator • Shock absorber	AM1319705	\$ 617.00
 For Grammer Seat Assemblies	Suspension, Air For 24 Volt Systems • Grammer MSG95G air suspension • Self-contained 24-volt compressor • Frame width of 11.75" • Side controls • Fore/aft isolator • Air suspension with suspension travel of 4" • Suspension stroke up to 7" • Adjustable to suit driver's weight from 110 to 285 lbs • Weight indicator • Shock absorber	AM1319709	\$ 583.00
 For Grammer Seat Assemblies	Suspension, Air • Grammer MSG93 compact air suspension • Frame width of 8.92" • Front controls • Manual weight adjustment w/ push-pull switch control	AM1225983	\$ 528.27

Case®—Seats and Suspensions

	Application	Description	Part Number	Retail Price
	For Grammer Seat Assemblies	Suspension, Mechanical • Grammer MSG87 mechanical suspension • Height adjustment up to 3.10" • Suspension stroke up to 7" • Adjustable to suit driver's weight from 110 to 400 lbs • Weight indicator	AM1347434	\$ 683.08
	For Grammer Seat Assemblies	Suspension, Mechanical • Grammer MSG85 mechanical suspension • Frame width of 11.75" • Suspension travel of 4" • Suspension stroke up to 7" • Flip-handle weight adjustment from 110 to 285 lbs • Weight indicator • Three-position height adjustment of 3"	AM1201579	\$ 354.00
	For Grammer Seat Assemblies	Suspension, Mechanical • Grammer MSG83 compact mechanical suspension • Flip-handle weight adjustment • Front weight indicator • Three-position height adjustment • Frame width of 8.92"	AM1225985	\$ 364.00

Seat and Suspension Components

	Application	Description	Part Number	Retail Price
	For Grammer MSG85, MSG95 and MSG95DDS Suspensions	Side-to-Side Isolator	AM1139345	\$ 294.00
	For Grammer MSG97 12 Volt Suspensions Will not work on 24 Volt Suspensions	Heated Switch Kit	AM1250169	\$ 70.00
	Universal Equipment	Seat Belt, Retractable 55" long from bolt hole to hold hole when extended out	AMX6824	\$ 44.00
	For Grammer 721, 731 and 741 Seat Assemblies	Literature Box Kit	AMAL117363	\$ 28.00
	For Grammer MSG85, MSG95G, MSG95GL DDS and MSG97 Suspensions	Shock Absorber Replacement Shock Absorber for Grammer Side-to-Side Isolator	AM1019014	\$ 23.00
	For Grammer MSG85, MSG95G, MSG95GL DDS and MSG97 Suspensions	Shock Absorber Kit Replacement Shock Absorber for Grammer AM1139345 Side-to-Side Isolator	AMAL151004	\$ 49.00
	For Grammer MSG85 Mechanical Suspensions	Suspension Rebuild Kit Includes Adjusting Shaft, Clevis, Spindle, Springs, Weight Indicator and Hardware	AM1163691	\$ 68.00



Case IH®—Seats and Suspensions

Seats



Complete Seats

Application	Description	Part Number	Retail Price
 MX180, MX200, MX210, MX215, MX220, MX230, MX240, MX245, MX255, MX270, MX275, MX285, MX305, STX275, STX280, STX325, STX330, STX375, STX380, STX425, STX430, STX440, STX450, STX480, STX500, STX530	Seat and Suspension Assembly • Plug-and-play • Grammer MSG95GL DDS air suspension • Durable red leatherette covering • Cut-and-sew cushions for added comfort • Armrest • Backrest extension for extra backrest height • Adjustable lumbar support • Suspension stroke of 100 mm • Fore/aft adjustment • Seat depth/tilt • Operator presence switch Includes Grammer 741 Seat, Grammer MSG95GL DDS Air Suspension, Seat Adapter Plate, Command Arm Bracket, Switch Kit, Wire Adapter, Mounting Hardware and Installation Instructions Replaces 333658A1, 333658A2, 358202A1, 374353A2, 400184A1, 84155868, 84162213, 87347886, 87347885, 87395380, 87395381	Red Leatherette AMSS10012	\$ 1650.00
	Swivel Kit	AM134958	\$ 169.00
	Side-to-Side Isolator	AM1139345	\$ 294.00
	Seat Belt	AM902131	\$ 104.00
MX180, MX200, MX210, MX215, MX220, MX230, MX240, MX245, MX255, MX270, MX285, MX305, STX275, STX325, STX330, STX375, STX380, STX425, STX430, STX440, STX450, STX480, STX500, STX530	Seat and Suspension Assembly • Plug-and-play • Grammer MSG95G air suspension • Durable black/gray matrix fabric covering • Armrests • Backrest extension for extra backrest height • Suspension stroke of 100 mm • Weight adjustment from 110 to 285 lbs • Fore/aft adjustment • Height adjustment • Operator presence switch Includes Grammer 741 Seat, Grammer MSG95G Air Suspension, Seat Adapter Plate, Switch Kit, Wire Adapter, Mounting Hardware and Installation Instructions	Black/Gray Matrix Fabric AMSS10080	\$ 1150.00

Case IH®—Seats and Suspensions



Application	Description	Part Number	Retail Price
	Seat and Suspension Assembly • Plug-and-play • Grammer MSG95GL DDS air suspension • Durable gray fabric covering • Cut-and-sew cushions for added comfort • Armrest • Backrest extension for extra backrest height • Adjustable lumbar support • Suspension stroke of 100 mm • Fore/aft adjustment • Seat depth/tilt • Operator presence switch Includes Grammer 741 Seat, Grammer MSG95GL DDS Air Suspension, Seat Adapter Plate, Command Arm Bracket, Switch Kit, Wire Adapter, Mounting Hardware and Installation Instructions Replaces 333658A1, 333658A2, 358202A1, 358202A2, 374353A2, 400184A1, 1987214C2, 84155868, 84162213, 87347886, 87347885, 87395380, 87395381	Gray Fabric AMSS10011	\$ 1665.00
	Swivel Kit	AM134958	\$ 169.00
	Side-to-Side Isolator	AM1139345	\$ 294.00
	Seat Belt	AM902131	\$ 104.00
	7110, 7120, 7130, 7140, 7150, 7210, 7220, 7230, 7240, 7250, 8910, 8920, 8930, 8940, 8950, 9310, 9330, 9350, 9370, 9380, 9390, (9310, 9330, 9350, 9370, 9380, 9380 Quadtrac®, 9390, 9390 Quadtrac® - w/ Deluxe Air Suspension) Seat and Suspension Assembly • Plug-and-play • Grammer MSG95GL DDS air suspension • Durable red leatherette covering • Cut-and-sew cushions for added comfort • Armrests • Adjustable lumbar support • Backrest extension for extra backrest height • Suspension stroke of 100 mm • Fore/aft adjustment • Seat depth/tilt • Operator presence switch Includes Grammer 741 Seat, Grammer MSG95GL DDS Air Suspension, Seat Adapter Plate, Switch Kit, Wire Adapter, Mounting Hardware and Installation Instructions Replaces 132861A1, 132861A2, 132861A3, 132861A4, 1987214C2, 1999936C4	Red Leatherette AMSS10009	\$ 1580.00
	Swivel Kit	AMSS11000	\$ 109.00
	Side-to-Side Isolator	AM1139345	\$ 294.00
	Seat Belt, Retractable	AM902133	\$ 103.00

Case IH®—Seats and Suspensions

Application	Description	Part Number	Retail Price	
 <p>7110, 7120, 7130, 7140, 7150, 7210, 7220, 7230, 7240, 7250, 8910, 8920, 8930, 8940, 8950, 9330, 9350, 9370, 9380, 9390, (9310, 9330, 9350, 9370, 9380, 9380 Quadtrac®, 9390, 9390 Quadtrac® - w/ Deluxe Air Suspension)</p>	<p>Seat and Suspension Assembly</p> <ul style="list-style-type: none"> • Plug-and-play • Grammer MSG95GL DDS air suspension • Durable gray fabric covering • Cut-and-sew cushions for added comfort • Armrests • Backrest extension for extra backrest height • Adjustable lumbar support • Suspension stroke of 100 mm • Fore/aft adjustment • Seat depth/tilt • Operator presence switch <p>Includes Grammer 741 Seat, Grammer MSG95GL DDS Air Suspension, Switch Kit, Mounting Hardware and Installation Instructions</p> <p>Replaces 132861A1, 132861A2, 132861A3, 132861A4, 1987214C2, 1999936C4</p>	Gray Fabric	AMSS10008	\$ 1485.00
	Swivel Kit	AMSS11000	\$ 109.00	
	Side-to-Side Isolator	AM1139345	\$ 294.00	
	Seat Belt, Retractable	AM902133	\$ 103.00	
7110, 7120, 7130, 7140, 7150, 7210, 7220, 7230, 7240, 7250, 8910, 8920, 8930, 8940, 8950, 9330, 9350, 9370, 9380, 9390, (9310, 9330, 9350, 9370, 9380, 9380 Quadtrac®, 9390, 9390 Quadtrac® - w/ Deluxe Air Suspension)	<p>Seat and Suspension Assembly</p> <ul style="list-style-type: none"> • Plug-and-play • Grammer MSG95G air suspension • Durable black/gray matrix fabric covering • Armrests • Backrest extension for extra backrest height • Suspension stroke of 100 mm • Weight adjustment from 110 to 285 lbs • Fore/aft adjustment • Height adjustment <p>Includes Grammer 741 Seat, Grammer MSG95G Air Suspension, Seat Adapter Plate, Switch Kit, Wire Adapter, Mounting Hardware and Installation Instructions</p>	Black/Gray Matrix Fabric	AMSS10081	\$ 1150.00
 <p>CX50, CX60, CX70, CX80, CX90, CX100, MX80C, MX90C, MX100, MX100C, MX110, MX120, MX135, MX150, MX170</p>	<p>Seat and Suspension Assembly</p> <ul style="list-style-type: none"> • Plug-and-play • Grammer MSG95GL DDS air suspension • Durable gray fabric covering • Cut-and-sew cushions for added comfort • Armrests • Backrest extension for extra backrest height • Adjustable lumbar support • Suspension stroke of 100 mm • Fore/aft adjustment • Seat depth/tilt • Operator presence switch <p>Includes Grammer 741 Seat, Grammer MSG95GL DDS Air Suspension, Seat Adapter Plate, Switch Kit, Wire Adapter, Mounting Hardware and Installation Instructions</p> <p>Replaces 254762A1</p>	Gray Fabric	AMSS10013	\$ 1561.00
	Swivel Kit	AMSS11000	\$ 109.00	
	Side-to-Side Isolator	AM1139345	\$ 294.00	
	Seat Belt, Retractable	AM902133	\$ 103.00	



Case IH®—Seats and Suspensions

Case IH®—Seats

Application	Description	Part Number	Retail Price	
 <p>7110, 7120, 7130, 7140, 7150, 7210, 7220, 7230, 7240, 7250, 8910, 8920, 8930, 8940, 8950, 9210, 9230, 9240, 9250, 9260, 9270, 9280</p>	Seat and Suspension Assembly • Plug-and-play • Grammer MSG95 air suspension • Durable black/gray matrix fabric covering • Armrests • Backrest extension for extra backrest height • Suspension stroke of 100 mm • Weight adjustment from 110 to 285 lbs • Fore/aft adjustment • Height adjustment • Operator presence switch Includes Grammer 731 Seat, Grammer MSG95G Air Suspension, Seat Adapter Plate, Wire Adapter, Mounting Hardware and Installation Instructions Replaces 222393A1, 241190A1, 241194A1, 1981819C2, 1999936C4	Black/Gray Matrix Fabric	AMSS10016	\$ 1256.00
	Swivel Kit	AMSS11000	\$ 109.00	
	Side-to-Side Isolator	AM1139345	\$ 294.00	
	Seat Belt, Retractable	AM902133	\$ 103.00	
 <p>CX50, CX60, CX70, CX80, CX90, CX100, MX80C, MX90C, MX100, MX100C, MX110, MX120, MX135, MX150, MX170</p>	Seat and Suspension Assembly • Plug-and-play • Grammer MSG95 air suspension • Durable black/gray matrix fabric covering • Armrests • Backrest extension for extra backrest height • Suspension stroke of 100 mm • Weight adjustment from 110 to 285 lbs • Fore/aft adjustment • Height adjustment • Operator presence switch Includes Grammer 731 Seat, Grammer MSG95G Air Suspension, Seat Adapter Plate, Wire Adapter, Mounting Hardware and Installation Instructions Replaces 254762A1	Black/Gray Matrix Fabric	AMSS10017	\$ 1250.00
	Swivel Kit	AMSS11000	\$ 109.00	
	Side-to-Side Isolator	AM1139345	\$ 294.00	
	Seat Belt, Retractable	AM902133	\$ 103.00	
9110, 9130, 9150, 9170, 9180, 9190	Seat and Suspension Assembly • Plug-and-play • Grammer MSG95G air suspension • Durable black/gray matrix fabric covering • Armrests • Backrest extension for extra backrest height • Suspension stroke of 100 mm • Weight adjustment from 110 to 285 lbs • Fore/aft adjustment • Height adjustment Includes Grammer 741 Seat, Grammer MSG95G Air Suspension, Seat Adapter Plate, Switch Kit, Wire Adapter, Mounting Hardware and Installation Instructions	Black/Gray Matrix Fabric	AMSS10082	\$ 1150.00

Seats and Suspensions



Case IH®—Seats and Suspensions

Application	Description	Part Number	Retail Price
	Seat and Suspension Assembly • Plug-and-play • Grammer MSG95 air suspension • Durable black/gray matrix fabric covering • Armrests • Backrest extension for extra backrest height • Suspension stroke of 100 mm • Weight adjustment from 110 to 285 lbs • Fore/aft adjustment • Height adjustment • Operator presence switch Includes Grammer 731 Seat, Grammer MSG95G Air Suspension, Mounting Hardware and Installation Instructions Replaces 60-4793T91, 60-5949T91	Black/Gray Matrix Fabric AMSS10010	\$ 1250.00
	Swivel Kit	AMSS11000	\$ 109.00
	Side-to-Side Isolator	AM1139345	\$ 294.00
	Seat Belt, Retractable	AM902133	\$ 103.00
	5120, 5130, 5140, 5220, 5230, 5240, 5250 Seat and Suspension Assembly • Plug-and-play • Grammer MSG95 air suspension • Durable black/gray matrix fabric covering • Armrests • Backrest extension for extra backrest height • Suspension stroke of 100 mm • Weight adjustment from 110 to 285 lbs • Fore/aft adjustment • Height adjustment • Operator presence switch Includes Grammer 731 Seat, Grammer MSG95G Air Suspension, Seat Adapter Plate, Wire Adapter, Mounting Hardware and Installation Instructions Replaces 222395A1, 241196A1, 1981855C1	Black/Gray Matrix Fabric AMSS10006	\$ 1250.00
	Swivel Kit	AM134958	\$ 169.00
	Side-to-Side Isolator	AM1139345	\$ 294.00
	Seat Belt, Retractable	AM902133	\$ 103.00
7110, 7120, 7130, 7140, 7150, 7210, 7220, 7230, 7240, 7250, 8910, 8920, 8930, 8940, 8950, 9210, 9230, 9240, 9250, 9270, 9280, 9310, 9330, 9350, 9370, 9380, 9390	Seat and Suspension Assembly • Grammer MSG85 compact mechanical suspension • Durable black/gray matrix fabric covering • Armrests • Backrest extension for extra backrest height • Suspension travel of 4" • Fore/aft isolator • Suspension stroke up to 7" • Flip-handle weight adjustment from 110 to 285 lbs • Weight indicator • Three-position height adjustment of 3" • Frame width of 11.75" Includes Grammer 731 Seat, Grammer MSG85 Mechanical Suspension, Seat Adapter Plate, Wire Adapter, Mounting Hardware and Installation Instructions	Black/Gray Matrix Fabric AMSS10026	\$ 1048.00
	Swivel Kit	AMSS11000	\$ 109.00
	Side-to-Side Isolator	AM1139345	\$ 294.00
	Seat Belt, Retractable	AM902133	\$ 103.00



Case IH®—Seats and Suspensions

Case IH®—Seats



Seats and Suspensions

	Application	Description		Part Number	Retail Price	
	9110, 9130, 9150, 9170, 9180, 9190	Seat and Suspension Assembly • Grammer MSG85 compact mechanical suspension • Durable black/gray matrix fabric covering • Armrests • Backrest extension for extra backrest height • Suspension travel of 4" • Fore/aft isolator • Suspension stroke up to 7" • Flip-handle weight adjustment from 110 to 285 lbs • Weight indicator • Three-position height adjustment of 3" • Frame width of 11.75" Includes Grammer 731 Seat, Grammer MSG85 Mechanical Suspension, Mounting Hardware and Installation Instructions	Black/Gray Matrix Fabric	AMSS10028	\$ 1057.00	
				Swivel Kit	AMSS11000	\$ 109.00
				Side-to-Side Isolator	AM1139345	\$ 294.00
				Seat Belt, Retractable	AM902133	\$ 103.00
	5120, 5130, 5140, 5220, 5230, 5240, 5250	Seat and Suspension Assembly • Grammer MSG85 compact mechanical suspension • Durable black/gray matrix fabric covering • Armrests • Backrest extension for extra backrest height • Suspension travel of 4" • Fore/aft isolator • Suspension stroke up to 7" • Flip-handle weight adjustment from 110 to 285 lbs • Weight indicator • Three-position height adjustment of 3" • Frame width of 11.75" Includes Grammer 731 Seat, Grammer MSG85 Mechanical Suspension, Seat Adapter Plate, Wire Adapter, Mounting Hardware and Installation Instructions Replaces 222393A1, 1981819C2, 241190A1, 241194A1	Black/Gray Matrix Fabric	AMSS10007	\$ 1023.00	
				Swivel Kit	AMSS11000	\$ 109.00
				Side-to-Side Isolator	AM1139345	\$ 294.00
				Seat Belt, Retractable	AM902133	\$ 103.00
	MXU100, MXU110, MXU115, MXU125, MXU130, MXU135, Maxxum®: 100, 110, 115, 120, 125, 130, 135, 140, 145, 150	Seat and Suspension Assembly • Plug-and-play • Grammer MSG93 air suspension • Durable black/gray matrix fabric covering • Armrests • Backrest extension for extra backrest height • Air suspension w/ 12-volt compressor • Fore/aft isolator Includes Grammer 731 Seat, Grammer MSG93 Air Suspension, Mounting Hardware and Installation Instructions	Black/Gray Matrix Fabric	AMSS10031	\$ 1243.00	
				Seat Belt, Retractable	AM902133	\$ 103.00

Case IH®—Seats and Suspensions





	Application	Description		Part Number	Retail Price
	MXU100, MXU110, MXU115, MXU125, MXU130, MXU135, Maxxum®: 100, 110, 115, 120, 125, 130, 135, 140, 145, 150	Seat and Suspension Assembly	Black/Gray Matrix Fabric	AMSS10032	\$ 1048.00
		<ul style="list-style-type: none"> • Grammer MSG83 mechanical suspension • Durable black/gray matrix fabric covering • Armrests • Backrest extension for extra backrest height • Fore/aft isolator Includes Grammer 731 Seat, Grammer MSG83 Mechanical Suspension, Mounting Hardware and Installation Instructions			
	Most Models, Steiger®: Most Models	Seat and Suspension Assembly	Black/Gray Matrix Fabric	AMSS11063	\$ 965.00
		<ul style="list-style-type: none"> • Grammer MSG83 compact mechanical suspension • Black/gray matrix fabric option includes backrest extension • Black/vinyl option does not include backrest extension • Armrests • Front weight indicator • Flip-handle weight adjustment • Suspension travel of 3.10" • Frame width of 8.92" • Three-position height adjustment Includes Grammer 721 Seat and Grammer MSG83 Mechanical Suspension			
		Backrest Extension	Black Vinyl	AM1092126	\$ 89.00
		Seat Belt, Retractable		AM902133	\$ 103.00
	For Grammer DS44/1HB Seat Assemblies	Seat and Suspension Assembly For Grammer DS44/1HB Seat Assemblies	Black Vinyl	AM2049435	\$ 316.00

Buddy Seats

	Application	Description		Part Number	Retail Price
	7110, 7120, 7130, 7140, 7150, 7210, 7220, 7230, 7240, 7250, 8910, 8920, 8930, 8940, 8950	Buddy Seat	Gray Fabric	AMX6814	\$ 430.00
		Includes brackets and seat belt Back cushion folds down to use as an armrest			
	7110, 7120, 7130, 7140, 7150, 7210, 7220, 7230, 7240, 7250, 8910, 8920, 8930, 8940, 8950	Buddy Seat	Gray Fabric	AMSS8212	\$ 482.00
		Includes brackets, seat belt, outside handrail and hardware			

Case IH®—Seats and Suspensions

Seat Tops

	Application	Description	Part Number	Retail Price
	For Grammer Suspensions	Seat Assembly • Grammer 741 seat • Durable red leatherette covering • Cut-and-sew cushions for added comfort • Armrests • Backrest extension for extra backrest height • Adjustable lumbar support • Operator presence switch	Red Leatherette AMSS11010	\$ 806.00
		Seat Assembly w/ Swivel	Red Leatherette AMSS11035	\$ 1015.00
	For Grammer Suspensions	Seat Assembly w/ Command Arm • Grammer 741 seat • Durable red leatherette covering • Cut-and-sew cushions for added comfort • Armrest • Backrest extension for extra backrest height • Adjustable lumbar support • Operator presence switch	Red Leatherette AMSS11015	\$ 821.00
		Seat Assembly w/ Command Arm and Swivel	Red Leatherette AMSS11037	\$ 1174.00
	5120, 5130, 5140, 5150, 5220, 5230, 5240, 5250, 7210, 7230, 7240, 7250, 8910, 8920, 8930, 8940, 8950, 9310, 9330, 9370, 9380	Seat Assembly For Sears Suspensions • Grammer 741 seat • Durable red leatherette covering • Cut-and-sew cushions for added comfort • Armrests • Backrest extension for extra backrest height • Adjustable lumbar support • Operator presence switch Includes Installation Kit	Red Leatherette AMSS10041	\$ 833.00
	For Grammer Suspensions	Seat Assembly • Grammer 741 seat • Durable gray fabric covering • Cut-and-sew cushions for added comfort • Armrests • Backrest extension for extra backrest height • Adjustable lumbar support • Operator presence switch	Gray Fabric AMSS11009	\$ 879.00
		Seat Assembly w/ Swivel	Gray Fabric AMSS11034	\$ 1021.00
	5120, 5130, 5140, 5150, 5220, 5230, 5240, 5250, 7210, 7230, 7240, 7250, 8910, 8920, 8930, 8940, 8950, 9310, 9330, 9370, 9380	Seat Assembly For Sears Suspensions • Grammer 741 seat • Durable gray fabric covering • Cut-and-sew cushions for added comfort • Armrests • Backrest extension for extra backrest height • Adjustable lumbar support • Operator presence switch Includes Installation Kit	Gray Fabric AMSS10040	\$ 875.00



Case IH®—Seats

Seats and Suspensions







Case IH®—Seats and Suspensions

Application	Description	Part Number	Retail Price
 For Grammer Suspensions	Seat Assembly w/ Command Arm • Grammer 741 seat • Durable gray fabric covering • Cut-and-sew cushions for added comfort • Armrest • Backrest extension for extra backrest height • Adjustable lumbar support • Operator presence switch	Gray Fabric AMSS11014	\$ 885.90
	Seat Assembly w/ Command Arm and Swivel	Gray Fabric AMSS11036	\$ 1115.00
 For Grammer Suspensions	Seat Assembly • Grammer 731 seat • Durable gray vinyl covering • Armrests • Adjustable lumbar support • Slide rails • Operator presence switch	Gray Vinyl AM1110258	\$ 443.00
	Seat Assembly • Grammer 742 tall back seat • Durable black/gray matrix fabric covering • Armrests • Operator presence switch	Black/Gray Matrix Fabric AMSS11052	\$ 730.00
 For Grammer Suspensions	Seat Assembly w/ Swivel	Black/Gray Matrix Fabric AMSS11054	\$ 790.00
	Seat Assembly • Grammer 741 seat • Durable black/gray matrix fabric covering • Armrests • Backrest extension for extra backrest height • Operator presence switch	Black/Gray Matrix Fabric AMSS11051	\$ 657.00
 For Grammer Suspensions	Seat Assembly w/ Swivel	Black/Gray Matrix Fabric AMSS11053	\$ 724.00
	Seat Assembly • Grammer 731 seat • Durable black/gray matrix fabric covering • Armrests • Backrest extension for extra backrest height	Black/Gray Matrix Fabric AMSS11007	\$ 526.00
 For Grammer Suspensions	Seat Assembly w/ Swivel	Black/Gray Matrix Fabric AMSS11033	\$ 675.00
	Seat Assembly • Grammer 731 seat • Durable black/gray matrix fabric covering	Black/Gray Matrix Fabric AM1205873	\$ 354.00
 For Grammer Suspensions	Seat Assembly • Grammer 731 seat • Durable black vinyl covering • Armrests • Adjustable lumbar support	Black Vinyl AMSS11025	\$ 523.00

Case IH®—Seats and Suspensions

	Application	Description		Part Number	Retail Price
	For Grammer Suspensions	Seat Assembly • Grammer 731 seat • Durable black vinyl covering • Adjustable lumbar support	Black Vinyl	AM1205871	\$ 322.00
	MXU100, MXU110, MXU115, MXU125, MXU130, MXU135, Maxxum®: 100, 110, 115, 120, 125, 130, 140, 145, 150, Puma®: 115, 125, 140, 150, 155, 165	Seat Assembly Features: • Grammer S85/90 seat • Durable black vinyl covering • Adjustable backrest • Lumbar support • Retractable seat belt Replaces 5169051, 47476151, 82023115	Black Vinyl	AMSS11061	\$ 219.77
	For Grammer S7X2 High Back Seat Assemblies	Seat Frame, High Back S7X2 Frame Only, Cushions Not Included Includes Seat Frame, Mechanical Lumbar, Slide Rails and Literature Box		AM1125651	\$ 245.00





Seat Cushions

	Application	Description		Part Number	Retail Price
	For Grammer Seat Assemblies	Seat Cushion Kit 72X	Black/Gray Matrix Fabric	AM1344868	\$ 116.00
	For Grammer Seat Assemblies	Seat Back 7X1	Black/Gray Matrix Fabric	AM1344869	\$ 125.00
	For Grammer Seat Assemblies	Seat Cushion 73X	Black/Gray Matrix Fabric	AM1348172	\$ 127.00
	For Grammer Seat Assemblies	Seat Cushion 73X	Black/Gray Fabric	AM1348171	\$ 122.00
	For Grammer 731 Seat Assemblies	Seat Cushion w/ Cut Out	Black Vinyl	AM1014726	\$ 117.00
	For Grammer 721, 731 and 741 Seat Assemblies	Seat Back	Black Vinyl	AM141730	\$ 112.00
	For Grammer 741 and 742 Seat Assemblies	Seat Cushion	Black/Gray Matrix Fabric	AM1344872	\$ 122.00

Case IH®—Seats

Seats and Suspensions



Case IH®—Seats and Suspensions

Application	Description	Part Number	Retail Price
 For Grammer Cut-and-Sew Seat Assemblies	Seat Cushion 74X	Gray Fabric AM1361951	\$ 206.00
	5120, 5130, 5140, 5150, 5210, 5220, 5230, 5240, 5250, 7110, 7120, 7130, 7140, 7150, 7210, 7220, 7230, 7240, 7250, 8910, 8920, 8930, 8940, 8950, 9100, 9110, 9120, 9130, 9140, 9150, 9160, 9170, 9180, 9200, 9210, 9220, 9230, 9240, 9250, 9260, 9270, 9280, 9300, 9310, 9320, 9330, 9340, 9350, 9360, 9370, 9380	Seat Back Gray Fabric AMSS7998	\$ 236.00
		Seat Cushion Gray Fabric AMSS7999	\$ 236.00
 For Grammer Cut-and-Sew Seat Assemblies	Seat Back 7X1	Gray Fabric AM1361958	\$ 172.00
 For Grammer Seat Assemblies	Seat Back 7X2	Black/Gray Matrix Fabric AM1344871	\$ 120.00

Suspensions

Application	Description	Part Number	Retail Price
For Grammer Seat Assemblies	Suspension, Air • Grammer MSG97G air suspension • Front controls • Suspension stroke up to 7" • Adjustable to suit driver's weight from 110 to 485 lbs • Fore/aft adjustment • Height adjustment up to 3.10" • Shock absorber	AM1378253	\$ 699.25
For Grammer Seat Assemblies	Suspension, Air For 24 Volt Systems • Grammer MSG97G air suspension • Self-contained 24-volt compressor • Front controls • Suspension stroke up to 7" • Adjustable to suit driver's weight from 110 to 485 lbs • Fore/aft adjustment • Height adjustment up to 3.10" • Shock absorber	AM1338593	\$ 681.75
For Grammer Seat Assemblies	Suspension, Air For 24 Volt Systems • Grammer MSG97 low-frequency air suspension • Self-contained 24-volt compressor • Frame width of 17" • Front controls • Fore/aft isolator • Suspension stroke up to 7" • Height adjustment up to 3.10" • Adjustable to suit driver's weight from 100 to 400 lbs • Weight indicator • Shock absorber	AM1241742	\$ 470.00

Case IH®—Seats and Suspensions

Application	Description	Part Number	Retail Price
 For Grammer Seat Assemblies	Suspension w/ Wiring Harness, Air <ul style="list-style-type: none"> • Grammer MSG95GL DDS air suspension • Suspension stroke of 100 mm • Fore/aft adjustment 	AMSS11016	\$ 619.00
 For Grammer Seat Assemblies	Suspension, Air <ul style="list-style-type: none"> • Grammer MSG95G air suspension • Frame width of 11.75" • Side controls • Fore/aft isolator • Air suspension w/ suspension travel of 4" • Suspension stroke up to 7" • Adjustable to suit driver's weight from 110 to 285 lbs • Weight indicator • Shock absorber 	AM1319704	\$ 536.51
 For Grammer Seat Assemblies	Suspension, Air <ul style="list-style-type: none"> • Grammer MSG95G air suspension • Frame width of 11.75" • Front controls • Fore/aft isolator • Air suspension w/ suspension travel of 4" • Suspension stroke up to 7" • Adjustable to suit driver's weight from 110 to 285 lbs • Weight indicator • Shock absorber 	AM1319705	\$ 617.00
 For Grammer Seat Assemblies	Suspension, Air For 24 Volt Systems <ul style="list-style-type: none"> • Grammer MSG95G air suspension • Self-contained 24-volt compressor • Frame width of 11.75" • Side controls • Fore/aft isolator • Air suspension with suspension travel of 4" • Suspension stroke up to 7" • Adjustable to suit driver's weight from 110 to 285 lbs • Weight indicator • Shock absorber 	AM1319709	\$ 583.00
 For Grammer Seat Assemblies	Suspension, Air <ul style="list-style-type: none"> • Grammer MSG93 compact air suspension • Frame width of 8.92" • Front controls • Manual weight adjustment w/ push-pull switch control 	AM1225983	\$ 528.27
 For Grammer Seat Assemblies	Suspension, Mechanical <ul style="list-style-type: none"> • Grammer MSG87 mechanical suspension • Height adjustment up to 3.10" • Suspension stroke up to 7" • Adjustable to suit driver's weight from 110 to 400 lbs • Weight indicator 	AM1347434	\$ 683.08
 For Grammer Seat Assemblies	Suspension, Mechanical <ul style="list-style-type: none"> • Grammer MSG85 mechanical suspension • Frame width of 11.75" • Suspension travel of 4" • Suspension stroke up to 7" • Flip-handle weight adjustment from 110 to 285 lbs • Weight indicator • Three-position height adjustment of 3" 	AM1201579	\$ 354.00
 For Grammer Seat Assemblies	Suspension, Mechanical <ul style="list-style-type: none"> • Grammer MSG83 compact mechanical suspension • Flip-handle weight adjustment • Front weight indicator • Three-position height adjustment • Frame width of 8.92" 	AM1225985	\$ 364.00

Case IH®—Seats

Seats and Suspensions

Case IH®—Seats and Suspensions

Seat and Suspension Components

Application	Description	Part Number	Retail Price
 For Grammer Cut-and-Sew Seat Assemblies	Backrest Extension Red Leatherette	AM1392322	\$ 113.00
 For Grammer Cut-and-Sew Seat Assemblies	Backrest Extension Gray Fabric	AM1392324	\$ 113.00
 For Grammer Seat Assemblies	Backrest Extension Black/Gray Matrix Fabric	AM1348179	\$ 59.00
 For Grammer Seat Assemblies	Backrest Extension Black Vinyl	AM1092126	\$ 89.00
 For Grammer 721, 722, 731, 732, 741 and 742 Seat Assemblies	Armrest, Right Hand	AM1023155	\$ 65.00
	Armrest, Left Hand A60/380, 60 mm x 380 mm	AM1023156	\$ 65.00
 For Grammer 721, 722, 731, 732, 741 and 742 Seat Assemblies	Armrest, Right Hand	AM1026779	\$ 70.00
	Armrest, Left Hand Tiltable, Adjustable Height Bracket 80 mm x 380 mm	AM1026778	\$ 70.00
 For Grammer DS44/1 and DS44/1HB Seat Assemblies	Armrest, Right Hand	AM1186403	\$ 42.50
	Armrest, Left Hand	AM1186402	\$ 42.50
 For Grammer MSG85 and MSG95 Suspensions	Swivel Kit	AM134958	\$ 169.00
 For Grammer MSG85, MSG95 and MSG95DDS Suspensions	Side-to-Side Isolator	AM1139345	\$ 294.00
 For Grammer 721, 722, 731, 732, 741 and 742 Seat Assemblies	Seat Depth and Tilt Adjustment Kit	AM1040538	\$ 122.00
 For Grammer 721, 722, 731, 732, 741 and 742 Seat Assemblies	Seat Depth and Tilt Bezel and Lever Kit Replaces 1091389	AMF073716	\$ 35.00

Case IH®—Seats and Suspensions

Application	Description	Part Number	Retail Price
 For Grammer MSG97 12 Volt Suspensions Will not work on 24 Volt Suspensions	Heated Switch Kit	AM1250169	\$ 70.00
 For Grammer MSG83, MSG85, MSG93 and MSG95GL DDS Suspensions	Slide Rail Kit	AM140733	\$ 78.00
For Grammer MSG85 Suspensions	Tension Spring	AMT82227	\$ 19.00
For Grammer MSG83 Suspensions	Tension Spring	AML114921	\$ 13.80
 Universal Equipment	Seat Belt, Retractable 55" long from bolt hole to hold hole when extended out	AMX6824	\$ 44.00
 For Grammer Seat and Suspension Assemblies	Seat Belt, Retractable	AM902133	\$ 103.00
 For Grammer Seat and Suspension Assemblies w/ Command Arm Bracket	Seat Belt	AM902131	\$ 104.00
 For Grammer 721, 731 and 741 Seat Assemblies	Literature Box Kit	AMAL117363	\$ 28.00
For Grammer MSG93 Suspensions	Compressor	AMAL117313	\$ 144.00
 For Grammer MSG95 Suspensions	Air Level Control Switch	AM345107A1	\$ 70.00
 CX50, CX60, CX70, CX80, CX90, CX100, MX80C, MX90C, MX100, MX100C, MX110, MX120, MX135, MX150, MX170	Air Hose Kit For Grammer MSG95 Suspensions	AMAL166451	\$ 65.00
For Grammer MSG93 Suspensions	Air Hose Kit Replaces 1159864	AMAL180863	\$ 46.25
 For Grammer MSG95, MSG95AL and MSG97AL Suspensions	Air Level Control Mechanism Replacement Control Unit w/ Black Powder Coat Finish 12 Volt	AMAL166452	\$ 222.00
 For Grammer MSG95A, MSG95G, MSG95GL DDS and MSG97A Suspensions	Air Spring Early Style Universal Air Spring Tee Fitting at Top Mount Includes Plug Fittings for Extra Air Ports Not Used Air Lines Not Included	AMAL166455	\$ 153.00

Case IH®—Seats





Seats and Suspensions

Case IH®—Seats and Suspensions

Application	Description	Part Number	Retail Price	
 For Grammer 721, 722, 731, 732, 741 and 742 Seat Assemblies	Operator Presence Switch Kit	AM139267	\$ 65.00	
	For Grammer MSG95G Suspensions	Wiring Harness Replaces 1182922	AMAL210459	\$ 34.00
 For Grammer MSG85 Mechanical Suspensions	Suspension Rebuild Kit Includes Adjusting Shaft, Clevis, Spindle, Springs, Weight Indicator and Hardware	AM1163691	\$ 68.00	
 For Grammer 721, 722, 731, 732, 741 or 742 Seat Assemblies w/ Integrated Swivel	Swivel Handle	AMAL216582	\$ 50.00	
 For Grammer MSG95G or MSG95GI DDS Suspensions	Fore/Aft Shock Absorber	AMAL210538	\$ 95.00	
 MXU100, MXU110, MXU115, MXU125, MXU135 - w/ Grammer Deluxe Seat	Fore/Aft Lever or Adjustable Shock Handle For Grammer MSG95 Suspensions w/ Fore/Aft Adjustment or Adjustable Shock Option (depending on 1 or 2 Lever operations)	AM299564A1	\$ 27.00	
 For Grammer MSG95GL DDS Suspensions	Adapter Cable	AMAL210465	\$ 85.00	
	For Grammer MSG95G Suspensions	Rubber Boot	AMAT177339	\$ 144.00
 For Grammer MSG95G Suspensions	Rubber Boot	AMAL210536	\$ 94.00	
 For Grammer MSG93 Suspensions	Rubber Boot Replaces 137504	AMAL117322	\$ 48.00	
 For Grammer MSG83 Suspensions	Rubber Boot	AMAL117270	\$ 52.00	
 For Grammer MSG95G Suspensions	Shock Absorber	AMAL117453	\$ 63.00	
 For Grammer MSG85, MSG95G, MSG95GL DDS and MSG97 Suspensions	Shock Absorber Replacement Shock Absorber for Grammer Side-to-Side Isolator	AM1019014	\$ 23.00	
	For Grammer MSG95A, MSG95AL, MSG95G, MSG95GL DDS Suspensions	Shock Absorber	AMAL210505	\$ 127.00
 For Grammer MSG85 Suspensions	Shock Absorber	AMTCA18446	\$ 82.00	

Case IH®—Seats and Suspensions

Case IH®—Seats



Application	Description	Part Number	Retail Price
 For Grammer MSG85, MSG95G, MSG95GL DDS and MSG97 Suspensions	Shock Absorber Kit Replacement Shock Absorber for Grammer AM1139345 Side-to-Side Isolator	AMAL151004	\$ 49.00
 For Grammer MSG83 Suspensions	Shock Absorber	AMAL117265	\$ 65.00
 Cotton Pickers: 414, 420 - w/ Deluxe Seat	Shock Absorber 7.815" Collapsed Length, 10.42" Extended Length	AM372751R91	\$ 57.00
 MXU100, MXU110, MXU115, MXU125, MXU130, Farmall®: 85U, 95U, 105U, Maxxum®: 100, 110, 115, 120, 125, 130, 140	Fork and Bearing Kit For Grammer MSG85 Suspensions	AM9704956	\$ 34.00

Seats and Suspensions

Ford® / New Holland®—Seats and Suspensions

Seats



Complete Seats

Application	Description	Part Number	Retail Price
T8010, T8020, T8030, T8040, T8050, T9010, T9020, T9030, T9040, T9050, T9060, TG210, TG215, TG230, TG245, TG255	Seat and Suspension Assembly • Plug-and-play • Grammer MSG95G air suspension • Durable black/gray matrix fabric covering • Armrests • Backrest extension for extra backrest height • Suspension stroke of 100 mm • Weight adjustment from 110 to 285 lbs • Fore/aft adjustment • Height adjustment • Operator presence switch Includes Grammer 741 Seat, Grammer MSG95G Air Suspension, Seat Adapter Plate, Switch Kit, Wire Adapter, Mounting Hardware and Installation Instructions	Black/Gray Matrix Fabric AMSS10080	\$ 1150.00
	Seat and Suspension Assembly • Plug-and-play • Grammer MSG95GL DDS air suspension • Durable gray fabric covering • Cut-and-sew cushions for added comfort • Armrest • Backrest extension for extra backrest height • Adjustable lumbar support • Suspension stroke of 100 mm • Fore/aft adjustment • Seat depth/tilt • Operator presence switch Includes Grammer 741 Seat, Grammer MSG95GL DDS Air Suspension, Seat Adapter Plate, Command Arm Bracket, Switch Kit, Wire Adapter, Mounting Hardware and Installation Instructions Replaces 333658A1, 333658A2, 358202A1, 358202A2, 374353A2, 400184A1, 1987214C2, 84155868, 84162213, 87347886, 87347885, 87395380, 87395381	Gray Fabric AMSS10011	\$ 1665.00
	Swivel Kit	AM134958	\$ 169.00
	Side-to-Side Isolator	AM1139345	\$ 294.00
	Seat Belt	AM902131	\$ 104.00
	Seat and Suspension Assembly • Plug-and-play • Grammer MSG95GL DDS air suspension • Durable gray fabric covering • Cut-and-sew cushions for added comfort • Armrests • Backrest extension for extra backrest height • Adjustable lumbar support • Suspension stroke of 100 mm • Fore/aft adjustment • Seat depth/tilt • Operator presence switch Includes Grammer 741 Seat, Grammer MSG95GL DDS (Dynamic Dampening System) Air Suspension, Switch Kit, Mounting Hardware and Installation Instructions	Gray Fabric AMSS10037	\$ 1557.00
	Swivel Kit	AMSS11000	\$ 109.00
	Side-to-Side Isolator	AM1139345	\$ 294.00
	Seat Belt, Retractable	AM902133	\$ 103.00

Ford® / New Holland®—Seats and Suspensions

Ford® / New Holland®—Seats

Seats and Suspensions

	Application	Description		Part Number	Retail Price
	8670, 8670A, 8770, 8770A, 8870, 8870A, 8970, 8970A	Seat and Suspension Assembly	Black/Gray Matrix	AMSS10038	\$ 1172.00
		<ul style="list-style-type: none"> • Plug-and-play • Grammer MSG95 air suspension • Durable black/gray matrix fabric covering • Armrests • Backrest extension for extra backrest height • Fore/aft isolator Includes Grammer 731 Seat, Grammer MSG95 Air Suspension, Seat Adapter Plate, Wire Adpater, Mounting Hardware and Installation Instructions	Fabric		
	8670, 8670A, 8770, 8770A, 8870, 8870A, 8970, 8970A	Seat and Suspension Assembly	Black/Gray Matrix	AMSS10039	\$ 956.00
		<ul style="list-style-type: none"> • Grammer MSG85 compact mechanical suspension • Durable black/gray matrix fabric covering • Armrests • Backrest extension for extra backrest height • Suspension travel of 4" • Fore/aft isolator • Suspension stroke up to 7" • Flip-handle weight adjustment from 110 to 285 lbs • Weight indicator • Three-position height adjustment of 3" • Frame width of 11.75" Includes Grammer 731 Seat, Grammer MSG85 Mechanical Suspension, Seat Adapter Plate, Wire Adapter, Mounting Hardware and Installation Instructions	Fabric		
		Swivel Kit		AMSS11000	\$ 109.00
		Side-to-Side Isolator		AM1139345	\$ 294.00
		Seat Belt, Retractable		AM902133	\$ 103.00
	Most Models, Versatile®: Most Models	Seat and Suspension Assembly	Black/Gray Matrix	AMSS11063	\$ 965.00
		<ul style="list-style-type: none"> • Grammer MSG83 compact mechanical suspension • Black/gray matrix fabric option includes backrest extension • Black/vinyl option does not include backrest extension • Armrests • Front weight indicator • Flip-handle weight adjustment • Suspension travel of 3.10" • Frame width of 8.92" • Three-position height adjustment Includes Grammer 721 Seat and Grammer MSG83 Mechanical Suspension	Black Vinyl	AMSS11064	\$ 914.00
		Backrest Extension	Black Vinyl	AM1092126	\$ 89.00
		Seat Belt, Retractable		AM902133	\$ 103.00
	For Grammer DS44/1HB Seat Assemblies	Seat and Suspension Assembly For Grammer DS44/1HB Seat Assemblies	Black Vinyl	AM2049435	\$ 316.00

Ford® / New Holland®—Seats and Suspensions

Application	Description	Part Number	Retail Price
600, 700, 800, 900, 1000, 1100, 1200, 1210, 1300, 1310, 1500, 1510, 1600, 1700, 1710, 1900, 1910, 2000, 2100, 2110, 2120, 2130, 2300, 2310, 2600, 2610, 2810, 2910, 3000, 3010, 3055, 3100, 3110, 3120, 3150, 3190, 3230, 3300, 3310, 3330, 3400, 3430, 3600, 3610, 3900, 3910, 3930, 3930N, 4000, 4031, 4040, 4100, 4110, 4120, 4121, 4130, 4130N, 4131, 4190, 4200, 4330, 4340, 4400, 4410, 4500, 4600, 4610, 4630, 4630N, 4830, 4830N, 4835, 5000, 5030, 5030O, 5100, 5110, 5190, 5200, 5340, 5600, 5610, 5610S, 5640, 5700, 5900, 6000, 6410, 6600, 6610, 6635, 6700, 6810, 7000, 7100, 7200, 7600, 7610, 7700, T4020, T4030, TD5010	Seat and Suspension Assembly • Wrap-around style backrest • Adjustable to suit driver's weight up to 265 lbs • Slide rails provide fore/aft adjustment • Adjustable base angle • Mechanical suspension • Multiple mounting patterns Replaces 44907538, 81874576, 83982816, E9NN400AA, E9NN400AB99M	Black Vinyl AMSS8093 Blue Vinyl AMSS7465	\$ 90.00 \$ 90.00

Seat Tops

Application	Description	Part Number	Retail Price
	For Grammer Suspensions Seat Assembly • Grammer 742 tall back seat • Durable black/gray matrix fabric covering • Armrests • Operator presence switch	Black/Gray Matrix Fabric AMSS11052	\$ 730.00
	Seat Assembly w/ Swivel	Black/Gray Matrix Fabric AMSS11054	\$ 790.00





Ford® / New Holland®—Seats and Suspensions

Ford® / New Holland®—Seats

	Application	Description		Part Number	Retail Price
	For Grammer Suspensions	Seat Assembly • Grammer 741 seat • Durable black/gray matrix fabric covering • Armrests • Backrest extension for extra backrest height • Operator presence switch	Black/Gray Matrix Fabric	AMSS11051	\$ 657.00
		Seat Assembly w/ Swivel	Black/Gray Matrix Fabric	AMSS11053	\$ 724.00
	For Grammer Suspensions	Seat Assembly • Grammer 731 seat • Durable black/gray matrix fabric covering • Armrests • Backrest extension for extra backrest height	Black/Gray Matrix Fabric	AMSS11007	\$ 526.00
		Seat Assembly w/ Swivel	Black/Gray Matrix Fabric	AMSS11033	\$ 675.00
	For Grammer Suspensions	Seat Assembly • Grammer 731 seat • Durable black/gray matrix fabric covering	Black/Gray Matrix Fabric	AM1205873	\$ 354.00
	For Grammer Suspensions	Seat Assembly • Grammer 731 seat • Durable black vinyl covering • Armrests • Adjustable lumbar support	Black Vinyl	AMSS11025	\$ 523.00
	For Grammer Suspensions	Seat Assembly • Grammer 731 seat • Durable black vinyl covering • Adjustable lumbar support	Black Vinyl	AM1205871	\$ 322.00
	For Grammer Suspensions	Seat Assembly • Grammer 741 seat • Durable gray fabric covering • Cut-and-sew cushions for added comfort • Armrests • Backrest extension for extra backrest height • Adjustable lumbar support • Operator presence switch	Gray Fabric	AMSS11009	\$ 879.00
		Seat Assembly w/ Swivel	Gray Fabric	AMSS11034	\$ 1021.00
	8670, 8670A, 8770, 8770A, 8870, 8870A, 8970, 8970A, Combines: TR87, TR88, TR97, TR98, TR99	Seat Assembly For Sears Suspensions • Grammer 741 seat • Durable gray fabric covering • Cut-and-sew cushions for added comfort • Armrests • Backrest extension for extra backrest height • Adjustable lumbar support • Operator presence switch Includes Installation Kit	Gray Fabric	AMSS10040	\$ 875.00

Seats and Suspensions

Ford® / New Holland®—Seats and Suspensions

	Application	Description	Part Number	Retail Price
	For Grammer Suspensions	Seat Assembly w/ Command Arm • Grammer 741 seat • Durable gray fabric covering • Cut-and-sew cushions for added comfort • Armrest • Backrest extension for extra backrest height • Adjustable lumbar support • Operator presence switch	Gray Fabric AMSS11014	\$ 885.90
		Seat Assembly w/ Command Arm and Swivel	Gray Fabric AMSS11036	\$ 1115.00
	For Grammer Suspensions	Seat Assembly • Grammer 731 seat • Durable gray vinyl covering • Armrests • Adjustable lumbar support • Slide rails • Operator presence switch	Gray Vinyl AM1110258	\$ 443.00
	4635, 4835, 5635, 6635, 7635, T5030, T5040, T5050, T5060, T5070, T6080, T6010, T6020, T6030, T6040, T6050, T6060, T6070, T6090, T6.120, T6.125, T6.140, T6.145, T6.150, T6.155, T6.160, T6.165, T6.175, T6.180, T7.140, T7.150, T7.165, T7.165S, T7.170, T7.175, T7.180, T7.185, T7.190, T7.195, T7.195S, T7.200, T7.205, T7.210, T7.215, T7.215S, T7.230, T7.245, T7.260, TL70, TL70A, TL80, TL80A, TL90, TL90A, TL100, TL100A, TS100A, TS110A, TS115A, TS125A, TS130A, TS135A	Seat Assembly Features: • Grammer S85/90 seat • Durable black vinyl covering • Adjustable backrest • Lumbar support • Retractable seat belt Replaces 5169051, 47476151, 82023115	Black Vinyl AMSS11061	\$ 219.77
	231, 233, 234, 334, 335, 340, 445, 445A, 515, 531, 532, 540, 545, 2000, 2110, 2120, 2310, 2600, 2610, 2810, 2910, 3000, 3055, 3100, 3120, 3190, 3310, 3330, 3550, 3600, 3610, 3900, 4000, 4100, 4110, 4200, 4330, 4340, 4410, 4500, 4600, 4610, 5000, 5110, 5200, 5340, 5600, 5610, 5900, 6000, 6410, 6600, 6610, 7000, 7100, 7200 - w/ Bucket Style Seat	Seat Assembly	Blue Vinyl AMSS11042	\$ 437.00
	For Grammer S7X2 High Back Seat Assemblies	Seat Frame, High Back S7X2 Frame Only, Cushions Not Included Includes Seat Frame, Mechanical Lumbar, Slide Rails and Literature Box	AM1125651	\$ 245.00

Ford® / New Holland®—Seats and Suspensions



Seat Cushions

	Application	Description		Part Number	Retail Price
	For Grammer 721, 731 and 741 Seat Assemblies	Seat Back	Black/Gray Matrix Fabric	AM1344869	\$ 125.00
	For Grammer Seat Assemblies	Seat Cushion 72X	Black/Gray Matrix Fabric	AM1344868	\$ 116.00
	For Grammer Seat Assemblies	Seat Cushion 73X	Black/Gray Matrix Fabric	AM1348172	\$ 127.00
	For Grammer Seat Assemblies	Seat Cushion 73X w/ cut out for seat depth/tilt	Black/Gray Matrix Fabric	AM1348171	\$ 122.00
	For Grammer Seat Assemblies	Seat Back 7X2	Black/Gray Matrix Fabric	AM1344871	\$ 120.00
	For Grammer 741 and 742 Seat Assemblies	Seat Cushion	Black/Gray Matrix Fabric	AM1344872	\$ 122.00
	For Grammer 721, 731 and 741 Seat Assemblies	Seat Back	Black Vinyl	AM141730	\$ 112.00
	For Grammer 731 Seat Assemblies	Seat Cushion w/ cut out for seat depth/tilt	Black Vinyl	AM1014726	\$ 117.00
	For Grammer Cut-and-Sew Seat Assemblies	Seat Back 7X1	Gray Fabric	AM1361958	\$ 172.00
	For Grammer Cut-and-Sew Seat Assemblies	Seat Cushion 74X	Gray Fabric	AM1361951	\$ 206.00
	2600, 3000, 4000, 5600, 7600, 7610	Seat Back	Blue Vinyl	AMF2600B	\$ 140.00
		Seat Cushion, bars on seat bottom	Blue Vinyl	AMF2600S	\$ 156.00
	2000, 3000, 4000, 5600, 5610, 6600, 6610, 7600, 7610	Seat Back	Blue Vinyl	AMF7610B	\$ 124.00
		Seat Cushion	Blue Vinyl	AMF7610S	\$ 162.00

Ford® / New Holland®—Seats

Seats and Suspensions

Ford® / New Holland®—Seats and Suspensions

	Application	Description		Part Number	Retail Price
	8000, 8600, 9000, 9600	Seat Back	Blue Vinyl	AMF8000B	\$ 225.00
		Seat Cushion	Blue Vinyl	AMF8000S	\$ 134.00
		Armrests (Pair), fold-up independently	Blue Vinyl	AMF8000ARV	\$ 181.00
	8600, 8700, 9600, 9700, TW10, TW20, TW30	Seat Back	Blue Vinyl	AMF8600BV	\$ 112.00
		Seat Cushion	Blue Vinyl	AMF8600SV	\$ 135.00
		Armrests (Pair), fold-up together	Blue Vinyl	AMF8600ARV	\$ 101.00
		Seat Back	Blue Fabric	AMF8600BF	\$ 112.00
		Seat Cushion	Blue Fabric	AMF8600SF	\$ 139.00
		Armrests (Pair), fold-up together	Blue Fabric	AMF8600ARF	\$ 101.00
Note: use all w/ Original 301E Suspension					
	Versatile®: D118, D145, G125	Seat Back	Black Vinyl	AMMF285B	\$ 117.00
		Seat Cushion	Black Vinyl	AMMF285S	\$ 110.00







Suspensions

	Application	Description	Part Number	Retail Price
	For Grammer Seat Assemblies	Suspension, Air • Grammer MSG97G air suspension • Front controls • Suspension stroke up to 7" • Adjustable to suit driver's weight from 110 to 485 lbs • Fore/aft adjustment • Height adjustment up to 3.10" • Shock absorber	AM1378253	\$ 699.25
	For Grammer Seat Assemblies	Suspension, Air For 24 Volt Systems • Grammer MSG97G air suspension • Self-contained 24-volt compressor • Front controls • Suspension stroke up to 7" • Adjustable to suit driver's weight from 110 to 485 lbs • Fore/aft adjustment • Height adjustment up to 3.10" • Shock absorber	AM1338593	\$ 681.75
	For Grammer Seat Assemblies	Suspension, Air For 24 Volt Systems • Grammer MSG97 low-frequency air suspension • Self-contained 24-volt compressor • Frame width of 17" • Front controls • Fore/aft isolator • Suspension stroke up to 7" • Height adjustment up to 3.10" • Adjustable to suit driver's weight from 100 to 400 lbs • Weight indicator • Shock absorber	AM1241742	\$ 470.00
	For Grammer Seat Assemblies	Suspension w/ Wiring Harness, Air • Grammer MSG95GL DDS air suspension • Suspension stroke of 100 mm • Fore/aft adjustment	AMSS11016	\$ 619.00

Ford® / New Holland®—Seats and Suspensions

Ford® / New Holland®—Seats

Seats and Suspensions

Application	Description	Part Number	Retail Price
 For Grammer Seat Assemblies	Suspension, Air <ul style="list-style-type: none"> • Grammer MSG95G air suspension • Frame width of 11.75" • Side controls • Fore/aft isolator • Air suspension w/ suspension travel of 4" • Suspension stroke up to 7" • Adjustable to suit driver's weight from 110 to 285 lbs • Weight indicator • Shock absorber 	AM1319704	\$ 536.51
For Grammer Seat Assemblies	Suspension, Air <ul style="list-style-type: none"> • Grammer MSG95G air suspension • Frame width of 11.75" • Front controls • Fore/aft isolator • Air suspension w/ suspension travel of 4" • Suspension stroke up to 7" • Adjustable to suit driver's weight from 110 to 285 lbs • Weight indicator • Shock absorber 	AM1319705	\$ 617.00
 For Grammer Seat Assemblies	Suspension, Air For 24 Volt Systems <ul style="list-style-type: none"> • Grammer MSG95G air suspension • Self-contained 24-volt compressor • Frame width of 11.75" • Side controls • Fore/aft isolator • Air suspension with suspension travel of 4" • Suspension stroke up to 7" • Adjustable to suit driver's weight from 110 to 285 lbs • Weight indicator • Shock absorber 	AM1319709	\$ 583.00
 For Grammer Seat Assemblies	Suspension, Air <ul style="list-style-type: none"> • Grammer MSG93 compact air suspension • Frame width of 8.92" • Front controls • Manual weight adjustment w/ push-pull switch control 	AM1225983	\$ 528.27
 For Grammer Seat Assemblies	Suspension, Mechanical <ul style="list-style-type: none"> • Grammer MSG87 mechanical suspension • Height adjustment up to 3.10" • Suspension stroke up to 7" • Adjustable to suit driver's weight from 110 to 400 lbs • Weight indicator 	AM1347434	\$ 683.08
 For Grammer Seat Assemblies	Suspension, Mechanical <ul style="list-style-type: none"> • Grammer MSG85 mechanical suspension • Frame width of 11.75" • Suspension travel of 4" • Suspension stroke up to 7" • Flip-handle weight adjustment from 110 to 285 lbs • Weight indicator • Three-position height adjustment of 3" 	AM1201579	\$ 354.00
 For Grammer Seat Assemblies	Suspension, Mechanical <ul style="list-style-type: none"> • Grammer MSG83 compact mechanical suspension • Flip-handle weight adjustment • Front weight indicator • Three-position height adjustment • Frame width of 8.92" 	AM1225985	\$ 364.00

Ford® / New Holland®—Seats and Suspensions

Seat and Suspension Components

Application	Description	Part Number	Retail Price
 For Grammer Seat Assemblies	Backrest Extension Black/Gray Matrix Fabric	AM1348179	\$ 59.00
 For Grammer Seat Assemblies	Backrest Extension Black Vinyl	AM1092126	\$ 89.00
 For Grammer 721, 722, 731, 732, 741 and 742 Seat Assemblies	Armrest, Right Hand	AM1023155	\$ 65.00
	Armrest, Left Hand A60/380, 60 mm x 380 mm	AM1023156	\$ 65.00
 For Grammer 721, 722, 731, 732, 741 and 742 Seat Assemblies	Armrest, Right Hand	AM1026779	\$ 70.00
	Armrest, Left Hand Tiltable, Adjustable Height Bracket, 80 mm x 380 mm	AM1026778	\$ 70.00
 For Grammer MSG85 and MSG95 Suspensions	Swivel Kit	AM134958	\$ 169.00
 For Grammer MSG85, MSG95 and MSG95DDS Suspensions	Side-to-Side Isolator	AM1139345	\$ 294.00
 For Grammer 721, 722, 731, 732, 741 and 742 Seat Assemblies	Seat Depth and Tilt Adjustment Kit	AM1040538	\$ 122.00
 For Grammer 721, 722, 731, 732, 741 and 742 Seat Assemblies	Seat Depth and Tilt Bezel and Lever Kit	AMF073716	\$ 35.00
 For Grammer MSG97 12 Volt Suspensions Will not work on 24 Volt Suspensions	Heated Switch Kit	AM1250169	\$ 70.00
For Grammer MSG85 Suspensions	Tension Spring	AMT82227	\$ 19.00
For Grammer MSG83 Suspensions	Tension Spring	AML114921	\$ 13.80
 Universal Equipment	Seat Belt, Retractable 55" long from bolt hole to hold hole when extended out	AMX6824	\$ 44.00
 For Grammer Seat and Suspension Assemblies	Seat Belt, Retractable	AM902133	\$ 103.00

Ford® / New Holland®—Seats and Suspensions

Ford® / New Holland®—Seats

Seats and Suspensions

	Application	Description	Part Number	Retail Price
	For Grammer Seat and Suspension Assemblies w/ Command Arm Bracket	Seat Belt	AM902131	\$ 104.00
	For Grammer 721, 731 and 741 Seat Assemblies	Literature Box Kit	AMAL117363	\$ 28.00
	For Grammer MSG93 Suspensions	Compressor	AMAL117313	\$ 144.00
	For Grammer MSG95 Suspensions	Air Level Control Switch	AM345107A1	\$ 70.00
	For Grammer MSG93 Suspensions	Air Hose Kit	AMAL180863	\$ 46.25
	For Grammer MSG95, MSG95AL and MSG97AL Suspensions	Air Level Control Mechanism Replacement Control Unit w/ Black Powder Coat Finish 12 Volt	AMAL166452	\$ 222.00
	For Grammer MSG95A, MSG95G, MSG95GL DDS and MSG97A Suspensions	Air Spring Early Style Universal Air Spring Tee Fitting at Top Mount Includes Plug Fittings for Extra Air Ports Not Used Air Lines Not Included	AMAL166455	\$ 153.00
	For Grammer 721, 722, 731, 732, 741 and 742 Seat Assemblies	Operator Presence Switch Kit	AM139267	\$ 65.00
	For Grammer MSG95G Suspensions	Wiring Harness	AMAL210459	\$ 34.00
	For Grammer MSG85 Mechanical Suspensions	Suspension Rebuild Kit Includes Adjusting Shaft, Clevis, Spindle, Springs, Weight Indicator and Hardware	AM1163691	\$ 68.00
	For Grammer MSG95G or MSG95GI DDS Suspensions	Fore/Aft Shock Absorber	AMAL210538	\$ 95.00
	T6010, T6020, T6030, T6040, T6050, T6060, T6070, T6080, TS100A, TS115A, TS125A, TS135A - w/ Grammer Deluxe Seat	Fore/Aft Lever or Adjustable Shock Handle For Grammer MSG95 Suspensions w/ Fore/Aft Adjustment or Adjustable Shock Option (depending on 1 or 2 Lever operations)	AM299564A1	\$ 27.00
	For Grammer MSG95GL DDS Suspensions	Adapter Cable Replaces 1228040	AMAL210465	\$ 85.00
	For Grammer MSG95G Suspensions	Rubber Boot	AMAT177339	\$ 144.00
	For Grammer MSG95G Suspensions	Rubber Boot	AMAL210536	\$ 94.00



Ford® / New Holland®—Seats and Suspensions

Application	Description	Part Number	Retail Price
 For Grammer MSG93 Suspensions	Rubber Boot	AMAL117322	\$ 48.00
 For Grammer MSG83 Suspensions	Rubber Boot	AMAL117270	\$ 52.00
For Grammer MSG95A, MSG95AL, MSG95G, MSG95GL DDS Suspensions	Shock Absorber	AMAL210505	\$ 127.00
 For Grammer MSG95G Suspensions	Shock Absorber	AMAL117453	\$ 63.00
 For Grammer MSG85, MSG95G, MSG95GL DDS and MSG97 Suspensions	Shock Absorber Replacement Shock Absorber for Grammer Side-to-Side Isolator	AM1019014	\$ 23.00
 For Grammer MSG85 Suspensions	Shock Absorber	AMTCA18446	\$ 82.00
 For Grammer MSG85, MSG95G, MSG95GL DDS and MSG97 Suspensions	Shock Absorber Kit Replacement Shock Absorber for Grammer AM1139345 Side-to-Side Isolator	AMAL151004	\$ 49.00
 For Grammer MSG83 Suspensions	Shock Absorber	AMAL117265	\$ 65.00
 T5040, T5050, T5060, T5070, T6010, T6020, T6030, T6050, T6070, TL70, TL80, TL80A, TL90, TL90A, TL100, TL100A, TS100A, TS110A, TS115A, TS125A, TS130A, TS135A, Versatile®: 9030E, 9030V	Fork and Bearing Kit For Grammer MSG85 Suspensions	AM9704956	\$ 34.00

International®—Seats and Suspensions

Seats

Complete Seats

	Application	Description		Part Number	Retail Price
	786, 886, 986, 1086, 1486, 1586, 3288, 3388, 3588, 3688, 5088, 5288, 5488, Hydro 186	Seat and Suspension Assembly	Black/Gray Matrix Fabric	AMSS10048	\$ 1060.00
		• Grammer MSG83 compact mechanical suspension	Black Vinyl	AMSS10049	\$ 1012.00
		• Armrests			
		• Black/gray matrix fabric option includes backrest extension			
		• Black vinyl option does not include backrest extension			
		• Front weight indicator			
		• Flip-handle weight adjustment			
		• Suspension travel of 3.10"			
		• Frame width of 8.92"			
		• Three-position height adjustment			
		• Durable rubber molded suspension cover to keep components free of dirt and dust			
		Includes Grammer 721 Seat w/ Grammer MSG83 Mechanical Suspension, Seat Adapter Plate, Mounting Hardware and Installation Instructions			
		Backrest Extension	Black Vinyl	AM1092126	\$ 89.00
		Seat Belt, Retractable		AM902133	\$ 103.00
	Most Models	Seat and Suspension Assembly	Black/Gray Matrix Fabric	AMSS11063	\$ 965.00
		• Grammer MSG83 compact mechanical suspension	Black Vinyl	AMSS11064	\$ 914.00
		• Black/gray matrix fabric option includes backrest extension			
		• Black/vinyl option does not include backrest extension			
		• Armrests			
		• Front weight indicator			
		• Flip-handle weight adjustment			
		• Suspension travel of 3.10"			
		• Frame width of 8.92"			
		• Three-position height adjustment			
		Includes Grammer 721 Seat and Grammer MSG83 Mechanical Suspension			
		Backrest Extension	Black Vinyl	AM1092126	\$ 89.00
		Seat Belt, Retractable		AM902133	\$ 103.00
	706, 756, 766, 806, 826, 856, 966, 1026, 1066, 1206, 1256, 1456, 1466, 1566, 1568, Ind: 2706, 2756, 2806, 2826, 2856, 21026, 21206, 21256, 21456	Seat and Suspension Assembly	Black Vinyl	AMSS10029	\$ 1048.00
		• Grammer MSG85 compact mechanical suspension			
		• Durable black vinyl covering			
		• Armrests			
		• Suspension travel of 4"			
		• Fore/aft isolator			
		• Suspension stroke up to 7"			
		• Flip-handle weight adjustment from 110 to 285 lbs			
		• Weight indicator			
		• Three-position height adjustment of 3"			
		• Frame width of 11.75"			
		• Tips up to keep seat dry			
		Includes Grammer 731 Seat, Grammer MSG85 Compact Mechanical Suspension, Seat Adapter Plates, Mounting Hardware and Installation Instructions			





International®—Seats

Seats and Suspensions

International®—Seats and Suspensions

Application	Description	Part Number	Retail Price
 706, 806, 1206	Seat and Suspension Assembly • Grammer MSG85 mechanical suspension • Durable black and white vinyl covering • Small upper and large middle seat backs • Seat cushion • Frame width of 11.75" • Mechanical suspension w/ suspension travel of 4" • Suspension stroke up to 7" • Flip-handle weight adjustment from 110 to 285 lbs • Weight indicator • Three-position height adjustment of 3" • Shock absorber • Compatible w/ original OEM seat Includes 3-Piece Cushion Set, Grammer MSG85 Mechanical Suspension, Mounting Hardware and Installation Kit Replaces 351880R92, 357518R92, 403361R92	Black & White Vinyl AMSS10050	\$ 845.33
For Grammer DS44/1HB Seat Assemblies	Seat and Suspension Assembly	Black Vinyl AM2049435	\$ 316.00

Seat Tops and Cushions

Application	Description	Part Number	Retail Price
 For Grammer Suspensions	Seat Assembly • Grammer 742 tall back seat • Durable black/gray matrix fabric covering • Armrests • Operator presence switch	Black/Gray Matrix Fabric AMSS11052	\$ 730.00
	Seat Assembly w/ Swivel	Black/Gray Matrix Fabric AMSS11054	\$ 790.00
 For Grammer Suspensions	Seat Assembly • Grammer 741 seat • Durable black/gray matrix fabric covering • Armrests • Backrest extension for extra backrest height • Operator presence switch	Black/Gray Matrix Fabric AMSS11051	\$ 657.00
	Seat Assembly w/ Swivel	Black/Gray Matrix Fabric AMSS11053	\$ 724.00
 For Grammer Suspensions	Seat Assembly • Grammer 731 seat • Durable black/gray matrix fabric covering • Armrests • Backrest extension for extra backrest height	Black/Gray Matrix Fabric AMSS11007	\$ 526.00
	Seat Assembly w/ Swivel	Black/Gray Matrix Fabric AMSS11033	\$ 675.00
 For Grammer Suspensions	Seat Assembly • Grammer 731 seat • Durable black/gray matrix fabric covering	Black/Gray Matrix Fabric AM1205873	\$ 354.00

International®—Seats and Suspensions

International®—Seats

Seats and Suspensions

	Application	Description		Part Number	Retail Price
	For Grammer Suspensions	Seat Assembly • Grammer 731 seat • Durable black vinyl covering • Armrests • Adjustable lumbar support	Black Vinyl	AMSS11025	\$ 523.00
	For Grammer Suspensions	Seat Assembly • Grammer 731 seat • Durable black vinyl covering • Adjustable lumbar support	Black Vinyl	AM1205871	\$ 322.00
	For Grammer Suspensions	Seat Assembly • Grammer 731 seat • Durable gray vinyl covering • Armrests • Adjustable lumbar support • Slide rails • Operator presence switch	Gray Vinyl	AM1110258	\$ 443.00
	786, 886, 986, 1086,	Seat Back	Black Fabric	AMIH1086BF	\$ 125.00
	1486, 1586, 3088,	Seat Cushion	Black Fabric	AMIH1086SF	\$ 125.00
	3288, 3388, 3488, 3588, 3688, 3788, 4386, 4586, 4786, 5088, 5288, 5488, 6388, 6588, 6788, 7288, 7488, Hydro 186 - w/ Presidential Seats	Armrests (Pair), 1 1/4" hole	Black Fabric	AMIH1086ARF	\$ 127.00
	786, 886, 986, 1086,	Seat Back	Black Vinyl	AMIH1086BV	\$ 125.00
	1486, 1586, 3088,	Seat Cushion	Black Vinyl	AMIH1086SV	\$ 131.00
	3288, 3388, 3488, 3588, 3688, 3788, 4386, 4586, 4786, 5088, 5288, 5488, 6388, 6588, 6788, 7288, 7488, Hydro 186 - w/ Presidential Seats	Armrests (Pair), 1 1/4" hole	Black Vinyl	AMIH1086ARV	\$ 147.00
	656, 666, 686, 706, 756, 766, 806, 826, 856, 966, 1026, 1066, 1206, 1256, 1456, 1466, 1468, 1566, 1568, 4100, 4156, 4166, 4186, Hydro 100, Ind: 2504, 2544, 2656, 2706, 2756, 2806, 2826, 2856, 21206, 21256, 21456	Seat Assembly	Black Fabric Black & White Vinyl	AMIH856BF AMIH856B/WV	\$ 601.00 \$ 592.00
		504, 544, 656, 666, 686, 706, 756, 766, 806, 826, 856, 966, 1026, 1066, 1206, 1256, 1456, 1466, 1468, 1566, 4100, Hydro 70, Hydro 86, Hydro 100, Hydro 1066, Ind: 2656 Note: Will Not Work on Hydraulic Seat Suspension	Seat Assembly w/o Brackets	Black & White Vinyl	AMIH806V
		3-Piece Seat Kit w/o Brackets (Import)	Black & White Vinyl	AMIH806VA	\$ 165.00
		Seat Back, Small Upper	Black & White Vinyl	AMIH806SB	\$ 72.00
		Seat Back, Large Middle	Black & White Vinyl	AMIH806LB	\$ 195.00
		Seat Cushion	Black & White Vinyl	AMIH806S	\$ 140.00
		Seat Bracket Set, use with AMIH806V		AMIH806MK	\$ 75.00



International®—Seats and Suspensions

	Application	Description		Part Number	Retail Price
	460, 560, Suspension: 560	Seat Assembly	Black & White Vinyl	AMIH560DX	\$ 285.00
	300, 330, 350	Seat Back Seat Cushion	Black Vinyl Black Vinyl	AMIH350UB AMIH350US	\$ 110.00 \$ 93.00
	100, 130, 140, 330, Cub, Cub Lo-boy, Utility: 300, 350	Seat Back Seat Cushion	Silver Woven Silver Woven	AM363219R91 AM363220R91	\$ 53.50 \$ 77.50
	H, M - Farmall	Seat, 4-Bolt Bottom	Silver Vinyl	AMIHMS-SIL	\$ 124.00
	H & M - Early H, M - Farmall	Seat w/ Rail, Tips Back Seat, 4-Bolt Bottom	Silver Canvas Silver Canvas	AMIHMS-SC AMIHMS-SC	\$ 181.00 \$ 133.00
	A, B - Farmall H, M - Farmall	Seat w/ Rod, Tips Forward Seat, 4-Bolt Bottom	Red & White Vinyl Red & White Vinyl	AMIHABS AMIHMS	\$ 181.00 \$ 124.00
	460, 560, 660	Seat Replaces 372759R92	Black Vinyl	AMSS7147	\$ 124.00
	For Grammer S7X2 High Back Seat Assemblies	Seat Frame, High Back S7X2 Frame Only, Cushions Not Included Includes Seat Frame, Mechanical Lumbar, Slide Rails and Literature Box		AM1125651	\$ 245.00
	For Grammer 741 and 742 Seat Assemblies	Seat Cushion	Black/Gray Matrix Fabric	AM1344872	\$ 122.00

Suspensions

Application	Description	Part Number	Retail Price
For Grammer Seat Assemblies	Suspension, Air • Grammer MSG97G air suspension • Front controls • Suspension stroke up to 7" • Adjustable to suit driver's weight from 110 to 485 lbs • Fore/aft adjustment • Height adjustment up to 3.10" • Shock absorber	AM1378253	\$ 699.25

International®—Seats and Suspensions

Application	Description	Part Number	Retail Price
For Grammer Seat Assemblies	Suspension, Air For 24 Volt Systems • Grammer MSG97G air suspension • Self-contained 24-volt compressor • Front controls • Suspension stroke up to 7" • Adjustable to suit driver's weight from 110 to 485 lbs • Fore/aft adjustment • Height adjustment up to 3.10" • Shock absorber	AM1338593	\$ 681.75
For Grammer Seat Assemblies	Suspension, Air For 24 Volt Systems • Grammer MSG97 low-frequency air suspension • Self-contained 24-volt compressor • Frame width of 17" • Front controls • Fore/aft isolator • Suspension stroke up to 7" • Height adjustment up to 3.10" • Adjustable to suit driver's weight from 100 to 400 lbs • Weight indicator • Shock absorber	AM1241742	\$ 470.00
 For Grammer Seat Assemblies	Suspension w/ Wiring Harness, Air • Grammer MSG95GL DDS air suspension • Suspension stroke of 100 mm • Fore/aft adjustment	AMSS11016	\$ 619.00
 For Grammer Seat Assemblies	Suspension, Air • Grammer MSG95G air suspension • Frame width of 11.75" • Side controls • Fore/aft isolator • Air suspension w/ suspension travel of 4" • Suspension stroke up to 7" • Adjustable to suit driver's weight from 110 to 285 lbs • Weight indicator • Shock absorber	AM1319704	\$ 536.51
 For Grammer Seat Assemblies	Suspension, Air • Grammer MSG95G air suspension • Frame width of 11.75" • Front controls • Fore/aft isolator • Air suspension w/ suspension travel of 4" • Suspension stroke up to 7" • Adjustable to suit driver's weight from 110 to 285 lbs • Weight indicator • Shock absorber	AM1319705	\$ 617.00

International®—Seats

Seats and Suspensions

International®—Seats and Suspensions

Application	Description	Part Number	Retail Price
 <p>For Grammer Seat Assemblies</p>	<p>Suspension, Air For 24 Volt Systems</p> <ul style="list-style-type: none"> • Grammer MSG95G air suspension • Self-contained 24-volt compressor • Frame width of 11.75" • Side controls • Fore/aft isolator • Air suspension with suspension travel of 4" • Suspension stroke up to 7" • Adjustable to suit driver's weight from 110 to 285 lbs • Weight indicator • Shock absorber 	AM1319709	\$ 583.00
 <p>For Grammer Seat Assemblies</p>	<p>Suspension, Air</p> <ul style="list-style-type: none"> • Grammer MSG93 compact air suspension • Frame width of 8.92" • Front controls • Manual weight adjustment w/ push-pull switch control 	AM1225983	\$ 528.27
 <p>For Grammer Seat Assemblies</p>	<p>Suspension, Mechanical</p> <ul style="list-style-type: none"> • Grammer MSG87 mechanical suspension • Height adjustment up to 3.10" • Suspension stroke up to 7" • Adjustable to suit driver's weight from 110 to 400 lbs • Weight indicator 	AM1347434	\$ 683.08
 <p>For Grammer Seat Assemblies</p>	<p>Suspension, Mechanical</p> <ul style="list-style-type: none"> • Grammer MSG85 mechanical suspension • Frame width of 11.75" • Suspension travel of 4" • Suspension stroke up to 7" • Flip-handle weight adjustment from 110 to 285 lbs • Weight indicator • Three-position height adjustment of 3" 	AM1201579	\$ 354.00
 <p>706, 756, 766, 806, 826, 856, 966, 1026, 1066, 1206, 1256, 1456, 1566, 1568, Ind: 2706, 2756, 2806, 2826, 2856, 21026, 21206, 21256, 21456</p>	<p>Suspension, Mechanical Conversion Kit</p> <ul style="list-style-type: none"> • Grammer MSG85 compact mechanical suspension • Flip-handle weight adjustment from 110 to 285 lbs • Weight indicator • Three-position height adjustment of 3" • Frame width of 11.75" • Suspension travel of 4" • Suspension stroke up to 7" • Tips up to keep seat dry <p>Includes Grammer MSG85 Compact Mechanical Suspension, Seat Adapter Plates, Slide Rail Kit, Mounting Hardware and Installation Instructions</p>	AMSS10030	\$ 478.00
 <p>For Grammer Seat Assemblies</p>	<p>Suspension, Mechanical</p> <ul style="list-style-type: none"> • Grammer MSG83 compact mechanical suspension • Flip-handle weight adjustment • Front weight indicator • Three-position height adjustment • Frame width of 8.92" 	AM1225985	\$ 364.00

International®—Seats and Suspensions

Seat and Suspension Components

Application	Description	Part Number	Retail Price
 For Grammer MSG85, MSG95 and MSG95DDS Suspensions	Side-to-Side Isolator	AM1139345	\$ 294.00
 For Grammer MSG97 12 Volt Suspensions Will not work on 24 Volt Suspensions	Heated Switch Kit	AM1250169	\$ 70.00
 Universal Equipment	Seat Belt, Retractable 55" long from bolt hole to hold hole when extended out	AMX6824	\$ 44.00
 For Grammer 721, 731 and 741 Seat Assemblies	Literature Box Kit	AMAL117363	\$ 28.00
 For Grammer MSG85 Mechanical Suspensions	Suspension Rebuild Kit Includes Adjusting Shaft, Clevis, Spindle, Springs, Weight Indicator and Hardware	AM1163691	\$ 68.00
 For Grammer MSG85, MSG95G, MSG95GL DDS and MSG97 Suspensions	Shock Absorber Replacement Shock Absorber for Grammer Side-to-Side Isolator	AM1019014	\$ 23.00
 For Grammer MSG85, MSG95G, MSG95GL DDS and MSG97 Suspensions	Shock Absorber Kit Replacement Shock Absorber for Grammer AM1139345 Side-to-Side Isolator	AMAL151004	\$ 49.00
 460, 504, 544, 560, 656, 660, 666, 686, 706, 756, 766, 806, 826, 856, 966, 1026, 1066, 1206, 1256, 1456, 1466, 1468, 1566, 1568, 4156, 4166, 4186, Hydro 70, Hydro 86, Hydro 100, Ind: 2504, 2544, 2706, 2756, 2806, 2826, 2856, 21026, 21206, 21256, 21456 - All w/ Deluxe Seat	Shock Absorber 7.815" Collapsed Length, 10.42" Extended Length	AM372751R91	\$ 57.00
 H, Super H, M, Super M, Super MTA	Shock Absorber, Mid-Mounted 9.125" Compressed Length, 11" Extended Length Horizontal Bolt at one end and a Stud at the other end Mounts at the front of the Seat Frame Includes Bushings	AM353204R93	\$ 46.00
 100, 504, 544, 560, 656, 660, 666, 686, 706, 756, 766, 806, 826, 856, 966, 1026, 1066, 1206, 1256, 1456, 1466, 1468, 1566, 1568, 4100, 4156, 4166, 4186, Hydro 70, Hydro 86, Hydro 100, Ind: 2504, 2544, 2656, 2706, 2756, 2806, 2856	Rubber Spring	AM380712R1	\$ 36.00

International®—Seats

Seats and Suspensions

International®—Seats and Suspensions

Suspension—560



Installation Instructions for Low Profile Suspension with IH 560 Deluxe Seat Applications



1. Cut off existing pedestal at 2 3/4" from the top and slide back together.
2. Drill through the four existing holes and bolt with four 5/16" x 1" bolts.
3. Maintain an overall height of 8 1/2".
4. Install AMSS8093.

Description	Part Number	Retail Price
Seat and Suspension Assembly	Black Vinyl AMSS8093	\$ 90.00
560 Adapter Bracket	AMSS7148	\$ 66.00
Adapter Plate SAP SS-1	AMSS6088	\$ 30.00
Slide Rails	AMSS6043	\$ 25.00
Low Profile Narrow Mechanical Suspension	AMSS6087	\$ 399.00

John Deere®—Seats and Suspensions

Seats



Complete Seats

	Application	Description	Part Number	Retail Price
	5065M, 5075M, 5085M, 5090R, 5095M, 5095MH, 5100M, 5100MH, 5100R, 5105M, 5115M, 5115R, 5125R, 6105E, 6120E, 6135E - w/ Cab w/ Mechanical Joystick	Seat and Suspension Assembly • Plug-and-play • Grammer MSG95G air suspension • Durable brown matrix fabric covering • Armrests • Backrest extension for extra backrest height • Adjustable lumbar support • Suspension stroke of 100 mm • Weight adjustment from 110 to 285 lbs • Fore/aft adjustment • Operator presence switch Includes Grammer 731 Seat, Grammer MSG95G Air Suspension, Integrated Swivel, Mounting Hardware and Installation Instructions	Brown Matrix Fabric AMRE243291	\$ 1175.00
		Side-to-Side Isolator Includes Grammer 731 Seat, Grammer MSG85 Mechanical Suspension Swivel Kit Side-to-Side Isolator Seat Belt, Retractable	AM1139345 AMSJ16332 AMSS11000 AM1139345 AM902133	\$ 294.00 \$ 990.00 \$ 109.00 \$ 294.00 \$ 103.00
	5075M, 5085M, 5090M, 5100M, 5100MH, 5115M	Seat and Suspension Assembly • Grammer MSG85 mechanical suspension • Durable brown matrix fabric covering • Armrests • Adjustable lumbar support • Seat riser • Suspension stroke of 100 mm • Weight adjustment from 110 to 285 lbs • Fore/aft adjustment • Operator presence switch Includes Grammer 731 Seat, Grammer MSG85 Mechanical Suspension	Brown Matrix Fabric AMSJ16332	\$ 990.00
		Swivel Kit Side-to-Side Isolator Seat Belt, Retractable	AMSS11000 AM1139345 AM902133	\$ 109.00 \$ 294.00 \$ 103.00
	6010, 6020, 6100, 6105M, 6110, 6110M, 6115M, 6120, 6120M, 6125M, 6130, 6130M, 6140M, 6145M, 6150M, 6155M, 6170M, 6175M, 6195M, 6200, 6200L, 6210, 6215, 6220, 6230, 6300, 6300L, 6310, 6320, 6320L, 6330, 6400, 6400L, 6405, 6410, 6410S, 6415, 6420, 6420L, 6420S, 6430, 6500, 6500L, 6506, 6510, 6510S, 6520, 6520L, 6530, 6605, 6610, 6615, 6620, 6630, 6715, 6800, 6810, 6820, 6830, 6900, 6910, 6910S, 6920, 6920S, 6930, 7130, 7220, 7230, 7520, Premium Models: 6230, 6330, 6430, 6530, 6630, 6830, 6930, 7130, 7230, 7530	Seat and Suspension Assembly • Plug-and-play • Grammer MSG95GL DDS air suspension • Durable brown fabric covering • Cut-and-sew cushions for added comfort • Fold-up armrests • Backrest extension for extra backrest height • Suspension stroke of 100 mm • Fore/aft adjustment Includes Grammer 741 Seat, Grammer MSG95GL DDS Air Suspension, Seat Adapter Plates, Switch Kit, Wire Adapter, Mounting Hardware and Installation Instructions	Brown Fabric AMSS10004	\$ 1553.00
		Swivel Kit Side-to-Side Isolator Seat Belt, Retractable	AMSS11000 AM1139345 AM902133	\$ 109.00 \$ 294.00 \$ 103.00



John Deere®—Seats

Seats and Suspensions



John Deere®—Seats and Suspensions

	Application	Description	Part Number	Retail Price		
	6010, 6020, 6100, 6105M, 6110, 6110M, 6115M, 6120, 6120M, 6125M, 6130, 6130M, 6140M, 6145M, 6150M, 6155M, 6170M, 6175M, 6195M, 6200, 6200L, 6210, 6215, 6220, 6230, 6300, 6300L, 6310, 6320, 6320L, 6330, 6400, 6400L, 6405, 6410, 6410S, 6415, 6420, 6420L, 6420S, 6430, 6500, 6500L, 6506, 6510, 6510S, 6520, 6520L, 6530, 6605, 6610, 6615, 6620, 6630, 6715, 6800, 6810, 6820, 6830, 6900, 6910, 6910S, 6920, 6920S, 6930, 7130, 7220, 7230, 7520, Premium Models: 6230, 6330, 6430, 6530, 6630, 6830, 6930, 7130, 7230, 7530	Seat and Suspension Assembly • Plug-and-play • Grammer MSG95G air suspension • Durable brown matrix fabric covering • Armrests • Backrest extension for extra backrest height • Adjustable lumbar support • Suspension stroke of 100 mm • Weight adjustment from 110 to 285 lbs • Fore/aft adjustment • Operator presence switch Includes Grammer 731 Seat, Grammer MSG95G Air Suspension, Integrated Swivel, Seat Adapter Plates, Wire Adapter, Mounting Hardware and Installation Instructions	Brown Matrix Fabric	AMSS10015	\$ 1235.00	
		Side-to-Side Isolator		AM1139345	\$ 294.00	
		Seat Belt, Retractable		AM902133	\$ 103.00	
		6010, 6020, 6100, 6105M, 6110, 6110M, 6115M, 6120, 6120M, 6125M, 6130, 6130M, 6140M, 6145M, 6150M, 6155M, 6170M, 6175M, 6195M, 6200, 6200L, 6210, 6215, 6220, 6230, 6300, 6300L, 6310, 6320, 6320L, 6330, 6400, 6400L, 6405, 6410, 6410S, 6415, 6420, 6420L, 6420S, 6430, 6500, 6500L, 6506, 6510, 6510S, 6520, 6520L, 6530, 6534, 6605, 6610, 6615, 6620, 6630, 6715, 6800, 6810, 6820, 6830, 6900, 6910, 6910S, 6920, 6920S, 6930, 7130, 7220, 7230, 7520, 7530, Premium Models: 6230, 6330, 6430, 6530, 6630, 6830, 6930, 7130, 7230, 7530	Seat and Suspension Assembly • Grammer MSG85 mechanical suspension • Durable brown matrix fabric covering • Armrests • Backrest extension for extra backrest height • Adjustable lumbar support • Seat riser • Suspension stroke of 100 mm • Weight adjustment from 110 to 285 lbs • Fore/aft adjustment • Operator presence switch Includes Grammer 731 Seat, Grammer MSG85 Mechanical Suspension, Seat Adapter Plates, Wire Adapter, Mounting Hardware and Installation Instructions	Brown Matrix Fabric	AMSS10014	\$ 1007.00
			Swivel Kit		AMSS11000	\$ 109.00
			Side-to-Side Isolator		AM1139345	\$ 294.00
			Seat Belt, Retractable		AM902133	\$ 103.00

John Deere®—Seats and Suspensions

	Application	Description	Part Number	Retail Price
	7200, 7210, 7400, 7410, 7510, 7600, 7610, 7630, 7700, 7710, 7720, 7730, 7800, 7810, 7820, 7830, 7920, 7930 - w/o IVT™ Transmission	Seat and Suspension Assembly • Plug-and-play • Grammer MSG95GL DDS air suspension • Durable brown fabric covering • Cut-and-sew cushions for added comfort • Armrests • Backrest extension for extra backrest height • Suspension stroke of 100 mm • Fore/aft adjustment Includes Grammer 741 Seat, Grammer MSG95GL DDS Air Suspension, Seat Adapter Plate, Switch Kit, Wire Adapter, Mounting Hardware and Installation Instructions Replaces RE264912, RE264913, RE264915	Brown Fabric AMSS10003	\$ 1583.00
		Swivel Kit	AMSS11000	\$ 109.00
		Side-to-Side Isolator	AM1139345	\$ 294.00
		Seat Belt, Retractable	AM902133	\$ 103.00
		Seat and Suspension Assembly • Plug-and-play • Grammer MSG95G air suspension • Durable brown matrix fabric covering • Fold-up armrests • Backrest extension for extra backrest height • Adjustable lumbar support • Suspension stroke of 100 mm • Weight adjustment from 110 to 285 lbs • Fore/aft adjustment • Height adjustment • Operator presence switch Includes Grammer 741 Seat, Grammer MSG95G Air Suspension, Seat Adapter Plate, Switch Kit, Wire Adapter, Mounting Hardware and Installation Instructions	Brown Matrix Fabric AMSS10078	\$ 1150.00
	7200, 7210, 7400, 7410, 7510, 7600, 7610, 7630, 7700, 7710, 7720, 7730, 7800, 7810, 7820, 7830, 7920, 7930, (8560, 8570, 8760, 8770, 8870, 8960, 8970 - w/ IVT™ Transmission)	Seat and Suspension Assembly • Grammer MSG85 Mechanical Suspension • Durable brown matrix fabric covering • Armrest • Adjustable lumbar support • Seat riser • Suspension stroke of 100 mm • Weight adjustment from 110 to 285 lbs • Fore/aft adjustment • Operator presence switch Includes Grammer 731 Seat, Grammer MSG85 Mechanical Suspension, Seat Adapter, Mounting Hardware and Installation Instructions	Brown Matrix Fabric AMSS10047	\$ 1019.00
		Swivel Kit	AMSS11000	\$ 109.00
		Side-to-Side Isolator	AM1139345	\$ 294.00
		Seat Belt, Retractable	AM902133	\$ 103.00



John Deere®—Seats and Suspensions

	Application	Description	Part Number	Retail Price	
	7200, 7210, 7400, 7410, 7510, 7600, 7610, 7630, 7700, 7710, 7720, 7730, 7800, 7810, 7820, 7830, 7920, 7930, 8560, 8570, 8760, 8770, 8870, 8960, 8970 - w/o IVT™ Transmission	Seat and Suspension Assembly • Plug-and-play • Grammer MSG95G air suspension • Durable brown matrix fabric covering • Fold-up armrests • Backrest extension for extra backrest height • Adjustable lumbar support • Suspension stroke of 100 mm • Weight adjustment from 110 to 285 lbs • Fore/aft adjustment • Operator presence switch Includes Grammer 731 Seat, Grammer MSG95G Air Suspension, Integrated Swivel, Seat Adapter Plate, Wire Adapter, Mounting Hardware and Installation Instructions Replaces RE163452, RE264912, RE264913, RE264915, RE289300	Brown Matrix Fabric	AMSS10001	\$ 1257.00
		Side-to-Side Isolator	AM1139345	\$ 294.00	
		Seat Belt, Retractable	AM902133	\$ 103.00	
	(7200, 7210, 7400, 7410, 7600, 7610, 7630, 7700, 7710, 7720, 7730, 7800, 7810, 7820, 7830, 7920, 7930 - w/ IVT™ Transmission), 8100T, 8110, 8110T, 8120, 8120T, 8130, 8200, 8200T, 8210, 8210T, 8220, 8220T, 8230, 8230T, 8300, 8300T, 8310, 8310T, 8320, 8320T, 8330, 8330T, 8400, 8400T, 8410, 8410T, 8420, 8420T, 8430, 8430T, 8520, 8530, 8630, 9300, 9300T, 9320, 9320T, 9330, 9330T, 9400, 9400T, 9420, 9420T, 9430, 9430T, 9520, 9520T, 9530, 9530T, 9620, 9620T, 9630, 9630T	Seat and Suspension Assembly • Plug-and-play • Grammer MSG95GL DDS air suspension • Durable brown fabric covering • Cut-and-sew cushions for added comfort • Armrest • Backrest extension for extra backrest height • Suspension stroke of 100 mm • Fore/aft adjustment Includes Grammer 741 Seat, Grammer MSG95GL DDS Air Suspension, Seat Adapter Plate, Command Arm Bracket, Switch Kit, Wire Adapter, Mounting Hardware and Installation Instructions Replaces RE163452, RE264912, RE264913, RE264915, RE289300	Brown Fabric	AMSS10002	\$ 1628.00
		Swivel Kit	AM134958	\$ 169.00	
		Side-to-Side Isolator	AM1139345	\$ 294.00	
		Seat Belt	AM902131	\$ 104.00	



John Deere®—Seats and Suspensions

John Deere®—Seats

Seats and Suspensions

Application	Description	Part Number	Retail Price
 <p>(7200, 7210, 7400, 7410, 7600, 7610, 7630, 7700, 7710, 7720, 7730, 7800, 7810, 7820, 7830, 7920, 7930 - w/ IVT™ Transmission), 8100T, 8110, 8110T, 8120, 8120T, 8130, 8200, 8200T, 8210, 8210T, 8220, 8220T, 8230, 8230T, 8300, 8300T, 8310, 8310T, 8320, 8320T, 8330, 8330T, 8400, 8400T, 8410, 8410T, 8420, 8420T, 8430, 8430T, 8520, 8530, 8630, 9300, 9300T, 9320, 9320T, 9330, 9330T, 9400, 9400T, 9420, 9420T, 9430, 9430T, 9520, 9520T, 9530, 9530T, 9620, 9620T, 9630, 9630T</p>	<p>Seat and Suspension Assembly</p> <ul style="list-style-type: none"> • Plug-and-play • Grammer MSG95G air suspension • Durable brown matrix fabric covering • Fold-up armrests • Backrest extension for extra backrest height • Suspension stroke of 100 mm • Weight adjustment from 110 to 285 lbs • Fore/aft adjustment • Height adjustment • Operator presence switch <p>Includes Grammer 741 Seat, Grammer MSG95G Air Suspension, Seat Adapter Plate, Switch Kit, Wire Adapter, Mounting Hardware and Installation Instructions</p>	Brown Matrix Fabric	AMSS10077 \$ 1150.00
 <p>8450, 8650, 8850</p>	<p>Seat and Suspension Assembly</p> <ul style="list-style-type: none"> • Plug-and-play • Grammer MSG95G air suspension • Durable brown matrix fabric covering • Armrests • Backrest extension for extra backrest height • Adjustable lumbar support • Suspension stroke of 100 mm • Weight adjustment from 110 to 285 lbs • Fore/aft adjustment • Operator presence switch <p>Includes Grammer 731 Seat, Grammer MSG95G Air Suspension, Integrated Swivel, Wire Adapter, Mounting Hardware and Installation Instructions</p>	Brown Matrix Fabric	AMSS10043 \$ 1287.00
	Swivel Kit		AMSS11000 \$ 109.00
	Side-to-Side Isolator		AM1139345 \$ 294.00
 <p>8450, 8650, 8850</p>	<p>Seat and Suspension Assembly</p> <ul style="list-style-type: none"> • Grammer MSG85 mechanical suspension • Durable brown matrix fabric covering • Armrests • Adjustable lumbar support • Seat riser • Suspension stroke of 100 mm • Weight adjustment from 110 to 285 lbs • Fore/aft adjustment • Operator presence switch <p>Includes Grammer 731 Seat, Grammer MSG85 Mechanical Suspension, Seat Adapter Plate, Mounting Hardware and Installation Instructions</p>	Brown Matrix Fabric	AMSS10044 \$ 1013.00
	Swivel Kit		AMSS11000 \$ 109.00
	Side-to-Side Isolator		AM1139345 \$ 294.00
	Seat Belt, Retractable		AM902133 \$ 103.00



John Deere®—Seats and Suspensions

Application	Description	Part Number	Retail Price
 <p>2750, 2755, 2950, 2955, 3030, 3040, 3130, 3140, 3150, 4000, 4030, 4040, 4050, 4055, 4230, 4240, 4250, 4255, 4430, 4440, 4450, 4455, 4560, 4630, 4640, 4650, 4755, 4760, 4840, 4850, 4955, 4960 - w/ Wide 11" Seat Well</p>	Seat and Suspension Assembly • Plug-and-play • Grammer MSG93 compact air suspension • Durable brown matrix fabric covering • Fold-up armrests • Reclining backrest w/ tapered back support • Adjustable lumbar support • Easily accessible front controls • Manual weight adjustment w/ push-pull switch control • Frame width of 8.92" Includes Grammer 731 Seat, Grammer MSG93 Compact Air Suspension, Seat Adapter Plate, Pedestal, Slide Rail Kit and Installation Kit	Brown Matrix Fabric	AMSS10018 \$ 1025.00
	Backrest Extension	Brown Matrix Fabric	AM1201069 \$ 67.00
	Seat Belt, Retractable		AM902133 \$ 103.00
	 <p>2750, 2755, 2950, 2955, 3030, 3040, 3130, 3140, 3150, 4000, 4030, 4040, 4050, 4055, 4230, 4240, 4250, 4255, 4430, 4440, 4450, 4455, 4560, 4630, 4640, 4650, 4755, 4760, 4840, 4850, 4955, 4960 - w/ Wide 11" Seat Well</p>	Seat and Suspension Assembly • Grammer MSG83 compact mechanical suspension • Durable brown matrix fabric covering • Fold-up armrests • Reclining backrest w/ tapered back support • Adjustable lumbar support • Flip-handle weight adjustment • Front weight indicator • Three-position height adjustment • Frame width of 8.92" Includes Grammer 731 Seat, Grammer MSG83 Compact Mechanical Suspension, Seat Adapter Plate, Pedestal, Slide Rail Kit and Installation Kit	Brown Matrix Fabric
Backrest Extension		Brown Matrix Fabric	AM1201069 \$ 67.00
Seat Belt, Retractable			AM902133 \$ 103.00
3030, 3130, 4030, 4230, 4430, 4630 - Early w/ Narrow 7" Seat Well		Seat and Suspension Assembly • Plug-and-play • Grammer MSG93 compact air suspension • Durable brown matrix fabric covering • Fold-up armrests • Reclining backrest w/ tapered back support • Adjustable lumbar support • Easily accessible front controls • Manual weight adjustment w/ push-pull switch control • Frame width of 8.92" Includes Grammer 731 Seat, Grammer MSG93 Compact Air Suspension, Seat Adapter Plate, Pedestal, Slide Rail Kit, Seat Well Extension and Installation Kit	Brown Matrix Fabric



John Deere®—Seats and Suspensions

John Deere®—Seats

Seats and Suspensions

Application	Description	Part Number	Retail Price	
 3030, 3130, 4030, 4230, 4430, 4630 - Early w/ Narrow 7" Seat Well	Seat and Suspension Assembly • Grammer MSG83 compact mechanical suspension • Durable brown matrix fabric covering • Fold-up armrests • Reclining backrest w/ tapered back support • Adjustable lumbar support • Flip-handle weight adjustment • Front weight indicator • Three-position height adjustment • Frame width of 8.92" Includes Grammer 731 Seat, Grammer MSG83 Compact Mechanical Suspension, Seat Adapter Plate and Installation Kit	Brown Matrix Fabric	AMSS10022	\$ 878.00
	Backrest Extension	Brown Matrix Fabric	AM1201069	\$ 67.00
	Seat Belt, Retractable		AM902133	\$ 103.00
For Grammer DS44/1HB Seat Assemblies	Seat and Suspension Assembly For Grammer DS44/1HB Seat Assemblies	Black Vinyl	AM2049435	\$ 316.00
 5200, 5210, 5220, 5300, 5303, 5310, 5320, 5400, 5410, 5420, 5510, 5520, 6110, 6200, 6210, 6300, 6310, 6400, 6410, 6500 - w/ Open Station	Seat and Suspension Assembly	Yellow Vinyl	AMX6805	\$ 375.00
	• Heavy duty slider suspension	Black Vinyl	AMX6806	\$ 375.00
	• Weight adjustable			
	• Angle adjustment			
	• Height adjustable			
	• Fore and aft adjustment			
Armrests (Pair)			AMX6805AR	\$ 45.00
Seat and Suspension Assembly	Yellow Vinyl	AMX6827	\$ 360.00	
• Heavy duty slider suspension	Black Vinyl	AMX6826	\$ 360.00	
• Weight adjustable				
• Angle adjustment				
• Height adjustable				
• Fore and aft adjustment				
• Operator presence switch				
Armrests (Pair)			AMX6805AR	\$ 45.00
840, 920, 930, 940, 1020, 1030, 1040, 1120, 1130, 1140, 1530, 1630, 1640, 1840, 2020, 2030, 2040, 2040S, 2120, 2130, 2140, 2150, 2250, 2255, 2350, 2355, 2355N, 2440, 2550, 2555, 2640, 2750, 2755, 2840, 2855N, 2940, 2950, 2955, 3030, 3040, 3120, 3130, 3140, Utility: 820, 830, 2155, 2240, Swathers: 800, 830	Seat and Suspension Assembly	Yellow Vinyl	AMSS8094	\$ 90.00
• Wrap-around style backrest				
• Adjustable to suit driver's weight up to 265 lbs				
• Slide rails provide fore/aft adjustment				
• Adjustable base angle				
• Mechanical suspension				
• Multiple mounting patterns				
Replaces AL31842, AL35635, AL36556, AL39913				

John Deere®—Seats and Suspensions

	Application	Description		Part Number	Retail Price
	Combines: 9550 ASN 695200, 9550SH ASN 695700, 9560, 9560SH, 9560STS, 9570STS, 9650 ASN 695300, 9650CTS ASN 965400, 9650STS ASN 965500, 9660STS, 9670STS, 9750STS ASN 965600, 9760STS, 9770STS, 9780CTS, 9860STS, 9870STS, Cotton Pickers: 7660, 7760, 9986, 9996, CP690, Cotton Strippers: 7460, CS690, Forage Harvesters: 7180, 7200, 7250, 7280, 7300, 7350, 7380, 7400, 7450, 7480, 7500, 7550, 7580, 7700, 7780, 7800, 7950, 7980, Swathers: 4895, 4990, 4995	Seat and Suspension Assembly • Plug-and-play • High back Includes Grammer 742 Seat and Grammer MSG95 Air Suspension Replaces AH169595, AH227974	Brown	AMAXE48239	\$ 1319.00
	Combines: S550, S650, S660, S670, S670HM, S680, S680HM, S690, S690HM, S760, S770, S780, S785, S790, T550, T560, T660, T670, Forage Harvesters: 8100, 8200, 8300, 8400, 8500, 8600, 8700, 8800, 9600, 9700, 9800, 9900, Swathers: W235, W260, Sprayers: R4030, R4038, R4045, R4060	Seat and Suspension Assembly • Plug-and-play • High back Includes Grammer 742 Seat and Grammer MSG95 Air Suspension Replaces AL202783, BL15148	Brown	AMAL209102	\$ 1515.00
	Sprayers: 4730, 4830, 4930, 4940	Seat and Suspension Assembly • Plug-and-play • High back Includes Grammer 742 Seat and Grammer MSG95 Air Suspension Replaces RE306464	Brown	AMRE581108	\$ 1391.00

Buddy Seats

	Application	Description		Part Number	Retail Price
	7630, 7720, 7730, 7820, 7830, 7920, 7930, 8100, 8110, 8110T, 8120, 8120T, 8130, 8200, 8200T, 8210, 8210T, 8220, 8220T, 8230, 8230T, 8300, 8300T, 8310, 8310T, 8320, 8320T, 8330, 8330T, 8400, 8400T, 8410, 8410T, 8420, 8420T, 8430, 8430T, 8520, 8520T, 8530, 9300T, 9320T, 9400T, 9420T, 9430T, 9520T, 9530T, 9620T, 9630T, Sprayers: 4720, 4730, 4830, 4920, 4930, 4940	Buddy Seat • Durable fabric covers • Backrest cushion does not fold forward • Seat belt, brackets and hardware included • 35.50" tall, to top of backrest cushion • 23" tall, to top of seat cushion • 19.50" tall, to bottom of the seat cushion • 17" deep, from front to back of seat cushion Note: when adding buddy seat, AMRE221551 Fender Panel must also be purchased	Brown Fabric	AMX6819	\$ 576.00

John Deere®—Seats and Suspensions

Application	Description	Part Number	Retail Price
 <p>7720, 7730, 7630, 7815, 7820, 7830, 7920, 7930, 8100, 8100T, 8110, 8110T, 8120, 8120T, 8130, 8200, 8200T, 8210, 8210T, 8220, 8220T, 8230, 8230T, 8300, 8300T, 8310, 8310T, 8320, 8320T, 8330, 8330T, 8400, 8400T, 8410, 8410T, 8420, 8420T, 8430, 8430T, 8520, 8520T, 8530, 9100, 9120, 9200, 9220, 9230, 9300, 9300T, 9320, 9320T, 9330, 9400, 9400T, 9420, 9420T, 9430, 9430T, 9520, 9520T, 9530, 9530T, 9620, 9620T, 9630, 9630T, Premium Models: 7130, 7230, 7330, 7430, 7530, Combines: 9650CTS, 9650STS, 9750STS, Sprayers: 4630, 4710, 4720, 4730, 4830, 4920, 4930, 4940</p>	<p>Buddy Seat</p> <ul style="list-style-type: none"> • Fits tractors w/ passenger seat fender or cup holder fender • Seat cushion is 2" thick and has a wood core • Backrest is 13.5" x 13" and inset into a hard plastic frame • Backrest does not fold forward • Mesh document pouch • Seat belt included for added safety • Steel mounting plate <p>Replaces RE151331, RE192707, RE244303</p>	Brown Fabric AMSS8249	\$ 306.00
 <p>6105M, 6110, 6115M, 6120M, 6125M, 6130M, 6140J, 6140M, 6145M, 6150M, 6155J, 6155M, 6170M, 6175M, 6195M, 6200, 6210, 6230, 6300, 6310, 6330, 6400, 6405, 6410, 6420, 6430, 6500, 6605, 7130, 7210, 7220, 7230, 7320, 7330, 7410, 7420, 7510, 7520, 7530, 7600, 7610, 7700, 7710, 7800, 7810, Premium Models: 6230, 6330, 6430, 7130, 7230, 7330, 7430, 7530</p>	<p>Buddy Seat</p> <ul style="list-style-type: none"> • Durable, vacuum-formed cushions for long wear • Seat cushion is 15.50" x 12" • Backrest cushion is 9.50" x 8.50" • 20" tall, bottom of the mounting to the top of the backrest cushion • Seat cushion folds up to a width of 5" • Seat belt and brackets included for added safety <p>Note: will not fit if the tractor has a plastic inner fender panel</p> <p>Replaces AL119958, AL173569</p>	AMSS8495	\$ 255.00
	<p>Suspension For Suspended Buddy Seat</p>	AMAL112974	\$ 255.00
 <p>5065M, 5075M, 5082E, 5085E, 5085M, 5090E, 5090EH, 5093E, 5095M, 5095MH, 5100M, 5100MH, 5105M, 5115M, 5225, 5325, 5425, 5625, 5725, 6100D, 6100E, (6105D, 6115D, 6130, 6140D - iT4), (6105E, 6120E, 6135E - FT4), 6110D, 6110E, 6115D, 6115E, 6125D, 6125E, 6130D, 6130E, Sprayers: 4630, R4023</p>	<p>Buddy Seat</p> <p>Safety Labels, Seat Belt and Handle Not Included</p>	AMXVB25717	\$ 265.00
 <p>2140, 2350, 2355, 2550, 2555, 2750, 2755, 2855N, 2940, 2950, 2955, 3055, 3140, 3150, 3155, 3255, 4030, 4040, 4055, 4050, 4230, 4240, 4250, 4255, 4320, 4430, 4440, 4450, 4455, 4555, 4560, 4630, 4640, 4650, 4755, 4760, 4840, 4850, 4955, 4960, Combines: 6620, 7700, 7720, 8820, 9400, 9410, 9510, 9600, 9610, Cotton Pickers: 9935, 9940, 9950</p>	<p>Buddy Seat</p> <p>Replaces existing personal posture armrest to provide a full suspension buddy seat</p> <p>Seat back folds down to serve as an armrest</p>	Brown Fabric AMX6821	\$ 345.00

John Deere®—Seats and Suspensions

Seat Tops

	Application	Description	Part Number	Retail Price
	For Grammer Suspensions	Seat Assembly • Grammer 741 seat • Durable brown fabric covering • Cut-and-sew cushions for added comfort • Armrests • Backrest extension for extra backrest height • Operator presence switch	Brown Fabric AMSS11004	\$ 839.00
		Seat Assembly w/ Swivel	Brown Fabric AMSS11032	\$ 1054.00
	For Grammer Suspensions	Seat Assembly w/ Command Arm • Grammer 741 seat • Durable brown fabric covering • Cut-and-sew cushions for added comfort • Armrest • Backrest extension for extra backrest height • Operator presence switch	Brown Fabric AMSS11003	\$ 899.00
		Seat Assembly w/ Command Arm and Swivel	Brown Fabric AMSS11031	\$ 1050.00
	7200, 7210, 7400, 7410, 7510, 7600, 7610, 7700, 7710, 7800, 7810, 8100, 8100T, 8200, 8200T, 8300, 8300T, (8320RT, 8345R, 8345RT, 8370RT ASN 920001), 8400, 8400T, 8570, 8770, 8870, 8970, 9100, 9200, 9300, 9400	Seat Assembly For Sears Suspensions • Grammer 741 seat • Durable brown fabric covering • Cut-and-sew cushions for added comfort • Armrests • Backrest extension for extra backrest height • Operator presence switch Includes Installation Kit	Brown Fabric AMSS10042	\$ 910.00
	For Grammer Suspensions	Seat Assembly • Grammer 742 tall back seat • Durable brown matrix fabric covering • Armrests • Operator presence switch	Brown Matrix Fabric AMSS11056	\$ 807.00
		Seat Assembly w/ Swivel	Brown Matrix Fabric AMSS11058	\$ 894.00
	For Grammer Suspensions	Seat Assembly • Grammer 741 seat • Durable brown matrix fabric covering • Armrests • Backrest extension for extra backrest height • Operator presence switch	Brown Matrix Fabric AMSS11055	\$ 752.00
		Seat Assembly w/ Swivel	Brown Matrix Fabric AMSS11057	\$ 777.00
	For Grammer Suspensions	Seat Assembly • Grammer 731 seat • Durable brown matrix fabric covering • Armrests • Backrest extension for extra backrest height • Operator presence switch	Brown Matrix Fabric AMSS11070	\$ 670.00
		Seat Assembly w/ Swivel	Brown Matrix Fabric AMSS11071	\$ 741.00

John Deere®—Seats and Suspensions



	Application	Description		Part Number	Retail Price
	For Grammer Suspensions	Seat Assembly	Brown Matrix Fabric	AM1302891	\$ 450.00
		Backrest Extension	Brown Matrix Fabric	AM1201069	\$ 67.00
	4030, 4040, 4230, 4240, 4250, 4430, 4440, 4630, 4640, 4840, 4850, 8430, 8440, 8630, 8640, 8650, 8850	Seat Assembly Adapter Plate Included For Mechanical Suspensions Will Fit Narrow and Wide OEM Suspensions	Brown Matrix Fabric	AMSS10027	\$ 495.00
		Backrest Extension	Brown Matrix Fabric	AM1201069	\$ 67.00
	For Grammer Suspensions	Seat Assembly • Grammer 721 seat • Durable yellow vinyl covering • Armrests • Adjustable lumbar support	Yellow Vinyl	AMSS11075	\$ 525.00
		Seat Assembly w/ Swivel	Yellow Vinyl	AMSS11076	\$ 633.00
	For Grammer Suspensions	Seat Assembly • Grammer 731 seat • Durable black vinyl covering • Armrests • Adjustable lumbar support	Black Vinyl	AMSS11025	\$ 523.00
	For Grammer Suspensions	Seat Assembly • Grammer 731 seat • Durable black vinyl covering • Adjustable lumbar support	Black Vinyl	AM1205871	\$ 322.00
	4030, 4040, 4230, 4240, 4250, 4430, 4440, 4630, 4640, 4840, 4850, 8430, 8440, 8630, 8640, 8650, 8850	Seat Assembly For Tractors w/ Mechanical Suspension		AMJD4440-M	\$ 875.00
		Seat Assembly For Tractors w/ Hydraulic Suspension		AMJD4440-H	\$ 875.00
	2010, 2350, 2355, 2510, 2520, 2550, 2555, 2750, 2755, 2855N, 2940, 2950, 2955, 3010, 3020, 3055, 3140, 3150, 3155, 3255, 4000, 4010, 4020, 4025, 4030, 4040, 4050, 4055, 4230, 4240, 4250, 4255, 4320, 4430, 4440, 4450, 4455, 4520, 4555, 4560, 4620, 4630, 4640, 4650, 4755, 4760, 4840, 4850, 4955, 4960, 5010, 5020, 6030, 7020	Seat Assembly	Yellow Vinyl	AMJD4240YLV	\$ 634.00

John Deere®—Seats





Seats and Suspensions

Prices Subject to Change without Prior Notice. The use of original equipment manufacturer (OEM) part numbers or trademarks, e.g. Case® and John Deere®, are for reference purposes only and for indicating product use and compatibility. Our company and the listed replacement parts contained herein are not sponsored, approved or manufactured by the OEM. All parts are New unless designated Reman in the description.

John Deere®—Seats and Suspensions

	Application	Description	Part Number	Retail Price
	2955, 3055, 3150, 3155, 3255, 4020, 4030, 4040, 4050, 4055, 4230, 4240, 4250, 4255, 4320, 4430, 4440, 4450, 4455, 4555, 4560, 4630, 4640, 4650, 4755, 4760, 4840, 4850, 4955, 4960, 7200, (7210, 7410, 7610, 7710, 7810 - w/o Cab), 7400, 7510, 7600, 7700, 7800, Combines: 4420, 6620, 6622, 7720, 8820, Cotton Pickers: 9920, 9940, Cotton Stripper: 7440, Sprayer: 6000, Swathers: 2320, 2420, 3430, 3830	4-Piece Seat Assembly • Heavy duty yellow vinyl covering • Steel-back construction • High density foam cushions for added comfort	Yellow Vinyl AMSS7896	\$ 374.00
	Utility: 4105, 4200, 4210, 4300, 4310, 4400, 4410, 4500, 4510, 4600, 4610, 4700, 4710, Gator™ Utility Vehicles: 4x2 ASN 19951*, 6x4 ASN 20789*, Diesel Models ASN 2298* *Models with serial numbers prior to these listed will require an adapter bracket from John Deere®	Bucket Seat • Seat is 18.75" x 18.80" x 19" • Durable, blow-molded plastic frame is corrosion resistant • Multiple mounting patterns • Accepts twist-in-mount operator presence switch	Yellow Vinyl AMSS7927	\$ 70.00
	For Grammer S7X2 High Back Seat Assemblies	Seat Frame, High Back S7X2 Frame Only, Cushions Not Included Includes Seat Frame, Mechanical Lumbar, Slide Rails and Literature Box	AM1125651	\$ 245.00

Seat Cushions

	Application	Description	Part Number	Retail Price
	For Grammer Cut-and-Sew Seat Assemblies	Seat Back Seat Cushion 74X	Brown Fabric AM1341008 Brown Fabric AM1341009	\$ 172.00 \$ 206.00
	For Grammer Seat Assemblies	Seat Back	Brown Matrix Fabric AM1263102	\$ 147.00
	For Grammer Seat Assemblies	Seat Back Replacement seat back for Grammer 742 seat assembly • Durable brown matrix fabric covering	Brown Matrix Fabric AM1396565	\$ 139.00
	For Grammer 731 Seat Assemblies	Seat Cushion w/o cut out for seat depth/tilt	Brown Matrix Fabric AM1210103	\$ 130.00





John Deere®—Seats and Suspensions

John Deere®—Seats

Seats and Suspensions

	Application	Description		Part Number	Retail Price
	For Grammer 741 and 742 Seat Assemblies	Seat Cushion	Brown Matrix Fabric	AM1263101	\$ 155.00
	(5065M, 5075M (iT4), 5083E, 5083E Limited, 5085M (Tier 3 or iT4), 5093E, 5093E Limited, 5095M, 5095MH, 5100M (iT4), 5100MH (iT4), 5101E, 5101E Limited, 5105M, 6100D, 6100E, 6105D, 6105E, 6110, 6110D, 6110E, 6115D, 6120, 6120E, 6125D, 6125E, 6130D, 6130E, 6140D, 6210, 6215, 6220, 6310, 6310S, 6320, 6320L, 6410, 6410S, 6415, 6420, 6420L, 6510S, 6520L, 6615, 6715, 7220, 7320, 7420, 7520 - w/ Cab)	Seat Back For 7X1 Grammer Seat Assemblies	Alaska Brown Cloth	AMAL116984	\$ 158.00
	5210, 5310, 5410, 5510	Seat Back	Alaska Brown Cloth	AMRE181808	\$ 90.00
	7200R, 7210R, 7215R, 7230R, 7250R, 7260R, 7280R, 7290R, 7310R, 8345R, 8370R, 8400R, (8245R, 8270R, 8295R, 8320R, 8335R ASN 090000), (8320RT, 8345RT, 8370RT SN 912001-920000)	Seat Cushion For Grammer Seat Assemblies with Passive Fabric Seat and Adjustable Cushion	Alaska Brown Cloth	AMRE334548	\$ 575.00
	For Grammer 721, 731 and 741 Seat Assemblies	Seat Back	Black Vinyl	AM141730	\$ 112.00
	For Grammer 731 Seat Assemblies	Seat Cushion w/o cut out for seat depth/tilt	Black Vinyl	AM1014238	\$ 103.00
	For Grammer 731 Seat Assemblies	Seat Cushion w/ cut out for seat depth/tilt	Black Vinyl	AM1014726	\$ 117.00
	For Grammer 741 and 742 Seat Assemblies	Seat Cushion w/ cut out for seat depth/tilt	Black Vinyl	AM1344807	\$ 92.00
	For Grammer DS44/1 Seat Assemblies	Seat Cushion	Black Vinyl	AM1169038	\$ 75.00
		Seat Back Trapeze Backrest	Black Vinyl	AM1169040	\$ 62.00
	For Grammer DS44/1 Seat Assemblies	Seat Back	Black Vinyl	AM128389	\$ 88.00
		Seat Cushion	Black Vinyl	AM122200	\$ 83.00
	For Grammer DS44/2 Seat Assemblies	Seat Back	Black Vinyl	AM122198	\$ 63.00

John Deere®—Seats and Suspensions





	Application	Description	Part Number	Retail Price	
	5210, 5220, 5310, 5320, 5410, 5420, 5510, 5520	Seat Cushion For Grammer DS44/IHB Seat Assemblies Replaces 127420, 13441274, 82983701	Black Vinyl AMRE181809	\$ 83.00	
	7130, 7185J, 7195J, 7205J, 7210J, 7225J, 7230, 7330, 7430, 7530, 7630, 7715, 7720, 7730, 7815, 7820, 7830, 7920, 7930, 8110, 8110T, 8120, 8120T, 8130, 8210, 8210T, 8220, 8220T, 8230, 8230T, 8310, 8310T, 8320, 8320T, 8330, 8330T, 8410, 8410T, 8420, 8420T, 8430, 8430T, 8520, 8520T, 8530, 9100, 9120, 9200, 9220, 9230, 9300, 9300T, 9320, 9320T, 9330, 9400, 9400T, 9420, 9420T, 9430, 9430T, 9520, 9520T, 9530, 9530T, 9620, 9620T, 9630, 9630T	2-Piece Cushion Set Includes Seat Cushion, Backrest and Mounting Hardware For Sears Seats Only Replaces RE168331, RE239595, RE312760	Brown Fabric AMSS8512	\$ 453.00	
	(2140, 3040 ASN 43000), 2350, 2355, 2550, 2555, 2750, 2755, 2855N, 2940, 2950, 2955, 3150, 3155, 3255, 4030, 4040, 4040S, 4050, 4055, 4230, 4240, 4240S, 4250, 4255, 4350, 4430, 4440, 4450, 4455, 4555, 4560, 4630, 4640, 4650, 4755, 4760, 4840, 4850, 4955, 4960, 7200, (7210, 7410, 7610, 7710, 7810 - w/ Cab), 7400, 7510, 7600, 7700, 7800, 8100, 8100T, 8200, 8200T, 8300, 8300T, 8400, 8400T, 8430, 8440, 8450, 8560, 8570, 8630, 8640, 8650, 8760, 8770, 8850, 8960, 8970, 9100, 9200, 9300, 9400, Combines: 4400, 4420, 6620, 6622, 7720, 8820, Cotton Picker: 9920, 9930, 9940, 9950, 9960, Cotton Strippers: 7440, 7445, Forage Harvesters: 5420, 5440, 5460, 5720, 5730, 5820, 5830, Sprayers: 4700, 4710, 6000, 6100, 6500, 6600, 6700, Swathers: 2280, 3430, 3830, 4890, 4990	Seat Back w/ Lumbar Adjustment Seat Back w/o Lumbar Adjustment Seat Cushion, Hydraulic* Seat Cushion, Mechanical* *Cushions only, no armrests	Brown Fabric Brown Fabric Brown Fabric Brown Fabric	AMSPJD47B AMJDPPB-M AMSPJD47S-H AMSPJD47S-M	\$ 174.00 \$ 124.00 \$ 124.00 \$ 124.00
	5220, 5225, 5320, 5325, 5420, 5425, 5520, 5525, 5625, 6110, 6110L, 6120, 6120L, 6200, 6200L, 6210, 6210L, 6215, 6220, 6220L, 6300, 6300L, 6310, 6310L, 6320, 6320L, 6400, 6400L, 6410, 6410L, 6403, 6405, 6415, 6420, 6420L, 6420S, 6500, 6500L, 6520L, 6603, 6605, 6615, 6715	Seat Back For SuperComfort™ Seat Seat Cushion For SuperComfort™ Seat	Yellow Vinyl Yellow Vinyl	AMAL117331 AMAL117332	\$ 85.00 \$ 85.00
	2510, 2520, 3010, 3020, 4000, 4010, 4020, 4030, 4230, 4320, 4430, 4520, 4620, 4630, 5010, 5020, 6030, 7020, 7520	3-Piece Cushion Set 3-Piece Economy Cushion Set Seat Back, Small Upper Seat Back, Large Middle Seat Cushion Seat Brackets	Yellow Vinyl Yellow Vinyl Yellow Vinyl Yellow Vinyl Yellow Vinyl	AMJD4010N AMJD4010NA AMJD4010SB AMJD4010LB AMJD4010S AMJD4010BRK	\$ 389.00 \$ 140.00 \$ 63.00 \$ 209.00 \$ 127.00 \$ 88.00

Prices Subject to Change without Prior Notice. The use of original equipment manufacturer (OEM) part numbers or trademarks, e.g. Case® and John Deere®, are for reference purposes only and for indicating product use and compatibility. Our company and the listed replacement parts contained herein are not sponsored, approved or manufactured by the OEM. All parts are New unless designated Reman in the description.

John Deere®—Seats and Suspensions

John Deere®—Seats



Seats and Suspensions

	Application	Description		Part Number	Retail Price
	2040, 2150, 2255, 2340, 2350, 2355, 2550, 2555, 2750, 2755, 2840, 2855, 2940, 2950, 2955, Utility: 2240	Seat Back	Yellow Vinyl	AMJD2940B	\$ 116.00
		Seat Cushion	Yellow Vinyl	AMJD2940S	\$ 146.00
	1020, 1520, 1530, 2020, 2030, 2040, 2630, 2640, Utility: 2240 BSN 34099	Seat Back	Yellow Vinyl	AMJD2020B	\$ 264.00
		Seat Cushion	Yellow Vinyl	AMJD2020S	\$ 146.00
	420, 430, 520, 530, 620, 630, 720, 730, Utility: 820, 830	Seat Back	Yellow Vinyl	AMJD720B	\$ 67.00
		Seat Cushion	Yellow Vinyl	AMJD720S	\$ 78.00
		Dimensions are required Armrests (Pair)	Yellow Vinyl	AMJD720AR	\$ 100.00
	50, 60, 70, 80, 520, 530, 620, 630, 720, 730, 840 Standard, A, AR, B, D, G, R, Utility: 820, 830	Seat Back	Yellow Vinyl	AMAR21966	\$ 60.00
		Seat Cushion	Yellow Vinyl	AMAR30181	\$ 78.00
	Gator™ Utility Vehicles: (4X2 HPX, 4X4 HPX ASN 090001), 4X4 Trail HPX ASN 090001 w/ Gas, HPX615E, HPX815E, XUV 625I, XUV 825E, XUV 825I, XUV 825I S4, XUV 825M, XUV 825M S4, XUV 855D, XUV 855D S4, XUV 855E, XUV 855M, XUV 855M S4	Bench Seat Back w/ Metal Frame 15.50" x 43" Cushion Dimensions	Yellow Vinyl	AMAM140623	\$ 256.41
		Bench Seat Cushion 17.50" x 44" Cushion Dimensions	Yellow Vinyl	AMAM140624	\$ 227.33
	Gator™ Utility Vehicles: (4X2 HPX, 4X4 HPX ASN 090001), 4X4 Trail HPX ASN 090001 w/ Gas, Military 4X4 A2, Military 4X4 A3, Military A3 T, XUV 625I, XUV 825E, XUV 825I, XUV 825I S4, XUV 825M, XUV 825M S4, XUV 855D, XUV 855D S4, XUV 855E, XUV 855M, XUV 855M S4	Bench Seat Back w/ Metal Frame 15.50" x 43" Cushion Dimensions	Black Vinyl	AMAM140945	\$ 274.36
		Bench Seat Cushion 17.50" x 44" Cushion Dimensions	Black Vinyl	AMAM140946	\$ 227.33





Suspensions

Application	Description	Part Number	Retail Price
For Grammer Seat Assemblies	Suspension, Air • Grammer MSG97G air suspension • Front controls • Suspension stroke up to 7" • Adjustable to suit driver's weight from 110 to 485 lbs • Fore/aft adjustment • Height adjustment up to 3.10" • Shock absorber	AM1378253	\$ 699.25
For Grammer Seat Assemblies	Suspension, Air For 24 Volt Systems • Grammer MSG97G air suspension • Self-contained 24-volt compressor • Front controls • Suspension stroke up to 7" • Adjustable to suit driver's weight from 110 to 485 lbs • Fore/aft adjustment • Height adjustment up to 3.10" • Shock absorber	AM1338593	\$ 681.75

John Deere®—Seats and Suspensions

Application	Description	Part Number	Retail Price
For Grammer Seat Assemblies	Suspension, Air For 24 Volt Systems • Grammer MSG97 low-frequency air suspension • Self-contained 24-volt compressor • Frame width of 17" • Front controls • Fore/aft isolator • Suspension stroke up to 7" • Height adjustment up to 3.10" • Adjustable to suit driver's weight from 100 to 400 lbs • Weight indicator • Shock absorber	AM1241742	\$ 470.00
 For Grammer Seat Assemblies	Suspension w/ Wiring Harness, Air • Grammer MSG95GL DDS air suspension • Suspension stroke of 100 mm • Fore/aft adjustment	AMSS11016	\$ 619.00
 For Grammer Seat Assemblies	Suspension, Air • Grammer MSG95G air suspension • Frame width of 11.75" • Side controls • Fore/aft isolator • Air suspension w/ suspension travel of 4" • Suspension stroke up to 7" • Adjustable to suit driver's weight from 110 to 285 lbs • Weight indicator • Shock absorber	AM1319704	\$ 536.51
 For Grammer Seat Assemblies	Suspension, Air • Grammer MSG95G air suspension • Frame width of 11.75" • Front controls • Fore/aft isolator • Air suspension w/ suspension travel of 4" • Suspension stroke up to 7" • Adjustable to suit driver's weight from 110 to 285 lbs • Weight indicator • Shock absorber	AM1319705	\$ 617.00
Combines: S650 w/ Premium or Leather Seat, S690, (S660, S670, S670HM, S680, S680HM, S690HM - w/o Premium Heated Seat), (S760, S770, S780, S790 - w/o Premium Leather Seat), Forage Harvesters: (8100, 8200, 8300, 8400, 8500, 8600, 8700, 8800, 9600, 9700, 9800, 9900 - w/ Premium or Leather Seat), Sprayers: 4030 BSN 182001, R4038 BSN 184001, R4045 BSN 186001, R4060 BSN 184001 w/ Premium Seat, Swathers: W235, W235D, W260	Suspension, Air • Grammer MSG95G air suspension • Frame width of 11.75" • Side controls • Fore/aft isolator • Air suspension w/ suspension travel of 4" • Suspension stroke up to 7" • Adjustable to suit driver's weight from 110 to 285 lbs • Weight indicator • Adjustable shock absorber	AMAL210546	\$ 649.00

John Deere®—Seats and Suspensions



Application	Description	Part Number	Retail Price
 <p>For Grammer Seat Assemblies</p>	<p>Suspension, Air For 24 Volt Systems</p> <ul style="list-style-type: none"> • Grammer MSG95G air suspension • Self-contained 24-volt compressor • Frame width of 11.75" • Side controls • Fore/aft isolator • Air suspension with suspension travel of 4" • Suspension stroke up to 7" • Adjustable to suit driver's weight from 110 to 285 lbs • Weight indicator • Shock absorber 	AM1319709	\$ 583.00
 <p>For Grammer Seat Assemblies</p>	<p>Suspension, Air</p> <ul style="list-style-type: none"> • Grammer MSG93 compact air suspension • Frame width of 8.92" • Front controls • Manual weight adjustment w/ push-pull switch control 	AM1225983	\$ 528.27
 <p>5065M, 5075M, 5085M, 5095M, 5095MH, 5105M, 6100, 6100D, 6110, 6110D, 6110L, 6115D, 6115M, 6120, 6125D, 6130D, 6130M, 6140D, 6200, 6210, 6210L, 6215, 6220, 6230, 6300, 6310, 6310L, 6310S, 6320, 6320L, 6330, 6400, 6410, 6410L, 6410S, 6415, 6420, 6420L, 6430, 6500, 6510, 6510L, 6520L, 6615, 6715, 6920, 7130, 7220, 7230, 7320, 7330, 7420, 7430, 7520, 7530, 7720, 7820</p>	<p>Suspension, Air</p> <ul style="list-style-type: none"> • Grammer MSG95G air suspension • Fore/aft isolator • Air suspension w/ suspension travel of 4" • Suspension stroke up to 7" • Adjustable to suit driver's weight from 110 to 285 lbs • Weight indicator • Shock absorber • Compatible w/ original OEM seat • Direct replacement for original suspension 	AMSJ292625	\$ 569.44
 <p>For Grammer Seat Assemblies</p>	<p>Suspension, Mechanical</p> <ul style="list-style-type: none"> • Grammer MSG87 mechanical suspension • Height adjustment up to 3.10" • Suspension stroke up to 7" • Adjustable to suit driver's weight from 110 to 400 lbs • Weight indicator 	AM1347434	\$ 683.08
 <p>For Grammer Seat Assemblies</p>	<p>Suspension, Mechanical</p> <ul style="list-style-type: none"> • Grammer MSG85 mechanical suspension • Frame width of 11.75" • Suspension travel of 4" • Suspension stroke up to 7" • Flip-handle weight adjustment from 110 to 285 lbs • Weight indicator • Three-position height adjustment of 3" 	AM1201579	\$ 354.00
For Grammer Seat Assemblies	<p>Suspension, Mechanical</p> <ul style="list-style-type: none"> • Grammer MSG83 compact mechanical suspension • Flip-handle weight adjustment • Front weight indicator • Three-position height adjustment • Frame width of 8.92" 	AM1225985	\$ 364.00

John Deere®—Seats and Suspensions

Application	Description	Part Number	Retail Price
 <p>2750, 2755, 2950, 2955, 3030, 3040, 3130, 3140, 3150, 4000, 4030, 4040, 4050, 4055, 4230, 4240, 4250, 4255, 4430, 4440, 4450, 4455, 4560, 4630, 4640, 4650, 4755, 4760, 4840, 4850, 4955, 4960 - w/ Wide 11" Seat Well</p>	<p>Suspension, Air Conversion Kit</p> <ul style="list-style-type: none"> • Plug-and-play • Grammer MSG93 compact air suspension • Easily accessible front controls • Manual weight adjustment with push-pull switch control • Air suspension with 12-volt compressor • Frame width of 8.92" <p>Includes Grammer MSG93 Compact Air Suspension, Seat Adapter Plate, Pedestal, Slide Rail Kit, Mounting Hardware and Installation Instructions</p>	AMSS10023	\$ 700.00
 <p>3030, 3130, 4030, 4230, 4430, 4630 - Early w/ Narrow 7" Seat Well</p>	<p>Suspension, Mechanical Conversion Kit</p> <ul style="list-style-type: none"> • Grammer MSG83 compact mechanical suspension • Flip-handle weight adjustment • Front weight indicator • Three-position height adjustment • Frame width of 8.92" <p>Includes Grammer MSG83 Compact Mechanical Suspension, Seat Adapter Plate, Pedestal, Slide Rail Kit, Mounting Hardware and Installation Instructions</p>	AMSS10021	\$ 610.00
 <p>2510, 2520, 3010, 3020, 4000, 4010, 4020, 4320</p>	<p>Suspension, Mechanical Conversion Kit</p> <ul style="list-style-type: none"> • Grammer MSG83 compact mechanical suspension • Flip-handle weight adjustment • Front weight indicator • Three-position height adjustment • Compact mechanical suspension • Frame width of 8.92" <p>Includes Grammer MSG83 Compact Mechanical Suspension, Seat Adapter Plate, Pedestal, Slide Rail Kit, Mounting Hardware and Installation Instructions Note: Some restriction to use of tool box</p>	AMSS10056	\$ 795.00
 <p>2750, 2755, 2950, 2955, 3030, 3040, 3130, 3140, 3150, 4000, 4030, 4040, 4050, 4055, 4230, 4240, 4250, 4255, 4430, 4440, 4450, 4455, 4560, 4630, 4640, 4650, 4755, 4760, 4840, 4850, 4955, 4960 - w/ Wide 11" Seat Well</p>	<p>Suspension, Mechanical Conversion Kit</p> <ul style="list-style-type: none"> • Grammer MSG83 compact mechanical suspension • Flip-handle weight adjustment • Front weight indicator • Three-position height adjustment • Frame width of 8.92" <p>Includes Grammer MSG83 Compact Mechanical Suspension, Seat Adapter Plate, Pedestal, Slide Rail Kit, Mounting Hardware and Installation Instructions</p>	AMSS10024	\$ 535.00

Application	Description	Part Number	Retail Price
 8430, 8440, 8630, 8640	Suspension, Air Ride Conversion Kit Includes Air Ride Suspension, (3) Seat Adapter Plates, Adapter Bracket and Slide Rail Kit	AMSS6622	\$ 1118.00
 4030, 4230, 4430, 4630	Reman Suspension, Complete Assembly Early, Narrow 7" Base Suspension	AMX6823	\$ 895.00
 4030, 4230, 4430, 4630	Reman Suspension, Complete Suspension Late, Wide 11" Base Suspension	AMSS6703	\$ 895.00
 2510, 3010, 3020 BSN 122999, 4020 BSN 200999, 5010, 5020	Reman Suspension, Complete Assembly	AMSS6700	\$ 895.00
 2520, 3020 ASN 123000, 4020 ASN 201000, 4320	Reman Suspension, Complete Assembly	AMSS6701	\$ 895.00





Seat and Suspension Components

Application	Description	Part Number	Retail Price
 For Grammer Cut-and-Sew Seat Assemblies	Replacement Backrest Extension	Brown Fabric AM1392323	\$ 112.50
 For Grammer Suspensions	Backrest Extension	Brown Matrix Fabric AM1201069	\$ 67.00





John Deere®—Seats and Suspensions

	Application	Description	Part Number	Retail Price
	For Grammer 500 and 700 Series Seat Assemblies	Backrest Extension Black Vinyl	AM1092126	\$ 89.00
	For Grammer 721, 722, 731, 732, 741 and 742 Seat Assemblies	Armrest, Right Hand	AM1023155	\$ 65.00
		Armrest, Left Hand A60/380, 60 mm x 380 mm	AM1023156	\$ 65.00
	For Grammer 721, 722, 731, 732, 741 and 742 Seat Assemblies	Armrest, Right Hand	AM1026779	\$ 70.00
		Armrest, Left Hand Tilttable, Adjustable Height Bracket 80 mm x 380 mm	AM1026778	\$ 70.00
	For Grammer DS44/1 and DS44/1HB Seat Assemblies	Armrest, Right Hand	AM1186403	\$ 42.50
		Armrest, Left Hand	AM1186402	\$ 42.50
	For Grammer MSG85 and MSG95 Suspensions	Swivel Kit	AM134958	\$ 169.00
	5065M, 5075M, 5085E, 5085M, 5090E, 5090EL, 5090M, 5095MH, 5100E, 5100M, 5100MH, 5105M, 5115M, 6105M, 6110, 6110L, 6110M, 6115M, 6120M, 6120L, 6210, 6210L, 6125M, 6130, 6130M, 6140M, 6145M, 6150M, 6155M, 6175M, 6195M, 6215, 6220, 6220L, 6230, 6310, 6310L, 6310S, 6320, 6320L, 6330, 6410, 6410L, 6410S, 6415, 6420, 6420L, 6430, 6510L, 6510S, 6520L, 6615, 6715, 7130, 7220, 7230, 7320, 7330, 7420, 7520, Premium Models: 6230, 6330, 6430, 7130, 7230, 7330, 7430, 7530	Swivel Plate For 721, 722, 731, 732, 741 and 742 Seat Assemblies w/ Integrated Swivel	AMAL117351	\$ 62.00
	For Grammer MSG85, MSG95 and MSG95GL DDS Suspensions	Side-to-Side Isolator	AM1139345	\$ 294.00
	For Grammer 721, 722, 731, 732, 741 and 742 Seat Assemblies	Seat Depth and Tilt Adjustment Kit	AM1040538	\$ 122.00
	6110M, 6110R, 6120M, 6120R, 6130M, 6130R, 6140M, 6145M, 6145R, 6155M, 6155R, 6155RH, 6175M, 6175R, 6195M, 6195R, 6215R, 6250R	Seat Depth and Tilt Bezel and Lever Kit For Grammer 721, 722, 731, 732, 741 and 742 Seat Assemblies	AMF073716	\$ 35.00
	For Grammer MSG97 12 Volt Suspensions Will not work on 24 Volt Suspensions	Heated Switch Kit	AM1250169	\$ 70.00
	For Grammer MSG83, MSG85, MSG93 and MSG95GL DDS Suspensions	Slide Rail Kit	AM140733	\$ 78.00



John Deere®—Seats and Suspensions

Application	Description	Part Number	Retail Price
6105M, 6110, 6110L, 6110M, 6120, 6120M, 6125M, 6130M, 6140M, 6145M, 6150M, 6155M, 6170M, 6175M, 6195M, 6200L, 6210, 6210L, 6215, 6220, 6220L, 6230, 6300L, 6310, 6310L, 6310S, 6320, 6320L, 6330, 6400L, 6405, 6410, 6410L, 6410S, 6415, 6420, 6420L, 6430, 6500L, 6510L, 6510S, 6520L, 6605, 6615, 6715, 7130, 7220, 7230, 7320, 7330, 7420, 7520, Premium Models: 6230, 6330, 6430, 7130, 7230, 7330, 7430, 7530, Combines: 9780CTS, C670, T550, T560, T660, T670, Cotton Pickers: 9986, 9996, Cotton Stripper: 7460, Forage Harvesters: 7180, 7200, 7250, 7280, 7300, 7380, 7400, 7450, 7480, 7500, 7550, 7580, 7700, 7750, 7780, 7800, 7850, 7950	Tension Spring For Grammer MSG85 Suspensions	AMT82227	\$ 19.00
5083E, 5093E, 5101E, 5220, 5225, 5320, 5320N, 5325, 5420, 5420N, 5425, 5520, 5520N, 5525, 5603, 5625, 6105L, 6105M, 6110, 6110L, 6110M, 6120, 6120L, 6125M, 6130M, 6140M, 6145M, 6150M, 6155M, 6200, 6200L, 6210, 6210L, 6215, 6220, 6220L, 6230, 6300, 6300L, 6310, 6310L, 6310S, 6320, 6320L, 6330, 6400, 6400L, 6405, 6410, 6410L, 6410S, 6415, 6420, 6420L, 6430, 6500, 6500L, 6510S, 6520L, 6600, 6603, 6605, 6615, 6715, 7130, 7230, 7330, 7500, Premium Models: 6230, 6330, 6430	Tension Spring For Grammer MSG83 Suspensions	AML114921	\$ 13.80
 Universal Equipment	Seat Belt, Retractable 55" long from bolt hole to hold hole when extended out	AMX6824	\$ 44.00
 For Grammer Seat and Suspension Assemblies	Seat Belt, Retractable	AM902133	\$ 103.00
 For Grammer Seat and Suspension Assemblies w/ Command Arm Bracket	Seat Belt	AM902131	\$ 104.00
 For Grammer 721, 731 and 741 Seat Assemblies	Literature Box Kit	AMAL117363	\$ 28.00
5220, 5225, 5320, 5325, 5420, 5425, 5520, 5525, 5625, 6130, 6230, 6330, 6430, 7130, 7230, 7330	Compressor For Grammer MSG93 Suspensions	AMAL117313	\$ 144.00
 For Grammer MSG95 Suspensions	Air Level Control Switch	AM345107A1	\$ 70.00

John Deere®—Seats and Suspensions

	Application	Description	Part Number	Retail Price
	5065M, 5075M, 5085M, 5090M, 5095M, 5095MH, 5100M, 5100MH, 5105M, 5115M, 6100E, (6105D, 6115D, 6130D, 6140D ASN 060000), 6105E, 6110, 6110E, 6115E, 6120, 6125E, 6130E, 6135E, 6200, 6210, 6215, 6220, 6230, 6300, 6310, 6310S, 6320, 6320L, 6330, 6400, 6410, 6410S, 6415, 6420, 6420L, 6430, 6500, 6510S, 6520L, 6615, 6715, 7130, 7230, 7330, Combines: 9780CTS ASN 072800, C670, T550, T560, T660, T670	Air Hose Kit For Grammer MSG95 Suspensions	AMAL166451	\$ 65.00
	5220, 5225, 5310, 5320, 5325, 5410, 5420, 5425, 5510, 5520, 5525, 5625, 6230, 6330, 6430, 7130, 7230, 7330	Air Hose Kit Replaces 1159864, AL117315	AMAL180863	\$ 46.25
	For Grammer MSG95, MSG95AL and MSG97AL Suspensions	Air Level Control Mechanism Replacement Control Unit w/ Black Powder Coat Finish 12 Volt	AMAL166452	\$ 222.00
	5065M, 5075M, 5085M, 5090M, 5095MH, 5100M, 5100MH, 5105M, 5115M, 6100D, 6100E, 6105D, 6105E, 6110D, 6110E, 6115D, 6115E, 6120E, 6125D, 6130, 6130D, 6130E, 6135E, 6140D, 6215, 6415, 6230, 6330, 6430, 6615, 6715, 7130, 7230, 7330, Premium Models: 6230, 6330, 6430, Sprayers: 4630, 4730, 4830, Swathers: 4895, 4990, 4995	Air Spring For Grammer MSG95A, MSG95G, MSG95GL DDS and MSG97A Suspensions Early Style Universal Air Spring Tee Fitting at Top Mount Includes Plug Fittings for extra Air Ports not used Air Lines Not Included	AMAL166455	\$ 153.00
	For Grammer 721, 722, 731, 732, 741 and 742 Seat Assemblies	Operator Presence Switch Kit	AM139267	\$ 65.00
	Tractors: 6105M, 6105R, 6110M, 6110R, 6115M, 6120M, 6120R, 6125M, 6125R, 6130M, 6130R, 6140M, 6140R, 6145M, 6145R, 6150R, 6150RH, 6155M, 6155R, 6155RH, 6170M, 6170R, 6175M, 6175R, 6190R, 6195M, 6195R, 6210R, 6215R, 6230R, 6250R, 7210R, 7230R, 7250R, 7270R, 7290R, 7310R, 8245R, 8270R, 8295R, 8320R, 8320RT, 8335R, 8345R, 8345RT, 8370R, 8370RT, 8400R, Combines: 9570STS, 9760STS, 9770STS, 9780CTS, 9870STS, S540, S550, S650, S660, S670, S670HM, S680, S680HM, S690, S690HM, S760, S770, S780, S785, S790, Forage Harvesters: 8100, 8200, 8300, 8400, 8500, 8600, 8700, 9600, 9700, 9800, 9900, Sprayers: R4030, R4038, R4044, R4045, R4060, Swathers: W235, W260	Wiring Harness For Grammer MSG95G Suspensions	AMAL210459	\$ 34.00



John Deere®—Seats and Suspensions

Application	Description	Part Number	Retail Price
 <p>For Grammer MSG85 Mechanical Suspensions</p>	Suspension Rebuild Kit Includes Adjusting Shaft, Clevis, Spindle, Springs, Weight Indicator and Hardware	AM1163691	\$ 68.00
 <p>6105M, 6115M, 6125M, 6130M, 6140M - w/ Open Station and MSG85/731 Seat Assembly</p>	Swivel Handle For Grammer 721, 722, 731, 732, 741 or 742 Seat Assemblies w/ Integrated Swivel	AMAL216582	\$ 50.00
 <p>6110, 6120, 6200, 6210, 6215, 6220, 6230, 6300, 6310, 6310S, 6320, 6320L, 6330, 6400, 6410, 6410S, 6415, 6420, 6420L, 6430, 6500, 6510S, 6520L, 6615, 6715, 7130, 7210R, 7230, 7230R ASN 080000, 7250R, 7270R, 7290R, 7310R, 7330, (8245R, 8270R, 8295R, 8335R, 8345R ASN 090000), 8320R, (8320RT, 8345RT SN 912001-920000), 8370R, 8370R BSN 920001, 8400R, Premium Models: 6230, 6330, 6430, Combines: 9560STS, 9570STS, 9670STS, 9770STS, 9860STS, 9870STS, S550, S650, S660, S670, S670HM, S680, S680HM, S690, S690HM, S760, S770, S780, S790, Cotton Pickers: 7760, CP690, Cotton Strippers: 7460, CS690, Forage Harvesters: 8100, 8200, 8300, 8400, 8500, 8600, 8700, 8800, 9600, 9700, 9800, 9900, Sprayers: 4830, 6700, R4030, R4038, R4044, R4045, R4060, Swathers: W235, W235D, W260</p>	Fore/Aft Shock Absorber For Grammer MSG95G or MSG95GI DDS Suspensions	AMAL210538	\$ 95.00







John Deere®—Seats

Seats and Suspensions

John Deere®—Seats and Suspensions

Application	Description	Part Number	Retail Price
 <p>5065M, 5075M Excluding FT4, 5085M, 5090M, 5095M, 5095MH, 5100M, 5100MH, 5105M, 5115M, 6105D, 6110, 6110E, 6115E, 6120, 6120E, 6125E, 6130D (IT4), 6130E, 6135E, 6140D ASN 050000, 6200, 6210, 6215, 6220, 6230, 6300, 6310, 6310S, 6320, 6320L, 6330, 6400, 6410, 6410S, 6415, 6420, 6420L, 6430, 6500, 6510S, 6520L, 6615, 6715, 7130, 7210R, 7230, 7230R ASN 080000, 7250R, 7270R, 7290R, 7310R, 7330, (8245R, 8270R, 8295R, 8335R, 8345R ASN 090000), 8320R, (8320RT, 8345RT SN 912001-920000), 8370R, 8370RT BSN 920001, 8400R, Premium Models: 6230, 6330, 6430, Combines: 9560STS, 9570STS, 9670STS, 9770STS, 9860STS, 9870STS, S650, S660, S670, S670HM, S680, S680HM, S690, S690HM, S760, S770, S780, S790, Cotton Pickers: 7760, 9986, 9996, CP690, Cotton Strippers: 7460, CS690, Forage Harvesters: 8100, 8200, 8300, 8400, 8500, 8600, 8700, 8800, 9600, 9700, 9800, 9900, Sprayers: 4630, 4830, 6700, R4030, R4038, R4044, R4045, R4060, Swathers: W235, W235D, W260</p>	Fore/Aft Isolator Kit For Grammer MSG95 and MSG97 Suspensions	AMAL210537	\$ 167.00
 <p>5090R, 5100R, 5115R, 5115RH, 5125R, 6105M, 6105R, 6110M, 6110R, 6115M, 6115R, 6120M, 6120R, 6125M, 6125R, 6130M, 6130R, 6140M, 6140R, 6145M, 6145R, 6150M, 6150R, 6150RH, 6155M, 6155R, 6155RH, 6170M, 6170R, 6175M, 6175R, 6190R, 6195M, 6195R, 6210R, 6215R, 6230R, 6250R, 7220, 7320, 7420, 7520</p>	Adapter Cable For Grammer MSG95GL DDS Suspensions	AMAL210465	\$ 85.00
<p>5065M, 5075M, 5085M, 5090M, 5095MH, 5100M, 5100MH, 5105M, 5115M, 6100D, 6100E, 6105D, 6105E, 6110D, 6110E, 6115D, 6115E, 6120E, 6125D, 6125E, 6130D, 6130E, 6135E, 6140D, Sprayers: 4720, 4630, 4730, 4830, 4920, 4930, 4940, 6700</p>	Rubber Boot For Grammer MSG95G Suspensions	AMAT177339	\$ 144.00
 <p>5083E, 5093E, 5101E, 5220, 5225, 5320, 5325, 5420, 5420N, 5425, 5520, 5520N, 5525, 5603, 5625, 6105M, 6110, 6110L, 6110M, 6115M, 6120, 6120L, 6120M, 6125M, 6130M, 6140M, 6145M, 6150M, 6155M, 6200, 6200L, 6210, 6210L, 6215, 6220, 6220L, 6230, 6300, 6300L, 6310, 6310L, 6310S, 6320, 6330, 6400, 6400L, 6403, 6405, 6410, 6410L, 6410S, 6415, 6420, 6420L, 6430, 6500, 6500L, 6510L, 6520L, 6600, 6603, 6605, 6615, 6715, 7130, 7230, 7330, 7500, Premium Models: 6230, 6330, 6430</p>	Rubber Boot For Grammer MSG83 Suspensions	AMAL117270	\$ 52.00





John Deere®—Seats and Suspensions

	Application	Description	Part Number	Retail Price
	5220, 5225, 5320, 5325, 5420, 5425, 5500, 5520, 5625, 6130, 6230, 6430, 7130, 7230, 7330	Rubber Boot For Grammer MSG93 Suspensions	AMAL117322	\$ 48.00
	Combines: 9570STS, 9670STS, 9780CTS, 9870STS, C670, S550, S660, S670, S670HM, S680, S680HM, S690, S690HM, S760, S770, S780, S785, S790, T550, T560, T660, T670, Forage Harvesters: 8100, 8200, 8300, 8400, 8500, 8600, 8700, 8800, 9600, 9700, 9800, 9900, Swathers: W235, W260	Rubber Boot For Grammer MSG95G Suspensions	AMAL210536	\$ 94.00
	1020, 1520, 2010, 2020, 2030, (2140, 3040, 3140 ASN 430000), (2440, 2640 BSN 341000), 2510, 2520, 2550, 2630, 2750, 2940, 2950, 3010, 3020, 4000, 4010, 4020, 4030, 4040, 4050, 4055, 4230, 4240, 4250, 4255, 4320, 4430, 4440, 4450, 4455, 4520, 4555, 4560, 4620, 4630, 4640, 4650, 4755, 4760, 4840, 4850, 4955, 4960, 5010, 5020, 6030, 7020, 7520, 8430, 8630 - All w/ Deluxe Seat	Shock Absorber Assembly w/ Coil Spring, 7.625" Collapsed Length, 10.50" Extended Length	AMAR26529	\$ 186.00
	For Grammer MSG85, MSG95G, MSG95GL DDS and MSG97 Suspensions	Shock Absorber Replacement Shock Absorber for Grammer Side-to-Side Isolator	AM1019014	\$ 23.00
	1020, 1520, 2020, 2030, (2140, 3040, 3140 ASN 430000), 2350, (2440, 2640 BSN 340999), 2510, 2520, 2550, 2630, 2750, 2940, 2950, 3010, 3020, 4000, 4010, 4020, 4030, 4040, 4050, 4055, 4230, 4240, 4250, 4255, 4320, 4350, 4430, 4440, 4450, 4455, 4520, 4555, 4620, 4630, 4640, 4650, 4755, 4840, 4850, 4955, 5010, 5020, 6030, 7020, 7520, 8430, 8630	Shock Absorber w/o Coil Spring	AMRE62234	\$ 109.00
	5083E, 5090M, 5093E, 5101E, 5220, 5225, 5320, 5320N, 5325, 5420, 5420N, 5425, 5500, 5520, 5520N, 5525, 5603, 5625, 5720, 5725, 6105M, 6110, 6110L, 6110M, 6115M, 6120, 6120L, 6120M, 6125M, 6130, 6130M, 6145M, 6150M, 6155M, 6200, 6200L, 6210, 6210L, 6215, 6220, 6220L, 6230, 6300, 6300L, 6310, 6310L, 6310S, 6320, 6320L, 6330, 6330 Premium, 6400, 6400L, 6410, 6410L, 6410S, 6415, 6420, 6420L, 6430, 6500, 6500L, 6510L, 6510S, 6520L, 6600, 6615, 6715, 7130, 7230, 7330, 7500, Premium Model: 6430	Shock Absorber For Grammer MSG83 Suspensions	AMAL117265	\$ 65.00
	5065M, 5075M, 5085E, 5085M, 5090E, 5090EL, 5090M, 5095MH, 5100E, 5100M, 5105M, 5115M, 6100D, 6100E, 6105D, 6105SE, 6110D, 6110E, 6115D, 6115E, 6120E, 6125D, 6125E, 6130D, 6130E, 6135E, 6140D, 6403, 6603	Shock Absorber For Grammer MSG85 Suspensions	AMTCA18446	\$ 82.00

John Deere®—Seats

Seats and Suspensions

John Deere®—Seats and Suspensions

Application	Description	Part Number	Retail Price
 <p>5065M, 5075M, 5085M, 5090M, 5095MH, 5100M, 5100MH, 5105M, 5115M, 6010, 6100D, 6100E, 6105D, 6105E, 6110, 6110D, 6110E, 6115D, 6115E, 6120E, 6125D, 6125E, 6130D, 6130E, 6135E, 6140D, 6210, 6215, 6310, 6410, 6415, 6510, 6610, 6810, 6910, 6910S, Premium Model: 6930, Sprayer: 4630</p>	Shock Absorber For Grammer MSG95G Suspensions	AMAL117453	\$ 63.00
<p>5090R, 5100R, 5115R, 5115RH, 6105M, 6105R, 6110M, 6110R, 6115M, 6115R, 6120M, 6120R, 6125M, 6125R, 6130M, 6130R, 6140M, 6145M, 6145R, 6150M, 6150R, 6150RH, 6155M, 6155R, 6155RH, 6170M, 6175M, 6175R, 6190R, 6195M, 6195R, 6210R, 6215R, 6230R, 7200R, 7215R, 7220, 7320, 7260R, 7280R, 7420, 7520, 7R 210, 7R 230, 7R 250, 7R 270, 7R 290, 7R 310, 7R 330, 8R 230, 8R 250, 8R 280, 8R 310, 8R 340, 8R 370, 8R 410, 8RT 310, 8RT 340, 8RT 370, 8RT 410, 8RX 310, 8RX 340, 8RX 370, 8RX 410</p>	Shock Absorber For Grammer MSG95A, MSG95AL, MSG95G, MSG95GL DDS Suspensions	AMAL210505	\$ 127.00
 <p>6105M, 6105R, 6110, 6110M, 6110R, 6115M, 6115R, 6120, 6120M, 6120R, 6125M, 6125R, 6130, 6130M, 6130R, 6140M, 6140R, 6145M, 6150M, 6150R, 6155M, 6155R, 6170M, 6170R, 6175M, 6175R, 6190R, 6195M, 6195R, 6200L, 6210R, 6215, 6215R, 6220, 6230, 6230R, 6250R, 6300L, 6310S, 6320, 6320L, 6400L, 6410S, 6415, 6420, 6420L, 6500L, 6510S, 6520L, 6330, 6405, 6430, 6605, 6615, 6715, 7130, 7230, 7330, Premium Models: 6330, 7130, 7230, 7330, 7430, 7530</p>	Shock Absorber Kit For Grammer MSG85, MSG95G, MSG95GL DDS and MSG97 Suspensions Replacement Shock Absorber for Grammer AM1139345 Side-to-Side Isolator	AMAL151004	\$ 49.00
<p>Combines: 9570STS, 9670STS, 9770STS, 9870STS, S650, S660, S670, S680, S680HM, S690, S690HM, S760, S770, S780, S790, Forage Harvesters: 8100, 8200, 8300, 8400, 8500, 8600, 8700, 8800, 9600, 9700, 9800, 9900, Sprayers: R4030, R4038, R4044, R4045, R4060, John Deere® Swathers: W235, W235D, W260</p>	Shock Absorber For Grammer MSG95G and MSG95GL DDS Suspensions	AMAL210544	\$ 187.00
 <p>4040, 4050, 4055, 4240, 4250, 4255, 4440, 4450, 4455, 4555, 4560, 4640, 4650, 4755, 4760, 4850, 4955, 4960, 8440, 8450, 8560, 8640, 8650, 8760, 8850, 8960</p>	Hydraulic Seat Accumulator	AMRE17477	\$ 275.00
 <p>4040, 4050, 4055, 4240, 4250, 4255, 4440, 4450, 4455, 4555, 4560, 4640, 4650, 4755, 4760, 4850, 4955, 4960, 8440, 8450, 8560, 8640, 8650, 8760, 8850, 8960</p>	Fitting	AMR63922	\$ 7.00
 <p>520, 530, 620, 630, 720, 730, Utility: 820, 830</p>	Rubber Spring Leaf, Right Hand Rubber Spring Leaf, Left Hand	AMAR39648 AMAR39649	\$ 32.00 \$ 37.00

Kubota®—Seats and Suspensions

Seats

Complete Seats

	Application	Description		Part Number	Retail Price
	M7040DTC, M7040DTC-1, M7040FC, M7040FC-1, M7040HDC, M7040HDC-1, M7040HDC-LTD, M8540DTC, M8540DTC-1, M8540FC, M8540HDC, M8540HDC-1, M9540DTC, M9540DTC-1, M9540FC, M9540FC-1, M9540HDC, M9540HDC-1, M9540HDC-LTD, M9540HDC12, M9540HDC12-1, M9540HDC24-1	Seat and Suspension Assembly • Plug-and-play • Grammer MSG95G air suspension • Durable black vinyl covering • Armrests • Backrest extension for extra backrest height • Adjustable lumbar support • Suspension stroke of 100 mm • Weight adjustment from 110 to 285 lbs • Fore/aft adjustment • Operator presence switch Includes Grammer 731 Seat, Grammer MSG95G Air Suspension, Seat Adapter Plate, Wire Adapter, Mounting Hardware and Installation Instructions	Black Vinyl	AMSS10054	\$ 1075.00
	MX4700DT BSN 53556, MX4700F BSN 11700, MX4700H, MX4800DT, MX4800F, MX4800H, MX5000DT, MX5000F, MX5000SU, MX5100DT BSN 69674, MX5100F BSN 15188, MX5100H, MX5200DT, MX5200F, MX5200H, MX5400DT, MX5400F, MX5400H, MX5800H	Seat and Suspension Assembly • Plug-and-play • Grammer MSG75 Air Suspension • Durable black/gray fabric covering • Armrest • Backrest extension for extra backrest height • Adjustable lumbar support • Seat belt • Air suspension with 12-volt compressor • Suspension stroke of 100 mm • Fore/aft adjustment • Operator presence switch Includes Grammer 731 Seat, Grammer MSG75 Air Suspension, Seat Adapter Plate, Command Arm Bracket, Wire Adapter, Mounting Hardware and Installation Instructions	Black/Gray Matrix Fabric	AMSS11065	\$ 1137.00
	For Grammer DS44/1HB Seat Assemblies	Seat and Suspension Assembly For Grammer DS44/1HB Seat Assemblies	Black Vinyl	AM2049435	\$ 316.00

Seat Tops

	Application	Description		Part Number	Retail Price
	MX4700DT BSN 53556, MX4700F BSN 11700, MX4700H, MX4800DT, MX4800F, MX4800H, MX5000DT, MX5000F, MX5000SU, MX5100DT BSN 69674, MX5100F BSN 15188, MX5100H, MX5200DT, MX5200F, MX5200H, MX5400DT, MX5400F, MX5400H, MX5800H	Seat Assembly • Grammer 731 seat • Durable black/gray matrix fabric covering • Armrests • Backrest extension for extra backrest height	Black/Gray Matrix Fabric	AMSS11007	\$ 526.00

Kubota®—Seats



Seats and Suspensions

Kubota®—Seats and Suspensions

	Application	Description		Part Number	Retail Price
	For Grammer Suspensions	Seat Assembly • Grammer 731 seat • Durable black vinyl covering • Armrests • Adjustable lumbar support	Black Vinyl	AMSS11025	\$ 523.00
	For Grammer Suspensions	Seat Assembly • Grammer 731 seat • Durable black vinyl covering • Adjustable lumbar support	Black Vinyl	AM1205871	\$ 322.00
	For Grammer Suspensions	Seat Assembly • Grammer 731 seat • Durable gray vinyl covering • Armrests • Adjustable lumbar support • Slide rails • Operator presence switch	Gray Vinyl	AM1110258	\$ 443.00
	B20, B1550, B1700, B1750, B2100, B2150, B2400, B9200, G1800, G1900, G2000, GF1800, L35, L175, L185, L210, L225, L245, L245H, L285P, L295F, L300F, L305, L345, L2050, L2250, L225DT, L2350F, L2500, L2550, L2600, L2650, L2800, L2850DT, L2900, L2950, L3250F, L3300, L3350, L3400, L3450, L3600, L3650, L3750, L4150, L4200, L4300, L4350, L4400, L4500, L4850, L5450	Kub 85 Large Bucket Seat	Black Vinyl	AMX6817	\$ 189.00
	B4200, B5100, B6100, B7100, B8200, L175, L185, L200, L210, L225, L235, L245, L260, L275, L285, L295, L305, L345, L355, L2050, L2350, M4000, M4050, M4500, M5500, M7500	150 Uni Pro Bucket Seat Seat is vacuum-formed w/ contoured foam cushions, adjustable brackets are provided for seat to tip forward. Brackets are adjustable from 4" to 7.375".	Black Vinyl	AMX6818	\$ 201.00
	B5200, B6200, B7200	155 Uni Pro Bucket Seat Seat is vacuum-formed w/ contoured foam cushions, adjustable brackets are provided for seat to tip forward. Brackets are adjustable from 4" to 7.375".	Black Vinyl	AM155UP	\$ 237.00
	L3301DT, L3301F, L3301H, L3901DT, L3901F, L3901H, L4701DT, L4701F, L4701H	129 Uni Pro Bucket Seat Seat is vacuum-formed and waterproof, w/ central drain hole. Corrosion-resistant, molded plastic frame.	Black Vinyl	AMSS6833	\$ 198.00
	For Grammer S7X2 High Back Seat Assemblies	Seat Frame, High Back S7X2 Frame Only, Cushions Not Included Includes Seat Frame, Mechanical Lumbar, Slide Rails and Literature Box		AM1125651	\$ 245.00

Kubota®—Seats and Suspensions





Suspensions

Application	Description	Part Number	Retail Price
For Grammer Seat Assemblies	Suspension, Air <ul style="list-style-type: none"> • Grammer MSG97G air suspension • Front controls • Suspension stroke up to 7" • Adjustable to suit driver's weight from 110 to 485 lbs • Fore/aft adjustment • Height adjustment up to 3.10" • Shock absorber 	AM1378253	\$ 699.25
For Grammer Seat Assemblies	Suspension, Air For 24 Volt Systems <ul style="list-style-type: none"> • Grammer MSG97G air suspension • Self-contained 24-volt compressor • Front controls • Suspension stroke up to 7" • Adjustable to suit driver's weight from 110 to 485 lbs • Fore/aft adjustment • Height adjustment up to 3.10" • Shock absorber 	AM1338593	\$ 681.75
For Grammer Seat Assemblies	Suspension, Air For 24 Volt Systems <ul style="list-style-type: none"> • Grammer MSG97 low-frequency air suspension • Self-contained 24-volt compressor • Frame width of 17" • Front controls • Fore/aft isolator • Suspension stroke up to 7" • Height adjustment up to 3.10" • Adjustable to suit driver's weight from 100 to 400 lbs • Weight indicator • Shock absorber 	AM1241742	\$ 470.00
 For Grammer Seat Assemblies	Suspension w/ Wiring Harness, Air <ul style="list-style-type: none"> • Grammer MSG95GL DDS air suspension • Suspension stroke of 100 mm • Fore/aft adjustment 	AMSS11016	\$ 619.00
 For Grammer Seat Assemblies	Suspension, Air <ul style="list-style-type: none"> • Grammer MSG95G air suspension • Frame width of 11.75" • Side controls • Fore/aft isolator • Air suspension w/ suspension travel of 4" • Suspension stroke up to 7" • Adjustable to suit driver's weight from 110 to 285 lbs • Weight indicator • Shock absorber 	AM1319704	\$ 536.51
 For Grammer Seat Assemblies	Suspension, Air <ul style="list-style-type: none"> • Grammer MSG95G air suspension • Frame width of 11.75" • Front controls • Fore/aft isolator • Air suspension w/ suspension travel of 4" • Suspension stroke up to 7" • Adjustable to suit driver's weight from 110 to 285 lbs • Weight indicator • Shock absorber 	AM1319705	\$ 617.00



Kubota®—Seats

Seats and Suspensions

Kubota®—Seats and Suspensions





Application	Description	Part Number	Retail Price
 For Grammer Seat Assemblies	Suspension, Air For 24 Volt Systems <ul style="list-style-type: none"> • Grammer MSG95G air suspension • Self-contained 24-volt compressor • Frame width of 11.75" • Side controls • Fore/aft isolator • Air suspension with suspension travel of 4" • Suspension stroke up to 7" • Adjustable to suit driver's weight from 110 to 285 lbs • Weight indicator • Shock absorber 	AM1319709	\$ 583.00
 For Grammer Seat Assemblies	Suspension, Air <ul style="list-style-type: none"> • Grammer MSG93 compact air suspension • Frame width of 8.92" • Front controls • Manual weight adjustment w/ push-pull switch control 	AM1225983	\$ 528.27
 For Grammer Seat Assemblies	Suspension, Mechanical <ul style="list-style-type: none"> • Grammer MSG87 mechanical suspension • Height adjustment up to 3.10" • Suspension stroke up to 7" • Adjustable to suit driver's weight from 110 to 400 lbs • Weight indicator 	AM1347434	\$ 683.08
 For Grammer Seat Assemblies	Suspension, Mechanical <ul style="list-style-type: none"> • Grammer MSG85 mechanical suspension • Frame width of 11.75" • Suspension travel of 4" • Suspension stroke up to 7" • Flip-handle weight adjustment from 110 to 285 lbs • Weight indicator • Three-position height adjustment of 3" 	AM1201579	\$ 354.00
 For Grammer Seat Assemblies	Suspension, Mechanical <ul style="list-style-type: none"> • Grammer MSG83 compact mechanical suspension • Flip-handle weight adjustment • Front weight indicator • Three-position height adjustment • Frame width of 8.92" 	AM1225985	\$ 364.00

Seat and Suspension Components

Application	Description	Part Number	Retail Price
 For Grammer MSG85, MSG95 and MSG95DDS Suspensions	Side-to-Side Isolator	AM1139345	\$ 294.00
 For Grammer MSG97 12 Volt Suspensions Will not work on 24 Volt Suspensions	Heated Switch Kit	AM1250169	\$ 70.00

Kubota®—Seats and Suspensions

Kubota®—Seats

	Application	Description	Part Number	Retail Price
	Universal Equipment	Seat Belt, Retractable 55" long from bolt hole to hold hole when extended out	AMX6824	\$ 44.00
	For Grammer 721, 731 and 741 Seat Assemblies	Literature Box Kit	AMAL117363	\$ 28.00
	For Grammer MSG85 Mechanical Suspensions	Suspension Rebuild Kit Includes Adjusting Shaft, Clevis, Spindle, Springs, Weight Indicator and Hardware	AM1163691	\$ 68.00
	For Grammer MSG85, MSG95G, MSG95GL DDS and MSG97 Suspensions	Shock Absorber Kit Replacement Shock Absorber for Grammer AM1139345 Side-to-Side Isolator	AMAL151004	\$ 49.00
	For Grammer MSG85, MSG95G, MSG95GL DDS and MSG97 Suspensions	Shock Absorber Replacement Shock Absorber for Grammer Side-to-Side Isolator	AM1019014	\$ 23.00

Seats and Suspensions

Massey Ferguson®—Seats and Suspensions

Seats

Complete Seats

	Application	Description	Part Number	Retail Price	
	5610 w/ Dyna-4 Transmission, (5611, 5612, 5613, 5711, 5712, 5713 - w/ Dyna-4 or Dyna-6 Transmission), (6614, 6615, 6616, 6715, 6715S, 6716S, 7615, 7616, 7618, 7619, 7620, 7622, 7624, 7719, 7720, 7722, 7724, 7726 - w/ Dyna-6 or Dyna-VT Transmission), (7465, 7475, 7480 - w/ Tier 3 or Tier 3 SISU Engine), (7485, 7490, 7495, 7499 - w/ Tier 3 Engine), (7716, 7718 - w/ Dyna-VT Transmission)	Seat and Suspension Assembly • Plug-and-play • Grammer MSG95AL air suspension • Blue/gray with red speckle fabric covering • Foldable/adjustable armrest • Powered air lumbar support • Automatic suspension level control • Fore/aft adjustment • Suspension stroke of 100 mm • Operator presence switch Includes Grammer 741 Seat, Grammer MSG95AL Air Suspension, Command Arm Bracket, Integrated Swivel, Slide Rails and Literature Box	Blue/Gray Fabric w/ Red Speckle	AM4352324M96	\$ 1550.00
	(5609, 5610, 7614 - w/ Dyna-4 Transmission), (5611, 5612, 5613, 5711, 5713 - w/ Dyna-4 or Dyna-6 Transmission), (5712, 7719 - w/ Dyna-6 Transmission), (6614, 6615, 6616, 7615, 7616, 7618, 7619, 7620, 7622, 7624, 7720, 7722, 7724, 7726 - w/ Dyna-6 or Dyna-VT Transmission), (7465, 7475, 7480 - w/ Tier 3 or Tier 3 SISU Engine), (7485, 7490, 7495, 7499 - w/ Tier 3 Engine), (7716, 7718 - w/ Dyna-VT Transmission), Challenger®: MT515D w/ Dyna-4 Transmission, MT525D w/ Dyna-4, Dyna-6 or Dyna-VT Transmission, (MT535D, MT545D - w/ Dyna-6 or Dyna-VT Transmission), (MT555D, MT565D, MT575D, MT585D - w/ Dyna-6 or CVT Transmission)	Seat and Suspension Assembly • Plug-and-play • Grammer MSG95AL air suspension • Blue/gray with red speckle fabric covering • Foldable/adjustable armrest • Powered air lumbar support • Automatic suspension level control • Fore/aft adjustment • Suspension stroke of 100 mm • Operator presence switch Includes Grammer 731 Seat, Grammer MSG95AL Air Suspension, Command Arm Bracket, Integrated Swivel, Slide Rails and Literature Box	Blue/Gray Fabric w/ Red Speckle	AM4352780M97	\$ 1160.00

Massey Ferguson®—Seats and Suspensions

Massey Ferguson®—Seats

Seats and Suspensions

	Application	Description		Part Number	Retail Price	
	Most Models	Seat and Suspension Assembly • Grammer MSG83 compact mechanical suspension • Black/gray matrix fabric option includes backrest extension • Black/vinyl option does not include backrest extension • Armrests • Front weight indicator • Flip-handle weight adjustment • Suspension travel of 3.10" • Frame width of 8.92" • Three-position height adjustment Includes Grammer 721 Seat and Grammer MSG83 Mechanical Suspension	Black/Gray Matrix Fabric	AMSS11063	\$ 965.00	
			Black Vinyl	AMSS11064	\$ 914.00	
			Backrest Extension	Black Vinyl	AM1092126	\$ 89.00
			Seat Belt, Retractable		AM902133	\$ 103.00
	20, 50, 65, 85, 88, Super 95, 98, 130, 135, 150, 154-4, 154-4S, 165, 174-4S, 175, 178, 180, 184-4, 185, 194-4F, 230, 231, 235, 240, 240P, 240S, 245, 250, 253, 254-4, 255, 261, 263, 265, 265S, 270, 274-4, 275, 282, 283, 285, 285S, 290, 294-4, 298, 360, 362, 364S, 365, 374, 375, 383, 390, 393, 394S, 398, 399, 1080, Colt, F40, Pony, TE20, TEA20, TO20, TO30, TO35	Seat and Suspension Assembly • Wrap-around style backrest • Adjustable to suit driver's weight up to 265 lbs • Slide rails provide fore/aft adjustment • Adjustable base angle • Mechanical suspension • Multiple mounting patterns Replaces 533813M96	Black Vinyl	AMSS8093	\$ 90.00	
	Challenger®: 65, 65A, 65B, 65C, 65D, 65E	Seat and Suspension Assembly • Plug-and-play • Grammer MSG95GL DDS air suspension • Durable gray fabric covering • Cut-and-sew cushions for added comfort • Armrests • Backrest extension for extra backrest height • Adjustable lumbar support • Suspension stroke of 100 mm • Fore/aft adjustment • Seat depth/tilt • Operator presence switch Includes Grammer 741 Seat, Grammer MSG95GI DDS (Dynamic Dampening System) Air Suspension, Switch Kit, Mounting Hardware and Installation Instructions	Gray Fabric	AMSS10037	\$ 1557.00	
				AMSS11000	\$ 109.00	
				AM1139345	\$ 294.00	
				AM902133	\$ 103.00	

Massey Ferguson®—Seats and Suspensions

Application	Description	Part Number	Retail Price
	Challenger®: 65, 65A, 65B, 65C, 65D, 65E	Seat and Suspension Assembly • Plug-and-play • Grammer MSG95 air suspension • Durable black/gray matrix fabric covering • Armrests • Backrest extension for extra backrest height • Fore/aft isolator Includes Grammer 731 Seat, Grammer MSG95 Air Suspension, Seat Adapter Plate, Wire Adapter, Mounting Hardware and Installation Instructions	Black/Gray Matrix Fabric AMSS10038 \$ 1172.00
	Challenger®: 65, 65A, 65B, 65C, 65D, 65E	Seat and Suspension Assembly • Grammer MSG85 compact mechanical suspension • Durable black/gray matrix fabric covering • Armrests • Backrest extension for extra backrest height • Suspension travel of 4" • Fore/aft isolator • Suspension stroke up to 7" • Flip-handle weight adjustment from 110 to 285 lbs • Weight indicator • Three-position height adjustment of 3" • Frame width of 11.75" Includes Grammer 731 Seat, Grammer MSG85 Mechanical Suspension, Seat Adapter Plate, Wire Adapter, Mounting Hardware and Installation Instructions	Black/Gray Matrix Fabric AMSS10039 \$ 956.00
	Swivel Kit	AMSS11000	\$ 109.00
	Side-to-Side Isolator	AM1139345	\$ 294.00
	Seat Belt, Retractable	AM902133	\$ 103.00
For Grammer DS44/1HB Seat Assemblies	Seat and Suspension Assembly	Black Vinyl AM2049435	\$ 316.00

Seat Tops and Cushions

Application	Description	Part Number	Retail Price
	For Grammer Suspensions	Seat Assembly • Grammer 742 tall back seat • Durable black/gray matrix fabric covering • Armrests • Operator presence switch	Black/Gray Matrix Fabric AMSS11052 \$ 730.00
		Seat Assembly w/ Swivel	Black/Gray Matrix Fabric AMSS11054 \$ 790.00





Massey Ferguson®—Seats and Suspensions

Massey Ferguson®—Seats

	Application	Description		Part Number	Retail Price
	For Grammer Suspensions	Seat Assembly	Black/Gray Matrix Fabric	AMSS11051	\$ 657.00
		<ul style="list-style-type: none"> • Grammer 741 seat • Durable black/gray matrix fabric covering • Armrests • Backrest extension for extra backrest height • Operator presence switch 			
		Seat Assembly w/ Swivel	Black/Gray Matrix Fabric	AMSS11053	\$ 724.00
	For Grammer Suspensions	Seat Assembly	Black/Gray Matrix Fabric	AMSS11007	\$ 526.00
		<ul style="list-style-type: none"> • Grammer 731 seat • Durable black/gray matrix fabric covering • Armrests • Backrest extension for extra backrest height 			
		Seat Assembly w/ Swivel	Black/Gray Matrix Fabric	AMSS11033	\$ 675.00
	For Grammer Suspensions	Seat Assembly	Black/Gray Matrix Fabric	AM1205873	\$ 354.00
		<ul style="list-style-type: none"> • Grammer 731 seat • Durable black/gray matrix fabric covering 			
	For Grammer Suspensions	Seat Assembly	Black Vinyl	AMSS11025	\$ 523.00
		<ul style="list-style-type: none"> • Grammer 731 seat • Durable black vinyl covering • Armrests • Adjustable lumbar support 			
		Seat Assembly	Black Vinyl	AM1205871	\$ 322.00
		<ul style="list-style-type: none"> • Grammer 731 seat • Durable black vinyl covering • Adjustable lumbar support 			
	For Grammer Suspensions	Seat Assembly	Gray Vinyl	AM1110258	\$ 443.00
		<ul style="list-style-type: none"> • Grammer 731 seat • Durable gray vinyl covering • Armrests • Adjustable lumbar support • Slide rails • Operator presence switch 			
	2675, 2705, 2745, 2775, 2805 - w/ Presidential Seats	Seat Back	Black Vinyl	AMIH1086BV	\$ 125.00
		Seat Cushion	Black Vinyl	AMIH1086SV	\$ 131.00
		Armrests (Pair), 1 1/4" hole	Black Vinyl	AMIH1086ARV	\$ 147.00
	2675, 2705, 2745, 2775, 2805 - w/ Presidential Seats	Seat Back	Black Fabric	AMIH1086BF	\$ 125.00
		Seat Cushion	Black Fabric	AMIH1086SF	\$ 125.00
		Armrests (Pair), 1 1/4" hole	Black Fabric	AMIH1086ARF	\$ 127.00

Seats and Suspensions







Massey Ferguson®—Seats and Suspensions

	Application	Description		Part Number	Retail Price
	Super 90, 699	Universal Seat Bolt pattern: front to back - 11" center-to-center left to right - 11.25" center-to-center Blow-molded plastic bucket, non-sewn covers, will not crack or peel away from foam. Waterproof w/ drain hole.	Gray Vinyl	AMSS6777T	\$ 166.00
	30, 50, 65, 95, 150, 165, 175, 178, 180, 245, 255, 265, 275, 285, 1080, Ind: 31, 40B	Seat Back Seat Cushion	Black Vinyl Black Vinyl	AMMF285B AMMF285S	\$ 117.00 \$ 110.00
	For Grammer S7X2 High Back Seat Assemblies	Seat Frame, High Back S7X2 Frame Only, Cushions Not Included Includes Seat Frame, Mechanical Lumbar, Slide Rails and Literature Box		AM1125651	\$ 245.00
	For Grammer 741 and 742 Seat Assemblies	Seat Cushion	Black/Gray Matrix Fabric	AM1344872	\$ 122.00



Suspensions

	Application	Description	Part Number	Retail Price
	For Grammer Seat Assemblies	Suspension, Air • Grammer MSG97G air suspension • Front controls • Suspension stroke up to 7" • Adjustable to suit driver's weight from 110 to 485 lbs • Fore/aft adjustment • Height adjustment up to 3.10" • Shock absorber	AM1378253	\$ 699.25
	For Grammer Seat Assemblies	Suspension, Air For 24 Volt Systems • Grammer MSG97G air suspension • Self-contained 24-volt compressor • Front controls • Suspension stroke up to 7" • Adjustable to suit driver's weight from 110 to 485 lbs • Fore/aft adjustment • Height adjustment up to 3.10" • Shock absorber	AM1338593	\$ 681.75
	For Grammer Seat Assemblies	Suspension, Air For 24 Volt Systems • Grammer MSG97 low-frequency air suspension • Self-contained 24-volt compressor • Frame width of 17" • Front controls • Fore/aft isolator • Suspension stroke up to 7" • Height adjustment up to 3.10" • Adjustable to suit driver's weight from 100 to 400 lbs • Weight indicator • Shock absorber	AM1241742	\$ 470.00







Massey Ferguson®—Seats and Suspensions

	Application	Description	Part Number	Retail Price
	For Grammer Seat Assemblies	Suspension w/ Wiring Harness, Air • Grammer MSG95GL DDS air suspension • Suspension stroke of 100 mm • Fore/aft adjustment	AMSS11016	\$ 619.00
	8660, Combines: 9690, 9790, Challenger® Combines: 660, 670	Suspension, Air • Grammer MSG95GL DDS air suspension • Suspension stroke of 100 mm • Fore/aft adjustment • Height adjustment	AM1292594	\$ 598.97
	For Grammer Seat Assemblies	Suspension, Air • Grammer MSG95G air suspension • Frame width of 11.75" • Front controls • Fore/aft isolator • Air suspension w/ suspension travel of 4" • Suspension stroke up to 7" • Adjustable to suit driver's weight from 110 to 285 lbs • Weight indicator • Shock absorber	AM1319705	\$ 617.00
	For Grammer Seat Assemblies	Suspension, Air For 24 Volt Systems • Grammer MSG95G air suspension • Self-contained 24-volt compressor • Frame width of 11.75" • Side controls • Fore/aft isolator • Air suspension with suspension travel of 4" • Suspension stroke up to 7" • Adjustable to suit driver's weight from 110 to 285 lbs • Weight indicator • Shock absorber	AM1319709	\$ 583.00
	Swather: WR9635	Suspension, Air • Grammer MSG95G air suspension • Frame width of 11.75" • Side controls • Fore/aft isolator • Air suspension w/ suspension travel of 4" • Suspension stroke up to 7" • Adjustable to suit driver's weight from 110 to 285 lbs • Weight indicator • Shock absorber	AM1319704	\$ 536.51
	For Grammer Seat Assemblies	Suspension, Air • Grammer MSG93 compact air suspension • Frame width of 8.92" • Front controls • Manual weight adjustment w/ push-pull switch control	AM1225983	\$ 528.27
	For Grammer Seat Assemblies	Suspension, Mechanical • Grammer MSG87 mechanical suspension • Height adjustment up to 3.10" • Suspension stroke up to 7" • Adjustable to suit driver's weight from 110 to 400 lbs • Weight indicator	AM1347434	\$ 683.08

Massey Ferguson®—Seats and Suspensions

Application	Description	Part Number	Retail Price
 For Grammer Seat Assemblies	Suspension, Mechanical • Grammer MSG85 mechanical suspension • Frame width of 11.75" • Suspension travel of 4" • Suspension stroke up to 7" • Flip-handle weight adjustment from 110 to 285 lbs • Weight indicator • Three-position height adjustment of 3"	AM1201579	\$ 354.00
 For Grammer Seat Assemblies	Suspension, Mechanical • Grammer MSG83 compact mechanical suspension • Flip-handle weight adjustment • Front weight indicator • Three-position height adjustment • Frame width of 8.92"	AM1225985	\$ 364.00



Seat and Suspension Components

Application	Description	Part Number	Retail Price
 For Grammer MSG85, MSG95 and MSG95DDS Suspensions	Side-to-Side Isolator	AM1139345	\$ 294.00
 For Grammer MSG97 12 Volt Suspensions Will not work on 24 Volt Suspensions	Heated Switch Kit	AM1250169	\$ 70.00
 Universal Equipment	Seat Belt, Retractable 55" long from bolt hole to hold hole when extended out	AMX6824	\$ 44.00
 For Grammer 721, 731 and 741 Seat Assemblies	Literature Box Kit	AMAL117363	\$ 28.00
 For Grammer MSG85 Mechanical Suspensions	Suspension Rebuild Kit Includes Adjusting Shaft, Clevis, Spindle, Springs, Weight Indicator and Hardware	AM1163691	\$ 68.00
 For Grammer MSG85, MSG95G, MSG95GL DDS and MSG97 Suspensions	Shock Absorber Replacement Shock Absorber for Grammer Side-to-Side Isolator	AM1019014	\$ 23.00
 For Grammer MSG85, MSG95G, MSG95GL DDS and MSG97 Suspensions	Shock Absorber Kit Replacement Shock Absorber for Grammer AM1139345 Side-to-Side Isolator	AMAL151004	\$ 49.00

White® / Oliver® / M&M®—Seats and Suspensions

Seats

Complete Seats

Application	Description	Part Number	Retail Price		
	White®: Most Models	Seat and Suspension Assembly	Black/Gray Matrix Fabric	AMSS11063	\$ 965.00
		• Grammer MSG83 compact mechanical suspension	Black Vinyl	AMSS11064	\$ 914.00
		• Black/gray matrix fabric option includes backrest extension			
		• Black/vinyl option does not include backrest extension			
	• Armrests				
	• Front weight indicator				
	• Flip-handle weight adjustment				
	• Suspension travel of 3.10"				
	• Frame width of 8.92"				
	• Three-position height adjustment				
	Includes Grammer 721 Seat and Grammer MSG83 Mechanical Suspension				
	Backrest Extension	Black Vinyl	AM1092126	\$ 89.00	
	Seat Belt, Retractable		AM902133	\$ 103.00	
	Oliver®: 1250, 1250A, 1255, 1265, 1270, 1355, 1365, 1370, 1465, 1470, White®: 2-50, 2-60, 700	Seat and Suspension Assembly	Black Vinyl	AMSS8093	\$ 90.00
		• Wrap-around style backrest			
	• Adjustable to suit driver's weight up to 265 lbs				
	• Slide rails provide fore/aft adjustment				
	• Adjustable base angle				
	• Mechanical suspension				
	• Multiple mounting patterns				
	Replaces 30-3050890, 30-3053350				
	White®: (2-85, 2-88, 2-105, 2-110, 2-135, 2-155, 2-180, 140, 160, 185 - w/ Grammer Seat)	Seat and Suspension Assembly	Black/Gray Matrix Fabric	AMSS10063	\$ 964.00
		• Grammer MSG85 compact mechanical suspension			
	• Durable black/gray matrix fabric covering				
	• Armrests				
	• Suspension travel of 4"				
	• Fore/aft isolator				
	• Suspension stroke up to 7"				
	• Flip-handle weight adjustment from 110 to 285 lbs				
	• Weight indicator				
	• Three-position height adjustment of 3"				
	• Frame width of 11.75"				
	Includes Grammer 731 Seat, Grammer MSG85 Mechanical Suspension, Mounting Hardware and Installation Instructions				





White® / Oliver® / M&M®—Seats

Seats and Suspensions

White® / Oliver® / M&M®—Seats and Suspensions

Application	Description	Part Number	Retail Price
White®: (2-85, 2-105, 2-135, 2-155 - w/ Bostrom Seat)	Seat and Suspension Assembly • Grammer MSG85 compact mechanical suspension • Durable black/gray matrix fabric covering • Armrests • Backrest extension for extra backrest height • Suspension travel of 4" • Fore/aft isolator • Suspension stroke up to 7" • Flip-handle weight adjustment from 110 to 285 lbs • Weight indicator • Three-position height adjustment of 3" • Frame width of 11.75" Includes Grammer 731 Seat, Grammer MSG85 Mechanical Suspension, Seat Adapter Plate, Wire Adapter, Mounting Hardware and Installation Instructions	Black/Gray Matrix Fabric AMSS10055	\$ 934.00
For Grammer DS44/1HB Seat Assemblies	Seat and Suspension Assembly	Black Vinyl AM2049435	\$ 316.00

Seat Tops and Cushions

Application	Description	Part Number	Retail Price
 For Grammer Suspensions	Seat Assembly • Grammer 742 tall back seat • Durable black/gray matrix fabric covering • Armrests • Operator presence switch	Black/Gray Matrix Fabric AMSS11052	\$ 730.00
	Seat Assembly w/ Swivel	Black/Gray Matrix Fabric AMSS11054	\$ 790.00
 For Grammer Suspensions	Seat Assembly • Grammer 741 seat • Durable black/gray matrix fabric covering • Armrests • Backrest extension for extra backrest height • Operator presence switch	Black/Gray Matrix Fabric AMSS11051	\$ 657.00
	Seat Assembly w/ Swivel	Black/Gray Matrix Fabric AMSS11053	\$ 724.00
 For Grammer Suspensions	Seat Assembly • Grammer 731 seat • Durable black/gray matrix fabric covering • Armrests • Backrest extension for extra backrest height	Black/Gray Matrix Fabric AMSS11007	\$ 526.00
	Seat Assembly w/ Swivel	Black/Gray Matrix Fabric AMSS11033	\$ 675.00
 For Grammer Suspensions	Seat Assembly • Grammer 731 seat • Durable black/gray matrix fabric covering	Black/Gray Matrix Fabric AM1205873	\$ 354.00

White® / Oliver® / M&M®—Seats and Suspensions

White® / Oliver® / M&M®—Seats



	Application	Description		Part Number	Retail Price
	For Grammer Suspensions	Seat Assembly • Grammer 731 seat • Durable black vinyl covering • Armrests • Adjustable lumbar support	Black Vinyl	AMSS11025	\$ 523.00
	For Grammer Suspensions	Seat Assembly • Grammer 731 seat • Durable gray vinyl covering • Armrests • Adjustable lumbar support • Slide rails • Operator presence switch	Gray Vinyl	AM1110258	\$ 443.00
	M&M®: 670, G900, Jet Star 3, Jet Star 3 Super	Seat Back, Small Upper Seat Back, Large Middle Seat Cushion		AMMM670SB AMMM670LB AMMM670S	\$ 74.00 \$ 211.00 \$ 144.00
	M&M®: Big Mo 400, Big Mo 400M, Big Mo 500, Big Mo 600, G, G705, G706, G750, Jet Star, Jet Star 4, Jet Star 4 Super, M5, M504, M602, M604	Seat Back Seat Cushion	Black Vinyl Black Vinyl	AMMF285B AMMF285S	\$ 117.00 \$ 110.00
	Oliver®: 1550, 1555, 1650, 1655, 1750, 1755, 1850, 1855, 1950, 1955, 2050, 2055, 2150, 2155, White®: 2-85, 2-105, 2-110, 2-135, 2-150, 2-155, 2-180	Seat Back Seat Cushion	Claret Vinyl Claret Vinyl	AMOW1850BC AMOW1850SC	\$ 209.00 \$ 121.00
	Oliver®: 1550, 1555, 1650, 1655, 1750, 1755, 1850, 1855, 1950, 1955, 2050, 2055, 2150, 2155, White®: 2-85, 2-105, 2-110, 2-135, 2-150, 2-155, 2-180	Seat Back Seat Cushion	Black & White Vinyl Black & White Vinyl	AMOW1850B AMOW1850S	\$ 190.00 \$ 121.00
	Oliver®: 55, 70, 77, 550, 770TR, 1365, 1550, 1555, 1600, 1650, 1655, 1750, 1755, 1850, 1855, 1955, 2150, 2255, M&M®: 4 Star, Jet Star, M-5, 302, 445, 670, 670 Super, G704, G800, G900, G950, G1000	Universal Seat Bolt pattern: front to back - 11" center-to-center left to right - 11.25" center-to-center Blow-molded plastic bucket, non-sewn covers, will not crack or peel away from foam. Waterproof w/ drain hole.	Gray Vinyl	AMSS6777T	\$ 166.00
	For Grammer S7X2 High Back Seat Assemblies	Seat Frame, High Back S7X2 Frame Only, Cushions Not Included Includes Seat Frame, Mechanical Lumbar, Slide Rails and Literature Box		AM1125651	\$ 245.00

Seats and Suspensions

White® / Oliver® / M&M®—Seats and Suspensions

Application	Description	Part Number	Retail Price	
 For Grammer 741 and 742 Seat Assemblies	Seat Cushion	Black/Gray Matrix Fabric	AM1344872	\$ 122.00







Suspensions

Application	Description	Part Number	Retail Price
For Grammer Seat Assemblies	Suspension, Air <ul style="list-style-type: none"> • Grammer MSG97G air suspension • Front controls • Suspension stroke up to 7" • Adjustable to suit driver's weight from 110 to 485 lbs • Fore/aft adjustment • Height adjustment up to 3.10" • Shock absorber 	AM1378253	\$ 699.25
For Grammer Seat Assemblies	Suspension, Air For 24 Volt Systems <ul style="list-style-type: none"> • Grammer MSG97G air suspension • Self-contained 24-volt compressor • Front controls • Suspension stroke up to 7" • Adjustable to suit driver's weight from 110 to 485 lbs • Fore/aft adjustment • Height adjustment up to 3.10" • Shock absorber 	AM1338593	\$ 681.75
For Grammer Seat Assemblies	Suspension, Air For 24 Volt Systems <ul style="list-style-type: none"> • Grammer MSG97 low-frequency air suspension • Self-contained 24-volt compressor • Frame width of 17" • Front controls • Fore/aft isolator • Suspension stroke up to 7" • Height adjustment up to 3.10" • Adjustable to suit driver's weight from 100 to 400 lbs • Weight indicator • Shock absorber 	AM1241742	\$ 470.00
 For Grammer Seat Assemblies	Suspension w/ Wiring Harness, Air <ul style="list-style-type: none"> • Grammer MSG95GL DDS air suspension • Suspension stroke of 100 mm • Fore/aft adjustment 	AMSS11016	\$ 619.00
 White®: 6124, 6144	Suspension, Air <ul style="list-style-type: none"> • Grammer MSG95GL DDS air suspension • Suspension stroke of 100 mm • Fore/aft adjustment • Height adjustment 	AM1292594	\$ 598.97

White® / Oliver® / M&M®—Seats and Suspensions

White® / Oliver® / M&M®—Seats







Seats and Suspensions

Application	Description	Part Number	Retail Price
 <p>For Grammer Seat Assemblies</p>	<p>Suspension, Air</p> <ul style="list-style-type: none"> • Grammer MSG95G air suspension • Frame width of 11.75" • Side controls • Fore/aft isolator • Air suspension w/ suspension travel of 4" • Suspension stroke up to 7" • Adjustable to suit driver's weight from 110 to 285 lbs • Weight indicator • Shock absorber 	AM1319704	\$ 536.51
 <p>For Grammer Seat Assemblies</p>	<p>Suspension, Air</p> <ul style="list-style-type: none"> • Grammer MSG95G air suspension • Frame width of 11.75" • Front controls • Fore/aft isolator • Air suspension w/ suspension travel of 4" • Suspension stroke up to 7" • Adjustable to suit driver's weight from 110 to 285 lbs • Weight indicator • Shock absorber 	AM1319705	\$ 617.00
 <p>For Grammer Seat Assemblies</p>	<p>Suspension, Air</p> <p>For 24 Volt Systems</p> <ul style="list-style-type: none"> • Grammer MSG95G air suspension • Self-contained 24-volt compressor • Frame width of 11.75" • Side controls • Fore/aft isolator • Air suspension with suspension travel of 4" • Suspension stroke up to 7" • Adjustable to suit driver's weight from 110 to 285 lbs • Weight indicator • Shock absorber 	AM1319709	\$ 583.00
 <p>For Grammer Seat Assemblies</p>	<p>Suspension, Air</p> <ul style="list-style-type: none"> • Grammer MSG93 compact air suspension • Frame width of 8.92" • Front controls • Manual weight adjustment w/ push-pull switch control 	AM1225983	\$ 528.27
 <p>For Grammer Seat Assemblies</p>	<p>Suspension, Mechanical</p> <ul style="list-style-type: none"> • Grammer MSG87 mechanical suspension • Height adjustment up to 3.10" • Suspension stroke up to 7" • Adjustable to suit driver's weight from 110 to 400 lbs • Weight indicator 	AM1347434	\$ 683.08
 <p>For Grammer Seat Assemblies</p>	<p>Suspension, Mechanical</p> <ul style="list-style-type: none"> • Grammer MSG85 mechanical suspension • Frame width of 11.75" • Suspension travel of 4" • Suspension stroke up to 7" • Flip-handle weight adjustment from 110 to 285 lbs • Weight indicator • Three-position height adjustment of 3" 	AM1201579	\$ 354.00



White® / Oliver® / M&M®—Seats and Suspensions

Application	Description	Part Number	Retail Price
 For Grammer Seat Assemblies	Suspension, Mechanical • Grammer MSG83 compact mechanical suspension • Flip-handle weight adjustment • Front weight indicator • Three-position height adjustment • Frame width of 8.92"	AM1225985	\$ 364.00

Seat and Suspension Components

Application	Description	Part Number	Retail Price
 For Grammer MSG85, MSG95 and MSG95DDS Suspensions	Side-to-Side Isolator	AM1139345	\$ 294.00
 For Grammer MSG97 12 Volt Suspensions Will not work on 24 Volt Suspensions	Heated Switch Kit	AM1250169	\$ 70.00
 Universal Equipment	Seat Belt, Retractable 55" long from bolt hole to hold hole when extended out	AMX6824	\$ 44.00
 For Grammer 721, 731 and 741 Seat Assemblies	Literature Box Kit	AMAL117363	\$ 28.00
 For Grammer MSG85 Mechanical Suspensions	Suspension Rebuild Kit Includes Adjusting Shaft, Clevis, Spindle, Springs, Weight Indicator and Hardware	AM1163691	\$ 68.00
 For Grammer MSG85, MSG95G, MSG95GL DDS and MSG97 Suspensions	Shock Absorber Replacement Shock Absorber for Grammer Side-to-Side Isolator	AM1019014	\$ 23.00
 For Grammer MSG85, MSG95G, MSG95GL DDS and MSG97 Suspensions	Shock Absorber Kit Replacement Shock Absorber for Grammer AM1139345 Side-to-Side Isolator	AMAL151004	\$ 49.00



Industrial / Construction / Turf

	Application	Description	Part Number	Retail Price	
	Bobcat® Ind/Const: 5600, 5610, Skid Steer Loaders: 463, 751C, 753G, 763, 763G, 773, 773G, 773GT, 853, 863, 863F, 863G, 863H, 863HF, 873, 873C, 873F, 873G, 883, A300, S70, S100, S130 SN 527411001 & ASN A00E11001, S150, S160, S160HF, S175, S175HF, S185, S185HF, S205, S220, S220H, S250, S250HF, S250K, S300, S330, S510 SN A3NK11001 & ASN AZN411001, S530 SN A7TW11001 & ASN AZN711001, S550 SN A3NM11001 & ASN AZN911001, S570 SN A7U811001 & ASN AZNC11001, S630 SN B2L511001, S650 SN S1ML11001 & ASN 1MLS11001, Track Skid Steer Loader: 864, 864EH, 864F, 864G, 864H, 864T, T110, T140, T180 SN 527511001, 527611001 & ASN A3LL11001, T190 SN 519411001, 527011001, 527811001, 531611001, 531711001 & ASN A3LN11001, T190G, T190H, T190K, T200, T200G, T200H, T250, T250G, T250H, T300 SN 522011001, 525411001, 532111001, A5GU11001 & ASN A5GV11001, T300ACS, T300G, T300H, T300K, T320, T320H, T450 SN AUV11001 & ASN B1EM11001, T550 SN A7UJ11001 & ASN AJZV11001, T590 SN A3NR11001 & ASN A3N511001, T630 SN A7PU11001 & ASN AJDT11001, T650 SN A3P011001, A3P11001, 1MLT11001 & ASN B2KZ11001, T750 SN ANKA11001 & ASN ATF611001, T870	Seat and Suspension Assembly • Durable black vinyl covering • Adjustable backrest • Lumbar support • Retractable seat belt • Shock absorber • Suspension stroke up to 2.30" or 3.10" • Mechanical weight adjustment from 110 to 375 lbs • Fore/aft adjustment • Safety tether to meet construction standards Includes Grammer 531 Seat, Grammer MSG65 Low-Profile Mechanical Suspension	Black Vinyl	AM7149786	\$ 677.01
			Fore/Aft Isolator	AM1191515	\$ 223.00
			Seat Belt	AM1405472	\$ 95.00
			Duo-Links		
	For Forklifts, Mowers and Skid Steer Loaders	Seat and Suspension Assembly • Durable black vinyl covering • Adjustable backrest • Lumbar support • Retractable seat belt • Shock absorber • Suspension stroke up to 2.30" or 3.10" • Mechanical weight adjustment from 110 to 375 lbs • Fore/aft adjustment Includes Grammer 531 Seat and Grammer MSG65 Low-Profile Mechanical Suspension	Black Vinyl	AM1254628	\$ 666.00
	Bobcat® Skid Steer Loaders, Caterpillar® Skid Steer Loaders	Seat and Suspension Assembly • Durable gray vinyl covering • Contoured foam cushions to ensure operator comfort • Manual weight adjustment • Adjustable slide rails • Mechanical suspension w/ suspension travel of 3" • Accepts operator presence switch	Black Vinyl	AMSS7939	\$ 610.00
			Gray Vinyl	AMSS8029	\$ 610.00

Industrial / Construction / Turf

Industrial / Construction / Turf

Seats and Suspensions

	Application	Description		Part Number	Retail Price
	Ford®/New Holland® Ind/Const: 230A, 231, 233, 234, 250C, 260C, 333, 334, 335, 340, 340B, 345C, 345D, 420, 445, 445A, 445C, 445D, 450, 515, 530A, 531, 532, 535, 540A, 540B, 545, 545A, 545C, 545D, 550, 555, 1801, 3550	Seat and Suspension Assembly • Wrap-around style backrest • Adjustable to suit driver's weight up to 265 lbs • Slide rails provide fore/aft adjustment • Adjustable base angle • Mechanical suspension • Multiple mounting patterns Replaces 44907538, 81874576, 83982816, E9NN400AA, E9NN400AB99M	Black Vinyl	AMSS8093	\$ 90.00
			Blue Vinyl	AMSS7465	\$ 90.00
	John Deere® Skid Steer Loaders: 240, 250, 260, 270, 280, 312GR, 313, 314G, 315, 316GR, 317, 317G, 318D, 318E, 318G, 319D, 319E, 320, 320D, 320E, 323D, 323E, 324E, 325, 326D, 326E, 328, 328D, 328E, 329D, 329E, 330G, 331G, 332, 332D, 332E, 332G, 333D, 333E, 333G, Track Skid Steer Loaders: CT315, CT322, CT332	Seat and Suspension Assembly • Plug-and-play • Grammer MSG75G low-profile air suspension • Durable gray fabric covering • Adjustable backrest • Mechanical lumbar support • Adjustable suspension stroke of 2.30" to 4.30" • Weight adjustment from 100 to 375 lbs • Fore/aft adjustment • Operator presence switch Includes Grammer 531 Seat and Grammer MSG75G Air Suspension Replaces 427490, AT315073, AT344971, AT361224, AT405894, AT434492	Asphalt	AMAT347476	\$ 998.00
			Gray Fabric		
		Fore/Aft Isolator		AM1191515	\$ 223.00
	John Deere® Skidders: 540D, 548D, 640D, 648D	Seat and Suspension Assembly • Wrap-around style backrest • Adjustable to suit driver's weight up to 265 lbs • Slide rails provide fore/aft adjustment • Adjustable base angle • Mechanical suspension • Multiple mounting patterns Replaces AL31842, AL35635, AL36556, AL39913	Yellow Vinyl	AMSS8094	\$ 90.00

Seat Tops and Cushions

	Application	Description		Part Number	Retail Price
	For Grammer Suspensions	Seat Assembly • Grammer 742 tall back seat • Durable black/gray matrix fabric covering • Armrests • Operator presence switch	Black/Gray Matrix	AMSS11052	\$ 730.00
			Fabric		
		Seat Assembly w/ Swivel	Black/Gray Matrix	AMSS11054	\$ 790.00
			Fabric		

Industrial / Construction / Turf

	Application	Description		Part Number	Retail Price
	For Grammer Suspensions	Seat Assembly • Grammer 741 seat • Durable black/gray matrix fabric covering • Armrests • Backrest extension for extra backrest height • Operator presence switch	Black/Gray Matrix Fabric	AMSS11051	\$ 657.00
		Seat Assembly w/ Swivel	Black/Gray Matrix Fabric	AMSS11053	\$ 724.00
	For Grammer Suspensions	Seat Assembly • Grammer 731 seat • Durable black/gray matrix fabric covering • Armrests • Backrest extension for extra backrest height	Black/Gray Matrix Fabric	AMSS11007	\$ 526.00
		Seat Assembly w/ Swivel	Black/Gray Matrix Fabric	AMSS11033	\$ 675.00
	For Grammer Suspensions	Seat Assembly • Grammer 731 seat • Durable black/gray matrix fabric covering	Black/Gray Matrix Fabric	AM1205873	\$ 354.00
	For Grammer Suspensions	Seat Assembly • Grammer 731 seat • Durable black vinyl covering • Armrests • Adjustable lumbar support	Black Vinyl	AMSS11025	\$ 523.00
	For Grammer Suspensions	Seat Assembly • Grammer 731 seat • Durable black vinyl covering • Adjustable lumbar support	Black Vinyl	AM1205871	\$ 322.00
	For Grammer Suspensions	Seat Assembly • Grammer 731 seat • Durable gray vinyl covering • Armrests • Adjustable lumbar support • Slide rails • Operator presence switch	Gray Vinyl	AM1110258	\$ 443.00
	John Deere® Backhoe-Loader: 410B	4-Piece Seat Assembly • Heavy duty yellow vinyl covering • Steel-back construction • High density foam cushions for added comfort	Yellow Vinyl	AMSS7896	\$ 374.00
	John Deere® Lawn Mowers: 240, 245, 260, 265, 285, 320, (325, 335, 345, 415, 425 BSN 070000), 445, 455, (F710, F725 ASN 090001), F735, G100, L100, L105, L107, L110, L118, L120, L130, L135, L145, LX172, LX173, LX176, LX178, LX186, LX188, SST16, SST18	Bucket Seat • Seat is 18.75" x 18.80" x 19" • Durable, blow-molded plastic frame is corrosion resistant • Multiple mounting patterns • Accepts twist-in-mount operator presence switch	Yellow Vinyl	AMSS7927	\$ 70.00

Industrial / Construction / Turf



Industrial / Construction / Turf

	Application	Description		Part Number	Retail Price
	Forklifts, Industrial Equipment, Skid Steers, Small Construction Equipment, Turf Equipment	Universal Seat Bolt pattern: front to back - 11" center-to-center left to right - 11.25" center-to-center Blow-molded plastic bucket, non-sewn covers, will not crack or peel away from foam. Waterproof w/ drain hole.	Gray Vinyl	AMSS6777T	\$ 166.00
	For Grammer S7X2 High Back Seat Assemblies	Seat Frame, High Back S7X2 Frame Only, Cushions Not Included Includes Seat Frame, Mechanical Lumbar, Slide Rails and Literature Box		AM1125651	\$ 245.00
	John Deere® Mowers: 1600, 1600T, 1620, 3215B, 3225B, 3225C, 3235B, 3245C	Seat Back For SuperComfort™ Seat	Yellow Vinyl	AMAL117331	\$ 85.00
		Seat Cushion For SuperComfort™ Seat	Yellow Vinyl	AMAL117332	\$ 85.00
	John Deere® Telehandler: 3800	Seat Back For 7X1 Grammer Seat Assemblies	Alaska Brown Cloth	AMAL116984	\$ 158.00
	For Grammer 741 and 742 Seat Assemblies	Seat Cushion	Black/Gray Matrix Fabric	AM1344872	\$ 122.00
	For Forklifts, Mowers and Skid Steer Loaders w/ Grammer 5X1 Seat Assemblies	Seat Back	Black/Gray Matrix Fabric	AM1344863	\$ 94.00
	John Deere® Skid Steer Loaders: 312GR, 314G, 316GR, 318D, 318E, 318G, 319E, 320D, 320E, 323E, 326D, 326E, 328D, 328E, 332D, 332E, Track Skid Steer Loaders: 317G, 319D, 323D, 329D, 329E, 333D, 333E	Seat Back For Grammer Seat Assemblies Replaces 1212296	Black Vinyl	AMAT413666	\$ 104.00
		Seat Cushion For Grammer Seat Assemblies Replaces 1212294, 73445667EF, 9791405600	Black Vinyl	AMAT413667	\$ 119.00
	John Deere® Ind: 210K, 210K EP, 210L, 210L EP, 210LJ	Seat Cushion For Grammer 721 and 722 Seat Assemblies Replaces 14666-010, 141497, 172467-64120, 7345681EF, 1914101147, L3514338003, L13514338003	Black Vinyl	AMCB11487692	\$ 169.00

Seats and Suspensions

Industrial / Construction / Turf

Suspensions

Application	Description	Part Number	Retail Price
For Grammer Seat Assemblies	Suspension, Air <ul style="list-style-type: none"> • Grammer MSG97G air suspension • Front controls • Suspension stroke up to 7" • Adjustable to suit driver's weight from 110 to 485 lbs • Fore/aft adjustment • Height adjustment up to 3.10" • Shock absorber 	AM1378253	\$ 699.25
For Grammer Seat Assemblies	Suspension, Air For 24 Volt Systems <ul style="list-style-type: none"> • Grammer MSG97G air suspension • Self-contained 24-volt compressor • Front controls • Suspension stroke up to 7" • Adjustable to suit driver's weight from 110 to 485 lbs • Fore/aft adjustment • Height adjustment up to 3.10" • Shock absorber 	AM1338593	\$ 681.75
For Grammer Seat Assemblies	Suspension, Air For 24 Volt Systems <ul style="list-style-type: none"> • Grammer MSG97 low-frequency air suspension • Self-contained 24-volt compressor • Frame width of 17" • Front controls • Fore/aft isolator • Suspension stroke up to 7" • Height adjustment up to 3.10" • Adjustable to suit driver's weight from 100 to 400 lbs • Weight indicator • Shock absorber 	AM1241742	\$ 470.00
 For Grammer Seat Assemblies	Suspension w/ Wiring Harness, Air <ul style="list-style-type: none"> • Grammer MSG95GL DDS air suspension • Suspension stroke of 100 mm • Fore/aft adjustment 	AMSS11016	\$ 619.00
 For Grammer Seat Assemblies	Suspension, Air <ul style="list-style-type: none"> • Grammer MSG95G air suspension • Frame width of 11.75" • Side controls • Fore/aft isolator • Air suspension w/ suspension travel of 4" • Suspension stroke up to 7" • Adjustable to suit driver's weight from 110 to 285 lbs • Weight indicator • Shock absorber 	AM1319704	\$ 536.51
 For Grammer Seat Assemblies	Suspension, Air <ul style="list-style-type: none"> • Grammer MSG95G air suspension • Frame width of 11.75" • Front controls • Fore/aft isolator • Air suspension w/ suspension travel of 4" • Suspension stroke up to 7" • Adjustable to suit driver's weight from 110 to 285 lbs • Weight indicator • Shock absorber 	AM1319705	\$ 617.00



Industrial / Construction / Turf

Industrial / Construction / Turf

Seats and Suspensions

	Application	Description	Part Number	Retail Price
	For Grammer Seat Assemblies	Suspension, Air For 24 Volt Systems • Grammer MSG95G air suspension • Self-contained 24-volt compressor • Frame width of 11.75" • Side controls • Fore/aft isolator • Air suspension with suspension travel of 4" • Suspension stroke up to 7" • Adjustable to suit driver's weight from 110 to 285 lbs • Weight indicator • Shock absorber	AM1319709	\$ 583.00
	For Grammer Seat Assemblies	Suspension, Air • Grammer MSG93 compact air suspension • Frame width of 8.92" • Front controls • Manual weight adjustment w/ push-pull switch control	AM1225983	\$ 528.27
	For Grammer Seat Assemblies	Suspension, Mechanical • Grammer MSG87 mechanical suspension • Height adjustment up to 3.10" • Suspension stroke up to 7" • Adjustable to suit driver's weight from 110 to 400 lbs • Weight indicator	AM1347434	\$ 683.08
	For Grammer Seat Assemblies	Suspension, Mechanical • Grammer MSG85 mechanical suspension • Frame width of 11.75" • Suspension travel of 4" • Suspension stroke up to 7" • Flip-handle weight adjustment from 110 to 285 lbs • Weight indicator • Three-position height adjustment of 3"	AM1201579	\$ 354.00
	For Grammer Seat Assemblies	Suspension, Mechanical • Grammer MSG83 compact mechanical suspension • Flip-handle weight adjustment • Front weight indicator • Three-position height adjustment • Frame width of 8.92"	AM1225985	\$ 364.00

Seat and Suspension Components









	Application	Description	Part Number	Retail Price
	John Deere® Mowers: 1420, 1435, 1445, 1550, 1565, 1570, 1575, 1580, 1585, 2700, 2750, 8400	Armrest, Right Hand Armrest, Left Hand A60/320, 60 mm x 380 mm For Grammer Seat Assemblies	AMTCA19839 AMTCA19827	\$ 95.00 \$ 94.00
	John Deere® Telehandler: 3800	Swivel Plate For 721, 722, 731, 732, 741 and 742 Seat Assemblies w/ Integrated Swivel	AMAL117351	\$ 62.00

Industrial / Construction / Turf

	Application	Description	Part Number	Retail Price
	For Grammer MSG85, MSG95 and MSG95 DDS Suspensions	Side-to-Side Isolator	AM1139345	\$ 294.00
	John Deere® Swing Machines: 2154D, 2154G, 2154GLC, 2156G, 2156GLC, 2454D, 2654G, 2656G, 2954D, 3154G, 3156G, 3754D, 3754G, 3754GLC, 3756G, 3756GLC, Forwarders: 810E, 1010E, 1110E, 1210E, 1510E, 1910E, Wheel Harvesters: 1070E, 1170E, 1270E, 1470E	Seat Depth and Tilt Bezel and Lever Kit For Grammer 721, 722, 731, 732, 741 and 742 Seat Assemblies	AMF073716	\$ 35.00
	John Deere® Mowers: 1420, 1435, 1445, 1545, 1550, 1565, 1570, 1575, 1580, 1585, 8400, Skid Steer Loaders: 312GR, 314G, 316GR, 318D, 318E, 318G, 319E, 320D, 320E, 323E, 326D, 326E, 328D, 328E, 332D, Track Skid Steer Loaders: 317G, 319D, 323D, 329D, 329E, 333E	Backrest Adjustment Lever Recline Lever Replaces 1192519	AMAT365419	\$ 24.00
	John Deere® Mowers: 2700, 2750	Backrest Adjustment Lever For Grammer 721, 722, 731, 732, 741 and 742 Seat Assemblies w/ Front Facing Lever	AMAUC11776	\$ 20.50
	For Grammer MSG97 12 Volt Suspensions Will not work on 24 Volt Suspensions	Heated Switch Kit	AM1250169	\$ 70.00
	John Deere® Skid Steer Loaders: (312GR, 314G, 316GR ASN 366357), (318D, 318E, 319E, 320D, 320E, 323E, 326D, 326E, 328D, 328E, 332E BSN 267547), Track Skid Steer Loader: 317G ASN 366357, (319D, 323D, 329D, 329E, 333D, 333E BSN 267547)	Slide Rail Kit For Grammer MSG75 Air Suspensions	AMAT365416	\$ 73.00
	John Deere® Backhoe-Loaders: 210C, 300D, 310C, 310D, 315C, 315D, 410B, 410C, 410D, 510B, 510C, 510D, 610B, 610C, 710B, 710D, Excavators: 690CR, 690D, 690DR, Telehandler: 3800, Track Feller Buncher: 693D	Tension Spring For Grammer MSG85 Suspensions	AMT82227	\$ 19.00
	John Deere® Telehandlers: 3200, 3215, 3220, 3400, 3415, 3420	Tension Spring For Grammer MSG83 Suspensions	AML114921	\$ 13.80
	Universal Equipment	Seat Belt, Retractable 55" long from bolt hole to hold hole when extended out	AMX6824	\$ 44.00
	For Grammer 721, 731 and 741 Seat Assemblies	Literature Box Kit	AMAL117363	\$ 28.00







Industrial / Construction / Turf

Industrial / Construction / Turf

	Application	Description	Part Number	Retail Price
	John Deere® Mowers: 1420, 1435, 1445, 1550, 1565, 1570, 1575, 1580, 1585, 8400, Skid Steer Loaders: 312GR, 314G, 316GR, 318D, 318E, 318G, 319E, 320D, 320E, 323E, 326D, 326E, 328D, 328E, 332D, 332E, 333E, Track Skid Steer Loaders: 317G, 319D, 323D, 329D, 329E, 333D, 333E	Compressor Kit 12 Volt For Grammer Suspensions	AMAT365417	\$ 192.00
	John Deere® Telehandlers: 3200, 3215, 3220, 3400, 3415, 3420	Compressor For Grammer MSG93 Suspensions	AMAL117313	\$ 144.00
	John Deere® Forwarders: 810E, 1010E, 1110E, 1210E, 1510E, 1910E, Wheeled Harvesters: 1070E, 1170E, 1270E, 1470E	Air Level Control Switch Kit For Grammer MSG95A, MSG97A or MSG97AL Suspensions in Generation 1 Models w/ Rotating and Leveling Cab	AMF683869	\$ 58.00
	John Deere® Telehandlers: 3200, 3215, 3220, 3400, 3415, 3420	Air Hose Kit Replaces 1159864, AL117315	AMAL180863	\$ 46.25
	John Deere® Mowers: 1545, 1550, 1570, 1580, Skid Steer Loaders: 312GR, 314G, 316GR, 318D, 318E, 318G, 319E, 320D, 320E, 323E, 326D, 326E, 328D, 328E, 332D, 332E, 333E, Track Skid Steer Loaders: 317G, 319D, 323D, 329D, 329E, 333D	Housing Kit For Grammer MSG75 Suspensions 80 mm	AMAT414347	\$ 79.00
	John Deere® Mowers: 1420, 1435, 1445, 1550, 1565, 1570, 1575, 1580, 1585, 8400, Skid Steer Loaders: 312GR, 314G, 316GR, 318D, 318E, 318G, 319E, 320D, 320E, 323E, 326D, 326E, 328D, 328E, 332D, 332E, Track Skid Steer Loaders: 317G, 319D, 323D, 329D, 329E, 333D, 333E	Air Spring Kit For Grammer Suspensions	AMAT365418	\$ 152.00
	John Deere® Mowers: 7500A, 7700A, 8700A, 8800A, 8900A, 9009A	Air Spring For Grammer MSG95A, MSG95G, MSG95GL DDS and MSG97A Suspensions Early Style Universal Air Spring Tee Fitting at Top Mount Includes Plug Fittings for extra Air Ports not used Air Lines Not Included	AMAL166455	\$ 153.00
	John Deere® Skid Steer Loaders: (312GR, 314G, 316GR, 318G ASN 366357), (318D, 318E, 319E, 320D, 320E, 323E, 326D, 326E, 328D, 328E, 329D, 332D, 332E BSN 267546), John Deere® Track Skid Steer Loader: 317G ASN 366357, (319D, 323D, 329E, 333D, 333E BSN 267546)	Operator Presence Switch Kit For Grammer MSG65 and MSG75 Suspensions	AMAT365412	\$ 117.00
	For Grammer MSG85 Mechanical Suspensions	Suspension Rebuild Kit Includes Adjusting Shaft, Clevis, Spindle, Springs, Weight Indicator and Hardware	AM1163691	\$ 68.00
	For Forklifts, Mowers and Skid Steer Loaders w/ Grammer MSG65 Mechanical Suspensions	Rubber Boot	AM1079665	\$ 25.00
	John Deere® Mowers: 7500A, 7700A, 8700A, 8800A, 8900A, 9009A, Wheel Feller Bunchers: 643G, 843G	Rubber Boot For Grammer MSG95G Suspensions	AMAT177339	\$ 144.00

Seats and Suspensions

Industrial / Construction / Turf

	Application	Description	Part Number	Retail Price
	John Deere® Mowers: 1600, 7500A, 7700A, 8700A, 8800, 8800A, 8900, 8900A, 9009A	Rubber Boot For Grammer MSG95G Suspensions	AMAL210536	\$ 94.00
	John Deere® Mowers: 1600, 1620, 3215B, 3225B, 3225C, 3235B, 3235C, 3245C, Telehandlers: 3200, 3215, 3220, 3400, 3415, 3420	Rubber Boot For Grammer MSG83 Suspensions	AMAL117270	\$ 52.00
	John Deere® Skid Steer Loaders: 312GR, 314G, 316GR, 318D, 318E, 318G, 319E, 320D, 320E, 323E, 326D, 326E, 328D, 328E, 332D, 332E, Track Skid Steer Loaders: 317G, 319D, 323D, 329D, 329E, 333D, 333E	Rubber Boot For Grammer Suspensions	AMAT365413	\$ 54.00
	John Deere® Telehandlers: 3200, 3215, 3220, 3400, 3415, 3420	Rubber Boot For Grammer MSG93 Suspensions	AMAL117322	\$ 48.00
	For Grammer MSG85, MSG95G, MSG95GL DDS and MSG97 Suspensions	Shock Absorber Replacement Shock Absorber for Grammer Side-to-Side Isolator	AM1019014	\$ 23.00
	John Deere® Backhoe-Loaders: 210C, 300D, 310C, 310D, 315C, 315D, 410B, 410C, 410D, 510B, 510C, 510D, 610B, 610C, 710B, 710C, 710D, Excavators: 690CR, 690D, 690DR	Shock Absorber For Grammer Suspensions	AMAT84224	\$ 84.00
	John Deere® Mowers: 6080A, 6500A, 6700A, 7200A, 7400A, 7500, 7500A, 7700, 7700A, 8000A, 8500, 8700, 8700A, 8800, 8800A	Shock Absorber For Grammer MSG85 Suspensions	AMTCA18446	\$ 82.00
	John Deere® Mowers: 7700A, 8700A, 8800A, 8900A, 9009A	Shock Absorber For Grammer MSG95G Suspensions	AMAL117453	\$ 63.00
	John Deere® Mowers: 1600, 1620, 3225B, 3225C, 3235B, 3245C, Telehandlers: 3200, 3215, 3220, 3400, 3415, 3420	Shock Absorber For Grammer MSG83 Suspensions	AMAL117265	\$ 65.00
	John Deere® Skid Steer Loaders: (312GR, 314G, 316GR, 318G ASN 366357), (318D, 318E, 319E, 320D, 320E, 323E, 326D, 326E, 328D, 328E, 332D, 332E BSN 267547), Track Skid Steer Loader: 317G ASN 366357, (319D, 323D, 329D, 329E, 333D, 333E BSN 267547)	Shock Absorber For Grammer Suspensions	AMAT365415	\$ 58.00
	John Deere® Swing Machines: 2154D, 2154G, 2154GLC, 2156G, 2156GLC, 2454D, 2654G, 2656G, 2954D, 3154G, 3156G, 3754D, 3754G, 3754GLC, 3756G, 3756GLC	Shock Absorber For Grammer MSG95A, MSG95AL, MSG95G, MSG95GL DDS Suspensions	AMAL210505	\$ 127.00
	John Deere® Swing Machines: 2154D ASN 210531, 2454D ASN 240114, 2954D ASN 290111, 3754D ASN 370067	Shock Absorber For Grammer MSG95G and MSG95GL DDS Suspensions	AMAL210544	\$ 187.00
	John Deere® Telehandler: 3800	Shock Absorber Kit For Grammer MSG85, MSG95G, MSG95GL DDS and MSG97 Suspensions Replacement Shock Absorber for Grammer AM1139345 Side-to-Side Isolator	AMAL151004	\$ 49.00

Prices Subject to Change without Prior Notice. The use of original equipment manufacturer (OEM) part numbers or trademarks, e.g. Case® and John Deere®, are for reference purposes only and for indicating product use and compatibility. Our company and the listed replacement parts contained herein are not sponsored, approved or manufactured by the OEM. All parts are New unless designated Reman in the description.

Industrial / Construction / Turf

Industrial / Construction / Turf



Application	Description	Part Number	Retail Price
Case® Backhoe-Loaders: 655E, 675E, Wheel Loaders: 21D, 21E, (21E, 121E, 321E - Series 3), 21F, 121E, 121F, 221D, 221E, 221F, 321D, 321E, 321F, 521F, 721E, 721F, 821E, 821F, 921E, 921F, Case IH® Telehandlers: 635, 735, 742, Ford®/New Holland® Backhoe-Loaders: 555E, 575E, B90B, B95, B95B, B95BLR, B95BTC, B95C, B95CLR, B95CTC, B95LR, B95TC, B100B, B100BLR, B100BTC, B110, B110B, B110BTC, B110C, B115, B115B, B115BTC, LB75, LB75.B, LB90, LB90.B, LB95, LB110, LB110.B, LB115-4WS, LB115.B, LB115.B-4WS, Telehandlers: LM6.35, LM7.42, Wheel Loaders: LW50.B, LW80.B, W50BTC, W50C, W50TC, W60BTC, W60C, W70BTC, W70C, W80BTC, W80C, W80TC (Compact and Mini), W110B, W130B, W130C, W170B, W170C, W190B, W190C, W230C	Fork and Bearing Kit For Grammer MSG85 Suspensions	AM9704956	\$ 34.00

Seats and Suspensions

Sprayer Parts

Table of Contents

Sprayer Parts for John Deere®	116	Hydrostats	118
Air Springs	118	Operator Station	116
Belts	119	Tanks and Retainers	117
Drive Hub and Axle Assemblies	116	Transmissions and Components	118
Fenders	116		
Hydraulics	118		

Sprayer Parts for John Deere®



Pumps

Application	Description	Part Number	Retail Price	Core
 210, 220, 250, 320, 335, 520, 535, 550, 6000 Hi-Cycle	Solution Pump Replaces AN151808	AMAN152866	\$ 496.00	

Operator Station

Application	Description	Part Number	Retail Price	Core
4700, 4710, 4720	Ladder Actuator Late Model 16 1/2" Long	AMAN205299	\$ 704.00	

Fenders

Application	Description	Part Number	Retail Price	Core
 6000 Hi-Cycle	Front Fender	AMAN152123	\$ 190.00	
 6000 Hi-Cycle, 6100, 6500, 6700	Front Fender, Poly	AMN202587	\$ 235.00	
 6000 Hi-Cycle	Rear Fender, Right Hand	AMAN85180	\$ 575.00	
	Rear Fender, Left Hand	AMAN152193	\$ 575.00	

Drive Hub and Axle Assemblies





Application	Description	Part Number	Retail Price	Core
4700	Hub Assembly, Rear 30:1 Gear Ratio	AMAN204897	\$ 5450.00	

Sprayer Parts for John Deere®

Sprayer Parts

Sprayer Parts

Sprayer Parts for John Deere®

	Application	Description	Part Number	Retail Price	Core
	4700, 6100, 6500 ASN 6001, 6600, 6700 BSN 4000	Hub Assembly 34:1 Gear Ratio, Nut Retainer	AMAN204749	\$ 4500.00	
	6500 BSN 6000	Hub Assembly 40:1 Gear Ratio, Nut Retainer	AMAE55305	\$ 4500.00	
	Patriot Sprayers: 3230, 3240 Front, 3330, SPX3320	Hub Assembly 25.2:1 Ratio Replaces 87269800	AM84280675	\$ 3471.00	
	Patriot Sprayers: 3230, 3240 Rear, 3330, SPX3320	Hub Assembly 31:1 Ratio Replaces 87269801`	AM84280676	\$ 4602.00	
	6000 Hi-Cycle	Reman Rear Axle Assembly	AMN202232	\$ 1250.00	\$ 200.00
	4920, 4930	Hydraulic Wheel Motor, Front 80 cc Replaces AN206097	AMAKK10707	\$ 6292.80	
	4920, 4930, 4940	Hydraulic Wheel Motor, Rear Replaces AN206098, AN208426	AMAN405695	\$ 8635.50	
	R4030 BSN 192001	Hydraulic Wheel Motor, Rear 60 cc w/o Loop	AMAN403491	\$ 4416.55	
	R4030 BSN 192001	Hydraulic Wheel Motor, Front 60 cc w/ Loop	AMAN403490	\$ 4679.70	
	R4038	Hydraulic Wheel Motor, Rear 80 cc w/ Speed Sensor	AMAN401953	\$ 6292.80	
	R4038 BSN 194001	Hydraulic Wheel Motor, Front 80 cc w/o Loop	AMAN401954	\$ 6292.80	
	R4045 SN 006000-186000	Hydraulic Wheel Motor, Front 107 cc	AMAN405719	\$ 8635.50	
	R4045 SN 006000-176999, R4060	Hydraulic Wheel Motor, Rear 107 cc	AMAN405785	\$ 8635.50	
	Patriot Sprayers: (3230, 3330 ASN YCT0362640), 3240, SPX3320	Hydraulic Wheel Motor 55 cc Replaces 87269799	AM84476649	\$ 2980.15	
	4940	Hydraulic Axial Piston Motor, Front Replaces AN307111, AN402684	AMAN405694	\$ 8635.50	

Tanks and Retainers

	Application	Description	Part Number	Retail Price	Core
	6000 Hi-Cycle, 6100	Poly Tank	AMAN203203	\$ 1095.00	
	6000 Hi-Cycle, 6100	Tank Bracket, 2 Pc.	AMAN152400	\$ 935.00	
	6500, 6700	Tank Bracket, 2 Pc.	AMAN153498	\$ 1350.00	

Sprayer Parts

Sprayer Parts

Application	Description	Part Number	Retail Price	Core
6000 Hi-Cycle	Retainer	AMN155039	\$ 255.00	



Hydrostats

Application	Description	Part Number	Retail Price	Core
6500, 6600, 6700	Reman Hydrostat, Sundstrand	H6500S	\$ 3150.00	\$ 500.00
3230, 3240, 3330, SPX3320	Hydrostat Pump 56 cc, 11 Tooth, Left Hand	AM84399369	\$ 5279.15	
4920, 4930	Hydrostat Pump Includes Front and Rear Pumps Replaces PG200722	AMAN209066	\$ 13233.50	
SPX4260, SPX4410, Patriot Sprayers: 2240, 2250, 3230, 3240, 3330, 3340, 4420, 4430, 4440, SPX3320	Hydraulic Pump	AMBN316492	\$ 1193.20	
Patriot Sprayers: 3230, 3240, 3330, SPX3320	Hydrostat Pump 56 cc, 13 Tooth, Right Hand Replaces 87269803	AM84399370	\$ 5106.25	

Transmissions and Components

Application	Description	Part Number	Retail Price	Core
6000 Hi-Cycle	Main Drive Gear	AMN155041	\$ 350.00	
6000 Hi-Cycle	3rd Gear	AMN155024	\$ 220.00	
6000 Hi-Cycle	Countershaft Replaces N153385	AMAN153385	\$ 120.00	
6000 Hi-Cycle	Countershaft	AMN155031	\$ 495.00	
6000 Hi-Cycle	1st & 2nd Synchronizer Replaces AN152160	AMAN153231	\$ 350.00	
6000 Hi-Cycle	3rd & 4th Synchronizer	AMAN152161	\$ 220.00	
6000 Hi-Cycle	Synchronizer	AMN155025	\$ 47.00	

Hydraulics

Application	Description	Part Number	Retail Price	Core
4630 ASN 054999, R4030, R4038, R4044, R4045	Auxiliary Hydraulic Pump	AMAN403480	\$ 2393.05	
4920, 4930	Auxiliary Hydraulic Pump	AMAN206024	\$ 3087.50	

Air Springs

Application	Description	Part Number	Retail Price	Core
(4700, 4710, 4720 - Front and Rear), (4730, 4830 - Rear)	Absorber For Sleeve Air Spring	AMAN205362	\$ 395.00	
(4730, 4830 - Rear)	Absorber	AMAN209716	\$ 450.00	
4920, 4930, 4940, R4045	Absorber For Sleeve Air Spring	AMAN205761	\$ 625.00	

Sprayer Parts for John Deere®

Sprayer Parts

Sprayer Parts

Sprayer Parts
for JD®

Belts

Application	Description	Part Number	Retail Price	Core
6100, 6500, 6600	Main Drive Belt 3 Banded Replaces N202372, N203950	AMN204624	\$ 109.44	

Planter & Grain Drill Parts

Table of Contents



<p>Commodity Cart Parts 152</p> <p style="padding-left: 20px;">Air System Parts—Air Tube Couplers and Components 163</p> <p style="padding-left: 20px;">Air System Parts—Distributors, Plenums and Tubes 154</p> <p style="padding-left: 20px;">Air System Parts—Manifold Components 157</p> <p style="padding-left: 20px;">Conveyor Components 164</p> <p style="padding-left: 20px;">Ladders and Components 165</p> <p style="padding-left: 20px;">Meter Housing and Components 152</p> <p style="padding-left: 20px;">Tank and Hopper Components 165</p> <p>Grain Drill and Air Seeder Parts for John Deere® 132</p> <p style="padding-left: 20px;">Air System Parts 139</p> <p style="padding-left: 20px;">Gauge and Packer Wheels 135</p> <p style="padding-left: 20px;">Keeton® Seed Firmers 135</p> <p style="padding-left: 20px;">Recappers 139</p> <p style="padding-left: 20px;">Row Unit Components 138</p> <p style="padding-left: 20px;">Seed Boots and Components 133</p> <p style="padding-left: 20px;">Seeder Blades and Components 132</p> <p>Grain Drill Parts for Landoll® 148</p> <p>Grain Drill Parts for Sunflower® 148</p> <p>Grain Drill Parts for Tye® 150</p> <p>No-Till Coulter Blades 151</p> <p>Planter and Grain Drill Parts for Case IH® 145</p> <p>Planter and Grain Drill Parts for Great Plains® 148</p>	<p>Planter and Grain Parts for New Holland® 147</p> <p>Planter Parts for John Deere® 120</p> <p style="padding-left: 20px;">Closing Wheels and Components 125</p> <p style="padding-left: 20px;">Fertilizer Shoes 130</p> <p style="padding-left: 20px;">Gauge Wheels and Components 122</p> <p style="padding-left: 20px;">Keeton® Seed Firmers 124</p> <p style="padding-left: 20px;">Opener Discs and Assemblies 120</p> <p style="padding-left: 20px;">Replacement Chains 131</p> <p style="padding-left: 20px;">Row Unit Components 127</p> <p style="padding-left: 20px;">Scrapers 121</p> <p style="padding-left: 20px;">Seed Tubes and Components 123</p> <p>Planter Parts for Kinze® and White® 140</p> <p style="padding-left: 20px;">Closing Wheels and Components 143</p> <p style="padding-left: 20px;">Gauge Wheels and Components 141</p> <p style="padding-left: 20px;">Keeton® Seed Firmers 143</p> <p style="padding-left: 20px;">Opener Discs and Assemblies 140</p> <p style="padding-left: 20px;">Replacement Chains 145</p> <p style="padding-left: 20px;">Row Unit Components 144</p> <p style="padding-left: 20px;">Scrapers 141</p> <p style="padding-left: 20px;">Seed Tubes and Components 142</p> <p>Sensors—Seed Flow and Population 151</p>
---	---

Replacement Parts for JD 7200-7300 and 1700 Series Planters

Row Unit	Planter frame row unit used on:
MaxEmerge®2	1760 Early, 1780 Early, 7200, 7300
MaxEmerge®Plus	1700, 1710, 1720, 1730, 1750, 1760, 1761NT, 1770, 1770NT, 1780
Pro	1770NT, 1790
XP	1700, 1710, 1720, 1730, 1750, 1760, 1761NT, 1770, 1770NT, 1780
XP Pro	1770NT, 1790









Planter Parts for John Deere®

Opener Discs and Assemblies



	Application	Description	Part Number	Retail Price
	1700, 1710, 1720, 1730, 1750, 1760, 1760NT, 1770, 1770NT, 1780, 1790, 7000-7340 MaxEmerge™, DB55, DB58, DB60, DB66, DB80, DB90 Replaces AA37474	Seed Disc Opener Assembly, 15" x 3.50 mm w/ 5/8" ID hole	AMAA53860	\$ 28.85
	XP, XP Pro Series	Seed Disc Opener Assembly, 15" x 3 mm	AMAA55927	\$ 25.50
	1770, 1790, 7000 Series	Disc Opener Bearing, 204 Series 0.628" ID, 1.782" OD	AMAA21480	\$ 6.85

Planter Parts for John Deere®











Planter & Grain Drill Parts

Application	Description	Part Number	Retail Price
 7000, 7100, 7200, 7300, 7340	Bearing 2.047" OD	AMA27002	\$ 6.00
 Fits All Models Except Early 1770NT and 1790 Replaces A48720	Disc Opener Blade 16" blade, 0.197" thick, 3 1/2" bolt circle, 2 1/2" pilot hole For single disc fertilizer opener, Import	AMA72358	\$ 28.00
 Early 1770NT and 1790	Disc Opener Blade 16" disc, 0.197" thick, 4 3/32" bolt circle, 3 3/16" pilot hole For single disc fertilizer opener, Import	AMA72404	\$ 32.00
(1705, 1715, 1725, 1765 ASN 760101), 1720, 1760, 1780, 7200, 7300	Double Disc Fertilizer Blade w/ Bearing 13.50" Diameter For double disc attachment that mounts to face of row unit	AMAA57467	\$ 37.00
 1750, 1755 (SN 760101-790101), 1760NT, 1770, 1780, 1785, 7000, 7200, 7240 Will also fit MaxEmerge™ Row Units and Groff; also MaxEmerge™ 2 and MaxEmerge™ Plus w/ double disc attachment that mounts to fertilizer bar	Fertilizer Disc, HD 13.50" disc w/ hub and bearing Blade # - A72359	AMAA57466	\$ 35.00
 1750, 1760NT, 1765NT, 1770, 1780, 1785, 1790, 7200, 7240 Will not fit 1770NT, 1775NT, 1790, 1795 w/ 6" x 10" or 7" x 7" Fertilizer Bar	Spindle For Single Disc Fertilizer Opener	AMA48724	\$ 25.00
 1770NT, 1775NT, 1790 ASN 720101, 1795	Spindle For Single Disc Fertilizer Openers w/ 6" x 10" or 7" x 7" Fertilizer Bar	AMA82768	\$ 25.00
 1700, 1750, 1760, 7000-7340 MaxEmerge™	Rubberized Plastic Cap For AMAA53860 Seed Disc Opener Assembly	AMA52024	\$ 0.56
71, 494, 494A, 494AN, 495, 495A, 694, 694A, 694AN, 695, 695A, 894A, 1240, 1250, 1260, 1280, 1290, 1300, (1705, 1715, 1725, 1755, 1765, 1765NT, 1785 ASN 760101), 1720, 1750, 1760NT, 1770, 1780, 4484, 4493, 4684, 4884, 5184, 5186, 5193, 7000, 7200	Dust Cap, Flat For Double Disc Fertilizer Opener	AMB29400	\$ 1.50
 1700, 1750, 1760, 7000-7340 MaxEmerge®	Metal Dust Cap For Fertilizer Disc Opener Assembly	AMA22836	\$ 1.06
 Disc Opener Assemblies	Nut, Right Hand	AM14H821	\$ 0.55
	Nut, Left Hand	AM14H944	\$ 1.45











Scrapers

Application	Description	Part Number	Retail Price
 1700, 1760, 1780, 7100, 7200, 7300, 7340	Rotating Disc Scraper Kit w/ Nylon Covers Includes (2) AMAA37221 Wheels, (1) AMA50047 Spring, (1) AMA69140 Right Hand Arm and (1) AMA69139 Left Hand Arm	AMX55006	\$ 17.25
 1700, 1760, 1780, 7100, 7200, 7300, 7340	Rotating Disc Scraper Kit w/ All Metal Wheels Includes (2) AMAA37221M Wheels, (1) AMA50047 Spring, (1) AMA69140 Right Hand Arm and (1) AMA69139 Left Hand Arm	AMX55007	\$ 17.25

Planter & Grain Drill Parts













Application	Description	Part Number	Retail Price
 1705, 1715, 1725, 1725CCS, 1725NT, 1755, 1765, 1765NT, 1770NT, 1775, 1775NT, 1785, 1790, 1795, DB37, DB37C, DB41, DB44, DB55, DB58, DB60, DB66, DB90, DB120	Scraper Kit Includes (1) Right Hand Scraper, (1) Left Hand Scraper and (1) Tension Spring Replaces A98182, A98183	AMX55056	\$ 15.00
 1700, 1760, 1780, 7100, 7200, 7300, 7340	Rotating Disc Scraper Wheel w/ Nylon Cover	AMAA37221	\$ 6.50
 1700, 1760, 1780, 7100, 7200, 7300, 7340	Rotating Disc Scraper Wheel, All Metal	AMAA37221M	\$ 6.50
 1700, 1760, 1780, 7000, 7100, 7200, 7300, 7340	Spring For Rotating Disc Scraper Kits	AMA50047	\$ 2.85
 1760, 1780, 7200 & 7300	Scraper Arm, Right Hand	AMA69140	\$ 3.50
 MaxEmerge™, MaxEmerge™ Plus, MaxEmerge™ XP	Scraper Arm, Left Hand	AMA69139	\$ 3.50
 803, 805, 1750, (1755, 1785, 1765 ASN 760101), 1760NT, 1770, 1780, 7000, 7200, 7240	Outside Scraper Includes mounting hardware For double disc fertilizer openers that mount to fertilizer bar (2) Required per Row	AMA24085	\$ 2.95
 7000, 7100 Planter Disc Openers	Scraper, Right Hand	AMAA26443	\$ 3.75
 7000, 7100 Planter Disc Openers	Scraper, Left Hand	AMAA26444	\$ 3.75
 1760, 1780, 7200 & 7300 MaxEmerge™ 2	Tungsten Seed Opener Scraper	AMAA62559	\$ 20.50

Gauge Wheels and Components

Application	Description	Part Number	Retail Price
 1760, 1780, 7200 & 7300 MaxEmerge™ 2	Gauge Wheel Tire 6.50" x 12", Smooth Crown	AMA58851	\$ 60.00
 1750, 7100, 9200 Replaces A84050	Gauge Wheel Tire, 4.50" x 16" Carlisle®	AMA22884	\$ 40.00
 XP and XP Pro Series	Gauge Wheel Tire, 4.50" x 16" Solid Urethane	AMA22884U	\$ 85.00
 XP and XP Pro Series	Gauge Wheel Tire, 4.50" x 16" Carlisle®, w/ Standard Profile Offset	AMA84062	\$ 40.00
 (1705, 1715, 1725, 1755, 1765, 1775 ASN 760101), (DB44, DB60, DB66, DB88, DB90, DB120 ASN 755101), DR12, DR16, DR18, DR24	Gauge Wheel Assembly, 4.50" x 16" Carlisle®, Spoked Replaces AA86055, AA98187	AMX55039	\$ 145.00
 (1705, 1715, 1725, 1755, 1765, 1775 ASN 760101), (DB44, DB60, DB66, DB88, DB90, DB120 ASN 755101), DR12, DR16, DR18, DR24	Gauge Wheel Assembly, 3" x 16" Carlisle®, Spoked Replaces AA85465, AA98188	AMX55041	\$ 135.00
 1760, 1780, 7000 & 7100 MaxEmerge™, 7200 & 7300 MaxEmerge™ 2	Gauge Wheel Assembly, 4.50" x 16" Yellow steel wheel halves, JD style chined tire and stem bearing w/ cross hole	AMAA35392	\$ 80.00
 1760, 1780, 7000 & 7100 MaxEmerge™, 7200 & 7300 MaxEmerge™ 2	Gauge Wheel Assembly, 4.50" x 16" Urethane Tire	AMAA35392U	\$ 120.00
 MaxEmerge®Plus, Pro Series	Gauge Wheel Assembly, 4.50" x 16" w/ AMAN131668 bearing Mount using Set Screws	AMAA41359	\$ 80.00
 MaxEmerge®Plus, Pro Series	Gauge Wheel Assembly Solid Urethane	AMAA41359U	\$ 120.00

Planter Parts for John Deere®

Planter & Grain Drill Parts









Application	Description	Part Number	Retail Price
 XP and XP Pro Series	Gauge Wheel Assembly, 4.50" x 16" Standard profile wheel assembly and nylon-steel wheel half combination w/ AMAN212132 bearing Replaces AN281360	AMAA66604	\$ 80.00
1700, 1720, 1730, 7300, 7340	Hub Assembly, 6-Bolt Replaces AN150825	AMAN183318	\$ 82.39
 7000 & 7100 MaxEmerge™, 7200 & 7300 MaxEmerge™ 2	Wheel Half, Steel Painted Yellow (2) Required	AMA22780	\$ 11.00
 MaxEmerge™ XP, XP Pro ASN 710101	Wheel Half, Steel Painted Black (2) Required	AMA77880	\$ 20.00
 7000 & 7100 MaxEmerge™, MaxEmerge™ Plus, MaxEmerge™ XP, Pro Row XP, Pro Series	Wheel Half, Plastic 8-Bolt	AMA56565	\$ 16.50
 XP, XP Pro	Double Row Ball-Bearing, 40 mm For 4" x 16" wheel assemblies	AMAN212132	\$ 7.50
 7000, 7100, MaxEmerge™ 2 1992 and Later, MaxEmerge™ Plus, Pro	Bearing w/ Sleeve Stem Type Replaces AA49161	AMAA38106	\$ 9.50
 MaxEmerge™ 2 1992 and Later, MaxEmerge™ Plus, Pro	Bearing Stem Type	AMAN131668	\$ 11.15
 7000-7100	Bearing w/ Hole For Closing and Press Wheels SL4x16 Sleeve Required on Press Wheel	AMAA35741	\$ 5.50
 For Gauge Wheel Assembly	Stem Bearing Bushing Use w/ AMAN131668 Stem Bearing or AMAA35741 Stem Bearing w/ Hole	AMA25915	\$ 1.60
 MaxEmerge@XP, XP Pro	Gauge Wheel Arm Kit Includes Arm, Threaded Bushing w/ 5/8" Hole, (2) Bolts and (3) Washers Replaces A79648	AMA92817	\$ 23.00
 7000-7300, MaxEmerge™ 2, MaxEmerge™ Plus	Gauge Wheel Arm Kit Includes (2) bushings Replaces A22572, A41968, A79647 For wheel that uses cross-drilled stem bearing	AMA54179	\$ 40.00
1700, 1705, 1710, 1715, 1720 CCS, 1730, 1745, 1750, 1755, 1760, 1765, 1770, 1775, 1780, 1790, 1795, DB37, DB41, DB44, DB55, DB60, DB62, DB66, DB74, DB80, DB83, DB88, DB90	Gauge Wheel Arm Bushing, Self-Aligning 5/8" Bolt Hole Diameter	AMA92818	\$ 8.50
 7000-7300, MaxEmerge™ 2, MaxEmerge™ Plus	Self-Aligning Bushing Use w/ AMA54179	AMA57058	\$ 11.00
 7000-7100 Planters	Self-Aligning Bushing Use w/ AMA22572T	AMA57057	\$ 10.00

Seed Tubes and Components





Application	Description	Part Number	Retail Price
 MaxEmerge™ Row Units w/ Curved Seed Tube	Slicer Knife Made from cast chrome	AMX55003	\$ 17.00
	Fastener Kit Required for AMX55003	AMX55004	\$ 1.50

Planter & Grain Drill Parts

Planter Parts for John Deere®

	Application	Description	Part Number	Retail Price
	1700	Seed Tube w/ 0.75" Diameter Monitor Hole	AMA56784	\$ 9.25
	7200, 7300, 7340	Seed Tube w/ 0.53" Diameter Monitor Hole	AMA55880	\$ 9.25
	1750, (1755, 1775, 1785 ASN 760101), 1770, 1780, 7000, 7200, 7240	Fertilizer Tube, Dry For Single and Double Disc Openers	AMB35601	\$ 9.75
	1700, 1760, 1786, 7000 & 7100 MaxEmerge™, 7200 & 7300 MaxEmerge™ 2, Pro Series	Guard-Scraper (Cast Frog)	AMA61577	\$ 6.25
	1700, MaxEmerge™ XP, XP Pro ASN 710101	Guard-Scraper	AMA80203	\$ 5.00
	MaxEmerge®2, Plus, Pro, XP, and XP Pro Replaces GA2031	Opener Guard	AMA48879	\$ 9.50
	7000, 7100	Handle Depth Adjustment Assembly	AMA42740	\$ 18.50
	7000, 7100	Seed Depth Stop	AMA42737	\$ 17.00
	1700, 1700TR, 1705, 1710, 1715, 1720, 1720 CCS, 1725, 1725 CCS, 1735, 1750, 1760, 1765, 1765NT, 1770, 1770NT, 1775, 1775NT, 1780, 1785, DB37, DB37C, DB41, DB44, DB55, DB55C, DB58, DB60, DB60T, DB62, DB66, DB74, DB74C, DB80, DB83, DB88, DB90, DB120, XP, MaxEmerge™ XP	Seed Sensor XP, Red LED, AccuCount™	AMAA61909	\$ 115.00

Keeton® Seed Firmers

	Application	Description		Part Number	Retail Price
	1700 Series, 7000, 7100, 7200, 7300, MaxEmerge™ 5 Note: will not fit ExactEmerge™	Keeton® Seed Firmer Seed Tube Mount	w/ Standard Dry Tail	AMX55018	\$ 44.00
			w/ Standard Liquid Tail	AMX55019	\$ 45.00
	1700 Series, 7000, 7100, 7200, 7300, MaxEmerge™ 5* *Requires Modifications Note: will not fit ExactEmerge™	Keeton® Seed Firmer Universal Bracket Bracket mounts to seed disc opener shafts	w/ Standard Dry Tail	AMX55050	\$ 47.00
			w/ Standard Liquid Tail	AMX55051	\$ 47.00
			w/ Short Low-Profile Tail	AMX55052	\$ 47.00
	Fits Universal Brackets	Replacement Dry Tail		AMX55015	\$ 40.00
		Replacement Short Low-Profile Tail		AMX55016	\$ 40.00
					









Planter & Grain Drill Parts

Closing Wheels and Components

Application	Description	Part Number	Retail Price
 7000, 7100 - Prior to 1997	Closing Wheel Assembly, 1" x 12" Made w/ plastic wheel halves, w/ stem bearing	AMAA43899	\$ 30.00
 7000 & 7100 MaxEmerge™ 1997 and Later, MaxEmerge™ Plus, Pro, XP, XP Pro	Closing Wheel Assembly, 1" x 12" Uses 5203KYY2 Bearing	AMAA39968	\$ 32.00
 1760, 1780, 7200 & 7300 MaxEmerge@2	Closing Wheel Assembly, 1" x 12" Replaces AA34211	AMAA43898	\$ 33.00
 (1760, 1780, 7200, 7300 - w/ MaxEmerge™ 2), (7000, 7100 - MaxEmerge™ 1997 and Later w/ Heavy Duty Cast Closing Wheel), (MaxEmerge@Plus, MaxEmerge™ XP, Pro and XP Pro - w/ Cast Closing Wheel)	Closing Wheel Bearing 0.669" ID, 1.574" OD	AMAA34132	\$ 3.50
 1760, 1780, 7200 & 7300 MaxEmerge™ 2	Closing Wheel Bearing For Early AMAA43898 Nylon Wheels	AMAA35638	\$ 15.95
 803, 805, 7000, 7100, 7200, 7300, 9200	Closing Wheel Tire, 1" x 12"	AMAA22325	\$ 7.50
 7200 & 7300 MaxEmerge™ 2	Covering Disc Assembly, 8" Includes bearing, hub and bolt for disc closing attachment	AMAA58321	\$ 28.00
 7000, 7100	Closing Wheel Arm	AMAA31217	\$ 36.00
 7000, 7100	Spiral Pins for Wheel Arm 1/4" x 1 1/4" Sold in Multiples of 50, Priced Individually	AMA26311	\$ 0.40
 1760, 1780, 7200, 7300 Planters and Attachments	Closing Wheel Arm	AMAA37552	\$ 49.00
 1760, 1780, 7200, 7300 Planters and Attachments	Nut, M16, Right Hand Nut, M16, Left Hand	AM14M7260 AM14M7382	\$ 1.30 \$ 2.10
 1760, 1780, 7200, 7300 Planters and Attachments	Cam Collar Bushing, Right Hand	AMA48430	\$ 4.00
 1760, 1780, 7200, 7300 Planters and Attachments	Washer, Left Hand 0.492" x 1.576" x 0.335"	AMA48290	\$ 2.00
 MaxEmerge@Plus, MaxEmerge™ XP, Pro and XP Pro	Closing Wheel Arm	AMA69141	\$ 50.00
 7000, 7100	Closing Wheel Arm Stop	AMA33879	\$ 21.50
 MaxEmerge@2 and MaxEmerge™ Plus w/ single closing wheel attachment	Closing Wheel Arm Stop, Cast Iron	AMA53118	\$ 26.95
 MaxEmerge™ Plus, Pro and XP	Closing Wheel Arm Stop, Cast Iron	AMA87426	\$ 29.00

Planter & Grain Drill Parts









Planter Parts for John Deere®

Application	Description	Part Number	Retail Price
 (1705, 1715, 1725, 1735, 1755, 1765, 1765NT, 1775, 1775NT, 1785, 1795 ASN 760101), 1725NT, 1760, 1780, 7200, 7300, (DB44, DB58, DB60, DB66, DB80, DB88, DB120, XP Pro ASN 710101), DB90, MaxEmerge™ XP	Closing Wheel Handle Replaces A54261, A64237	AMA86762	\$ 9.75
 1760, 1780, 7200, 7300	Non-Eccentric Bushing	AMA53242	\$ 3.25
 7200 & 7300 MaxEmerge™ 2	Eccentric Bushing	AMA51723	\$ 12.00
 MaxEmerge™ Plus, Pro and XP	Bushing For closing wheel arm (2) Required per row	AMAN131668	\$ 4.00
 1760, 1780, 7200, 7300	Dust Cap	AMA47217	\$ 2.25
 1700, (1705, 1715, 1725, 1735, 1755, 1765, 1765NT, 1775, 1775NT, 1785, 1795 ASN 760101), 1725NT, 1760, 1770NT, 1780, 1790, 7000, 7100, 7200, 7300, DB44, DB58, DB60, DN60T, DB80, (DB88, DR12, DR18, DR24 ASN 760101), DB90, DB120, DR8T Will not fit early MaxEmerge™ 2 w/ 9/16" hole and pivot stops or row units equipped w/ John Deere® stop sensors	Rocker For Walking Gauge Wheel	AMA62609	\$ 7.00
 (1705, 1715, 1725, 1735, 1755, 1765, 1765NT, 1775, 1775NT, 1785, 1795 ASN 760101), 1720, 1725NT, 1760, 1770NT, 1780, 1790, 7000, 7100, 7200, 7300, DB44, DB58, DB60, DB60T, DB66, (DB80, DR16 ASN 760101), DB90, DB120, DR8T, DR12, DR18, DR24 Will not fit early MaxEmerge™ 2 w/ 9/16" hole and pivot stops or row units equipped w/ John Deere® stop sensors	Pivot Bolt Use w/ AMA62609 Rocker	AMA58670	\$ 2.45
 1700 Series, DB37, DB37C, DB41, DB41C, DB44, DB50C, DB53, DB55, DB55C, DB58, DB60, DB60T, DB62, DB66, DB74, DB74C, DB80, DB83, DB88, DB90, DB120, DB1108, DB1110, DB1113, MaxEmerge™, MaxEmerge™ 2, MaxEmerge™ 5, MaxEmerge™ Plus, MaxEmerge™ Pro, MaxEmerge™ XP	Xtreme Cruiser Set of 2, Cast Spiked Closing Wheel 14 Tooth Includes Spacing Washers	AMX55063	\$ 280.00
 1700 Series, DB37, DB37C, DB41, DB41C, DB44, DB50C, DB53, DB55, DB55C, DB58, DB60, DB60T, DB62, DB66, DB74, DB74C, DB80, DB83, DB88, DB90, DB120, DB1108, DB1110, DB1113, MaxEmerge™, MaxEmerge™ 2, MaxEmerge™ 5, MaxEmerge™ Plus, MaxEmerge™ Pro, MaxEmerge™ XP	Furrow Cruiser Set of 2 For Planters w/ "V" Style Closing System	AMX55061	\$ 230.00
	Furrow Cruiser Set of 2 For Shallow Depth Planting, Vegetables, Sugar Beets and Cotton	AMX55066	\$ 260.00











Planter & Grain Drill Parts

Application	Description	Part Number	Retail Price
 1700 Series, DB37, DB37C, DB41, DB41C, DB44, DB50C, DB53, DB55, DB55C, DB58, DB60, DB60T, DB62, DB66, DB74, DB74C, DB80, DB83, DB88, DB90, DB120, DB1108, DB1110, DB1113, MaxEmergetm, MaxEmergetm 2, MaxEmergetm 5, MaxEmergetm Plus, MaxEmergetm Pro, MaxEmergetm XP	Furrow Cruiser Insert Set of 2 For Planters w/ "V" Style Closing System	AMX55062	\$ 140.00
	Furrow Cruiser Insert Set of 2 For Shallow Depth Planting, Vegetables, Sugar Beets and Cotton	AMX55068	\$ 140.00
7000, 7200, 7300	Furrow Cruiser Set of 2 Includes Bolt Kit For Planters w/ "V" Style Closing System	AMX55069	\$ 260.00

Row Unit Components

Application	Description	Part Number	Retail Price
1770NT (24 Row Retrofitted w/ MaxEmergetm 5e and Large Tires), 1775NT (w/ 24 Row, MaxEmergetm 5e, ExactEmergetm Original and Retrofitted or All w/ Large Tire Option)	Terrace King Pivot Set of 2	AMX55139	\$ 3680.00
 1700, 1760, 1780, 7200, 7300, MaxEmergetm XP	Parallel Arm, Upper 16" Standard Length (2) Required per Row	AMA76223	\$ 21.00
 1700, 1760, 1780, 7200, 7300, MaxEmergetm XP	Parallel Arm, Lower 16" Standard Length, 1-Piece Steel Casting	AMA52092	\$ 100.00
 1700, 1760, 1780, 7200, 7300, MaxEmergetm XP	Parallel Arm, Upper 23" Extended Length (2) Required per Row	AMA61571	\$ 31.00
 1700, 1760, 1780, 7200, 7300, MaxEmergetm XP	Parallel Arm, Lower 23" Extended Length, 1-Piece Steel Casting	AMA84382	\$ 150.00
 For front and rear upper parallel arms and front lower parallel arms on MaxEmergetm 2	Bushing 0.658" ID, 1.084" OD (6) Required for Upper and Lower Parallel Arms	AMA48515	\$ 1.75
 1720 CCS, 1770NT, 1790, DB44, DB50C, DB58, DB60, DB66, DB74, DB80, DB90, DR12, DR24, Pro, XP Pro	Angled Brush, Vacuum Meters	AMA69629	\$ 4.00
 1700, 1705, 1710, 1715, 1720, 1725, 1725NT, 1730, 1750, 1755, 1760, 1760NT, 1765, 1765NT, 1770NT, 1775, 1775NT, 1780, 1785, 7200, 7300, 9200, DB37, DB37C, DB41, DB44, DB50C, DB55, DB55C, DB58, DB60, DB60T, DB62, DB66, DB74, DB74C, DB83, DB88, DB90, DB120, XP, XP Pro	Straight Brush, Vacuum Meters	AMAA32868	\$ 3.50
 1720, 1770NT, 1790, DB44, DB50C, DB58, DB60, DB66, DB74, DB74C, DB80, DB90, DR12, DR18, DR24, XP, XP Pro	Cell Plate Brush, Vacuum Meters	AMA74214	\$ 5.00
7000 MaxEmergetm, 7100 MaxEmergetm	Seed Plate Adapter Fitting Replaces AA22897	AMAA27100	\$ 19.58

Planter & Grain Drill Parts









	Application	Description	Part Number	Retail Price
	1700, 1705, 1710, 1715, 1720, 1725, 1725NT, 1730, 1750, 1755, 1760, 1760NT, 1765, 1765NT, 1770NT, 1775, 1775NT, 1780, 1785, 7200, 7300, 9200 Series, DB37, DB37C, DB41, DB44, DB50C, DB55, DB55C, DB58, DB60, DB60T, DB62, DB66, DB74, DB74C, DB83, DB88, DB90, DB120, XP, XP Pro	Knocker, Seed Meters	AMAH129125	\$ 6.50
	1760, 1780, 700 & 7100 MaxEmerge™, 7200 & 7300 MaxEmerge™ 2, 9200 Series, MaxEmerge™ XP, Pro and XP Pro Replaces A22795	Seed Belt Drive Wheel For finger pickup mechanism	AMA76093	\$ 8.00
	7000, 7100	Corn Meter Belt	AMA67976	\$ 13.00
	MaxEmerge™, MaxEmerge™ 2 Prior to 1992	Idler Arm For seed drive chain tightener	AMA50564	\$ 5.75
	MaxEmerge™, MaxEmerge™ 2 Prior to 1992	Plastic Idler For Seed Drive, 1 9/16" Diameter	AMA22838	\$ 1.00
	MaxEmerge™	Plastic Idler For Drive Wheels, 2 1/4" Diameter	AMA22628	\$ 1.90
	MaxEmerge™	Plastic Idler For Seed Transmission, 1 7/8" Diameter	AMB30969	\$ 1.55
	1705, 1715, 1725, 1735, 1745, 1755, 1765, 1770, 1770NT, 1785, 1790, 1795, DB37, DB37C, DB41, DB44, DB50C, DB55, DB55C, DB74, DB74C, DB90, DB120, MaxEmerge™ Plus	Chamber, Vacuum Meter Dome	AMA94259	\$ 20.50
	1700, 1705, 1715, 1725, 1735, 1745, 1755, 1765, 1770NT, 1785, 1790, 1795, DB60, DB66, DB90, DB120, DB74, DB88, MaxEmerge™ Plus	Hub Kit, Vacuum Meter	AMAA89297	\$ 31.00
	1700, (1705, 1715, 1725, 1735, 1755, 1765, 1765NT, 1775, 1775NT, 1785, 1795 ASN 760101), 1710, 1720, 1730, 1750, 1760, 1760NT, 1770, 1770NT, 1780, 1790, 7000, 7200, 7240, 7300, 7340, DB37, DB37C, DB41, DB41C, DB44, DB50C, DB53, DB55, DB55C, DB58, DB60, DB60T, DB62, DB66, DB74, DB74C, DB80, DB83, DB88 ASN 755001, DB90, DB120, DR8T, DR12, DR16, DR18, DR24	Idler Sprocket 14 Tooth, 1/2" Bore For Size 40 Chain	AMAA32729	\$ 20.00
	1700, (1705, 1715, 1735, 1755, 1775NT, 1795 ASN 760101), 1710, 1720, 1730, 1750, 1770, 1770NT, 7000, 7200, 7300, 7340, (DB44, DB58, DB60, DB66, DB80, DB88, DB90, DB120 ASN 755001)	Idler Sprocket 12 Tooth, 1/2" Bore For Size 50 Chain	AMAA32776	\$ 15.00
	7000, 7100, MaxEmerge™	Sprocket, Hopper Drive 11 & 19 Tooth	AMAA27146	\$ 18.00
	MaxEmerge™ 2, Plus and XP	Plastic Idler Sprocket, 10 Tooth For seed drive on vacuum and finger pickup units and herbicide/insecticide drive	AMA55008	\$ 1.15

Planter Parts for John Deere®

Planter & Grain Drill Parts

	Application	Description	Part Number	Retail Price
	(1705, 1715, 1735, 1755, 1765, 1765NT, 1775, 1775NT, 1785 ASN 760101), 1750, 1770, 1780, 7200, 7240, 7300, (DB44, DB60, DB66, DB80 ASN 755001), (DB58, DB88, DB90 ASN 760101)	Bearing w/ Sprocket 2 1/8" Wide, 19 Tooth	AMAA36212	\$ 18.25
	(1715, 1735, 1775, 1785 ASN 760101), 1730, 1770, 1780, 7200, DB44, DB53, DB55C, DB58, DB60, DB66, DB74, DB80, DB83, DB88 ASN 760101, DB90, DB120	Bearing w/ Sprocket 1 1/2" Wide, 19 Tooth	AMAH133868	\$ 18.25
	MaxEmerge™, MaxEmerge™ 2, MaxEmerge™ Plus	Drag Chain Kit Includes mounting brackets and twisted link chain	AMX55011	\$ 80.00
	7000, 7100	Closing Wheel Spring w/ Plug	AMAA23116	\$ 11.00
	7200, 7300, 7340	Closing Wheel Spring	AMA74643	\$ 8.75
	7000, 7100	Down Pressure Spring w/ Plug 6 1/8" Overall Length, 1 7/16" OD, 4 1/2" Spring Length	AMAB10071	\$ 7.50
	7000, 7100	Down Pressure Spring w/ Plug, HD 6 7/8" Overall Length, 1 1/4" OD, 4 3/8" Spring Length	AMAA35876	\$ 11.75
	7200, 7300	Down Pressure Spring Standard Style	AMA43609	\$ 8.50
	1700 Twin Row, 1720, 1770 24 Row, 1775, 1790 BSN 740101	Pneumatic Air Spring	AMAA71437	\$ 83.00
	1700, 1710, 1720, 1730, 1750, 1760, 1760NT, 1770, 1770NT, 1780, 1790, 1795 ASN 760101, DB44, DB58, DB60, DB66, DB80, DB90	Pneumatic Air Spring	AMAA73942	\$ 80.00
	1760, 1780, 7200 & 7300 MaxEmerge™ 2, MaxEmerge™ Plus	Pneumatic Air Spring For units that require (2) springs per row	AMAA40969	\$ 100.00
	1700, 1700TR, 1705, 1710, 1720, 1725, 1730, 1745, 1750, 1755, 1760, 1765, 1770, 1770NT, 1775NT, 1780, 1790, DB37, DB41, DB41C, DB44, DB50C, DB55C, DB60, DB60T, DB66, DB74, DB74C, DB80, DB83, DB88, DB90, DB120	Wheel Speed Sensor	AMAA54557	\$ 390.00
	1705, 1715, 1720, 1725, 1735, 1755, 1765, 1765NT, 1770NT, 1775, 1775NT, 1790, 1795, 1830, 1835, 1840, 1870, 1910, DB37, DB37C, DB41, DB41C, DB44, DB50C, DB55, DB55C, DB60, DB60T, DB62, DB66, DB74, DB74C, DB80, DB83, DB88, DB90, DB120	Potentiometer Sensor	AMRE261354	\$ 100.00
	1560, 1565	Fan Speed Actuator Plug under Motor Replaces AA77820	AMAH143903	\$ 60.00
	1790, 1795 ASN 760101	Pneumatic Air Spring	AMAA49827	\$ 102.00
	7200, 7300	Down Pressure Spring Eyebolt Use w/ AMA43609 Down Pressure Spring	AMA39073	\$ 8.00
	1710, 1770, 1780, 7200 & 7300 MaxEmerge™ 2 Planters, Row Units and Drivelines	Bearing w/ Sprocket 19 Tooth, 7/8" Hex Bore, 2 1/2" Wide, 0.908" ID	AMAA35645	\$ 18.00

Planter & Grain Drill Parts

Application	Description	Part Number	Retail Price
 1780, 7240, DB74	Ball Bearing 1.251" ID, 2.835" OD	AMJD9420	\$ 28.09
 MaxEmerge™, MaxEmerge™ 2 and MaxEmerge™ Plus Seed and Fertilizer Transmissions and Drivelines	Bearing 7/8" Hex Bore, Curved Outer Race	AMAA22097	\$ 9.00
 Used on Wheel Frame, Seed and Fertilizer Transmissions	Bearing 7/8" Hex Bore, Flat Outer Race	AMAA28271	\$ 10.00
 7200 Flex-Fold Seed Driveline, 7300 Vertical Fold, 1710, 1760, 1760NT, 1780	Bearing w/ Riveted Flange 7/8" Hex Bore	AMAA35646	\$ 11.50
 7000 Flex-Fold Seed Driveline, 7200 and 1750 Clutch Actuator Shaft	Bearing w/ Riveted Flange 9/16" Hex Bore	AMAA34259	\$ 10.50
 1750, 1770, 7200	Bearing w/ Locking Collar For Clutch Assembly (2) Required	AMJD8562	\$ 9.75
 1700, (1705, 1715, 1725, 1735, 1755, 1765, 1765NT, 1775, 1775NT, 1785 ASN 760101), 1710, 1720, 1725NT, 1730, (7200, 7240, 7300 - 1990 and Later), 1750, 1760, 1770, 1780, 7000, 7100, (DB44, DB60, DB66, DB80, DB88, DB120 ASN 755001), (DB58, DR12, DR16, DR18, DR24 ASN 760101), DB90	Bearing, Marker Disc 0.904" Wide, 1.181" ID, 2.165" OD For Row Cleaner Attachment Replaces AA38601	AMAA34616	\$ 19.00
 MaxEmerge™ 2 and MaxEmerge™ Plus Herbicide/Insecticide	Tension Spring	AMA49644	\$ 2.50
 MaxEmerge™ Seed Meter Drive Excluding Push Units, MaxEmerge™ 2 and Plus (Both Vacuum and Finger Pickup) Replaces A63534	Tension Spring	AMA28518	\$ 2.00
1700, (1705, 1715, 1725, 1735, 1755, 1765, 1765NT, 1775, 1775NT, 1785 ASN 760101), 1710, 1720, 1730, 1750, 1760, 1760NT, 1770, 1770NT, 1780, 7000, 7200, 7240, 7300, 7340, DB37, DB37C, DB41, DB41C, (DB44, DB58, DB66, DB88, DB90 ASN 760101), DB53, DB55, DB55C, DB60, DB62, DB74, DB80, DB83, DB120	Rubber Spacer	AMA43610	\$ 4.75
DB50C, DB74, DB74C, DB90	Wiring Harness Replaces AKK22626	AMAA79093	\$ 75.00

Fertilizer Shoes

Application	Description	Part Number	Retail Price
1750, 1770, 1780, 7200, 7240	Fertilizer Shoe, Right Hand	AMA52150	\$ 55.00
	Fertilizer Shoe, Left Hand	AMA52149	\$ 55.00

Planter & Grain Drill Parts

Replacement Chains for Planters with MaxEmerge™ 2 and MaxEmerge™ Plus Row Units

Seed Meter Chains for MaxEmerge™ 2 and MaxEmerge™ Plus:

Part Number	Application	Description	Retail Price	
AMAA33060		With vacuum meter and standard parallel arms, also fits MaxEmerge™ XP	Chain, 112 link, Includes connector link	\$ 10.00
AMAA43718		MaxEmerge™ 2 with vacuum meter herbicide/insecticide chain after 1992, MaxEmerge™ Plus and XP with vacuum meter herbicide/insecticide chain	Chain, 113 links Includes connector link	\$ 8.00
AMAA43720		With vacuum meter seed meter chain for units with long parallel arms, also fits MaxEmerge®XP	Chain, 140 links Includes connector link	\$ 13.00

Herbicide/Insecticide Chains for MaxEmerge™ 2 Prior to 1992:

Part Number	Application	Description	Retail Price	
AMAA33048		With plate meter seed meter chain & vacuum meter herbicide/insecticide chain prior to 1992	Chain, 104 link Includes connector link	\$ 7.00

Herbicide/Insecticide Chains for MaxEmerge™ 2 1992 and Later; all MaxEmerge™ Plus:

Part Number	Application	Description	Retail Price	
AMAA20978		With seed meter chain	Chain, 98 links Includes connector link	\$ 10.00
AMAA43719		With finger pickup meter herbicide/insecticide chain on units after 1992, also MaxEmerge® herbicide/insecticide chain	Chain, 110 links Includes connector link	\$ 9.00
AMAA42795		MaxEmerge™ 2 w/ finger pickup meter on units prior to 1992 and w/ plate meter herbicide/insecticide chain after 1992, MaxEmerge0153 Plus and XP w/ finger meter	Chain, 102 links Includes connector link	\$ 8.00

Seed Transmission Chains for:

Part Number	Application	Description	Retail Price	
AMAA37980	1750, 1755 ASN 760101, 7200	Chain, 112 Links Includes connector and offset link For Wheel Drive	\$ 18.00	
AMAA32249		1700, 1710, 1720, (1750, 7200 - w/ 7" x 7" frame), (1770 12-row wide, 16 and 24-row narrow), 7300	Chain, 105 links Includes connector link	\$ 12.00
AMAA32250		1700, 1710, 1720, (1750, 7200 - w/ 7" x 7" frame), 1760, 1770, 7300	Chain, 86 links Includes connector link	\$ 9.00
AMAA35365		1780, 7240	Chain, 104 links Includes connector link	\$ 9.00
AMAA35503	1780, 7240	Chain, 128 links Includes connector link	\$ 12.00	
AMAA32257	1730 w/ 15" spacing, (1760, 1770 - Main drive wheel 12-row narrow w/o one-half width disconnect), 7340	Chain, 93 links Includes connector link	\$ 20.00	

Planter & Grain Drill Parts

Planter Parts for John Deere®

Seed Transmission Chains for:

Part Number	Application	Description	Retail Price
AMAA21484	MaxEmerge®	Chain, 38 links Includes connector link	\$ 6.00
AMAA21483	MaxEmerge®	Chain, 44 links Includes connector link	\$ 7.00



Main Wheel Drive Chains for:

Part Number	Application	Description	Retail Price
AMAA35927	1770	Chain, 59 Links Includes connector link For Jackshaft Drive	\$ 6.95
AMAA37881	7000 4-row narrow and wide, 6-row narrow	Chain, 53 links Includes connector link	\$ 18.00
AMAA22372	7000 rigid 6-row wide, 8-row narrow and wide, 12-row narrow, 7100 built before 1979	Chain, Type 2050, 56 links Includes connector link	\$ 14.00
AMAA28486	All 7100 built after 1979	Chain, 50 links Includes connector link	\$ 13.00
AMAA32887	1770, 7200 12-row wide, 16 and 24-row narrow	Chain, 140 links Includes connector link	\$ 21.00



Grain Drill and Air Seeder Parts for John Deere®

















Grain Drill and Air Seeder Parts for John Deere®

Seeder Blades and Components



Application	Description	Part Number	Retail Price
750, 1560, 1590, 1690, 1850, 1860, 1890, 1895, 1990	Flat Seeder Blade, 18"	AMN283804	\$ 28.50
1560, 1590, 1690, 1860, 1890, 1895, 1990	Hub Assembly Includes Bearing and Snap Ring	AMAN281856	\$ 34.00
450, 455, 515, 520, 730, 8000, 8100, 8300, 8350, 8500, 9400, 9450	Drill Disc Blade, 13.50" Has Raised Center for Aluminum Boot	AMN283805	\$ 19.27
450, 455, 515, 520, 730, 730LL, 740A, 1520, 9100, DB1108, DB1110, DB1113	Foam Seal For Grain Drill Bearing	AMN280975	\$ 1.95
750A, 1560, 1565, 1590, 1690, 1860, 1890, 1895	Disc Opener Bearing 1.457" Wide, 2.362" OD, 1.181" Bore Diameter Replaces AN281242, AN281521	AMAN281813	\$ 30.15
750A, 1560, 1565, 1590, 1690, 1835, 1860, 1890, 1895, 1990	Hub Seal, Rear 3 11/16" OD	AMAN281241	\$ 6.75
750, 1850	Hub w/ Cups For Seeder Blade Assembly	AMAN213544	\$ 37.50
750A, 1560, 1565, 1590, 1690, 1835, 1860, 1890, 1895, 1990	Spindle, Right Hand	AMAN282118	\$ 27.95
	Spindle, Left Hand	AMAN282119	\$ 27.95

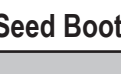







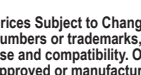







Planter & Grain Drill Parts

Application	Description	Part Number	Retail Price
 750, 1850	Bearing Kit Includes Inner Cups, Outer Cups, Cones, Seals and Retainers	AMAA44267	\$ 30.50
 450, 515, 520, 530, 8000, 8500, 9000	Bearing 2.047" OD	AMA27002	\$ 6.00
 1530, 1535	Tungsten Seed Opener Scraper	AMAA62559	\$ 20.50
 750, 1850	Opener Spindle	AMAN280725	\$ 60.00
 Air Seeders: 750, 1850	Gauge Wheel Arm Replaces AN211440	AMAN282374	\$ 28.00
 1525, 1530, 1535 Replaces AA37474	Seed Disc Opener Assembly, 15" x 3.50 mm w/ 5/8" ID hole	AMAA53860	\$ 28.85
 1530, 1535 - w/ XP	Seed Disc Opener Assembly, 15" x 3 mm	AMAA55927	\$ 25.50
 1530, 1535 - w/ XP	Seed Disc Opener Assembly, 15" x 3.50 mm, HD	AMAA65248	\$ 31.00
 1525, 1530	Metal Dust Cap For Fertilizer Disc Opener Assembly	AMA22836	\$ 1.06
 1530, 1535	Rotating Disc Scraper Kit w/ Nylon Covers Includes (2) AMAA37221 Wheels, (1) AMA50047 Spring, (1) AMA69140 Right Hand Arm and (1) AMA69139 Left Hand Arm	AMX55006	\$ 17.25
 1530, 1535	Rotating Disc Scraper Kit w/ All Metal Wheels Includes (2) AMAA37221M Wheels, (1) AMA50047 Spring, (1) AMA69140 Right Hand Arm and (1) AMA69139 Left Hand Arm	AMX55007	\$ 17.25
 1530, 1535	Rotating Disc Scraper Wheel w/ Nylon Cover	AMAA37221	\$ 6.50
 1530, 1535	Rotating Disc Scraper Wheel, All Metal	AMAA37221M	\$ 6.50
 1530, 1535	Spring For Rotating Disc Scraper Kits	AMA50047	\$ 2.85
 1530, 1535	Scraper Arm, Right Hand	AMA69140	\$ 3.50
 1530, 1535	Scraper Arm, Left Hand	AMA69139	\$ 3.50
 1560, 1565, 1590, 1690, 1835, 1860, 1890, 1895, 1990	Gauge Wheel Arm and Shaft Replaces AN282117	AMAA73951	\$ 35.00

Seed Boots and Components

Application	Description	Part Number	Retail Price
 750, 1850	Seed Boot Replaces N217160, N219632	Right Hand AMN280446	\$ 27.00
 750, 1850	Seed Boot Replaces N217161, N219633	Left Hand AMN280447	\$ 27.00
 750, 1590, 1690, 1850, 1890, 1895, 1990	Seed Boot Strap	AMN219982	\$ 1.45



Planter & Grain Drill Parts

Application	Description	Part Number	Retail Price		
	1560, 1565, 1860	Right Hand	AMN282788	\$ 27.00	
		Left Hand	AMN282789	\$ 27.00	
		Seed Boot, Lower	Right Hand	AMN283432	\$ 27.00
			Left Hand	AMN283433	\$ 27.00
	1590, 1690, 1890, 1895	Right Hand	AMN284044	\$ 32.00	
		Left Hand	AMN284045	\$ 32.00	
	1590, 1690, 1890, 1895, 1990	Right Hand	AMN284024	\$ 65.00	
		Left Hand	AMN284025	\$ 65.00	
	750, 1560, 1565, 1590, 1690, 1820, 1850, 1860, 1890, 1895, 1990	Pivot Pin for Opener Arm Replaces N280486	AMN282536	\$ 20.00	
	750, 1560, 1565, 1590, 1690, 1850, 1860, 1890, 1895, 1990	Row Unit Bushing	AMN219547	\$ 3.50	
	750, 1560, 1565, 1590, 1690, 1850, 1860, 1890, 1895, 1990, Cultivators: 980, 2210, Mulch Finisher: 726	Row Unit Bushing	AMN280648	\$ 6.00	
	750, 1560, 1565, 1590, 1690, 1850, 1860, 1890, 1895, 1990, Cultivators: 980, 2210, Mulch Finisher: 726	Row Unit Bushing	AMN284086	\$ 9.25	
	750, 1590, 1690, 1850, 1890, 1895, 1990	Row Unit Bushing Replaces N218646, N216540	AMN283636	\$ 7.00	
	1530, 1535	Stem Bearing Bushing Use w/ AMAN131668 Stem Bearing or AMAA35741 Stem Bearing w/ Hole	AMA25915	\$ 1.60	
	1560, 1565, 1590, 1690, 1860, 1890, 1985, 1990	Right Hand	AMN283994	\$ 8.25	
		Left Hand	AMN283995	\$ 8.25	
	1530, 1535	Guard-Scraper (Cast Frog)	AMA61577	\$ 6.25	
	1530, 1535	Guard-Scraper	AMA80203	\$ 5.00	
	750, 1560, 1565, 1590, 1690, 1850, 1860, 1890, 1895, 1990	Leaf Tension Spring	AMN284055	\$ 3.75	
	1530, 1535	Seed Sensor XP, Red LED, AccuCount™	AMAA61909	\$ 115.00	







Grain Drill and Air Seeder Parts for John Deere®

Planter & Grain Drill Parts

Keeton® Seed Firmers















Application	Description	Part Number	Retail Price
 1530, 1535 Keeton® Seed Firmer Seed Tube Mount	w/ Standard Dry Tail	AMX55018	\$ 44.00
	w/ Standard Liquid Tail	AMX55019	\$ 45.00
 1530, 1535 Keeton® Seed Firmer Universal Bracket	w/ Standard Dry Tail	AMX55050	\$ 44.00
	w/ Standard Liquid Tail	AMX55051	\$ 40.00
	w/ Short Low-Profile Tail	AMX55052	\$ 45.00
 Fits Universal Brackets Replacement Dry Tail		AMX55015	\$ 40.00
	Replacement Short Low-Profile Tail	AMX55016	\$ 40.00

Gauge and Packer Wheels

Application	Description	Part Number	Retail Price
 1560, 1565, 1690, 1850, 1860, 1890, 1990 Replaces A84050	Gauge Wheel Tire, 4.50" x 16" Carlisle®	AMA22884	\$ 40.00
	Gauge Wheel Tire, 4.50" x 16" Solid Urethane	AMA22884U	\$ 85.00
 1530, 1535 - w/ XP	Gauge Wheel Tire, 4.50" x 16" Carlisle®, w/ Standard Profile Offset	AMA84062	\$ 40.00
 750, 1560, 1565, 1590, 1690, 1835, 1850, 1860, 1890, 1895	Gauge Wheel Assembly, 4.50" x 16" w/ AMAN212132 bearing	AMAA66604	\$ 80.00
	Gauge Wheel Assembly, 4.50" x 16" Solid Urethane Tire	AMAA66604U	\$ 120.00
 750, 1560, 1590, 1690, 1850, 1860, 1890, 1895, 1990	Gauge Wheel Tire, 3" x 16" Carlisle®	AMA85133	\$ 40.00
	Gauge Wheel Tire, 3" x 16" Solid Urethane, Extended Wear Replaces A75374, A84349	AMA85133U	\$ 75.00
 750, 1560, 1590, 1690, 1850, 1860, 1890, 1895, 1990 Replaces AA56719	Gauge Wheel Assembly, Narrow 3" x 16"	AMAA66988	\$ 80.00
	Gauge Wheel Assembly, Narrow 3" x 16" Solid Urethane Tire	AMAA66988U	\$ 120.00
 750, 1590, 1835, 1850	Gauge Wheel Assembly, Narrow 3" x 16" Solid Urethane	AMX55058	\$ 85.00
 750, 1850	Gauge Wheel Assembly, 4.50" x 16" Yellow Steel Wheel Halves, JD Style Chined Tire	AMAN211864	\$ 80.00
	Gauge Wheel Assembly, 4.50" x 16" Urethane Tire	AMAN211864U	\$ 120.00



















Grain Drill and Air Seeder Parts for John Deere®

Planter & Grain Drill Parts



	Application	Description	Part Number	Retail Price
	1530, 1535	Gauge Wheel Assembly, 4.50" x 16" w/ AMAN131668 bearing Mount using Set Screws	AMAA41359	\$ 80.00
		Gauge Wheel Assembly Solid Urethane	AMAA41359U	\$ 120.00
	1530, 1535, 1560, 1565, 1590, 1690, 1860, 1890, 1895, 1990	Gauge Wheel Assembly, 4.50" x 16" Carlisle®, Spoked Replaces AA86055, AA98187	AMX55039	\$ 145.00
		Gauge Wheel Assembly, 3" x 16" Carlisle®, Spoked Replaces AA85465, AA98188	AMX55041	\$ 135.00
	730, 735, 737, 770, 1690, 1810, 1820, 1840, 1890, 1895, 1990	Hub Assembly, 6-Bolt Replaces AN150825	AMAN183318	\$ 82.39
	750, 1850	Wheel Half, Steel Painted Yellow (2) Required	AMA22780	\$ 11.00
	1530, 1535, 1560, 1566, 1690, 1860, 1890, 1895, 1990	Wheel Half, Steel Painted Black (2) Required	AMA77880	\$ 20.00
	1530, 1535, 1560, 1565, 1590, 1690, 1860, 1890, 1895, 1990, 2100, Row Crop Cultivator: 856	Wheel Half, Plastic 8-Bolt	AMA56565	\$ 16.50
	750, 1560, 1590, 1690, 1850, 1860, 1890, 1895, 1990 Replaces A75375	Rim, Plastic	AMA85134	\$ 16.50
	750, 1560, 1590, 1690, 1850, 1860, 1890, 1895, 1990 Replaces A56621	Rim, Steel	AMA85104	\$ 16.50
	750, 1530 & 1535 w/ XP, 1850	Double Row Ball-Bearing, 40 mm For 4" x 16" wheel assemblies	AMAN212132	\$ 7.50
	1530, 1535 - w/ MaxEmerge™ Plus Replaces AA49161	Bearing w/ Sleeve Stem Type	AMAA38106	\$ 9.50
	1530, 1535 - w/ MaxEmerge™ Plus	Bearing Stem Type	AMAN131668	\$ 11.15
	1530 & 1535 w/ XP Row Unit	Gauge Wheel Arm Kit Includes Arm, Threaded Bushing w/ 5/8" Hole, (2) Bolts and (3) Washers Replaces A79648	AMA92817	\$ 23.00
	1530, 1535 Replaces A22572, A41968, A79647	Gauge Wheel Arm Kit Includes (2) Bushings For wheel that uses cross-drilled stem bearing	AMA54179	\$ 40.00
	1530, 1535	Self-Aligning Bushing Use w/ AMA54179	AMA57058	\$ 11.00
	1530, 1535	Gauge Wheel Arm Bushing, Self-Aligning 5/8" Bolt Hole Diameter	AMA92818	\$ 8.50
	750, 1500, 1600, 1800 Series	Packer Wheel, 1" x 10" 5/8" ID Replaces AN281359	AMAA38447	\$ 25.00
	450, 455, 515, 520, 730, 750, 1520, 1530, 1535	Closing Wheel Tire, 1" x 12"	AMAA22325	\$ 7.50
	455, 730, 730LL, 735, 740A, 1520, 1810	Closing Wheel Assembly, 2" x 13" Replaces AN162400, AN280591	AMAN281598	\$ 65.00

Grain Drill and Air Seeder Parts for John Deere®









Planter & Grain Drill Parts

	Application	Description	Part Number	Retail Price
	515, 520	Closing Wheel Assembly, 1" x 12" Made w/ plastic wheel halves, w/ stem bearing	AMAA43899	\$ 30.00
	515, 520, Row Crop Cultivator: 886	Closing Wheel Assembly, 1" x 12" Replaces AA34211	AMAA43898	\$ 33.00
	1530, 1535	Closing Wheel Assembly, 1" x 12" Uses 5203KYY2 Bearing	AMAA39968	\$ 32.00
	750A, 1560, 1565, 1590, 1690, 1860, 1890, 1895, 1990	Closing Wheel, Cast Iron	AMN282110	\$ 38.00
	1590, 1835 BSN 780101, 1890, 1895, 1990	Closing Wheel Arm, Right Hand	AMAN282190	\$ 270.00
		Closing Wheel Arm, Left Hand	AMAN282191	\$ 258.00
	750 ASN 6501, 1850	Closing Wheel Update Kit, Right Hand Includes Closing Wheel Arm, Heavy Duty Bearing, and Mounting Hardware	AMX55059	\$ 95.00
		Closing Wheel Update Kit, Left Hand Includes Closing Wheel Arm, Heavy Duty Bearing and Mounting Hardware	AMX55060	\$ 95.00
	1530, 1535	Closing Wheel Arm	AMA69141	\$ 50.00
	1530, 1535	Closing Wheel Arm Stop, Cast Iron	AMA87426	\$ 29.00
	1530, 1535	Closing Wheel Handle Replaces A54261, A64237	AMA86762	\$ 9.75
	455, 750, 750A, 1535, 1560, 1565, 1590, 1690, 1835, 1850, 1860, 1890, 1895	Dust Cap	AMA47217	\$ 2.25
	750, 1520, 1530, 1535, 1560, 1565, 1590, 1690, 1860, 1890, 1895, 1990	Bearing Use w/ AMAA38447 Wheel Assembly	AMAN281357	\$ 3.25
	455 ASN 1568, 1535 w/ Heavy Duty Cast Closing Wheel	Closing Wheel Bearing 0.669" ID, 1.574" OD	AMAA34132	\$ 3.50
	515, 520, Row Crop Cultivator: 886	Closing Wheel Bearing	AMAA35638	\$ 15.95
		For Early AMAA43898 Nylon Wheels		
	1530, 1535	Bushing For closing wheel arm (2) Required per row	AMA55888	\$ 4.00
	1560, 1590, 1690, 1860, 1890, 1895, 1990	Press Wheel Spring, Left Hand	AMN282219	\$ 14.00
		Press Wheel Spring, Right Hand	AMN282218	\$ 14.00
	740A, 750, 750A, 1850	Torsion Spring, Right Hand For Press and Closing Wheels	AMN214510	\$ 11.75
	750, 1850	Torsion Spring, Left Hand For Press and Closing Wheels	AMN214511	\$ 11.75
	750, 1850	Spindle, Right Hand	AMN280564	\$ 28.00
		Spindle, Left Hand	AMN280565	\$ 28.00

Planter & Grain Drill Parts

	Application	Description	Part Number	Retail Price
	1530, 1535	Rocker For Walking Gauge Wheel	AMA62609	\$ 7.00
	1530, 1535	Pivot Bolt Use w/ AMA62609 Rocker	AMA58670	\$ 2.45
	1560, 1590, 1835, 1860, 1890, 1895, 1990	Depth Control Handle	AMN282710	\$ 17.50
	1560, 1590, 1835, 1860, 1890, 1895, 1990	Depth Control Cover	AMN283120	\$ 12.00
	Grain Drills and Air Seeders w/ Fertilizer Attachment	SFP Cruiser Anhydrous Closing Wheel Sold Individually	AMX55065	\$ 108.00
	1560, 1590, 1690, 1860, 1890, 1895, 1990	Drill Cruiser Set of 2	AMX55064	\$ 87.00

Row Unit Components

	Application	Description	Part Number	Retail Price
	1530, 1535 Replaces A22795	Seed Belt Drive Wheel For finger pickup mechanism	AMA76093	\$ 8.00
	730LL, 1690, 1820, 1830, 1835, 1860, 1870, 1890, 1895	Air Seeder Hose, Tank-to-Tower 100' Long, 2.50" ID Runs from tank to tower manifold, Clear hose w/ black spiral braid reinforcement, Smooth outside and inside covers	AMAA54447	\$ 394.01
	1790, (1720 CCS, 1775 ASN 760101), 1770NT, DB41, DB41C, (DB44, DB66, DB80, DB90 ASN 755001), DB50C, (DB58, DB88 ASN 760101), DB60, DB62, DB74C, DB83, DR12, DR16, DR18, DR24, Pro, XP Pro ASN 710101	Seed Delivery Hose 100' Long, 1.25" ID, 1.53" OD	AMA94642	\$ 156.57
	730LL, 1690, 1820, 1830, 1835, 1840, 1860, 1890, 1990CCS	Seed Delivery Hose 100' Long, 1" ID, 1.24" OD	AMAA54445	\$ 147.39
	450, 750 Series, 1530, 1560, 1565, 1590, 8000, 8100, 8200, 8250, 8300, 8350, 8500, 9000	Seed Tube Hose Replaces M61104	AMN407659	\$ 6.48
	1530, 1535	Pneumatic Air Spring For units that require (2) springs per row	AMAA40969	\$ 100.00
	730, 730LL, 1890, 1895, Air Seeder: 1810	Potentiometer Sensor	AMRE261354	\$ 100.00
	750, 1520, 1530, 1535, 1560, 1565, 1590, 1990	Idle Sprocket 14 Tooth, 1/2" Bore For Size 40 Chain	AMAA32729	\$ 20.00
	780, 785	Bearing w/ Locking Collar For Clutch Assembly (2) Required	AMJD8562	\$ 9.75

Grain Drill and Air Seeder Parts for John Deere®









Planter & Grain Drill Parts

Application	Description	Part Number	Retail Price
 1530, 1535	Bearing w/ Sprocket 19 Tooth, 7/8" Hex Bore, 2 1/2" Wide, 0.908" ID	AMAA35645	\$ 18.00
1520, 1535, 1990	Rubber Spacer	AMA43610	\$ 4.75

Recappers





Application	Description	Part Number	Retail Price
 9400 Split Wheel	Recapper, 3" x 26" Wheel Width (2) Required	AMX55009	\$ 12.50

Air System Parts

Application	Description	Part Number	Retail Price
 1690, 1820, 1830, 1835, 1840, 1860, 1870, 1890, 1895, N530F, N540F, N543F, P540, P556	Air Hose Coupling Kit Includes (2) 2 Port Reversible Couplers for 2 1/2" Tubes	AMX55083	\$ 281.87
 1690, 1820, 1830, 1835, 1840, 1860, 1870, 1890, 1895, N530F, N540F, N543F, P540, P556	Air Hose Coupling, Cart Side (2) Port Reversible Coupler for 2 1/2" Tubes	AMX55085	\$ 128.01
 1690, 1820, 1830, 1835, 1840, 1860, 1870, 1890, 1895, N530F, N540F, N543F, P540, P556	Air Hose Coupling, Applicator Side (2) Port Reversible Coupler for 2 1/2" Tubes	AMX55084	\$ 153.86
 (1690, 1820, 1835, 1860, N530F, N540F, N543F - Tow-Between), 1830, 1840, 1870 (40' Tow-Behind), (1890 Tow-Between 3 Section Drills BSN 775101 or All 5 Section Drills), (1895 Tow-Between 3 Section Drills), P540, P556	Air Hose Coupling, Cart Side 2 Port Coupler for 2 1/2" Tubes Replaces A60698, AA49380, AA65241, AA67121	AMAA67121	\$ 128.01
 1690, 1820, 1860, 1890 3 Section and 5 Section BSN 775101, N530F, N540F, N543F - All w/ Quick Connect Hose	Seed Delivery Straight Tube 48.58" Long, 4" Diameter For Stationary Single Shoot and Upper Tube for Double Shoot Manifold	AMA59345	\$ 85.00
 1690, 1830, 1835, 1870 (40' & 56' Drills), P540, P556, (1820, 1840 Tow-Between), 1860, 1890 (3 Section Drills Tow-Between BSN 775101, All Tow-Behind, or All 5 Section Drills), 1895 (3 Section Drill), N530F, N540F, N543F	Air Hose Coupling, Applicator Side (2) Port Coupler for 2 1/2" Tubes Replaces A65280, A82371	AMA82371	\$ 134.41
 (1690, 1860, N530F, N540F, N543F - Tow-Between), 1820, 1830, 1835, 1840, 1870 (40' & 56' Drills), (1890 Tow-Between 3 Section Drills BSN 775101 or All 5 Section Drills), (1895 Tow-Between 3 Section Drills), P540, P556	Air Hose Coupling Kit Includes (2) 2 Port Couplers for 2 1/2" Tubes Replaces A60698, A65280, A82371, AA49380, AA65241, AA67121	AMX55127	\$ 251.00
 1830, 1835, 1840, 1860, 1870, 1890, 1895, N530F, N540F, N543F, N560F, P540, P556, P576	Distributor Wear Cap Stainless Steel Extends Life of Distributor Covers Fits in John Deere® Cover AA73954	AMX55092	\$ 24.77

Planter & Grain Drill Parts





Grain Drill and Air Seeder Parts for John Deere®

	Application	Description	Part Number	Retail Price
	(1830, 1835 ASN 740100), 1840, 1870 40' and 56' ASN 740100 or All 76', 1890 3 Section ASN 740100 or All 5 Section, 1895 3 Section Double Shoot ASN 740100 or All 5 Section, P540, P556, P576, N530F, N540F, N543F, N560F	Manifold Tube Use w/ Stationary Single Shoot or Double Shoot Manifold For New Style Tower Replaces A89483	AMAA76331	\$ 180.00
	1830, 1870, 1890, 1895, N540F, N543F, N560F, P556, P576	Air Hose Coupling Kit Includes (2) 2 Port Reversible Couplers for 3" Tubes	AMX55086	\$ 308.59
	1830, 1870 (56' & 76' Drills), 1890 (5 Section), 1895 (3 Section 43' and All 5 Section), N540F Tow-Behind, N543F, N560, P556, P576	Air Hose Coupling, Applicator Side (2) Port Coupler for 3" Tubes	AMA102339	\$ 162.29
	1830 Tow-Behind, 1870 (56' & 76' Drills), 1890 (5 Section Tow-Between), 1895 (3 Section 43' or All 5 Section), N543F, N560F, 556, P576	Air Hose Coupling, Cart Side (2) Port Coupler for 3" Tubes	AMAA87296	\$ 136.36
	1830 Tow-Behind, 1870 (56' & 76' Drills), 1890 (5 Section Tow-Between), 1895 (3 Section 43' or All 5 Section), N543F, N560F, P556, P576	Air Hose Coupling Kit Includes (2) 2 Port Coupler for 3" Tubes Replaces A102339, AA87296	AMX55124	\$ 281.77

Planter Parts for Kinze® and White®

Planter Parts for Kinze® and White®











Opener Disc and Assemblies

	Application	Description	Part Number	Retail Price
	Kinze® 3000, 3400, 3110, 3120, 3140, 3200, 3400, 3500, 3600, 3600TR, 3600V, 3650, 3660, 3700, 3700 SDS, 3800, 3800 SDS, 4900 2013 and Later, White® 6000, 6100, 6106, 6108, 6122, 6128, 6138, 6180, 6182, 6184, 6186, 6200, 6208, 6218, 6222, 6238, 6242, 6300, 6308, 6318, 6322, 6338, 6342, 6500, 6512, 6515, 6524, 6531, 6534, 6600, 6608, 6700, 6722, 6762, 6772, 6877, 6800, 6900, 6925, 8000, 8100, 8102, 8104, 8106, 8108, 8116, 8122, 8128, 8138, 8180, 8182, 8186, 8200, 8202, 8222, 8228, 8248, 8300, 8302, 8342, 8346, 8400, 8412, 8415, 8500, 8516, 8523, 8524, 8531, 8600, 8604, 8606, 8608, 8616, 8700, 8702, 8704, 8706, 8708, 8716, 8718, 8722, 8738, 8742, 8743, 8762, 8772, 8776, 8788, 8792, 8800, 8816, 8824, 8831, 8900, 8903, 8905, 8925, 8929 (Replaces GA8324)	Seed Disc Opener Assembly, 15" x 3.50 mm w/ 5/8" ID hole	AMAA53860	\$ 28.85
		Seed Disc Opener Assembly, 15" x 3 mm	AMAA55927	\$ 25.50
	Kinze® Models w/ Seed and Fertilizer Openers, Residue Wheels, and Early Notched Single Disc Fertilizer Openers (Replaces GA2014), White® 6000 Series, 8000 Series - w/ Seed and Fertilizer Openers	Disc Opener Bearing, 204 Series 0.628" ID, 1.782" OD	AMAA21480	\$ 6.85
	Kinze® Row Units (Replaces GB0218), White® 5100, 5700, 6000, 8000 Series, (Replaces WRC6834, N854141)	Bushing	AMA23789	\$ 1.25
	Kinze® Planters w/ OEM original bearing Replaces GD11845	Rubberized Plastic Cap For AMAA53860 Seed Disc Opener Assembly	AMA52024	\$ 0.56





Planter & Grain Drill Parts

Application	Description	Part Number	Retail Price
 Kinze® Planters w/ OEM original bearing Replaces GD11845	Metal Dust Cap For Fertilizer Disc Opener Assembly	AMA22836	\$ 1.06

Scrapers











Application	Description	Part Number	Retail Price
 Kinze® Planter Disc Openers	Rotating Disc Scraper Kit w/ Nylon Covers Includes (2) AMAA37221 Wheels, (1) AMA50047 Spring, (1) AMA69140 Right Hand Arm and (1) AMA69139 Left Hand Arm	AMX55006	\$ 17.25
 Kinze® Planter Disc Openers	Rotating Disc Scraper Kit w/ All Metal Wheels Includes (2) AMAA37221M Wheels, (1) AMA50047 Spring, (1) AMA69140 Right Hand Arm and (1) AMA69139 Left Hand Arm	AMX55007	\$ 17.25
 Kinze® Planter Disc Openers	Rotating Disc Scraper Wheel w/ Nylon Cover	AMAA37221	\$ 6.50
 Kinze® Planter Disc Openers	Rotating Disc Scraper Wheel, All Metal	AMAA37221M	\$ 6.50
 Kinze® Planter Disc Openers	Spring for Rotating Disc Scraper Kits	AMA50047	\$ 2.85
 Kinze® Planter Disc Openers	Scraper Arm, Right Hand	AMA69140	\$ 3.50
 Kinze® Planter Disc Openers	Scraper Arm, Left Hand	AMA69139	\$ 3.50
 Kinze® Planter Disc Openers	Scraper, Right Hand	AMAA26443	\$ 3.75
 Kinze® Planter Disc Openers	Scraper, Left Hand	AMAA26444	\$ 3.75
 Kinze® 3000 Series Row Units	Tungsten Seed Opener Scraper	AMAA62559	\$ 20.50

Gauge Wheels and Components





Application	Description	Part Number	Retail Price
 Kinze® 2000 and 3000 Series Row Units (Replaces GD1086), White® 5100-5700, 6000-8000 (Replaces 852060, F7100T)	Gauge Wheel Tire, 4.50" x 16" Carlisle®	AMA22884	\$ 40.00
	Gauge Wheel Tire, 4.50" x 16" Solid Urethane	AMA22884U	\$ 85.00
 Kinze® 1993 and Later Excluding 3000 Series (Replaces GA7949), White® 8000 Series (Replaces 700727657, 700725744)	Gauge Wheel Assembly, 4.50" x 16" w/ AMAN212132 bearing	AMAA66604	\$ 80.00
	Gauge Wheel Assembly, 4.50" x 16" Solid Urethane Tire	AMAA66604U	\$ 120.00
 Kinze® 1993 and Later, White® 8700, 8742, 8743	Gauge Wheel Tire, 3" x 16" Carlisle® Replaces A75374, A84349	AMA85133	\$ 40.00
	Gauge Wheel Tire, 3" x 16" Solid Urethane, Extended Wear Replaces A75374, A84349	AMA85133U	\$ 75.00
 Kinze® 1993 and Later, White® 8000 Series	Gauge Wheel Assembly, 4.50" x 16" Carlisle®, Spoked	AMX55039	\$ 145.00
	Gauge Wheel Assembly, 3" x 16" Carlisle®, Spoked	AMX55041	\$ 135.00
 Kinze® 1993 and Later (Replaces GA8877), White® 8000 Series	Gauge Wheel Assembly, Narrow 3" x 16"	AMAA66988	\$ 80.00
	Gauge Wheel Assembly, Narrow 3" x 16" Solid Urethane Tire	AMAA66988U	\$ 120.00

Planter & Grain Drill Parts

Planter Parts for Kinze® and White®

Application	Description	Part Number	Retail Price
 Kinze® Row Units Replaces GA2021	Gauge Wheel Assembly, 4.50" x 16" Yellow steel wheel halves, JD style chined tire and stem bearing w/ cross hole	AMAA35392	\$ 80.00
	Gauge Wheel Assembly, 4.50" x 16" Urethane Tire	AMAA35392U	\$ 120.00
 Kinze® 2000 Row Units Replaces GD11423	Wheel Half, Steel Painted Yellow (2) Required	AMA22780	\$ 11.00
 Kinze® 2000 and 3000 Series Row Units Replaces GD11453	Wheel Half, Plastic 8-Bolt	AMA56565	\$ 16.50
 Kinze® 1993 and Later, White® 8000 Series	Rim, Plastic	AMA85134	\$ 16.50
 Kinze® 1993 and Later, White® 8000 Series (Replaces N858654)	Rim, Steel	AMA85104	\$ 16.50
 Kinze® 2000 and 3000 Series Row Units, White® Late Model 6000 and 8000 Series Rubber or Cast Dual Closing Wheels Replaces GA6171, 854003	Double Row Ball-Bearing, 40 mm For 4" x 16" wheel assemblies	AMAN212132	\$ 7.50
 Kinze® Row Units Prior to 1993 (Replaces GA2022), White® 5100, 5700	Bearing w/ Sleeve Stem Type	AMAA38106	\$ 9.50
 Kinze® Row Units Prior to 1993 (Replaces GA2022), White® 5100, 5700	Bearing w/ Hole For Closing and Press Wheels SL4x16 Sleeve Required on Press Wheel	AMAA35741	\$ 5.50
 For Gauge Wheel Assembly Replaces GB0118	Stem Bearing Bushing Use w/ AMAN131668 Stem Bearing or AMAA35741 Stem Bearing w/ Hole	AMA25915	\$ 1.60
 Kinze® 2000 Series Row Units Prior to 1999	Gauge Wheel Arm Kit Includes (2) Bushings For wheel that uses cross-drilled stem bearing	AMA54179	\$ 40.00
 Kinze® 2000 Series Row Units Prior to 1999	Self-Aligning Bushing Use w/ AMA54179	AMA57058	\$ 11.00



Seed Tubes and Components

Application	Description	Part Number	Retail Price
 Kinze® Row Units w/ Curved Seed Tube	Slicer Knife Made from Cast Chrome	AMX55003	\$ 17.00
	Fastener Kit Required for AMX55003	AMX55004	\$ 1.50
 Kinze® Planters	Guard-Scraper (Cast Frog)	AMA61577	\$ 6.25
 Kinze® Planters	Opener Guard	AMA48879	\$ 9.50
 Kinze® Planters Replaces GB0102	Handle Depth Adjustment Assembly	AMA42740	\$ 18.50





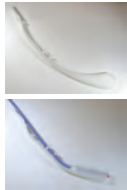

Planter & Grain Drill Parts

Application	Description	Part Number	Retail Price
 Kinze® Planters Replaces GB0104	Seed Depth Stop	AMA42737	\$ 17.00





Keeton® Seed Firmers

Application	Description	Part Number	Retail Price
	Kinze® 2000 and 3000 Series Row Units, White® 5000, 6000, 8000 and 9000 Series	Keeton® Seed Firmer w/ Standard Dry Tail	AMX55018 \$ 44.00
		Seed Tube Mount w/ Standard Liquid Tail	AMX55019 \$ 45.00
	Kinze® 2000 and 3000 Series Row Units	Keeton® Seed Firmer w/ Standard Dry Tail	AMX55053 \$ 44.00
		Kinze® Bracket w/ Standard Liquid Tail	AMX55054 \$ 40.00
		Bracket mounts inside the unit between scrapers Will not work w/ spring-loaded disc scrapers	w/ Short Low-Profile Tail AMX55055 \$ 45.00
	White® 6000*, 8000* and 9000 Series* *Requires Bracket Modifications	Keeton® Seed Firmer w/ Standard Dry Tail	AMX55050 \$ 44.00
		Universal Bracket w/ Standard Liquid Tail	AMX55051 \$ 40.00
		Bracket mounts to seed disc opener shafts	w/ Short Low-Profile Tail AMX55052 \$ 45.00
	Fits Universal or Kinze® Brackets	Replacement Dry Tail	AMX55015 \$ 40.00
		Replacement Short Low-Profile Tail	AMX55016 \$ 40.00









Closing Wheels and Components

Application	Description	Part Number	Retail Price
 Kinze® Prior to 1993 Replaces (2) of GA3086	Closing Wheel Assembly, 1" x 12" Made w/ plastic wheel halves, w/ stem bearing	AMAA43899	\$ 30.00
 Kinze® 2000 and 3000 Series Row Units, White® 6000 and 8000 with Dual Closing Wheels Replaces GA6434, 854262	Closing Wheel Assembly, 1" x 12" Uses 5203KYY2 Bearing	AMAA39968	\$ 32.00
 Kinze® 2000 and 3000 Row Units, White® 6000, 8000, 9000 Series	Closing Wheel Tire, 1" x 12"	AMAA22325	\$ 7.50
 Kinze® 2000 and 3000 Series Row Units, White® Late Model 6000 and 8000 Series Rubber or Cast Dual Closing Wheels Replaces GA6171, 854003	Double Row Ball-Bearing, 40 mm For 4" x 16" wheel assemblies	AMAN212132	\$ 7.50
 Kinze® Planters Replaces GA6056	Closing Wheel Arm	AMAA31217	\$ 36.00
 Kinze® Planters Replaces GA6056	Spiral Pins for Wheel Arm 1/4" x 1 1/4" Sold in Multiples of 50, Priced Individually	AMA26311	\$ 0.40

Planter & Grain Drill Parts

Application	Description	Part Number	Retail Price
 Kinze® Planters	Closing Wheel Arm Stop	AMA33879	\$ 21.50
 Kinze® Planters	Eccentric Bushing	AMX55008	\$ 2.50
 Kinze® 1993 and Later, White® 6000, 8000 & 9000 Series	Xtreme Cruiser Set of 2, Cast Spiked Closing Wheel 14 Tooth Includes Spacing Washers	AMX55063	\$ 280.00
 Kinze® 1993 and Later, White® 6000, 7000 & 8000 Series	Furrow Cruiser Set of 2 For Planters w/ "V" Style Closing System	AMX55061	\$ 230.00
	Furrow Cruiser Set of 2 For Shallow Depth Planting, Vegetables, Sugar Beets and Cotton	AMX55066	\$ 260.00
 Kinze® 1993 and Later, White® 6000, 7000 & 8000 Series	Furrow Cruiser Insert Set of 2 For Planters w/ "V" Style Closing System	AMX55062	\$ 140.00
	Furrow Cruiser Insert Set of 2 For Shallow Depth Planting, Vegetables, Sugar Beets and Cotton	AMX55068	\$ 140.00







Row Unit Components

Application	Description	Part Number	Retail Price
 Kinze® 2000 and 3000 Row Units Replaces GD1041	Seed Belt Drive Wheel For finger pickup mechanism	AMA76093	\$ 8.00
 Kinze® 2000 Series Row Units Replaces GD1040	Corn Meter Belt	AMA67976	\$ 13.00
 Kinze® 2000 and 3000 Series Row Units Replaces B30968 (also used on liquid or dry fertilizer drive, herbicide/insecticide drive)	Plastic Idler For Seed Transmission, 1 7/8" Diameter	AMB30969	\$ 1.55
 Fits Kinze® 2000 and 3000 Series Row Units Replaces GD7426	Plastic Idler Sprocket, 10 Tooth For seed drive on vacuum and finger pickup units and herbicide/insecticide drive	AMA55008	\$ 1.15
 Kinze® Row Units & White® w/ Bolt-On Wheels	Drag Chain Kit Includes mounting brackets and twisted link chain	AMX55011	\$ 80.00
 Kinze® Planters	Closing Wheel Spring w/ Plug	AMAA23116	\$ 11.00
 Kinze® Planters Prior to 1989, White® 6000 Series	Down Pressure Spring w/ Plug 6 1/8" Overall Length, 1 7/16" OD, 4 1/2" Spring Length	AMAB10071	\$ 7.50
 Kinze® Planters Prior to 1989, White® 6000 Series	Down Pressure Spring w/ Plug, HD 6 7/8" Overall Length, 1 1/4" OD, 4 3/8" Spring Length	AMAA35876	\$ 11.75

Planter Parts for Kinze® and White®

Planter & Grain Drill Parts





Planter Parts for Kinze® and White®

	Application	Description	Part Number	Retail Price
	Kinze® 1989 and Later	Down Pressure Spring	AMGD8249	\$ 4.75
	White® 8102, 8104, 8106, 8108, 8116, 8122, 8128, 8138, 8604, 8606, 8608, 8616, 8702, 8704, 8706, 8708, 8716, 8718, 8903, 8905, 8925, 8929, 8935	Pneumatic Air Spring	AM700732697	\$ 41.50
	White® 8816, 8824	Pneumatic Air Spring	AM700736342	\$ 65.00
	Kinze® 3000 Series	Pneumatic Air Spring	AMGA11982	\$ 65.00
	Kinze® 2000 Series Row Units Replaces GA2036	Down Pressure Spring Eyebolt Use w/ AMA43609 Down Pressure Spring	AMA39073	\$ 8.00
	Kinze® seed and fertilizer transmissions and drive lines, Kinze® contact drive wheel	Bearing 7/8" Hex Bore, Curved Outer Race	AMAA22097	\$ 9.00
	Kinze® 3000 Series Row Units	Tension Spring	AMA28518	\$ 2.00

Replacement Chains















	Application	Description	Part Number	Retail Price
	Kinze® seed meter chain (except push units) Replaces G3303-98	Chain, 98 links Includes connector link	AMAA20978	\$ 10.00
	Kinze® herbicide/insecticide chain units before 1983 Replaces G3303-110	Chain, 110 links Includes connector link	AMAA43719	\$ 9.00

Planter and Grain Drill Parts for Case IH®













	Application	Description	Part Number	Retail Price
	Planters: 800, 900, 950, 955, 1200 Series, Grain Drills: 5400, 5500	Disc Opener Assembly, 14" x 3.50 mm, Right Hand Bellota®, Taper is on opposite side of hub	AM90851C92	\$ 35.00
		Disc Opener Assembly, 14" x 3.50 mm, Left Hand Bellota®, Taper is on same side as hub	AM90850C92	\$ 35.00
	Planters: 800, 900, 950, 955, 1215, 1225, 1235, 1245, 1255, 1265, Grain Drills: 5400, 5500 Models Prior to 2012 can be updated to this blade using AM107-111D Cover and 5/8" x 2" Bolts	Disc Opener Assembly, 14" x 4.50 mm Bellota®, Double Bevel, Leading Opener w/ Heavy Duty Bearing	AM84416318	\$ 37.50
		Disc Opener Assembly, 14" x 4.50 mm Bellota®, Double Bevel, Trailing Opener w/ Heavy Duty Bearing	AM84416319	\$ 37.50
	Planters: 92, 1200, Grain Drills: 5200, 5300, 5400, 5500, 6100, 6300, 6800, 8600 Replaces 145161C91, 145161C92, 492757R91, 1268017C91	Disc Opener Bearing, 204 Series 0.628" ID, 1.782" OD	AMAA21480	\$ 6.85
	Grain Drills: 5100, 5200, 6200, International® Grain Drills: 10, 100, 510, 620, Fertilizer Unit: 224	Disc Opener Blade 14" Diameter, 0.0984" Thick, 6-Hole Pattern, 2 1/2" Bolt Circle Diameter	AM603013R2	\$ 18.00
	Air Seeders: SDX30, SDX40	Opening Disc, 22.50" x 0.256" Replaces 73340386	AM306001A1	\$ 50.00
	Planters: 800, 900, 950, 955, 1200, Grain Drills: 5400, 5500	Opener Scraper Kit, Heavy Duty	AM1547680C1	\$ 34.00

Prices Subject to Change without Prior Notice. The use of original equipment manufacturer (OEM) part numbers or trademarks, e.g. Case® and John Deere®, are for reference purposes only and for indicating product use and compatibility. Our company and the listed replacement parts contained herein are not sponsored, approved or manufactured by the OEM. All parts are New unless designated Reman in the description.



Planter & Grain Drill Parts

	Application	Description	Part Number	Retail Price
	Planters: 800, 900, 950, 955, 1200, 1200PT, 1210, 1215, 1220, 1225, 1230, 1235, 1240, 1245, 1250, 1255, 1260, 1265, Grain Drills: 5400, 5500	Covering Disc Assembly 8" Diameter, 0.118" Thickness	AM1277891C91	\$ 20.00
	Planters: 800, 900, 950, 955, 1200, Air Drills: SDX30, SDX40	Gauge Wheel Tire, 4.50" x 15.50"	AM128633C1	\$ 35.00
	Planters: 800, 900, 950, 955, 1200, 5400, 5500	Traction Tread Tire, 6.50" x 12"	AM90854C1	\$ 50.00
	Planters: 900, 955, 1200, 1200PT	Gauge Wheel Assembly, 4.50" x 15.50"	AM225349A1	\$ 80.00
	Planters: 1200, 1200PT, 1210, 1220, 1225, 1230, 1240, 1250, 1260, Air Seeders: SDX30, SDX40	Gauge Wheel Assembly, 4.50" x 15.50" Black Steel Wheel Half, Reduced Inner Diameter Tire, w/ Double Row Ball Bearing, 5/8" Bearing ID	AM87604747	\$ 80.00
	Planters: Most Models, Grain Drills: Most Models	Gauge Wheel Assembly, 4.50" x 16" Carlisle®, Spoked	AMX55039	\$ 145.00
		Gauge Wheel Assembly, 3" x 16" Carlisle®, Spoked	AMX55041	\$ 135.00
	Air Drills: 500, 500T Replaces 21618	Gauge Wheel Assembly, 4.50" x 16" w/ AMAN212132 bearing	AMAA66604	\$ 80.00
		Gauge Wheel Assembly, 4.50" x 16" Solid Urethane Tire	AMAA66604U	\$ 120.00
	Planter: 1200 ASN CBJ0001611 Replaces 87604612	Rim, Steel	AMA85104	\$ 16.50
	Planters: 1200, 5300, 5400, 5500, Air Drills: SDX30, SDX40 Replaces 324461A1	Double Row Ball-Bearing, 40mm Use w/ AM128633C1 Gauge Wheel Tire	AMAN212132	\$ 7.50
	For Gauge Wheel Assembly Replaces 133966C1	Stem Bearing Bushing Use w/ AMAN131668 Stem Bearing or AMAA35741 Stem Bearing w/ Hole	AMA25915	\$ 1.60
	Planters: 800, 900, 950, 955 Replaces 128558C91	Bearing w/ Sleeve Stem Type	AMAA38106	\$ 9.50
	Planters: 800, 900, 950, 955, 1200 Series BSN CBJ0001610 Replaces 128558C91	Bearing w/ Hole For Closing and Press Wheels SL4x16 Sleeve Required on Press Wheel	AMAA35741	\$ 5.50
	Air Seeders: SDX30, SDX40	Packer Wheel, 1" x 10" 5/8" ID Replaces AN281359	AMAA38447	\$ 25.00
	Air Drills: SDX30, SDX40 Replaces 306251A1	Closing Wheel Tire, 1" x 12"	AMAA22325	\$ 7.50
	Air Drills: SDX30, SDX40 Replaces 87695406	Closing Wheel Assembly, 1" x 12" Uses 5203KYY2 Bearing	AMAA39968	\$ 32.00
	Planters: 800, 900, 950, 955	Hub Cap	AM224066C1	\$ 4.15
	800 and 900 Cyclo main wheel drive chain on trailing planters ASN 14501	Chain, Type 2050, 56 links Includes connector link	AMAA22372	\$ 14.00







Planter & Grain Drill Parts

Application	Description	Part Number	Retail Price
 Cyclo output speed drive chain	Chain, 44 links Includes connector link	AMAA21483	\$ 7.00
 Planters: 1200, 1200PT, 1210, 1220, 1230, 1240, 1250, 1255, 1265	Solenoid, Flow Control Valve Replaces 87775314	AM188105A1	\$ 70.00
 Air Seeders: SDX30, SDX40	Xtreme Cruiser Set of 2, Cast Spiked Closing Wheel 14 Tooth Includes Spacing Washers	AMX55063	\$ 280.00
 Air Seeders: SDX30, SDX40	Furrow Cruiser Set of 2 For Planters w/ "V" Style Closing System	AMX55061	\$ 230.00
 Air Seeders: SDX30, SDX40	Furrow Cruiser Set of 2 For Shallow Depth Planting, Vegetables, Sugar Beets and Cotton	AMX55066	\$ 260.00
 Air Seeders: SDX30, SDX40	Furrow Cruiser Insert Set of 2 For Planters w/ "V" Style Closing System	AMX55062	\$ 140.00
 Air Seeders: SDX30, SDX40	Furrow Cruiser Insert Set of 2 For Shallow Depth Planting, Vegetables, Sugar Beets and Cotton	AMX55068	\$ 140.00
 Planters: 1200, 1200PT, 1210, 1220, 1225, 1230, 1240, 1250, 1260, 2150	Electric Module	AM87601142	\$ 43.00
 Planter: 900, Grain Drills: 30, 40, 400, 500, 500DS, 700, 5000, 5500, 6200, 7200, (ATX400, ATX700 BSN Y9S003001), SDX30, SDX40	Riser Tube w/ Flange	AMGP-103	\$ 209.40
 Grain Drill: 30, 40, 400, 5000, (SDX30, SDX40 - Tow-Between)	Air Hose Coupling Kit Stainless Steel Includes (2) 3 Port Couplers	AMX55110	\$ 309.10
 Grain Drills: 30, 40, 400, 5000, ATX400 BSN Y9S003001, (SDX30, SDX40 - Tow-Between)	Quick Connect Coupler Assembly, Applicator Side 3 Port Coupler	AMGD-672A	\$ 168.75
 Grain Drills: 30, 40, 400, 5000, 5500, ATX400 BSN Y9S003001, SDX30, SDX40	Quick Connect Coupler Assembly, Cart Side 3 Port Coupler	AMGD-673	\$ 155.81

Planter and Grain Drill Parts for New Holland®

Application	Description	Part Number	Retail Price
 Planters: SP280, SP380, SP480, SP580	Disc Opener Assembly, 14" x 3.50 mm, Right Hand Bellota®, Taper is on opposite side of hub	AM90851C92	\$ 35.00
 Planters: SP280, SP380, SP480, SP580	Disc Opener Assembly, 14" x 3.50 mm, Left Hand Bellota®, Taper is on same side as hub	AM90850C92	\$ 35.00
 Planters: SP280, SP380, SP480, SP580 Models Prior to 2012 can be updated to this blade using AM107-111D Cover and 5/8" x 2" Bolts	Disc Opener Assembly, 14" x 4.50 mm Bellota®, Double Bevel, Leading Opener w/ Heavy Duty Bearing	AM84416318	\$ 37.50
	Disc Opener Assembly, 14" x 4.50 mm Bellota®, Double Bevel, Trailing Opener w/ Heavy Duty Bearing	AM84416319	\$ 37.50



Planter & Grain Drill Parts

Application	Description	Part Number	Retail Price
 Planters: SP280, SP380, SP480, SP580 - w/ Seed and Fertilizer Openers	Disc Opener Bearing, 204 Series 0.628" ID, 1.782" OD	AMAA21480	\$ 6.85
 Planters: SP280, SP380, SP480, SP580	Covering Disc Assembly 8" Diameter, 0.118" Thickness	AM1277891C91	\$ 20.00
Planters: SP280, SP380, SP480, SP580	Gauge Wheel Assembly, 4.50" x 15.50"	AM225349A1	\$ 80.00
 Grain Drills: (P2050, SD440A BSN Y9S003001), P2060 ASN Y9S003001, P2070, P2080, P2082, P2085, SD440, SD550	Riser Tube w/ Flange	AMGP-103	\$ 209.40
 Grain Drills: (P2050, SD440A (BSN Y9S003001), SD440	Air Hose Coupling Kit Stainless Steel Includes (2) 3 Port Couplers	AMX55110	\$ 309.10
 Grain Drills: (P2050, SD440A ASN Y9S003001), SD440	Quick Connect Coupler Assembly, Applicator Side 3 Port Coupler	AMGD-672A	\$ 168.75
 Grain Drills: P2050 ASN Y9S003001, SD440, SD440A BSN Y9S003001	Quick Connect Coupler Assembly, Cart Side 3 Port Coupler	AMGD-673	\$ 155.81



Grain Drill Parts for Landoll®

Application	Description	Part Number	Retail Price
5210, 5211, 5530, 5531, 5540, 5550	Disc Opener Assembly, 15.75" x 3.50 mm	AM143880	\$ 47.50













Grain Drill Parts for Sunflower®

Application	Description	Part Number	Retail Price
(9100, 9200, 9300, 9400 BSN 18358 Prior to 2001 w/ Offset Openers)	Seed Disc Opener Assembly, 15" Bellota®	AMSN7261	\$ 34.00
 (9100, 9200, 9300, 9400 ASN 18358 2001 and Later w/ Offset Openers)	Seed Disc Opener Assembly, 15" Bellota®	AMSN9753N	\$ 34.00
 (9100, 9200, 9300, 9400 ASN 18358 2001 and Later w/ Offset Openers)	Seed Disc Opener, 15" Bellota®, Blade Only	AMSN9752N	\$ 20.00





Planter and Grain Drill Parts for Great Plains®

Application	Description	Part Number	Retail Price
 Grain Drills	Drill Disc Assembly, 13.50" x 4 mm Bellota®, w/ 205 Bearing	AM107-138S	\$ 30.50
	Drill Disc Assembly, 13.50" x 3 mm Bellota®, w/ 205 Bearing	AM107-135S	\$ 32.50
 Planters: Late Model Row Units 1999 and Later, Grain Drills: Late Model 1999 and Later w/ Heavy Duty HD00, HD10, 15 and 25 Series Openers	Disc Opener Assembly, 15" x 4 mm Bellota®, HD, w/ 205 Series Bearing (5/8" ID)	AM820-287C	\$ 37.00
 Planters: Most Models, Grain Drills: Early Models w/ 13.50" Double Disc Openers Replaces 820-003C, 822011C	Disc Opener Bearing, 204 Series 0.628" ID, 1.782" OD	AMAA21480	\$ 6.85







Planter & Grain Drill Parts

Application	Description	Part Number	Retail Price
Grain Drills	Disc Opener Bearing, 205 Series 3/4" ID, 2.09" OD For Early 15" Disc Openers	AM188-007V	\$ 8.50
 Grain Drills	Double Disc Opener Bearing 205 bearing w/ 5/8" ID hole Replaces GD8188	AM188-001V	\$ 9.50
 Grain Drills	Cap Required when replacing 204 bearing assembly w/ 205 bearing assembly	AM107-111D	\$ 2.25
 Grain Drills: YP30, YP40, YP425A (4 Row Pull-Type Yield Pro Sugar Beet), YP425A3P, YP625A, YP625A3P, YP825A, YP825A3P (8 Row 3-Point Mounted Yield Pro), YP825AR, YP1225, YP1225A, YP1625, YP1625A, YP2425, YP2425A	Gauge Wheel Tire, 3" x 16" Carlisle® Replaces A75374, A84349	AMA85133	\$ 40.00
	Gauge Wheel Tire, 3" x 16" Solid Urethane, Extended Wear Replaces A75374, A84349	AMA85133U	\$ 75.00
 Grain Drills	Smooth Crown Tire, 2" x 13"	AMX55026	\$ 15.00
 Grain Drills	Wheel, 2" x 13" w/ Nylon Wheels and Stem Bearings	AM814-157CN	\$ 64.00
Grain Drills	Press Wheel, 3" x 13" Includes Single Rib Tire, Nylon Wheel Halves and Bearing	AM814-158C	\$ 107.00
 Grain Drills: Models Prior to 1997 w/ 2x13, 3x13 or 3x14 Press Wheels, Models 1984 and Later w/ 4x12 Press Wheels	Press Wheel Bearing 0.72" Wide, 0.625" ID (2) Required	AM822-095C	\$ 5.00
 Grain Drills	Gauge Wheel Assembly, 4.50" x 16" Carlisle®, Spoked	AMX55039	\$ 145.00
	Gauge Wheel Assembly, 3" x 16" Carlisle®, Spoked	AMX55041	\$ 135.00
 YP Grain Drills Replaces 814-260C	Gauge Wheel Assembly, Narrow 3" x 16"	AMAA66988	\$ 80.00
	Gauge Wheel Assembly, Narrow 3" x 16" Solid Urethane Tire	AMAA66988U	\$ 120.00
 YP Grain Drills Replaces 814-173C	Gauge Wheel Assembly, 4.50" x 16" w/ AMAN212132 bearing	AMAA66604	\$ 80.00
	Gauge Wheel Assembly, 4.50" x 16" Solid Urethane Tire	AMAA66604U	\$ 120.00
 YP Grain Drills	Rim, Plastic	AMA85134	\$ 16.50
 YP Grain Drills	Rim, Steel	AMA85104	\$ 16.50
 For 2" x 13" and 3" x 13" Press Wheels Built 1997 and Later	Double Row Ball-Bearing, 40 mm For 4" x 16" wheel assemblies	AMAN212132	\$ 7.50
 Grain Drills	Packer Wheel, 1" x 10" Stem type bearing	AM199-009C	\$ 29.00

Planter & Grain Drill Parts









Application	Description	Part Number	Retail Price
 YP Grain Drills	Keeton® Seed Firmer	w/ Standard Dry Tail AMX55018	\$ 44.00
	Seed Tube Mount	w/ Standard Liquid Tail AMX55019	\$ 45.00
 Grain Drills	Scraper, Slotted For 13.50" Disc Openers	AM107-113D	\$ 3.15
 Planters	Xtreme Cruiser Set of 2, Cast Spiked Closing Wheel 14 Tooth Includes Spacing Washers	AMX55063	\$ 280.00
 Grain Drills: 2N-2410, 2N-3010, 2S-2600HD, 2S-2600F, 2SF24, 2SF30, 2SNG24, 1005NT, 1006NT, 1007NT, 1200, 1205NT, 1206NT, 1300EWD, 1500, 1510HDP, 1510P, 1520P, 2000, 2010P, 2015P, 2020P, 2025F, 2025P, 2400, 2410, 2410P, 2420, 2420P, 2510HDP, 2515P, 2520F, 2520P, 2525A, 2525F, 2525P, 2700	Rubber Seed Flap	AM816-302C	\$ 2.25

Grain Drill Parts for Tye®

Application	Description	Part Number	Retail Price
 Grain Drills	Disc Opener Assembly, 13.50"	AM540-012	\$ 40.00
 Models w/ Conventional Grain Drill Double Disc Openers	Disc Opener Bearing, 204 Series 0.628" ID, 1.782" OD	AMAA21480	\$ 6.85
 Grain Drills	Packer Wheel, 1" x 10" w/ 1/2" ID Bearing	AM501-006	\$ 24.95
 2015, 2020	Closing Wheel Tire, 1" x 12"	AMAA22325	\$ 7.50
 Grain Drills	Bearing w/ Sleeve Stem Type	AMAA38106	\$ 9.50
 Grain Drills	Bearing Stem Type	AMAN131668	\$ 11.15
 For Gauge Wheel Assembly	Stem Bearing Bushing Use w/ AMAN131668 Stem Bearing or AMAA35741 Stem Bearing w/ Hole	AMA25915	\$ 1.60

Planter & Grain Drill Parts





Sensors—Seed Flow and Population

	Application	Description	Part Number	Retail Price
	Planters: Case IH® 800, 900, John Deere® 7000, 7100, 7200, 7300, Kinze®, White® 5100, 5400, 5700	Planter Seed Flow Sensor w/ 3 Amp Connector	AMAA27652	\$ 90.00
	Planters: Case IH® 800, 900, John Deere® 7000, 7100, 7200, 7300, Kinze®, White® 5100, 5400, 5700	Planter Seed Flow Sensor w/ Weather Pack Connector	AMX55005	\$ 90.00
	Planters: Case IH® 800, 900, John Deere® 7000, 7100, 7200, 7300, Kinze®, White® 5100, 5400, 5700	High Rate Planter Population Sensor w/ Weather Pack Connector	AMAA58293	\$ 55.00
	Grain Drills: Case IH®, CrustBuster®, Great Plains®, Hiniker®, John Deere®, Krause®, Marliss®, Sunflower®, Tye®, UFT® and many others	Grain Drill Seed Flow Sensor w/ Weather Pack Connector	AMX55034	\$ 96.00
	Grain Drills: CrustBuster®, John Deere® 750 (Prior to 1994), many other types of drills	Grain Drill Seed Flow Sensor w/ Weather Pack Connector	AMX55035	\$ 90.00
	Planters: John Deere® 1700, 1710, 1720, 1730, 1750, 1760, 1760NT, 1770, 1770NT, 1780, 1790, DB44, DB58, DB60, DB66, DB80, DB90, Grain Drills: Case IH®, CrustBuster®, Great Plains®, Hiniker®, John Deere® 455, 750, 1520, 1530, 1560, 1565, 1690, 1890, Krause®, Marliss®, Sunflower®, Tye®, UFT® and many other types of Drills and Air Seeders that use convoluted seed tubing	Grain Drill Population Sensor w/ Weather Pack Connector	AMAA38813	\$ 159.00
	Planters: Case IH®, New Holland®, John Deere®, Kinze®, White®, Grain Drills: Case IH®, Crust Buster®, New Holland®, Great Plains®, Hiniker®, John Deere®, Krause®, Marliss®, Sunflower®, Tye®, UFT, and many other types of Grain Drills	High Rate Sensor Tester Tool For testing both seed flow sensors and population sensors, comes w/ standard Weather Pack Connector that is adaptable to a Cannon™ Sure Seal or a 3 Amp Connector, operates on a 9 volt battery (included)	AMX55033	\$ 227.00
	Planters: Case IH®, New Holland®, John Deere®, Kinze®, White®, Grain Drills: Case IH®, Crust Buster®, New Holland®, Great Plains®, Hiniker®, John Deere®, Krause®, Marliss®, Sunflower®, Tye®, UFT, and many other types of Grain Drills	Adapter Weather Pack Connector to Cannon™ Sure Seal Connector	AMX55036	\$ 48.00
	Planters: Case IH®, New Holland®, John Deere®, Kinze®, White®, Grain Drills: Case IH®, Crust Buster®, Great Plains®, Hiniker®, John Deere®, Krause®, Marliss®, Sunflower®, Tye®, UFT, and many other types of Grain Drills	Adapter Weather Pack Connector to 3 Amp Connector	AMX55037	\$ 48.00

No-Till Coultter Blades







	Application	Description	Part Number	Retail Price
	John Deere® Planters: 7000, 7100, MaxEmerge™	Coulter Blade, 13 Wave 16" diameter, 3/4" wide, 0.190" thick, 6-hole pattern	AMA72677	\$ 30.00

Planter & Grain Drill Parts

	Application	Description	Part Number	Retail Price
	John Deere® Planters: MaxEmerge™ 2, MaxEmerge™ Plus, Pro, XP, XP Pro, Grain Drills: 1530, 1535	Coulter Blade, 13 Wave 16" diameter, 3/4" wide, 0.190" thick, 5-hole pattern, 4 3/4" bolt circle diameter	AMA72678	\$ 30.00
	Grain Drills: Great Plains®, Case IH® 5400, John Deere® 1570, Krause®, Yetter®, No-Till Coulters: Yetter®, Kinze®	Coulter Blade, 13 Wave 16" diameter, 3/4" wide, 0.190" thick, 4-hole pattern	AMA72694	\$ 35.00
	John Deere® Planters: MaxEmerge™ 2, MaxEmerge™ Plus, Pro, XP, XP Pro, Grain Drills: 1530, 1535	Coulter Blade, 18 Wave 16" diameter, 0.157" thick, 5-hole pattern, 4 3/4" bolt circle diameter	AMA72360	\$ 33.50
	John Deere® Planters: 7000, 7100, MaxEmerge™, MaxEmerge™ Plus, Pro, Pro XP	Coulter Blade, 25 Wave 16" diameter, 0.190" thick, 6-hole pattern, 3 1/2" bolt circle diameter	AMA72679	\$ 30.00
	John Deere® Planters: MaxEmerge™ 2, MaxEmerge™ Plus, Pro, XP, XP Pro, Grain Drills: 1530, 1535	Coulter Blade, 25 Wave 16" diameter, 5/8" wide, 0.190" thick, 5-hole pattern, 4 3/4" bolt circle diameter	AMA72680	\$ 30.00
	John Deere® Planters: 1530, 1535, MaxEmerge™ 2, MaxEmerge™ Plus, Pro, XP, XP Pro	Coulter Blade, Fluted 16" diameter, 0.157" thick, 6-hole pattern	AMA73910	\$ 32.00

Commodity Cart Parts

Meter Housing and Components

	Application	Description	Part Number	Retail Price
	Case IH® 2280, 2330, 3380, 3430, ADX3360, ADX3380, ADX3430, Flexi-Coil® 2850, 3350, 3450, 3850, 4350, New Holland® P1030, P1040, P1050, P1060, SC380, SC430	Meter Housing	AMGL-400A	\$ 3046.20
	Flexi-Coil® 1330, John Deere® 787	Meter Housing For 6 Run Meter	AMX55104	\$ 2733.26
	Flexi-Coil® 1720, 2320, John Deere® 787 (Excluding 130 Bushel Cart)	Meter Housing For 8 Run System Replaces GH-128A, NAGH152A	AMGH-661A	\$ 3092.00
	John Deere® 1900*, 1910 *For 270 Bushel Tow-Between	Meter Roll Shaft 7/8" Hex Shaft Diameter, Stainless Steel	AMA57211	\$ 273.00
	John Deere® 1900 ASN 685195 for Tow-Behind or ASN 685240 for Tow-Between, 1910, C650, C850	Meter Mount Plate	AMAA50064	\$ 680.00
	John Deere® 1900 ASN 685195 for Tow-Behind or ASN 685240 for Tow-Between, 1910, C650, C850	Top Meter Housing Seal Replaces A62773	AMA70600	\$ 91.00
	John Deere® 1900, 1910, C650, C850	Half Width Disconnect Kit	AMX55073	\$ 511.63













Planter & Grain Drill Parts

Application	Description	Part Number	Retail Price
 John Deere® 1900, 1910, C650, C850	Hydraulic Motor Mounting Kit Side Mount Stainless Steel Bracket For mounting Motor to side of Meter Housing if you have Hydraulic Drive or are converting to Hydraulic Drive	AMX55075	\$ 169.12
 John Deere® 1900, 1910, C650, C850	Drive Bushing Will Not Fit OEM Meter Housings	AMA92922	\$ 28.58
Morris® 6000 Series	Metering Wheel Calibrator 3" Wide	AMN19070	\$ 29.45
Morris® 6000 Series	Section Shut-Off Plate Stainless Steel	AMN19407	\$ 14.73
Morris® 6000 Series	Meter Housing Stainless Steel For 6 Run System Includes Mounting Hardware and Seals	AMN19490	\$ 1725.06
Morris® 6000 Series	Meter Housing Stainless Steel For 8 Run System Includes Mounting Hardware and Seals	AMN19686	\$ 1796.58
Morris® 6000 Series	Shim Stainless Steel 1/8" Thick	AMX55118	\$ 15.15
Morris® 6000 Series	Shim Stainless Steel 1/4" Thick	AMX55119	\$ 21.04
Morris® 7000 Series	Meter Box Stainless Steel For 8 Run System Includes Mounting Hardware and Seals	AMN28928	\$ 1640.91
Morris® 7000 Series	Metering Wheel Calibrator For #7 Wheel 1.75" Wide	AMN27087	\$ 29.45
Morris® 7000 Series	Metering Wheel Calibrator For #8 Wheel 2" Wide	AMN27088	\$ 29.45
Morris® 7000 Series	Metering Wheel Calibrator For #9 Wheel 2.25" Wide	AMN27089	\$ 29.45
Morris® 7000 Series	Metering Wheel Calibrator For #10 Wheel 2.50" Wide	AMN27090	\$ 29.45
Morris® 7000 Series	Metering Wheel Spacer Plate Stainless Steel For #9 Wheel - Single, Left 1/4" Thick	AMN27099	\$ 21.04
Morris® 7000 Series	Meter Box Section Shut-Off Plate Stainless Steel	AMN27605	\$ 14.73
Morris® 7000 Series	Metering Wheel Spacer Plate Stainless Steel 1/8" Thick	AMX55120	\$ 15.15
Morris® 8000 Series	Meter Housing Stainless Steel Includes Clamping Bracket, Shut-Off Gates, Mounting Hardware and Seals	AMN37131	\$ 3492.19
Morris® 8000 Series Tow-Between Excluding 8000XL Series	Collector Spacer Stainless Steel Includes Mounting Hardware and Seals	AMN37865	\$ 424.95
Morris® 8000 Series	Meter Housing Cleanout Door Stainless Steel	AMN42135	\$ 223.00

Planter & Grain Drill Parts

Application	Description	Part Number	Retail Price
Morris® 8000XL Series, 9000 Series	Meter Housing Stainless Steel Includes Clamping Bracket, Shut-Off Gates, Mounting Hardware and Seals	AMN40671	\$ 3492.19













Air System Parts—Distributors, Plenums and Tubes

Application	Description	Part Number	Retail Price
 Case IH® 3380, 3430, 3580, ADX3360, ADX3380, ADX3430, Flexi-Coil® 3450, 3850, 4350, New Holland® P1050, P1060, P1070, SC380, SC430	Transition Y Tube Converts 3 Tank Cart to Fixed Single Shoot Replaces the three outlet valve. Will also require AMX55109 Transition Y Tube to use on second tank.	AMX55108	\$ 122.02
 Flexi-Coil® 1330, 1720, 1740, 2320, 2340, 2640, John Deere® 787	Transition Y Tube For Single Shoot Conversion Kit Replaces OEM Plastic Single Shoot or Double Shoot Switch	AMX55106	\$ 123.85
 Flexi-Coil® All Series	Splitter Tube 2 1/2" Inlet to (2) 1 3/4" Outlets	AMX55117	\$ 277.69
 John Deere® 1900, 1910	Double Shoot Air Plenum For Stationary Double Shoot System Replaces AA42574	AMAA48322	\$ 1690.00
 John Deere® 1900, 1910	Pressure Inlet Tube, Stainless Steel 5.50" Long, 2.50" Diameter, 1" Straight Outlet For Two Tank or Third Tank Option w/ Stationary Single Shoot or Double Shoot Manifold Replaces A49581	AMAA57195	\$ 75.00
 John Deere® 1900 Single Shoot to Double Shoot Conversion, 1910	Pressure Inlet Tube, Stainless Steel 5.50" Long, 2.50" Diameter, 1" Angle Outlet For Two Tank or Third Tank Option w/ Stationary Single Shoot or Double Shoot Manifold	AMAA54440	\$ 75.00
 John Deere® 1900, 1910	Seed Delivery Formed Tube Lower Tube For Tow-Behind 350/430 Bushel w/ Stationary Double Shoot Manifold	AMA65658	\$ 169.00
 John Deere® 1900, 1910	Seed Delivery Formed Tube Upper Tube For Tow-Between 195/250 Bushel w/ Stationary Double Shoot Manifold	AMA64943	\$ 169.00
 John Deere® 1900, 1910	Seed Delivery Formed Tube Lower Tube For Tow-Between 195/250 Bushel w/ Stationary Double Shoot Manifold	AMA64944	\$ 169.00
 John Deere® 1900, 1910	Seed Delivery Formed Tube Upper Tube For Tow-Behind 195/250 Bushel w/ Stationary Double Shoot Manifold	AMA65140	\$ 169.00
 John Deere® 1900, 1910	Seed Delivery Formed Tube Lower Tube For Tow-Behind 195/250 Bushel w/ Stationary Double Shoot Manifold	AMA65141	\$ 169.00
 John Deere® 1900, 1910	Seed Delivery Formed Tube Upper Tube For Tow-Between 270 Bushel w/ Stationary Double Shoot Manifold	AMA65344	\$ 169.00















Commodity Cart Parts

Planter & Grain Drill Parts

Commodity Cart Parts

	Application	Description	Part Number	Retail Price
	John Deere® 1900 BSN 655263, 1910	Seed Delivery Formed Tube For Tow-Behind 195/250 Bushel w/ Stationary Single Shoot Manifold Replaces A60261	AMA63082	\$ 169.00
	John Deere® 1900, 1910	Seed Delivery Formed Tube Upper Tube For Tow-Behind 270/340 Bushel w/ Stationary Double Shoot Manifold	AMA65347	\$ 169.00
	John Deere® 1900, 1910	Seed Delivery Formed Tube Upper Tube For Tow-Behind 350/430 Bushel w/ Stationary Double Shoot Manifold	AMA65348	\$ 169.00
	John Deere® 1900, 1910	Seed Delivery Formed Tube Lower Tube For Tow-Between 270 Bushel w/ Stationary Double Shoot Manifold	AMA65656	\$ 169.00
	John Deere® 1900, 1910	Seed Delivery Formed Tube Lower Tube For Tow-Behind 270/340 Bushel w/ Stationary Double Shoot Manifold	AMA65657	\$ 169.00
	John Deere® 1900 BSN 685413, 1910	Seed Delivery Formed Tube For Tow-Between 270/340 Bushel w/ Stationary Single Shoot Manifold Replaces A59204	AMA63186	\$ 169.00
	John Deere® 1900 BSN 655263, 1910	Seed Delivery Formed Tube For Tow-Behind 270/340 Bushel w/ Stationary Single Shoot Manifold Replaces A60259	AMA63192	\$ 169.00
	John Deere® 1900 BSN 655263, 1910* *All Ground Drive or 430 Bushel BSN 770101 w/ Hydraulic Drive or All 350 Bushel w/ Hydraulic Drive	Seed Delivery Formed Tube For Tow-Behind 350/430 Bushel w/ Stationary Single Shoot Manifold Replaces A60257	AMA63190	\$ 169.00
	John Deere® 1900, 1910	Seed Delivery Straight Tube 29.88" Long Third Tank Option for Stationary Single Shoot and Lower Tube for Double Shoot Manifold	AMA59347	\$ 52.00
	John Deere® 1900, 1910	Seed Delivery Straight Tube 28.937" Long Third Tank Option for Stationary Single Shoot and Upper Tube for Double Shoot Manifold	AMA59348	\$ 52.00
	John Deere® 1900, 1910* *Ground Drive - Lower for Double Shoot Manifold or Hydraulic Drive and Upper for Double Shoot Manifold	Seed Delivery Straight Tube 47.638" Long For Stationary Double Shoot Manifolds	AMA59346	\$ 85.00
	John Deere® 1900, 1910* *Will fit a 1910 if the Commodity Cart fits one of the following criteria: - Ground Drive, Liquid Option - 340/430 Bushel Tow-Behind and 430 Bushel Tow-Between - Hydraulic Drive - 430 Bushel Tow-Between	Seed Delivery Straight Tube Upper Tube 69.291 Long For Stationary Double Shoot Manifold	AMA86913	\$ 69.00
	John Deere® 1900, 1910* *Will fit a 1910 if the Commodity Cart fits one of the following criteria: - Ground Drive, Liquid Option - 430 Bushel Tow-Between and 340/430 Tow-Behind - Hydraulic Drive - 430 Bushel Tow-Between and 340/430 Tow-Behind w/ Stationary Single Shoot Manifold - Hydraulic Drive - 430 Bushel Tow-Between w/ Double Shoot Manifold	Seed Delivery Straight Tube 70.276" Long Lower Tube for Double Shoot Manifold	AMA86914	\$ 69.00

Planter & Grain Drill Parts



	Application	Description	Part Number	Retail Price
	John Deere® 1900, 1910 - w/ Stationary Single Shoot and Double Shoot Manifolds	Seed Delivery Straight Tube 48.58" Long, 4" Diameter For Stationary Single Shoot and Upper Tube for Double Shoot Manifold	AMA59345	\$ 85.00
	John Deere® 1910 ASN 740100 w/ Ground Drive	Manifold Tube Use w/ Stationary Single Shoot or Double Shoot Manifold For New Style Tower Replaces A89483	AMAA76331	\$ 180.00
	John Deere® 1910* *Hydraulic Drive BSN 770101 w/ Single Shoot Manifold or All w/ Double Shoot Manifold	Seed Delivery Formed Tube Upper Tube for Double Shoot Manifold For Tow-Behind 550 Bushel	AMA92245	\$ 169.00
	John Deere® 1910* *All Ground Drive or 430 Bushel BSN 770101 w/ Hydraulic Drive or All 350 Bushel w/ Hydraulic Drive	Seed Delivery Formed Tube For Tow-Between 350/430 Bushel w/ Stationary Single Shoot Manifold	AMA88195	\$ 169.00
	John Deere® 1910	Seed Delivery Formed Tube Upper Tube For Tow-Between 350/430 Bushel w/ Stationary Double Shoot Manifold	AMA88196	\$ 169.00
	John Deere® 1910	Seed Delivery Formed Tube Lower Tube For Tow-Between 350/430 Bushel w/ Stationary Double Shoot Manifold	AMA88197	\$ 169.00
	John Deere® 1910 Hydraulic Drive	Seed Delivery Formed Tube Lower Tube For Tow-Behind 550 Bushel w/ Stationary Double Shoot Manifold	AMA92243	\$ 169.00
	John Deere® 1910 Hydraulic Drive ASN 770100	Seed Delivery Formed Tube Lower Tube For Tow-Behind 550 Bushel w/ Stationary Double Shoot Manifold	AMA99547	\$ 169.00
	John Deere® 1910 Hydraulic Drive ASN 770100 w/ Single Shoot or Double Shoot Manifold	Seed Delivery Formed Tube Upper Tube for Double Shoot Manifold For Tow-Behind 550 Bushel	AMA99546	\$ 169.00
	John Deere® 1910 Hydraulic Drive	Seed Delivery Straight Tube Lower Tube For Tow-Between 350/430 Bushel w/ Stationary Double Shoot Manifold	AMA92238	\$ 62.00
	John Deere® 1910 Hydraulic Drive	Seed Delivery Straight Tube Lower Tube 42.972" Long For Tow-Behind 550 Bushel w/ Stationary Single Shoot or Double Shoot Manifold	AMA92241	\$ 62.00
	John Deere® 1910 Hydraulic Drive	Seed Delivery Straight Tube, Stainless Steel 42.972" Long, 3" Diameter For 550 Bushel Tow-Behind (16) Required	AMA99255	\$ 163.00
	John Deere® 1910 Hydraulic Drive	Seed Delivery Straight Tube, Stainless Steel Upper Tube for Double Shoot Manifold 42.028" Long, 3" Diameter For 550 Bushel Tow-Behind (16) Required	AMA99256	\$ 163.00
	John Deere® 1910 Hydraulic Drive	Straight Tube Bushing, Stainless Steel 5.50 Long, 2.50" Diameter For Two Tank or Third Tank Option	AMA72998	\$ 17.00
	Morris® All Series	Flat Distributor, 7 Outlet	AMN31187	\$ 416.54
	Morris® All Series	Flat Distributor, 8 Outlet	AMN31188	\$ 424.95
	Morris® All Series	Flat Distributor, 9 Outlet	AMN31189	\$ 433.37
	Morris® All Series	Flat Distributor, 10 Outlet	AMN31190	\$ 441.78

Commodity Cart Parts

Planter & Grain Drill Parts



Application	Description	Part Number	Retail Price
Morris® All Series	Flat Distributor, 11 Outlet	AMN42274	\$ 450.20
Morris® 6240, 6300	Seed Delivery Formed Tube	AMN21235	\$ 165.77
Morris® 7000 Series Tow-Between, 8370 Double Shoot	Seed Delivery Formed Tube, Stainless Steel 31.125" Long	AMN28825	\$ 40.76
Morris® 7130, 7180 Tow-Behind	Seed Delivery Formed Tube, Stainless Steel 79" Long	AMN27330	\$ 178.40
Morris® 7130, 7180 Tow-Between, 7252	Seed Delivery Formed Tube, Stainless Steel 43.75" Long	AMN27045	\$ 165.77
Morris® 7240 Tow-Between	Seed Delivery Formed Tube, Stainless Steel 55.75" Long	AMN27050	\$ 155.68
Morris® 7240, 7300 Tow-Behind	Seed Delivery Formed Tube, Stainless Steel 112.00" Long	AMN27345	\$ 197.75
Morris® 7252 Tow-Behind	Seed Delivery Formed Tube, Stainless Steel 47 29/32" Long	AMN31536	\$ 165.77
Morris® 7252 Tow-Between	Seed Delivery Formed Tube, Stainless Steel 57" Long	AMN31537	\$ 74.35
Morris® 7252 Tow-Between, Double Shoot	Seed Delivery Formed Tube, Stainless Steel 87" Long	AMN31539	\$ 113.48
Morris® 8240, 8300, 8336	Seed Delivery Formed Tube, Stainless Steel	AMN36281	\$ 165.77
Morris® 8336	Seed Delivery Formed Tube, Stainless Steel	AMN36283	\$ 165.77
Morris® 8370	Seed Delivery Formed Tube, Stainless Steel	AMN37794	\$ 165.77
Morris® 8370	Seed Delivery Formed Tube, Stainless Steel	AMN37796	\$ 165.77
Morris® 8370	Seed Delivery Formed Tube, Stainless Steel	AMN37875	\$ 165.77
Morris® 8630	Seed Delivery Formed Tube, Stainless Steel	AMN42531	\$ 165.77
Morris® 8630	Seed Delivery Formed Tube, Stainless Steel 63.25" Long	AMN44574	\$ 82.49
Morris® 8630	Seed Delivery Formed Tube, Stainless Steel 39.50" Long	AMN45185	\$ 51.52
Morris® 8630	Seed Delivery Formed Tube, Stainless Steel 23" Long	AMN45190	\$ 30.00

Air System Parts—Manifold Components

Application	Description	Part Number	Retail Price
 Case IH® 2230, (2280, 2330 - Two Tank), (3380, 3430 - Three Tank), 3580, ADX2180, ADX2230, ADX3260, ADX3360, ADX3380, ADX3430, Flexi-Coil® 1740, 2340, 2640, (2850, 3350 - Two Tank), (3174, 3234 - Third Tank on 40 Series Cart), 3450, 3850, 4350 Three Tank, New Holland® (P1030, P1040 - Two Tank), (P1050, P1060 - Three Tank), P1070, SC180, SC230, SC260, SC380, SC430	Center Manifold Outlet	AMGL-443	\$ 206.38
 Case IH® 2230, 2280 Two Tank, 2330, (3380, 3430, 3450 - Three Tank), 3580, ADX2180, ADX2230, ADX3260, ADX3360, ADX3380, ADX3430, Flexi-Coil® 1740, 2340, 2640, (2850, 3350 - Two Tank), (3174, 3234 - Third Tank on 40 Series Cart), 3450, 3850, 4350, New Holland® (P1030, P1040 - Two Tank), (P1050, P1060 - Third Tank), P1070, SC180, SC230, SC260, SC380, SC430	Center Mount Transition Manifold	AMGL-442	\$ 123.70

















Planter & Grain Drill Parts

Commodity Cart Parts

















	Application	Description	Part Number	Retail Price
	Case IH® 2230, 2280, 2330, 3380, 3430, 3580, ADX2180, ADX2230, ADX3260, ADX3360, ADX3380, ADX3430, Flexi-Coil® 1740, 2340, 2640, 2850, (3174, 3234 - Third Tank on 40 Series Cart), 3350, 3450, 3850, 4350, New Holland® P1030, P1040, P1050, P1060, P1070, SC180, SC230, SC260, SC380, SC430	Intermediate Manifold Upper Manifold for Double Shoot or Triple Shoot Option	AMGL-448	\$ 517.52
	Case IH® 2280, 2330, Flexi-Coil® 2850, 3350, New Holland® P1030, P1040	Center Manifold For 2 Tank Setup w/ Hydraulic Lift	AM87616668	\$ 1809.89
	Case IH® 2280, 2330, 3380, 3430, 3580, ADX3360, ADX3380, ADX3430, Flexi-Coil® 2850, 3350, 3450, 4350, New Holland® P1030, P1040, P1050, P1060, P1070, SC380, SC430	Intermediate Manifold Lower Manifold	AMGL-447	\$ 559.59
	Case IH® (2280, 2330 - Two Tank), (3380, 3430 - Three Tank), 3580, ADX3360, ADX3380, ADX3430, Flexi-Coil® (2850, 3350 - Two Tank), 3450, (3850, 4350 - Three Tank), New Holland® (P1050, P1060 - Three Tank), P1070, SC380, SC430"	Center Manifold Carrier Bracket	AMGL-444	\$ 315.56
	Case IH® 2330, 3380, 3430, 3580, ADX3360, ADX3380, ADX3430, Flexi-Coil® 2850, 3350, 3450, 3850, 4350, New Holland® P1030, P1040, P1050, P1060, P1070, SC380, SC430	Intermediate Manifold Bracket	AMX55107	\$ 605.87
	Case IH® (3380, 3430 - Three Tank), ADX3360, ADX3380, ADX3430, Flexi-Coil® (3450, 3850 - Three Tank), New Holland® (P1050, P1060 - Three Tank), SC380, SC430	Center Manifold For Double Shoot Manifold	AMGL-440	\$ 1893.35
	Case IH® (3380, 3430 - Three Tank), ADX3360, ADX3380, ADX3430, Flexi-Coil® (3450, 3850 - Three Tank), New Holland® (P1050, P1060 - Three Tank), SC380, SC430	Center Manifold For Triple Shoot Manifold	AMGL-441	\$ 1220.16
	Flexi-Coil® 1100, 1110	Bypass Manifold For 5 Run System w/ Double Shoot Manifold	AMGD-233	\$ 312.36
	Flexi-Coil® 1100, 1110, 1115	Rear Manifold Assembly For 5 Run System	AMGD-229	\$ 327.62
	Flexi-Coil® 1100, 1110, 1115	Front Manifold Assembly For 5 Run System	AMGD-232	\$ 327.62
	Flexi-Coil® 1100, (1110, 1115 - w/ Double Shoot Manifold), (1610 Plus, 1615 Plus - w/ Double Shoot Diverter Valve Option)	Bypass Manifold For 3 Run System	AMGD-148	\$ 249.53
	Flexi-Coil® 1100, (1110, 1115 - w/ Double Shoot Manifold), (1610 Plus, 1615 Plus - w/ Double Shoot Diverter Valve Option)	Bypass Manifold For 4 Run System	AMGD-149	\$ 280.95
	Flexi-Coil® 1100, 1110, 1115, (1610 Plus, 1615 Plus - Tow-Between w/ Double Shoot Diverter Valve Option)	Rear Manifold Assembly For 3 Run System	AMGD-144	\$ 255.81

Prices Subject to Change without Prior Notice. The use of original equipment manufacturer (OEM) part numbers or trademarks, e.g. Case® and John Deere®, are for reference purposes only and for indicating product use and compatibility. Our company and the listed replacement parts contained herein are not sponsored, approved or manufactured by the OEM. All parts are New unless designated Reman in the description.

Planter & Grain Drill Parts





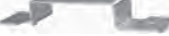









	Application	Description	Part Number	Retail Price
	Flexi-Coil® 1100, 1110, 1115, (1610 Plus, 1615 Plus - Tow-Between w/ Double Shoot Diverter Valve Option)	Rear Manifold Assembly For 4 Run System	AMGD-146	\$ 296.20
	Flexi-Coil® 1100, 1110, 1115, (1610 Plus, 1615 Plus - Tow-Between w/ Double Shoot Diverter Valve Option)	Front Manifold Assembly For 4 Run System	AMGD-147	\$ 296.20
	Flexi-Coil® 1100, 1110, 1115, (610 Plus, 1615 Plus - Tow-Between w/ Double Shoot Diverter Valve Option)	Front Manifold Assembly For 3 Run System	AMGD-145	\$ 255.81
	Flexi-Coil® 1330, 1330 Plus, 1330.B, John Deere® 787 (130 Bushel Cart)	Center Manifold Assembly Replaces NAGH717	AMGH-717	\$ 1174.45
	Flexi-Coil® 1330, 1330 Plus, 1330.B, John Deere® 787 (130 Bushel Cart)	Manifold Transition Channel Replaces NAGH743	AMGH-743	\$ 67.09
	Flexi-Coil® 1330, 1330 Plus, 1330.B, John Deere® 787 (130 Bushel Cart)	Manifold Outlet Channel Replaces NAGH744	AMGH-744	\$ 363.01
	Flexi-Coil® 1600, 1610, 1615, John Deere® 777 (160 Bushel Cart)	Rear Manifold Assembly For 4 Run System Replaces NAGD544	AMGD-544	\$ 281.87
	Flexi-Coil® 1600, 1610, 1615, John Deere® 777 (160 Bushel Cart)	Rear Manifold Assembly For 5 Run System Replaces NAGD546	AMGD-546	\$ 311.76
	Flexi-Coil® 1600, 1610, 1615, John Deere® 777 (160 Bushel Cart)	Rear Manifold Assembly For 6 Run System Replaces NAGD548	AMGD-548	\$ 341.66
	Flexi-Coil® 1600, 1610, 1615, John Deere® 777 (160 Bushel Cart)	Rear Manifold Assembly For 8 Run System Replaces NAGD643	AMGD-643	\$ 371.55
	Flexi-Coil® 1600, 1610, 1615, John Deere® 777 (160 Bushel Cart)	Front Manifold Assembly For 4 Run System Replaces NAGD545	AMGD-545	\$ 281.87
	Flexi-Coil® 1600, 1610, 1615, John Deere® 777 (160 Bushel Cart)	Front Manifold Assembly For 5 Run System Replaces NAGD547	AMGD-547	\$ 311.76
	Flexi-Coil® 1600, 1610, 1615, John Deere® 777 (160 Bushel Cart)	Front Manifold Assembly For 6 Run System Replaces NAGD549	AMGD-549	\$ 341.66
	Flexi-Coil® 1600, 1610, 1615, John Deere® 777 (160 Bushel Cart)	Front Manifold Assembly For 8 Run System Replaces NAGD644	AMGD-644	\$ 371.55
	Flexi-Coil® 1720, 2320, John Deere® 787 Excluding 130 Bushel Cart	Intermediate Manifold Bracket	AMX55105	\$ 614.98
	Flexi-Coil® 1600, 1610, 1615, John Deere® 777 (160 Bushel Cart)	Bypass Manifold For 4 Run System w/ Double Shoot Manifold Replaces NAGH640	AMGD-640	\$ 267.35

Planter & Grain Drill Parts











	Application	Description	Part Number	Retail Price
	Flexi-Coil® 1600, 1610, 1615, John Deere® 777 (160 Bushel Cart)	Bypass Manifold For 5 Run System w/ Double Shoot Manifold Replaces NAGH641	AMGD-641	\$ 297.24
	Flexi-Coil® 1600, 1610, 1615, John Deere® 777 (160 Bushel Cart)	Bypass Manifold For 6 Run System w/ Double Shoot Manifold Replaces NAGH642	AMGD-642	\$ 327.14
	Flexi-Coil® 1720, 2320, John Deere® 787 (Excluding 130 Bushel Cart)	Front Manifold Outlet Channel Replaces NAGH242	AMGH-242	\$ 169.10
	Flexi-Coil® 1720, 2320, John Deere® 787 (Excluding 130 Bushel Cart)	Transition Manifold Top Channel Replaces NAGH209	AMGH-209	\$ 77.69
	Flexi-Coil® 1720, 2320, John Deere® 787 (Excluding 130 Bushel Cart)	Center Manifold Assembly Replaces NAGH172	AMGH-172	\$ 1665.58
	Flexi-Coil® 1720, 2320, John Deere® 787 Excluding 130 Bushel Cart	Intermediate Manifold Replaces NAGH165	AMGH-165	\$ 363.01
	Flexi-Coil® 1720, 2320, John Deere® 787 Excluding 130 Bushel Cart	Double Shoot Intermediate Manifold Upper Manifold For Double Shoot Option Replaces NAGH169	AMGH-169	\$ 363.01
	John Deere® 1900	Stationary Single Shoot Manifold Plate For 6 Run System Use w/ AMAA52645 Bottom Manifold Plate	AMA62025	\$ 248.00
	John Deere® 1900	Double Shoot Manifold Bracket For Stationary Double Shoot Manifold	AMAA60889	\$ 609.00
	John Deere® 1900 Tow-Between	Bottom Manifold Plate For Stationary Single Shoot or Stationary Double Shoot Manifold	AMAA52645	\$ 269.00
	John Deere® 1900 Single Shoot to Double Shoot Conversion, 1910	Bottom Manifold Plate Bracket For Stationary Single Shoot or Stationary Double Shoot Manifold	AMA69543	\$ 23.00
	John Deere® 1900 Single Shoot to Double Shoot Conversion, 1910 BSN 735101 w/ Ground Drive	Double Shoot Manifold Bracket Use w/ AMA69443 Bottom Manifold Plate For Stationary Double Shoot Manifold	AMAA60888	\$ 380.00
	John Deere® 1900 Single Shoot to Double Shoot Conversion, 1910, C650, C850	Manifold Plate Seal	AMA70821	\$ 47.00
	John Deere® 1900, 1910	Manifold Spacer Plate For 4 Run Stationary Single Shoot Manifolds	AMA63064	\$ 121.00
	John Deere® 1900, 1910	Slide Stop Bracket, Right Hand For Stationary Double Shoot or Premium 8 Run Manifold	AMA64920	\$ 55.00
	John Deere® 1900, 1910	Double Shoot Manifold Cover For 6 Run Center Plate	AMAA48755	\$ 142.00
	John Deere® 1900, 1910	Manifold Cover 8 Run Center Cover Plate For Stationary Single Shoot or Stationary Double Shoot Manifolds	AMAA48753	\$ 50.00

Commodity Cart Parts

Planter & Grain Drill Parts

Application	Description	Part Number	Retail Price
 John Deere® 1900, 1910	Slide Stop Bracket, Left Hand For Stationary Double Shoot or Premium 8 Run Manifold	AMAA50030	\$ 53.00
 John Deere® 1900, 1910	Lower Hardware Kit Includes Stainless Steel Hardware for Bottom of Meter and Below Long Carriage Manifold Bolts Not Included For Single Shoot Manifold Systems (1) Required per Tank	AMX55079	\$ 129.87
 John Deere® 1900, 1910	Lower Hardware Kit Includes Stainless Steel Hardware for Bottom of Meter and Below Long Carriage Manifold Bolts Not Included For Double Shoot Manifold Systems (1) Required per Tank	AMX55081	\$ 52.76
 John Deere® 1900, 1910	Manifold Bolt Kit For Double Shoot Manifold (1) Required per Run	AMX55082	\$ 37.16
 John Deere® 1900, 1910* *Will fit a 1910 if the Commodity Cart fits one of the following criteria: - Ground Drive - All Single Shoot Manifold or ASN 735100 w/ Double Shoot Manifold - Hydraulic Drive - All Models	Manifold Spacer Plate	AMA63066	\$ 99.00
 John Deere® 1900, 1910 BSN 735101 w/ Ground Drive	Manifold Spacer Plate For 3 Run Stationary Single Shoot Manifolds	AMA63063	\$ 147.00
 John Deere® 1900, 1910 BSN 735101 w/ Ground Drive	Manifold Spacer Plate For 5 Run Stationary Single Shoot Manifolds	AMA63065	\$ 119.00
 John Deere® 1900, 1910 BSN 735101 w/ Ground Drive	Manifold Spacer Plate For 7 Run Stationary Single Shoot Manifolds	AMA63067	\$ 98.00
 John Deere® 1900, 1910 BSN 735101 w/ Ground Drive	Manifold Spacer Plate Collection Pan Mount, 3 Run to 7 Run For Stationary Single Shoot Manifolds	AMA63068	\$ 77.00
 John Deere® 1900, 1910 Ground Drive	Double Shoot Manifold Cover For 3 Run Center Plate	AMAA48758	\$ 142.00
 John Deere® 1900, 1910 Ground Drive	Double Shoot Manifold Cover For 4 Run Center Plate	AMAA48757	\$ 195.00
 John Deere® 1900, 1910 Ground Drive	Double Shoot Manifold Cover For 5 Run Center Plate	AMAA48756	\$ 121.00
 John Deere® 1900, 1910* *Will fit a 1910 if the Commodity Cart fits one of the following criteria: - Ground Drive - All Single Shoot Manifold or ASN 735100 w/ Double Shoot Manifold - Hydraulic Drive - All Models	Manifold Cover For 7 Run Center Plate	AMAA48754	\$ 84.00
 John Deere® 1900, 1910, C650, C850	Manifold Plate Seal For Stationary Double Shoot Manifolds	AMA64856	\$ 43.00









Planter & Grain Drill Parts

Application	Description	Part Number	Retail Price
 John Deere® 1900, 1910, C650, C850	Manifold Bracket Latch Stainless Steel For Single and Double Shoot Manifolds	AMX55080	\$ 10.80
 John Deere® 1910	Manifold Plate Bracket For Stationary Single Shoot Manifold	AMA72276	\$ 37.00
 John Deere® 1910 ASN 735100 w/ Ground Drive or All w/ Hydraulic Drive	Single Shoot Manifold Plate Use w/ Bottom Cover	AMA88060	\$ 345.00
 John Deere® 1910 ASN 735100 w/ Ground Drive or All w/ Hydraulic Drive	Bottom Cover Plate For Stationary Single Shoot Manifold	AMA88237	\$ 269.00
 John Deere® 1910 ASN 735100 w/ Ground Drive or All w/ Hydraulic Drive	Double Shoot Manifold Bracket Use w/ Bottom Cover For Stationary Double Shoot Manifold	AMAA71722	\$ 340.00
 John Deere® 1910 BSN 735101 w/ Ground Drive	Bottom Manifold Plate For Stationary Single Shoot or Stationary Double Shoot Manifold	AMA69443	\$ 269.00
 John Deere® 1910 Ground Drive	Stationary Single Shoot Manifold Plate	AMA69442	\$ 248.00
 John Deere® 1910 Hydraulic Drive w/ Premium Manifold, C650, C850	Manifold Cover Center Plate Cover	AMAA84236	\$ 22.00
 John Deere® 1910 w/ Hydraulic Drive	Bottom Cover Plate For Premium 8 Run Manifold for 430 Bushel Tow-Between or 430/550 Bushel Tow-Behind	AMA98748	\$ 286.00
 John Deere® 1910 w/ Hydraulic Drive	Premium Double Shoot Manifold Bracket For Premium 8 Run Manifold for 430 Bushel Tow-Between or 430/550 Bushel Tow-Behind	AMAA83284	\$ 372.00
Morris® 6000 Series	Collector Box Manifold Stainless Steel For 6 Run System Includes Mounting Hardware and Seals	AMN19080	\$ 525.93
Morris® 6000 Series	Manifold Cover Stainless Steel For 6 Run System Includes Mounting Hardware and Seals	AMN19289	\$ 290.31
Morris® 6000 Series, 7000 Series	Manifold Cover Stainless Steel For 8 Run System Includes Mounting Hardware and Seals	AMN19693	\$ 332.39
Morris® 6000 Series, 7000 Series	Manifold Stainless Steel For 8 Run System Includes Mounting Hardware and Seals	AMN45125	\$ 660.57
Morris® 8000 Series	Double Shoot Collector Body Stainless Steel For 9 Run System Includes Mounting Hardware and Seals Replaces N36285	AMN37700	\$ 2734.85
Morris® 8000 Series	Manifold Bottom Cover Stainless Steel For 9 Run System Includes Mounting Hardware and Seals	AMX55121	\$ 349.22
Morris® 8000 Series	Single Shoot Manifold Stainless Steel Includes Mounting Hardware and Seals Replaces N36270	AMN47040	\$ 711.06

Commodity Cart Parts

Planter & Grain Drill Parts

Air System Parts—Air Tube Couplers and Components





Application	Description	Part Number	Retail Price
 Case IH® 2230, 2280, 2320, 2330, (2340, 2640, 3380 - Tow-Behind), ADX2180, ADX2230, ADX3260, ADX3360, ADX3380, ADX3430, Flexi-Coil® 1100, 1110, 1115, 1330, (1330 Plus, 1330.B, 1720, 1740, 2340, 2640, 2850, 3350, 4350 - Tow-Behind), 1600, 1610, (1610 Plus, 1615 Plus - Granular Applicator), 1615, 2320, 2330, (3174, 3234 - Tow-Behind or Third Tank on 40 Series Cart), New Holland® P1030, P1040, P1050, P1060, SC180, SC230, SC260, SC380, SC430	Quick Connect Coupler Assembly, Applicator Side 3 Port Coupler	AMGD-672A	\$ 168.75
 Case IH® 2230, 2280, 2330, 3380, 3430, ADX2180, ADX2230, ADX3260, ADX3360, ADX3380, ADX3430, New Holland® P1030, P1040, P1050, P1060, SC180, SC230, SC260, SC380, SC430	Riser Tube w/ Flange	AMGP-103	\$ 209.40
 Case IH® (2230, 2280, 2330, 3380, ADX2180, ADX3260, ADX3360, ADX3380, ADX3430 - Tow-Behind), 2320, Flexi-Coil® 1100, 1110, 1115, 1330, (1330 Plus, 1330.B, 1740, 2330, 2340, 2640, 2850, 3350, 4350 - Tow-Behind), 1600, 1610, 1615, 1720, 2320, (3174, 3234 - Tow-Behind or Third Tank on 40 Series Cart), New Holland® (P1030, P1040, P1050, P1060, SC180, SC230, SC260, SC380, SC430 - Tow-Behind)	Quick Connect Coupler Assembly, Cart Side 3 Port Coupler	AMGD-673	\$ 155.81
 Flexi-Coil® All Series	Air Hose Coupling, Applicator Side 4 Port Coupler Does not seal w/ the OEM Coupler Replace both Applicator Side and Cart Side Couplers. AMX55112 Coupler Sold Separately.	AMX55111	\$ 170.16
 Flexi-Coil® All Series	Air Hose Coupling, Applicator Side 5 Port Coupler Does not seal w/ the OEM Coupler Replace both Applicator Side and Cart Side Couplers. AMX55115 Coupler Sold Separately.	AMX55114	\$ 171.56
 Flexi-Coil® All Series	Air Hose Coupling, Cart Side 4 Port Coupler Does not seal w/ the OEM Coupler Replace both Applicator Side and Cart Side Couplers. AMX55111 Coupler Sold Separately.	AMX55112	\$ 156.86
 Flexi-Coil® All Series	Air Hose Coupling, Cart Side 5 Port Coupler Does not seal with w/ OEM Coupler Replace both Applicator Side and Cart Side Couplers. AMX55114 Coupler Sold Separately.	AMX55115	\$ 157.91
 Flexi-Coil® All Series	Air Hose Coupling Kit Includes (2) 4 Port Couplers	AMX55113	\$ 314.44
 Flexi-Coil® All Series	Air Hose Coupling Kit Includes (2) 5 Port Couplers	AMX55116	\$ 319.77

Commodity Cart Parts

Planter & Grain Drill Parts

	Application	Description	Part Number	Retail Price
	Flexi-Coil® 1100, 1110, 1115, 1330, (1330 Plus, 1330.B, 1720, 1740, 2330, 2340, 2640, 2850, 3350, 4350 - Tow-Behind), 1600, 1610, 2320, (3174, 3234 - Tow-Behind or Third Tank on 40 Series Cart), New Holland® (P1030, P1040, P1050, P1060, SC180, SC230, SC260, SC380, SC430 - Tow-Behind)	Air Hose Coupling Kit Stainless Steel Includes (2) 3 Port Couplers	AMX55110	\$ 309.10
	John Deere® 1900, 1910	Air Hose Coupling, Applicator Side (2) Port Reversible Coupler for 2 1/2" Tubes	AMX55084	\$ 153.86
	John Deere® 1900, 1910 Ground Drive	Air Hose Coupling, Applicator Side (2) Port Coupler for 2 1/2" Tubes Replaces A65280	AMA82371	\$ 134.41
	John Deere® 1900, 1910	Air Hose Coupling, Cart Side (2) Port Reversible Coupler for 2 1/2" Tubes	AMX55085	\$ 128.01
	John Deere® 1900 Tow-Between, (1910 Ground Drive, Tow-Between)	Air Hose Coupling, Cart Side 2 Port Coupler for 2 1/2" Tubes Replaces A60698, AA49380, AA65241	AMAA67121	\$ 128.01
	John Deere® 1900, 1910	Air Hose Coupling Kit Includes (2) 2 Port Reversible Couplers for 2 1/2" Tubes	AMX55083	\$ 281.87
	John Deere® 1900, 1910 Ground Drive	Air Hose Coupling Kit Includes (2) 2 Port Couplers for 2 1/2" Tubes Replaces A60698, A65280, A82371, AA49380, AA65241, AA67121	AMX55127	\$ 251.00
	John Deere® 1910	Distributor Wear Cap Stainless Steel Extends Life of Distributor Covers Fits in John Deere® Cover AA73954	AMX55092	\$ 24.77
	Morris® All Series	Air Hose Coupling Kit Stainless Steel 4 Port Coupler Assembly	AMX55122	\$ 245.54









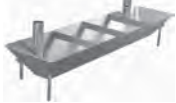

Conveyor Components

	Application	Description	Part Number	Retail Price
	John Deere® 1910 Ground Drive	Conveyor Housing Assembly For 350 or 430 Bushel Includes Upper and Lower Housings Replaces AA54917, AA72953	AMX55126	\$ 7284.15
	John Deere® 1910 Ground Drive	Conveyor Housing Assembly For 195, 250, 270 or 340 Bushel Includes Upper and Lower Housings Replaces AA54916, AA55555, AA57798	AMX55125	\$ 7101.93
	John Deere® 1910	Conveyor Rubberized Drive Roller	AMAA57010	\$ 853.29
	John Deere® 1910	Conveyor Roller	AMAA54920	\$ 561.12

Prices Subject to Change without Prior Notice. The use of original equipment manufacturer (OEM) part numbers or trademarks, e.g. Case® and John Deere®, are for reference purposes only and for indicating product use and compatibility. Our company and the listed replacement parts contained herein are not sponsored, approved or manufactured by the OEM. All parts are New unless designated Reman in the description.

Planter & Grain Drill Parts

Ladders and Components

	Application	Description	Part Number	Retail Price	Wholesale
	John Deere® 1900	Ladder Extension Set Set of 2 Required when replacing AA48072 Ladder Bracket w/ AMAA85578 Lower Inside Tank Ladder Bracket	AMX55074	\$ 76.87	\$ 69.26
	John Deere® 1900 ASN 685195 for Tow-Behind or ASN 685240 for Tow-Between, 1910	Lower Inside Tank Ladder Bracket Chute Weldment Bracket Replaces AA47638	AMAA85578	\$ 706.00	\$ 630.14
	John Deere® 1910, C650, C850	Lower Ladder Bracket Chute Weldment Bracket for 550 Bushel Replaces AA78276	AMAA85582	\$ 706.00	\$ 630.14
	John Deere® 1900, 1910	In-Tank Isolator Seal	AMA70517	\$ 329.00	\$ 293.31
	John Deere® 1900, 1910	Sensor Mount and Cover Kit Middle Includes Stainless Steel Hardware	AMX55089	\$ 150.51	\$ 135.59
	John Deere® 1900, 1910	Top Ladder and Lid Mounting Kit Includes Stainless Steel Hardware	AMX55088	\$ 423.08	\$ 381.16
	John Deere® 1900, 1910, C650, C850	Upper Hardware Kit Stainless Steel Hardware Included for Top of Meter and Above (1) Require per Tank	AMX55076	\$ 80.86	\$ 72.85
	John Deere® 1900 Tow-Between, 1910	Tank Ladder For 350/430 Bushel Rear Tank or 550 Bushel Front/Rear Tank 200 Bushel Tank Replaces AA46285	AMAA50079	\$ 795.78	\$ 716.92
	John Deere® 1900 Tow-Between, 1910	Tank Ladder For 350/430 Bushel Front Tank 150 Bushel Tank Replaces AA46286	AMAA50080	\$ 795.78	\$ 716.92
	John Deere® 1900 Tow-Between, 430 Bushel 3rd Tank, 1910	Tank Ladder For 430 Bushel Center Tank 80 Bushel Tank Replaces AA46289	AMAA50083	\$ 1436.78	\$ 1294.39

Tank and Hopper Components

	Application	Description	Part Number	Retail Price
	Flexi-Coil® 3450, 3850, 4350	Tank Mounting Cradle	AMGL-606	\$ 1556.76

Skid Steer Parts

Table of Contents

Air Cleaner Components	178	Glass	186
Air Conditioning and Components	187	Hydraulic Components	183
Alternators	177	Hydraulic Oil Coolers	181
Attachments	194	Hydrostatic Drive Components	179
Axles and Components	178	Injectors	174
Balancer Shafts	167	Lighting	183
Belts	193	Longblock Assemblies	166
Cab Components—Miscellaneous	185	Manifolds	174
Camshafts and Lifters	167	Mufflers and Exhaust	175
Carburetors	173	Oil Coolers, Engine	168
Connecting Rods	167	Oil Pumps, Engine	168
Crankshaft Pulleys	167	Radiator Hoses and Thermostats	170
Crankshafts	166	Radiators	168
Cylinder Heads, Bare	168	Sensors	178
Cylinders	182	Starters	175
Fan Clutches	173	Turbochargers and Components	174
Fuel Components	187	Water Pumps and Components	171
Fuel Lift Pumps	173		
Gas Struts	187		

Longblock Assemblies

Application	Description	Part Number	Retail Price	Core
Case® 60XT, 70XT, 75XT, 85XT, 1840, 1845C	Longblock Assembly Externally Balanced	LBCUM3.9-N	\$ 5100.00	\$ 1000.00
	Reman Longblock Assembly 4-Bolt Injection Pump Mount	LBCUM3.9TA-4B	\$ 5100.00	\$ 1000.00
Case® 90XT, 95XT	Longblock Assembly Externally Balanced	LBCUM3.9TA-N	\$ 5100.00	\$ 1000.00



Crankshafts

Application	Description	Part Number	Retail Price	Core
Case® 1845 Replaces 976321, A39151, G11740, G11741	Crankshaft 188 4 Cylinder Diesel Engine 4.125" Stroke, 3.811" - 3.812" Bore, 2.0605" - 2.0615" Rod, 2.873" - 2.874" Main Flange - No Centering Ring, 4 Bolt Holes, Splined, Pilot Hole has 13 Splines Snout - Threaded, 2 Keyways	AMA151015	\$ 575.00	
Case® 1845 Replaces A39151, A76321, A151015, G11740, G11741	Crankshaft 188 4 Cylinder Engine 4.125" Stroke, (Diesel) 3.811" - 3.812", (Gas) 3.813" - 3.8145" Bore, - 2.0605" - 2.0615" Rod, 2.873" - 2.874" Main Flange - No Centering, Flat, 4 Bolt Holes, w/ Bushing Snout - Threaded, 2 Keyways This Crankshaft is not Splined in Pilot Hole	AMA39150	\$ 575.00	

Skid Steer Parts

Application	Description	Part Number	Retail Price	Core
Ford®/New Holland® L783, L785 Replaces C5NE6303N, E5NN6306N	Crankshaft BSD333 4.4 Stroke 201 CID 3.3 Liter 3 Cylinder Engine 4.400" Stroke, 4.4007" - 4.4032" Bore, 2.7496" - 2.7504" Rod, 3.3713" - 3.3723" Main Flange - 6 Bolt Holes, 1 Dowel Hole, Centering Ring Snout - Keyed, 1 Bolt Hole	AMFONN6303MA	\$ 415.00	
John Deere® 240, 250, 260, 8875 - w/ 3029D or 3029T 2.9L PowerTech™ Engine	Crankshaft, Cast	AMRE50979	\$ 750.00	
John Deere®: 260, 270, 280 Replaces R113596, RE50618	Crankshaft 4.5 PowerTech™ Straight Nose 4 Cylinder Engine 5" Stroke, 4.192" - 4.194" Bore, 3.063" - 3.064" Rod, 3.123" - 3.124" Main Flange - No Centering Ring, Flat, 4 Bolt Holes, 1 Dowel Hole Snout - Straight, 4 Bolt Holes, 1 Keyway, w/ 30 Tooth Helical Timing Gear	AMRE504638	\$ 775.00	
John Deere® 4475, 5575	Crankshaft	AMAM880894	\$ 729.00	

Connecting Rods

Application	Description	Part Number	Retail Price	Core
John Deere® 270, 280	Connecting Rod 1.375" Pin Diameter Replaces RE60272	AMRE500002	\$ 90.00	

Crankshaft Pulleys

Application	Description	Part Number	Retail Price	Core
John Deere® 313, 315, 317, 318D, 320, 320D, 325, 326D, 328, 328D, 332, 332D, Track Skid Steer Loaders: 319D, 323D, 329D, 333D, CT315, CT322, CT332	Crankshaft Pulley w/ Sleeve	AMRE520244	\$ 32.41	

Camshafts and Lifters

Application	Description	Part Number	Retail Price	Core
Case® 40XT, 60XT, 70XT, 75XT, 85XT, 90XT, 95XT	Camshaft 3.9 Cummins® Engine	AMJ929039	\$ 95.00	
Case® 60XT, 70XT, 75XT, 85XT, 90XT, 1840, 1845	Rocker Arm Assembly 3.9 and 5.9 Cummins® Engines Replaces J922488	AMJ910814	\$ 40.00	
New Holland® L779, L783	Lifter w/o Adjusting Screw Replaces 957E6489, 731150M1, 731150V1, 860012, 81804255	AM0860012	\$ 4.65	
John Deere® 270, 280	Camshaft Replaces R135439	AMRE56375	\$ 255.00	
John Deere® 270, 280	Lifter 4.5, 6.8 PowerTech™ Engine	AMR123565	\$ 7.19	
John Deere® 4475, 5575	Camshaft	AMAM876430	\$ 187.15	
John Deere® 314G ASN G298751, 318E, 319E, 320E, 320G, 323E, 324E, 324G, 325G, 326E, 4475, 5575, 6675, 7775	Lifter	AMM801046	\$ 10.00	

Balancer Shafts

Application	Description	Part Number	Retail Price	Core
John Deere® 270, 280	Balancer Shaft Replaces RE69364	Right Hand AMRE500448	\$ 120.00	

Prices Subject to Change without Prior Notice. The use of original equipment manufacturer (OEM) part numbers or trademarks, e.g. Case® and John Deere®, are for reference purposes only and for indicating product use and compatibility. Our company and the listed replacement parts contained herein are not sponsored, approved or manufactured by the OEM. All parts are New unless designated Reman in the description.

Skid Steer Parts

Cylinder Heads, Bare

Application	Description	Part Number	Retail Price	Core
Case® 40XT, 75XT, 85XT, 1840, 1845C	Valve Train Kit Includes (4) Exhaust Valves, (4) Intake Valves, (8) Valve Springs, 0.16" Wire Diameter, (16) Valve Keepers Replaces K3802356, K3900250, K3932453	AMVK1040	\$ 107.00	
Ford®/New Holland® L783, L785	Valve Train Kit Includes (3) Exhaust Valves, 5.766" Long, 45°, (3) Intake Valves, 5.746" Long, 45°, (6) Valve Springs, (6) Valve Spring Retainers, (6) Valve Spring Retainer Sleeves, (12) Valve Keepers, and (6) Valve Seals	AMVK1045	\$ 107.00	

Oil Pumps, Engine

Application	Description	Part Number	Retail Price	Core
Case® 430 BSN N7M479683, 440, 445 BSN N7M454787, 450, 465, Track Skid Steer Loaders: 440CT, 445CT BSN N8M458846, 450CT - All w/ N45 Fiat® Diesel Engine	Engine Oil Pump	AM4897480	\$ 129.60	
John Deere® (240, 250 BSN 936967), 260 Early, 8875	Oil Pump Repair Kit Includes (2) Oil Tubes and (2) O-Rings Marked R54615 Replaces DD14760, RE35685	AMRE52020	\$ 131.00	
John Deere® (240, 250 ASN 936966), 260 Late	Engine Oil Pump Marked RE515079	AMRE515746	\$ 365.76	
John Deere® 240, 250, 260, 8875	Oil Pump Drive Gear 33 Tooth, 0.55" ID, 3.625" OD	AMT20298	\$ 160.56	
John Deere® 314G ASN G298751, 4475, 5575, 6675, 7775	Engine Oil Pump	AMAM878778	\$ 133.00	
John Deere® 318E, 319E, 320E, 320G, 323E, 324E, 324G, 325G, 326E	Engine Oil Pump	AMMIA882626	\$ 119.00	
New Holland® L865, LS180, LS190, LX865, LX885, LX985	Engine Oil Pressure Switch	AM9847720	\$ 31.68	

Oil Coolers, Engine

Application	Description	Part Number	Retail Price	Core
Bobcat® 863, 864, 873 (SN 514111516-514123935 & ASN 51421107)	Oil Cooler Overall: 14 1/2" x 24 1/2" x 2 1/2"	AM6710791	\$ 355.00	
Case® 440 ASN N8M474469, 450, 465, Track Skid Steer Loaders: 440CT ASN N7M483467, 450CT, New Holland® L190 ASN N7M459485, Track Skid Steer Loader: C190 ASN N7M457280	Oil Cooler N45 Fiat Diesel, 5 Fin	AM2853722	\$ 139.54	
John Deere® 313, 315, 317, 318D, 320, 320D, 325, 326D, 328, 328D, 332, 332D, Track Skid Steer Loaders: 319D, 323D, 329D, 333D, CT315, CT322, CT332	Oil Cooler, 9 Plate	AMRE515469	\$ 188.95	
John Deere® 317, 320, 325, 328, 332, Track Skid Steer Loaders: CT322, CT332	Oil Cooler Hose	AMR516071	\$ 12.44	

Radiators

Application	Description	Part Number	Retail Price	Core
Bobcat® 463, 553AF, S70	Radiator Overall: 27 3/4" x 10 1/4" x 2 1/2" Core: 9 1/4" x 23" x 2 1/2" Replaces 709566, 6678820	AM6672455	\$ 380.00	
Bobcat® 642, 642B, 643, 722, 742, 742B, 743	Radiator Overall: 30 1/2" x 12 1/8" x 3" Core: 24 5/8" x 11 1/2" x 3" 4 Row, 6 Fins per Inch	AM6571713	\$ 350.00	

Prices Subject to Change without Prior Notice. The use of original equipment manufacturer (OEM) part numbers or trademarks, e.g. Case® and John Deere®, are for reference purposes only and for indicating product use and compatibility. Our company and the listed replacement parts contained herein are not sponsored, approved or manufactured by the OEM. All parts are New unless designated Reman in the description.

Skid Steer Parts

Application	Description	Part Number	Retail Price	Core
Bobcat® 645, 743, 743B, 743DS	Radiator Overall: 35 1/4" x 12 1/4" x 2 3/4" Core: 30 1/4" x 11 1/2" x 2 3/4" 4 Row, 6 Fins per Inch	AM6648820	\$ 430.00	
Bobcat® 653, 751, 751F, 751G, 753C, 753F, 753G, 753H, 753HC, 753L, 763, 763C, 763H, 763HC, 763HF, 763HG, 773, 773C, 773F, 7753, S130G	Radiator Overall: 32" x 12 1/2" Core: 26 1/8" x 12" x 2 1/16" 4 Rows	AM6666384	\$ 355.00	
Bobcat® 733G, 773, 773G, S150, S160, S175, S185, S175G, S185G, T190, T190G	Radiator Overall: 31" x 13 5/8" Core: 12 5/8" x 27" x 2 5/8" 4 Rows, 16 Fins per Inch Replaces 6685733	AM6718648	\$ 390.00	
Bobcat® 773T, A300, S220, S250, S300, S330, T250, T300, T320	Radiator Overall: 33 1/4" x 16 1/2" Core: 27 1/2" x 15 1/4" x 2" 3 Rows, 13 Fins per Inch Replaces 6684367, 6737658, 7173921	AM6737650	\$ 350.00	
Bobcat® S150, S150G, S160, S160G, S175, S185, S205, T180, T180G, T190, TB85, TB90, TB100, TB110, TB120	Radiator Overall: 31" x 13 5/8" Core: 12 5/8" x 27" x 2 5/8" 4 Row, 14 Fins per Inch	AM6686077	\$ 332.00	
Bobcat® S510, S530, S550, S570, S590	Radiator Overall: 20 7/8" x 21 3/8" x 3"	AM7025613	\$ 480.00	
Bobcat® S750, S770	Radiator, Stud Mounted Replaces 4222868, 7024102, 7204653	AM7025103	\$ 450.00	
Bobcat® S850, T870	Radiator Overall: 20 7/8" x 24" x 4 1/8"	AM7025105	\$ 525.00	
Case® 85XT, 90XT, 95XT - w/ Diesel	Radiator Overall: 26 1/8" x 21 1/4" x 3 1/4"	AM237992A3	\$ 495.00	
Case® 410, 420, 420CT, 430, 435, 440, 440CT, 445, 445CT, 450, 450CT, 465, New Holland® C175, C185, C190, L175, L180, L185 2007-12/07, L190, LS180.B, LS185.B, LS190.B, Track Skid Steer Loaders: LT185.B, LT190.B	Radiator Overall: 25 1/2" x 21 1/2" x 2 1/2"	AM87013856	\$ 400.00	
Case® 410 ASN N7M480924, 420 ASN N7M466710, 430 ASN N7M479683, 435 ASN N7M425032, 440 ASN N8M474469, 445 ASN N7M454787, 450 ASN N7M464019, 465 ASN N8M452623, Track Skid Steer Loaders: 420CT ASN N7M455401, 440CT ASN N7M483467, 445CT ASN N8M458846, 450CT ASN N7M464019	Radiator Overall: 16 5/8" x 31 1/2" x 4.10"	AM87688523	\$ 755.00	
Case® 1818, 1825 BSN JAF0096438 w/ Gas or Diesel Engine	Radiator	AMA173836	\$ 542.00	
Case® 1835, 1835B	Radiator Overall: 20" x 26 3/4" Core: 19 1/2" x 19 3/4" x 2" 3 Rows, 7 Fins per Inch	AMD83592	\$ 790.00	
Case® 1835C	Radiator Overall: 25 3/8" x 21 1/4" Core: 19 3/8" x 19 1/4" x 2"	AMA190749	\$ 495.00	
Case® 1840, 1845C	Radiator Core: 20 1/4" x 19 1/4" x 2"	AM1347609C1	\$ 445.00	
Case® 1845 ASN 9855225, 1845B, 1845S	Radiator Overall: 20 1/4" x 26 1/2" x 2 1/4"	AMD81055	\$ 454.00	
Case® SR130, SR150, New Holland® L213	Radiator Overall: 17.20" x 20.60" x 3"	AM84475179	\$ 1180.00	
Case® SR175, SR250, SV185, SV300, Track Skid Steer Loaders: TR320, TV380, New Holland® L218, L220, L230, Track Skid Steer Loader: C238	Radiator Overall: 12 3/4" x 29" x 4 1/8"	AM84499505	\$ 663.00	

Skid Steer Parts

Application	Description	Part Number	Retail Price	Core
Case® SR200, Track Skid Steer Loader: TR270, New Holland® C227	Radiator Overall: 17 1/4" x 28 1/2" x 3" overall height does not include Filler Neck	AM84379153	\$ 816.00	
Case® SR220, SR240, SR250, SV280, SV300, Track Skid Steer Loaders: TR320, TV380, New Holland® L223, L225, L230, Track Skid Steer Loaders: C232, C238	Radiator Overall: 17 5/8" x 27 7/8" x 4 1/8" overall height does not include filler neck	AM84379154	\$ 1076.00	
Case® SR220, SV250, SV300, Track Skid Steer Loaders: TR320, TV380, New Holland® L223, L230, Track Skid Steer Loaders: C232, C238	Radiator Overall: 17.60" x 23.70" x 4.11"	AM84475135	\$ 1075.00	
Case® SR220, SV250, SV300, Track Skid Steer Loaders: TR320, TV380	Coolant Temperature Sensor	AM82017881	\$ 26.40	
John Deere® 260, 270, 280 - w/ Diesel Engine	Radiator Overall: 22.25" x 26.50" x 2.75"	AMKV23966	\$ 690.00	
New Holland® C185 ASN N8M469897, C190 ASN N7M457282, L180 1-Speed ASN N8M465246 or 2-Speed ASN N8M464425, L185 1-Speed ASN N8M465248 and 2-Speed ASN N8M465248, L190 ASN N7M459486	Radiator w/ Oil Cooler Radiator	AM87648127 AM87687377	\$ 1310.00 \$ 687.00	
New Holland® L140, L150, L160, L170, LS140, LS140E, LS150, LS160 ASN 133, LS160E, LS170 ASN LMU024443, LS170E, SR150	Radiator Overall: 22" x 18 1/2" Core: 17 1/2" x 18 5/8" x 2 1/2"	AM87033479	\$ 465.00	
New Holland® L465, L565, L665, LS140, LS150, LS160 BSN 133, LS170 BSN LMU024443, LX465, LX485, LX565, LX665, John Deere® 4475, 5575, 6675, 7775	Radiator Overall: 18 3/4" x 23" Core: 18" x 18 5/16" x 3 1/4" 5 Row, 7 Flat Fins per Inch Replaces 9842126, 86534248, 86534249, 86563887, MG86534249	AMMG86563887	\$ 430.00	
New Holland® L553, L555, John Deere® 675, 675B	Radiator Overall: 19" x 23 5/16" Core: 17 3/8" x 17 13/16" x 2 11/16" 4 Rows, 8 Fins per Inch	AMMG9828737	\$ 380.00	
New Holland® L554, L555, John Deere® 675, 675B Diesel	Radiator Overall: 24" x 19" x 2" Replaces 771716	AMMG771716	\$ 325.00	
New Holland® L865, L885, LS180, LX865, LX885, John Deere® 8875	Radiator Overall: 25 3/4" x 20 1/4" x 3 5/16" Ref# MG86534243	AM86534243	\$ 630.00	
Owatonna® 920, 930, 930A, 940	Radiator Overall: 20 1/2" x 16 5/8" x 2 1/4" Core: 16" x 16 1/2" x 2 1/4" Overall Height Includes Fill Neck Replaces 42036262, 42534708, 42535924	AM42035548	\$ 315.00	



Radiator Hoses and Thermostats

Application	Description	Part Number	Retail Price	Core
Bobcat® 463	Radiator Hose, Upper 0.875" & 1" ID	AM6713788	\$ 24.18	
Bobcat® 543 ASN 12001, 543B, 553	Radiator Hose, Upper 0.937" ID	AM6563828	\$ 14.80	
Bobcat® 553AF, 553F	Radiator Hose, Upper 1" & 1.125" ID	AM6714058	\$ 13.92	
Bobcat® 553AF, 553F	Radiator Hose, Upper 1" & 1.125" ID	AM6714059	\$ 17.04	
Bobcat® 632, 732	Radiator Hose, Upper 1.25" ID	AM6555983	\$ 25.35	
Bobcat® 642, 742	Radiator Hose, Upper 1.25" & 1.50" ID	AM6562986	\$ 15.24	

Skid Steer Parts

Application	Description	Part Number	Retail Price	Core
Bobcat® 642, 742	Radiator Hose, Upper 1.25" & 1.437" ID	AM6562987	\$ 22.49	
Bobcat® 642B, 742B	Radiator Hose, Upper 1.25" & 1.375" ID	AM6571682	\$ 15.60	
Bobcat® 643, 645, 743, 743B, 743DS	Radiator Hose, Upper 1.25" & 1.375" ID	AM6562284	\$ 33.55	
Bobcat® 643, 743 BSN 14999	Radiator Hose, Upper 1.25" & 1.375" ID	AM6563116	\$ 27.38	
Bobcat® 645, 743 ASN 15001, 743B, 743DS	Radiator Hose, Upper 1.25" & 1.312" ID	AM6565598	\$ 22.93	
Bobcat® 773G, S175, S185, T190	Radiator Hose, Upper 1.25" & 1.312" ID	AM6717591	\$ 13.33	
Bobcat® 773G, S175, S185, T190	Radiator Hose, Upper 1.25" & 1.375" ID	AM6576028	\$ 6.42	
Bobcat® 751, 751G, 753, 753G, 753L, 763, 763G, 773, 7753	Radiator Hose, Upper 1.25" ID	AM6578279	\$ 16.64	
Bobcat® 751, 751G, 753, 753G, 753L, 763, 763G, 773, 7753	Radiator Hose, Upper 1.25" & 1.312" ID	AM6578280	\$ 29.71	
Bobcat® 843 BSN 12999	Radiator Hose, Upper 1.50" ID	AM6559952	\$ 35.75	
Bobcat® 843 ASN 13001	Radiator Hose, Upper 1.50" & 1.90" ID	AM6564220	\$ 19.81	
Bobcat® 843, 843B	Radiator Hose, Upper 1.50" ID	AM6568983	\$ 23.16	
Bobcat® 853	Radiator Hose, Upper 1.25" ID	AM6700738	\$ 21.93	
Case® 40XT	Radiator Hose, Upper 1 3/4" ID	AM395106A1	\$ 37.52	
Case® 40XT	Radiator Hose, Lower 2.25" ID	AM395107A1	\$ 19.72	
Case® 1840, 1845C	Radiator Hose, Upper 1.78" ID, 2.15" OD	AMD124950	\$ 29.42	
Case® 1840, 1845C	Radiator Hose, Lower 2.312" ID, 2.69" OD	AMD124951	\$ 12.69	
Case® (420, 430, 435, 445 - 2008 and Later), Track Skid Steer Loaders: (420CT, 445CT - 2008 and Later), New Holland® L180, L185, Track Skid Steer Loader: C185	Thermostat, 174°F / 79°C Replaces 504209127	AM11C20	\$ 19.59	
Ford®/New Holland® L140, L150, L160, L170, L465, L565, LS140, LS150, LS160, LS170, LX465, LX485, LX565, LX665	Bypass Hose 0.54" ID Replaces 83938274, 83966732, 87772767, 87780789, SBA145536050, SBA145536380, SBA145537020	AMSBA145536051	\$ 6.39	
John Deere® 24	Radiator Hose, Lower 1.875" ID	AMT22500	\$ 9.00	
John Deere® 240, 250, 260, 270, 280	Thermostat, 182°F / 83°C	AMRE501052	\$ 3.91	

Skid Steer Parts

Water Pumps and Components

Application	Description	Part Number	Retail Price	Core
Bobcat® 443, 443B, 453, 543 ASN 12001, 543B, 553	Water Pump	AM6652753	\$ 47.00	
Bobcat® 533, 543 BSN 11999	Water Pump	AM6660992	\$ 186.51	
Bobcat® 632, 642, 722, 732	Water Pump	AM6640686	\$ 112.26	

Skid Steer Parts

Application	Description	Part Number	Retail Price	Core
Bobcat® 643, 645, 743, 743B, 743DS, 751, 751G, 753, 753G, 753L, 763, 763G, 773, 773G, S150, S160, S175, S185, Case® 1838 w/ V2203 Kubota® Engine, New Holland® (L454, L455, L553, L555 - w/ D1402B or V1902B Kubota® Engine) Replaces 503180, 332451A1, 80503180	Water Pump Includes Mounting Gasket	AM6653941	\$ 57.50	
Bobcat® 825	Water Pump	AM6630572	\$ 104.29	
Bobcat® 825, 943, 953, 970, 974	Water Pump w/o Pulley Includes Mounting Gasket Replaces 743064M91, 748073M91, 3118125R91	AM748095M91	\$ 62.50	
Bobcat® 843 BSN 12999	Water Pump	AM6598500	\$ 133.89	
Bobcat® 843 ASN 13001	Water Pump Replaces 6630541	AM6599948	\$ 60.00	
Bobcat® 943, 953, 970, 974	Water Pump w/o Pulley Replaces 41313218, 41313261	AM41313227	\$ 60.00	
Bobcat® 943, 953, 970, 974	Water Pump	AM6631515	\$ 61.77	
Bobcat® 943, 953, 970, 974	Water Pump w/o Pulley Includes Mounting Gasket	AMU5MW0106	\$ 76.00	
Bobcat® 963	Water Pump Replaces 2396142, 4222840M91, 4224475M91	AMU5MW0193	\$ 138.00	
Bobcat® 751, 753, 763, 773, S130, S150, S160, S175, S185, T140, T180, T190	Belt Tensioner	AM6735884	\$ 140.00	
Case® 410, 420, Ford®/New Holland® L140, L150, L160, L170, L175, L465, L565, LS140, LS150, LS160, LS170, LX465, LX485, LX565, LX665, Track Skid Steer Loader: C175	Water Pump	AMSBA145017790	\$ 151.52	
Case® 450 BSN N8M458415, 465 BSN N7M452623, Track Skid Steer Loader: 450CT BSN N7M464019	Water Pump w/o O-Ring Seal	AM2852114	\$ 60.00	
Case® 1835C, New Holland® L454, L455, L554, John Deere® 570 - All w/ TM13, TM20 or TMD20 Continental Engine	Water Pump Replaces 518161, 1959818C1, 1959819C1	AM508161	\$ 230.00	
Case® 430 BSN N7M479683, 440, 445 BSN N7M454787, 450 BSN N7M458414, Track Skid Steer Loaders: 440CT, 445CT BSN N8M458856, 450CT BSN N7M464019	Belt Tensioner Replaces 2852161, 2853680, 2854611, 2855622, 2856687, 87415847, 87415848, 87803067	AM504028028	\$ 78.50	
New Holland® L779, L783, L785	Water Pump w/ Pulley Includes Mounting Gasket Replaces 3637372R91, 3641250M1, 41312167	AM3637372M91	\$ 61.00	
New Holland® L783, L785, L865, LS180, LX865, LX885 - w/ Ford® Engine	Water Pump w/ Single Groove Pulley Replaces 81872280, 83956731, E6NN8501FA	AM87800116	\$ 194.27	
New Holland® LS190, LX985	Belt Tensioner Replaces 83998237, F0NN6B209AA, F1NN6B209AA	AM87801689	\$ 57.50	
John Deere® 260, 270	Water Pump Standard Flow	AMRE505981	\$ 80.00	
John Deere® 280 - w/ 3029, 4036, 4045 or 6068 Engine	Water Pump Pulley 94 mm Diameter	AMR115250	\$ 41.67	
John Deere® 313, 315, 317, 318D, 320, 320D, Track Skid Steer Loaders: 319D, 323D, CT315, CT322	Water Pump Includes Mounting Gasket Replaces RE518520, SE502115	AMRE545572	\$ 180.00	
John Deere® 325, 326D, 328, 328D, 332, 332D, Track Skid Steer Loaders: 329D, 333D, CT332	Water Pump Replaces RE507604	AMRE545573	\$ 170.00	
John Deere® 675, 675B	Water Pump	AMAM880905	\$ 111.88	
John Deere® 240, 250, 260, 8875	Water Pump Shaft Bearing 5.75" Long, 2.125" Wide, 1.50" OD, 0.746" Shaft Size	AMJD9257	\$ 18.40	

Skid Steer Parts

Application	Description	Part Number	Retail Price	Core
John Deere® 270	Fan Drive Pulley	AMR128660	\$ 84.94	
John Deere® 313, 315, 317, 320, 325, 328, 332, Track Skid Steer Loaders: CT315, CT322, CT332	Fan Idler Pulley	AMRE537940	\$ 20.64	
Kubota® SSV65	Water Pump	AM1J700-73030	\$ 128.40	

Carburetors

Application	Description	Part Number	Retail Price	Core
Case® 1835, 1835B	Carburetor, Zenith	AMX82002	\$ 508.00	
Case® 1845B, 1845S	Carburetor	AMX82007	\$ 550.00	

Fan Clutches

Application	Description	Part Number	Retail Price	Core
Case® 40XT, 60XT, 70XT	Fan Pulley Support Replaces 5261322, 84585624, J911205	AM87428288	\$ 204.00	
John Deere® 313, 315, 317, 320, 325, 328, 332, Track Skid Steer Loaders: CT315, CT322, CT332	Fan Drive Hub w/ Bearing	AMRE505621	\$ 85.95	

Fuel Lift Pumps

Application	Description	Part Number	Retail Price	Core
Bobcat® 443, 453, 543, 553, 643, 645, 743	Fuel Lift Pump Replaces 6564223	AM6598121	\$ 33.50	
Bobcat® A300, S220, S250, S300, S330, T250, T300, T320	Fuel Lift Pump Replaces 6680838	AM7011982	\$ 47.68	
Case® 60XT, 70XT, 85XT, 90XT, 95XT, 1840, 1845C	Fuel Transfer Pump Replaces 87473337, J917998	AM87648717	\$ 80.00	
Case® 75XT, 85XT, 90XT, 95XT, 1840, 1845C	Fuel Lift Pump Replaces 3904374, J904374	AMJ928143	\$ 28.50	
Case® 90XT, 95XT, 1840, 1845C	Fuel Primer Pump Replaces 3914319	AM3918000	\$ 62.50	
Case® 420 BSN N7M466710, 420CT, 430, 435, 440, 440CT, 445, 445CT, 450, 450CT, 465, SR200, Track Skid Steer Loader: TR270, New Holland® L180, L185, L190, L223, LS180.B, LS185.B, LS190.B, Track Skid Steer Loaders: C185, C190, C227, LT185.B, LT190.B	Fuel Lift Pump Replaces 84268475, 84269570, 504146090	AM2830266	\$ 36.00	
New Holland® L865, LS180, LS190, LX865, LX885, LX985	Fuel Lift Pump	AM87802238	\$ 77.00	
New Holland® L140, L150, L160, L170, (L425, L445, L452 ASN 607250), L454, L455, L465, L553 ASN 715165, L555, L565, LS140, LS150, LS160, LS170, LX465, LX485, LX565, LX665	Fuel Pump, Electronic 12 Volt, 1.30 Amps, Round Replaces 646193, 9607940, 9843528	AM86506895	\$ 49.32	
New Holland®: L150, L160, L170, L175, L213, L215, L218, L220, LS150, Track Skid Steer Loader: C175	Fuel Pump, Electronic Square	AM84130988	\$ 49.32	
John Deere® 240, 250, 260, 270, 280	Fuel Pump, Electronic 25 GPH Flow Rate at 4-6 PSI	AMKV13829	\$ 44.32	
John Deere® 312GR, 314G, 316GR, 317G, 318E, 318G, 319E, 320E, 320G, 323E, 324E, 324G, 325G, 326E	Fuel Transfer Pump	AMAT318139	\$ 71.00	
John Deere® 313, 315, 317, 320, 325, 328, 332, Track Skid Steer Loaders: CT315, CT322, CT332	Fuel Lift Pump Replaces RE515953, RE525102	AMRE532211	\$ 62.50	

Skid Steer Parts

Injectors

Application	Description	Part Number	Retail Price	Core
Case® 90XT, 95XT	Fuel Injector, 7 mm Tip	AMJ919343	\$ 45.00	
	Injector	AMJ929490	\$ 40.00	
Case® 1700, 1835, 1835B, 1845, 1845B, 1845S	Injector Pencil # - 20671	AMA140829	\$ 40.00	
John Deere® 240, 250	Injector	AMRE531437	\$ 64.85	
John Deere® 250, 260	Injector Marked 29229 Turbo Engines	AMRE48786	\$ 60.00	
John Deere® 270, 280	Injector Marked 32262 Non-Turbo Engines	AMRE60062	\$ 35.00	
John Deere® 4475, 5575, 6675, 7775	Injector	AMAT110293	\$ 92.00	
John Deere® 8875	Pencil Injector	AMRE38087	\$ 33.00	
	Injector Replaces RE38087, Stanadyne® 28484	AMRE36939	\$ 37.55	
John Deere®: 240, 240-II	Pencil Injector Washer For Lower Injector 0.381" ID, 0.562" OD, 0.120" Thick Replaces 64355A, 499210, A41403	AMR60746	\$ 0.58	
John Deere® 240, 250, 260, 8875	Injector O-Ring Kit Replaces R48000, R79605, R92352	AMRE64292	\$ 5.45	

Turbochargers and Components

Application	Description	Part Number	Retail Price	Core
Case® 90XT, 95XT	Turbocharger	AMJ804960	\$ 575.00	
Case® 90XT, 95XT - w/ 3.9T Cummins® Engine	Turbocharger, Holset Replaces J802290, J919135	AM3522900	\$ 475.00	
Case® 420CT ASN N7M45501, New Holland® L170, L175, LS170, Track Skid Steer Loader C175	Turbocharger Replaces 4T507, 87772751, 87780726, 135756172	AMSBA135756171	\$ 517.00	
New Holland® L170, L175, LS170, Track Skid Steer Loader: C175	Turbocharger Replaces 87780726, SBA135756170, SBA135756171	AMSBA135756172	\$ 450.00	
New Holland® L865, LS180, LX865, LX885 - w/ Emissionized Engine	Turbocharger Replaces 465209-0004, 87801364	AM87801413	\$ 620.00	
New Holland® L865, LX865, LX885 - w/ Non-Emissionized Engine	Turbocharger Replaces 465209-5006, 87800402	AM87801483	\$ 550.00	
New Holland® LS170 1999 and Later, LX665 1994-99	Turbocharger Replaces 87771826, 87771827, SBA135756150	AMSBA135756151	\$ 450.00	
John Deere® 240, 250, 260, 270	Reman Turbocharger	AMRE70036	\$ 525.00	\$ 145.00
John Deere® 313, 315, Track Skid Steer Loader: CT315	Turbocharger	AMRE532400	\$ 865.00	
John Deere® 313, 315, 317, 320, 325, 328, Track Skid Steer Loaders: CT315, CT322	Turbocharger Replaces SE501678	AMRE518228	\$ 475.00	
John Deere® 280	Turbocharger Drain Hose	AMR120013	\$ 33.92	
John Deere® 280	Turbocharger Oil Inlet Hose	AMRE501260	\$ 43.00	

Manifolds

Application	Description	Part Number	Retail Price	Core
Case® 1835, 1835B, 1845, 1845B, 1845S - w/ 188 or 207 Diesel Engine	Exhaust Manifold Plates or Hardware Not Included Replaces G2113, A39233, A-G2113	AMA182084	\$ 172.00	

Skid Steer Parts

Mufflers and Exhaust

Application	Description	Part Number	Retail Price	Core
Bobcat® 642, 643, 645, 742, 743	Muffler Inlet 1 3/4"	AM6514737	\$ 130.00	
Bobcat® 643, 645, 743	Exhaust Pipe	AM6569624	\$ 96.00	
Bobcat® 751, 753, 763, 773, 7753, S130, S150, S160, S175, S185, Track Skid Steer Loader: T140	Muffler Inlet 1 3/4"	AM7100840	\$ 130.00	
Bobcat® 751, 753, 763, 773, 7753, S130, S150, S160, S175, S185, Track Skid Steer Loader: T140	Exhaust Pipe Inlet 1 5/8"	AM6701151	\$ 85.00	
Bobcat® S130 ASN A3KY11001 & ASN AU4Y11001, S150 ASN A3L111001, S175 ASN A3L511001, Track Skid Steer Loader: T140 ASN A3L711001 & ASN A3L811001	Muffler Vertical Round, Inlet 1 3/4", Length 32 1/8"	AM7137824	\$ 175.00	
Bobcat® S150, S160, S175, S185, Track Skid Steer Loader: T190	Muffler Vertical Round, 2-Hole Mounting Flange, Inlet 1 3/4", Length 28 3/4"	AM6676728	\$ 180.00	
Bobcat® S150, S160, S175, S185, S205, Track Skid Steer Loaders: T180, T190	Muffler Vertical Round Body, 2-Hole Mounting Flange, Inlet 2", Length 29 1/4"	AM6683915	\$ 185.00	
Bobcat® S150 SN 526611001-526711000, S160 SN 526611001-526811000 ASN 529911001, ASN AC3211001 & ASN AHWA11001, S175 SN 525011000-525211000, S185 SN 525011001-525211000, ASN 530311001 & ASN ABRT11001, S205 ASN 528411001, Track Skid Steer Loaders: T180 ASN 524211001, T190 ASN 527011001	Exhaust Pipe Inlet 1 7/8"	AM7107449	\$ 100.00	
New Holland® L160 BSN N7M448077, L170 BSN N7M456356, L565, LS160, LS170, LX565	Muffler Vertical Round, Inlet 2", Length 17 3/4"	AM86527336	\$ 250.00	
New Holland® L160, L565, LS160, LX565	Muffler Length - 27.69"	AM86537593	\$ 186.27	
John Deere® 4475, 5575	Muffler Vertical Round, Inlet 1 1/2", Length 17"	AMMG9844590	\$ 230.00	
John Deere® 6675, 7775	Muffler Horizontal Round, Inlet 2 1/8", Length 17 3/8" Replaces MG9844518	AMMG86527304	\$ 310.00	

Starters

Application	Description	Part Number	Retail Price	Core
Bobcat® Ind: 5600, 5610, T2250, V417, Skid Steer Loaders: 751G, 753, 763, 773, 863, 873, 883, 963, A300 (w/ Deutz® or Kubota® Engine), A770, S100, S130, S150, S160, S175, S185, S205, S220, S250, S300, S330, S510, S530, S550, S570, S590, S630, S650, S750, S770, S850, T110, T140, T180, T190, T200, T250, T300, T320, T550, T590, T630, T650, T750, T770, T870	Starter, 12 Volt 11 Tooth, CW Rotation	AM6676957	\$ 266.00	
Bobcat® 444, 500, 600, 611, 611W, 631, 721, 731	Starter, 12 Volt Direct Drive, 9 Tooth, 2.70kW, 2-Ear Mount on Drive End Housing	AM6513391	\$ 219.50	
Bobcat® 453, 453C, 453D, 453F, 463, 553, 553AF, 553F, 751M, MT50	Starter, 12 Volt Denso, Gear Reduction, 10 Tooth, 1.40kW, CW Rotation	AM6667987	\$ 137.00	
Bobcat® 631, 641, 741, 843, 843B, 853, 853C, 853H, 943, 953, 970, 974 w/ 4.236 Perkins® Engine, 1080 - Diesel	Starter, 12 Volt HD Planetary Gear Reduction, 10 Tooth Steel Pinions, Steel Ring Gear, 4kW, CW Rotation For Diesel Engines Replaces 1113391, 1113672	AMX34112	\$ 285.00	
	Solenoid Use w/ AMX34112 Starter	AMX34113	\$ 60.00	

Prices Subject to Change without Prior Notice. The use of original equipment manufacturer (OEM) part numbers or trademarks, e.g. Case® and John Deere®, are for reference purposes only and for indicating product use and compatibility. Our company and the listed replacement parts contained herein are not sponsored, approved or manufactured by the OEM. All parts are New unless designated Reman in the description.

Skid Steer Parts

Application	Description	Part Number	Retail Price	Core
Bobcat® 641, 741, 853, 943, 974, Loaders: 2000, 2400, 2410, Trencher: 3023, Wood Loaders: 1080C, 1213	Starter, 12 Volt Delco 28MT, Gear Reduction, 12 Tooth, CW Rotation Replaces 6630180, 6630181, 6651210	AM6651664	\$ 129.50	
Bobcat® (653, 751, 751C - w/ Peugeot Diesel Engines), (873, 873C - w/ Deutz® Diesel Engines)	Starter, 12 Volt Denso, Gear Reduction, 10 Tooth, 2.70kW, CW Rotation	AM6665654	\$ 190.00	
Bobcat® 751F, 751G, 753, 753C, 753F, 753G, 753H, 753HC, 753L, 763, 763C, 763F, 763G, 763HC, 763HF, 763HG, 773, 773C, 773F, 773G, 773TG, S300, T190	Starter, 12 Volt Denso, Gear Reduction, 11 Tooth, 2.70kW, CW Rotation	AM6667587	\$ 170.00	
Bobcat® 763C, 763F, 763G, 763HC, 763HF, 763HG, 773 - w/ V2203E or V2203EB Diesel Engine	Starter, 12 Volt Delco 28MT, Gear Reduction, 12 Tooth, CW Rotation Replaces 6586, 111038, 323-1189, 10465346, 10465348, 10465420, 10479613	AM6660797	\$ 155.00	
Bobcat® (843B, 843HC, 853H, 853 - w/ Isuzu Diesel Engines), (943, 974 - w/ Perkins Diesel Engines), Articulated Loader: 2000	Starter, 12 Volt Gear Reduction, Direct Replacement, 3-Bolt Flange	AMX34107	\$ 145.00	
Bobcat® 863, 863C, 863F, 863G, 863H, 863HC, 863HF, 863HG, 864F, 864G, 864HG, 873, 873C, 873F, 873G, 873HG, 883G, A220, Trencher: T200 - All w/ Deutz® MF4M1011 Engine	Starter, 12 Volt 10 Tooth, 3-Ear Mount	AM6667825	\$ 269.25	
Bobcat® 953C (1995-99), 963 (1997-2002)	Starter, 12 Volt 10 Tooth, 3.00kW, CW Rotation, 3-Ear Mount	AM6667320	\$ 221.50	
Bobcat® 970, 974	Starter, 12 Volt 10 Tooth, CW Rotation, 3-Ear Mount	AM6670269	\$ 138.50	
Bobcat® 975, John Deere® 240, 250, 260	Starter, 12 Volt Gear Reduction, 10 Tooth, 3.20kW, Noseless Version 32 mm Pinion OD Replaces RE68470, SE501402	AMRE540300	\$ 290.00	
Case® 410, 420, Track Skid Steer Loader: 420CT, Ford®/New Holland® L140, L150, L160, L170, L175, (L465, LX465, LX485 Engine ASN 046640), (L565, LX565, LX665 Engine ASN 057422), LS140, LS150, LS160, LS170, Track Skid Steer Loader: C175	Starter, 12 Volt 11 Tooth	AMSBA185086530	\$ 128.00	
Case® SR200, SR250	Starter Bosch, 10 Tooth, 4kW, CW Rotation Bosch Mfg # - 504357110 Iskra Mfg # - IS1109	AM84151331	\$ 275.00	
Case® 420 ASN N7M466710, 430 ASN N7M479683, 435, 440 ASN N8M474469, 445, 450, 465, Track Skid Steer Loaders: 420CT, 440CT, 445CT, 450CT, TR270, TR320, TV380, New Holland® L180, L185, L190, L225, L230, Track Skid Steer Loaders: C185, C190, C227, C232, C238	Starter, 12 Volt Replaces 428000991, 4280006030, 4280009910	AM87638510	\$ 438.00	
New Holland® L35 ASN 462066, L120, L125, L140, L150, L160, L170, L175, L180, L185, L190, L250, L255, L325 SN 451643-555425, L425 ASN 479215, L445 ASN 482311, L451, L452, L454, L455, L465, L553 ASN 712165, L554, L555, L565, L775 ASN 491999, L779, L781 BSN 728845, L783, L784, L785, L865, LS120, LS125, LS140, LS150, LS160 ASN LMU024133, LS170 ASN LMU024444, LS180, LS180.B, LS185.B, LS190, LS190.B, LX465, LX485, LX565, LX665, LX865, LX885, LX985, Track Skid Steer Loaders: C175, C190, LT185.B, LT190.B	Ignition Switch Replaces 529713, 8641833, 80641833	AM641833	\$ 20.31	
John Deere® 240 ASN 173339, 250 ASN 167861, 260 ASN 168074	Starter, 12 Volt 10 Tooth, CW Rotation Iskra Mfg # - 11131063 Marked RE502156 or RE505746 Replaces SE501852	AMRE516157	\$ 373.30	

Skid Steer Parts

Application	Description	Part Number	Retail Price	Core
John Deere® 240 Standard BSN 196419 or Hi-Flow BSN 173340, 250 Standard BSN 197301 or Hi-Flow BSN 167861, 260 BSN 168075	Starter, 12 Volt Gear Reduction, 10 Tooth, 3.20kW Marked RE501680 or RE502156 Will Not Replace Bosch or Iskra Starters Replaces RE501693, RE502196, SE501861	AMRE501680	\$ 258.00	
John Deere® 313, 315, 317, 318D, 320D, 325, 326D, 328D, 332, 332D, Track Skid Steer Loaders: 319D, 323D, 329D, 333D, CT315, CT322, CT332	Starter, 12 Volt Bosch, Planetary Magnet Gear Reduction, 9 Tooth, 2.20kW, CW Rotation, 2-Ear Mount	AMRE508922	\$ 99.00	
John Deere® 8875	Starter, 12 Volt Delco, 28MT, Gear Reduction, 10 Tooth Replaces AL110597, AL70850, RE59588, RE62916, RE417418, SE501428, TY1458, TY6702, TY24305	AMRE239087	\$ 160.00	

Alternators

Application	Description	Part Number	Retail Price	Core
Bobcat® 371, 443, 525, 530, 543B, 611, 620, 631, 641, 642, 643, 721, 741, 742, 743, 825, 833, 843, 974, 975, 1080	Alternator 12 Volt, 22 Amp, IR/EF, CW Rotation Plug at 6 o'clock position	AM6654209	\$ 138.00	
Bobcat® 443B, 524B, 543B, 641, 642B, 643, 741, 742, 743, 753, 753H, 753L, 843, 843B, 853, 853C, 853H, 943, 974, 975, 980, 7753, Excavators: 220, 225, 231, 325C, 325D, 331, 331C, 331E, 331EC, 337C, 337D, Trenchers: 3022, 3023, Ind: 1080C, 1213, 1600, 2000, 2400, 2410, 3022, 3023, 440B	Alternator 12 Volt, 55 Amp, IR/EF, CCW Rotation	AM6661611	\$ 138.50	
Bobcat® 751, 763, 773, 863, 864, 883, 5600 (Toolcat), A220, A300, S130, S175, S185, S220, S250, S300, T190, T200, T300, X331	Alternator 12 Volt, 90 Amp, CW Rotation Replaces 6678205	AM6675292	\$ 155.50	
Case® 40XT, 60XT, 70XT, 75XT, 85XT, 90XT, 95XT, 1835C, 1840, 1845C 1987-99	Reman Alternator Bosch Type, 12 Volt, 65 Amps, IR/EF	AMRE533516	\$ 188.59	\$ 20.00
Case® 1825 Ref# 1959600C1	Alternator Denso Type, 12 Volt, 25 Amps, E/R	AM15411-64010	\$ 77.00	
Case® SR130, SR160, SR175, SR200, SR220, SR250, SV185, SV250, SV300, Track Skid Steer Loaders: TR270, TR320, TV380	Alternator 14 Volt, 120 Amps Replaces Delco 860000, Denso 102211-9090	AM84254290	\$ 230.00	
Ford®/New Holland® L140, L150, L160, L170, L465, L565, LS140, LS150, LS160, LS170, LX465, LX485, LX565, LX665	Alternator 12 Volt, 40 Amps	AMSBA185046320	\$ 127.00	
New Holland® L781, L783, L785	Alternator Lucas, 12 Volt, 45 Amps, IR/EF, CW Rotation 1-Groove Pulley Replaces 81863039, 81868798, 83961474	AM82857207	\$ 111.00	
New Holland® SL57	Alternator 14 Volt, 120 Amps Replaces 102211-9090, 422777, 84416587	AM84254289	\$ 230.00	
John Deere® 270, 280	Alternator Magnetron Type, 12 Volt, 55 Amps, IR/EF Replaces RE501634, RE505895, SE501823	AMRE506196	\$ 229.33	
	Alternator Bosch, 12 Volt, 95 Amps, IR/EF, CW Rotation, w/o Pulley	AMA187623	\$ 105.00	
John Deere® 313, 315, 317, 318D, (318E, 320E, 323E, 326E - w/ A/C), 320D, 325, 326D, 328, 328D, 328E, 332, 332D, 332E	Alternator Bosch, 12 Volt, 70 Amps Replaces SE501831	AMRE529377	\$ 311.00	
John Deere® 570, 575, 675, 675B	Alternator 12 Volt, 40 Amps Replaces AM100808	AMAM877740	\$ 100.00	

Prices Subject to Change without Prior Notice. The use of original equipment manufacturer (OEM) part numbers or trademarks, e.g. Case® and John Deere®, are for reference purposes only and for indicating product use and compatibility. Our company and the listed replacement parts contained herein are not sponsored, approved or manufactured by the OEM. All parts are New unless designated Reman in the description.

Skid Steer Parts

Air Cleaner Components

Application	Description	Part Number	Retail Price	Core
John Deere®: 280	Air Intake Hose 3.15" Long	AMR500596	\$ 7.06	

Sensors

Application	Description	Part Number	Retail Price	Core
Case® 40XT, 60XT, 70XT, 75XT, 85XT, 90XT, 95XT, 410, 420, 430, 435, 440, 445, 450, 465, 1835, 1835B, Track Skid Steer Loaders: 420CT, 440CT, 445CT, 450CT, New Holland® L180, L185, L190, LS180.B, LS185.B, LS190.B, LT185.B, LT190.B, Track Skid Steer Loaders: C185, C190	Temperature Sending Switch Replaces A166057, D65446, 47048895, 87779395	AM84300765	\$ 36.35	
Case® SR130, SR150, SR160, SR175, SR200, SR210, SR220, SR240, SR250, SR270, SV185, SV250, SV280, SV300, SV340, Track Skid Steer Loaders: TR270, TR310, TR320, TR340, TV380, New Holland® L213, L215, L216, L218, L220, L221, L223, L225, L228, L230, L234, Track Skid Steer Loaders: C227, C232, C234, C238	Sensor, Grain Tank Cover/Spreader	AM87392235	\$ 29.00	
Case® SR210, SR220, SR250, SV250, SV300, Track Skid Steer Loaders: TR270, TR320, TV380, New Holland® Track Skid Steer Loaders: C227, C232, C238, L225, L230	Sensor, Exhaust Pressure	AM5801382522	\$ 104.00	
John Deere®: 318E BSN 249323, 319E BSN 249321, 320E BSN 249291, 323E BSN 249322, 324E BSN 297099, 326E ASN 254997, 4475, 5575, 6675, 7775	Water Temperature Sender Switch	AMT110736	\$ 31.90	
John Deere® 318D, 319D, 320D, 323D, 326D, 328D, 329D, 332D, 333D	Air Temperature Sensor Replaces 72102514	AMRE525016	\$ 19.25	

Axles and Components

Application	Description	Part Number	Retail Price	Core
Bobcat® 730, 731, 732, 741, 742, 743, 843, 1213	Brake Disc	AM6559237	\$ 83.50	
Case® 40XT, 60XT, 70XT, 75XT BSN JAF0318922, 85XT BSN JAF0352234, 410, 420, 430, 435, 440	Axle Housing Includes Races and Grease Zerk Replaces 338552A3, 386799A1	AM338551A2	\$ 438.00	
Case® 40XT, 60XT, 70XT, 75XT ASN JAF0317622, 85XT BSN JAF0297637 & SN JAF0297642-JAF0298061, 410, 420, 430, 435, 440	Axle Drive Shaft Wheel Spindle w/ Studs Replaces 189994A1, 338550A1, 338550A2	AM338550A4	\$ 449.00	
Case® 60XT, 70XT, 75XT, 410, 420, 430, 435, 440	Axle Assembly Includes Axle, Hub, Bearings and Seals	AM338552A3	\$ 1246.00	
Case® 85XT ASN JAF0298061, 90XT ASN JAF0298847, 95XT ASN JAF0299274, 445, 450, 465	Axle Drive Shaft Wheel Spindle w/ Studs	AM339428A3	\$ 495.00	
Case® 85XT, 90XT, 95XT, 445, 450, 465	Axle Housing Includes Bearing Cups	AM339429A2	\$ 520.00	
Case® 1835C ASN JAF0037911, 1840 ASN JAF0098608	Axle Housing Bare Housing Replaces H435001	AMH436341	\$ 496.00	
Case® 1835C, 1838, 1840	Axle Drive Shaft Wheel Spindle w/ Studs Replaces 199281A1, H672982	AM103825A1	\$ 469.00	
	Driven Sprocket, Rear Axle 33 Tooth	AMH435258	\$ 184.00	
	Drive Sprocket, Front Park Brake 33 Tooth Replaces D64228	AMH435243	\$ 152.00	

Skid Steer Parts

Application	Description	Part Number	Retail Price	Core
Case® 1845, 1845B, 1845C, 1845S	Axle Assembly Includes Axle, Hub, Bearings and Seals	AM222931A1	\$ 1199.00	
	Axle Housing Includes Races and Grease Zerk Replaces D63672, D67818	AM222930A1	\$ 496.00	
	Axle Drive Shaft Wheel Spindle w/ Studs Replaces 222931A1, D120108	AMD67818	\$ 417.00	
	Driven Sprocket, Axle 33 Tooth, 14 Spline Replaces D67818, D76464	AMD120108	\$ 167.00	
	Cluster Sprocket Assembly 41, 12 & 12 Tooth Replaces D64175, D63780, D124607	AMD76529	\$ 178.00	
Case® 1845, 1845B, 1845S	Pin, Cluster Sprocket Cluster Shaft Only	AMD63780	\$ 172.50	
Case® 1845C	Pin, Cluster Sprocket Cluster Shaft Only	AMD124607	\$ 184.00	
New Holland® L140, L150, L465, LS140, LS150, LX465, John Deere® 4475	Drive Sprocket 51 Tooth Replaces MG9841270	AM9841270	\$ 183.00	
New Holland® L140, L150, L465, LS140, LS150, LX465, LX485, John Deere® 4475, 5575	Axle Assembly Includes Axle, Hub, Bearings and Seals Replaces 86562320, 87025350, MG86562320	AM86501234	\$ 990.00	
	Axle Housing Replaces 9841475, 86594883	AM87025350	\$ 308.00	
	Axle Drive Shaft Wheel Spindle Replaces 86501232, MG86501232, MG86562320	AM86562320	\$ 413.00	
New Holland® L160, L170, L175, L565, LS160, LS170, LX565, LX665, John Deere® 6675, 7775	Axle Housing Replaces 9841232, 86594882	AM87026231	\$ 392.00	
New Holland® L160, L170, L565, LS160, LS170, LX565, LX665, John Deere® 6675, 7775	Axle Drive Shaft Wheel Spindle w/ Studs Replaces 9841453, MG9841453, MG86546633	AM86546633	\$ 517.00	
New Holland® L180, L185, L190, L865, LS180, LS180.B, LS185.B, LS190, LS190.B, LX865, LX885, LX985, John Deere® 8875	Axle Assembly Includes Axle, Hub, Bearings and Seals Replaces 9841131, 86546632, 86594881	AM87440218	\$ 1356.00	
	Axle Housing Bare Housing Replaces MG9841502, MG86594881	AM86594881	\$ 392.00	
	Axle Drive Shaft Wheel Spindle w/ Studs Replaces 9829889, 87440219	AM86546632	\$ 620.00	

Hydrostatic Drive Components

Application	Description	Part Number	Retail Price	Core
Case® 410 ASN N7M480924, 420 ASN N7M466710, 430 ASN N7M479683, 435 ASN N7M425032	Hydrostat Pump 42.90 cc	AM87619378	\$ 4425.00	
Case® 410, 420 BSN N7M466710, Track Skid Steer Loader: 420CT ASN N7M455401	Hydraulic Drive Motor Single Speed	AM48186712	\$ 2708.00	
Case® 420 ASN N7M466710, 430, 440, New Holland® L190, LS190.B, Track Skid Steer Loader: C190	Hydraulic Drive Motor	AM48033385	\$ 2428.00	
Case® 420 ASN N7M466710, 430, 440, New Holland® L190, LS190.B, Track Skid Steer Loader: C190	Hydraulic Drive Motor 9 Tooth, Single Speed Replaces 87035341	AM48033384	\$ 1524.00	

Skid Steer Parts

Application	Description	Part Number	Retail Price	Core
Case® 445 BSN N7M454787, Track Skid Steer Loaders: 440CT BSN N8M483727, 445CT, 450CT, New Holland® L190, Track Skid Steer Loaders: C185, C190 BSN N8M420341	Hydraulic Drive Motor Right Hand, 310 cc, 2-Speed	AM87600263	\$ 5799.00	
Case® 445, Track Skid Steer Loaders: 440CT BSN N7M483727, 445CT, 450CT BSN N8M485280, New Holland® L190 BSN N7M459487, Track Skid Steer Loaders: C185, C190	Hydraulic Drive Motor Left Hand, 200 cc Replaces 87447234	AM87600262	\$ 5799.00	
Case® 450 BSN N8M458415, 465 BSN N7M452623	Hydraulic Drive Motor Single Speed, w/ Inline Pump Replaces 87367732	AM48070319	\$ 3499.00	
Case® 450, 465	Hydraulic Drive Motor 2-Speed Replaces 87349721	AM48070318	\$ 3053.00	
Case® 450, 465, Track Skid Steer Loaders: 440CT, 445CT, 450CT - All w/ Pilot Control	Hydrostat Pump 46 cc	AM87546977	\$ 4425.00	
Case® 1838 ASN JAF0193088, 1840 ASN JAF0134061	Hydraulic Drive Motor	AM230459A1	\$ 1150.00	
Case® SR130, SR130B, SR150, SR150B, SR160, SR160B, SR175, SR175B, SV185, SV185B, Track Skid Steer Loader: 420CT, New Holland® L213, L215, L216, L218, L220, L313, L315, L316, L318, L320	Hydraulic Drive Motor 325 cc, Single Speed Replaces 48186651, 84256614, 84565749	AM51471337	\$ 1665.00	
Case® SR175, SR175B, SV185, SV185B, Track Skid Steer Loader: TR270B, New Holland® L218, L220, L318, L320, Track Skid Steer Loader: C327	Hydraulic Drive Motor 325 cc, 2-Speed Replaces 48186652, 84256615	AM84565750	\$ 2556.00	
Case® SR200, SR200B, SR210, SR210B, SR220, SR220B, SR240, SR240B, SR250, SR250B, SR270, SR270B, SV250, SV250B, SV280, SV280B, SV300, SV300B, SV340, SV340B, New Holland® L221, L223, L225 - 04/2011 and Later, L228, L230, L234, L321, L323, L325, L328, L330, L334, Track Skid Steer Loader: C232	Hydraulic Drive Motor 470 cc, 2-Speed	AM84565752	\$ 2386.00	
Case® SR200, SR200B, SR210, SR220B, SR240, SR270, SV250, SV250B, SV280, SV300, SV300B, SV340, Track Skid Steer Loaders: TR310, TR340, TV380, New Holland® L221, L228, L230, L234, L323, L325, L330, Track Skid Steer Loaders: C232, C234, C238	Hydrostat Pump Tandem Pump, 45 cc Replaces 47775932	AM48144404	\$ 4884.00	
Case® SR200B, SR210B, SR220B, SR240B, SR250B, SR270B, SV250B, SV280B, SV300B, SV340B, New Holland® L321, L323, L325, L328, L330, L334	Hydraulic Drive Motor 325 cc, Single Speed Replaces 84565751	AM51471338	\$ 2347.00	
Case® Track Skid Steer Loader: 420CT	Hydraulic Drive Motor 280 cc	AM87355890	\$ 5814.00	
New Holland® L175, L213, Track Skid Steer Loader: C175 ASN N7M466429	Hydraulic Drive Motor 10 Tooth, 2-Speed Replaces 87034688	AM48186708	\$ 3052.00	
New Holland® L180, 185, LS180.B, LS185.B	Hydraulic Drive Motor 10 Tooth, Single Speed Replaces 87035339	AM48033382	\$ 4030.00	
New Holland® L180, L185, L190, LS180.B, LS185.B, LS190.B, LT185.B, LT190.B, Track Skid Steer Loaders: C185, C190 - All w/ Pilot Control	Hydrostat Pump 46 cc	AM87357098	\$ 4425.00	
New Holland® L180, L185, LS180.B, LS185.B, Track Skid Steer Loaders: LT185.B	Hydraulic Drive Motor 10 Tooth, 2-Speed Replaces 87035340	AM48070316	\$ 3032.00	
New Holland® L225, L425, L445	Drive Sprocket, Hydrostat Replaces 80249879	AM249879	\$ 57.50	
John Deere® 325	Hydraulic Drive Motor Left Hand, 2-Speed Electrohydraulic Replaces AT340373	AMAT445989	\$ 3701.00	
John Deere® 317G	Hydraulic Drive Motor	AMAT442067	\$ 4231.00	
John Deere® 325, 326D	Hydraulic Drive Motor Right Hand, 2-Speed Replaces AT310825, AT310685	AMAT446033	\$ 3975.00	

Prices Subject to Change without Prior Notice. The use of original equipment manufacturer (OEM) part numbers or trademarks, e.g. Case® and John Deere®, are for reference purposes only and for indicating product use and compatibility. Our company and the listed replacement parts contained herein are not sponsored, approved or manufactured by the OEM. All parts are New unless designated Reman in the description.

Skid Steer Parts

Application	Description	Part Number	Retail Price	Core
John Deere® 325, 326D	Hydraulic Drive Motor Left Hand, 2-Speed Replaces AT310827, AT310686	AMAT446034	\$ 3975.00	
John Deere® 325, 326D	Hydraulic Drive Motor Right Hand, 2-Speed Electrohydraulic Replaces AT343527	AMAT446036	\$ 3975.00	
John Deere® 325, 326D	Hydraulic Drive Motor Left Hand, 2-Speed Electrohydraulic Replaces AT343529, AT340363	AMAT446042	\$ 3975.00	
John Deere® 326E, 328, 328D, 328E, 330G, 332, 332D, 332E, 332G	Hydraulic Drive Motor Right Hand, 2-Speed Electrohydraulic Replaces AT343528	AMAT445987	\$ 3975.00	
John Deere® 326E, 328, 328D, 328E, 330G, 332, 332D, 332E, 332G	Hydraulic Drive Motor Left Hand, 2-Speed Electrohydraulic Replaces AT343530	AMAT445990	\$ 3975.00	
John Deere® 326E, 328, 328E, 330G, 332D, 332E, 332G	Hydraulic Drive Motor Right Hand 2-Speed Electrohydraulic Marked AT445986 Replaces AT445987	AMAT445986	\$ 3701.00	
John Deere® 328, 328D, 332, 332D	Hydraulic Drive Motor Right Hand, 2-Speed Replaces AT310826	AMAT446037	\$ 3975.00	

Hydraulic Oil Coolers

Application	Description	Part Number	Retail Price	Core
Bobcat® S750, S770, S850, T750, T770, T870	Hydraulic Oil Cooler Core: 19 7/8" x 15 3/4" x 1 7/8"	AM7012614	\$ 360.00	
Case® 1835C, 1838, 1840, 1845C	Hydraulic Oil Cooler	AMA184084	\$ 395.00	
Case® 1840, 1845	Hydraulic Oil Cooler Core: 19" x 20 1/4" x 3" Replaces 252931A1	AM252931A2	\$ 675.00	
Case® 40XT, 60XT, 70XT	Hydraulic Oil Cooler Core: 19" x 20 1/8" x 1.50" Replaces 367985A3	AM386925A1	\$ 710.00	
	Hydraulic Oil Cooler Core: 19" x 20 1/4" x 3"	AM385707A1	\$ 521.00	
Case® 75XT, 85XT, 90XT, 95XT	Hydraulic Oil Cooler Core: 20 1/4" x 19" x 3 1/4" Replaces 226631A1, 237994A1	AM237994A2	\$ 1195.00	
Case® 75XT ASN JAF0318922, 95XT ASN JAF0311357	Hydraulic Oil Cooler Core: 20 1/4" x 19" x 3 1/4"	AM238693A1	\$ 725.00	
Case® 410 BSN J7M480924, 420 BSN N7M466710, 420CT BSN N7M455401	Hydraulic Oil Cooler Core: 15.10" x 17" x 1.50"	AM87050342	\$ 878.00	
Case® 410 ASN N7M480924, 420 ASN N7M466710, 430 ASN N7M479683, 435 ASN N7M425032, 440 ASN N8M474469, 445 ASN N7M454787, 450 ASN N7M464018, 465 ASN N7M452623, Track Skid Steer Loaders: 420CT ASN N7M455401, 440CT ASN N7M483467, 445CT ASN N8M458846, 450CT ASN N7M464019	Hydraulic Oil Cooler	AM87687372	\$ 1011.00	
Case® 420, 430, 440, Track Skid Steer Loaders: 420CT, 440CT	Hydraulic Oil Cooler, High Flow	AM87015306	\$ 598.00	
Case® 430 BSN N7M479683, 435 BSN N8M425032, 440 BSN N7M474469, 440CT BSN N7M483467, 445 BSN N7M454787, 445CT BSN N8M458846, 450 BSN N7M458414, 450CT BSN N7M464019, 465 BSN N7M452623	Hydraulic Oil Cooler Core: 18" x 20" x 1.50"	AM87037766	\$ 472.00	
Case® Backhoe-Loaders: 580L, 580SL, Loader: 570XLT	Hydraulic Oil Cooler Core: 17.50" x 19" x 2.30"	AM233817A1	\$ 835.00	
Case® SR175, SR200, SV185, Track Skid Steer Loader: TR270, New Holland® L218, L220, Track Skid Steer Loader: C227	Hydraulic Oil Cooler	AM47778419	\$ 950.00	

Prices Subject to Change without Prior Notice. The use of original equipment manufacturer (OEM) part numbers or trademarks, e.g. Case® and John Deere®, are for reference purposes only and for indicating product use and compatibility. Our company and the listed replacement parts contained herein are not sponsored, approved or manufactured by the OEM. All parts are New unless designated Reman in the description.

Skid Steer Parts

Application	Description	Part Number	Retail Price	Core
Case® (SR175, SV185 - Medium Frame ISM Tier 4), (SR220, SV250, TV380 - Large Frame NR), (SR240, SV280 - Large Frame 55kW Tier 4), (SR250, SV300 - Large Frame NR or 67kW Tier 4A), Track Skid Steer Loaders: TR320 Large Frame NR, (TR320, TV380 - Large Frame 67kW Tier 4A), New Holland® (L218, L220 - Medium Frame ISM Tier 4), (L223, L225 - Large Frame NR), L228 Large Frame 55kW Tier 4, L230 Large Frame NR or 67kW Tier 4A, Track Skid Steer Loaders: C232 Large Frame NR or 55kW Tier 4, C238 Large Frame NR or 67kW Tier 4A	Hydraulic Oil Cooler 24" x 5 1/2" x 4 1/8" Replaces 47740439	AM84499497	\$ 506.00	
Case® SR210, Track Skid Steer Loaders: TR270, TR310, New Holland® L221, Track Skid Steer Loader: C227	Hydraulic Oil Cooler Core: 25" x 5.40" x 3" Replaces 47397778	AM47532228	\$ 297.00	
New Holland® C175, L175, L180	Hydraulic Oil Cooler Core: 18" x 20" x 1.50"	AM87014852	\$ 450.00	
New Holland® C185, C190, L180, L185, L190	Hydraulic Oil Cooler Core: 22 1/4" x 5 1/2" x 4 1/8"	AM87687378	\$ 454.00	
New Holland® L140, L160	Hydraulic Oil Cooler Replaces 87033309, 87033310	AM87014828	\$ 485.00	
New Holland® L160, L170	Hydraulic Oil Cooler	AM87104828	\$ 280.00	
New Holland® L175, L180, L185, L190, LS180.B, Track Skid Steer Loaders: C175, C190	Hydraulic Oil Cooler	AM87032488	\$ 560.00	
John Deere® 312GR, 313, 314G, 315, Track Skid Steer Loader: CT315	Hydraulic Oil Cooler	AMAT333628	\$ 464.00	
John Deere® 317, 320	Hydraulic Oil Cooler Core: 19" x 19" x 2.30"	AMKV23228	\$ 600.00	
John Deere® 318D, 320D, 326D, 328D, 332D, Track Skid Steer Loaders: 319D, 329D	Hydraulic Oil Cooler Core: 22 3/4" x 10" x 2 1/4"	AMAT360781	\$ 639.00	
John Deere® 318E, 319E, 320E	Hydraulic Oil Cooler Core: 19" x 9" x 3.10"	AMAT394353	\$ 409.00	
John Deere® 325, 328, 332	Hydraulic Oil Cooler Core: 20 5/6" x 22" x 3.10"	AMKV26892	\$ 765.00	
John Deere® 326E, 328E, 332E, Track Skid Steer Loader: 329E	Hydraulic Oil Cooler Core: 21 3/4" x 9" x 3"	AMAT400992	\$ 481.00	

Cylinders

Application	Description	Part Number	Retail Price	Core
Bobcat® 730, 731, 732	Bucket Cylinder Replaces 6539810, 6593398, 6598067	AM7104437	\$ 465.00	
Bobcat® 751, 753	Bucket Cylinder Replaces 6586907	AM6804692	\$ 490.00	
Bobcat® 753G, 763, 773 SN 509616001-509629999 & ASN 509635001	Bucket Cylinder Replaces 6539931, 6586587	AM6804630	\$ 475.00	
Bobcat® 843	Bucket Cylinder Replaces B18257	AM6539808	\$ 475.00	
Bobcat® 853	Bucket Cylinder Replaces 6539075	AM6586991	\$ 469.00	
Bobcat® 863	Bucket Cylinder Replaces 6596896, 6800466	AM6804674	\$ 495.00	
Bobcat® 773, S175, S185, S205, Track Skid Steer Loader: T190	Boom Lift Cylinder	AM7117667	\$ 650.00	
Bobcat® 863, 864, S220, T200, T250	Boom Lift Cylinder Replaces 6597008, 6800973, 6815757	AM6815757	\$ 795.00	
Bobcat® 873, 883	Boom Lift Cylinder	AM6811996	\$ 750.00	
Bobcat® A300, S250, S300, S330, Track Skid Steer Loaders: T300, T320	Boom Lift Cylinder	AM7106456	\$ 650.00	
Case® 1830 ASN 9845302, 1835, 1835B, 1835C, 1838, 1840	Bucket Cylinder Replaces G103407	AM118110A1	\$ 469.00	

Skid Steer Parts

Application	Description	Part Number	Retail Price	Core
Case® 1845, 1845B, 1845C	Bucket Cylinder Replaces G34926	AM118156A1	\$ 417.00	
Case® 1845, 1845B, 1845C	Boom Lift Cylinder Replaces 129011A1, 276260A1, G34917	AM117903A1	\$ 517.00	
John Deere® (240, 250 BSN 925238), 313, 315, Track Skid Steer Loaders: CT315, CT322, Loaders: 520, 521, 540, (540M, 540R, H240, H260, H310, H340 - Self-Leveling)	Hydraulic Cylinder Seal Kit, Bucket Cylinder Replaces AH231937	AMAH164325	\$ 18.29	
John Deere® 312GR, 316GR, 318D ASN 179866, Track Skid Steer Loaders: (319D, 320D, 323D ASN 179866)	Hydraulic Cylinder Seal Kit, Boom Cylinder Replaces AH231937	AMAH164325	\$ 18.29	
John Deere® Loaders: 520, 521, 540, (540M, 540R, H240, H260, H310, H340 - Self-Leveling)	Hydraulic Cylinder Seal Kit, Lift Cylinder Replaces AH231937	AMAH164325	\$ 18.29	
New Holland® L120, L125, L250, L255, LS120, LS125	Boom Cylinder Seal Kit	AM9610762	\$ 73.98	
New Holland® L150, L160, L170, L175, (L565, LX565, LX665 - w/ Threaded Gland), LS150, LS160, LS170, LX485 w/ 2.50" Bore, Track Skid Steer Loader: C175	Boom Cylinder Seal Kit Replaces 86527694, 86527695	AM86570922	\$ 45.22	
New Holland® L180, L185, L865, LS180, LS180.B, LS185.B, LX865, LX885, Track Skid Steer Loaders: C185, LT185.B	Bucket Cylinder Seal Kit Replaces 9843717, 89843717	AM86570931	\$ 53.42	





Hydraulic Components

Application	Description	Part Number	Retail Price	Core
Bobcat® (653, 751 SN 515611001-515611135), 753 SN 508611001-508689999, 763 SN 512212001-512229816, 773 SN 509610000-509615791, 7753	Hydraulic Pump 9 Spline, 5/8" Spline Diameter Replaces 6650678, 6667723	AM6669385	\$ 235.00	
Bobcat® 751 ASN 515611136, 751G, 753 ASN 508695348, 753G, 763 ASN 512229817763, 763G, 773 SN 509616792-509634999	Hydraulic Pump Replaces 6672051, 550136836	AM6672513	\$ 308.00	
Bobcat® 753, 763, 773, 863, 864, 873, 883, A220, A300, S130, S150, S160, S175, S185, S205, S220, S250, S300, S330, Track Steers Loaders: T180, T190, T200, T250, T300, T320	Bob-Tach Double Acting Cylinder 1.75" Bore, 1" Rod, 6.75" Stroke, 26.375" Pin-to-Pin Replaces 6810611, 7175388	AM7366550	\$ 395.00	
Bobcat® 773, S150, S160, S175, S185, S205, Track Skid Steer Loader: T180, T190	Bucket Cylinder	AM7117174	\$ 505.00	
Bobcat® A300, S220, S250, S300, S330, Track Skid Steer Loaders: T250, T300, T320	Bucket Cylinder	AM7208419	\$ 510.00	
New Holland® L140, L150, L160, L170, L175, L465, L565, L865, LS140, LS150, LS160, LS170, LS180, LS190, LX465, LX485, LX565, LX665, LX865, LX885, LX985, Track Skid Steer Loader: C175	Relief Valve For Control Valve	AM86529091	\$ 103.15	
John Deere® 240 ASN 440000, 250 ASN 450000, 260 ASN 460000, 270 ASN 470000, 280, (317, 320, 325, 328, 332 BSN 150523), Track Skid Steer Loaders: (CT322, CT332 BSN 150523)	Control Valve Solenoid	AMKV23085	\$ 199.21	
John Deere® (240, 250 BSN 925239), 313, 315, Track Skid Steer Loader: CT315	Hydraulic Cylinder Seal Kit For Bucket Cylinder	AMAH161589	\$ 32.64	





Lighting

Application	Description	Part Number	Retail Price	Core
	LED Wide Floodlight All-Position Light 5" x 7" Rectangle Light 3800 Lumens, 35 Watts For 12 Volt to 24 Volt Systems	AMX34171	\$ 60.00	

Skid Steer Parts

	Application	Description	Part Number	Retail Price	Core
	Bobcat® A770, S450, S510, S530, S550, S570, S590, S595, S630, S650, S740, S750, S770, S850, Track Skid Steer Loaders: T450, T550, T590, T595, T630, T650, T740, T750, T770, T870	LED Headlight, Right Hand Floodlight/Spotlight 5000 Lumens, 70 Watts, 5.80 Amps For 12 Volt to 24 Volt Systems Aluminum Housing and Durable Polycarbonate Lens Plug-and-Play for Direct Replacement	AMTL970R	\$ 140.00	
		LED Headlight, Left Hand Flood/Spotlight 5000 Lumens, 70 Watts, 5.80 Amps For 12 Volt to 24 Volt Systems Aluminum Housing and Durable Polycarbonate Lens Plug-and-Play for Direct Replacement	AMTL970L	\$ 140.00	
		LED Headlight, Right Hand 5000 Lumens, 70 Watts, 5.80 Amps For 12 Volt to 24 Volt Systems	AM7251340	\$ 112.00	
		LED Headlight, Left Hand 5000 Lumens, 70 Watts, 5.80 Amps For 12 Volt to 24 Volt Systems	AM7251341	\$ 112.00	
	Bobcat® 553, 751, 753, 763, 773, 853, 863, 864, 873, 883, 943, 963, 7753, A250, A300, A770, S100, S130, S150, S160, S175, S185, S205, S250, S450, S510, S530, S550, S570, S590, S595, S630, S650, S740, S750, S770, S850, T110, T140, T180, T190, T250, T300, T320, T450, T550, T590, T595, T630, T650, T740, T750, T770, T870, New Holland® L465, L565, L865, LX465, LX485, LX565, LX665, LX865, LX885	LED Floodlight 4.90" x 3" x 2.50" Rectangle Light 2000 Lumens, 24 Watts, 2 Amps For 12 Volt to 24 Volt Systems Fits into Original Housing, Plug-and-Play Replaces 6661353	AMTL650	\$ 70.00	
		LED Headlight 4.90" x 3" x 2.50" Rectangle Light 2000 Lumens, 24 Watts, 2 Amps For 12 Volt to 24 Volt Systems Fits into Original Housing, Plug-and-Play Replace 6661353	AM9829523	\$ 56.00	
	Case® 40XT, 70XT, 75XT, 85XT, 90XT, 95XT, 410, 420, 430, 435, 440, 445, 450, 465, Track Skid Steer Loaders: 420CT, 440CT, 445CT, 450CT, New Holland® L120, L125, L140, L150, L160, L170, L175, L180, L185, L190, Track Skid Steer Loaders: C175, C185, C190, John Deere® 240, 250, 260, 270, 280, 315, 317, 320, 325, 328, 332, Track Skid Steer Loaders: CT315, CT322, CT332	LED Headlight w/ Clip Upper Front Cab and Rear Work/Reverse Mount 3" x 5" x 3" Rectangle Light 200 Lumens, 24 Watts, 2 Amps For 12 Volt to 24 Volt Systems Plug-and-Play for Direct Replacement Replaces 222004A2, 9844417, 9844418, 86501306, 86533428, AT345169, KV13708, KV13709, KV26918	AMTL750	\$ 70.00	
		LED Headlight w/ Clip Upper Front Cab and Rear Work/Reverse Mount 3" x 5" x 3" Rectangle Light 200 Lumens, 24 Watts, 2 Amps For 12 Volt to 24 Volt Systems Plug-and-Play for Direct Replacement Replaces 222004A2, 9844417, 9844418, 86501306, 86533428, KV13708, KV13709, KV26918	AMAT345169	\$ 56.00	
		LED Headlight 4.80" x 3.25" x 3" Floodlight 2100 Lumens, 30 Watts, 2.50 Amps For 12 Volt to 24 Volt Systems Fits into Original Housing, Plug-and-Play Replaces 84306271, 84306337	AMTL780	\$ 80.00	
	Case® SR130, SR150, SR160, SR175, SR200, SR220, SR240, SR250, SV185, SV250, SV300, Track Skid Steer Loaders: TR270, TR310, TR320, TV380, New Holland® L213, L215, L216, L221, Track Skid Steer Loaders: C227, C238	LED Headlight 4.80" x 3.25" x 3" Floodlight 2100 Lumens, 30 Watts, 2.50 Amps For 12 Volt to 24 Volt Systems Fits into Original Housing, Plug-and-Play Replaces 84306271, 84306337	AMTL780	\$ 80.00	
		LED Headlight 4.80" x 3.25" x 3" Floodlight 2100 Lumens, 30 Watts, 2.50 Amps For 12 Volt to 24 Volt Systems Fits into Original Housing, Plug-and-Play Replaces 84306271, 84306337	AM84306268	\$ 64.00	

Skid Steer Parts









Application	Description	Part Number	Retail Price	Core
 John Deere® 240	LED Trapezoid Light Fender Mount 4.50" Sealed Beam Round Light 2800 Lumens, 40 Watts, 3.30 Amps For 12 Volt to 24 Volt Systems Rear Stud Mount with Built-In Heat Sink Includes Both Long and Short Rubber Bezels	AMTL2060	\$ 95.00	
	Headlight Sealed Beam, 12 Volt, 2-Wire	AMRE25126	\$ 45.00	
 Kubota® SVL65-2, SVL65-2C, SVL75, SVL75-2, SVL75-2C, SVL75C, SVL90, SVL90-2, SVL90-2C, SVL90C, SVL95-2S, SVL95-2SC	LED Headlight 6" x 3" x 2.50" Rectangle Light 300 Lumens, 40 Watts, 3.33 Amps For 12 Volt to 24 Volt Systems Includes Connector and Stainless Steel Hardware	AMTL790	\$ 85.00	
	LED Headlight 6" x 3" x 2.50" Rectangle Light 300 Lumens, 40 Watts, 3.33 Amps For 12 Volt to 24 Volt Systems Includes Connector and Stainless Steel Hardware	AMV0511-53510	\$ 68.00	
 Universal Skid Steer Loaders	Blue LED Warning Light Die Cast Aluminum Housing, Polycarbonate Lens For 12 Volt to 24 Volt Systems Includes Stainless Steel Hardware	AMTLFL20	\$ 95.00	
 Bobcat® 450, 453, 463, 553, 653, 751, 753, 763, 773	LED Headlight Conversion Kit Includes (2) 6" x 3.50" x 3" Rectangle Floodlights Each Light is 7200 Lumens, 80 Watts, 6.60 Amps For 12 Volt to 24 Volt Systems Will Require to Splice into Original Wiring Harness Includes (2) LED Lights, (2) Mounting Plates and Stainless Steel Hardware Replaces 6649478	AMTL5015	\$ 175.00	
 Bobcat® Skid Steer Loaders: 751, 753, 763, 773, 863, 864, 873, 963, A220, A300, S130, S150, S160, S175, S185, S205, S220, S250, S300, S330, Track Skid Steer Loaders; T110, T140, T180, T190, T200, T250, T300, T320	LED Headlight Triangle Light 2500 Lumens, 30 Watts, 2.50 Amps Aluminum Housing, Polycarbonate Lens For 12 Volt to 24 Volt System Plug-and-Play Installation Replaces 6718042, 6718043, 7259523, 7259524	AMTL950	\$ 95.00	

Cab Components—Miscellaneous

Application	Description	Part Number	Retail Price	Core
Case® 75XT, 85XT, 90XT, 95XT	Windshield Wiper Motor, Front 12 Volt Replaces 427087A, 87714999	AMA186256	\$ 145.00	
240, 250, 260, 270, 280, 317, (318D, 318E, 319E, 320D, 320E, 323E, 324E, 326D, 326E, 328D, 328E, 332D, 332E - w/ Severe Duty Door), 320, 325, 328, 332, Track Skid Steer Loaders: (319D, 323D, 329D, 329E, 333D, 333E - w/ Severe Duty Door), CT322, CT332	Gas Strut, Canopy Tilt 46" Overall Length	AMAT362148	\$ 49.07	

Skid Steer Parts

Glass

	Application	Description	Part Number	Retail Price
	Bobcat® 751G, 753G, 763G, 773G, 863G, 864G, 873G, 883, 963G, A220, S175, S185, T190, T200	Front Windshield Glass Curved Glass, Tinted w/ 1" Wiper Motor Hole	AM6729776	\$ 135.00
	Bobcat® 542, 543, 553, 643, 645, 653, 741, 742, 743, 751, 753, 763, 773, 843, 853, 863, 864, 873, 943, 953, 963	Side Glass, Stationary Right or Left Hand	AM6702731	\$ 149.65
	Bobcat® 751, 753, 763, 773, 853, 863, 873, 883, 953, 963, 7753, A250, A300, S100, S130, S150, S160, S175, S185, S205, S220, S250, S300, S330, T110, T140, T180, T190, T200, T250, T300, T320	Rear Side Glass, Stationary Left Hand Replaces 6674520	AM6691001	\$ 51.25
	Bobcat® 751, 753, 763, 773, 863, 873, 883, 963, A220, A300, S100, S130, S150, S160, S175, S185, S205, S220, S250, S300, Track Skid Steer Loaders: 864, T180, T190, T200, T250, T300, T320	Rear Glass	AM6717874	\$ 59.50
	Case® SR130, SR150, SR175, SR200, SR220, SR250, SV185, SV250, SV300, Track Skid Steer Loaders: TR270, TR320, New Holland® (L213, L215, L220, L225, L230, Track Skid Steer Loaders: C227, C232, C238 - All Prior to 02/2013)	Front Windshield Glass For Single Wiper Arm	AM84344565	\$ 161.00
	Case® SR130, SR150, SR175, SR200, SR220, SR250, SV185, SV250, SV300, Track Skid Steer Loaders: TR270, TR320, New Holland® (L213, L215, L220, L225, L230, Track Skid Steer Loaders: C227, C232, C238 - All 02/2013 and Later)	Front Windshield Glass For Dual Wiper Arm	AM47405930	\$ 220.00
	New Holland® L160, L170, L180, L185, L190, LS160, LS170, LS180, LS185, LS185.B, LS190.B - w/ Deluxe Cab	Front Windshield Glass	AM87635930	\$ 138.00
	New Holland® L160, L170, L175, L180, L185, L190, (L565, L865, LX565, LX665, LX865, LX885, LX985 - w/ New Style Door and Motor), LS160, LS170, LS180, LS180.B, LS185.B, LS190, LS190.B, LT185.B, LT190.B, Track Skid Steer Loaders: C175, C185, C190	Front Windshield Glass	AM86547915	\$ 54.00
	John Deere® 318D, 320D, 326D, 326E, 328D, 328E, 332D, 332E	Front Windshield Glass	AMT312628	\$ 210.00
	John Deere® (318E, 319E, 320E, 323E, 324E, 326E, 328E, 332E ASN 269402), 320G, 324G, 325G, 330G, 332G, Track Skid Steer Loaders: 331G, 333G, (329E, 333E ASN 269402)	Front Windshield Glass	AMT344818	\$ 311.68

Skid Steer Parts

Application	Description	Part Number	Retail Price
 New Holland®: L213, L215, L216, L218, L220, L221, L223, L225, L228, L230, L234, Track Skid Steer Loaders: C227, C232, C234, C238	Weatherstrip For Cab Door	AM84368761	\$ 17.00



Fuel Components

Application	Description	Part Number	Retail Price	Core
John Deere® 240, 250, 260, 270, 280	Fuel Hose	AMRE501739	\$ 28.12	
John Deere® 280	Fuel/Water Separator Replaces RE52987, RE53400, RE62418	AMRE62419	\$ 15.00	
John Deere® 8875	Fuel Filter Head Assembly	AMRE500160	\$ 74.07	











Gas Struts

Application	Description	Part Number	Retail Price	Core
Case® 75XT, 85XT, 90XT, 95XT, 410 BSN N7M480924, 420 BSN N7M466710, 435, 445, 450, 465, SR130, SR150, SR160, SR175, SR200, SR210, SR220, SR240, SR250, SR270, SV185, SV250, SV280, SV300, SV340, Track Skid Steer Loaders: 445CT, 450CT, TR270, TR310, TR320, TR340, TV380	Gas Strut, Rear Hood Replaces 297891A1, 400473A1, 47567966	AM400472A1	\$ 56.00	
John Deere®: 240, 250, 260, 270, 280, 313, 315, 317, 320, 325, 328, 332, Track Skid Steer Loaders: CT315, CT322, CT332	Gas Strut, Door	AMT217241	\$ 25.39	
John Deere® (318D, 318E, 319E, 320D, 320E, 323E, 326D, 326E, 328D, 328E, 332D, 332E BSN 269401), Track Skid Loaders: (319D, 323D, 329D, 329E, 333D, 333E BSN 269401)	Gas Strut, Door	AMT249397	\$ 44.62	



Air Conditioning and Components

Application	Description	Part Number	Retail Price
 Bobcat® 430	Compressor, Seltec/Tama TM-08 Style 12 Volt, w/ 6-Groove Clutch for Serpentine Belt, 4.72" (120 mm) Clutch Diameter, Vertical #8 and #10 O-Ring	AM6681716	\$ 350.00
	Compressor 12 Volt, w/ 2-Groove Clutch, 4.92" (125 mm) Clutch Diameter, 0.50" Belt Width, Vertical #8 and #10 O-Ring Requires Synthetic Ester Oil 100V, 5.07 oz (150 cc) Replaces 6675667 Premium Synthetic Ester Oil, 100V, 12 oz	AM6733655	\$ 315.00
 Bobcat® S150, S160, S185, S205, T180, T190, T190G	Compressor 12 Volt, w/ 2-Groove Clutch, 4.92" (125 mm) Clutch Diameter, 0.50" Belt Width, Vertical #8 and #10 O-Ring Requires Synthetic Ester Oil 100V, 5.07 oz (150 cc) Replaces 7023582 Premium Synthetic Ester Oil, 100V, 12 oz	AM7136676	\$ 360.00
	Compressor 12 Volt, w/ Single Groove Clutch, 5" (120 mm) Clutch Diameter, 7/16" (12 mm) Belt Width, Vertical #8 and #10 O-Ring Requires Synthetic Ester Oil 100V, 4.56 oz (135 cc) Premium Synthetic Ester Oil, 100V, 12 oz	AMX10273	\$ 11.00
 Bobcat® S550, S570, S590, T590	Compressor 12 Volt, w/ 2-Groove Clutch, 4.92" (125 mm) Clutch Diameter, 0.50" Belt Width, Vertical #8 and #10 O-Ring Requires Synthetic Ester Oil 100V, 5.07 oz (150 cc) Premium Synthetic Ester Oil, 100V, 12 oz	AM7023583	\$ 280.00
	Compressor 12 Volt, w/ Single Groove Clutch, 5" (120 mm) Clutch Diameter, 7/16" (12 mm) Belt Width, Vertical #8 and #10 O-Ring Requires Synthetic Ester Oil 100V, 4.56 oz (135 cc) Premium Synthetic Ester Oil, 100V, 12 oz	AMX10273	\$ 11.00

Skid Steer Parts

	Application	Description	Part Number	Retail Price
	Bobcat® S650, S750, S850, T630, T650, T770, T870	Compressor, Sanden SD5H11 Style 12 Volt, w/ 6-Groove Clutch, 4.92" (125 mm) Clutch Diameter, Vertical #8 and #10 O-Ring Replaces 6698590	AM7023580	\$ 415.00
	Case® 85XT, 90XT, 95XT	Compressor, Sanden SD7H15 12 Volt, w/ 2-Groove Clutch, 6" Clutch Diameter, Horizontal Tube O-Ring Requires Synthetic Ester Oil 100V, 9.60 oz (285 cc) Premium Synthetic Ester Oil, 100V, 12 oz	AMX10125 AMX10273	\$ 240.00 \$ 11.00
	Case® (420, 450 w/ Tier 3 Engine), 430 ASN N7M457282, 435 ASN N8M469898, 440, 445 ASN N7M454787, 465, Track Skid Steer Loaders: 420CT, 440CT, 445CT ASN N7M454787, New Holland® L180, L185 ASN N8M465247, L190, Track Skid Steer Loaders: C185 ASN N8M469898, C190 ASN N7M457282 Replaces 84322106, 84322107, 87623657, 87626267, 87626268, 87681242, 87681243	Compressor, Sanden SD5H11 Style 12 Volt, w/ 4-Groove Clutch for Serpentine Belt, 4.68" (119 mm) Clutch Diameter Distance Between Mounting Holes: 2.885" (Between Ears), Vertical #8 and #10 O-Ring Requires Synthetic Ester Oil 100V, 4.56 oz (135 cc) Premium Synthetic Ester Oil, 100V, 12 oz	AM87649991 AMX10273	\$ 275.00 \$ 11.00
	Case® SR175, SV185, New Holland® L218, L220	Compressor, Sanden SD5H11 Style w/ 2-Groove Clutch, 6" (152 mm) Clutch Diameter Distance Between Mounting Holes: 2.885" (Between Ears)	AM84321962	\$ 340.00
	Case® SR175, SV185, New Holland® L218, L220	Compressor, Sanden SD5H11 Style 12 Volt, w/ 6-Groove Clutch for Serpentine Belt, 6" Clutch Diameter, 1-Wire, Vertical #8 and #10 O-Ring	AM84545270	\$ 715.00
	Case® SR200, SR210, SR220, SR240, SR250, SR270, SV250, SV280, SV300, Track Skid Steer Loaders: TR270, TR320, TR340, TV380, New Holland® L221, L223, L225, L230, Track Skid Steer Loaders: C227, C232, C2383 Replaces 84321961, 84321961R	Compressor, Sanden SD5H11 Style 12 Volt, w/ 4-Groove Clutch for Serpentine Belt, 5.50" (140 mm) Clutch Diameter, Vertical #8 and #10 O-Ring Requires Synthetic Ester Oil 100V, 4.56 oz (135 cc) Premium Synthetic Ester Oil, 100V, 12 oz	AM84321961C AMX10273	\$ 270.00 \$ 11.00
	John Deere® 260, 270, 280, 317, 320, 325, 328, 332, Track Skid Steer Loader: CT322	Compressor, Nippondenso Style 12 Volt, w/ 8-Groove Clutch for Serpentine Belt, 5.75" (146 mm) Clutch Diameter, Must use Original Manifold Requires Pag Oil ND8, 7.77 oz (230 cc) Denso ND8 Pag Oil, 46V, 8.50 oz	AMX10139 AMX10272	\$ 250.00 \$ 30.00
	John Deere® 318D, 319D, 320D, 323D, 326D, 328D, 329D, 332D, 333D	Compressor, Nippondenso Style 12 Volt, w/ 8-Groove Clutch for Serpentine Belt, 4.90" Clutch Diameter, Must use Original Manifold Requires Pag Oil 46V, 5.40 oz (160 cc) Ultra Pag Double End Capped, 46V, 8 oz	AMX10140 AMX10266	\$ 315.00 \$ 12.00
	John Deere® 318D, 319D, 320D, 323D, 326D, 328D, 329D, 332D, 333D	Compressor, Denso 10PA15C Style 12 Volt, w/ 8-Groove Clutch for Serpentine Belt, 4.901" (124.50 mm) Clutch Diameter, w/o Manifold Requires Pag Oil ND8, 5.40 oz (160 cc) Denso ND8 Pag Oil, 46V, 8.50 oz	AMAL176858 AMX10272	\$ 345.00 \$ 30.00
	John Deere® 318E, 319E, 320E, 323E, 326E, 328E, 329E, 332E, 333E	Compressor, Denso 10SRE18C Style 12 Volt, w/ 8-Groove Clutch for Serpentine Belt, 5.635" Clutch Diameter Requires Synthetic Ester Oil 100V, See Manufacturer for Oil Quantity Premium Synthetic Ester Oil, 100V, 12 oz	AMRE326205 AMX10273	\$ 425.00 \$ 11.00
	John Deere® 332, Track Skid Steer Loaders: CT322, CT332	Compressor, Nippondenso 10PA17C Style 12 Volt, w/ Single Groove Clutch, 5.748" (146 mm) Clutch Diameter, Must use Original Manifold Requires Pag Oil ND8, 7.77 oz (230 cc) Denso ND8 Pag Oil, 46V, 8.50 oz	AMX10137 AMX10272	\$ 250.00 \$ 30.00

















Skid Steer Parts

Application	Description	Part Number	Retail Price
 Bobcat® 864, 873, A300, S150, S160, S175, S185, T190, T190G, T200	Compressor Clutch 12 Volt Weatherpack Coil, 2-Groove, 4.92" (125 mm) Clutch Diameter Use w/ AM6733655 Compressor Replaces 6679145	AM6679145	\$ 155.00
 Case® 85XT, 90XT, 95XT	Compressor Clutch SD7H15 Clutch w/ 12 Volt Coil, 2-Groove, 5.98" Clutch Diameter, 0.47" Groove Width Use w/ AMX10125 Compressor	AM135324A2	\$ 120.00
 Universal Equipment	Low Pressure Switch Normally Open, Opens at 6 PSI, Closes at 45 PSI, Standard 7/16"x20 Thread	AMX10277	\$ 55.00
 Universal Equipment	Low Pressure Switch Normally Open, Opens at 35 PSI, Closes at 46 PSI, Standard 7/16"x20 Thread	AMX10278	\$ 42.00
 Bobcat® 430	Low Pressure Switch Normally Open, Opens 10 PSI, Closes 20 PSI, 7/16" x 20 Thread	AM6679095	\$ 40.00
 Case® 85XT, 90XT, 95XT	Low Pressure Switch Normally Closed, Opens at 23 PSI, Closes at 7 PSI, 10 mm Metric Thread	AM122579A1	\$ 44.00
 Case® SR175, SR200, SR210, SR220, SR240, SR250, SR270, SV185, SV250, SV280, SV300, Track Skid Steer Loaders: TR270, TR310, TR320, TR340, TV380, New Holland® L218, L220, L221, L223, L225, L228, L230, Track Skid Steer Loaders: C227, C232, C238	Low Pressure Switch Normally Open, Opens at 20 PSI, Closes at 7 PSI, 10 mm Metric Thread	AM84419250	\$ 65.20
 Universal Equipment	High Pressure Switch Normally Open, Opens at 305 PSI, Closes at 395 PSI, 7/16"x20 Thread	AMX10276	\$ 35.00
 Case® SR175, SR200, SR210, SR220, SR240, SR250, SR270, SV185, SV250, SV280, SV300, Track Skid Steer Loaders: TR270, TR310, TR320, TR340, TV380, New Holland® L218, L220, L221, L223, L225, L228, L230, Track Skid Steer Loaders: C227, C232, C238	High Pressure Switch Normally Closed, Opens at 390 PSI, Closes at 240 PSI, 10 mm Metric Female Thread	AM87000227	\$ 58.00
 John Deere® 317, 318D, 318E, 319E, 320, 320D, 320E, 323D, 323E, 325, 326D, 326E, 328, 328D, 328E, 329D, 332D, 332E, 333D, Track Skid Steer Loaders: CT322, CT332 Replaces A22-30930-000, ABPN83318179, ABPN83322315, RE60888	Pressure Switch, Binary/Dual Function Normally Open, Low Pressure Opens at 28 PSI, Closes at 30 PSI, High Pressure Opens at 445 PSI, Closes at 370 PSI, M10x1.25 Metric Thread	AMRE157329	\$ 24.00
 Bobcat® 864, A300, S150, S160, S175, S185, S205, S220, S550, S590, S650, S750, S850, T190, T190G, T200, T300, T320, T550, T590, T630, T650, T750, T770, T870	Binary Pressure Switch 9" Long, Normally Open Low Pressure Opens at 26 PSI, Closes at 28 PSI High Pressure Opens at 390 PSI, Closes at 260 PSI 7/16"x20 Female Flare Thread	AM6675779	\$ 40.00
 Bobcat® 864, A300, S150, S160, S175, S185, S205, S220, S550, S570, S590, S650, S750, S850, T190, T190G, T200, T300, T320, T550, T590, T630, T650, T750, T770, T870	Binary Pressure Switch 28.50" Long, Normally Open Low Pressure Opens at 26 PSI, Closes at 28 PSI High Pressure Opens at 390 PSI, Closes at 260 PSI 7/16" x 20 Female Flare Thread	AM7244124	\$ 26.00

Skid Steer Parts

	Application	Description	Part Number	Retail Price
	Bobcat® 430 BSN 562911001	Thermostatic Switch, Electronic	AM6683911	\$ 150.00
	Bobcat® (430, 864, A300, S150, S160, S220, S300, T190, T190G, T200, T320, ASN 562911001)	Thermostatic Switch, Electronic	AM6683004	\$ 119.00
	Case® 410, 420, 430, 435, 440, 445, 450, 465, Track Skid Steer Loaders: 420CT, 440CT, 445CT, 450CT, New Holland® Skid Steer Loaders: L175, L180, L185, L190, LS180, LS180.B, LS185.B, LS190, LS190.B, Track Skid Steer Loaders: C175, C185, C190, LT185.B, LT190.B	Thermostatic Switch 24" Capillary Tube	AM86625480	\$ 32.00
	Bobcat® 430, 773, 864, 873, 883, A300, S150, S160, S175, S185, S220, S250, S300, S330, S550, S570, S590, S630, S650, S750, S850, T180, T190G, T200, T250, T300, T320, T550, T590, T630, T650, T750, T770, T870 Replaces 6674235, 6680311	Receiver Drier 3" x 6.25", Inlet - #6 Male O-Ring, Outlet - #6 Male O-Ring, R12 and R134a Compatible	AM7025583	\$ 32.00
	Bobcat® S750, T550, T590, T630 SN A7PU11001-A7PU14099, T870	Receiver Drier, Heavy Duty 3" x 6", Inlet - #6 Male O-Ring, Outlet - #6 Male O-Ring, Dry-Tech Series, w/o Switch	AM7025095	\$ 40.00
	Case® 85XT, 90XT, 95XT Replaces 143469C2, 1990758C2	Receiver Drier 4" x 7 3/4", Inlet - #6, 3/8" Male O-Ring, Outlet - #6, 3/8" Female O-Ring, Front Mount, R12 and R134a Compatible	AMX10161	\$ 30.00
	Case® 410 ASN N7M480924, 420 ASN N7M466710, 430, 435 BSN N7M425032, 440 ASN N8M474469, 445, 450, 465 BSN N7M452623, Track Skid Steer Loaders: 420CT ASN N7M455401, 440CT, 445CT, 450CT, New Holland® L175, L180 BSN N8M464425, L185 ASN N8M465249, L190, LS180.B, LS185.B, LS190, LS190.B, Track Skid Steer Loaders: C175, C185, C190, LT185.B	Receiver Drier 2.50" x 6", Inlet - 18 mm, Outlet - 18 mm, R12 and R134a Compatible	AM86625481	\$ 23.00
	Case® SR175, SR200, SR210, SR250, SV185, Track Skid Steer Loaders: TR270, TV380 Replaces 295006A1	Receiver Drier	AMX10154	\$ 25.00
	Case® SR175, SR200, SR210, SR250, SV185, SV250, SV300, Track Skid Steer Loaders: TR270, TV380, New Holland® L218, L220, L223, L225, L230	Receiver Drier, Import 4" x 7 1/2", Inlet - #6 Female O-Ring, Outlet - #6 Male O-Ring, R12 and R134a Compatible	AMX10208	\$ 22.00
	John Deere® 240, 250, 260, 280, 317, 320, 325, 328	Receiver Drier 3" x 7" Male O-Ring, Inlet - #6 3/8" Male O-Ring, Outlet - #6 3/8" Male O-Ring, Male Switch Port, R12 and R134a Compatible	AM3383321M1	\$ 23.00
	John Deere® 317, 320, 325, 328, 332, CT322, CT332 Replaces AH234099, AT125596, AT162848, AXE53638	Receiver Drier 4" x 9", Inlet - #6 3/8" Female O-Ring, Outlet - #6 3/8" Male O-Ring, R12 and R134a Compatible Replaces AH234099, AT125596, AT162848, AXE53638	AMX10156	\$ 36.00
	John Deere® 318D, 318E, 319D, 319E, 320D, 320E, 323D, 323E, 326D, 326E, 328D, 328E, 329D, 329E, 332D, 333D, 333E	Receiver Drier 3" x 11 1/2", Inlet - #6 3/8" Female O-Ring, Outlet - #6 3/8" Male O-Ring, R12 and R134a Compatible	AMRE214440	\$ 28.00

Skid Steer Parts













Application	Description	Part Number	Retail Price
 Bobcat® 430, 773, 864, 873, A300, S150, S160, S175, S185, S205, S220, S250, S550, S570, S590, S630, S650, S750, S850, Track Skid Steer Loaders: T190, T190G, T200, T300, T320, T550, T590, T630, T650, T750, T770, T870 Replaces 4379-RD5-6868-0, 60012-5011	Expansion Valve Block Type, R12 and R134a Compatible, O-Ring Connection	AMX10151	\$ 24.00
 Case® 85XT, 90XT, 95XT, SV185	Expansion Valve Block Type, R12 and R134a Compatible, O-Ring Connection	AMX10150	\$ 26.00
 Case® 410 ASN N7M480924, 420 ASN N7M466710, 430, 435 BSN N7M425032, 440 ASN N8M474469, 445, 450, 465 BSN N7M452623, Track Skid Steers: 420CT ASN N7M455401, 440CT, 445CT, 450CT, New Holland® L175, L180 BSN N8M464425, L185 ASN N8M465249, L190, LS180.B, LS185.B, LS190, LS190.B, Track Skid Steer Loaders: C175, C185, C190, LT185.B	Expansion Valve	AM87035782	\$ 31.50
 John Deere® 240, 250, 260, 270, 280, 317, 320, 325, 328, 332, Track Skid Steer Loaders: CT322, CT332	Expansion Valve R12 and R134a Compatible, O-Ring Connection, Mounting Holes: 1/4"	AMKV22928	\$ 51.00
 John Deere® 318D, 318E, 319D, 319E, 320D, 320E, 323D, 323E, 326D, 326E, 328D, 328E, 329D, 329E, 332D, 332E, 333D, 333E	Expansion Valve Flange Type, O-Ring Connection	AMAT371672	\$ 44.00
 John Deere® (325, 328, 332 ASN 118058), Track Skid Steer Loaders: CT322 ASN 118058, CT332 ASN 118029 Replaces AL160578, RE283957	Expansion Valve Flange Style, R12 and R134a Compatible	AMRE174764	\$ 20.00
 Bobcat® 430	Compressor to Condenser Hose	AM6680303	\$ 70.00
 Bobcat® S175, S185, S205, T320	Compressor to Condenser Hose	AM6726661	\$ 58.00
 Bobcat® 430	Receiver Drier to Expansion Valve Hose	AM6680305	\$ 60.00
 Bobcat® 773, 863, 864, 883, A220, A300, S130, S175, S185, S205, S250, S330, T140, T180, T190G, T200, T250, T300, T320 Replaces 6675075	Receiver Drier to Expansion Valve Hose	AM6698442	\$ 61.00
 Bobcat® 430	Condenser to Receiver Drier Hose	AM6680304	\$ 55.00
 Bobcat® S175, S185, S205, T320	Condenser to Receiver Drier Hose	AM6727414	\$ 70.00
 Bobcat® 863, 864, 874, 883, A220, A300, S130, S175, S185, S205, S220, S250, S330, T140, T180, T190G, T200, T250, T300	Suction Hose Expansion Valve End	AM6675076	\$ 48.00
 Bobcat® S175, S185, S205, T320	Suction Hose Compressor End	AM6726656	\$ 45.00
 Bobcat® S175, S185, S205, T320	Suction Hose Expansion Valve End	AM6726623	\$ 45.00
 Bobcat® A300, S185, S220, T300	Blower Motor Assembly, HD 12 Volt	AM6675497	\$ 315.00

Skid Steer Parts

Skid Steer Parts

	Application	Description	Part Number	Retail Price
	Bobcat® S550, S570, S590, S750, T590, T630, T650, T750, T870	Blower Motor Assembly 12 Volt, Includes 3-Speed Resistor and Wiring Harness Replaces 7249527	AM7193536	\$ 305.00
	Case® 75XT, 85XT, 90XT, 95XT	Blower Motor Assembly 12 Volt, Resistor and Wiring Harness Not Included	AM178454A2	\$ 160.00
	Case® (420, 440 BSN N7M483467), 430, Track Skid Steer Loader: 440CT BSN N7M483467 Replaces 87383273	Blower Motor Assembly 12 Volt	AM87029689	\$ 240.00
	New Holland® L175, L185, LX885	Blower Motor Assembly 12 Volt, Includes 3-Speed Resistor and Wiring	AM86592107	\$ 225.00
	New Holland® L465, L565, L865, LX465, LX485, LX565, LX665, LX865, LX885, LX985	Blower Motor Assembly 12 Volt, w/ Mechanical Heat Control Replaces 86504771	AM86504790	\$ 305.00
	Bobcat® 753, 763, 773, 864, 873, 963, 733G, 751G, 773T, 963G, A220, A220G, A300, A300G, S130, S150G, S160, S175, S175G, S185, S185G, S205, S220, S220G, S250, S300, S330, T140, T180, T180G, T190, T190G, T200, T200G, T250, T250G, T300, T300G, T320 Replaces 446991C1, 80130185, ABPN83301162, EDE6LH-19805-A	Blower Motor, Vented 12 Volt, Vented Motor, 3-Speed, Double Shaft, Stud or Strap Mount, 5/16" Shaft Diameter, 3 1/8" Long	AM6675509	\$ 70.00
	Bobcat® A300, S100, S205, S550, S570, S590, S850, T190, T190G, T320, T590, T630, T650, T750, T770, T870	Blower Motor 12 Volt, Single Speed, Double Shaft, 2-Wire, Reversible, 5/16" Shaft Diameter, 2 29/32" Long, 3" Motor Diameter, 2 3/4" Long, For Heaters w/ Plastic Housing	AM7010163	\$ 220.00
	New Holland® L553, L555, L781, L783, L785	Blower Motor 12 Volt, Single Speed, Single Shaft, 1-Wire, CCW Rotation, 5/16" Shaft Diameter, 3/4" Long	AM9843214	\$ 79.00
	New Holland® L553, L785	Blower Motor 12 Volt, Single Speed, Single Shaft, 2-Wire, Reversible, 1/4" Shaft Diameter, 1 1/2" Long	AM6630980	\$ 48.00
	New Holland® LX465, LX485, LX565, LX665, LX865, LX885, LX985, John Deere® 8875	Blower Motor Single Speed, Double Shaft, 2-Wire, Reversible, 5/16" Shaft Diameter, 2 1/2" Long	AMX10110	\$ 55.00
	Bobcat® 553, 653, 751, 753, 763, 773, 853, 863, 873, 883, 963, 7753	Heater Motor 12 Volt, Single Speed Vented Motor, Single Shaft, 2-Wire, Reversible, Stud or Strap Mount, 5/16" Shaft Diameter, 1 3/8" Long	AM6660876	\$ 60.00
	Bobcat® A220, A300, S100, S130, S150, S160, S175, S185, S205, S220, S250, S300, S330, T110, T180, T190, T250, T300, T320	Blower Wheel, Plastic Reversible, Double Vented, 4 5/16" Diameter, 3 15/32" Long, 5/16" Shaft	AM6675505	\$ 35.00
	Bobcat® S205, S550, S570, S590, S650, S750, S850, T190, T320, T590, T630, T650, T750, T770, T870	Blower Wheel, Plastic Reversible, 4 1/8" Diameter, 3 1/2" Long, 5/16" Shaft	AM7010167	\$ 19.00
	Case® 420, SV185, New Holland® L218, L220, Track Skid Steer Loaders: C175, C185, C190	Blower Motor Switch, 3-Speed	AM271105M1	\$ 6.50

Skid Steer Parts

Application	Description	Part Number	Retail Price
 Bobcat® 430, 453C, 453D, 453F	Condenser Fan Assembly 12 Volt, 2-Wire, CCW Rotation, 10 1/2" OD	AM218-6250	\$ 95.00
 Case® SR175, SR200, SR210, SR220, SR240, SR250, SR270, SV185, SV250, SV280, SV300, Track Skid Steer Loaders: TR270, TR310, TR320, TR340, TV380, New Holland® L218, L220, L221, L223, L225, L228, L230, Track Skid Steer Loaders: C227, C232, C238	Condenser Fan Assembly High Performance	AM47395178	\$ 148.00
 Bobcat® 331, 335, 341	Condenser	AM6682037	\$ 300.00
 Bobcat® 430, 435	Condenser	AM7135618	\$ 275.00
 Bobcat® 864, T200	Condenser	AM667434	\$ 260.00
 Bobcat® S150, S160, S175, S185, T190	Condenser	AM6733001	\$ 350.00
 Caterpillar® 236B, 246B, 248B, 252B, 262B, 267B, 268B, 277B, 287B	Condenser	AM2186807	\$ 320.00
 New Holland® C190, L175	Condenser	AM87546517	\$ 525.00
 New Holland® C190, L175	Condenser w/ Brackets	AM87681242	\$ 490.00
 CaseH® SR220, SR250, SV250, SV300, Track Skid Steer Loaders: TR320, TV380, New Holland® L225, L230, Track Skid Steer Loaders: C232, C238	Charge Air Cooler	AM84515801	\$ 485.00
 John Deere® (318D, 319D, 320D, 323D, 326D, 328D, 329D, 332D, 333D ASN 198261)	Charge Air Cooler	AMAT406231	\$ 620.00
 John Deere® 328E, 332E, Track Skid Steer Loaders: 329E, 333E	Charge Air Cooler	AMAT390072	\$ 397.00

Belts

Application	Description	Part Number	Retail Price	Core
Bobcat® 444M, 500, 600, 611	Main Drive	AM6504510	\$ 99.00	
Bobcat® T190, T190G	A/C Compressor Replaces 17350, 17355	AM7143498	\$ 22.25	
Case® 440, Track Skid Steer Loader: 440CT	A/C Compressor 4-Groove Serpentine Belt	AM87685981	\$ 29.25	
John Deere® 260, 270	A/C Compressor - 6404DH 39.50" Long	AMH87459	\$ 4.88	

Skid Steer Parts

Attachments

Application	Description		Part Number	Retail Price	Core
Case® 40XT, 60XT, 70XT, 420, 430, 430 III, 440, 440 III, 440CT, Track Skid Steer Loaders: 420CT, 420CT III, 440CT	Faceplate Coupler Lever	Right Hand	AM86633196	\$ 54.10	
		Left Hand	AM86633195	\$ 54.10	
Case® 75XT, 85XT, 90XT, 95XT, 435, 445, 465, Track Skid Steer Loaders: 445CT, 450CT	Faceplate Coupler Lever	Right Hand	AM246649A1	\$ 96.41	
		Left Hand	AM246651A1	\$ 96.41	
Case® 75XT, 85XT, 90XT, 95XT, 435, 445, 465, Track Skid Steer Loaders: 445CT, 450CT	Upper Faceplate Pin		AM255071A2	\$ 84.62	
			AM255072A2	\$ 101.88	
			AM240484A1	\$ 64.97	
John Deere® 326D, (326E, 328E, 332E BSN 249769), 328D, 332D, Track Skid Steer Loaders: 329D, (329E, 333E BSN 249769), 333D	Quick Attach Pin		AMT259580	\$ 49.26	

Baler Parts

Table of Contents

Air Spring Service Assembly	195	For New Holland®	203
Belt Repair Parts	214	For New Idea®	209
Belts.....	201	For Vermeer®	210
For AGCO®	201	For Vicon®	212
For Allis Chalmers®	201	Gauge Wheels and Hub Assembly.....	199
For Case IH®	201	Platform Components.....	201
For Challenger®	203	Poly Pickup Bands.....	199
For Gehl®	204	PTO Components.....	195
For Hesston®	205	Sensors	195
For John Deere®	206	Sprockets and Parts	196
For Massey Ferguson®	207		
For McKee®	208		

Sensors

Application	Description	Part Number	Retail Price
Case IH® Rectangle Balers: LB323P, LB323R, LB323S, LB324P, LB324P XL, LB324PC, LB324PC XL, LB324R, LB324R XL, LB333P, LB333R, LB333S, LB334P, LB334P XL, LB334PC, LB334PC XL, LB334R, LB334R XL, LB423R, LB423S, LB424P, LB424P XL, LB424R, LB424R XL, LB433R, LB433S, LB434P, LB434P XL, LB434R, LB434R XL, LB436P HPD, LB436RC HPD, Round Balers: RB344, RB455, RB465, RB545, RBX343	Electric Module	AM87601142	\$ 43.00
Case IH® Rectangular Balers: LB333P, LB333R, LB433R, LB433S, LBX322S, LBX331P, LBX331R, LBX331S, LBX332P, LBX332R, LBX332S, LBX421R, LBX421S, LBX431R, LBX431S, LBX432R, LBX432S, New Holland® Rectangular Balers: BB930AP, BB930AR, BB940AP, BB940AR, BB940P, BB940R, BB940S, BB950AR, BB960AR, BB960AS, BB960R, BB960S, BB9050R, BB9060P, BB9060R, BB9060S, BB9070R, BB9070S, BB9080R, BB9080S	Sensor, Spreader Position Proximity	AM84058863	\$ 78.00
John Deere® Round Balers: 450M, 460M, 460R, 560M, 560R	Proximity Switch	AMAN372459	\$ 65.00

PTO Components

Application	Description	Part Number	Retail Price
John Deere® Round Balers: 448, 449, 458, 458S, 459, 459E, 468, 468S, 469, 558, 559, 568, 569	Gearbox 540 RPM Replaces AFH202245	AMAFH204883	\$ 1995.00

Air Spring Service Assembly

Application	Description	Part Number	Retail Price
 New Holland® Round Balers: 855* ASN 733141, 858 *BSN 733140 will require new style Pistons 695770 and Retainer 850097	Air Spring Service Assembly Includes Flex Member, Upper Bead Plate, Lower Retainer and Locknut	AM857581	\$ 355.00
	Air Spring Service Assembly Includes Flex Member, Upper Bead Plate, Lower Retainer and Locknut	AM857661	\$ 326.00
Vermeer® Round Balers: 604K, 604XL, 605K, 605L, 605XL	Air Spring Replaces 103687001	AM103687	\$ 210.00

Baler Parts

Sprockets and Parts

Application	Description	Part Number	Retail Price
Case IH® Round Balers: RB444, RB454, RB464, RB554, RB564, RBX443, RBX451, RBX452, RBX453, RBX461, RBX462, RBX463, RBX552, RBX553, RBX561, RBX562, RBX563, Square Balers: SB551, SBX550, New Holland® Round Balers: 640, 644, 648, 650, 654, 658, 660, 664, 678, 688, 850, 855, 858, BR730A, BR740, BR740A, BR750, BR750A, BR770, BR770A, BR780, BR780A, BR7060, BR7070, BR7080, BR7090, Square Balers: 580, 2000, BC5080, Swathers: 903, 905, 907, 909, 1100	Idler Sprocket 13 Tooth, 0.64" Bore For Size 80 Chain Bearing Included Replaces 86576898, 87011880, 87362667	AM84401598	\$ 42.04
Case IH® Round Balers: RB454, RB464, RB554, RB564, RBX452, RBX453, RBX462, RBX463, RBX552, RBX553, RBX562, RBX563, New Holland® Round Balers: BR740, BR740A, BR750, BR750A, BR770, BR770A, BR780, BR780A, BR7060, BR7070, BR7080, BR7090	Roll Sprocket, Right Hand Drive 28 Tooth, 1.58" Bore For Size 60 Chain Replaces 86610109	AM87660330	\$ 66.51
	Rotor Sprocket, Left Hand 25 Tooth, 1.50" Hex Bore For Size 80 Chain Replaces 86610108	AM87664055	\$ 96.66
	Stuffer Feeder Triple Sprocket, Left Hand Drive 18, 18 and 13 Tooth, 27 Spline, 1.64" Spline Diameter For Size 80 Chain Replaces 86613345	AM87664054	\$ 173.82
Case IH® Round Balers: RB454, RB464, RB554, RB564, RBX452, RBX453, RBX462, RBX463, RBX552, RBX553, RBX562, RBX563, New Holland® Round Balers: BR740, BR740A, BR750, BR750A, BR770, BR770A, BR780, BR780A, BR7070, BR7080, BR7090	Stuffer Feeder Double Sprocket, Left Hand Drive 25 and 17 Tooth, 27 Spline, 1.64" Spline Diameter For Size 80 Chain Replaces 86613346	AM87664058	\$ 165.29
Case IH® Round Balers: RB454, RB464, RB554, RB564, RBX462, RBX463, RBX562, RBX563, New Holland® Round Balers: BR750, BR750A, BR780, BR780A, BR7060, BR7070, BR7080, BR7090	Idler Sprocket, Trip Linkage Plastic 18 Tooth, 1.03" Bore For Size 2040 Chain	AM87041952	\$ 9.95
Case IH® Round Balers: RB454, RB464, RB554, RBX452, RBX553, RBX563, New Holland® Round Balers: BR740, BR740A, BR750A, BR770A, BR780A, BR7060, BR7070, BR7080	Sprocket, Main Frame Rolls 28 Tooth, 1.50" Hex Bore For Size 80 Chain	AM87056511	\$ 74.93
Case IH® Round Balers: RB454, RB464, RB554, RBX452, RBX453, RBX462, RBX463, New Holland® Round Balers: BR740, BR740A, BR750, BR750A, BR7060, BR7070, BR7090	Pickup Sprocket 17 Tooth, 1" Bore For Size 50 Chain Replaces 87397998	AM87602188	\$ 31.40
Case IH® Round Balers: RB454, RB464, RB564, RBX452, RBX453, RBX462, RBX463, RBX562, RBX563, New Holland® Round Balers: BR740, BR740A, BR750, BR750A, BR780, BR780A, BR7060, BR7070, BR7090	Auger Drive Sprocket 13 Tooth, 1.13" Hex Bore For Size 50 Chain Replaces 86624712, 87026284, 87037892	AM87641197	\$ 37.98
	Floor Roll Sprocket, Optional Speed Increase 29 and 41 Tooth, 23 Spline, 1.23" Spline Diameter For Size 80/60 Chain Replaces 87039066	AM87656795	\$ 236.50
	Pickup Sprocket, Reel 48 Tooth, 1.13" Hex Bore For Size 50 Chain Replaces 86624713	AM87641160	\$ 78.02
	Pickup Sprocket, Speed Increase 18 Tooth, 1" Bore For Size 50 Chain Replaces 87055082, 87462671	AM87397995	\$ 30.89
Case IH® Round Balers: RB454, RB464, RBX341, RBX451, RBX452, RBX453, RBX461, RBX462, RBX463, New Holland® Round Balers: 644, 648, 654, 658, 853, BR740, BR740A, BR750, BR750A, BR7060, BR7070, Square Baler: 2000	Pickup Sprocket, Tine Bar Driven 44 Tooth, 1.128" Hex Bore For Size 50 Chain Replaces 86536133	AM86637251	\$ 77.17
Case IH® Round Balers: RB454, RB464, RBX452, RBX453, RBX462, RBX463, New Holland® Forage Harvesters: 1900, 2100, Round Balers: 648, 658, BR740, BR740A, BR7060, BR7070	Idler Sprocket 12 Tooth, 0.64" Bore For Size 100 Chain Bearing Included Replaces 713183	AM87017554	\$ 65.14

Baler Parts

Application	Description	Part Number	Retail Price
Case IH® Round Balers: RB454, RB464, RBX452, RBX453, RBX462, RBX463, New Holland® Round Balers: 648, 658, BR740, BR740A, BR750, BR750A, BR7060, BR7070	Clutch Pickup Sprocket w/ Bushing 17 Tooth, 2" Bore For Size 60 Chain Brass Bushing Included Replaces 86543099, 86637255	AM87047934	\$ 110.45
Case IH® Round Balers: RB454, RB464, RBX452, RBX453, RBX462, RBX463, New Holland® Round Balers: BR740, BR740A, BR750, BR750A, BR7060, BR7070	Driven Sprocket, Rotor Cutter 29 Tooth, 23 Spline 1.376" Spline Diameter For Size 80 Chain Replaces 86616505	AM84244813	\$ 165.47
	Rotor Drive Double Sprocket, Left Hand 18, 14 and 13 Tooth, 27 Spline, 1.64" Spline Diameter For Size 100/80 Chain Replaces 86610110	AM87664057	\$ 123.90
	Rotor Drive Triple Sprocket, Left Hand 18, 14 and 13 Tooth, 27 Spline, 1.64" Spline Diameter For Size 100/80 Chain Replaces 86610107	AM87664056	\$ 191.53
	Rotor Feeder Drive Sprocket 31 Tooth, 2.50" Bore For Size 60 Chain	AM86633715	\$ 126.31
	Rotor Feeder Drive Sprocket w/ Bushing 39 Tooth, 3" Bore For Size 60 Chain Replaces 86978871	AM87728115	\$ 103.60
	Pickup Sprocket, Overrunning Clutch 15 Tooth, 1.378" Bore For Size 60 Chain Replaces 86630212, 87026273	AM87654402	\$ 59.75
Case IH® Round Balers: RB464, RB554, RB564, RBX461, RBX462, RBX463, RBX552, RBX553, RBX561, RBX562, RBX563, New Holland® Round Balers: 650, 654, 658, 660, 664, 678, 688, BR750, BR750A, BR770, BR770A, BR780, BR780A, BR7070, BR7090	Roll Drive Sprocket/Clutch 22 Tooth, 1.75" Bore Bushings Included For Size 80 Chain Replaces 86516998, 86601369	AM87032323	\$ 237.32
Case IH® Round Balers: RB464, RB564, New Holland® Round Balers: BR7070, BR7090	Stuffer Feeder Sprocket 15 Tooth, 1.58" Bore For Size 80 Chain Replaces 87615794	AM87660325	\$ 54.59
Case IH® Round Balers: RB464, RB564, New Holland® Round Balers: BR780A, BR7070, BR7090	Stuffer Feeder Sprocket, Fixed Roll Drive 15 Tooth, 1.51" Hex Bore For Size 80 Chain Replaces 87615793	AM87660324	\$ 51.18
Case IH® Round Balers: RB554, RB564, RBX552, RBX553, RBX562, RBX563, New Holland® Round Balers: BR740, BR740A, BR770, BR770A, BR780, BR780A, BR7060, BR7080, BR7090	Double Sprocket, Standard Pickup Reel/Drive 29 and 35 Tooth, 1.376" Spline Diameter For Size 80/50 Chain	AM86618109	\$ 116.60
Case IH® Round Balers: RB564, RBX452, RBX453, RBX462, RBX463, RBX562, RBX563, New Holland® Round Balers: BR740, BR740A, BR750, BR750A, BR780, BR780A	Pickup Driven Sprocket 17 Tooth, 1.003" Bore For Size 50 Chain Replaces 86610143, 86624711, 87041635	AM87047646	\$ 25.54
Case IH® Round Balers: RB564, RBX563, New Holland® Round Balers: BR780A, BR7090	Roll Drive Sprocket/Jaw Clutch w/ Bushing 15 Tooth, 2.005" Bore For Size 60 Chain Replaces 86624640	AM87047932	\$ 90.43
Case IH® Round Balers: RBX452, RBX453, RBX464, New Holland® Round Balers: BR740, BR740A, BR750, BR750A	Hydraulic Rotor Cutter Reverse Sprocket 22 Tooth, 1.75" Bore For Size 80 Chain Replaces 86705498	AM87660578	\$ 195.06
Case IH® Square Balers: SB521, SB531, SB541, SB551, SBX520, SBX530, SBX540, SBX550, New Holland® Square Balers: 565, 568, 570, 575, 580, BC5050	Pickup Drive Sprocket 33 Tooth, 1.974" Bore For Size 50 Chain Plastic Bushing Included Replaces 9621919	AM86641546	\$ 87.18







Prices Subject to Change without Prior Notice. The use of original equipment manufacturer (OEM) part numbers or trademarks, e.g. Case® and John Deere®, are for reference purposes only and for indicating product use and compatibility. Our company and the listed replacement parts contained herein are not sponsored, approved or manufactured by the OEM. All parts are New unless designated Reman in the description.

Baler Parts

Application	Description	Part Number	Retail Price
Case IH® Square Balers: SB521, SB531, SB541, SBX520, SBX530, SBX540, New Holland® Square Balers: 311, 565, 568, 570, 575, 585, BC5050, BC5060, BC5070	Sprocket and Hub Assembly 13 Tooth, 12 Inner Spline, 17 Outer Spline For Size 60 Chain Replaces 80635210, 86640891	AM635210	\$ 144.15
Case IH® Square Balers: SB521, SB531, SB541, SBX520, SBX530, SBX540, New Holland® Square Balers: 565 ASN 808917, BC5050, BC5060, BC5070	Pickup Drive Sprocket 21 Tooth, 1.003" Bore For Size 50 Chain Replaces 9801458, 89801458	AM86629624	\$ 77.89
Case IH® Square Balers: SB521, SBX520, New Holland® Round Balers: 565, 568, BC5050	Feeder Drive Sprocket 41 Tooth, 1.377" Bore For Size 60 Chain Replaces 9801470, 80849219, 89801470	AM86977217	\$ 124.62
New Holland® Round Balers: 644, 648, 654, 658, 660, 664	Sprocket with Bushing, Starter Roll Driven 20 Tooth, 2.003" Bore For Size 60H Chain Brass Bushing Included Replaces 9809175, 89809175	AM86536060	\$ 108.57
New Holland® Round Balers: 654, 658, 664	Pickup Sprocket Assembly w/ Bushing 21 Tooth, 2.005" Bore For Size 50 Chain Bushing Included Replaces 9805561	AM86544702	\$ 130.67
New Holland® Round Balers: BR740A, BR750A, BR780, BR780A, BR7060, BR7070, BR7090, Roll-Belt 450, Roll-Belt 460, Roll-Belt 550, Roll-Belt 560	Roll Drive Bearing Replaces 86590752	AM87660333	\$ 155.50
John Deere®: Square Baler: 65	Rubber Mount	AM5108225	\$ 8.00
John Deere® Round Balers: 330, 335, 375, 385, 410, 430, 435, 446, 447, 448, 456, 457, 458, 458S, 466, 467, 468, 468S, 500, 510, 530, 535, 540, 545, 546, 547, 550, 556, 557, 558, 565, 566, 567, 568, 572, 575, 582, 592, 854, Square Balers: 100, 327, 328, 336, 337, 338, 346, 347, 348, 466, 467, 468	Ball Bearing 1.251" ID, 2.835" OD	AMJD9420	\$ 28.09
John Deere® Round Balers: 335, 375, 540, 545, 550, 565, 575	Idler Sprocket 15 Tooth, 0.638" ID For Size 60 Chain	AMAE27909	\$ 27.46
John Deere® Round Balers: 440E, 447, 448, 449, 450M, 457, 458, 458S, 459, (459, 469, 559, 569 Silage Special), 460M, 460R, 467, 468, 468S, 469, 547, 550M, 557, 558, 559, 560M, 560R, 567, 568, 569, Premium Models: 469, 569	Stripper Replaces E130206	AMAE74364	\$ 13.45
John Deere® Round Balers: 440E, 449, 450E, 450M, 459, 459E, 459STD, 460M, 460R, 469PR, 550M, 559, 559SSD, 560M, 560R, 569, 569PR, 569R	Drawbar Shield	AMBE32262	\$ 50.00
John Deere® Round Balers: 446, 447, 448, 449, 456, 457, 458, 459, 466, 467, 468, 469, 469 Silage Special, 546, 547, 556, 557, 558, 559, 566, 567, 569	Starter Roll Sprocket 24 Tooth, 1.504" Hex Bore For Size 60 Chain Replaces AFH205816	AMAE54301	\$ 61.51
John Deere® Round Balers: 449, 459, 459E, 459 Silage Special, (460M, 460R, 560R - w/ Net Wrap) 469, 559, 560M, 568, 569, Premium Model: 469	Roll Bearing, Top Idler Roll 5.118" OD, 1.50" Hex Bore Diameter	AMAFH205481	\$ 124.19
	Roll Bearing, Bottom Gate Roll No. 9 5.118" OD, 1.50" Hex Bore Diameter	AMAFH205481	\$ 124.19
John Deere® Round Balers: 456, 457, 458, 458S, 459, 459 SS, 459E, 460M, 460R, 466, 467, 468, 468S, 469, 469 SS, 550M, 556, 557, 558, 559, 559 SS, 560M, 560R, 566, 567, 568, 569, 569 SS, Premium Models: 469, 569	Upper Tension Compression Spring Replaces E85033	AMFH316661	\$ 76.15

Baler Parts

Gauge Wheels and Hub Assembly

Application	Description	Part Number	Retail Price
 Case IH® Round Balers: 8420, 8430, 8450, Challenger® Round Balers: RB34, RB44, Hesston® Round Balers: 530, 540, 730, 740, 745, 830, 840, 5530, Massey Ferguson® Round Balers: 1734, 1744, New Idea® Round Balers: 4643, 4644, 6343, 6344	Hub Assembly, Pre-Assembled w/ AM700721469 Gathering Wheel, 24" x 9" Bearings Not Included Will work on either side of the Baler by loosening the bolts and reversing the Hub Assembly	AM700727604	\$ 295.33
 Case IH® Round Balers: 8420, 8430, 8450, Challenger® Round Balers: RB34, RB44, RB452, RB462, RB562, Hesston® Round Balers: 530, 540, 740, 745, 5134, 5145, 5146, 5156, Massey Ferguson® Round Balers: 1560, 1734, 1744, 1745, 1746, 1756, New Idea® Round Balers: 6243, 6244, 6254	Gathering Wheel 9" ID, 24" OD Will not fit OEM Wheels, Use w/ AM700727604 Hub Assembly	AM700721469	\$ 125.55
 Case IH® Round Balers: 8455, 8455T, 8460, 8465, 8465T, Hesston® Round Balers: 550, 555, 560, 565, 5540, 5545, 5580, 5585, John Deere® Round Balers: 330, 335, 375, 385, 430, 435, 446, 447, 448, 449, 456, 457, 458, 459, 466, 467, 468, 468S, 530, 535, 540, 545, 546, 547, 550, 556, 557, 558, 559, 566, 567, 568, 569, 582	Gathering Wheel Segment (3) Required for Entire Wheel	AME70647	\$ 56.00
 Case IH® Round Balers: RB455, RB465, RB565, Utility: RB455A, New Holland® Roll-Belt Round Balers: 450, 460, 550, 560	Gathering Wheel 12" ID, 24.40" OD	AM84296067	\$ 112.00
 Case IH® Round Balers: RB564, RBX552, RBX553, RBX561, RBX562, RBX563, New Holland® Round Balers: 640, 644, 648, 650, 654, 658, 660, 664, 678, 688, 848, 853, 855, BR740, BR740A, BR770, BR780, BR7060, BR7080, BR7090, Gehl® Round Balers: 1450, 1465, 1470, 1475, 1500, 1600, 1850, 1860, 1870, 1875, 2480, 2580, 2680, 2780, 2880, Vermeer® Round Balers: 504F, 504G, 504H, 605F, 605G, 605H	Gathering Wheel 12" ID, 28" OD	AM11122001	\$ 144.00
 Vermeer® Round Balers: 5041, 504L, (504M, 505M - Classic), 504SI, 5051, 505L, 505SI, 554XL, 555XL, 604J, 604K, 604L, 604SJ, 604XL, 605J, 605K, 605L, 605SJ, 605XL, (664, 665 - Rancher), (5400, 5410, 5420, 5500, 5520 - Rebel)	Gathering Wheel 9" ID, 24" OD	AM66274001	\$ 134.30

Poly Pickup Bands

Application	Description	Part Number	Retail Price
AGCO® Round Balers: 5446A, 5456A, 5546, 5556A, Case IH® Round Balers: 8435, RS451, RS551, RS561, RS561A, Challenger® Round Balers: RB46, RB46B, RB56B, RB463A, RB563A, Hesston® Round Balers: 845, 846A, 855, 856, 856A, 945, 946A, 955, 956, Massey Ferguson® Round Balers: 2646A, 2656A, 2746A, 2756A	Poly Pickup Band Includes Hardware	Black AM700132112	\$ 30.00
AGCO® Square Balers: 7423, 7424, 7433, 7434, 7444, Challenger® Round Balers: RB46, RB56, Massey Ferguson® Round Balers: 2846, 2856, 2946, 2956, Square Balers: 2150, 2170, 2190, 2250, 2270, 2290	Poly Pickup Band Includes Hardware Replaces 700189742	Gray AM700141909	\$ 30.00
Case IH® Round Balers: RB444, RBX441, RBX442, RBX443	Poly Pickup Band Includes Hardware	Black AM86619049	\$ 30.25
Case IH® Round Balers: (RB454, RB464, RB564, RBX452, RBX453, RBX462, RBX463, RBX562, RBX563 - w/ Wide Pickup)	Poly Pickup Band Includes Hardware	Black AM86643381	\$ 30.25
Case IH® Round Balers: (RB454, RB464, RBX453, RBX462, RBX463 - w/ Dual Cam Wide Pickup), (RB564, RBX452, RBX563 - w/ Wide Pickup)	Poly Pickup Band Includes Hardware	Black AM87055363	\$ 30.25
Case IH® Round Balers: (RB554, RB564, RBX552, RBX553, (RBX562, RBX563 ASN HBJ039346) - All w/ Standard Pickup)	Poly Pickup Band Includes Hardware Replaces 86634483	Black AM87041202	\$ 30.25

Baler Parts

Application	Description	Part Number	Retail Price
Case IH® Round Balers: RBX443 BSN Y7N030706, RBX561	Poly Pickup Band Includes Hardware	Black AM86637150	\$ 30.25
Case IH® Square Balers: 8550, 8570, 8575, 8585, Challenger® Square Balers: LB33, LB34, LB44, Hesston® Square Balers: 4690, 4750, 4755, 4760, 4790, New Idea® Square Balers: 7233, 7234, 7333	Poly Pickup Band Includes Hardware Replaces 700129658	Black AM700108607	\$ 23.00
Case IH® Square Balers: (LB324P, LB324PC, LB334P, LB334P XL, LB334PC XL, LB424P, LB424P XL, LB434P XL BSN 191 w/ Standard or Packer Cutter Head), (LB333S, LB333P, LB334PC, LB433S, LB434P, LBX322S, LBX331P, LBX331S, LBX332P, LBX332S, LBX421S - w/ Standard or Packer Cutter Head)	Poly Pickup Band Includes Hardware Replaces 84214800, 84607815, 84801631	Black AM84274387	\$ 22.00
Case IH® Square Balers: (LB333R, LB433R, LBX331R, LBX332R, LBX421R - w/ Rotor Cutter Head)	Poly Pickup Band Includes Hardware Replaces 84214795, 84274384	Black AM84607781	\$ 22.00
New Holland® Square Balers: ((230P, 230PC, 230PC+, 330PC, 340P BSN 191), 330P, 340P+ SN 137-191, (BB930AP, BB940AP, BB940AS ASN D548), BB960, (BB9060P, BB9060S, BB9070S, BB9080S BSN C799) - All w/ Standard or Packer Cutter Head)	Poly Pickup Band Includes Hardware Replaces 84274388, 85005357, 89837845	Yellow AM84801630	\$ 22.00
New Holland® Square Balers: 276, 278, 311, 315, 316, 320, 326, 565, 568, 570, 575, 580, BC5050, BC5060, BC5070, BC5080	Poly Pickup Band Includes Hardware Replaces 184550, 218598, 848564	Yellow AM86635482	\$ 30.25
New Holland® Round Balers: 630, 634, 638, 660 BSN 906678, 851, 852, BR730, BR730A ASN Y7N030706, BR7050, (640, 650, BR740A BSN Y6N016414 - w/ Standard Pickup)	Poly Pickup Band Includes Hardware Replaces 578696, 80578696	Yellow AM86619048	\$ 30.00
New Holland® Square Balers: (644, 648, 654, 658, 660 ASN 906679, 664, 678, 688, BR730A, BR740A ASN Y6N016413, BR7060 - w/ Standard Pickup)	Poly Pickup Band Includes Hardware	Yellow AM86637149	\$ 30.25
New Holland® Round Balers: (BR740, BR740A, BR750, BR750A, BR780, BR780A, BR7060, BR7070, BR7090 - w/ Wide Pickup)	Poly Pickup Band Includes Hardware	Yellow AM86643380	\$ 30.25
New Holland® Round Balers: (BR740, BR740A, BR750, BR750A, BR780A, BR7060, BR7070, BR7090 - w/ Wide Pickup)	Poly Pickup Band Includes Hardware	Yellow AM87055364	\$ 30.25
New Holland® Round Balers: BR770, BR770A, BR780, BR780A, BR7080, BR7090	Poly Pickup Band Includes Hardware Replaces 86634482	Yellow AM87041203	\$ 30.25
New Holland® Square Balers: (BB940, BB960, BB9050, BB9060, BB9070, BB9080 - w/ Rotor Cutter Head)	Poly Pickup Band Includes Hardware Replaces 84214794, 84274385, 84801613	Yellow AM84274385	\$ 22.00
John Deere® Round Balers: 330, (335, 375, 435, 535 ASN 915000), 385, 430, 446, 447, 448, 449, 456, 457, 458, 459, 466, 467, (468, 469 - w/ Mega Wide Plus Pickup), 530, 546, 547, 556, 557, 558, 559, 566, 567, 568, 569, 572, 582, 592, Square Balers: L330, L331, L340, L341, Pickup Platforms: 630A, 630B, 640A, 640B	Poly Pickup Band Includes Hardware Replaces E85043, FH311772	Green AMCC32669	\$ 30.00
Vermeer® Round Balers: 504I, 504L, 505I, 505L, 554XL, 555XL, 604J, 604K, 604L, 604SM, 604XL, 605J, 605K, 605L, 605N, 605SJ, 605SM, 605XL, (664, 664M, 665, 6640, 6650 - Rancher), (5400, 5410, 5420, 5500, 5520 - Rebel) Will fit other I, J, K, L, XL, N, Rancher, Rebel, SI, SJ and SM Models	Poly Pickup Band Includes Hardware	Yellow AM89982001	\$ 30.25
New Holland® Forage Harvester Pickup Platforms: 270FP, 280FP, 290FP, 346W, 356W, 366W	Poly Pickup Band Includes Hardware Replaces 86631272, 87584380	Yellow AM87696240	\$ 30.25
New Holland® Pull-Behind Silage Chopper Pickup Units: 27P, 29P, 707W, 717W, 770W, 790W, 880W, 890W, 900W, 919W3, 919W4, 990W	Poly Pickup Band Includes Hardware Replaces 224178, 80134526, 80224178	Yellow AM86625272	\$ 30.25

Baler Parts

Platform Components

Application	Description	Part Number	Retail Price
John Deere® Pickup Platforms: 912, 914	Slip Clutch Jaw	AMH101677	\$ 29.50
John Deere® Pickup Platforms: 912, 914, 914P	Platform Sprocket	AMAH138180	\$ 50.00

Belts

For Allis Chalmers®

Application	Description	Part Number	Retail Price
Round Baler: (Roto Baler - 6 Required)	Baler Belt, 5.50" x 72" Upper 2-ply TT, Clipper Connector	AM2P5.5X72TTC	\$ 59.00
Round Baler: Roto Baler	Baler Belt, 5.50" x 102" Lower 2-ply TT, Clipper Connector	AM2P5.5X102TTC	\$ 72.00

For AGCO®

Application	Description	Part Number	Retail Price
Round Baler: (5134 - 5 Required)	Baler Belt, 4.80" x 364" Upper 3-ply MRT, Alligator Connector	AM3P4.8X365MRTA	\$ 156.00
	Baler Belt, 4.80" x 364" Upper 3-ply MRT, Clipper Connector	AM3P4.8X364MRTC	\$ 183.00
	Baler Belt, 4.80" x 364" Upper 2-ply TT, Clipper Connector	AM2P4.8X364TTC	\$ 120.68
Round Balers: (5145, 5545 - 4 Required)	Baler Belt, 7" x 475" Upper 3-ply DT, Alligator Connector	AM3P7X475DTA	\$ 312.00
Round Balers: (5145, 5545 - 2 Required)	Baler Belt, 7" x 483" Upper 3-ply DT, Alligator Connector	AM3P7X483DTA	\$ 314.00
Round Balers: 5146, 5156	Baler Belt, 7" x 571" Upper 3-ply DT, Alligator Connector	AM3P7X571DTA	\$ 359.00
Round Balers: (5146 - 2 Required), (5156 - 4 Required)	Baler Belt, 7" x 578" Upper 3-ply DT, Alligator Connector	AM3P7X578DTA	\$ 364.00
Round Balers: (5446, 5456, 5546, 5555 - 4 Required), (5446A, 5546A - 6 Required), (5456A, 5556A - 8 Required)	Baler Belt, 7" x 547" Upper 3-ply DT, Alligator Connector	AM3P7X547DTA	\$ 349.00

For Case IH®

Application	Description	Part Number	Retail Price
Bale Thrower: BTX11, Square Balers: SBX520, SBX530, SBX540	Bale Thrower Belt, 12" x 72"	AM2P12X72DTC	\$ 141.00
Round Balers: (241, 2400 - 9 Required)	Baler Belt, 4" x 431" Upper 3-ply TT, Clipper Connector	AM3P4X431TTC	\$ 150.00
	Baler Belt, 4" x 431" Upper 2-ply TT, Clipper Connector	AM2P4X431TTC	\$ 154.00
Round Balers: (241, 2400 - 2 Required)	Baler Belt, 10" x 431" Upper 3-ply TT, Clipper Connector	AM3P10X431TTC	\$ 287.00
	Baler Belt, 10" x 431" Upper 2-ply TT, Clipper Connector	AM2P10X431TTC	\$ 347.00
Round Balers: (241, 2400 - 1 Required)	Baler Belt, 60" x 120" Lower 2-ply TT, Clipper Connector, No V-Guide	AM2P60X120TTCNV	\$ 356.00

Baler Parts

Application	Description	Part Number	Retail Price
Round Baler: (2400 - 9 Required)	Baler Belt, 4" x 424" Upper 3-ply TT, Clipper Connector, Dual Springs	AM3P4X424TTC	\$ 149.00
	Baler Belt, 4" x 424" Upper 2-ply TT, Clipper Connector, Dual Spring	AM2P4X424TTC	\$ 152.00
Round Baler: (2400 - 2 Required)	Baler Belt, 10" x 424" Upper 3-ply TT, Clipper Connector, Dual Springs	AM3P10X424TTC	\$ 324.00
	Baler Belt, 10" x 424" Upper 2-ply TT, Clipper Connector, Dual Springs	AM2P10X424TTC	\$ 344.00
Round Balers: (3440 - 12 Required), (3450 - 15 Required), (3640 - 20 Required), (3650 - 25 Required)	Baler Belt, 11" x 73.25" Upper 3-ply TT, Clipper Connector	AM3P11X73TTC	\$ 94.00
	Baler Belt, 11" x 73.25" Upper 2-ply TT, Clipper Connector	AM2P11X73TTC	\$ 71.65
Round Balers: (3440, 3450 - 5 Required)	Baler Belt, 11" x 103.50" Upper 2-ply TT, Clipper Connector	AM2P11X104TTC	\$ 103.00
Round Balers: (3450 - 30 Required), (3650 - 33 Required)	Baler Belt, 4.75" x 73.25" Upper 3-ply TT, Clipper Connector	AM3P4.75X73TTC	\$ 53.00
	Baler Belt, 4.75" x 73.25" Upper 2-ply TT, Clipper Connector	AM2P4.75X73TTC	\$ 57.00
Round Balers: (3640 - 20 Required), (3650 - 25 Required)	Baler Belt, 11" x 73.25" Upper 3-ply TT, Alligator Connector	AM3P11X73TTA	\$ 125.00
Round Balers: (3640 - 20 Required), (3650 - 25 Required)	Baler Belt, 11" x 73.25" Upper 2-ply TT, Alligator Connector	AM2P11X73TTA	\$ 141.22
Round Balers: (3640 - 4 Required), (3650 - 5 Required)	Baler Belt, 11" x 121.25" Lower 3-ply TT, Alligator Connector	AM3P11X121TTA	\$ 160.00
	Baler Belt, 11" x 121.25" Lower 3-ply TT, Clipper Connector	AM3P11X121TTC	\$ 129.00
	Baler Belt, 11" x 121.25" Lower 2-ply TT, Alligator Connector	AM2P11X121TTA	\$ 180.55
Round Balers: (3640 - 4 Required), (3650, 8480 - 5 Required)	Baler Belt, 11" x 121.25" Lower 2-ply TT, Clipper Connector	AM2P11X121TTC	\$ 117.00
Round Baler: (8420 - 5 Required)	Baler Belt, 4.80" x 364" Upper 3-ply MRT, Clipper Connector	AM3P4.8X364MRTC	\$ 183.00
	Baler Belt, 4.80" x 364" Upper 2-ply TT, Clipper Connector	AM2P4.8X364TTC	\$ 120.68
Round Baler: (8430 - 6 Required)	Baler Belt, 7" x 366" Upper 3-ply MRT, Clipper Connector	AM3P7X366MRTC	\$ 195.00
	Baler Belt, 7" x 366" Upper 2-ply TT, Clipper Connector	AM2P7X366TTC	\$ 173.63
Round Baler: (8435 - 6 Required)	Baler Belt, 7" x 471.50" Upper 2-ply TT, Clipper Connector	AM2P7X472TTC	\$ 218.85
Round Baler: (8440 - 9 Required)	Baler Belt, 4" x 452" Upper 3-ply RT, Clipper Connector	AM3P4X452RTC	\$ 157.00
	Baler Belt, 4" x 452" Upper 2-ply TT, Clipper Connector	AM2P4X452TTC	\$ 124.64
Round Balers: (8450, 8460 - 2 Required)	Baler Belt, 6.50" x 572.50" Upper 2-ply TT, Clipper Connector	AM2P6.5X573TTC	\$ 239.80
Round Balers: (8450 - 4 Required), (8460 - 6 Required)	Baler Belt, 7" x 570" Upper 3-ply RT, Clipper Connector	AM3P7X570RTC	\$ 302.00
Round Balers: (8450 4 Required), (8460 - 6 Required)	Baler Belt, 7" x 570" Upper 2-ply TT, Clipper Connector	AM2P7X570TTC	\$ 254.86
Round Balers: (8455 - 6 Required), (8460, 8465 - 8 Required)	Baler Belt, 7" x 562.50" Upper 3-ply RT, Clipper Connector	AM3P7X563RTC	\$ 342.00
	Baler Belt, 7" x 562.50" Upper 2-ply TT, Clipper Connector	AM2P7X563TTC	\$ 256.36

Belts

Baler Parts

Baler Parts

Application	Description	Part Number	Retail Price
Round Balers: (RS451 - 6 Required), (RS551 - 8 Required)	Baler Belt, 7" x 475" Upper 3-ply MRT, Titan	AM3P7X475MRT1T	\$ 282.00
	Baler Belt, 7" x 475" Upper 3-ply MRT, Alligator Connector	AM3P7X475MRT1A	\$ 306.00
Round Baler: (RS561 - 8 Required)	Baler Belt, 7" x 547" Upper 3-ply 0.315 MRT, Alligator Connector	AM3P7X547MRT1A	\$ 329.00

For Challenger®

Application	Description	Part Number	Retail Price
Round Baler: (RB34 - 5 Required)	Baler Belt, 4.80" x 364" Upper 3-ply MRT, Alligator Connector	AM3P4.8X365MRTA	\$ 156.00
	Baler Belt, 4.80" x 364" Upper 3-ply MRT, Clipper Connector	AM3P4.8X364MRTC	\$ 183.00
Round Baler: (RB44 - 6 Required)	Baler Belt, 7" x 366" Upper 3-ply MRT, Alligator Connector	AM3P7X366MRTA	\$ 210.00
	Baler Belt, 7" x 366" Upper 3-ply MRT, Clipper Connector	AM3P7X366MRTC	\$ 195.00
Round Baler: (RB45 - 6 Required)	Baler Belt, 7" x 475" Upper 3-ply MRT, Alligator Connector	AM3P7X475MRT1A	\$ 306.00
Round Balers: (RB46 - 6 Required), (RB56 - 8 Required)	Baler Belt, 7" x 547" Upper 3-ply 0.315 MRT, Alligator Connector	AM3P7X547MRT1A	\$ 329.00
Round Baler: (RB452 - 4 Required)	Baler Belt, 7" x 481.50" Upper 3-ply DT, Alligator Connector	AM3P7X482DTA	\$ 314.00
Round Baler: (RB452 - 2 Required)	Baler Belt, 7" x 486.50" Upper 3-ply DT, Alligator Connector	AM3P7X487DTA	\$ 304.00
Round Baler: (RB453 - 4 Required)	Baler Belt, 7" x 475" Upper 3-ply DT, Alligator Connector	AM3P7X475DTA	\$ 312.00
Round Baler: (RB453 - 2 Required)	Baler Belt, 7" x 483" Upper 3-ply DT, Alligator Connector	AM3P7X483DTA	\$ 314.00
Round Balers: RB462, RB562	Baler Belt, 7" x 571" Upper 3-ply DT, Alligator Connector	AM3P7X571DTA	\$ 359.00
Round Balers: (RB462 - 2 Required), (RB562 - 4 Required)	Baler Belt, 7" x 578" Upper 3-ply DT, Alligator Connector	AM3P7X578DTA	\$ 364.00
Round Balers: (RB463, RB563 - 4 Required), (RB463A - 6 Required), (RB563A - 8 Required)	Baler Belt, 7" x 547" Upper 3-ply DT, Alligator Connector	AM3P7X547DTA	\$ 349.00

For New Holland®

Application	Description	Part Number	Retail Price
Bale Thrower: 72, Square Balers: 565, 570, 575	Bale Thrower Belt, 12" x 72"	AM2P12X72DTC	\$ 141.00
Round Baler: (551 - 3 Required)	Baler Belt, 5" x 450" Upper 3-ply TT, Clipper Connector	AM3P5X450TTC	\$ 192.00
	Baler Belt, 5" x 450" Upper 2-ply TT, Clipper Connector	AM2P5X450TTC	\$ 244.75
Round Baler: (551 - 2 Required)	Baler Belt, 6" x 450" Upper 3-ply TT, Clipper Connector	AM3P6X450TTC	\$ 245.00
	Baler Belt, 6" x 450" Upper 2-ply TT, Clipper Connector	AM2P6X450TTC	\$ 255.00
Round Baler: (551 - 1 Required)	Baler Belt, 44.25" x 69.50" Lower 2-ply TT, Clipper Connector, V-Guide	AM2P44.25X70TTC	\$ 347.00
Round Baler: (552 - 6 Required)	Baler Belt, 6" x 466" Upper 3-ply TT, Clipper Connector	AM3P6X466TTC	\$ 227.00
	Baler Belt, 6" x 466" Upper 2-ply TT, Clipper Connector	AM2P6X466TTC	\$ 237.00

Belts

Baler Parts

Baler Parts

Application	Description	Part Number	Retail Price
Round Baler: (638 - 1 Required)	Baler Belt, 60" x 96" Lower 2-ply TT, Clipper Connector, V-Guide	AM2P60X96TTC	\$ 478.00
Round Balers: (658, 660, 664, 668 - 8 Required)	Baler Belt, 7" x 420.50" Upper 3-ply MRT, HP	AM3P7X421MRTHP	\$ 245.00

For Gehl®

Application	Description	Part Number	Retail Price
Round Balers: (1370, 1375, 1475 - 6 Required)	Baler Belt, 6" x 469" Upper 2-ply TT, Clipper Connector	AM2P6X469TTC	\$ 238.00
Round Baler: (1400 - 3 Required)	Baler Belt, 5" x 450" Upper 3-ply TT, Clipper Connector	AM3P5X450TTC	\$ 192.00
	Baler Belt, 5" x 450" Upper 2-ply TT, Clipper Connector	AM2P5X450TTC	\$ 244.75
Round Baler: (1400 - 2 Required)	Baler Belt, 6" x 450" Upper 3-ply TT, Clipper Connector	AM3P6X450TTC	\$ 245.00
	Baler Belt, 6" x 450" Upper 2-ply TT, Clipper Connector	AM2P6X450TTC	\$ 255.00
Round Balers: (1400, 1440 - 1 Required)	Baler Belt, 44.25" x 69.50" Lower 2-ply TT, Clipper Connector, V-Guide	AM2P44.25X70TTC	\$ 347.00
Round Balers: (1400, 1450, 1460, 1465 - 1 Required)	Baler Belt, 44.25" x 56.50" Lower 2-ply TT, Clipper Connector, V-Guide	AM2P44.25X57TTC	\$ 296.00
Round Balers: (1450, 1460 - 5 Required), (1465 - 6 Required)	Baler Belt, 6" x 462.50" Upper 3-ply TT, Clipper Connector	AM3P6X463TTC	\$ 225.00
Round Balers: (1450, 1460 - Requires 5), (1465, 1470 - Requires 6)	Baler Belt, 6" x 462.50" Upper 2-ply TT, Clipper Connector	AM2P6X462TTC	\$ 236.00
Round Baler: (1470 - 6 Required)	Baler Belt, 6" x 462.50" Upper 3-ply MRT, Clipper Connector	AM3P6X463MRTC	\$ 216.00
Round Baler: (1500 - 9 Required)	Baler Belt, 4" x 466" Upper 3-ply TT, Clipper Connector	AM3P4X466TTC	\$ 159.00
	Baler Belt, 4" x 466" Upper 2-ply TT, Clipper Connector	AM2P4X466TTC	\$ 164.00
Round Baler: (1500 - 2 Required)	Baler Belt, 10" x 466" Upper 3-ply TT, Clipper Connector	AM3P10X466TTC	\$ 352.00
	Baler Belt, 10" x 466" Upper 2-ply TT, Clipper Connector	AM2P10X466TTC	\$ 374.00
Round Balers: (1500, 1500A, 1600 - 1 Required)	Baler Belt, 60" x 96" Lower 2-ply TT, Clipper Connector, V-Guide	AM2P60X96TTC	\$ 478.00
Round Balers: (1500A, 1600 - 6 Required)	Baler Belt, 6" x 466" Upper 3-ply TT, Clipper Connector	AM3P6X466TTC	\$ 227.00
	Baler Belt, 6" x 466" Upper 2-ply TT, Clipper Connector	AM2P6X466TTC	\$ 237.00
Round Balers: (1850, 1860 - 7 Required)	Baler Belt, 6" x 546" Upper 2-ply TT, Clipper Connector	AM2P6X546TTC	\$ 214.87
Round Balers: (1850, 1860 - 1 Required)	Baler Belt, 60" x 56.50" Lower 2-ply TT, Clipper Connector, V-Guide	AM2P60X57TTC	\$ 338.00
Round Balers: (1865, 1870 - 8 Required)	Baler Belt, 6" x 545.50" Upper 3-ply MRT, Clipper Connector	AM3P6X546MRTC	\$ 255.00
	Baler Belt, 6" x 545.50" Upper 2-ply TT, Clipper Connector	AM2P6X545TTC	\$ 272.00
Round Baler: (1875 - 8 Required)	Baler Belt, 6" x 552" Upper 2-ply TT, Clipper Connector	AM2P6X552TTC	\$ 213.16

Belts

Baler Parts

Baler Parts

For Hesston®

Application	Description	Part Number	Retail Price
Bale Processor: BP25	Processor Speed Up Belt	AM700709676	\$ 278.00
Round Balers - (514, 814 - Order Quantity as Required)	Baler Belt, 11" x 73.25" Upper 3-ply TT, Clipper Connector	AM3P11X73TTC	\$ 94.00
Round Balers: (514, 814 - 25 Required)	Baler Belt, 11" x 73.25" Upper 2-ply TT, Clipper Connector	AM2P11X73TTC	\$ 71.65
Round Balers: (514, 814 - Order Quantity as Required)	Baler Belt, 11" x 121.25" Lower 3-ply TT, Clipper Connector	AM3P11X121TTC	\$ 129.00
Round Balers: (514, 814 - 5 Required)	Baler Belt, 11" x 121.25" Lower 2-ply TT, Clipper Connector	AM2P11X121TTC	\$ 117.00
Round Balers: (530, 730, 830, 5530 - Order Quantity as Required)	Baler Belt, 4.80" x 364" Upper 3-ply MRT, Clipper Connector	AM3P4.8X364MRTC	\$ 183.00
	Baler Belt, 4.80" x 364" Upper 2-ply TT, Clipper Connector	AM2P4.8X364TTC	\$ 120.68
Round Balers: (540, 740, 840 - Order Quantity as Required)	Baler Belt, 7" x 366" Upper 3-ply RT, Clipper Connector	AM3P7X366RTC	\$ 189.00
	Baler Belt, 7" x 366" Upper 2-ply TT, Clipper Connector	AM2P7X366TTC	\$ 173.63
Round Baler: (545 - Order Quantity as Required)	Baler Belt, 7" x 471.50" Upper 2-ply TT, Clipper Connector	AM2P7X472TTC	\$ 218.85
Round Balers: (550, 560 - Order Quantity as Required)	Baler Belt, 6.50" x 572.50" Upper 2-ply TT, Clipper Connector	AM2P6.5X573TTC	\$ 239.80
	Baler Belt, 7" x 570" Upper 2-ply TT, Clipper Connector	AM2P7X570TTC	\$ 254.86
Round Balers: (555, 560, 565 - Order Quantity as Required)	Baler Belt, 7" x 562.50" Upper 2-ply TT, Clipper Connector	AM2P7X563TTC	\$ 256.36
Round Baler: (565A - 8 Required)	Baler Belt, 7" x 562.50" Upper 3-ply MRT, Alligator Connector	AM3P7X563MRTA	\$ 274.72
Round Balers: (745, 845, 945 - 6 Required)	Baler Belt, 7" x 475" Upper 3-ply 0.230 MRT, Alligator Connector ConnectorBaler	AM3P7X475MRT2A	\$ 237.22
Round Balers: (846, 846A, 946 - 6 Required), (856, 856A, 956 - 8 Required)	Baler Belt, 7" x 547" Upper 3-ply 0.315 MRT, Alligator Connector	AM3P7X547MRT1A	\$ 329.00
Round Balers: (846, 846A, 946 - 6 Required)	Baler Belt, 7" x 547" Upper 3-ply 0.315 MRT, Titan	AM3P7X547MRT1T	\$ 303.00
Round Balers: (946A, 5446A - 6 Required), (956A, 5456A - 8 Required)	Baler Belt, 7" x 547" Upper 3-ply DT, Alligator Connector	AM3P7X547DTA	\$ 349.00
Round Baler: (5400 - Order Quantity as Required)	Baler Belt, 4" x 127" Upper 3-ply TT, Clipper Connector	AM3P4X127TTC	\$ 48.00
Round Baler: (5400 - 9 Required)	Baler Belt, 4" x 127" Upper 2-ply TT, Clipper Connector	AM2P4X127TTC	\$ 48.21
Round Balers: (5500, 5510 - Order Quantity as Required)	Baler Belt, 4" x 452" Upper 3-ply RT, Clipper Connector	AM3P4X452RTC	\$ 157.00
Round Balers: (5500, 5510 - Order Quantity as Required)	Baler Belt, 4" x 452" Upper 2-ply TT, Clipper Connector	AM2P4X452TTC	\$ 124.64
Round Balers: (5540, 5580 - Order Quantity as Required)	Baler Belt, 5.30" x 470" Upper 3-ply RT, Clipper Connector	AM3P5.3X470RTC	\$ 198.00
	Baler Belt, 5.30" x 470" Upper 2-ply TT, Clipper Connector	AM2P5.3X470TTC	\$ 163.66
Round Balers: (5545, 5585 - Order Quantity as Required)	Baler Belt, 5.30" x 465" Upper 3-ply MRT, Clipper Connector	AM3P5.3X465MRTC	\$ 192.00
	Baler Belt, 5.30" x 465" Upper 2-ply TT, Clipper Connector	AM2P5.3X465TTC	\$ 162.04
Round Baler: (5600 - 9 Required)	Baler Belt, 4" x 400" Upper 3-ply TT, Clipper Connector	AM3P4X400TTC	\$ 142.00

Belts

Baler Parts

Baler Parts

Application	Description	Part Number	Retail Price
Round Baler: (5600 - Order Quantity as Required)	Baler Belt, 4" x 400" Upper 2-ply TT, Clipper Connector	AM2P4X400TTC	\$ 146.00
	Baler Belt, 10" x 400" Upper 3-ply TT, Clipper Connector	AM3P10X400TTC	\$ 309.00
	Baler Belt, 10" x 400" Upper 2-ply TT, Clipper Connector	AM2P10X400TTC	\$ 325.00
Round Baler: (5600 - 1 Required)	Baler Belt, 60" x 120" Lower 2-ply TT, Clipper Connector	AM2P60X120TTC	\$ 562.00
Round Baler: (5800 - Order Quantity as Required)	Baler Belt, 4" x 480" Upper 3-ply TT, Clipper Connector	AM3P4X480TTC	\$ 164.00
	Baler Belt, 4" x 480" Upper 2-ply TT, Clipper Connector	AM2P4X480TTC	\$ 209.47
	Baler Belt, 10" x 480" Upper 3-ply TT, Clipper Connector	AM3P10X480TTC	\$ 360.00
	Baler Belt, 10" x 480" Upper 2-ply TT, Clipper Connector	AM2P10X480TTC	\$ 384.00

For John Deere®

Application	Description	Part Number	Retail Price
Round Balers: (330, 335, 446, 447, 448 - 2 Required), (375, 546, 547 - 4 Required)	Baler Belt, 7" x 402.75" Upper 3-ply DT, Alligator Connector	AM3P7X403DTA	\$ 230.00
	Baler Belt, 7" x 402.75" Upper 3-ply DT, Clipper Connector	AM3P7X403DTC	\$ 215.00
	Baler Belt, 7" x 402.75" Upper 3-ply DT, HP	AM3P7X403DTHP	\$ 232.00
Round Balers: (330, 335, 375, 446, 447, 448, 546, 547 - 4 Required)	Baler Belt, 7" x 410.25" Upper 3-ply DT, Alligator Connector	AM3P7X410DTA	\$ 235.00
	Baler Belt, 7" x 410.25" Upper 3-ply DT, Clipper Connector	AM3P7X411DTC	\$ 217.00
	Baler Belt, 7" x 410.25" Upper 3-ply DT, HP	AM3P7X411DTHP	\$ 235.00
Round Balers: (385, 456, 457, 458, 458SS - 2 Required), (556, 557, 558, 582, 592 - 4 Required)	Baler Belt, 7" x 461" Upper 3-ply DT, Alligator Connector	AM3P7X461DTA	\$ 258.00
	Belt - Baler, 7" x 461" Upper 3-ply DT, HP	AM3P7X461DTHP	\$ 258.00
Round Balers: (385, 456, 457, 458, 458SS - 4 Required), (556, 557, 558, 582, 592 - 2 Required)	Baler Belt, 7" x 461" Upper 3-ply DT, Clipper Connector	AM3P7X461DTC	\$ 240.00
Round Balers: (385, 456, 457, 458, 458SS, 556, 557, 558, 582, 592 - 4 Required)	Baler Belt, 7" x 466.50" Upper 3-ply DT, Alligator Connector	AM3P7X467DTA	\$ 259.00
	Baler Belt, 7" x 466.50" Upper 3-ply DT, Clipper Connector	AM3P7X467DTC	\$ 242.00
	Baler Belt, 7" x 466.50" Upper 3-ply DT, HP	AM3P7X467DTHP	\$ 260.00
Round Baler: (410 - 6 Required)	Baler Belt, 4" x 415" Upper 3-ply TT, Clipper Connector	AM3P4X415TTC	\$ 145.00
	Baler Belt, 4" x 415" Upper 2-ply TT, Clipper Connector	AM2P4X415TTC	\$ 120.00
Round Balers: (410 - 5 Required), (510 - 7 Required)	Baler Belt, 8" x 74.50" Upper 3-ply TT, Alligator Connector	AM3P8X75TTA	\$ 115.00
Round Baler: (410 - 2 Required)	Baler Belt, 10" x 415" Upper 3-ply TT, Clipper Connector	AM3P10X415TTC	\$ 318.00
	Baler Belt, 10" x 415" Upper 2-ply TT, Clipper Connector	AM2P10X415TTC	\$ 266.20
Round Baler: (410 - Order Quantity as Required)	Baler Belt, 12" x 417.50" Upper 3-ply TT, Clipper Connector	AM3P12X418TTC	\$ 380.00
	Baler Belt, 12" x 417.50" Upper 2-ply TT, Clipper Connector	AM2P12X418TTC	\$ 329.53

Belts

Baler Parts

Baler Parts

Belts

Application	Description	Part Number	Retail Price
Round Balers: (430, 435, 466, 467, 468, 468SS - 2 Required), (530, 535, 536, 567, 568 - 4 Required)	Baler Belt, 7" x 525" Upper 3-ply DT, Alligator Connector	AM3P7X525DTA	\$ 286.00
	Baler Belt, 7" x 525" Upper 3-ply DT, Clipper Connector	AM3P7X525DTC	\$ 269.00
	Baler Belt, 7" x 525" Upper 3-ply DT, HP	AM3P7X525DTHP	\$ 311.00
Round Balers: (430, 435, 466, 467, 468, 468SS, 530, 535, 536, 567, 568 - 4 Required)	Baler Belt, 7" x 531" Upper 3-ply DT, Alligator Connector	AM3P7X531DTA	\$ 306.00
	Baler Belt, 7" x 531" Upper 3-ply DT, Clipper Connector	AM3P7X531DTC	\$ 272.00
	Baler Belt, 7" x 531" Upper 3-ply DT, HP	AM3P7X531DTHP	\$ 314.00
Round Baler: (500 - 9 Required)	Baler Belt, 4" x 422" Upper 3-ply TT, Clipper Connector	AM3P4X422TTC	\$ 147.00
	Baler Belt, 4" x 422" Upper 2-ply TT, Clipper Connector	AM2P4X422TTC	\$ 119.60
Round Baler: (500 - 2 Required)	Baler Belt, 10" x 422" Upper 3-ply TT, Clipper Connector	AM3P10X422TTC	\$ 322.00
	Baler Belt, 10" x 422" Upper 2-ply TT, Clipper Connector	AM2P10X422TTC	\$ 270.67
Round Baler: (500 - 1 Required)	Baler Belt, 60" x 138" Lower 2-ply TT, Clipper Connector, V-Guide	AM2P60X138TTC	\$ 600.00
Round Baler: (510 - 9 Required)	Baler Belt, 4" x 484" Upper 3-ply TT, Clipper Connector	AM3P4X484TTC	\$ 164.00
	Baler Belt, 4" x 484" Upper 2-ply TT, Clipper Connector	AM2P4X484TTC	\$ 137.83
Round Baler: (510 - 2 Required)	Baler Belt, 10" x 484" Upper 3-ply TT, Clipper Connector	AM3P10X484TTC	\$ 364.00
	Baler Belt, 10" x 484" Upper 2-ply TT, Clipper Connector	AM2P10X484TTC	\$ 290.00
Round Baler: (510 - Order Quantity as Required)	Baler Belt, 12" x 486.50" Upper 3-ply TT, Clipper Connector	AM3P12X487TTC	\$ 435.00
	Baler Belt, 12" x 486.50" Upper 2-ply TT, Clipper Connector	AM2P12X487TTC	\$ 386.52

For Massey Ferguson®

Application	Description	Part Number	Retail Price
Round Baler: (822 - 6 Required)	Baler Belt, 6.375" x 187.80" Upper 3-ply MRT, Clipper Connector, Front	AM3P6.3X188MRTC	\$ 93.00
	Baler Belt, 6.375" x 187.80" Upper 2-ply TT, Clipper Connector, Front	AM2P6.3X188TTC	\$ 92.42
	Baler Belt, 6.375" x 226.80" Upper 3-ply MRT, Clipper Connector, Rear	AM3P6.3X227MRTC	\$ 108.00
	Baler Belt, 6.375" x 226.80" Upper 2-ply TT, Clipper Connector, Rear	AM2P6.3X227TTC	\$ 108.34
Round Baler: (825 - Requires 6)	Baler Belt, 6" x 462.50" Upper 2-ply TT, Clipper Connector	AM2P6X462TTC	\$ 236.00
Round Balers: (828 - 6 Required), (834 - 8 Required)	Baler Belt, 6.375" x 211.42" Upper 3-ply MRT, Clipper Connector, Front	AM3P6.3X212MRTC	\$ 104.00
	Baler Belt, 6.375" x 211.42" Upper 2-ply TT, Clipper Connector	AM2P6.3X212TTC	\$ 104.10
	Baler Belt, 6.375" x 306.30" Upper 3-ply MRT, Clipper Connector, Rear	AM3P6.3X306MRTC	\$ 140.00
	Baler Belt, 6.375" x 306.30" Upper 2-ply TT, Clipper Connector, Rear	AM2P6.3X306TTC	\$ 140.61

Baler Parts

Baler Parts

Application	Description	Part Number	Retail Price
Round Balers: (1440, 1450, 1455 - 8 Required)	Baler Belt, 4" x 436" Upper 3-ply D95TT, Clipper Connector	AM3P4X436TTC	\$ 169.00
	Baler Belt, 4" x 436" Upper 2-ply TT, Clipper Connector	AM2P4X436TTC	\$ 173.00
Round Balers: (1440, 1450, 1455 - 2 Required)	Baler Belt, 9" x 436" Upper 3-ply TT, Clipper Connector	AM3P9X436TTC	\$ 338.00
	Baler Belt, 9" x 436" Upper 2-ply TT, Clipper Connector	AM2P9X436TTC	\$ 356.00
Round Balers: (1440, 1450, 1455 - 6 Required)	Baler Belt, 10" x 436" Upper 3-ply RC, Clipper Connector	AM3P10X436TTC	\$ 371.00
	Baler Belt, 10" x 436" Upper 2-ply TT, Clipper Connector	AM2P10X436TTC	\$ 352.00
Round Balers: (1500, 1560, 1565 - 6 Required)	Baler Belt, 4" x 512" Upper 3-ply RC, Clipper Connector	AM3P4X512TTC	\$ 191.00
	Baler Belt, 4" x 512" Upper 2-ply TT, Clipper Connector	AM2P4X512TTC	\$ 177.00
Round Balers: (1500, 1560, 1565 - 3 Required)	Baler Belt, 9" x 512" Upper 3-ply TT, Clipper Connector	AM3P9X512TTC	\$ 389.00
	Baler Belt, 9" x 512" Upper 2-ply TT, Clipper Connector	AM2P9X512TTC	\$ 412.00
Round Balers: (1500, 1560, 1565 - 2 Required)	Baler Belt, 10" x 512" Upper 3-ply TT, Clipper Connector	AM3P10X512TTC	\$ 428.00
	Baler Belt, 10" x 512" Upper 2-ply TT, Clipper Connector	AM2P10X512TTC	\$ 409.00
Round Balers: (1745, 2745 - 4 Required)	Baler Belt, 7" x 475" Upper 3-ply DT, Alligator Connector	AM3P7X475DTA	\$ 312.00
Round Balers: (1745, 2745 - 2 Required)	Baler Belt, 7" x 483" Upper 3-ply DT, Alligator Connector	AM3P7X483DTA	\$ 314.00
Round Baler: (1850 - 8 Required)	Baler Belt, 6" x 545.50" Upper 2-ply TT, Clipper Connector	AM2P6X545TTC	\$ 272.00
Round Balers: 1746, 1756	Baler Belt, 7" x 571" Upper 3-ply DT, Alligator Connector	AM3P7X571DTA	\$ 359.00
Round Balers: (1746, 1756 - 2 Required)	Baler Belt, 7" x 578" Upper 3-ply DT, Alligator Connector	AM3P7X578DTA	\$ 364.00
Round Balers: (2746, 2756 - 4 Required), (2746A - 6 Required), (2756A - 8 Required)	Baler Belt, 7" x 547" Upper 3-ply DT, Alligator Connector	AM3P7X547DTA	\$ 349.00
Round Balers: (2846, 2846A - 2 Required), (2856, 2856A - 4 Required)	Baler Belt, 7" x 563.50" Upper 3-ply DT, Alligator Connector	AM3P7X564DTA	\$ 356.00

For McKee®

Application	Description	Part Number	Retail Price
Round Balers: 875, 878	Baler Belt, 7" x 64.50" Upper 2-ply TT, Clipper Connector	AM2P7X64TTC	\$ 53.00
Round Balers: (875, 878 - 6 Required)	Baler Belt, 7" x 104.50" Lower 3-ply TT, Clipper Connector	AM3P7X105TTC	\$ 89.00
	Baler Belt, 7" x 104.50" Lower 2-ply TT, Clipper Connector	AM2P7X105TTC	\$ 73.00
Round Balers: (1500, 1578 - 55 Required)	Baler Belt, 4.75" x 73.25" Upper 3-ply TT, Clipper Connector	AM3P4.75X73TTC	\$ 53.00
	Baler Belt, 4.75" x 73.25" Upper 2-ply TT, Clipper Connector	AM2P4.75X73TTC	\$ 57.00
Round Balers: (1500, 1578 - 25 Required)	Baler Belt, 11" x 73.25" Upper 2-ply TT, Clipper Connector	AM2P11X73TTC	\$ 71.65
Round Baler: (1578 - 25 Required)	Baler Belt, 11" x 73.25" Upper 3-ply TT, Clipper Connector	AM3P11X73TTC	\$ 94.00
Round Baler: 1578 - Order Quantity as Required)	Baler Belt, 11" x 121.25" Lower 3-ply TT, Clipper Connector	AM3P11X121TTC	\$ 129.00

Prices Subject to Change without Prior Notice. The use of original equipment manufacturer (OEM) part numbers or trademarks, e.g. Case® and John Deere®, are for reference purposes only and for indicating product use and compatibility. Our company and the listed replacement parts contained herein are not sponsored, approved or manufactured by the OEM. All parts are New unless designated Reman in the description.

Baler Parts

Application	Description	Part Number	Retail Price
Round Baler: (1578 - 5 Required)	Baler Belt, 11" x 121.25" Lower 2-ply TT, Clipper Connector	AM2P11X121TTC	\$ 117.00

For New Idea®

Application	Description	Part Number	Retail Price
Bale Thrower: 22, Square Balers: 7205, 7210, 7215	Bale Thrower Belt, 12" x 72"	AM2P12X72DTC	\$ 141.00
Round Balers: (456, 486, 4865 - 55 Required), (483, 484 - 30 Required)	Baler Belt, 4.75" x 73.25" Upper 3-ply TT, Clipper Connector	AM3P4.75X73TTC	\$ 53.00
	Baler Belt, 4.75" x 73.25" Upper 2-ply TT, Clipper Connector	AM2P4.75X73TTC	\$ 57.00
Round Balers: (456, 486, 4865 - Order Quantity as Required)	Baler Belt, 4.75" x 73.25" Upper 3-ply TT, Clipper Connector, BK Cleat	AM3P4.75X73TTCBC	\$ 59.00
	Baler Belt, 4.75" x 73.25" Upper 2-ply TT, Clipper Connector, BK Cleat	AM2P4.75X73TTCBC	\$ 54.50
Round Balers: (456, 486, 4865 - 25 Required), (483, 4844 - 12 Required), (484, 4845 - 20 Required), (485, 4855 - 20 Required)	Baler Belt, 11" x 73.25" Upper 3-ply TT, Clipper Connector	AM3P11X73TTC	\$ 94.00
Round Balers: (456, 486, 4865 - 25 Required), (483, 4844 - 12 Required), (484 - 15 Required), (485, 4855 - 20 Required), (4845 - 15 Required)	Baler Belt, 11" x 73.25" Upper 2-ply TT, Clipper Connector	AM2P11X73TTC	\$ 71.65
Round Balers: (456, 486, 4865 - 25 Required), (485 - 20 Required)	Baler Belt, 11" x 73.25" Upper 3-ply TT, Alligator Connector	AM3P11X73TTA	\$ 125.00
	Baler Belt, 11" x 73.25" Upper 2-ply TT, Alligator Connector	AM2P11X73TTA	\$ 141.22
Round Balers: (456, 486, 4865 - 5 Required), (485 - 4 Required)	Baler Belt, 11" x 121.25" Lower 3-ply TT, Alligator Connector	AM3P11X121TTA	\$ 160.00
	Baler Belt, 11" x 121.25" Lower 2-ply TT, Alligator Connector	AM2P11X121TTA	\$ 180.55
	Baler Belt, 11" x 121.25" Lower 3-ply TT, Clipper Connector	AM3P11X121TTC	\$ 129.00
	Baler Belt, 11" x 121.25" Lower 2-ply TT, Clipper Connector	AM2P11X121TTC	\$ 117.00
Round Balers: (483, 484, 4844, 4845 - 5 Required)	Baler Belt, 11" x 103.50" Upper 2-ply TT, Clipper Connector	AM2P11X104TTC	\$ 103.00
Round Balers: (4643, 6243, 6343 - 5 Required)	Baler Belt, 4.80" x 364" Upper 3-ply MRT, Clipper Connector	AM3P4.8X364MRTC	\$ 183.00
	Baler Belt, 4.80" x 364" Upper 2-ply TT, Clipper Connector	AM2P4.8X364TTC	\$ 120.68
Round Balers: (4644, 6244, 6344 - 6 Required)	Baler Belt, 7" x 366" Upper 2-ply TT, Clipper Connector	AM2P7X366TTC	\$ 173.63
Round Balers: (4664 - 6 Required), (4665 - 8 Required)	Baler Belt, 7" x 562.50" Upper 2-ply TT, Clipper Connector	AM2P7X563TTC	\$ 256.36
Round Baler: (6254 - 4 Required)	Baler Belt, 7" x 481.50" Upper 3-ply DT, Alligator Connector	AM3P7X482DTA	\$ 314.00
Round Baler: (6254 - 2 Required)	Baler Belt, 7" x 478.50" Upper 3-ply MRT, Alligator Connector	AM3P7X479MRTA	\$ 238.71
	Baler Belt, 7" x 486.50" Upper 3-ply DT, Alligator Connector	AM3P7X487DTA	\$ 304.00
Round Balers: (6345, 6454 - 6 Required)	Baler Belt, 7" x 475" Upper 3-ply MRT, Titan	AM3P7X475MRT1T	\$ 282.00

Belts

Baler Parts

Baler Parts

For Vermeer®

Application	Description	Part Number	Retail Price
Round Balers: (403F, 403G - 6 Required)	Baler Belt, 4" x 358" Upper 3-ply TT, Clipper Connector	AM3P4X358TTC	\$ 144.00
	Baler Belt, 4" x 358" Upper 2-ply TT, Clipper Connector	AM2P4X358TTC	\$ 147.00
Round Balers: (403F, 403G - 2 Required)	Baler Belt, 9" x 358" Upper 3-ply TT, Clipper Connector	AM3P9X358TTC	\$ 284.00
	Baler Belt, 9" x 358" Upper 2-ply TT, Clipper Connector	AM2P9X358TTC	\$ 298.00
Round Baler: (503I - 4 Required)	Baler Belt, 6.50" x 431" Upper 3-ply TT, Clipper Connector	AM3P6.5X431TTC	\$ 193.00
	Baler Belt, 6.50" x 431" Upper 2-ply TT, Clipper Connector	AM2P6.5X431TTC	\$ 183.53
Round Baler: (504C - 8 Required)	Baler Belt, 4" x 388" Upper 3-ply TT, Clipper Connector	AM3P4X388TTC	\$ 153.00
	Baler Belt, 4" x 388" Upper 2-ply TT, Clipper Connector	AM2P4X388TTC	\$ 158.00
Round Baler: (504C - 2 Required)	Baler Belt, 9" x 388" Upper 3-ply TT, Clipper Connector	AM3P9X388TTC	\$ 304.00
	Baler Belt, 9" x 388" Upper 2-ply TT, Clipper Connector	AM2P9X388TTC	\$ 290.00
Round Balers: (504F, 504G, 504H, 504I - 8 Required)	Baler Belt, 4" x 436" Upper 3-ply D95TT, Clipper Connector	AM3P4X436TTC	\$ 169.00
	Baler Belt, 4" x 436" Upper 2-ply TT, Clipper Connector	AM2P4X436TTC	\$ 173.00
Round Balers: (504F, 504G, 504H, 504I - 2 Required)	Baler Belt, 9" x 436" Upper 3-ply TT, Clipper Connector	AM3P9X436TTC	\$ 338.00
	Baler Belt, 9" x 436" Upper 2-ply TT, Clipper Connector	AM2P9X436TTC	\$ 356.00
Round Balers: (504F, 504G, 504H, 504I - Order Quantity as Required)	Baler Belt, 10" x 436" Upper 3-ply RC, Clipper Connector	AM3P10X436TTC	\$ 371.00
Round Balers: (504F, 504G, 504H, 504I - 6 Required)	Baler Belt, 10" x 436" Upper 2-ply TT, Clipper Connector	AM2P10X436TTC	\$ 352.00
Round Baler: (504I - 6 Required)	Baler Belt, 6" x 428" Upper 3-ply TT, Clipper Connector	AM3P6X428TTC	\$ 237.00
Round Baler: (504I - 4 Required)	Baler Belt, 6" x 428" Upper 2-ply TT, Clipper Connector	AM2P6X428TTC	\$ 245.00
Round Balers: (504IS - Order Quantity as Required), (504L, 5400 - 2 Required), (505I, 505L - 3 Required)	Baler Belt, 14" x 424" Upper 3-ply TT, Clipper Connector	AM3P14X424TTC	\$ 503.00
	Baler Belt, 14" x 424" Upper 2-ply TT, Clipper Connector	AM2P14X424TTC	\$ 532.00
Round Balers: (504M ASN 404, 5520 - 3 Required), (505M BSN 429 - 4 Required), (5420 - 2 Required)	Baler Belt, 6.80" x 427" Upper 2-ply 0.285 MRT, Alligator Connector	AM3P6.8X427MRT3A	\$ 372.00
	Baler Belt, 6.80" x 437" Upper 3-ply 0.285 MRT, Alligator Connector	AM3P6.8X437MRT3A	\$ 378.00
Round Baler: (505M - 4 Required)	Baler Belt, 6.80" x 409" Upper 2-ply TT, Clipper Connector	AM2P6.8X409TTC	\$ 223.71
	Baler Belt, 6.80" x 419" Upper 2-ply TT, Clipper Connector	AM2P6.8X419TTC	\$ 229.24
Round Balers: (554XL, 555XL, 5500 - 2 Required)	Baler Belt, 6" x 450" Upper 3-ply TT, Clipper Connector	AM3P6X450TTC	\$ 245.00
Round Balers: (554XL, 555XL w/ Standard Pickup - 2 Required), (5500 - 2 Required)	Baler Belt, 6" x 450" Upper 2-ply TT, Clipper Connector	AM2P6X450TTC	\$ 255.00
Round Balers: (554XL - w/ Standard Pickup, 2 Required), (555XL - w/ Standard Pickup, 5500 - 3 Required)	Baler Belt, 14" x 450" Upper 3-ply TT, Clipper Connector	AM3P14X450TTC	\$ 528.00
	Baler Belt, 14" x 450" Upper 2-ply TT, Clipper Connector	AM2P14X450TTC	\$ 562.00

Belts

Baler Parts

Baler Parts

Application	Description	Part Number	Retail Price
Round Balers: (604 Super M - 3 Required), (605 Super M - 4 Required)	Baler Belt, 6.80" x 540" Upper 3-ply MRT, Alligator Connector	AM3P6.8X540MRT3A	\$ 354.00
Round Balers: (604J - 6 Required), (604K, 604L, 604XL, 605K, 605L, 605XL - 2 Required), (605J - 8 Required)	Baler Belt, 6.50" x 528" Upper 3-ply TT, Clipper Connector	AM3P6.5X528TTC	\$ 229.00
	Baler Belt, 6.50" x 528" Upper 2-ply TT, Clipper Connector	AM2P6.5X528TTC	\$ 282.37
Round Balers: (604K, 604L, 604XL - 2 Required), (605K, 605L, 605XL - 3 Required)	Baler Belt, 14" x 528" Upper 3-ply TT, Clipper Connector	AM3P14X528TTC	\$ 474.00
	Baler Belt, 14" x 528" Upper 2-ply TT, Clipper Connector	AM2P14X528TTC	\$ 809.25
Round Balers: (604M - 3 Required), (605M - 4 Required)	Baler Belt, 6.80" x 522" Upper 3-ply MRT, Alligator Connector	AM3P6.8X522MRT3A	\$ 334.00
Round Balers: (604M, 604 Super M - 3 Required), (605M, 605 Super M - 4 Required)	Baler Belt, 6.80" x 533" Upper 3-ply MRT, Alligator Connector	AM3P6.8X533MRT3A	\$ 342.00
Round Baler: (605A - 9 Required)	Baler Belt, 4" x 400" Upper 3-ply TT, Clipper Connector	AM3P4X400TTC	\$ 142.00
	Baler Belt, 4" x 400" Upper 2-ply TT, Clipper Connector	AM2P4X400TTC	\$ 146.00
Round Baler: (605A - 2 Required)	Baler Belt, 10" x 400" Upper 3-ply TT, Clipper Connector	AM3P10X400TTC	\$ 309.00
	Baler Belt, 10" x 400" Upper 2-ply TT, Clipper Connector	AM2P10X400TTC	\$ 325.00
Round Balers: (605A, 605B - 1 Required)	Baler Belt, 60" x 120" Lower 2-ply TT, Clipper Connector	AM2P60X120TTC	\$ 562.00
Round Baler: (605B - 9 Required)	Baler Belt, 4" x 387" Upper 3-ply TT, Clipper Connector	AM3P4X387TTC	\$ 116.00
	Baler Belt, 4" x 387" Upper 2-ply TT, Clipper Connector	AM2P4X387TTC	\$ 109.33
Round Baler: (605B - 2 Required)	Baler Belt, 10" x 387" Upper 3-ply TT, Clipper Connector	AM3P10X387TTC	\$ 335.00
	Baler Belt, 10" x 387" Upper 2-ply TT, Clipper Connector	AM2P10X387TTC	\$ 352.00
Round Balers: (605C - 9 Required), (605E - 5 Required)	Baler Belt, 4" x 440" Upper 3-ply TT, Clipper Connector	AM3P4X440TTC	\$ 153.00
	Baler Belt, 4" x 440" Upper 2-ply TT, Clipper Connector	AM2P4X440TTC	\$ 157.00
Round Balers: (605C, 605E - 2 Required)	Baler Belt, 10" x 440" Upper 3-ply TT, Clipper Connector	AM3P10X440TTC	\$ 335.00
	Baler Belt, 10" x 440" Upper 2-ply TT, Clipper Connector	AM2P10X440TTC	\$ 354.00
Round Baler: (605D - 9 Required)	Baler Belt, 4" x 450" Upper 3-ply TT, Clipper Connector	AM3P4X450TTC	\$ 156.00
	Baler Belt, 4" x 450" Upper 2-ply TT, Clipper Connector	AM2P4X450TTC	\$ 160.00
Round Baler: (605D - 2 Required)	Baler Belt, 10" x 450" Upper 3-ply TT, Clipper Connector	AM3P10X450TTC	\$ 341.00
	Baler Belt, 10" x 450" Upper 2-ply TT, Clipper Connector	AM2P10X450TTC	\$ 361.00
Round Baler: (605E - 5 Required)	Baler Belt, 4" x 457" Upper 3-ply TT, Clipper Connector	AM3P4X457TTC	\$ 157.00
	Baler Belt, 4" x 457" Upper 2-ply TT, Clipper Connector	AM2P4X457TTC	\$ 162.00
Round Baler: (605E - 2 Required)	Baler Belt, 10" x 457" Upper 3-ply TT, Clipper Connector	AM3P10X457TTC	\$ 346.00
	Baler Belt, 10" x 457" Upper 2-ply TT, Clipper Connector	AM2P10X457TTC	\$ 367.00

Belts

Baler Parts

Baler Parts

Belts

Application	Description	Part Number	Retail Price
Round Balers: (605F, 605G, 605H - 6 Required)	Baler Belt, 4" x 512" Upper 3-ply RC, Clipper Connector	AM3P4X512TTC	\$ 191.00
	Baler Belt, 4" x 512" Upper 2-ply TT, Clipper Connector	AM2P4X512TTC	\$ 177.00
Round Balers: (605F, 605G, 605H - 3 Required)	Baler Belt, 9" x 512" Upper 3-ply TT, Clipper Connector	AM3P9X512TTC	\$ 389.00
	Baler Belt, 9" x 512" Upper 2-ply TT, Clipper Connector	AM2P9X512TTC	\$ 412.00
Round Balers: (605F, 605G, 605H - 2 Required)	Baler Belt, 10" x 512" Upper 3-ply TT, Clipper Connector	AM3P10X512TTC	\$ 428.00
	Baler Belt, 10" x 512" Upper 2-ply TT, Clipper Connector	AM2P10X512TTC	\$ 409.00
Round Baler: (605J - 8 Required)	Baler Belt, 6.50" x 542" Upper 3-ply TT, Clipper Connector	AM3P6.5X542TTC	\$ 309.00
	Baler Belt, 6.50" x 542" Upper 2-ply TT, Clipper Connector	AM2P6.5X542TTC	\$ 324.00
Round Baler: (706A - 11 Required)	Baler Belt, 4" x 493" Upper 3-ply TT, Clipper Connector	AM3P4X493TTC	\$ 167.00
	Baler Belt, 4" x 493" Upper 2-ply TT, Clipper Connector	AM2P4X493TTC	\$ 172.00
Round Baler: (706A - 2 Required)	Baler Belt, 10" x 493" Upper 3-ply TT, Clipper Connector	AM3P10X493TTC	\$ 369.00
	Baler Belt, 10" x 493" Upper 2-ply TT, Clipper Connector	AM2P10X493TTC	\$ 395.00
Round Baler: (706C - 11 Required)	Baler Belt, 4" x 541" Upper 3-ply TT, Clipper Connector	AM3P4X541TTC	\$ 180.00
	Baler Belt, 4" x 541" Upper 2-ply TT, Clipper Connector	AM2P4X541TTC	\$ 186.00
Round Baler: (706C - 2 Required)	Baler Belt, 10" x 541" Upper 3-ply TT, Clipper Connector	AM3P10X541TTC	\$ 404.00
	Baler Belt, 10" x 541" Upper 2-ply TT, Clipper Connector	AM2P10X541TTC	\$ 429.00
Round Baler: (5410 BSN 1136 - 3 Required)	Baler Belt, 6" x 409" Upper 3-ply MRT, Clipper Connector	AM3P6X409MRT3C	\$ 303.00
	Baler Belt, 6" x 419" Upper 3-ply MRT, Clipper Connector	AM3P6X419MRT3C	\$ 307.00
Round Baler: (5410 ASN 1136 - 3 Required)	Baler Belt, 6" x 427" Upper 3-ply MRT, Clipper Connector	AM3P6X427MRT3C	\$ 312.00
	Baler Belt, 6" x 437" Upper 3-ply MRT, Clipper Connector	AM3P6X437MRT3C	\$ 318.00

For Vicon®

Application	Description	Part Number	Retail Price
Round Baler: 260	Baler Belt, 7" x 64.50" Upper 2-ply TT, Clipper Connector	AM2P7X64TTC	\$ 53.00
Round Balers: (260, RP1210 - 6 Required)	Baler Belt, 7" x 104.50" Lower 3-ply TT, Clipper Connector	AM3P7X105TTC	\$ 89.00
	Baler Belt, 7" x 104.50" Lower 2-ply TT, Clipper Connector	AM2P7X105TTC	\$ 73.00
Round Balers: (560, RP1510 - 25 Required)	Baler Belt, 11" x 73.25" Upper 3-ply TT, Clipper Connector	AM3P11X73TTC	\$ 94.00
	Baler Belt, 11" x 73.25" Upper 2-ply TT, Clipper Connector	AM2P11X73TTC	\$ 71.65
Round Balers: (560, RP1510 - 5 Required)	Baler Belt, 11" x 121.25" Lower 3-ply TT, Clipper Connector	AM3P11X121TTC	\$ 129.00
	Baler Belt, 11" x 121.25" Lower 2-ply TT, Clipper Connector	AM2P11X121TTC	\$ 117.00

Prices Subject to Change without Prior Notice. The use of original equipment manufacturer (OEM) part numbers or trademarks, e.g. Case® and John Deere®, are for reference purposes only and for indicating product use and compatibility. Our company and the listed replacement parts contained herein are not sponsored, approved or manufactured by the OEM. All parts are New unless designated Reman in the description.

Baler Parts

Application	Description	Part Number	Retail Price
Round Baler: (1200 - 4 Required)	Baler Belt, 4" x 465" Upper 3-ply TT, Clipper Connector	AM3P4X465TTC	\$ 159.00
	Baler Belt, 4" x 465" Upper 2-ply TT, Clipper Connector	AM2P4X465TTC	\$ 164.00
Round Baler: (1200 - 2 Required)	Baler Belt, 9" x 465" Upper 3-ply TT, Clipper Connector	AM3P9X465TTC	\$ 319.00
	Baler Belt, 9" x 465" Upper 2-ply TT, Clipper Connector	AM2P9X465TTC	\$ 339.00
Round Baler: (1201 - Order Quantity as Required)	Baler Belt, 6.37" x 187.50" Upper 3-ply MRT, Alligator Connector	AM3P6.3X188MRTA	\$ 114.00
	Baler Belt, 6.375" x 187.80" Upper 2-ply TT, Clipper Connector, Front	AM2P6.3X188TTC	\$ 92.42
Round Balers: (1201 - Order Quantity as Required), (RV187 - 6 Required)	Baler Belt, 6.37" x 205.90" Upper 3-ply MRT, Alligator Connector	AM3P6.3X206MRTA	\$ 125.00
Round Balers: (1201, RV187 - 6 Required)	Baler Belt, 6.37" x 205.90" Upper 2-ply MRT, Alligator Connector	AM2P6.3X206TTC	\$ 101.50
Round Balers: (1281 - Order Quantity as Required), (RV186 - 6 Required)	Baler Belt, 6.37" x 211.50" Upper 3-ply MRT, Alligator Connector	AM3P6.3X212MRTA	\$ 129.00
	Baler Belt, 6.375" x 211.42" Upper 2-ply TT, Clipper Connector	AM2P6.3X212TTC	\$ 104.10
Round Balers: (1281 - Order Quantity as Required), (RV186, RV187 - 6 Required)	Baler Belt, 6.37" x 306.30" Upper 3-ply MRT, Alligator Connector	AM3P6.3X306MRTA	\$ 163.00
	Baler Belt, 6.375" x 306.30" Upper 2-ply TT, Clipper Connector, Rear	AM2P6.3X306TTC	\$ 140.61
Round Baler: (RP1210 - 45 Required)	Baler Belt, 4.75" x 64.75" Upper 3-ply TT, Clipper Connector	AM3P4.75X65TTC	\$ 58.00
	Baler Belt, 4.75" x 64.75" Upper 2-ply TT, Clipper Connector	AM2P4.75X65TTC	\$ 43.69
Round Baler: (RP1210 - 30 Required)	Baler Belt, 7" x 64.75" Upper 2-ply TT, Clipper Connector	AM2P7X65TTC	\$ 46.77
Round Baler: (RP1211 - 25 Required)	Baler Belt, 7.28" x 64.80" Upper 3-ply TT, Clipper Connector	AM3P7.28X65TTC	\$ 47.00
	Baler Belt, 7.28" x 64.80" Upper 2-ply TT, Clipper Connector	AM2P7.3X65TTC	\$ 48.49
Round Baler: (RP1211 - 5 Required)	Baler Belt, 7.28" x 96.85" Lower 3-ply TT, Clipper Connector	AM3P7.28X97TTC	\$ 85.00
	Baler Belt, 7.28" x 96.85" Lower 2-ply TT, Clipper Connector	AM2P7.3X97TTC	\$ 70.67
Round Baler: (RP1510 - 55 Required)	Baler Belt, 4.75" x 73.25" Upper 3-ply TT, Clipper Connector	AM3P4.75X73TTC	\$ 53.00
	Baler Belt, 4.75" x 73.25" Upper 2-ply TT, Clipper Connector	AM2P4.75X73TTC	\$ 57.00
Round Baler: (RP1511 - 25 Required)	Baler Belt, 11" x 75.75" Upper 3-ply TT, Clipper Connector	AM3P11X76TTC	\$ 72.00
	Baler Belt, 11" x 75.75" Upper 2-ply TT, Clipper Connector	AM2P11X76TTC	\$ 72.18
Round Baler: (RP1511 - 5 Required)	Baler Belt, 11" x 112" Lower 3-ply TT, Clipper Connector	AM3P11X112TTC	\$ 99.00
	Baler Belt, 11" x 112" Lower 2-ply TT, Clipper Connector	AM2P11X112TTC	\$ 107.91
Round Baler: (RV157 - 6 Required)	Baler Belt, 6.37" x 194" Upper 3-ply MRT, Alligator Connector	AM3P6.3X194MRTA	\$ 107.00
	Baler Belt, 6.37" x 194" Front 2-ply TT, Clipper Connector	AM2P6.3X194TTC	\$ 95.63
	Baler Belt, 6.37" x 259" 3-ply MRT, Alligator Connector, Rear	AM3P6.3X259MRTA	\$ 137.00
	Baler Belt, 6.37" x 259" Rear 2-ply TT, Clipper Connector	AM2P6.3X259TTC	\$ 128.21

Belts

Baler Parts

Baler Parts

Belts	Application	Description	Part Number	Retail Price
	Round Baler: (RV1501 - 5 Required)	Baler Belt, 8.46" x 403.54"	AM3P8.4X404MRTHP	\$ 263.00
		Upper 3-ply MRT, HP		
		Baler Belt, 8.46" x 403.54"	AM3P8.4X404MRTC	\$ 236.00
	Round Baler: (RV1601 - 5 Required)	Upper 3-ply MRT, Clipper Connector		
		Baler Belt, 8.46" x 403.54"	AM2P8.4X404TTC	\$ 233.16
		Upper 2-ply TT, Clipper Connector		
	Round Baler: (RV1601 - 5 Required)	Baler Belt, 8.46" x 421.26"	AM3P8.4X421MRTHP	\$ 279.00
		Upper 3-ply MRT, HP		
		Baler Belt, 8.46" x 421.26"	AM3P8.4X421MRTC	\$ 244.00
Round Baler: (RV1901 - 5 Required)	Upper 3-ply MRT, Clipper Connector			
	Baler Belt, 8.46" x 421.26"	AM2P8.4X422TTC	\$ 241.80	
	Upper 2-ply TT, Clipper Connector			
Round Baler: (RV1901 - 5 Required)	Baler Belt, 8.46" x 472.44"	AM3P8.4X472MRTHP	\$ 303.00	
	Upper 3-ply MRT, HP			
	Baler Belt, 8.46" x 472.44"	AM3P8.4X472MRTC	\$ 270.00	
Round Baler: (RV1901 - 5 Required)	Lower 3-ply MRT, Clipper Connector			
	Baler Belt, 8.46" x 472.44"	AM2P8.4X472TTC	\$ 266.80	
		Upper 2-ply TT, Clipper Connector		

Belt Repair Parts

Application	Description	Part Number	Retail Price
John Deere® Round Balers: 430, 435, 449, 450, 456, 457, 458, 459, 460, 466, 467, 468, 469, 530, 535, 550, 556, 557, 558, 559, 560, 565, 567, 568, 569, 572, 575, 592, 854	Belt Clip Splice Plate, 14 Segment 7" Long Replaces 411295862	AMAE53298	\$ 12.00

Swather Parts

Table of Contents

Swather Parts for AGCO®.....	215	Draper Belts.....	239
Guards.....	215	Drive Hub Assembly.....	241
Swather Parts for Case®.....	216	Guards and Cutter Bar Parts.....	237
Draper Belts.....	216	Platform Components.....	238
Swather Parts for Case IH®.....	216	Radiator Hoses and Thermostats.....	234
Alternators.....	217	Sensors.....	235
Camshafts and Lifters.....	216	Sickle Assemblies With Heads.....	236
Cutter Bar Components.....	218	Sickle Drives and Components.....	238
Cylinder Heads, Bare.....	216	Sickle Knife Heads.....	235
Draper Belts.....	219	Skid Shoes.....	236
Fuel Lift Pumps.....	217	Water Pumps and Components.....	235
Guards and Cutter Bar Parts.....	219	Swather Parts for Krone®.....	241
Injectors.....	217	Cutter Bar Components.....	241
Oil Pumps, Engine.....	215	Swather Parts for Kuhn®.....	241
Sickle Assemblies With Heads.....	218	Belts.....	241
Sickle Knife Heads.....	217	Cutter Bar Components.....	241
Water Pump Components.....	221	Swather Parts for MacDon®.....	242
Swather Parts for Hesston®.....	229	Guards and Cutter Bar Parts.....	243
Camshafts.....	229	Sickle Drives and Components.....	242
Draper Belts.....	230	Swather Parts for Massey Ferguson®.....	243
Guards.....	230	Draper Belts.....	244
Sickle Assemblies With Heads.....	229	Guards.....	243
Water Pumps.....	229	Swather Parts for New Holland®.....	221
Swather Parts for International®.....	232	Air Cleaner Components.....	221
Draper Belts.....	232	Belts.....	228
Swather Parts for John Deere®.....	234	Cutter Bar Components.....	226
Auger Components.....	238	Draper Belts.....	228
Balancer Shafts.....	234	Fuel Lift Pumps.....	222
Belts.....	241	Guards and Cutter Bar Parts.....	227
Camshaft and Lifters.....	234	Reel Components.....	228
Connecting Rods.....	234	Sickle Assemblies With Heads.....	222
Crankshafts.....	234	Sickle Knife Heads.....	222
Cutter Bar Components.....	236	Water Pumps.....	222
Cylinder Heads, Bare.....	235		

Swather Parts for AGCO®

Swather Parts
for AGCO®

Guards

Application	Description	Part Number	Retail Price
AGCO® Platforms: 9020, 9125, 9140 Replaces 700707147, 700716292	Knife Guard, Double Pronged w/ Trash Bar Use w/ 3" Cutter Bar Knife	AM86615982	\$ 11.75

Swather Parts

Swather Parts for Case®

Draper Belts

Application	Description	Part Number	Retail Price
Swathers: 820, 840, 850, 950, 955, 1050, 1140	Draper Belt 10' Right or Left Hand, 40.00" x 85.00" Single V-Guide Replaces FHO28233	AMFHO28407	\$ 191.00
	Draper Belt 12' Right or Left Hand, 40.00" x 107.00" Single V-Guide Replaces FHO28175	AMFHO28415	\$ 265.00
Swathers: 820, 840, 850, 950, 955, 1140	Draper Belt 20' Right or Left Hand, 40.00" x 205.00" Single V-Guide	AMFHO28753	\$ 461.00
Swathers: 840, 950, 1050	Draper Belt 14', 40.00" x 133.00" Single V-Guide Replaces 602819, 8067489, FH028423	AM67489	\$ 260.00
	Draper Belt 16', 40.00" x 157.00" Single V-Guide Replaces 602843, FH028217, FH028431	AM67490	\$ 301.00
Swather: 855	Draper Belt 10' Right or Left Hand, 48.00" x 87.00" Single V-Guide	AMF49326	\$ 272.00
	Draper Belt 12" Right or Left Hand, 48.00" x 108.00" Single V-Guide	AMF49327	\$ 310.00
	Draper Belt 14' Right or Left Hand, 48.00" x 129.00" Single V-Guide	AMF49328	\$ 367.00
	Draper Belt 18' Right or Left Hand, 48.00" x 174.00" Single V-Guide	AMF49330	\$ 499.00
	Draper Belt 20' Right or Left Hand, 48.00" x 198.00" Single V-Guide	AMF49331	\$ 541.00

Swather Parts for Case®

Swather Parts

Swather Parts for Case IH®

Camshafts and Lifters

Application	Description	Part Number	Retail Price
Swathers: 8825, 8850, 8860, 8870, 8880	Rocker Arm Assembly 3.9 and 5.9 Cummins® Engines Replaces J922488	AMJ910814	\$ 40.00

Cylinder Heads, Bare

Application	Description	Part Number	Retail Price
Swathers: 8860, 8860HP	Valve Train Kit Includes (4) Exhaust Valves, (4) Intake Valves, (8) Valve Springs, 0.16" Wire Diameter, (16) Valve Keepers Replaces K3802356, K3900250, K3932453	AMVK1040	\$ 107.00

Swather Parts for Case IH®

Swather Parts

Oil Pumps, Engine

Application	Description	Part Number	Retail Price
Swathers: WDX1002S, WDX1202, WDX1202S - w/ N45 Fiat® Diesel Engine	Engine Oil Pump	AM4897480	\$ 129.60
Swather: 8850 - w/ 5.9 Cummins® Engine	Oil Pump Pickup Tube Replaces J934942	AMJ909373	\$ 140.00

Fuel Lift Pumps

Application	Description	Part Number	Retail Price
Swathers: 8825, 8825HP, 8860, 8860HP, 8870	Fuel Transfer Pump Replaces 87473337, J917998	AM87648717	\$ 80.00
Swather: WD1203, WD1204, WDX1002S, WDX1202, WDX1202S, Speedrower Swather: 130	Fuel Lift Pump Replaces 84268475, 84269570, 504146090	AM2830266	\$ 36.00
Swathers: WDX901, WDX1002S, WDX1101, WDX1202S, WDX1701	Fuel Pump, Electronic 12 Volt, 1.30 Amps, Round Replaces 646193, 9607940, 9843528	AM86506895	\$ 49.32

Injectors

Application	Description	Part Number	Retail Price
Swathers 8825, 8850, 8860, 8870, 8880	Injector	AMJ929490	\$ 40.00
Swather: 8840	Fuel Injector, 7 mm Tip	AMJ919343	\$ 45.00

Alternators

Application	Description	Part Number	Retail Price
Swathers: 4000, 5000, 8820, 8825, 8825HP, 8830, 8840, 8850	Reman Alternator Bosch Type, 12 Volt, 65 Amps, IR/EF	AMRE533516	\$ 188.59
Swathers: 8825HP, 8840, 8850 SN CFH0099001-CFH0099164	Alternator Bosch, 12 Volt, 95 Amps, IR/EF, CW Rotation, w/o Pulley	AMA187623	\$ 105.00
Swathers: WDX1002S, WDX1202, WDX1202S, WDX1902, WDX2302	Alternator 12 Volt, 135 Amps, IR, CW Rotation, w/o Pulley Replaces 91448C1, 86994128	AM125849A1	\$ 217.00



Sickle Knife Heads

Application	Description	Part Number	Retail Price
Swathers: (230, 4000, 5000 - w/ Single Auger), (4000, 5000 - w/ Double Auger)	Knife Head	AM824594C91	\$ 102.00

Swather Parts for Case IH®

Swather Parts

Swather Parts

Sickle Assemblies With Heads

Application	Description		Part Number	Retail Price
Swathers: 230, 4000, 5000 - w/ Single Auger	Sickle Assembly w/ Head, Fine 14 Teeth per Inch	12'	AM824506C94	\$ 390.00
		14'	AM831607C94	\$ 435.00
		16'	AM1281480C92	\$ 455.00
		19'	AM1281481C92	\$ 500.00
	Sickle Assembly w/ Head, Under Serrated	12'	AM827812C92	\$ 390.00
		14'	AM827814C92	\$ 420.00
		16'	AM827815C92	\$ 455.00
		19'	AM827816C92	\$ 500.00
24'		AM827830C92	\$ 615.00	
Swather: 8870, Swather Platform: 8840, Mower Conditioner: 8380	Sickle Assembly w/ Head, Fine Plated, 14 Teeth per Inch, Top Serrated, Self-Sharpening Serrations	7' Right Hand	AM700715166	\$ 290.00
		7' Left Hand	AM700715165	\$ 290.00
	Features bolt-on, fine sections Ships Truck Freight Only	8' Right Hand	AM700715168	\$ 305.00
		8' Left Hand	AM700715167	\$ 305.00
		9' Right Hand	AM700715779	\$ 325.00
		9' Left Hand	AM700715778	\$ 325.00
Swather Platforms: 4000, 5000 - w/ Double Auger	Sickle Assembly w/ Head, Fine 14 Teeth per Inch	14'	AM827701C92	\$ 455.00
	Sickle Assembly w/ Head, Under Serrated	12'	AM827724C92	\$ 355.00
		14'	AM827725C92	\$ 415.00
	16'	AM827726C92	\$ 475.00	
Mower Conditioner: 8340	Sickle Assembly w/ Head, Fine Plated, 14 Teeth per Inch, Top Serrated, Self-Sharpening Serrations Includes Splice Kit Features bolt-together, bolt-on, fine sections Will ship UPS and FedEx	9'	AM700118673	\$ 278.00
		12'	AM700709622	\$ 302.00
	Sickle Assembly w/ Head, Fine 14 Teeth per Inch, Top Serrated, Self-Sharpening Serrations Includes Splice Kit Features bolt-together, bolt-on, fine sections Will ship UPS and FedEx	14'	AM700709623	\$ 280.00

Cutter Bar Components

Application	Description		Part Number	Retail Price	
Swather Platforms: RD163, RD193, Disc Mower Conditioners: DC133, DC163	Disc Mower Blade, 7° Sold in Multiples of 25, Priced Individually 4.57" Long, 1.97" Wide, 0.127" Thick	Right Hand	AM84343226	\$ 3.61	
		Left Hand	AM84343225	\$ 3.61	
	Disc Mower Blade, 14° Sold in Multiples of 25, Priced Individually 4.57" Long, 1.97" Wide, 0.127" Thick	Right Hand	AM84255700	\$ 2.35	
		Left Hand	AM84255699	\$ 2.35	
	Disc Mower Blade, 18° Sold in Multiples of 25, Priced Individually 4.57" Long, 1.97" Wide, 0.127" Thick	Right Hand	AM84271203	\$ 3.61	
		Left Hand	AM84271205	\$ 3.61	
	Swather Platforms: (230, 4000, 5000 - w/ Single Auger), (4000, 5000 - w/ Double Auger)	Sickle Section Top Serrated, 3" Wide, 2.0625" Hole Spacing Sold in Multiples of 25, Priced Individually		AM826720C3	\$ 1.50
Sickle Section Under Serrated, 3" Wide, 2.0625" Hole Spacing Sold in Multiples of 25, Priced Individually			AM826722C3	\$ 1.32	

Swather Parts



Guards and Cutter Bar Parts

Application	Description	Part Number	Retail Price
Swathers: (230, 4000, 5000 - w/ Single Auger), (4000, 5000 - w/ Double Auger)	Knife Guard	AM613839R1	\$ 12.50
Swathers: 6000, 6500	Knife Guard, Single Prong End Use w/ 3" Cutter Bar Knife For 15', 20', 25' and 30' Platforms	AM1338269C1	\$ 10.95
	Knife Guard, Double Pronged w/ Trashbar Use w/ 3" Cutter Bar Knife Replaces 613838R2, 613838R3	AM613838R1	\$ 11.00
Swathers: 8210, 8220, 8230, 8240, 8820, 8830, 8840	Knife Guard Replaces 700700845	AM65327	\$ 11.50
Swather Platforms: HDX121, HDX122, HDX141, HDX142, HDX161, HDX162, HDX181, HDX182, Mower Conditioners: 8320, 8330, SC412, SC414, SC414 Deluxe, SC416 Deluxe Replaces 86521587, 86553340, 87042356	Knife Guard, Double Pronged w/ Trash Bar Use w/ 3" Cutter Bar Knife	AM86615982	\$ 11.75
Swather Platforms: HDX121, HDX122, HDX141, HDX142, HDX161, HDX162, HDX181, HDX182, Mower Conditioner: SMX91	Knife Guard, Double Pronged w/ Trashbar Use w/ 3" Cutter Bar Knife For Drive Head End Replaces 9801347, 86521590, 86553346, 86615983, 87042358, 87042360	AM86615984	\$ 17.00
Mower Conditioners: 721, 725, 730	Knife Guard, Double Pronged w/o Trashbar Use w/ 3" Cutter Bar Knife Replaces 334305A1, 87442324	AM1307299C2	\$ 12.00
Sickle Bar Mowers: 100, 110, 115, 200, 230, 1000, 1100, 1110, 1200, 1300	Guard Stub, Single Prong Forged Replaces 257635, H472717R2	AM472717R2	\$ 10.50
Swathers: (230, 4000, 5000 - w/ Single Auger), (4000, 5000 - w/ Double Auger)	Sickle Section End Replaces 148200C1	AM86617760	\$ 7.25
Mower Conditioner: SMX91	Knife Clip, Low Profile Adjustable Replaces 1307280C3, 71346158, 86630786, H84412	AMX29115	\$ 14.75
	Knife Clip, Low Profile Replaces 1307280C3, 71346158, 86630786, H84412	AMX27554	\$ 3.95
Swathers: 8830, 8840, Swather Platform: 325, Mower Conditioners: 8320, 8330, 8340, 8350, 8360, 8370	Hold Down Clip, Adjustable w/ Set Screws	AM700106782	\$ 13.00
	Hold Down Clip	AM700702736	\$ 12.00
Swathers: 8210, 8220, 8230, 8240, 8820, 8830, 8840, Swather Platforms: HDX121, HDX122, HDX141, HDX142, HDX161, HDX162, HDX181, HDX182, Mower Conditioners: 8320, 8330, 8340, 8350, 8360, 8370, SC412, SC414, SC416	Section Bolt and Nut Kit 7/32" x 5/8" Grade 8 Rib Neck, Package of 50 For Standard Straight Hole Sections Replaces 850716, 700705296	AM86507777	\$ 15.63

Draper Belts

Application	Description	Part Number	Retail Price
Swathers: 742, 750	Draper Belt 21' Left Hand Rear, 41.50" x 191.00" Single V-Guide	AM91058C1	\$ 430.00
	Draper Belt 21', 41.50" x 122.00" Center Deck, Rear Unit Single V-Guide	AM1276662C1	\$ 287.00

Swather Parts for Case IH®

Swather Parts

Swather Parts

Application	Description	Part Number	Retail Price
Swather: 4000 1978 and Later	Draper Belt 24.50' Right or Left Hand, 41.50" x 242.00" Single V-Guide	AM832190C91	\$ 548.00
Swathers: 6000, 6500	Draper Belt 21', 41.50" x 184.50" Single V-Guide	AM1906345C1	\$ 413.00
Swathers: (6000, 6500 Center Deck Extension For 21', 22', 25' or 30')	Draper Belt 21', 22', 25' or 30', 41.50" x 51.00" Single V-Guide	AM1336270C2	\$ 147.00
Swathers: (8210, 8220, 8230, 8240 SN CHF0064001-CFH0064005)	Draper Belt 21' Left Hand, Short Bar, 42.00" x 141.81" Single V-Guide	AM700710161	\$ 339.00
Swathers: (8210, 8220, 8230, 8240 SN CFH0064001-CFH0064005 w/ 21' Platform or SN CFH0065001-CFH0065015 w/ 25' Platform)	Draper Belt 21' or 25' Right Hand, Short Bar, 42.00" x 276.50" Single V-Guide	AM700710162	\$ 638.00
Swathers: (8210, 8220, 8230, 8240 SN CHF0065001-CFH0065015)	Draper Belt 25' Left Hand, Short Bar, 42.00" x 237.81 Single V-Guide	AM700710163	\$ 549.00
Swathers: (8210, 8220, 8230, 8240 SN CHF0066001-CFH0066037)	Draper Belt 30' Right Hand, Short Bar, 42.00" x 244.81" Single V-Guide	AM700710165	\$ 564.00
Swathers: (8210, 8220, 8230, 8240 ASN CFH0066037)	Draper Belt 30' Left Hand, Long Bar, 42.00" x 244.00" Single V-Guide	AM700712958	\$ 558.00
Swathers: (8210, 8220, 8230, 8240 SN CFH0067001-CFH0067003)	Draper Belt 35' Right Hand, Short Bar, 42.00" x 434.00" Single V-Guide	AM700710966	\$ 844.00
	Draper Belt 35' Left Hand, Short Bar, 42.00" x 295.75" Single V-Guide	AM700710965	\$ 682.00
Swathers: (8210, 8220, 8230, 8240 ASN CFH0067003)	Draper Belt 35' Right Hand, Long Bar, 42.00" x 433.80" Single V-Guide	AM700712961	\$ 981.00
	Draper Belt 35' Left Hand, Long Bar, 42.00" x 293.00" Single V-Guide	AM700712960	\$ 669.00
Swather: 8820 SN CFH0050001-CFH0050295	Draper Belt 25' Right Hand, 42.00" x 206.88" Recessed Cleat	AM700710182	\$ 402.00
Swather: 8820	Draper Belt 25' Left Hand, 42.00" x 246.88"	AM700710181	\$ 478.00
	Draper Belt 30', 42.00" x 300.87" Single V-Guide	AM700710183	\$ 585.00
Swather: 8820 ASN CFH0050295	Draper Belt 25' Right Hand, 42.00" x 207.00" Single V-Guide	AM700712987	\$ 478.00
	Draper Belt 25' Left Hand, 42.00" x 247.00" Single V-Guide	AM700712986	\$ 559.00
	Draper Belt 25' or 30', 42.00" x 39.00" Single V-Guide	AM700712990	\$ 149.00
	Draper Belt 30' Right Hand, 42.00" x 261.00" Single V-Guide	AM700712989	\$ 594.00
	Draper Belt 30' Left Hand, 42.00" x 301.00" Single V-Guide	AM700712988	\$ 679.00

Swather Parts for Case IH®

Swather Parts

Swather Parts

Swather Parts for Case IH®

Application	Description	Part Number	Retail Price
Swather: 8820 SN CFH0050001-CFH0050295	Draper Belt 25' or 30', 42.00" x 38.86" Mini Draper for Shiftable Platform Single V-Guide Belt	AM700711197	\$ 167.00
	Draper Belt 30' Right Hand, 42.00" x 260.87" Single V-Guide	AM700710184	\$ 605.00
Swathers: 8820, 8830, 8840 ASN CFH0030454	Draper Belt 21' 42.00" x 199.00" Single V-Guide	AM700712985	\$ 463.00
Swathers: (8820, 8840 SN CFH0030159-CFH0030454), 8830	Draper Belt 18' Left Hand, 42.00" x 166.00" Single V-Guide	AM1700087	\$ 380.00
Swather: 8830	Draper Belt 21' Left Hand, 42.00" x 202.00" Single V-Guide	AM1700103	\$ 468.00
Swather Platforms: 6000, 6500, Mower Conditioners: 721, 725, 730, 736, 742, 750	Draper Belt Extension 36', 41.50" x 15.00" Single V-Guide	AM1336271C2	\$ 62.00
Mower Conditioners: 721, 725, 730, 736, (742, 750 - Left Hand Front)	Draper Belt 25' Left Hand, 41.50" x 225.00" Single V-Guide	AM1276659C1	\$ 513.00
Mower Conditioner: 736	Draper Belt 36' Right or Left Hand, 41.50" x 373.00" Single V-Guide	AM1337589C1	\$ 859.00
Mower Conditioners: 742, 750	Draper Belt 25' Left Hand Rear Belt, 41.50" x 287.00" Single V-Guide	AM1276660C1	\$ 604.00
Mower Conditioner: 8320 Prior to 1993	Draper Belt 30' Right Hand, 42.00" x 369.68" Single V-Guide	AM700710166	\$ 844.00

Water Pump Components

Application	Description	Part Number	Retail Price
Swathers: (8820, 8830, 8840 - w/ Diesel Engine), 8825, 8825HP, 8850, 8860, 8870, 8880, 8880HP	Thermostat Housing Replaces J903756	AMJ914409	\$ 57.00
Swathers: WDX1002S, WDX1202, WDX1202S	Belt Tensioner Replaces 2852161, 2853680, 2854611, 2855622, 2856687, 87415847, 87415848, 87803067	AM504028028	\$ 78.50

Swather Parts

Swather Parts for New Holland®

Swather Parts for New Holland®

Air Cleaner Components

Application	Description	Part Number	Retail Price
Swathers: 910, 912, 1090, 1100, 1112, 1114 Mower Conditioners: 1495, 1496, 1499 Replaces CONN9A633A	Small Precleaner Bowl 7" Diameter	AMP02-0227	\$ 10.00

Swather Parts

Fuel Lift Pumps

Application	Description	Part Number	Retail Price
Swathers: HW305, HW305S, HW325	Fuel Lift Pump Replaces 84268475, 84269570, 504146090	AM2830266	\$ 36.00

Water Pumps

Application	Description	Part Number	Retail Price
Swathers: 116, 1100, 1116, Mower Conditioners: 1495, 1496	Water Pump w/o Pulley Includes Mounting Gasket	AMU5MW0106	\$ 76.00
Swathers: 1100, 1116, Mower Conditioners: 1495, 1496	Water Pump w/o Pulley Replaces 41313218, 41313261	AM41313227	\$ 60.00

Sickle Knife Heads

Application	Description	Part Number	Retail Price
Swather: 1475, Swather Platforms: 300HW, 320, 2200, 2300HS, 2450, 2550	Knife Head, Right Hand Replaces 9622855	AM86617752	\$ 84.00
	Knife Head, Left Hand Replaces 9622854, 89622854	AM86617755	\$ 84.00
Mower Conditioners: 495, 1495	Knife Head	AM86508155	\$ 108.00



Sickle Assemblies With Heads

Application	Description	Part Number		Retail Price
Swathers: 469, 1469	Sickle Assembly w/ Head, Fine 14 Teeth per Inch, Top Serrated, Self-Sharpener Serrations Includes Splice Kit Features bolt-together, bolt-on, fine sections Will ship UPS and FedEx	AM86518678	9'	\$ 230.00
	Sickle Assembly w/ Head, Under Serrated Includes Splice Kit Features bolt-together, bolt-on sections Will ship UPS and FedEx	AM86518677	9'	\$ 270.00
Swather: 1469 ASN 220947, Mower Conditioners: 479, 488	Sickle Assembly w/ Head, Fine 14 Teeth per Inch, Top Serrated, Self-Sharpener Serrations Includes Splice Kit Features bolt-together, bolt-on, fine sections Will ship UPS and FedEx	AM9623570	9'	\$ 265.00
	Sickle Assembly w/ Head, Under Serrated Includes Splice Kit Features bolt-together, bolt-on sections Will ship UPS and FedEx	AM858700	9'	\$ 265.00
Swather: 1475, Swather Platforms: 300HW, 320, 2200, 2300HS, 2450, 2550	Sickle Assembly w/ Head Under Serrated, Self-Sharpener Serrations	AM86528146	9' Right Hand	\$ 235.00
	Features bolt-on sections Ships Truck Freight Only	AM86528145	9' Left Hand	\$ 235.00



Swather Parts

Application	Description	Part Number		Retail Price	
Swather: 1475, Swather Platforms: 300HW, 320, 2200, 2300HS, 2450, 2550	Sickle Assembly w/ Head, Coarse 7 Teeth per Inch, Top Serrated, Self-Sharpening Serrations	AM86589597	6' Right Hand	\$ 180.00	
		AM86589596	6' Left Hand	\$ 180.00	
	Features bolt-on, coarse sections Will ship UPS and FedEx	AM86589595	7' Right Hand	\$ 205.00	
		AM86589594	7' Left Hand	\$ 205.00	
		AM86589593	8' Right Hand	\$ 220.00	
		AM86589592	8' Left Hand	\$ 220.00	
	Sickle Assembly w/ Head, Coarse 7 Teeth per Inch, Top Serrated, Self-Sharpening Serrations	AM86589591	9' Right Hand	\$ 233.00	
		AM86589590	9' Left Hand	\$ 233.00	
	Features bolt-on, coarse sections Ships Truck Freight Only				
Swather: 1475, Swather Platforms: 300HW, 320, 2200, 2300HS, 2450, 2550	Sickle Assembly w/ Head, Coarse Plated, 7 Teeth per Inch, Top Serrated, Self-Sharpening Serrations	AM86589586	6' Right Hand	\$ 195.00	
		AM86589585	6' Left Hand	\$ 195.00	
	Features bolt-on, coarse sections Will ship UPS and FedEx	AM86589584	7' Right Hand	\$ 225.00	
		AM86589583	7' Left Hand	\$ 225.00	
		AM86589582	8' Right Hand	\$ 240.00	
		AM86589581	8' Left Hand	\$ 240.00	
	Sickle Assembly w/ Head, Coarse Plated, 7 Teeth per Inch, Top Serrated, Self-Sharpening Serrations	AM86589580	9' Right Hand	\$ 260.00	
		AM86589579	9' Left Hand	\$ 260.00	
	Features bolt-on, coarse sections Ships Truck Freight Only				
Swather: 1475, Swather Platforms: 300HW, 320, 2200, 2300HS, 2450, 2550	Sickle Assembly w/ Head, Coarse 10 Teeth per Inch, Top Serrated, Self-Sharpening Serrations	AM86616719	6' Right Hand	\$ 180.00	
		AM86616718	6' Left Hand	\$ 180.00	
	Features bolt-on, coarse sections Will ship UPS and FedEx	AM86616717	7' Right Hand	\$ 204.00	
		AM86616716	7' Left Hand	\$ 204.00	
		AM86616715	8' Right Hand	\$ 271.00	
		AM86616714	8' Left Hand	\$ 271.00	
	Sickle Assembly w/ Head, Coarse 10 Teeth per Inch, Top Serrated, Self-Sharpening Serrations	AM86616713	9' Right Hand	\$ 233.00	
		AM86616712	9' Left Hand	\$ 233.00	
	Features bolt-on, coarse sections Ships Truck Freight Only				
Swather: 1475, Swather Platforms: 300HW, 320, 2200, 2300HS, 2450, 2550	Sickle Assembly w/ Head, Coarse Plated, 10 Teeth per Inch, Top Serrated, Self-Sharpening Serrations	AM86616727	6' Right Hand	\$ 195.00	
		AM86616726	6' Left Hand	\$ 195.00	
	Features bolt-on, coarse sections Will ship UPS and FedEx	AM86616725	7' Right Hand	\$ 225.00	
		AM86616724	7' Left Hand	\$ 225.00	
		AM86616723	8' Right Hand	\$ 242.00	
		AM86616722	8' Left Hand	\$ 242.00	
	Sickle Assembly w/ Head, Coarse Plated, 10 Teeth per Inch, Top Serrated, Self-Sharpening Serrations	AM86616721	9' Right Hand	\$ 260.00	
		AM86616720	9' Left Hand	\$ 260.00	
	Features bolt-on, coarse sections Ships Truck Freight Only				
Swather: 1475, Swather Platforms: 300HW, 320, 2200, 2300HS, 2450, 2550	Sickle Assembly w/ Head, Coarse Under Serrated	AM86528152	6' Right Hand	\$ 187.00	
		AM86528151	6' Left Hand	\$ 180.00	
	Features bolt-on, coarse sections Will ship UPS and FedEx	AM86528150	7' Right Hand	\$ 205.00	
		AM86528149	7' Left Hand	\$ 205.00	
		AM86528148	8' Right Hand	\$ 220.00	
		AM86528147	8' Left Hand	\$ 220.00	

Swather Parts for New Holland®

Swather Parts

Swather Parts

Application	Description	Part Number		Retail Price
Swather: 1475, Swather Platforms: 300HW, 320, 2200, 2300HS, 2450, 2550	Sickle Assembly w/ Head, Fine	AM86616062	6' Right Hand	\$ 185.00
	14 Teeth per Inch, Top Serrated,	AM86616061	6' Left Hand	\$ 185.00
	Self-Sharpening Serrations	AM86616060	7' Right Hand	\$ 243.00
	Features bolt-on, fine sections	AM86616059	7' Left Hand	\$ 204.00
	Will ship UPS and FedEx			
	Sickle Assembly w/ Head, Fine	AM86616058	8' Right Hand	\$ 220.00
	14 Teeth per Inch, Top Serrated,	AM86616057	8' Left Hand	\$ 220.00
	Self-Sharpening Serrations	AM86616056	9' Right Hand	\$ 245.00
	Features bolt-on, fine sections	AM86616055	9' Left Hand	\$ 240.00
	Ships Truck Freight Only			
Swather: 1475, Swather Platforms: 300HW, 320, 2200, 2300HS, 2450, 2550	Sickle Assembly w/ Head, Fine	AM86616537	6' Right Hand	\$ 195.00
	Plated, 14 Teeth per Inch, Top Serrated,	AM86616536	6' Left Hand	\$ 195.00
	Self-Sharpening Serrations	AM86616535	7' Right Hand	\$ 225.00
	Features bolt-on, fine sections	AM86616534	7' Left Hand	\$ 225.00
	Will ship UPS and FedEx	AM86616533	8' Right Hand	\$ 242.00
		AM86616532	8' Left Hand	\$ 242.00
	Sickle Assembly w/ Head, Fine	AM86616531	9' Right Hand	\$ 260.00
	Plated, 14 Teeth per Inch, Top Serrated,	AM86616530	9' Left Hand	\$ 260.00
Self-Sharpening Serrations				
Features bolt-on, fine sections				
Ships Truck Freight Only				
Swather Platform: 460	Sickle Assembly w/ Head, Big Tooth	AM127609	9'	\$ 265.00
	10 Teeth per Inch, Top Serrated, Self			
	Sharpening Serrations, 35 Common			
	Sections, plus Double End			
	Includes Splice Kit			
	Features bolt-together, bolt-on sections			
	Will ship UPS and FedEx			
Swather Platform: 461	Sickle Assembly w/ Head, Under	AM134186	9'	\$ 265.00
	Serrated			
	35 Common Sections, plus Double End			
	Includes Splice Kit			
	Features bolt-together, bolt-on sections			
	Will ship UPS and FedEx			
Swather Platform: 467	Sickle Assembly w/ Head, Fine	AM137215	7'	\$ 225.00
	14 Teeth per Inch, Top Serrated,			
	Self Sharpening Serrations			
	Features bolt-on, fine sections			
	Ships Truck Freight Only			
	Sickle Assembly w/ Head,	AM137214	7'	\$ 225.00
	Under Serrated			
	Features bolt-together, bolt-on sections			
	Ships Truck Freight Only			
Swather Platforms: 907, 909, 910, 912	Sickle Assembly w/ Head, Coarse	AM139179	6' Right Hand	\$ 117.00
	Under Serrated	AM139182	6' Left Hand	\$ 117.00
	Features bolt-on, coarse sections	AM139184	7' Right Hand	\$ 169.00
	Will ship UPS and FedEx	AM139185	7' Left Hand	\$ 169.00
		AM139186	8' Right Hand	\$ 180.00
		AM139187	8' Left Hand	\$ 180.00
Swather Platforms: 907, 909, 910, 912	Sickle Assembly w/ Head, Fine	AM9623845	7' Right Hand	\$ 186.00
	Plated, 14 Teeth per Inch, Top Serrated,	AM9623844	7' Left Hand	\$ 186.00
	Self-Sharpening Serrations	AM9623843	8' Right Hand	\$ 196.00
	Features bolt-on, fine sections	AM9623842	8' Left Hand	\$ 196.00
Will ship UPS and FedEx				
Mower Conditioner: 116	Sickle Assembly w/ Head, Fine	AM264984	6' Right Hand	\$ 215.00
	14 Teeth per Inch, Top Serrated,	AM264986	6' Left Hand	\$ 215.00
	Self-Sharpening Serrations	AM9619695	8' Right Hand	\$ 240.00
	Features bolt-on, fine sections	AM9619694	8' Left Hand	\$ 240.00
	Ships Truck Freight Only	AM9619697	7' Right Hand	\$ 225.00
		AM9619696	7' Left Hand	\$ 225.00

Prices Subject to Change without Prior Notice. The use of original equipment manufacturer (OEM) part numbers or trademarks, e.g. Case® and John Deere®, are for reference purposes only and for indicating product use and compatibility. Our company and the listed replacement parts contained herein are not sponsored, approved or manufactured by the OEM. All parts are New unless designated Reman in the description.

Swather Parts

Application	Description	Part Number		Retail Price
Mower Conditioners: 472, 477, 478	Sickle Assembly w/ Head, Fine 14 Teeth per Inch, Top Serrated, Self-Sharpening Serrations Features bolt-on, fine sections Ships Truck Freight Only	AM86616965	7'	\$ 218.00
	Sickle Assembly w/ Head, Under Serrated Features bolt-on sections Ships Truck Freight Only	AM86616963	7'	\$ 218.00
Mower Conditioner: 474	Sickle Assembly w/ Head, Fine 14 Teeth per Inch, Top Serrated, Self-Sharpening Serrations Features bolt-on, fine sections Ships Truck Freight Only	AM9623560	7'	\$ 241.00
	Sickle Assembly w/ Head, Under Serrated Features bolt-on sections Ships Truck Freight Only	AM86616990	7'	\$ 242.00
Mower Conditioners: 489, 492, 1465	Sickle Assembly w/ Head, Fine 14 Teeth per Inch, Top Serrated, Self-Sharpening Serrations Includes Splice Kit Features bolt-together, bolt-on, fine sections Will ship UPS and FedEx	AM86624469	9'	\$ 275.00
	Sickle Assembly w/ Head, Under Serrated Includes Splice Kit Features bolt-together, bolt-on sections Will ship UPS and FedEx	AM86616988	9'	\$ 288.00
Mower Conditioner: 490 BSN 259714	Sickle Assembly w/ Head, Fine 14 Teeth per Inch, Top Serrated, Self-Sharpening Serrations Includes Splice Kit Features bolt-together, bolt-on, fine sections Will ship UPS and FedEx	AM174594	12'	\$ 315.00
	Sickle Assembly w/ Head, Under Serrated Includes Splice Kit Features bolt-together, bolt-on sections Will ship UPS and FedEx	AM174593	12'	\$ 315.00
Mower Conditioner: 490 ASN 259714	Sickle Assembly w/ Head, Under Serrated Includes Splice Kit Features bolt-together, bolt-on sections Will ship UPS and FedEx	AM579171	12'	\$ 310.00

Swather Parts for New Holland®

Swather Parts

Swather Parts

Application	Description	Part Number		Retail Price
Mower Conditioners: 495, 1495	Sickle Assembly w/ Head, Fine 14 Teeth per Inch, Self-Sharpening Serrations	AM9623572	12'	\$ 310.00
	Sickle Assembly w/ Head, Fine Plated, 14 Teeth per Inch, Self-Sharpening Serrations	AM9623572FPL	12'	\$ 310.00
	Sickle Assembly w/ Head, Under Serrated	AM858706	12'	\$ 285.00
	Sickle Assembly w/ Head, Under Serrated Includes Splice Kit Features bolt-together, bolt-on sections Will ship UPS and FedEx	AM856706	12'	\$ 310.00
	Sickle Assembly w/ Head, Big Tooth 10 Teeth per Inch, Self-Sharpening Serrations	AM9623572BT	12'	\$ 280.00
	Sickle Assembly w/ Head, Big Tooth Plated, 10 Teeth per Inch, Self-Sharpening Serrations	AM9623572BTPL	12'	\$ 310.00
Mower Conditioners: 499, 1496, 1499	Sickle Assembly w/ Head, Fine 14 Teeth per Inch, Top Serrated, Self Sharpening Serrations Features bolt-on, fine sections	AM86617127	6' Right Hand	\$ 220.00
		AM86617126	6' Left Hand	\$ 220.00

Cutter Bar Components

Application	Description	Part Number		Retail Price
Durabine™ Swather Platforms: 416, 419, Discbine® Mower Conditioners: 313, 316	Disc Mower Blade, 7° Sold in Multiples of 25, Priced Individually 4.57" Long, 1.97" Wide, 0.127" Thick	AM84343226	Right Hand	\$ 3.61
	Disc Mower Blade, 7° Sold in Multiples of 25, Priced Individually 4.57" Long, 1.97" Wide, 0.127" Thick	AM84343225	Left Hand	\$ 3.61
	Disc Mower Blade, 14° Sold in Multiples of 25, Priced Individually 4.57" Long, 1.97" Wide, 0.127" Thick	AM84255700	Right Hand	\$ 2.35
	Disc Mower Blade, 14° Sold in Multiples of 25, Priced Individually 4.57" Long, 1.97" Wide, 0.127" Thick	AM84255699	Left Hand	\$ 2.35
	Disc Mower Blade, 18° Sold in Multiples of 25, Priced Individually 4.57" Long, 1.97" Wide, 0.127" Thick	AM84271203	Right Hand	\$ 3.61
	Disc Mower Blade, 18° Sold in Multiples of 25, Priced Individually 4.57" Long, 1.97" Wide, 0.127" Thick	AM84271205	Left Hand	\$ 3.61
	Disc Mower Blade, 7° Sold in Multiples of 25, Priced Individually 4.33" Long, 2" Wide, 0.16" Thick	AM9847683	Right Hand	\$ 2.85
	Disc Mower Blade, 7° Sold in Multiples of 25, Priced Individually 4.33" Long, 2" Wide, 0.16" Thick	AM9847684	Left Hand	\$ 2.85
Swather Platforms: 720HD, 720TD, 750HD, 770HD, 820TD, 2353, 2355, 2358, Disc Mowers: 615, 616, 617, H6730, H6740, H6750, H6830, Discbine® Mower Conditioners: 1409, 1410, 1411, 1412, 1431, 1432, 1441, 1442, 2331, 2332, H7220, H7230, H7320, H7330, H7450, H7460, H7550, H7560	Disc Mower Blade, 14° Sold in Multiples of 25, Priced Individually 4.33" Long, 1.57" Wide, 2" Thick	AM86561093	Right Hand	\$ 3.01
	Disc Mower Blade, 14° Sold in Multiples of 25, Priced Individually 4.33" Long, 1.57" Wide, 2" Thick	AM86561092	Left Hand	\$ 3.01

Swather Parts

Guards and Cutter Bar Parts

Application	Description	Part Number	Retail Price
Swathers: 900, 903, 905, 907, 909, (910, 912 ASN 164908), 1090, 1100, 1112, 1114, 1116, 1469 ASN 220946, Swather Platforms: 12HS, 14HS, 16HS, 18HB, 18HS, 21HB, 25HB, 30HB, 36HB, 1116NH (For Bi-Directional Tractors), 2200H, 2300H, Mower Conditioners: 114, 116, 472, 474, 477, 478, 479, 488, 489, 490, 492, 495, 499, 1465, 1495, 1496, 1499 Replaces 219191, 748178, 858778	Knife Guard, Double Pronged w/ Trash Bar Use w/ 3" Cutter Bar Knife	AM86615982	\$ 11.75
Swathers: 900, 903, 905, 907, 910, 912, Platforms: 970, 972, Versatile@: 4812, 4814	Knife Guard Replaces 65327, V94711	AM65327	\$ 11.50
Swathers: 903, 905, 907, 909, 910, 912, 1100, 1112, 1114, 11161469, Swather Platforms: 12HS, 14HS, 16HS, 18HS, 1116NH (For Bi-Directional Tractors), 2200H, 2300H, Mower Conditioners: 114, 116, 472, 474, 488, 489, 492, 495, 499, 1465, 1475, 1495, 1496, 1499	Knife Guard, Double Pronged w/ Trashbar Use w/ 3" Cutter Bar Knife For Drive Head End Replaces 9801347, 86521590, 86553346, 86615983, 87042358, 87042360	AM86615984	\$ 17.00
Swather Platforms: 12HS, 14HS, 16HS, 18HB, 18HS, 21HB, 25HB, 30HB, 36HB, 2200H, 2300H, Mower Conditioners: 1496, 1499	Knife Guard, Double Pronged Special, Center w/ Cross Bar	AM86615983	\$ 13.50
Swather Platforms: 12HS, 14HS, 16HS, 18HB, 18HS, 21HB, 84C, 86C, 2200H, 2300H, Mower Conditioners: 1496, 1499 Replaces 219191, 858778, 86612892	Knife Guard, Double Pronged	AM118344	\$ 11.00
Sickle Bar Mowers: 451, 456, 505, 507	Knife Guard, Double Pronged Replaces 219190DS, H83500R4	AM219190	\$ 11.00
Mower Conditioner: 538	Guard Stub, Single Prong Forged Replaces 257635, H472717R2	AM472717R2	\$ 10.50
Swather: 1475, Swather Platforms: 300HW, 320, 2200, 2300HS, 2450, 2550	Sickle Section, Overlap Kit Includes (2) Top Countersunk Sections, (3) Bottom Countersunk Sections, (1) Overlap End (Tomahawk) Section, (13) 82° Countersunk Bolts and (13) Cone Lock Nuts Replaces 86520727, 86520727DS	AM86616560	\$ 29.00
	Sickle Section, Tomahawk Sold in Multiples of 25, Priced Individually Replaces 86520698, 86520698DS, 89861129	AM86615985	\$ 8.00
	Sickle Section Top Serrated, 3" Wide, 2.0625" Hole Spacing Sold in Multiples of 25, Priced Individually	AM86616588T	\$ 1.25
	Sickle Section End, Left Hand Replaces 634789, 634789DS, 9622714, 9622714DS, 86616942, 86617759DS	AM86617759	\$ 6.50
	Sickle Section End Replaces 148200C1	AM86617760	\$ 7.25
Swathers: 1116, 2450, 2550, Swather Platforms: 12HS, 14HS, 16HS, 18HS, 300HW, 320, 2200, 2200H, 2300H, 2300HS, Mower Conditioners: 116, 472, 488, 495, 499, 1465, 1475, 1495, 1496, 1499	Knife Clip, Low Profile Adjustable Replaces 1307280C3, 71346158, 86630786, H84412	AMX29115	\$ 14.75
Swathers: 1116, 2450, 2550, Swather Platforms: 12HS, 14HS, 16HS, 18HS, 300HW, 320, 2200, 2200H, 2300H, 2300HS, Mower Conditioners: 116, 472, 488, 495, 499, 1465, 1475, 1495, 1496, 1499, Sickle Bar Mowers: 451, 456	Knife Clip, Low Profile Replaces 1307280C3, 71346158, 86630786, H84412	AMX27554	\$ 3.95
Mower Conditioners: 495, 1495	Knife Clip	AM87517382	\$ 11.50
Swathers: 1116, 1118, 2450, 2550, Swather Platforms: 2200H, 2300H, Mower Conditioner: 114	Section Bolt and Nut Kit 7/32" x 5/8" Grade 8 Rib Neck, Package of 50 For Standard Straight Hole Sections Replaces 850716, 700705296	AM86507777	\$ 15.63

Swather Parts for New Holland®

Swather Parts

Swather Parts

Reel Components

Application	Description	Part Number	Retail Price
Swather Platforms: 18HB, 21HB, 25HB, 30HB, 36HB	Reel Tine, Flexible Tear Drop Style Replaces 276306M1, 700708862, 800714195	AM86562205	\$ 2.26
Swather Platforms: 18HB, 21HB, 25HB, 30HB, 36HB	Eccentric Bushing, Pickup Reel - Female Replaces 86518392	AM114951A1	\$ 2.50
Swather Platforms: 18HB, 21HB, 25HB, 30HB, 36HB	Eccentric Bushing, Pickup Reel - Male Replaces 86518393	AM114952A1	\$ 2.50
Swather Platforms: 18HB, 21HB, 25HB, 30HB, 36HB	Reel Bearing Replaces 84469382, 89842300, 9842300	AM1347084C1	\$ 1.95

Draper Belts

Application	Description	Part Number	Retail Price
Swather: 109	Draper Belt Extension 3', 41.50" x 78.00" Single V-Guide Replaces 22921, 276688, 825977C91, 1041703M92	AM825977C92	\$ 167.00
	Draper Belt 18' Left Hand, 41.50" x 96.00" Single V-Guide Replaces 276691, 826053C91, 1041902M92	AMAW20637	\$ 194.00
	Draper Belt 21' Left Hand, 41.50" x 138.00" Single V-Guide Replaces 276690, 825803C91, 1041507M92	AMAW20639	\$ 321.00
Swathers: 900, 901, 905	Draper Belt 14', 40.00" x 133.00" Single V-Guide Replaces 602819, 8067489, FH028423	AM67489	\$ 260.00
	Draper Belt 16', 40.00" x 157.00" Single V-Guide Replaces 602843, FH028217, FH028431	AM67490	\$ 301.00
Swather: 1090	Draper Belt 15' Right or Left Hand, 41.50" x 140.00" Single V-Guide Replaces 275406, 1052764M91	AM1043862M91	\$ 329.00
Mower Conditioner: 1090 25' Double Swath Platform	Draper Belt 21', 22', 25' or 30', 41.50" x 51.00" Single V-Guide	AM1336270C2	\$ 147.00

Belts

Application	Description	Part Number	Retail Price
Disc Mowers: 442, 452, 462, 463	Main Drive Belt Replaces 274223	AM83101672	\$ 65.00
Disc Mowers: 442, 452, 462, 463, 465	Main Drive Belt Set of 4 Replaces 274224	AM83101673	\$ 87.00

Swather Parts for New Holland®

Swather Parts

Swather Parts

Swather Parts for Hesston®

Water Pumps

Application	Description	Part Number	Retail Price	Core
Swathers: 6450, 6600, 6610, 6650	Water Pump w/o Pulley Includes Mounting Gasket	AMU5MW0106	\$ 76.00	

Camshafts

Application	Description	Part Number	Retail Price	Core
Swathers: 8100, 8200	Camshaft Includes Gear, Key and Thrust Plate	AM98425868	\$ 1389.00	



Sickle Assemblies With Heads

Application	Description	Part Number	Retail Price
Swather: 520, Mower Conditioner: 1014	Sickle Assembly w/ Head, Fine 14 Teeth per Inch, Top Serrated, Self-Sharpening Serrations	12' AM700706511	\$ 265.00
	Includes Splice Kit	14' AM700705471	\$ 360.00
	Features bolt-together, bolt-on, fine sections Will ship UPS and FedEx	16' AM700705472	\$ 285.00
Swathers: 6550, 6650, Swather Platforms: 6566, 6665, 6666, Mower Conditioner: 1014	Sickle Assembly w/ Head, Fine Plated, 14 Teeth per Inch, Top Serrated, Self-Sharpening Serrations	10' AM6193619	\$ 255.00
	Includes Splice Kit	12' AM6497101	\$ 370.00
	Features bolt-together, bolt-on, fine sections Will ship UPS and FedEx	14' AM700705842	\$ 268.00
	Swathers: 6550, 6650, Swather Platforms: 6566, 6665, 6666, Mower Conditioner: 1014	Sickle Assembly w/ Head, Fine Plated, 14 Teeth per Inch, Top Serrated, Self-Sharpening Serrations	6' Right Hand AM700705857
Features bolt-on, fine sections	6' Left Hand AM700705850	\$ 225.00	
Ships Truck Freight Only	8' Right Hand AM700709580	\$ 224.00	
	8' Left Hand AM700709579	\$ 255.00	
Swather Platform: 8200	Sickle Assembly w/ Head, Fine 14 Teeth per Inch, Top Serrated, Self-Sharpening Serrations	7' Right Hand AM700709578	\$ 235.00
	Includes Splice Kit	7' Left Hand AM700709577	\$ 235.00
	Features bolt-on, fine sections Ships Truck Freight Only		
Swather Platform: 8200	Sickle Assembly w/ Head, Fine 14 Teeth per Inch, Top Serrated, Self-Sharpening Serrations	14' AM700709623	\$ 280.00
	Includes Splice Kit		
	Features bolt-together, bolt-on, fine sections Will ship UPS and FedEx		
Swather Platform: 8200	Sickle Assembly w/ Head, FinePlated, 14 Teeth per Inch, Top Serrated, Self-Sharpening Serrations	9' AM700118673	\$ 278.00
	Includes Splice Kit	12' AM700709622	\$ 302.00
	Features bolt-together, bolt-on, fine sections Will ship UPS and FedEx		
Swather Platforms: 8400, Mower Conditioners: 1170, 1270, 1275	Sickle Assembly w/ Head, Fine Plated, 14 Teeth per Inch, Top Serrated, Self-Sharpening Serrations	7' Right Hand AM700715166	\$ 290.00
	Features bolt-on, fine sections	7' Left Hand AM700715165	\$ 290.00
	Ships Truck Freight Only	8' Right Hand AM700715168	\$ 305.00
		8' Left Hand AM700715167	\$ 305.00
		9' Right Hand AM700715779	\$ 325.00
		9' Left Hand AM700715778	\$ 325.00

Swather Parts for Hesston®

Swather Parts

Swather Parts

Application	Description	Part Number	Retail Price
Mower Conditioners: PT7, PT10	Sickle Assembly w/ Head, Fine Plated, 14 Teeth per Inch, Top Serrated, Self-Sharpening Serrations Includes Splice Kit Features bolt-together, bolt-on, fine sections Will ship UPS and FedEx	9' AM700705837	\$ 325.00
	Sickle Assembly w/ Head, Fine, 14 Teeth per Inch, Top Serrated Will ship UPS and FedEx	7' AM700705836	\$ 200.00
Mower Conditioner: PT12	Sickle Assembly w/ Head, Fine Plated, 14 Teeth per Inch, Top Serrated, Self-Sharpening Serrations	12' AM700000759	\$ 265.00

Guards

Application	Description	Part Number	Retail Price
Swathers: 310, 420, 500, 600, 620, 1200PT, 6200, 6400, 6450, 6600, 6610, 8100, 8200, 8400, Swather Platforms: 6465, 6566, 6665, 6666, 8050, 8100, 8200, 8400, Mower Conditioners: 1010, 1014, 1070, 1071, 1085, 1090, 1091, 1095, 1110, 1120, 1150, 1160	Knife Guard Replaces 700700845, 748178	AM65327	\$ 11.50
Swather Platforms: 8000, 8010, 8020, 8100 w/ Range Guard, 8200, 8400, Mower Conditioners: (1110 ASN 070826, 1120 ASN 092480, 1130, 1150, 1260, 1265 - w/ Range Guard), 1170, 1270, 1275, PT12, PT14, PT16	Knife Guard, Double Pronged w/ Trash Bar Use w/ 3" Cutter Bar Knife	AM86615982	\$ 11.75
Swathers: 6200, 6450, 6600, 6610, 8200, Swather Platforms: 6465, 6566, 6665, 6666, 8010, 8200, Mower Conditioners: 1010, 1014, 1014+2, 1085, 1095, 1110, 1120, 1130, 1150, 1160, 1260, 1265, 1270, 1275, PT7, PT10	Hold Down Clip, Adjustable w/ Set Screws	AM700106782	\$ 13.00
	Hold Down Clip	AM700702736	\$ 12.00

Draper Belts

Application	Description	Part Number	Retail Price
Swathers: 420G 1970 and Later, 520G	Draper Belt 14' Left Hand, 44.00" x 115.00" Single V-Guide	AM728378	\$ 287.00
Swathers: 420G, 520G	Draper Belt 20' Left Hand, 44.00" x 187.00" Single V-Guide	AM728402	\$ 439.00
Swathers: 420G, 520G, 620 - w/ Shifting Platforms and Double Swath Attachments	Draper Belt 18' Right or Left Hand, 44.00" x 192.00" Single V-Guide	AM728105	\$ 474.00
Swathers: 420G, 520G, 520, 620, 6200, 6400	Draper Belt 20' Right Hand 44.00" x 205.00" Single V-Guide	AM728410	\$ 510.00
Swathers: 420G, 520G, 6200, 6400	Draper Belt 16' Left Hand, 44.00" x 139.00" Single V-Guide	AM728394	\$ 328.00
Swather: 1200 BSN 1200-40454	Draper Belt 21' Left Hand, Short Bar, 42.00" x 141.81" Single V-Guide	AM700710161	\$ 339.00
Swather: 1200	Draper Belt 21' or 25' Right Hand, Short Bar, 42.00" x 276.50" Single V-Guide	AM700710162	\$ 638.00
Swather: 1200 Prior to 1993	Draper Belt 30' Right Hand, 42.00" x 369.68" Single V-Guide	AM700710166	\$ 844.00

Swather Parts for Hesston®

Swather Parts

Swather Parts

Application	Description	Part Number	Retail Price
Swather: 1200 ASN 1200-00136	Draper Belt 30' Left Hand, Long Bar, 42.00" x 244.00" Single V-Guide	AM700712958	\$ 558.00
Swather: 1200 SN 1200-00135 - 1200-00136	Draper Belt 35' Right Hand, Short Bar, 42.00" x 434.00" Single V-Guide	AM700710966	\$ 844.00
Swather: 1200	Draper Belt 35' Left Hand, Short Bar, 42.00" x 295.75" Single V-Guide	AM700710965	\$ 682.00
Swather: 1200 ASN 1200-00154	Draper Belt 35' Right Hand, Long Bar, 42.00" x 433.80" Single V-Guide	AM700712961	\$ 981.00
	Draper Belt 35' Left Hand, Long Bar, 42.00" x 293.00" Single V-Guide	AM700712960	\$ 669.00
Swather: 1200PT BSN 1200-50237	Draper Belt 25' Left Hand, Short Bar, 42.00" x 237.81 Single V-Guide	AM700710163	\$ 549.00
Swather: 1200PT BSN 1200-00253	Draper Belt 30' Right Hand, Short Bar, 42.00" x 244.81" Single V-Guide	AM700710165	\$ 564.00
Swathers: 6400, 6405, 6450	Draper Belt 21' Left Hand, 42.00" x 202.00" Single V-Guide	AM1700103	\$ 468.00
Swathers: 6550, 6555, 6650, 6655 - Prior to 1974 w/ Shifting Platforms and Double Swath Attachments	Draper Belt 18', 44.00" x 189.00" Single V-Guide	AM828343	\$ 466.00
Swathers: 6600, 6610, 8400 - Prior to 1974 w/ Shifting Platforms and Double Swath Attachments	Draper Belt 18', 44.00" x 203.00" Single V-Guide Replaces 700709104	AM828038	\$ 483.00
Swathers: 6600, 6610 - w/ Double Swath Attachment	Draper Belt 44.00" x 215.00" Single V-Guide	AMSWA44X215	\$ 496.00
Swather: 8100	Draper Belt 21' 42.00" x 199.00" Single V-Guide	AM700712985	\$ 463.00
	Draper Belt 25' or 30', 42.00" x 39.00" Single V-Guide	AM700712990	\$ 149.00
Swather: 8100 - Prior to 1993	Draper Belt 21' Right or Left Hand, 42.00" x 201.25" Single V-Guide	AM700708481	\$ 464.00
	Draper Belt 25' Left Hand, 42.00" x 247.25" Single V-Guide	AM7007007748	\$ 570.00
	Draper Belt 25' Center Belt, 42.00" x 207.25" Single V-Guide	AMSWA42X207.25	\$ 478.00
	Draper Belt 30' Right Hand, 42.00" x 261.25" Single V-Guide	AM700706857	\$ 602.00
	Draper Belt 30' Left Hand, 42.00" x 301.25" Single V-Guide	AM700706951	\$ 694.00
Swather: 8100 ASN 810H-00442	Draper Belt 30' Right Hand, 42.00" x 261.00" Single V-Guide	AM700712989	\$ 594.00
	Draper Belt 30' Left Hand, 42.00" x 301.00" Single V-Guide	AM700712988	\$ 679.00

Swather Parts for Hesston®

Swather Parts

Swather Parts

Swather Parts for Hesston®

Application	Description	Part Number	Retail Price
8100 SN 810H-50311 - 810H-50711	Draper Belt 25' Right Hand, 42.00" x 206.88" Recessed Cleat	AM700710182	\$ 402.00
Swathers: (8100 SN 810H-50311 - 810H-50711 w/ 25' Platform or ASN 810H-00311 - 810H-00442 w/ 30' Platform)	Draper Belt 25' or 30', 42.00" x 38.86" Mini Draper for Shiftable Platform Single V-Guide Belt	AM700711197	\$ 167.00
Swather: 8100 ASN 810H-50711	Draper Belt 25' Right Hand, 42.00" x 207.00" Single V-Guide	AM700712987	\$ 478.00
	Draper Belt 25' Left Hand, 42.00" x 247.00" Single V-Guide	AM700712986	\$ 559.00
Swather: 8400	Draper Belt 21' Right or Left Hand, 42.00" x 200.00" Single V-Guide	AM700710180	\$ 466.00
Swathers: Most Models Prior to 1974	Draper Belt 21' Right or Left Hand, 42.00" x 201.25" Single V-Guide	AM700708471	\$ 819.00

Swather Parts for International®

Guards and Cutter Bar Parts

Application	Description	Part Number	Retail Price
Swathers: 201, 210, 225, 230, 275, 375, 4000, 5000, 5500, Sickle Bar Mowers: 100, 110, 115, 120	Knife Guard, Double Pronged w/ Trashbar Use w/ 3" Cutter Bar Knife Replaces 613838R2, 613838R3	AM613838R1	\$ 11.00
Swathers: 210, 230, Sickle Bar Mowers: 100, 110, 115, 120, 200, 230, 1000, 1100, 1200, 1300, 3110	Knife Guard, Single Prong End Use w/ 3" Cutter Bar Knife For 15', 20', 25' and 30' Platforms	AM1338269C1	\$ 10.95

Draper Belts

Application	Description	Part Number	Retail Price
Swather: 20 1963 and Later	Draper Belt Cross Conveyor, 41.50" x 242.00" Single V-Guide	AM597115R91	\$ 592.00
	Draper Belt Extension 41.50" x 39.25", Short Extension Single V-Guide	AM597116R91	\$ 138.00
Swather: 20 1963 and Later w/ Rear Delivery	Draper Belt 41.50" x 125.00" Single V-Guide	AM597114R91	\$ 302.00
Swather: 75	Draper Belt Extension 3', 41.50" x 78.00" Single V-Guide Replaces 22921, 276688, 825977C91, 1041703M92	AM825977C92	\$ 167.00
	Draper Belt 18' Left Hand, 41.50" x 96.00" Single V-Guide Replaces 276691, 826053C91, 1041902M92	AMAW20637	\$ 194.00
	Draper Belt 21' Left Hand, 41.50" x 138.00" Single V-Guide Replaces 276690, 825803C91, 1041507M92	AMAW20639	\$ 321.00

Swather Parts

Swather Parts for International®

Swather Parts

Application	Description	Part Number	Retail Price
Swather: 163	Draper Belt 12', 41.50" x 110.00" Single V-Guide	AM613584R92	\$ 272.00
	Draper Belt 12' Right or Left Hand, 41.50" x 90.00" Single V-Guide	AM613583R92	\$ 234.00
	Draper Belt 14', 41.50" x 135.00" Single V-Guide	AM613585R92	\$ 311.00
	Draper Belt 16', 41.50" x 158.00" Single V-Guide	AM613586R92	\$ 366.00
Swathers: 165, 201, 230	Draper Belt 12' or 12.50' Right or Left Hand, 41.50" x 104.00" Single V-Guide Replaces 597122R92, 597122R93, 597122R94	AM597122R95	\$ 252.00
Swathers: 175, 210	Draper Belt 13.50' Right or Left Hand, 41.50" x 115.00" Single V-Guide Replaces 597123R92, 597123R93, 597123R94	AM597123R95	\$ 277.00
Swathers: 175, 210 - w/ Narrow Platform	Draper Belt 13.50' Right or Left Hand, 40.00" x 115.00" Single V-Guide	AM597127R94	\$ 288.00
Swather: 200	Draper Belt 12', 41.50" x 193.00" Single V-Guide	AM597112R92	\$ 298.00
Swathers: (201, 210 - 14' Platform), 230 (14.50' Platform)	Draper Belt Right or Left Hand, 40.00" x 128.00" Single V-Guide	AM597128R98	\$ 304.00
Swathers: 201 (10' and 10.50' Platform, Narrow Apron), 210 (10.50' Platform), 230 (10.50' Platform)	Draper Belt Right or Left Hand, 40.00" x 80.00" Single V-Guide Replaces 597125R92, 597125R93, 597125R94	AM597125R95	\$ 200.00
Swathers: 201 (1964-66 Right or Left Hand 16' Platform and 1961-66 16.50' Platform), 210 (Right or Left Hand 10' Platform), 230 (Right or Left Hand 16.50' Platforms), 4000 (16.50' Platform), 5000 (Left Hand 19.50' Platform) Will also fit Right Hand 14.50' Platform or Left Hand 19.50' Draper Platforms with Wide Apron	Draper Belt 41.50" x 152.00" Single V-Guide Replaces 597119R93, 597119R94, 597119R95	AM597119R96	\$ 335.00
Swathers: 201 (12' Platform), 230 (12.50' Platform)	Draper Belt Right or Left Hand, 40.00" x 104.00" Single V-Guide Replaces 597126R92, 597126R93, 597126R94	AM597126R95	\$ 252.00
Swathers: 4000, 5000	Draper Belt 19.50' Right Hand, 41.50" x 224.00" Single V-Guide Replaces 829322C91	AM831358C91	\$ 511.00
	Draper Belt 24.50' BSN 3101 Left Hand, 41.50" x 206.00" Single V-Guide	AM831357C91	\$ 487.00
	Draper Belt 24.50' Right Hand, 41.50" x 278.00" Single V-Guide	AM831359C91	\$ 642.00
Mower Conditioner: 161	Draper Belt 10' Right or Left Hand, 41.50" x 113.00" Single V-Guide	AM618443R93	\$ 275.00
Mower Conditioner: 200	Draper Belt 16', 41.50" x 291.00" Single V-Guide	AM597113R92	\$ 564.00

Swather Parts for International®

Swather Parts

Swather Parts

Swather Parts for John Deere®

Radiator Hoses and Thermostats

Application	Description	Part Number	Retail Price
Swather: 3830	Bypass Hose	AMR70737	\$ 11.09
Swather: 2360, 2420, 3430, 3830	Thermostat, 180° Replaces AT22961	AMRE33705	\$ 5.96
Swather: W155	Thermostat Replaces RE538806	AMRE538289	\$ 15.50

Connecting Rods

Application	Description	Part Number	Retail Price
Swathers: 4890, 4895, 4990	Connecting Rod 1.375" Pin Diameter Replaces RE60272	AMRE500002	\$ 90.00

Crankshafts

Application	Description	Part Number	Retail Price
Swather Platform: 300A Replaces RE46896, RE47637, T23516, T23516T, T20031T	Crankshaft 3-152, 3-164, 3-179, 3029, 3029D Diesel Engines 4.328" Stroke, (152) 3.8581" - 3.8595", (164) 3.875", (179) 4.192", (179T) 4.190" Bore, 2.748" - 2.749" Rod, 3.123" - 3.124" Main Flange - 4 Bolt Holes, 1 Dowel Snout - 1 Bolt Hole, 1 Keyway, w/ Gear	AMAT18031	\$ 660.00
Swathers: 2270, 2280, 2320, 2360, 2420, 3430, 3830 Replaces R23517, R81959, R94644, RE33197, RE48748, RE57664, T23480, T23517, T28743	Crankshaft (202, 219, 239 BSN 769619), 4039D, 4039T - 4 Cylinder Engines 4.330" Stroke, (202) 3.8579" - 3.859", (219) 4.020", (239) 4.192" - 4.194 Bore, 2.748" - 2.7488" Rod, 3.1235" - 3.1245" Main Flange - No Centering Ring, Flat, 4 Bolt Holes, 1 Dowel Snout - Straight, No Splines, 1 Bolt Hole, 1 Keyway	AMAT18030	\$ 535.00
Swather: 4940 Replaces DZ100385, RE533517, RE565972	Crankshaft 6090 PowerTech™ Engine	AMRE548603	\$ 2700.00

Camshafts and Lifters

Application	Description	Part Number	Retail Price
Swathers: 4890, 4895, 4990, 4995	Lifter 4.5, 6.8 PowerTech™ Engine	AMR123565	\$ 7.19
Swathers: 4890, 4895	Camshaft	AMRE56375	\$ 255.00

Balancer Shafts

Application	Description	Part Number	Retail Price
Swathers: (2360, 3430 ASN 716485)	Balancer Shaft Replaces AR61351, R54054, RE26282	Right Hand AMRE56349	\$ 85.47
	Balancer Shaft Replaces AR61352, RE26283	Left Hand AMRE56350	\$ 130.00

Swather Parts

Application	Description	Part Number	Retail Price
Swather: 3830	Balancer Shaft Weighted Style Cast # - R54634	Right Hand AMAR69710	\$ 90.00
	Balancer Shaft Weighted Style Cast # - R54634	Left Hand AMAR69711	\$ 90.00
Swathers: 4890, 4895	Balancer Shaft Replaces RE69364	Right Hand AMRE500448	\$ 120.00

Cylinder Heads, Bare

Application	Description	Part Number	Retail Price
Swathers: 2270, 2280, 2360, 2420, 3430	Valve Train Kit Includes (4) Exhaust Valves, 5.155" Long, 45°, (4) Intake Valves, 5.155" Long, 45°, (8) Valve Springs, (16) Valve Keepers Replaces R26125, R79623, R79624	AMVK1043	\$ 74.00

Water Pumps and Components

Application	Description	Part Number	Retail Price
Swathers: 2280, 2320, 2420 - w/ 300 Series Diesel Engine	Reman Water Pump Cast # - R51039 Replaces RE19949	AMR51039	\$ 120.00
Swathers: 2280, 2420	Water Pump Cast # - R55758	AMRE19944	\$ 126.00
Swathers: 4990, A400, D450, R450 - w/ 3029, 4036, 4045 or 6068 Engine	Water Pump Pulley 94 mm Diameter	AMR115250	\$ 41.67
Swathers: 2250, 2270, 2320, 2360, 3430, 3830	Water Pump Shaft Bearing 5.75" Long, 2.125" Wide, 1.50" OD, 0.746" Shaft Size	AMJD9257	\$ 18.40
Swathers: 4890, 4990, 4995, A400, D450, R450	Fan Pulley	AMR128660	\$ 84.94

Sensors

Application	Description	Part Number	Retail Price
Swathers: 4890, 4895, 4990, 4995, A400, D450, R450	Engine Speed Sensor	AMRE519144	\$ 20.00
Swather: R450	Neutral Start Switch	AMAH161154	\$ 31.00
Swathers: W235, W260	Wiring Harness, Propulsion Control	AMAL203916	\$ 80.00
Swathers: A400, D450, R450	Air Temperature Sensor Replaces 72102514	AMRE525016	\$ 19.25

Sickle Knife Heads

Application	Description	Part Number	Retail Price
Swather Platforms: 890, 895, 896	Sickle Knife Head	AMAE54468	\$ 109.79

Swather Parts



Sickle Assemblies With Heads

Application	Description		Part Number	Retail Price
Swather Platforms: 130, 135, 230, 240, Mower Conditioners: 1209 Late, 1424	Sickle Assembly w/ Head, Fine 14 Teeth per Inch	9'	AMAE48664	\$ 253.00
		12'	AMAE48652	\$ 302.00
		14'	AMAE48654	\$ 390.00
		16'	AMAE48657	\$ 369.00
		18'	AMAE48599	\$ 426.00
		21'	AMAE48598	\$ 476.00
		25'	AMAE39178	\$ 578.00
	Sickle Assembly w/ Head, Under Serrated	9'	AMAE48662	\$ 253.00
		12'	AMAE48651	\$ 302.00
		14'	AMAE48655	\$ 335.00
Swather Platforms: 300, 300A, Mower Conditioners: 1525, 1600	Sickle Assembly w/ Head, Fine 14 Teeth per Inch	6' Right Hand	AMAE48597	\$ 288.00
		6' Left Hand	AMAE48665	\$ 300.00
		7' Right Hand	AMAE48135	\$ 244.00
		7' Left Hand	AMAE48131	\$ 262.00
		8' Right Hand	AMAE48134	\$ 260.00
		8' Left Hand	AMAE48130	\$ 277.00
Swather Platforms: 890, 895, 896	Sickle Assembly w/ Head, Fine 14 Teeth per Inch	7' Right Hand	AMAE55770	\$ 248.00
		7' Left Hand	AMAE55769	\$ 248.00
	Sickle Assembly w/ Head, Fine 14 Teeth per Inch Ships Truck Freight Only	8' Right Hand	AMAE55772	\$ 282.00
		8' Left Hand	AMAE55771	\$ 282.00
		9' Right Hand	AMAE56460	\$ 233.00
Mower Conditioner: 1209 ASN 285001	Sickle Assembly w/ Head Plated, Under Serrated	9' Left Hand	AMAE56459	\$ 262.00
		7'	AMAE48661	\$ 180.00
	Sickle Assembly w/ Head, Fine Plated, 14 Teeth per Inch	9'	AMAE48663	\$ 225.00

Skid Shoes

Application	Description	Part Number	Retail Price
Swather Platforms: 415D, 420D, 425D, 430D, 435D, 440D, 1415D, 1420D, 1425D, 1430D, 1435D, 1440D, 1445D	Skid Shoe, Right Hand	AMFH318495	\$ 78.93
	Skid Shoe, Left Hand	AMFH318494	\$ 78.93
Swather Platforms: 500R, 990, 994, 995, Disc Mower Conditioners: 946, 956, C450, C500	Skid Shoe	AMAE56948	\$ 138.08

Cutter Bar Components

Application	Description	Part Number	Retail Price
Swather Platforms: 500R, 990, 994, 995, Disc Mower Conditioners: 525, 530, 535, 625, 630, 635, 730, 735, 830, 835, 910, 915, 916, 920, 925, 926, 930, 935, 936, 945, 946, 955, 956, C400, C450	Accelerator, CW	AME98137	\$ 16.28
	Accelerator, CCW	AME98138	\$ 16.28
Swather Platforms: 500R, 990, 994, 995, Disc Mower Conditioners: 525, 530, 535, 625, 630, 635, 730, 735, 830, 835, 910, 915, 916, 920, 925, 926, 930, 935, 936, 945, 946, 955, 956, C300, C400, C450, S250, S300, S350	Disc, Turtle-Back	AMAE70632	\$ 80.88

Swather Parts

Swather Parts for John Deere®

Application	Description	Part Number		Retail Price
Swather Platforms: 500R, 990, 994, 995, Disc Mower Conditioners: 525, 530, 535, 625, 630, 635, 730, 735, 830, 835, 910, 915, 916, 920, 925, 926, 930, 935, 936, 946, 955, 956, C300, C400, C450, C500, S250, S300, S350	Input Driver Kit 7 Spline Includes Cap Screw	AMAE71035		\$ 67.34
Swather Platforms: 500R, 990, 994, Disc Mower Conditioners: 525, 530, 535, 625, 630, 635, 730, 735, 830, 835, 910, 915, 916, 920, 925, 926, 930, 935, 936, 945, 946, 955, 956	Disc Shear Hub Driver Kit 6 Spline Includes Cap Screw Replaces AE49067, AE53192, AE57547	AMAE71036		\$ 67.70
Swather Platforms: 500R, 990, 994, 995, Disc Mowers: 265, 275, 285, Disc Mower Conditioners: 190, 525, 530, 535, 625, 630, 635, 730, 735, 830, 835, 910, 915, 916, 920, 925, 926, 930, 935, 936, 945, 946, 955, 956, 1350, 1360, 1460, 1470, C300, C350, C400, C450, C500, S250, S300, S350	Disc Mower Blade, 11° Sold in Multiples of 25, Priced Individually 4.21" Long, 1.85" Wide, 0.157" Thick Replaces FH323282	AME80208	Right Hand	\$ 2.25
	Disc Mower Blade, 11° Sold in Multiples of 25, Priced Individually 4.21" Long, 1.85" Wide, 0.157" Thick Replaces FH323281	AME80206	Left Hand	\$ 2.25
Swather Platforms: 500R, 994, 995, Disc Mower Conditioners: 525, 530, 535, 625, 630, 635, 730, 735, 915, 916, 925, 926, 935, 936, 945, 946, 955, 956	Disc Mower Blade, 18° Sold in Multiples of 25, Priced Individually 4.21" Long, 1.85" Wide, 0.157" Thick	AMFH308235	Right Hand	\$ 2.55
	Disc Mower Blade, 18° Sold in Multiples of 25, Priced Individually 4.21" Long, 1.85" Wide, 0.157" Thick	AMFH308234	Left Hand	\$ 2.55
Mower Conditioners: 525, 530, 535, 625, 630, 635, Disc Mower Conditioners: 730, 735, 830, 835	Pin 3.354" Long, 0.315" Thick, 1" Diameter, 2.756" Hole Diameter	AMAH212002		\$ 28.00
Mower Conditioners: 1600, 1600A, Disc Mower Conditioners: 730, 735, 830, 835, 1350, 1360, 1460, 1470	Ball Bearing 1.50" Hex Bore	AMAE40895		\$ 35.00

Guards and Cutter Bar Parts

Application	Description	Part Number		Retail Price
Swather Platforms: 31, 36, 61, 66, 183, 220, 230, 240, 300, 300A, Mower Conditioners: 710, 720, 820, 1207, 1214, 1219, 1380, 1424, 1600, 1600A	Knife Guard Non-Clog	AME59625		\$ 11.00
Swather Platform: 140, 140A, 160, 160A, 180A, 415D, 420D, 425D, 430D, 435D, 440D, Mower Conditioner: 590	Knife Guard, Double Pronged	AM118344		\$ 11.00
Swather Platforms: 230 ASN 425000, 240, Mower Conditioners: 1207, 1209, 1214, 1217, 1219 BSN 710000, 1380, 1424	Knife Guard Replaces E52667	AME62000		\$ 10.00
Swather Platforms: 300, 300A, 890, 895, 896, Mower Conditioners: 710, 720, 820, (1217, 1219 ASN 710001), 1600, 1600A	Knife Guard	AME88923		\$ 12.00
Swather Platform: 300A, Mower Conditioners: (1217, 1219 ASN 710001), 1600	Knife Guard	AME72428		\$ 9.50
Swather Platforms: 890, 895, 896	Knife Guard	AME88909		\$ 10.00
Swather Platforms: 890, 895, 896	Sickle Section Top Serrated, 3" Wide, 2" Hole Spacing Sold in Multiples of 25, Priced Individually	AME76370		\$ 1.25
Swathers 190, Swather Platforms: 120, 130, 135, 183, 230, 240, Mower Conditioners: 580, 1207, 1209, 1214, 1217, 1219, 1424	Wear Plate	AME47954		\$ 2.00
Swather Platforms: 130, 135, 230, 240, 300, 300A, 890, 895, 896, Mower Conditioners: 710, 720, 820, 1202, 1424, 1600, 1600A	Hold Down Clip Sold in Multiples of 25, Priced Individually Replaces AE57172, E81963	AME73780		\$ 9.68
Swather Platforms: 140A, 160A, 180A, 415D, 420D, 425D, 430D, 435D, 440D Replaces AFH209191	Hold Down Clip Hi-Arch Includes Nut and Bolt	AM118499		\$ 6.85
Swather Platforms: 230, 240, 300, 300A, 710, 720, 820, 890, 895, 896, Mower Conditioners: 1424, 1600, 1600A	Hold Down Clip Non-Clog	AMAE57173		\$ 12.00

Swather Parts

Swather Parts

Application	Description	Part Number	Retail Price
Swather Platforms: 890, 895, 896	Hold Down Clip, Adjustable	AME127429	\$ 15.00

Sickle Drives and Components

Application	Description	Part Number	Retail Price
Swather Platforms: 220, 230, 240, 300, 300A, Mower Conditioners: 1207, 1209, 1214, 1219, 1380, 1424	Wobble Box 2-Bolt and 2-Dowel Pin Mounting Replaces E59258	AMAE34800	\$ 1195.00
Swather Platform: 300A, Mower Conditioners: 710, 720, 820, 1600, 1600A	Wobble Box Assembly 4-Bolt Mounting	AMAE41481	\$ 895.00
Swather Platforms: 220, 230, 240, Mower Conditioners: 1207, 1209, 1214, 1217, 1219, 1380, 1424	Wobble Box Housing Cast # - E59258 Replaces AE30609	AMAE35149	\$ 515.00
Swather: 890, Swather Platform: 300A, Mower Conditioners: 710, 720, 820, 1600, 1600A	Wobble Box Housing	AMAE35151	\$ 219.00
Mower Conditioners: 1207, 1209, 1214, 1217, 1219, 1380, 1424, 1600, 1600A	Wobble Box Housing Cover	AMAE38566	\$ 78.00
Swather Platform: 300A, Mower Conditioners: 710, 720, 820, 1600, 1600A	Wobble Box Fork w/ Bushings	AMAE38050	\$ 230.00
	Wobble Box Housing	AMAE46307	\$ 150.00
Swather Platform: 300A, Mower Conditioners: 1600, 1600A, Sickle Mower Conditioners: 710, 720, 820	Wobble Box Yoke Shaft	AME60129	\$ 215.00
Swather Platform: 300A, Mower Conditioners: 710, 720, 820, 1600, 1600A	Wobble Box Shaft Nut	AME59303	\$ 16.50
Swather Platform: 300A	Needle Bearing, Wobble Box Housing 0.875" ID, 1.188" OD, 1" Wide Outer Race	AMJD9977	\$ 9.23
Swather Platforms: 120, 130, 135, 183, 220, 230, 240, 300, 300A, 890, Mower Conditioners: 710, 720, 820, 1207, 1209, 1214, 1217, 1219, 1380, 1424, 1600, 1600A	Wobble Box Repair Kit	AMAE57735	\$ 647.00
Mower Conditioners: 710, 720, 820, 1600, 1600A	Pin Fastener Use w/ AMAE46307 Wobble Box Housing (2) Required	AME56839	\$ 17.00
Swather Platforms: 120, 183, 220, Mower Conditioners: (1207, 1209 BSN 285000), 1214	Knife Drive Arm 12 Spline	AME52444	\$ 120.12
Swather Platforms: 130, 135, 160, 240, 300, 895, Mower Conditioners: 1207, 1214, 1217, 1219, 1380, 1424	Pressure Relief Valve	AMAE38448	\$ 6.00

Auger Components

Application	Description	Part Number	Retail Price
Swather Platforms: 300, 300A	Bearing, Cross Auger Driveshaft 2.8346" OD, 1.25" Round Bore Replaces AH10515, JD9316	AMG1104KRRB-I	\$ 25.58
Mower Conditioners: 1207, 1217, 1219, 1600, 1600A	Ball Bearing 1.251" ID, 2.835" OD	AMJD9420	\$ 28.09

Platform Components

Application	Description	Part Number	Retail Price
Swather Platforms: 140, 160, 183, 220, 230, 240	Knife Driven Pulley 11.00" OD For Standard Duty Knife Drive Case Replaces E48349	AME78705	\$ 204.85

Swather Parts

Draper Belts

Application	Description	Part Number	Retail Price
Swather: 190	Draper Belt 42.00" x 266.00" Single V-Guide For Long Double Swath	AMAW11645W	\$ 611.00
	Draper Belt Extension 42.00" x 74.00" Single V-Guide For Regular Platform Extension	AMAW11646W	\$ 188.00
	Draper Belt Extension 42.00" x 112.00" Single V-Guide For Long Double Swath Extension	AMAW11647W	\$ 275.00
Swathers: 200, 200A	Draper Belt 10' Right or Left Hand, 42.00" x 82.00" Single V-Guide	AMAH11237H	\$ 226.00
	Draper Belt 16' Right Hand, 42.00" x 179.00" Single V-Guide	AMAH11235H	\$ 413.00
Swathers: 290	Draper Belt 42.00" x 143.00" Single V-Guide	AMAW13867	\$ 340.00
Swather: 780	Draper Belt 9' Right or Left Hand, 40.00" x 73.00" Single V-Guide	AMAE25972	\$ 215.00
	Draper Belt 11' Right or Left Hand, 40.00" x 97.00" Single V-Guide	AMAE23714	\$ 262.00
	Draper Belt 11' Right or Left Hand, 42.00" x 94.00" Single V-Guide	AMAE24257	\$ 260.00
Swathers: 780, 800, 2250, 2270	Draper Belt Extension 12' or 15', 40.00" x 16.00" Narrow Extension Single V-Guide	AMAE32333	\$ 67.00
Swathers: 780, 800, 2250, 2270, 2320, 2420 - w/ 130 Platform	Draper Belt 15' Right or Left Hand, 40.00" x 138.00" Single V-Guide	AMAE34797	\$ 319.00
Swathers: 780, 800, 2250, 2270, 2320, 2420	Draper Belt 25' Right or Left Hand, 42.00" x 258.00" Single V-Guide	AMAE36834	\$ 583.00
	Draper Belt 36' Right Hand or Left Hand, 42.00" x 377.00" Single V-Guide	AMAE33360	\$ 852.00
	Draper Belt Extension 41.50" x 15.00", Regular Platform Extension Single V-Guide Replaces 1069543M91	AMAE36767	\$ 54.00
Swathers: (800, 830 - w/Twin Swath), 880, Swather Platforms: 215, 215A	Draper Belt 12' Right or Left Hand, 42.00" x 110.00" Single V-Guide	AMAH18491H	\$ 267.00
Swathers: 800, 830, 2250, 2270 - w/ Narrow Platform	Draper Belt 12' Right or Left Hand, 42.00" x 110.00" Single V-Guide	AMAE20967	\$ 269.00
	Draper Belt 14' Right or Left Hand, 42.00" x 134.00" Single V-Guide	AMAE20968	\$ 315.00
Swathers: (800, 830, 2250, 2270 - w/ Narrow Platform), Swather Platform: 215A	Draper Belt 10' Right or Left Hand, 40.00" x 86.00" Single V-Guide	AMAE20966	\$ 197.00

Swather Parts for John Deere®

Swather Parts

Swather Parts

Application	Description	Part Number	Retail Price
Swathers: 800, 830, 2250, 2270, Swather Platform: 215A - All w/ Narrow Platform	Draper Belt 16' Right or Left Hand, 42.00" x 157.00" Single V-Guide	AMAE20969	\$ 365.00
Swather: 880, Swather Platforms: 215, 215A	Draper Belt 10' Right or Left Hand, 42.00" x 86.00" Single V-Guide	AMAH18490H	\$ 245.00
Swather: 880, Swather Platforms: 215, 215A	Draper Belt 14' Right or Left Hand, 42.00" x 134.00" Single V-Guide	AMAH18492H	\$ 322.00
	Draper Belt 16' Right or Left Hand, 42.00" x 158.00" Single V-Guide	AMAH18493H	\$ 376.00
Swathers: 2250, 2270, 2420 (1977 and Later)	Draper Belt 30', 42.00" x 310.00" Single V-Guide	AMAE36835	\$ 743.00
Swathers: 2280, 2320 - w/ 130 Twin Swath Platform	Draper Belt 21' Right or Left Hand, 42.00" x 186.00" Single V-Guide	AMAE38140	\$ 428.00
Swathers: (2280, 2320 - w/ 130 Twin Swath Platform), Swather Platforms: 278, 288	Draper Belt 40.00" x 47.00" Single V-Guide Replaces AE38276	AMAE24847	\$ 139.00
Swather: 2360	Draper Belt 15' Right or Left Hand, 41.50" x 140.00" Single V-Guide Replaces 275406, 1052764M91	AM1043862M91	\$ 329.00
Swather: 2360 - w/160 Platform	Draper Belt 21', 22', 25' or 30', 41.50" x 51.00" Single V-Guide	AM1336270C2	\$ 147.00
Swather Platforms: 78, 780, 800, 2250, 2270, 2320, 2420 - 1978 and Later	Draper Belt 18', 42.00" x 174.00"	AMAE23783	\$ 379.00
	Draper Belt 42.00" x 138.00"	AMAE23897	\$ 282.00
Swather Platform: 415D	Draper Belt 15' Right or Left Hand, 41.60" x 104.33" Single V-Guide	AMAFH209067	\$ 294.00
Swather Platform: 425D	Draper Belt 25' Right or Left Hand, 41.60" x 217.24" Single V-Guide	AMAFH209069	\$ 526.00
Swather Platform: 430D	Draper Belt 30' Right or Left Hand, 41.60" x 277.24" Single V-Guide	AMAFH209070	\$ 627.00
Swather Platform: 435D	Draper Belt 35' Right or Left Hand, 41.60" x 337.24" Single V-Guide	AMAFH209071	\$ 742.00
Swather Platform: 440D	Draper Belt 40' Right or Left Hand, 41.60" x 397.24" Single V-Guide	AMAFH209072	\$ 856.00
Mower Conditioner: 580	Draper Belt 18' Left Hand, 41.50" x 96.00" Single V-Guide Replaces 276691, 826053C91, 1041902M92	AMAW20637	\$ 194.00
	Draper Belt 21' Left Hand, 41.50" x 138.00" Single V-Guide Replaces 276690, 825803C91, 1041507M92	AMAW20639	\$ 321.00

Swather Parts for John Deere®

Swather Parts

Swather Parts

Drive Hub Assembly

Application	Description	Part Number	Retail Price
Swathers: 4890, 4990	Hub Assembly 40:1 Gear Ratio, Nut Retainer	AMAE55305	\$ 4500.00

Belts

Application	Description	Part Number	Retail Price
Disc Mower: R200, Rotary Mowers: 240, 260, 270	Main Drive Belt Set of 4 Replaces ES10774	AM83101673	\$ 87.00
Disc Mowers: R240, R270, Rotary Mowers: 265, 275	Main Drive Belt Set of 4 Replaces AE55671	AM83101791	\$ 125.00
Disc Mower: R310, Rotary Mower: 285	Main Drive Belt	AM83101792	\$ 125.00

Swather Parts for Krone®

Cutter Bar Components

Application	Description	Part Number	Retail Price	Core
Disc Mower: 323	Disc Mower Blade 4" Long, 1.89" Wide, 0.157" Thick Sold in Multiples of 25, Priced Individually Replaces 139889	Right Hand AM131118	\$ 3.00	
	Disc Mower Blade 4" Long, 1.89" Wide, 0.157" Thick Sold in Multiples of 25, Priced Individually Replaces 139888	Left Hand AM131117	\$ 3.00	

Swather Parts for Kuhn®

Cutter Bar Components

Application	Description	Part Number	Retail Price	Core
Alterna 400, Alterna 500, GMD28 SN A0001-A1632, GMD283TG, GMD313TG, GMD400, GMD500, GMD600, GMD600GII, GMD700, GMD700GII, GMD702, GMD800, GMD800GII, GMD802, GMD2850TL, GMD3150TL, GMD3550TL, GMD4050TL, FC243, FC250, FC283, FC300, FC302, FC303, FC313, FC350, FC352, FC353, FC883, FC4000	Disc Mower Blade, 11° Sold in Multiples of 25, Priced Individually 4.20" Long, 1.85" Wide, 0.157" Thick	Right Hand AM55903310	\$ 2.50	
	Disc Mower Blade, 11° Sold in Multiples of 25, Priced Individually 4.20" Long, 1.85" Wide, 0.157" Thick	Left Hand AM55903210	\$ 2.50	

Belts

Application	Description	Part Number	Retail Price	Core
Disc Mower Conditioners: FC243TG, FC283TG	Finger Roller Belt Set of 3	AM83101687	\$ 83.00	
Disc Mower Conditioners: FC303GC, FC353	Finger Rotor Drive Belt Set of 2	AM83101656	\$ 75.00	
Disc Mower Conditioners: FC303GC, FC353	Main Drive Belt	AM83111682	\$ 240.00	
Disc Mower Conditioner: FC303GL	Finger Roller Belt Set of 2	AM83101658	\$ 60.00	

Swather Parts

Swather Parts for Kuhn®

Application	Description	Part Number	Retail Price	Core
Disc Mower Conditioners: FC313F, FC313FFF, FC883FF	Rotor Drive Belt Set of 4	AM83101688	\$ 123.00	
Disc Mower Conditioner: FC352G	Finger Rotor Drive Belt Set of 4	AM83101682	\$ 92.00	
Disc Mower Conditioner: FC353	Conditioner Drive Belt Set of 2	AM83101797	\$ 77.00	
Disc Mower Conditioners: FC353GC, FC353RGC	Main Drive Belt 4V Belt	AM83111683	\$ 340.00	
Disc Mower Conditioner: FC813R	Conditioner Drive Belt Set of 3	AM83101681	\$ 69.00	
Disc Mowers: GMD44, GMD400	Main Drive Belt Replaces 274223	AM83101672	\$ 65.00	
Disc Mowers: GMD66, GMD66HD, GMD77, GMD77HD, GMD500	Main Drive Belt Set of 4 Replaces 274224	AM83101673	\$ 87.00	
Disc Mowers: GMD600, GMD600G2, GMD600HD, GMD700, GMD700G2, GMD700HD	Main Drive Belt Set of 4	AM83101791	\$ 125.00	
Disc Mower: GMD800	Main Drive Belt	AM83101792	\$ 125.00	

Swather Parts for MacDon®

Sickle Assemblies With Heads

Application	Description	Part Number	Retail Price
Swather: 7000 w/ Double Drive (Series III)	Sickle Assembly w/ Head, Fine Top Serrated, Self-Sharpening Serrations	8' Right Hand AM33719	\$ 265.00
	Sickle Assembly w/ Head, Fine Top Serrated, Self-Sharpening Serrations	8' Left Hand AM33716	\$ 265.00
	Sickle Assembly w/ Head, Fine Top Serrated, Self-Sharpening Serrations	7' Right Hand AM33718	\$ 250.00
	Sickle Assembly w/ Head, Fine Top Serrated, Self-Sharpening Serrations	7' Left Hand AM33715	\$ 250.00
Swather: 7000 w/ Single Drive (Series III) and Single Auger	Sickle Assembly w/ Head, Fine Top Serrated, Self-Sharpening Serrations	16' AM34394	\$ 440.00
	Sickle Assembly w/ Head, Fine Top Serrated, Self-Sharpening Serrations	14' AM34393	\$ 410.00
	Sickle Assembly w/ Head, Fine Top Serrated, Self-Sharpening Serrations	12' AM34392	\$ 345.00

Sickle Drives and Components

Application	Description	Part Number	Retail Price
Swather Platforms: 721, 722, 921, 942, Mower Conditioners: 5000, 5010, 5020, A30-D, A30-S Replaces 100532	Wobble Box	AM338670A1	\$ 1575.00
Swather Platform: 942 BSN 124499, Mower Conditioners: 4000, 5000 BSN 124499 Replaces 26320	Wobble Box 2-Bolt and 2-Dowel Pin Mounting	AMAE34800	\$ 1195.00
Swather: 9000, Swather Platforms: 721, 722, 921, 942, Mower Conditioners: 5000, 5010, 5020, A30-D, A30-S	Wobble Box Yoke	AM100706	\$ 517.00

Swather Parts

Swather Parts for MacDon®

Swather Parts

Application	Description	Part Number	Retail Price
Mower Conditioners: 5010, 5020, A30-D, A30-S Replaces 47832, 174982	Pulley, Knife Drive Gearbox	AM338585A1	\$ 265.00
Mower Conditioners: 5010, 5020, A30-D, A30-S Replaces 113698	Arm	AM369994A1	\$ 195.00

Guards and Cutter Bar Parts

Application	Description	Part Number	Retail Price
Swathers: 3000, 3020, 7000, 9000, Swather Platforms: 910, 912, 920, 922, 930, 942, 960, 962, 963, 972, 973, 974, A30D, A30S, A40D, D40, D50, D60, D65, FD70, FD75, FD130, FD135, FD140, FD145, Mower Conditioners: 4000, 5000, 5010, 5020 Replaces 23064, 28013	Knife Guard, Double Pronged	AM118344	\$ 11.00
Swather: 9000, Mower Conditioners: 4000, 5010, 5020	Knife Guard First Guard, Left Hand w/ Cross Bar Double Heat Treated (1) Required per Head Replaces 47709129, 87422039	AM118301	\$ 13.00
	Knife Guard Last Guard, Right Hand w/ Cross Bar Double Heat Treated (1) Required per Head Replaces 47709128, 87422040	AM118302	\$ 13.00
	Knife Guard, Double Pronged Drive Head Guard (3) Required per Single Knife, (6) Required per Double Knife	AM118345	\$ 12.00
Swather: 9000 w/ Double Drive, Swather Platforms: 910, 920, 922, 930	Sickle Section Top Serrated, 3" Wide, 2.125" Hole Spacing Sold in Multiples of 25, Priced Individually	AM34390PL	\$ 1.45
	Sickle Section Half, Right Hand	AM34391RH	\$ 3.25
Swather Platforms: 910, 920, 922, 930, 9000 w/ Double Drive	Sickle Section Half, Left Hand	AM34391LH	\$ 3.25

Swather Parts for Massey Ferguson®

Guards

Application	Description	Part Number	Retail Price
Swathers: 200, 210	Knife Guard	AM3725581M1	\$ 11.00
Swather Platforms: 9125, 9145, Mower Conditioners: (1457, 1459 - w/ Range Guard), 1474, 1476 Replaces 700707147, 700716292	Knife Guard, Double Pronged w/ Trash Bar Use w/ 3" Cutter Bar Knife	AM86615982	\$ 11.75
Swather Platforms: 9000, 9005, 9125, 9126, 9146	Hold Down Clip, Adjustable w/ Set Screws	AM700106782	\$ 13.00
	Hold Down Clip	AM700702736	\$ 12.00

Swather Parts

Draper Belts

Application	Description	Part Number	Retail Price
Swather: 35	Draper Belt 18' Left Hand, 41.50" x 96.00" Single V-Guide Replaces 276691, 826053C91, 1041902M92	AMAW20637	\$ 194.00
	Draper Belt 21' Left Hand, 41.50" x 138.00" Single V-Guide Replaces 276690, 825803C91, 1041507M92	AMAW20639	\$ 321.00
Swathers: 35	Draper Belt Extension 3', 41.50" x 78.00" Single V-Guide Replaces 22921, 276688, 825977C91, 1041703M92	AM825977C92	\$ 167.00
Swathers: 655, 775, 785, 885	Draper Belt 15' Right or Left Hand, 41.50" x 140.00" Single V-Guide Replaces 275406, 1052764M91	AM1043862M91	\$ 329.00
Swather: 885	Draper Belt Extension 41.50" x 15.00", Regular Platform Extension Single V-Guide Replaces 1069543M91	AMAE36767	\$ 54.00
Swather: 885 Center Deck Extension For 21', 22', 25' or 30'	Draper Belt 21', 22', 25' or 30', 41.50" x 51.00" Single V-Guide	AM1336270C2	\$ 147.00
Mower Conditioner: 120	Draper Belt 35' Right Hand, Long Bar, 42.00" x 433.80" Single V-Guide	AM700712961	\$ 981.00

Swather Parts for Massey Ferguson®

Swather Parts

Forage Harvester Parts

Table of Contents

Forage Harvester Parts for John Deere®	245
Cutter Head Components	245
Feed Rolls and Components	247

Forage Harvester Parts for John Deere®

Cutter Head Components

Application	Description	Part Number	Price
34	Knife Heat Treated, Tungsten Carbide	AME36831	\$ 105.00
35, 38	Knife Heat Treated, Tungsten Carbide	AME33221	\$ 95.00
3800, (5200, 5400, 5440, 5460 - w/ J-Knife)	Knife Bolt w/ Cam	AMAE32487	\$ 13.00
3940, 3950, 3955	Knife Hi-Performance Heat Treated, Tungsten Carbide Replaces E61962	AMFH310957HP	\$ 18.00
	Knife Heat Treated, Tungsten Carbide (36) Required Replaces E61962	AMFH310957	\$ 13.00
3940, 3950, 3955	Shearbar Kit Tungsten Carbide Includes Wear Strip and Shims	AMAE44465	\$ 240.00
	Shearbar Tungsten Carbide Replaces E72918	AMX93076	\$ 215.00
3940, 3950, 3955	Roll Cleaner Smooth Replaces AE44959	AMAFH205889	\$ 104.00
3940, 3950, 3955, 3960, 3970, 3975, 5200, 5400, 5440, 5460, 5720, 5730, 5820, 5830, 6610, 6650, 6710, 6750, 6810, 6850, 6910, 6950, 7180, 7200, 7250, 7280, 7300, 7350, 7380, 7400, 7480, 7500, 7580, 7700, 7780, 7800, 7980	Shearbar Wear Strip Kit Includes Long Wear Strip and (2) Short Wear Strips Replaces E49449	AME72350	\$ 60.00
3940, 3950, 3960, 3970	Wear Plate, Top Inside Abrasion Resistant (2) Required	AMX93038	\$ 42.00
3940*, 3950*, 3955*, 3960**, 3970**, 3975** *(108) Required **(144) Required	Knife Bolt Grade 8 Replaces E62538	AME83034	\$ 1.50
3960, 3970, 3975	Knife Hi-Performance Heat Treated, Tungsten Carbide Replaces E61961	AMFH310956HP	\$ 18.00
	Knife Heat Treated, Tungsten Carbide (48) Required Replaces E61961	AMFH310956	\$ 13.00
3960, 3970, 3975, (5200, 5400 - 1984 and Later w/ Dura-Drum™), (5440, 5460 - w/ Dura-Drum™), (5720, 5820 ASN 651001), 5730, 5830	Shearbar Kit Tungsten Carbide Includes Wear Strip and Bearings	AMAE44466	\$ 242.00
3960, 3970, 3975, 5200, 5400, 5440, 5460, 5720, 5730, 5820, 5830	Shearbar Tungsten Carbide Replaces AE44466, E72919	AMX93077	\$ 230.00

Forage Harvester Parts for John Deere®

Forage Harvester Parts

Forage Harvester Parts

Application	Description	Part Number	Price
(5200, 5400, 5440, 5460 - w/ Dura-Drum™), 5720, 5730, 5820, 5830	Knife Heat Treated, Tungsten Carbide (40) Required Replaces E66678	AMFH310958	\$ 13.00
	Knife Bolt Improved Head (120) Required Replaces E71444	AME83035	\$ 2.25
(5200, 5400, 5440, 5460 - w/ Dura-Drum™), 5720, 5730, 5820, 5830	Wear Plate, Right Hand High Carbon Steel, Abrasion Resistant, Tungsten Carbide	AMAE38058	\$ 54.00
	Wear Plate, Left Hand High Carbon Steel, Abrasion Resistant, Tungsten Carbide	AMAE38057	\$ 54.00
5200, (5400, 5460, 5720, 5820 - w/o Metal Detector), 5440, 5730, 5830	Knife Hi-Performance Heat Treated Replaces E66678	AMFH310958HP	\$ 17.00
5200, 5400, 5440, 5460, 5720, 5730, 5820, 5830	Roll Cleaner Smooth, Heat Treated	AME48802	\$ 49.00
6610, (6650, 6750, 6850, 6950 BSN 504992), 6710, 6810, 6910	Sharpening Stone Replaces AZ48700	AMAZ53747	\$ 83.00
6610, (6650, 6750 ASN 505694), 6710, 6810, (6850, 6950 ASN 505597), 6910, 7180, 7200, 7250, 7280, 7300, 7350, 7380, 7400, 7450, 7480, 7500, 7550, 7580, 7750, 7780, 7850, 7980	Front Spring For Double Spring Assembly	AMZ75927	\$ 51.00
6610, 6650, 6710, 6750, 6810, 6850, 6910, 6950	Corn Shearbar Heat Treated, Tungsten Carbide	AMAZ47614	\$ 495.00
	Roll Cleaner 4.875" Tall, Smooth	AMZ13019	\$ 200.00
6610, 6650, 6710, 6750, 6810, 6850, 6910, 6950, 7180, 7200, 7250, 7280, 7300, 7350, 7380, 7400, 7450, 7480, 7500, 7550, 7580	Roll Drive Coupler, Inside Smooth	AMAZ51114	\$ 99.00
	Roll Drive Coupler, Outside Smooth	AMAZ51115	\$ 102.00
6610, 6650, 6710, 6750, 6810, 6850, 6910, 6950, 7180, 7200, 7250, 7280, 7300, 7350, 7380, 7400, 7450, 7480, 7500, 7550, 7580	Tooth Bar Bolt-On, Stainless Steel (8) Required Replaces E73857	AMHXE64649	\$ 55.00
6610, 6650, 6710, 6750, 6810, 6850, 6910, 6950, 7180, 7200, 7250, 7280, 7300, 7350, 7380, 7400, 7450, 7480, 7500, 7550, 7580, 7700, 7750, 7800, 7850, 7950	Bearing Housing, Right Hand	AMZ12816	\$ 591.00
6610, 6650, 6710, 6750, 6810, 6850, 6910, 6950, 7180, 7200, 7250, 7280, 7300, 7350, 7380, 7400, 7450, 7480, 7550, 7580	Corn Knife Hi-Performance, Heat Treated, Tungsten Carbide Edge	AMZ63136HP	\$ 25.00
	Corn Knife Heat Treated, Tungsten Carbide, Wider Design (48) Required Replaces Z56647	AMZ63136	\$ 21.00
	Grass Knife Hi-Performance Heat Treated, Tungsten Carbide Edge	AMZ69500HP	\$ 22.00
6650, 6750, 6850, 6950, 7180, 7200, 7250, 7280, 7300, 7350, 7380, 7400, 7450, 7480, 7500, 7550, 7580	Corn Shearbar Hi-Performance 38 mm Thick, Heat Treated, Tungsten Carbide	AMAZ53906HP	\$ 720.00
	Grass Shearbar 36 mm Thick, Heat Treated, Tungsten Carbide	AMAZ53906	\$ 565.00
	Shearbar Hi-Performance Double Sine Wave	AMAZ53906DSW	\$ 1302.00
(6650, 6750, 6850, 6950 ASN 504992), 7180, 7200, 7250, 7280, 7300, 7350, 7380, 7400, 7450, 7480, 7500, 7550, 7580, 7750, 7780, 7850, 7980	Sharpening Stone	AMAZ56626	\$ 80.00

Forage Harvester Parts for John Deere®

Forage Harvester Parts

Forage Harvester Parts

Forage Harvester Parts for John Deere®

Application	Description	Part Number	Price
7180, 7200, 7250, 7280, 7300, 7350, 7380, 7400, 7450, 7480, 7500, 7550, 7580	Grass Shearbar 36 mm Thick, Heat Treated, Tungsten Carbide Replaces AZ53905	AMAZ103112	\$ 480.00
	Roll Cleaner 5 3/8" Tall, Smooth Replaces Z12818	AMZ13356	\$ 200.00
7700, 7750, 7780, 7800, 7850, 7950, 7980	Corn Knife Heat Treated, Tungsten Carbide Purchase Quantity as Required	AMZ72500	\$ 23.00
	Grass Knife Hi-Performance Heat Treated, Tungsten Carbide	AMZ81123HP	\$ 30.00
	Grass Knife Heat Treated, Tungsten Carbide Purchase Quantity as Required	AMZ81123	\$ 22.00
7700, 7750, 7780, 7800, 7850, 7950, 7980	Feed Roll, Lower Rear Smooth, Heat Treated Carbon Steel Replaces AZ59687	AMAZ103272	\$ 713.00
7700, 7750, 7780, 7800, 7850, 7950, 7980	Wear Plate, Kernel Processor, Right Hand Abrasion Resistant Replaces AZ100687	AMAXE11207	\$ 36.00
	Wear Plate, Kernel Processor, Left Hand Abrasion Resistant	AMAZ100688	\$ 36.00
8100, 8200, 8300, 8400, 8500	Grass Knife Heat Treated, Tungsten Carbide	AMHXE53568	\$ 22.00
	Corn Shearbar Heat Treated Tungsten Carbide Replaces HXE86990	AMHXE102352	\$ 447.00
8600, 8700, 8800	Corn Shearbar Heat Treated Tungsten Carbide Replaces HXE86990	AMHXE101350	\$ 555.00
	Shearbar Hi-Performance Heat Treated, Tungsten Carbide Replaces HXE86911	AMHXE101349	\$ 635.00

Feed Rolls and Components

Application	Description	Part Number	Price
3760, 3765, 3800, 3940, 3950, 3955, 3960, 3970, 3975, 5200, 5400, 5440, 5460, 5720, 5730, 5820, 5830, 6610, 6710, 6810, 6910, (7200, 7300, 7400, 7500, 7700, 7800 BSN 508100)	Needle Bearing, Feed Reverser/Feed Roll Gearbox	AMJD8819	\$ 14.12
3800, (3940, 3960 BSN 630000), (3950, 3970, 5730, 5830 - Lower Roll w/ Iron Guard), (3955, 3975 - Lower Roll w/ IntelliGuard™), 5200, 5400, 5440, 5460, (5720, 5820 - Upper Roll w/o Metal Detector and Lower Roll w/ Iron Guard)	Feed Roll Bearing Upper Front or Lower Front (2) Required	AMJD9865	\$ 11.50
3800, (5200, 5400, 5440, 5460 - w/ J-Knife)	Feed Roll, Lower Front For Models with 1" Hex Shaft Includes Crossbars and Hardware	AMAE35423	\$ 351.00
3940, 3950, 3955	Feed Roll, Upper Rear Abrasion Resistant	AMAE43833	\$ 241.00
3940, 3950, 3955	Feed Roll Shaft, Lower Front Hex Shaft, Stress Proof 25" Long, 1 1/4" Diameter	AME62679	\$ 87.00
	Feed Roll Shaft, Upper Front Round Shaft 26 5/16" Long, 1 3/8" Diameter	AME72470	\$ 110.00

Forage Harvester Parts

Forage Harvester Parts

Application	Description	Part Number	Price
3940, 3950, 3955	Feed Roll Tooth, Upper Front Abrasion Resistant (10) Required	AMX93045	\$ 17.00
3940, 3950, 3955, 3960, 3970, 3975	Wear Plate, Feed Roll Housing, Right Hand Abrasion Resistant, Tungsten Carbide Replaces E62415, E83070	AME92511	\$ 59.00
	Wear Plate, Feed Roll Housing, Left Hand Abrasion Resistant, Tungsten Carbide Replaces E62414, E83069	AME92512	\$ 59.00
(3950, 5720, 5730, 5820, 5830 - w/ Iron Guard), 3975 w/ IntelliGuard™, (5200, 5400 - w/ Metal Detector), (5440, 5460 - w/ Dura-Drum™ w/ Metal Detector)	Feed Roll, Lower Front Stainless Steel	AMAE42646	\$ 1076.00
3960, 3970, 3975	Feed Roll Shaft, Upper Front Round Shaft 30 5/16" Long, 1 3/8" Diameter	AME72468	\$ 83.00
	Feed Roll Shaft, Upper Rear Hex Shaft 30 5/8" Long, 1" Diameter	AME81583	\$ 63.00
3960, 3970, 3975	Feed Roll Tooth, Upper Front Abrasion Resistant (10) Required	AMAE41470	\$ 21.00
(3960, 3970 w/o Iron Guard, 3975 w/o IntelliGuard™ - w/o Metal Detector)	Feed Roll, Lower Front Abrasion Resistant	AMAE44164	\$ 385.00
5200, 5400, 5440, 5460 - w/ J-Knife	Feed Roll, Lower Rear Smooth Use w/ AME62113 Feed Roll Shaft	AMAE37068	\$ 152.00
5200, 5400, 5440, 5460 - w/ J-Knife	Feed Roll Shaft Hex Shaft, Smooth 1" Diameter, 27 3/4" Long	AME62113	\$ 43.00
	Feed Roll Shaft, Lower Front Hex Shaft, Heat Treated 27 1/8" Long, 1" Diameter	AMX93034	\$ 60.00
5200, (5400, 5460, 5720, 5820 - w/o Metal Detector), 5440, 5730, 5830	Feed Roll, Upper Rear w/ Heavy Duty End Plates, Abrasion Resistant	AMAE37101	\$ 433.00
(5200, 5400, 5440, 5460 - w/ J-Knife and Dura-Drum™ w/o Metal Detector), (5720, 5820 - w/o Metal Detector), 5730, 5830	Feed Roll Shaft, Upper Rear Hex Shaft, Heat Treated 29 7/8" Long, 1" Diameter	AME72352	\$ 45.00
(5200, 5400, 5440, 5460, 5720, 5820 - w/ Dura-Drum™ w/ Metal Detector), (5730, 5830 - w/o Iron Guard)	Feed Roll Shaft, Lower Front Hex Shaft 27 9/16" Long, 1 1/4" Diameter Use w/ AMAE37327 Feed Roll w/o Teeth, Lower Front	AME64565	\$ 68.00
(5200, 5400, 5440, 5460, 5720, 5820 - w/ Dura-Drum™ w/o Metal Detector), (5730, 5830 - w/o Iron Guard)	Feed Roll w/o Teeth, Lower Front For Models w/ 1 1/4" Hex Shaft Includes Crossbars and Hardware Replaces AE44164	AMAE37327	\$ 351.00
5440, 5460 - w/ Dura-Drum™ Prior to 1984	Feed Roll, Lower Rear Smooth, Extra Heavy, Thick Wall Tube Includes 1 1/4" Hex Shaft	AMAE42180	\$ 317.00
6610, 6650, 6710, 6750, 6810, 6850, 6910, 6950	Wear Plate, Feed Roll, Right Hand Heat Treated, Tungsten Carbide Replaces Z61013	AMZ65167	\$ 63.00
	Wear Plate, Feed Roll, Left Hand Heat Treated, Tungsten Carbide Replaces Z61012	AMZ65168	\$ 63.00

Forage Harvester Parts for John Deere®

Forage Harvester Parts

Forage Harvester Parts

Forage Harvester Parts for John Deere®

Application	Description	Part Number	Price
6610, 6650, 6710, 6750, 6810, 6850, 6910, 6950, 7180, 7200, 7250, 7280, 7300, 7350, 7380, 7400, 7450, 7480, 7500, 7550, 7580, 7750, 7780, 7850, 7950, 7980	Wear Plate, Feed Roll, Right Hand Tungsten Carbide	AMZ68063	\$ 74.00
	Wear Plate, Feed Roll, Left Hand Tungsten Carbide	AMZ68062	\$ 74.00
	Wear Plate, Feed Roll Frame, Right Hand Heat Treated	AMZ61011	\$ 30.00
	Wear Plate, Feed Roll Frame, Left Hand Heat Treated	AMZ61010	\$ 30.00
7180, 7200, 7250, 7280, 7300, 7350, 7380, 7400, 7450, 7480, 7500, 7550, 7580 - w/ Larger 4-Bearing System	Feed Roll Shaft, Upper Front Heat Treated	AMZ81671	\$ 351.00
7180, 7200, 7250, 7280, 7300, 7350, 7380, 7400, 7450, 7480, 7500, 7550, 7580	Feed Roll Shaft, Upper Rear Hex Shaft, Heat Treated 38 3/16" Long, 32 mm Diameter Replaces Z63862, Z81670	AMHXE26048	\$ 126.00
7700, 7750, 7780, 7800, 7850, 7950, 7980	Feed Roll, Upper Front Heavy Duty, 4-Bearing Design, Stainless Steel Includes Bolt-on Teeth and Bearings Replaces AZ103444	AMAZ102444	\$ 2735.00
	Feed Roll, Lower Front Stainless Steel Replaces AZ57158	AMAZ101150	\$ 1885.00
	Feed Roll, Upper Rear Stainless Steel, Reversible Design Replaces AZ57147	AMAZ71837	\$ 1014.00
7700, 7750, 7780, 7800, 7850, 7950, 7980	Feed Roll Shaft, Upper Front Heat Treated	AMZ81672	\$ 385.00
7700, 7750, 7780, 7800, 7850, 7950, 7980	Feed Roll Pan, Lower Front Abrasion Resistant	AMZ79268	\$ 200.00
	Feed Roll Pan, Lower Rear Abrasion Resistant	AMAZ64453	\$ 145.00
(7700, 7750, 7780, 7800, 7850, 7950, 7980 ASN 508669)	Wear Plate, Feed Roll, Right Hand Abrasion Resistant	AMAZ100961	\$ 148.00
	Wear Plate, Feed Roll, Left Hand Abrasion Resistant	AMAZ101960	\$ 148.00
8100, 8200, 8300, 8400, 8500	Feed Roll Tooth, Lower Front Stainless Steel (12) Required Replaces HXE55068	AMHXE100098	\$ 97.00
	Feed Roll Tooth, Lower Front Stainless Steel (12) Required Replaces HXE54553	AMHXE100097	\$ 83.00
	Feed Roll Tooth, Upper Front Stainless Steel (10) Required Replaces HXE87699	AMHXE93580	\$ 97.00
8600, 8700, 8800	Feed Roll Tooth, Upper Front Stainless Steel (10) Required	AMHXE93575	\$ 97.00

Forage Harvester Parts

Grain Tank Extensions



3" formed channel frame on John Deere® and Case IH® Gen II extensions provide unmatched strength and durability.



Simply add a Tip-Up Kit to a regular-size extension for added capacity.



Also available for Massey Ferguson® and New Holland®



Corner Caps on all Case IH® Gen II extensions prevent leakage.



For John Deere®	Description	Part Number	Retail Price
9400, 9410, 9450W BSN 695101, 9500, 9510, 9550W BSN 695201, 9600, 9610, 9650W BSN 695301	Grain Tank Extension	AMX27378	\$ 2795.00
9450W ASN 695101, 9550, 9560W ASN 695201	Grain Tank Extension	AMX27340	\$ 2795.00
9550 ASN 695301, 9650W ASN 695301, 9660W	Grain Tank Extension	AMX27341	\$ 2795.00
9650, 9660, 9670STS, 9750STS, 9760STS, 9770STS, 9860STS, 9870STS	Grain Tank Extension	AMX27342	\$ 3273.00
S550 Extension	Grain Tank Extension	AMX27346	\$ 3335.00
S Series Replaces S Series Manual Fold	Grain Tank Extension and Mounting Kit	AMX27345	\$ 3745.00
STS Series	Grain Tank Extension Mounting Kit Required for High Rate Unloading Auger	AMX27343	\$ 450.00
	Grain Tank Extension Mounting Kit Additional Corner Filler Strips Not Required	AMX27344	\$ 126.00
9400, 9410, 9450, 9500, 9500SH, 9510, 9510SH, 9550, 9550SH, 9560, 9560SH, 9560STS, 9600, 9610, 9650, 9650CTS, 9650STS, 9660, 9660CTS, 9660STS, 9750STS, 9760STS, 9860STS, CTS, CTS II	Grain Tank Window 39.1875" Wide, 14.3125" Tall, 0.187" Thick	AMH131675	\$ 121.61

For Case IH®	Description	Part Number	Retail Price
60 Series*, 66 Series*, 77 Series,	Grain Tank Extension, Red	AMX27347	\$ 2795.00
80 Series, 88 Series *Note: Requires Riser	Grain Tank Extension, Black	AMX27348	\$ 2795.00
7010, 7120, 7230, 8010, 8120, 8230, 9120, 9230	Grain Tank Extension, Black	AMX27350	\$ 3273.00
60 Series, 66 Series	Grain Tank Extension Riser Kit, Red	AMX27349	\$ 390.00

For New Holland®	Description	Part Number	Retail Price
8080, 9090, CR920, CR940, CR960, CR970, CR9040, CR9060, CR9070, CR9080	Grain Tank Extension, Black	AMX27350	\$ 3273.00

Tip-Up Assemblies

These Grain Tank Tip-Up Assemblies are for Factory Extensions. Great features of these Tip-Ups include easy installation, durable and sturdy design, unmatched quality and attractive appearance. When Ordering John Deere® or Case IH® parts for Tip-Up Assemblies, Generation I or Generation II design MUST be determined before ordering:

Generation I

- Rolled Steel at Top
- 10.50" x 10.50" Square Window
- Round Lynch-Style Pin Stud
- 4" Door-Style Hinge at Bottom

Generation II

- Square Top Edge
- 11" x 8" Trapezoid Window
- Oblong Pin Stud
- Hinge Point w/ Bolt at Bottom

**For John Deere®	Description	Part Number	Retail Price
60 Series, 70 Series	Tip-Up Assembly Factory Extension w/ Steel Corners	AMX27359 AMX27360	\$ 1891.00 \$ 2752.00
9400, 9410, 9450W, 9500, 9510, 9550, 9550W, 9560W, 9600, 9610, 9650W	Tip-Up Assembly	AMX27356	\$ 1065.00
9650, 9660, 9670STS, 9750, 9760, 9770STS, 9860, 9870STS, S Series	Tip-Up Assembly Use w/ AMX27345	AMX27358	\$ 1170.00
9650 ASN 695301, 9660W	Tip-Up Assembly	AMX27357	\$ 1065.00
S660, S670	Tip-Up Assembly Factory Equipped 300 Bushel Extension	AMX27363	\$ 2840.00
S680, S690	Tip-Up Assembly Factory Equipped 400 Bushel Extension	AMX27364	\$ 1891.00
S550 Tip-Up	Tip-Up Assembly S550, S650, S660	AMX27365	\$ 1192.00
9660STS, 9670STS, 9760STS, 9770STS, 9860STS, 9870STS	Tip-Up Assembly Sensor Bracket Manual Fold 60 Bushel	AMX27361	\$ 85.00
	Tip-Up Assembly Sensor Bracket Manual Fold 120 Bushel	AMX27362	\$ 85.00

**For Case IH®	Description	Part Number	Retail Price
60 Series, 66 Series, 77 Series, 80 Series, 88 Series	Tip-Up Assembly, Red Tip-Up Assembly, Black	AMX27366 AMX27367	\$ 1065.00 \$ 1065.00
5088, 5130, 5140	Tip-Up Assembly Manual Fold 24" Factory Extension	AMX27371	\$ 2752.00
5088, 5130, 5140, 6088, 6130, 6140, 7088, 7130, 7140	Tip-Up Assembly Manual Fold 32" Factory Extension	AMX27370	\$ 2752.00
7010, 7120, 7230	Tip-Up Assembly Manual Fold 24" Factory Extension	AMX27372	\$ 2752.00
7010, 7120, 7230, 8010, 8120, 8230, 9120, 9130, 9230	Tip-Up Assembly, Black	AMX27368	\$ 1170.00
7230, 8010, 8120, 8230, 9120, 9230	Tip-Up Assembly Manual Fold 27" Factory Extension	AMX27373	\$ 2752.00

For New Holland®	Description	Part Number	Retail Price
8080, 9090, CR920, CR940, CR960, CR970, CR9040, CR9060, CR9070, CR9080	Tip-Up Assembly, Black	AMX27368	\$ 1170.00
CR940, CR960, CR9040, CR9060	Tip-Up Assembly Manual Fold 24" Factory Extension	AMX27372	\$ 2752.00
CR940, CR960, CR9040, CR9060	Tip-Up Assembly Manual Fold 27" Factory Extension	AMX27373	\$ 2752.00



The AMX27371 Tip-Up adds approximately 100 bushel capacity.



The AMX27359 Tip-Up adds approximately 60 bushel capacity.



The AMX27370, AMX27372 and AMX27373 Tip-Up adds approximately 100 bushel capacity.



The AMX27360 Tip-Up adds approximately 120 bushel capacity.



Tillage Parts





Table of Contents

Bolts and Nuts	267
#3 Plow Head Bolts	267
Clipped Head Bolts	267
Disc Gang Bolts and Parts	268
Elliptical Head Bolts	267
Hex Head Nuts	268
Special Head Bolts	267
Chisel Plow Spikes & Sweeps, Shovels, Points and Blades	257
Chisel Plow/Wheatland Sweeps	257
Chisel Spikes	257
McKay Empire Penetrator Chisel Plow Sweeps	257
Twisted Chisel Spikes	257
Deep Tillage	269
Ripper Point	269
Disc Blades	260
Deep-Cone Disc Blades	261
Flat-Centered Disc Blades	260
Precision Double-Bevel Edge Disc Blades	260
Field Cultivator Sweeps, Parts and Accessories	253
Conventional Field Cultivator Sweeps	253
Double Points, DP Series	254
Double Points, WIF Series	254
Double Points, WIH Series	254
Harrow Tines	254
Viper Sweeps	253
Miscellaneous Parts	266
Chrome Points	266
Crescent Hoes	266
Fertilizer Knives	266
Furrower Shovels	266
Plow Parts	262
Deep-Suck Shares	265
Plow Parts—For International® Super Chief	261
Plow Parts—For John Deere®	263
Two-Way Plow Parts	264
For Harrell Ag® and Long	264
For John Deere®	264
Row Crop Sweeps, Points and Reversible Blades	256
S-Tine Sweeps and Shanks	256
Soil Saver Moldboards and Blades	258
Soil Saver Blades	258
Soil Saver Moldboards	258
Subsoiler Points	259
Booted Points	259
Cover Boards	259
Flat Shanks	259
Points—For Brillion™	259
Points—For Glencoe®	259
Points—For John Deere®	259
Vertical Tillage	255
Coulter Blades	255

Tillage—Field Cultivator Sweeps, Parts and Accessories



Viper Sweeps

All viper sweeps are made from heat-treated steel. The 7.50 mm thick material and long nose provide superior wear compared to conventional 6 mm or 1/4" thick sweeps. The built-in stem protector also minimizes wear on the bolts and stem. The unique flanged wing improves soil flow and reduces breakage.

Application	Description	Part Number	Retail Price
Recommended replacement for Brady 1971 and Later; Brillion™ 1986 and Later; Case® DMI and DMI Field Cultivators; Case IH® 4500, 4600, 4800; Glencoe® 4300; Hiniker®; International® 45; John Deere® 940, 960, 980, 985 & 726 Mulch/Finisher; Kent; Krause 3100, 4200, 4250, 6100; Landoll®; M&W; Noble; Sunflower®; Wil-Rich®	 Viper Sweep Bellota®, 47° Stem Angle, 7.50 mm Thick, 7.25" Wide 7/16" Bolt Size, 1 5/8" - 1 3/4" Center	AMX57056	\$ 11.00
	 Viper Sweep 47° Stem Angle, 7.50 mm Thick, 9" Wide 7/16" Bolt Size, 1 5/8" - 1 3/4" Center	AMX57057	\$ 14.00
	 Viper Sweep Bellota®, 47° Stem Angle, 7.50 mm Thick, 10.25" Wide 7/16" Bolt Size, 1 5/8" - 1 3/4" Center	AMX57058	\$ 15.00
	 Viper Sweep 47° Stem Angle, 7.50 mm Thick, 11.25" Wide 7/16" Bolt Size, 1 5/8" - 1 3/4" Center	AMX57059	\$ 24.00
	 Sweep Hardware Kit Includes (50) 7/16" x 1 1/2" #3 Plow Head Bolts and (50) Flange Nuts	AMX57140	\$ 51.00

Conventional Field Cultivator Sweeps



All conventional field cultivator sweeps are made from heat-treated steel. The stay-wide design ensures that the sweep will maintain the specified cutting width throughout the life of the sweep.

Application	Description	Part Number	Retail Price
Recommended replacement for Brady 1971 and Later; Brillion™ 1986 and Later; Case IH® 4500, 4600, 4800; DMI; Glencoe® 4300; Hiniker®; International® 45; John Deere® 940, 960, 980, 985 & 726 Mulch/Finisher; Kent; Krause 3100, 4200, 4250, 6100; Landoll®; M&W; Noble; Sunflower®; Wil-Rich®		Conventional Field Cultivator Sweep, WCC Series 7" Wide	AMX57062 \$ 6.50
		47° Stem Angle, 6mm Thick 8" Wide	AMX57063 \$ 8.00
		7/16" Bolt Size, 1 5/8" - 1 3/4" Center 9" Wide	AMX57018 \$ 8.50
		10" Wide	AMX57019 \$ 9.50
		12" Wide	AMX57053 \$ 11.50
Universal Tillage		Row Crop Sweep 54° Stem Angle, 6.35 mm Thick, 10" Wide	AMX57154 \$ 22.00
		7/16" Bolt Size, 2" Center 12" Wide	AMX57155 \$ 22.00
		14" Wide	AMX57130 \$ 26.00
Universal Tillage	Danish Tine Sweep Shovel Style Use AMX57055 Bolt	AMX57054	\$ 3.60
Universal Tillage	Danish Tine Sweep Shovel Style	9" Wide AMX57153	\$ 8.00

Tillage—Field Cultivator Sweeps, Parts and Accessories

Double Points, DP Series

All DP points are made from high-carbon, heat-treated steel. These points are drop-forged for superior wear-ability and have a self-sharpening edge that provides good soil penetration throughout the life of the point.

Application	Description	Part Number	Retail Price
Universal Tillage	 Double Point, DP Series 3/8" Thick, 11 3/4" Long, 2" Wide 7/16" Bolt Size, 1 5/8" - 1 3/4" Curved Center	AMX57065	\$ 17.00
Universal Tillage	 Double Point, DP Series 3/8" Thick, 11 3/4" Long, 2" Wide 7/16" Bolt Size, 1" - 2" Slotted Center	AMX57066	\$ 17.00

Double Points, WIF Series

Application	Description	Part Number	Retail Price
Universal Tillage	 Double Point, WIF Series 1/4" Thick, 1 1/2" Wide 7/16" Bolt Size, 1 3/4" Center	AMX57141	\$ 10.50

Double Points, WIH Series



Application	Description	Part Number	Retail Price
Designed for Brillion™, International® and Vibro Shank Machines	 Double Point, WIH Series 3/8" Thick, 15" Long, 2" Wide 7/16" Bolt Size, 1 1/2" - 2 1/2" Center	AMX57067	\$ 22.00

Harrow Tines

Application	Description	Part Number	Retail Price
John Deere® Field Cultivators: 960, 1050, 1060	 Harrow Tine	AMN188605	\$ 9.86

Tillage—Vertical Tillage







Coulter Blades

Application	Description	Part Number	Retail Price
Case IH® Vertical Tillage 330	 Vortex® Turbo Coulter Blade Fluted, Flat Center Blade 20" Diameter, 0.25" (6 mm) Thickness Self-Sharpening Fits 1 1/8" or 1 1/4" Square Axles	AM87630572	\$ 64.00
	 Vortex® Turbo Coulter Blade Fluted, Flat Center Blade 20" Diameter, 0.25" (6 mm) Thickness Self-Sharpening Fits 1 1/8" or 1 1/4" Square Axles	AM87630573	\$ 64.00
Great Plains® Turbo Chisels: TC5109, TC5111, TC5113, TC5115, TC5313, TC5315, TC5317, TC5319, TC5321, TC5323, TCN5107, TCN5109, TCN5311, TCN5313	Vortex® Coulter Blade VT Wave Blade 22" Diameter, 0.256" (6.50 mm) Thickness Fits 1 3/4" Round Axles	AM820-430C	\$ 72.50
Great Plains® Vertical Tillage: TurboMax, Turbo-Till, Turbo-Chopper	 Vortex® Coulter Blade VT Wave Blade 20" Diameter, 0.256" (6.50 mm) Thickness, 1.25" Cutting Width Fits 1 3/4" Round Axles	AM820-011C	\$ 68.50
Great Plains® Vertical Till: Turbo-Till ASN 5251NN, Turbo-Max ASN C3157H, Turbo-Chopper ASN A1810Y	Spider Wheel	AM589-258H	\$ 59.50
Great Plains® Discs: 3323DH*, 3326DH*, 3392DH*, 4330DH*, 4333DH*, 4336DH*, 7323DH, 7326DH, 7329DH, 7330DH, 7333DH, 7336DH, Turbo: (1000TT, 1200TT, 1500TT, 1700TT, 1800TT, 2200TT, 2400TT, 3000TT, 4000TT ASN 5251NN*), Turbo-Chisel: (TC5109, TC5111, TC5113, TC5115, TC5313, TC5315, TC5317, TC5319, TC5321, TC5323, TCN5107, TCN5309, TCN5311, TCN5313 ASN A1852*), Turbo-Chopper: (1200TC, 1500TC, 1800TC, 2400TC, 3000TC, 4000TC ASN A1810Y*), Turbo-Max: (1000TM, 1200TM, 1500TM, 1800TM, 2400TM, 3000TM, 3500TM, 4000TM, 4800TM ASN C3157H*) *Can be used to update early model machines w/ rubber ring bearing in 2-piece cast housing	Bearing Housing Assembly, Disc Gang Includes Front and Rear Housing For 1 3/4" Round Axle	AM822-294C	\$ 130.00
Great Plains® Turbo: (1000TT, 1200TT, 1500TT, 1700TT, 1800TT, 2200TT, 2400TT, 3000TT, 4000TT ASN 5251NN*), Turbo-Chopper: (1200TC, 1500TC, 1800TC, 2400TC, 3000TC, 4000TC ASN A1810Y*), Turbo-Max: (1000TM, 1200TM, 1500TM, 1800TM, 2400TM, 3000TM, 3500TM, 4000TM, 4800TM ASN C3157H*) *Can be used to update early model machines w/ rubber ring bearing in 2-piece cast housing	Bearing Housing Assembly, Chopper Reel Includes Front and Rear Housing For 1 3/4" Round Axle	AM822-294C	\$ 130.00

Tillage—Row Crop Sweeps, Points and Reversible Blades

S-Tine Sweeps and Shanks



S-Tine sweeps are made from heat-treated steel. These sweeps are designed to fit more row crop cultivators and some soil finishers using S-Tine shanks with one 3/8" bolt hole. All non-reversible sweeps are made with a built-in bolt protector. S-Tine shanks are made from spring steel designed to create a "vibra" action for superior weed control.

Application	Description	Part Number	Retail Price
Universal Tillage	 S-Tine Sweep, Reversible 6 mm Thick, 1" Wide 3/8" Bolt Size w/ Elliptical Head	AMX57068	\$ 3.60
	 S-Tine Sweep, Shovel 6 mm Thick, 2 3/4" Wide 3/8" Bolt Size w/ Elliptical Head	AMX57069	\$ 5.25
	 S-Tine Sweep, Shovel 6 mm Thick, 4" Wide 3/8" Bolt Size w/ Elliptical Head	AMX57070	\$ 6.40
	 S-Tine Sweep, Shovel 6 mm Thick, 7" Wide 3/8" Bolt Size w/ Elliptical Head	AMX57072	\$ 5.00
	 S-Tine Sweep, Duckfoot 6 mm Thick, 4" Wide 3/8" Bolt Size w/ Elliptical Head	AMX57071	\$ 6.40
	 S-Tine Shank, HD 12 mm Thick, 2" Toolbar Size 1/2" Clamp Bolt Size, 3/8" Sweep Bolt Size 14 1/2" Working Clearance	AMX57073	\$ 24.00
	 S-Tine Shank, High Clearance 12 mm Thick, 2 1/2" - 3" Toolbar Size 1/2" Clamp Bolt Size, 3/8" Sweep Bolt Size 18 1/2" Working Clearance	AMX57132	\$ 26.00

Tillage—Chisel Spikes & Plow Sweeps, Shovels, Points and Blades

Chisel Spikes

The drop-forged design provides several advantages over other brands or OEM points that are not drop-forged. The extra material at the point makes these chisel spikes some of the most durable and longest-wearing points on the market. The exclusive design provides a self-sharpening point for superior penetration throughout the life of the point.

Application	Description	Part Number	Retail Price
Universal Tillage	 Chisel Spike 5/8" Thick, 17 1/2" Long, 2" Wide 1/2" Bolt Size, 2 1/4" Center Reversible, Drop-Forged	AMX57001	\$ 18.00
	 Chisel Spike Single-Ended Spike w/ High-Chrome Alloy Point 3/4" Thick, 13 1/2" Long, 2 1/4" Wide 2 1/4" - 2 1/2" Center 1/2" Bolt Size w/ Plow Head	AMX57122	\$ 48.00



Twisted Chisel Spikes

All twisted chisel pikes are formed from high-carbon, heat-treated steel. Twisted chisel spikes are designed to be used in place of straight chisel spikes to turn soil or incorporate residue for maximum weed kill.

Application	Description	Part Number	Retail Price
Universal Tillage	 Twisted Chisel Spike 1/2" Thick, 23" Long, 3" Wide 1/2" Bolt Size, 2 1/4" - 2 1/2" Center	Right Hand	AMX57002 \$ 27.00
		Left Hand	AMX57003 \$ 27.00



Chisel Plow/Wheatland Sweeps

All chisel plow/wheatland sweeps are formed from heat-treated steel. They are designed to be used on chisel plows in place of a chisel for more soil shattering action and a wider cut between the shanks.

Application	Description	Part Number	Retail Price
Universal Tillage	 Chisel Plow Sweep 50° Stem Angle, 7.50 mm Thick, 14" Wide 1/2" Bolt Size, 2 1/4" Center	AMX57120	\$ 19.00
	 Chisel Plow Sweep 50° Stem Angle, 7.50 mm Thick, 16" Wide 1/2" Bolt Size, 2 1/4" Center	AMX57052	\$ 20.80



McKay Empire Penetrator Chisel Plow Sweeps

McKay Empire penetrator sweeps are uniquely designed to provide superior penetration and wearability in hard soil zones. The patented design of the penetrator sweep utilizes 70% of the cutting blade or edge inclined at an optimum angle of 30°. University tests have proven that these penetrators require 35-50% less load weight on the machine to penetrate hard soil zones when compared to conventional chisel sweeps. The inclined cutting edge and flanged wing also provide more strength and breakage resistance when compared to conventional chisel plow sweeps.







Application	Description	Part Number	Retail Price
Universal Tillage	 McKay Empire Penetrator Chisel Plow Sweep 50° Stem Angle, 5/16" Thick, 14" Wide 1/2" Bolt Size, 2 1/4" Center	AMX57060	\$ 20.00
	 McKay Empire Penetrator Chisel Plow Sweep 50° Stem Angle, 5/16" Thick, 16" Wide 1/2" Bolt Size, 2 1/4" Center	AMX57061	\$ 20.00

Tillage—Soil Saver Moldboards and Blades

Soil Saver Moldboards

Application	Description	Part Number	Retail Price
Universal Tillage	 Soil Saver Moldboard, Standard 26" Long, 4" Wide, 1/2" Thick 1/2" Bolt Size, 2 1/4" - 2 1/2" Center 1-Piece Reversible	Right Hand AMX57004	\$ 24.00
		Left Hand AMX57005	\$ 24.00
Brillion™; Bush Hog®; Deutz-Allis®; Glencoe®; Kelley; Kent; Krause; Landoll®; Massey Ferguson®; Steiger®; Sunflower®; Wilbeck and others	 Soil Saver Moldboard, Hardfaced 26" Long, 4" Wide, 1/2" Thick 1/2" Bolt Size, 2 1/4" - 2 1/2" Center 1-Piece Reversible	Right Hand AMX57006	\$ 34.00
		Left Hand AMX57007	\$ 34.00

Soil Saver Blades

Application	Description	Part Number	Retail Price
Universal Tillage	 Soil Saver Blade 22 7/16" Diameter, 0.19" Thick, 7-Gauge 1 1/2" Round Hole	AMX57017	\$ 40.00
Allis Chalmers® Min-Tills; John Deere® 710, 712 & 714 Mulch-Tillers	 Soil Saver Blade 20 3/8" Diameter, 0.19" Thick, 7-Gauge 1 1/8" or 1 1/4" Square Hole	AMN187522	\$ 32.00
Brillion™; McFarlane	 Soil Saver Blade 20 7/16" Diameter, 0.19" Thick, 7-Gauge 1 1/2" Square Hole	AMX57015	\$ 33.50
Bush Hog®; Case®; Case IH®; Ford®; Glencoe®; Krause; Landoll®; Massey Ferguson®	 Soil Saver Blade 20 3/8" Diameter, 0.19" Thick, 7-Gauge 1 1/2" Round Hole	AMX57014	\$ 33.50
Sunflower®	 Soil Saver Blade 20 3/8" Diameter, 0.19" Thick, 7-Gauge 1 3/4" Round Hole	AMX57016	\$ 33.50
John Deere® 712 Mulch Tiller	 Soil Saver Blade 22 1/2" Diameter, 0.19" Thick, 7-Gauge 1 1/8" or 1 1/4" Square Hole	AMN183542	\$ 40.00

Tillage—Subsoiler Points

Cover Boards

Application	Description	Part Number	Retail Price
Recommended replacement for DMI and Case® New Holland® Subsoilers	 Cover Board 6 mm Thick, 8" Wide 7/16" Bolt Size, 1 1/4" - 2 1/4" Center	AMX57074	\$ 37.00

Booted Points



Booted points are designed to fit most V-type rippers using standard shanks. All booted points are formed from 1" thick high-carbon, heat-treated steel.

Application	Description	Part Number	Retail Price
Recommended replacement for International® #10, #11, #14 and others	 Booted Point w/o Wing 2 1/2" x 8" Point Size, 1 1/4" Shank Size	AMX57124	\$ 31.50

Flat Shanks

Application	Description	Part Number	Retail Price
Fits Case®, John Deere® and Landoll®	 Flat Shank Subsoiler 1" Thick, 2" x 13" Point Size 1/2" Plow Head Bolt Size, 3" Center	AMX57134	\$ 26.00
Recommended replacement for M&W and Sunflower® Subsoiler Points	Flat Shank Subsoiler 2 1/2" x 12" Point Size, 1 1/4" Shank Size 1/2" x 2 1/2" Pin/Bolt Size Comes w/ extra heavy-duty chrome-footed cap	AMX57135	\$ 153.00



Points—For John Deere®

Application	Description	Part Number	Retail Price
Recommended replacement for Glencoe®; Krause Dominator and TL 3000 Disc Ripper w/ Wear Bar; John Deere® 510, 912, 915 & 2700 Mulch Ripper all w/ Standard Shanks	 Point w/o Wing 2 1/2" x 12" Point Size, 1 1/4" Shank Size	AMX57075	\$ 36.00
	 Point w/o Wing 2 1/2" x 12" Point Size, 1 1/4" Shank Size Comes w/ 3" Standard Cap	AMX57076	\$ 55.00

Points—For Brillion™

Application	Description	Part Number	Retail Price
Recommended replacement for Brillion™ equipment	 Point w/o Wing 2 1/2" x 12" Point Size, 1 1/4" Shank Size Slot for shank protector comes built-in	AMX57077	\$ 43.00





Points—For Glencoe®

Application	Description	Part Number	Retail Price
Recommended replacement for Glencoe®; Krause Dominator and TL 3000 Disc Ripper w/ Wear Bar; John Deere® 510, 912, 915 & 2700 Mulch Ripper all w/ Standard Shanks	 Point w/o Wing 2 1/2" x 12" Point Size, 1 1/4" Shank Size	AMX57075	\$ 36.00
	 Point w/o Wing 2 1/2" x 12" Point Size, 1 1/4" Shank Size Comes w/ 3" Standard Cap	AMX57076	\$ 55.00

Tillage—Disc Blades





Precision Double-Bevel Edge Disc Blades

All disc blades are manufactured using a high-quality alloy containing a small amount of boron. The boron alloy allows the blade to flex when striking an obstruction and return to its original shape. This greatly reduces breakage or bending. The press-formed, double-bevel edge is designed to self-sharpen as the disc wears, eliminating the need to roll or sharpen the blades.

Application	Description	Part Number	Retail Price
Universal Tillage	 Double-Bevel Disc Blade, Plain Edge 22" Diameter, 0.236" Thick (6 mm) 3-Gauge, 2.50" Concavity 1 1/8" or 1 1/4" Square Hole	AMX57108	\$ 94.00
	 Double-Bevel Disc Blade, Plain Edge 24" Diameter, 0.236" Thick (6 mm) 3-Gauge, 3" Concavity 1 1/8" or 1 1/4" Square Hole	AMX57114	\$ 110.00
	 Double-Bevel Disc Blade, Plain Edge 26" Diameter, 0.236" Thick (6 mm) 3-Gauge, 3.50" Concavity 1 1/8" or 1 1/4" Square Hole	AMX57136	\$ 134.00
	 Double-Bevel Disc Blade, Notched Edge 22" Diameter, 0.236" Thick (6 mm) 3-Gauge, 2.50" Concavity 1 1/8" or 1 1/4" Square Hole	AMX57109	\$ 97.00
	 Double-Bevel Disc Blade, Notched Edge 24" Diameter, 0.236" Thick (6 mm) 3-Gauge, 3" Concavity 1 1/8" or 1 1/4" Square Hole	AMX57115	\$ 114.00

Flat-Centered Disc Blades





All disc blades are manufactured using a high-quality alloy containing a small amount of boron. The boron alloy allows the blade to flex when striking an obstruction and return to its original shape. This greatly reduces breakage or bending. The press-formed edge is designed to self-sharpen as the disc wears, eliminating the need to roll or sharpen the blades.

Application	Description	Part Number	Retail Price
Recommended replacement for International®	 Flat-Centered Disc Blade, Plain Edge 22" Diameter, 0.236" Thick (6 mm) 3-Gauge, 2.50" Concavity 1 1/8" or 1 1/4" Square Hole	AMX57110	\$ 98.00
	 Flat-Centered Disc Blades, Plain Edge 22" Diameter, 0.177" Thick (4.50 mm) 7-Gauge, 2.50" Concavity 1 1/8" or 1 1/4" Square Hole	AMX57133	\$ 76.00
	 Flat-Centered Disc Blade, Plain Edge 24" Diameter, 0.236" Thick (6 mm) 3-Gauge, 3" Concavity 1 1/8" or 1 1/4" Square Hole	AMX57116	\$ 110.00
	 Flat-Centered Disc Blade, Notched Edge 22" Diameter, 0.236" Thick (6 mm) 3-Gauge, 2.50" Concavity 1 1/8" or 1 1/4" Square Hole	AMX57111	\$ 100.00
	 Flat-Centered Disc Blade, Notched Edge 24" Diameter, 0.236" Thick (6 mm) 3-Gauge, 3" Concavity 1 1/8" or 1 1/4" Square Hole	AMX57117	\$ 113.00

Tillage—Disc Blades

Deep-Cone Disc Blades

All disc blades are manufactured using a high-quality alloy containing a small amount of boron. The boron alloy allows the blade to flex when striking an obstruction and return to its original shape. This greatly reduces breakage or bending. The press-formed edge is designed to self-sharpen as the disc wears, eliminating the need to roll or sharpen the blades.

Application		Description	Part Number	Retail Price
Recommended replacement for John Deere®		Deep-Cone Disc Blade, Plain Edge 20" Diameter, 0.177" Thick (4.50 mm) 7-Gauge, 3.27" Concavity 1 1/8" or 1 1/4" Square Hole	AMX57131	\$ 68.00
		Deep-Cone Disc Blade, Plain Edge 22" Diameter, 0.236" Thick (6 mm) 3-Gauge, 3.74" Concavity 1 1/8" or 1 1/4" Square Hole	AMX57112	\$ 100.00
		Deep-Cone Disc Blade, Plain Edge 24" Diameter, 0.236" Thick (6 mm) 3-Gauge, 3.87" Concavity 1 1/8" or 1 1/4" Square Hole	AMX57118	\$ 115.00
		Deep-Cone Disc Blade, Notched Edge 22" Diameter, 0.177" Thick (4.50 mm) 7-Gauge, 3.74" Concavity 1 1/8" or 1 1/4" Square Hole	AMX57113	\$ 82.00
		Deep-Cone Disc Blade, Notched Edge 24" Diameter, 0.236" Thick (6 mm) 3-Gauge, 3.87" Concavity 1 1/8" or 1 1/4" Square Hole	AMX57119	\$ 118.00
		Deep-Cone Disc Blade, Notched Edge 24" Diameter, 0.236" Thick (6 mm) 3-Gauge, 3.87" Concavity 1 1/4" Square Hole	AMX57121	\$ 110.00









Tillage—Plow Parts

Plow Parts—For International® Super Chief

Application	Description	Part Number	Retail Price
Recommended replacement for International® Super Chief equipment	 Moldboard, Right Hand 16" - 18" - 20", 5/16" Thick 4 Holes at 7/16" Replaces 462314R, 488265R, 58996C	AMX57078	\$ 158.00
	 Moldboard, Left Hand 16" - 18" - 20", 5/16" Thick 4 Holes at 7/16" Replaces 46403L	AMX57079	\$ 160.00
	 Rock Share, Right Hand Includes Hardware 16", 3/8" Thick 4 Holes: 1 at 1/2", 3 at 7/16" Replaces 46323R	AMX57080	\$ 35.00
	 Rock Share, Left Hand Includes Hardware 16", 3/8" Thick 4 Holes: 1 at 1/2", 3 at 7/16"	AMX57081	\$ 37.00
	 Rock Share, Right Hand Includes Hardware 18", 3/8" Thick 4 Holes: 1 at 1/2", 3 at 7/16" Replaces 463238R	AMX57082	\$ 38.00
	 Rock Share, Left Hand Includes Hardware 18", 3/8" Thick 4 Holes: 1 at 1/2", 3 at 7/16"	AMX57083	\$ 39.00
	 Shin, Right Hand 14" - 16" - 18", 5/16" Thick Replaces 488266R, 522325R	AMX57033	\$ 28.00
	 Shin, Left Hand 14" - 16" - 18", 5/16" Thick Replaces 464595, 55075C	AMX57034	\$ 32.00
	 Landside Wear Plate, Right Hand Includes Hardware 1/2" Thick 2 Holes at 7/16" Replaces 59058	AMX57084	\$ 12.50
	 Landside Wear Plate, Left Hand 1/2" Thick 2 Holes at 7/16"	AMX57085	\$ 13.50
	 Landside Inner Plate, Right Hand 1/2" Thick 3 Holes: 1 at 7/16", 2 at 1/2" Replaces 59057, 1980672C	AMX57086	\$ 29.00
	 Landside Inner Plate, Left Hand 1/2" Thick 3 Holes: 1 at 7/16", 2 at 1/2" Replaces 59057L, 1980671C	AMX57087	\$ 30.00

Tillage—Plow Parts

Plow Parts—For John Deere®





Application	Description	Part Number	Retail Price
Recommended replacement for John Deere® 400, 500, HS356, NU1036-1046, NU1048 and SDT	 Landside Inner Plate, Left Hand 1/2" Thick 2 Holes at 1/2" Replaces A16494	AMX57098	\$ 28.00
	 Landside Inner Plate, Right Hand 1/2" Thick 2 Holes at 1/2" Replaces A16493	AMX57099	\$ 26.50
Recommended replacement for John Deere® NU1036-1046 and NU1048	 Moldboard 18", 5/16" Thick 8 Holes at 7/16" Replaces A17431	AMX57090	\$ 201.00
	 Moldboard, Left Hand 18", 5/16" Thick 8 Holes at 7/16" Replaces A17432	AMX57091	\$ 201.00
	 Rock Share, Right Hand 16", 3/8" Thick 4 Holes: 1 at 1/2", 3 at 7/16" Replaces A10228	AMX57092	\$ 34.00
	Rock Share, Left Hand 16", 3/8" Thick 4 Holes: 1 at 1/2", 3 at 7/16"	AMX57093	\$ 35.00
	 Rock Share, Right Hand 18", 3/8" Thick 5 Holes: 1 at 1/2", 4 at 7/16" Replaces A10225	AMX57094	\$ 38.00
	 Rock Share, Left Hand 18", 3/8" Thick 5 Holes: 1 at 1/2", 4 at 7/16"	AMX57095	\$ 39.00
	 Shin, Right Hand 16" - 18", 5/16" Thick 2 Holes at 7/16" Replaces A15594	AMX57096	\$ 30.00
	 Shin, Left Hand 16" - 18", 5/16" Thick 2 Holes at 7/16"	AMX57097	\$ 31.50

Tillage—Plow Parts







Two-Way Plow Parts

Two-way plow parts are manufactured using high-carbon, heat-treated steel. Moldboards and shins are manufactured using solid steel.

For Harrell Ag® and Long

Application	Description	Part Number	Retail Price
Recommended replacement for Harrell Ag®	 Double End Share 5 Bolt Holes Replaces 7900636, 7902836	AMX57100	\$ 35.00
	Double End Share, Hardfaced 5 Bolt Holes Replaces 7900636, 7902836	AMX57123	\$ 92.00
	 Lower Shin, Chrome Reversible Replaces 7920836	AMX57101	\$ 22.50
	 Upper Shin, Steel Reversible Replaces 9820736	AMX57102	\$ 15.75
	 Landside, Long 1/2" Thick 4 Bolt Holes Replaces 218270B	AMX57104	\$ 30.00
	Recommended replacement for Harrell Ag® and Long	Landside, Short 1/2" Thick 2 Bolt Holes Replaces 79010W	AMX57103



For John Deere®

Application	Description	Part Number	Retail Price
Recommended replacement for John Deere®	 Moldboard 19 7/8" x 17 1/2", 5/16" Thick 6 Bolt Holes Replaces P57264	AMX57105	\$ 148.00
	 Double End Share 27 1/2" Long, 4.50" Wide, 3/8" Thick 4 Bolt Holes Replaces 57043, 57270	AMX57106	\$ 34.50
	Double End Share, Hardfaced 27 1/2" Long, 4.50" Wide, 3/8" Thick 4 Bolt Holes Replaces 57043, 57270	AMX57107	\$ 92.00
	 Right Shin 3 Bolt Holes Replaces P57266	AMX57021	\$ 36.00
	 Left Shin 3 Bolt Holes Replaces P57265	AMX57020	\$ 36.00
	 Landside Reversible 8" x 11 1/2", 5/16" Thick 4 Bolt Holes Replaces P57522	AMX57022	\$ 53.00
	 Wear Pad 4" x 6 1/2", 1/2" Thick 2 Bolt Holes Includes Hardware Replaces P57046	AMX57023	\$ 19.00

Tillage—Plow Parts

Deep-Suck Shares



Deep-suck shares are manufactured using high-carbon, heat-treated steel. The special design includes a long nose for superior penetration and suction. The deep-suck plowshare is ideal for use on tough soil where it is difficult to keep the plow in the ground or when deeper penetration is desired.

Application	Description	Part Number	Retail Price
Case IH® 7550, HSCS, HSCU, HSCXK, HSCXN (1995 and Later), HSCXT, HSES	 Deep-Suck Plow Share, Right Hand Hardfaced	AMX57147	\$ 80.00
	 Deep-Suck Plow Share, Left Hand Hardfaced	AMX57148	\$ 87.00
	Rock Share, Right Hand Hardfaced	AMX57149	\$ 70.75
	 Rock Share, Left Hand Hardfaced	AMX57150	\$ 75.00
Recommended replacement for International®	 Deep-Suck Plow Share, Right Hand 18", 3/8" Thick 4 Holes: 1 at 1/2", 3 at 7/16" Replaces 463254	AMX57088	\$ 36.00
	 Deep-Suck Plow Share, Left Hand 18", 3/8" Thick 4 Holes: 1 at 1/2", 3 at 7/16"	AMX57089	\$ 32.50

Tillage—Miscellaneous Parts

Furrower Shovels

Furrower points are manufactured using high-carbon, heat-treated steel.



Application	Description	Part Number	Retail Price
Universal Tillage	 Furrower Shovel 1/4" Thick, 10" Wide 7/16" Bolt Holes, 1 1/4" - 2 1/4" Center-to-Center	AMX57025	\$ 55.00
	 Furrower Shovel 1/4" Thick, 12" Wide 7/16" Bolt Holes, 1 1/4" - 2 1/4" Center-to-Center	AMX57026	\$ 33.00
	 Furrower Shovel 1/4" Thick, 15" Wide 7/16" Bolt Holes, 1 1/4" - 2 1/4" Center-to-Center	AMX57027	\$ 40.10

Fertilizer Knives

Application	Description	Part Number	Retail Price
Universal Tillage	Fertilizer Knife 13 1/2" Long, 3/8" Pipe w/ Chrome Insert 3/8" x 2" Shank Size, Back-Swept Knife	AMX57024	\$ 44.00



Crescent Hoes

Crescent hoes are manufactured using high-carbon, heat-treated steel.

Application	Description	Part Number	Retail Price
Universal Tillage	 Crescent Hoe, Right Hand 6" x 1/4" 3/8" Bolt Holes, 1 1/4" - 2" Center	AMX57028	\$ 15.60
	 Crescent Hoe, Left Hand 6" x 1/4" 3/8" Bolt Holes, 1 1/4" - 2" Center	AMX57029	\$ 15.60

Chrome Points





Chrome points, made to fit drill shoes, are cast using high-chrome alloy for superior wear and durability.

Application	Description	Part Number	Retail Price
For John Deere® Spear Point, Acra-Plant, Crustbuster, Great Plains® and My-D Han-D	 Chrome Point	AMX57030	\$ 22.00
For Acra-Plant Z-6 Bolt-On Point	 Chrome Point	AMX57031	\$ 25.00
For Acra-Plant Z-6 Pin-On Point	 Chrome Point	AMX57032	\$ 20.00

Tillage—Bolts and Nuts









Clipped Head Bolts

Clipped head bolts are used primarily on plow shares, landsides and 3-piece chisel points.

Application	Description	Part Number	Retail Price
Universal Tillage	 Clipped Head Bolt 7/16" Diameter, 1 1/4" Long	AMX57035	\$ 1.05
	 Clipped Head Bolt 7/16" Diameter, 1 1/2" Long	AMX57036	\$ 1.05
	 Clipped Head Bolt 7/16" Diameter, 2" Long	AMX57037	\$ 1.45
	 Clipped Head Bolt 1/2" Diameter, 1 3/8" Long	AMX57038	\$ 1.20

#3 Plow Head Bolts

#3 plow head bolts are used primarily on shins, moldboards, landsides, chisel spikes and others.

Application	Description	Part Number	Retail Price
Universal Tillage	 Plow Head Bolt 3/8" Diameter, 1 1/4" Long	AMX57039	\$ 0.60
	 Plow Head Bolt 7/16" Diameter, 1 1/2" Long	AMX57040	\$ 0.71
	 Plow Head Bolt 7/16" Diameter, 1 3/4" Long	AMX57041	\$ 0.94
	 Plow Head Bolt 7/16" Diameter, 2" Long	AMX57042	\$ 1.05
	 Plow Head Bolt 7/16" Diameter, 2 1/2" Long	AMX57043	\$ 1.28
	 Plow Head Bolt 1/2" Diameter, 1 3/4" Long	AMX57044	\$ 1.53
	 Plow Head Bolt 1/2" Diameter, 2 1/2" Long	AMX57045	\$ 1.64
	 Plow Head Bolt 5/8" Diameter, 2" Long	AMX57046	\$ 2.10

Special Head Bolts

Special head bolts are designed to convert 3/8" shank holes to accommodate 7/16" punch sweeps on field cultivators.

Application	Description	Part Number	Retail Price
Universal Tillage	 Special Head Bolt 7/16" x 3/8"	AMX57047	\$ 1.23





Elliptical Head Bolts

Elliptical head bolts are designed to fit S-tine sweeps.



Application	Description	Part Number	Retail Price
Universal Tillage	 Elliptical Head Bolt 3/8" Diameter, 1 1/2" Long	AMX57055	\$ 0.70

Tillage—Bolts and Nuts

Hex Head Nuts

Application	Description	Part Number	Retail Price
Universal Tillage	Hex Head Nut, 3/8"	AMX57048	\$ 0.15
			
	Hex Head Nut, 7/16"	AMX57049	\$ 0.23
			
	Hex Head Nut, 1/2"	AMX57050	\$ 0.32
			
	Hex Head Nut, 5/8"	AMX57051	\$ 0.66
			

Disc Gang Bolts and Parts

Application	Description	Part Number	Retail Price
Case IH® Discs: 350, 370, International® Discs: 330, 490	Gang Bolt 71.90" Long For 1 1/8" Square Axle	AM472586R2	\$ 74.00
Case IH® Discs: 350, 370, 475, 485, 496, 760, International® Discs: 330, 470, 480, 490	Gang Bolt 76.40" Long For 1 1/8" Square Axle	AM468582R2	\$ 79.50
Case IH® Discs: 350, 370, 475, 496, International® Discs: 330, 470, 480, 490	Gang Bolt 79.40" Long For 1 1/8" Square Axle	AM468583R2	\$ 84.00
Case IH® Discs: 350, 370, 475, 496, 760, International® Discs: 470, 475, 480, 490, 610	Gang Bolt 67.40" Long For 1 1/8" Square Axle	AM652939R2	\$ 71.00
Case IH® Discs: 350, 370, 485, 496, 760, International® Discs: 330, 480	Gang Bolt 57.60" Long For 1 1/8" Square Axle	AM471015R1	\$ 59.00
Case IH® Discs: 350, 370, 496, International® Discs: 330, 480, 490	Gang Bolt 49" Long For 1 1/8" Square Axle	AM471014R1	\$ 51.00
Case IH® Discs: 350, 475, 485, 760, International® Discs: 350, 470, 480, 490	Gang Bolt 0.25" Long For 1 1/8" Square Axle	AM468607R1	\$ 45.00
Case IH® Discs: 350, 496, International® Discs: 470, 490	Gang Bolt 85.50" Long For 1 1/8" Square Axle	AM48144R1	\$ 84.00
Case IH® Discs: 475, 496, 760, International® Discs: 470, 475, 480, 490	Gang Bolt 94.60" Long For 1 1/8" Square Axle	AM487168R1	\$ 100.00
Case IH® Discs: 37, 46, 48, 60, 61, 120, 122, 130, 132, 150, 330, 340, 345, 350, 470, 475, 480, 485, 490, 496, 610, 760, 3800, 3850, 3900, 3950, RMX340, New Holland® Disc: ST440	 Flanged Disc Bearing 5" Overall Width, 0.531" Hole Diameter Round Bore, Greaseable Replaces 737321R93, SN3215	AMST491A	\$ 21.00
John Deere® Discs: 310, 315, 330, 331, 335, 340, 350, 355, 360, 370, 637, 640, 650, 670	 Gang Bearing	AMAA30942	\$ 38.50

Tillage—Deep Tillage

Ripper Point

Application	Description	Part Number	Retail Price
Recommended replacement for DMI and Case IH® Eco-Tiger Rippers and Disc Rippers; New Holland® ST Series; John Deere® Mulch Rippers and Disc Rippers; Krause® Dominator and TL 3000 Disc Ripper	 SoilRipper™ Point Bellota®, 7.50" winged point designed for a 1.25" wide shank	AMX57151	\$ 110.00

Rims

Table of Contents

Dual Rim Clamps and Bolts.....	274	Rims—Dual	274
Rims—Center Dish.....	273	Rims—Front	270
Rims—Combine	274	Rims—Rear	272
Rims—Combine Dual.....	276		



Rims—Front

Application	Description	Part Number	Retail Price
Allis Chalmers® D10, D12, D14, D15, D17, WC, WD, WD45	Rim - Front, 4.25" x 16" 5 Holes Inside Offset - 3.625, Outside Offset - 0.875	R4.25X16-5H-AC	\$ 105.00
All Models	Rim - Front, 6" x 15" 6 Hole Inside Offset - 4.50, Outside Offset - 2.00	R6X15-6H	\$ 80.00
All Models	Rim - Front, 6" x 15" 6 Hole (Heavy Duty) Inside Offset - 4.00, Outside Offset -2.50	R6X15-6H-HD	\$ 125.00
All Models	Rim - Front, 8" x 15" 6 Hole Inside Offset - 4.00, Outside Offset - 4.625	R8X15-6H	\$ 125.00
All Models	Rim - Front, 8" x 15" 6 Hole (Heavy Duty) Inside Offset - 4.00, Outside Offset - 4.625	R8X15-6H-HD	\$ 175.00
All Models	Rim - Front, 10" x 15" 6 Hole Inside Offset - 6.50, Outside Offset - 4.125	R10X15-6H	\$ 130.00
All Models	Rim - Front, 10" x 15" 6 Hole (Heavy Duty) Inside Offset - 4.00, Outside Offset - 6.50	R10X15-6H-HD	\$ 175.00
Ford®	Rim - Front, 4.5" x 16" 6 Hole	R4.5X16-6H-FD	\$ 55.00
Ford®	Rim - Front, 5.5" x 16" 6 Hole	R5.5X16-6H-FD	\$ 60.00
All Models	Rim - Front, 6" x 16" 6 Hole	R6X16-6H	\$ 90.00
All Models	Rim - Front, 6" x 16" 6 Hole (Heavy Duty) w/ 4.625" Pilot Inside Offset - 4.125, Outside Offset - 2.50	R6X16-6H-HD	\$ 125.00
Allis Chalmers®, Ford®	Rim - Front, 8" x 16" 6 Hole Inside Offset - 4.125, Outside Offset - 4.5625	R8X16-6H-AC	\$ 145.00
Allis Chalmers®, Ford®	Rim - Front, 8" x 16" 6 Hole Inside Offset- 4.125, Outside Offset - 4.5625	R8X16-6H-HD-AC	\$ 175.00
Case®, Massey Ferguson®	Rim - Front, 8" x 16" 6 Hole Inside Offset - 5.625, Outside Offset - 3.125	R8X16-6H-CA	\$ 145.00
Case®, Massey Ferguson®	Rim - Front, 8" x 16" 6 Hole (Heavy Duty) Inside Offset - 5.625, Outside Offset - 3.125	R8X16-6H-HD-CA	\$ 175.00
International®, John Deere®	Rim - Front, 8" x 16" 6 Hole (Heavy Duty) Inside Offset - 4.25, Outside Offset - 3.75	R8X16-6H-HD-IH	\$ 175.00
International®, John Deere®	Rim - Front, 8" x 16" 6 Hole Inside Offset - 4.75, Outside Offset - 3.25	R8X16-6H-JD	\$ 145.00
International®, John Deere®	Rim - Front, 8" x 16" 6 Hole (Heavy Duty) Inside Offset - 4.75, Outside Offset - 3.25	R8X16-6H-HD-JD	\$ 175.00
All Models	Rim - Front, 10" x 16" 6 Hole Inside Offset - 4.125, Outside Offset - 6.25	R10X16-6H	\$ 175.00
Allis Chalmers®, Ford®	Rim - Front, 10" x 16" 6 Hole (Heavy Duty) Inside Offset - 4.125, Outside Offset - 6.875	R10X16-6H-HD-AC	\$ 200.00
International®, John Deere®	Rim - Front, 10" x 16" 6 Hole (Heavy Duty) Inside Offset - 4.75, Outside Offset - 5.50	R10X16-6H-HD-JD	\$ 200.00
Allis Chalmers®, John Deere®	Rim - Front, 8" x 16" 8 Hole Inside Offset - 4.75, Outside Offset - 3.75	R8X16-8H-JD	\$ 145.00
Allis Chalmers®, John Deere®	Rim - Front, 8" x 16" 8 Hole (Heavy Duty) Inside Offset - 4.75, Outside Offset - 3.75	R8X16-8H-HD-JD	\$ 175.00
Ford®	Rim - Front, 8" x 16" 8 Hole Inside Offset - 3.75, Outside Offset - 5.25	R8X16-8H-FD	\$ 145.00
Ford®	Rim - Front, 8" x 16" 8 Hole (Heavy Duty) Inside Offset - 3.75, Outside Offset - 4.875	R8X16-8H-HD-FD	\$ 175.00

Rims

Application	Description	Part Number	Retail Price
International®, Massey Ferguson®	Rim - Front, 8" x 16" 8 Hole Inside Offset - 2.25, Outside Offset - 6.25	R8X16-8H-IH	\$ 145.00
International®	Rim - Front, 8" x 16" 8 Hole (Heavy Duty) Inside Offset - 2.25, Outside Offset - 6.375	R8X16-8H-HD-IH	\$ 175.00
Ford®	Rim - Front, 10" x 16" 8 Hole (Heavy Duty) Inside Offset - 3.75, Outside Offset - 6.875	R10X16-8H-HD-FD	\$ 200.00
International®, Massey Ferguson®	Rim - Front, 10" x 16" 8 Hole Inside Offset - 2.25, Outside Offset - 8.25	R10X16-8H-IH	\$ 195.00
International®	Rim - Front, 10" x 16" 8 Hole (Heavy Duty) Inside Offset - 2.375, Outside Offset - 8.25	R10X16-8H-HD-IH	\$ 200.00
Allis Chalmers®, John Deere®	Rim - Front, 10" x 16" 8 Hole Inside Offset - 4.75, Outside Offset - 5.75	R10X16-8H-JD	\$ 195.00
Allis Chalmers®, John Deere®	Rim - Front, 10" x 16" 8 Hole (Heavy Duty) Inside Offset - 4.75, Outside Offset - 6.00	R10X16-8H-HD-JD	\$ 200.00
John Deere®	Rim - Front, 11" x 16.10" 8 Hole	R11X16.1-8H	\$ 145.00
John Deere®	Rim - Front, 11" x 16.10" 8 Hole (Heavy Duty) Inside Offset - 8.00, Outside Offset - 3.50	R11X16.1-8H-HD	\$ 185.00
Massey Ferguson®	Rim - Front 11" x 16.10" 8 Hole (Heavy Duty) Inside Offset - 5 1/2"	R11X16.1-8H-HDMF	\$ 185.00
Case IH®	Rim - Front, 14" x 16.10" 8 Hole Inside Offset - 5.50, Outside Offset - 9.00	R14X16.1-8H-CIH	\$ 235.00
John Deere®	Rim - Front, 14" x 16.10" 8 Hole Inside Offset - 4.50, Outside Offset - 9.50	R14X16.1-8H-JD	\$ 235.00
John Deere®	Rim - Front, 14" x 16.10" 8 Hole (Heavy Duty) Inside Offset - 4.50, Outside Offset - 10.25	R14X16.1-8H-HD	\$ 280.00
Tractors with Front Wheel Assist	Rim - Front, 12" x 24" 8 Hole with 8 11/16" Pilot	R12X24-8H-MFD	\$ 525.00
All Models	Rim - Front, 15" x 26" 10 Hole with 11" Pilot Hole	R15X26-10H-MFD	\$ 715.00
All Models	Rim - Front (Waffle Style), Rim Only	R12X28-WAF	\$ 365.00
	Centers:		
	8 Hole Center	C28-8H-WAF	\$ 350.00
	10 Hole Center	C28-10H-WAF	\$ 350.00
	12 Hole Center	C28-12H-WAF	\$ 375.00
International® with Front Wheel Assist	Rim - Front, 15" x 28" 8 Loop	R15X28-8L	\$ 480.00
All Models	Rim - Front (Waffle Style), 15" x 28" - Rim Only	R15X28-WAF	\$ 375.00
	Centers:		
	8 Hole Center	C28-8H-WAF	\$ 350.00
	10 Hole Center	C28-10H-WAF	\$ 350.00
	12 Hole Center	C28-12H-WAF	\$ 375.00
All Models	Rim - Front, 12" x 30" 8 Hole with 8 11/16" Pilot Hole	R12X30-8H-MFD	\$ 295.00
Magnum® Series with Front Wheel Assist	Rim - Front 13" x 30" 8 Loop w/o Center Dish. Use with C30-10H Center Dish	R13X30-8L	\$ 475.00
All Models	Rim - Front, 13" x 30" 10 Hole with 11" Pilot	R13X30-10H-MFD	\$ 315.00
John Deere® 55 & 60 Series - Front Wheel Assist	Rim - Front (Waffle Style), 13" x 30" - Rim Only	R13X30-WAF	\$ 390.00
	Centers:		
	8 Hole Center	C28-8H-WAF	\$ 350.00
	10 Hole Center	C28-10H-WAF	\$ 350.00
	12 Hole Center	C28-12H-WAF	\$ 375.00
International® with Front Wheel Assist	Rim - Front, 15" x 30" 8 Loop	R15X30-8L	\$ 490.00
8000 Series John Deere®	Rim - Front (Waffle Style), 15" x 30" - Rim Only	R15X30-WAF	\$ 465.00
	Centers:		
	8 Hole Center	C28-8H-WAF	\$ 350.00
	10 Hole Center	C28-10H-WAF	\$ 350.00
	12 Hole Center	C28-12H-WAF	\$ 375.00

Rims

Application	Description	Part Number	Retail Price
All Models	Rim - Front (Waffle Style), 15" x 34" - Silver	R15X34-WAF-S	\$ 550.00
		Centers: 12 Hole Center C34-12H-WAF	\$ 310.00
All Models	Rim - Front (Waffle Style), 15" x 34" - Yellow	R15X34-WAF-Y	\$ 550.00
		Centers: 12 Hole Center C34-12H-WAF	\$ 310.00
8000 Series John Deere®	Rim - Front (Waffle Style), 13" x 34" - Rim Only	R13X34-WAF	\$ 465.00
		Centers: 12 Hole Center C34-12H-WAF	\$ 310.00
Case®, John Deere®	Rim - Front (Waffle Style), 15" x 34"	R15X34-WAF	\$ 550.00



Rims—Rear

Application	Description	Part Number	Retail Price
All Models with 4 Mounting Loops	Rear Rim, 10" x 24" 4 Loop	R10X24-4L	\$ 200.00
All Models with 6 Mounting Loops	Rear Rim, 10" x 24" 6 Loop	R10X24-6L	\$ 225.00
Models with Power Adjust	Rear Rim, 10" x 24" 4 Rail Power Adjust	R10X24-4R	\$ 585.00
Ford/New Holland®, Massey Ferguson®	Rear Rim, 12" x 24" Open Center Double Bevel	R12X24-DBS	\$ 485.00
Models with Power Adjust	Rear Rim, 12" x 26" 4 Rail Power Adjust	R12X26-4R	\$ 545.00
Ford®, International®, Massey Ferguson®	Rear Rim, 10" x 28" 6 Loop	R10X28-6L	\$ 175.00
Models with Power Adjust	Rear Rim, 10" x 28" 4 Rail Power Adjust	R10X28-4R	\$ 550.00
Ford®, Massey Ferguson®	Rear Rim, 11" x 28" 8 Hole with Center Dish	R11X28-8H	\$ 245.00
Models with Power Adjust	Rear Rim, 11" x 28" 4 Rail Power Adjust	R11X28-4R	\$ 535.00
John Deere®	Rear Rim, 12" x 28" Open Center Double Bevel	R12X28-DB	\$ 425.00
Models with 6 Mounting Loops	Rear Rim, 12" x 28" 6 Loop	R12X28-6L	\$ 285.00
Models with 8 Mounting Loops	Rear Rim, 12" x 28" 8 Loop	R12X28-8L	\$ 325.00
Models with Power Adjust	Rear Rim, 12" x 28" 4 Rail Power Adjust	R12X28-4R	\$ 560.00
Models with Power Adjust	Rear Rim, 13" x 28" 4 Rail Power Adjust	R13X28-4R	\$ 530.00
Case®, Ford®, International®, Massey Ferguson®	Rear Rim, 15" x 28" 6 Loop	R15X28-6L	\$ 470.00
Models with Power Adjust	Rear Rim, 15" x 28" 4 Rail Power Adjust	R15X28-4R	\$ 605.00
Ford®, Massey Ferguson®	Rear Rim, 14" x 30" 8 Hole with Center Dish	R14X30-8H	\$ 375.00
All Models with 8 ½" Lug Spacing	Rear Rim, 16" x 34" Open Center Double Bevel - Silver	R16X34-DBS	\$ 615.00
John Deere® 2755, 3020, 4000, 4010, 4020, 4030, 4040, 4050, 4230, 4240, 4250, 4320, 4430, 4440, 4450, 4455, 7020, 8430, 8440, 8450, 8630, 8640 - w/ 8 1/2" Lug Spacing	Rear Rim, 16" x 34" Open Center Double Bevel - Yellow Replaces R31943	R16X34-DBY	\$ 615.00
Models with Power Adjust	Rear Rim, 16" x 34" 6 Rail Power Adjust	R16X34-6R	\$ 770.00
Super C Farnall®	Rear Rim, 9" x 36" 6 Loop	R9X36-6L	\$ 420.00
Farnall® H, M	Rear Rim, 10" x 38" Deep Well	R10X38-IHHM	\$ 235.00
Case®, Ford®, International®	Rear Rim, 10" x 38" Open Center Double Bevel	R10X38-DBS	\$ 300.00
John Deere®	Rear Rim, 10" x 38" Open Center Double Bevel	R10X38-DBY	\$ 300.00
Farnall® H, M	Rear Rim, 11" x 38" Deep Well	R11X38-IHHM	\$ 265.00
Allis Chalmers®, Case®, International®, John Deere®	Rear Rim, 12" x 38" Open Center Double Bevel - Silver	R12X38-DBS	\$ 475.00
Allis Chalmers®, Case®, International®, John Deere®	Rear Rim, 12" x 38" Open Center Double Bevel - Yellow	R12X38-DBY	\$ 475.00
Models with Power Adjust	Rear Rim, 12" x 38" 6 Rail Power Adjust	R12X38-6R	\$ 810.00
John Deere® Tractors: 1020, 1120, 2010, 2020, 2030, 2120, 3010	Rear Rim, 12" x 36" Open Center Double Bevel - Yellow	R12X36-DBY	\$ 425.00

Rims

Application	Description	Part Number	Retail Price
Farmall® H, M	Rear Rim, 14" x 38" Deep Well	R14X38-IHBM	\$ 325.00
All Models with 14" Spacing	Rear Rim, 14" x 38" Open Center Double Bevel - Silver	R14X38-DBS	\$ 475.00
All Models with 14" Spacing	Rear Rim, 14" x 38" Open Center Double Bevel - Black	R14X38-DBB	\$ 280.00
All Models w/ 14" Lug Spacing	Rear Rim, 14" x 38" Open Center Double Bevel - Yellow	R14X38-DBY	\$ 475.00
Models with Power Adjust	Rear Rim, 14" x 38" 6 Rail Power Adjust	R14X38-6R	\$ 840.00
John Deere®	Rear Rim, 15" x 28" Open Center Double Bevel	R15X28-DBY	\$ 420.00
John Deere®	Rear Rim, 15" x 30" Open Center, Double Bevel, Drop Center to fit 28" Cast	R15X30-28-DBY	\$ 460.00
All Models	Rear Rim, 16" x 38" Open Center Double Bevel - Silver	R16X38-DBS	\$ 745.00
John Deere® 4050, 4250, 4430, 4450, 4520, 4620, 4630, 4640, 4840, 4650, 4850, 5020, 6030, 8440, 8450, 8630, 8640, 8650	Rear Rim, 16" x 38" Open Center Double Bevel - Yellow Replaces R41012, R418416, R80306	R16X38-DBY	\$ 745.00
55 Series & 60 Series John Deere®	Rear Rim	R16X38-12H-JD	\$ 1025.00
Versatile®	Rear Rim, 16" x 38" 16 Hole Inside Offset - 9.25, Outside Offset - 7.50	R16X38-16H-VER	\$ 1150.00
All Models with 7" or 9.5" Lug Space	Rear Rim, 18" x 38" Open Center Double Bevel - Silver	R18X38-DBS	\$ 925.00
John Deere® 4040, 4050, 4240, 4250, 4440, 4450, 4620, 4630, 4640, 4650, 4840, 4850, 5020, 6030, 8440, 8450, 8640, 8650, 8850 - w/ 7" or 9.50" Lug Spacing	Rear Rim, 18" x 38" Open Center Double Bevel - Yellow Replaces R74851	R18X38-DBY	\$ 925.00
Versatile®	Rear Rim, 18" x 38" 12 Hole Inside Offset - 10.00, Outside Offset - 8.50	R18X38-12H-VER	\$ 1150.00
All Models with 8" Lug Space	Rear Rim, 16" x 42" Open Center Double Bevel - Silver	R16X42-DBS	\$ 920.00
John Deere® 4050, 4250, 4450, 4640, 4650, 4840, 4850, 8450, 8650, 8850 - w/ 8" Lug Spacing	Rear Rim, 16" x 42" Open Center Double Bevel - Yellow Replaces R80307	R16X42-DBY	\$ 920.00
All Models with 9.5" or 14" Lug Space	Rear Rim, 16" x 42" Open Center Double Bevel - Silver Drops to Fit 38" Cast	R16X42-38-DBS	\$ 540.00
All Models with 9.5" or 14" Lug Space	Rear Rim, 16" x 42" Open Center Double Bevel - Yellow Drops to Fit 38" Cast	R16X42-38-DBY	\$ 540.00
55 Series John Deere®	Rear Rim, 16" x 42" 12 Hole Inside Offset - 6.00, Outside Offset - 11.25	R16X42-12H-JD	\$ 1350.00
All Models	Rear Rim, 18" x 42" Open Center - Silver	R18X42-DBS	\$ 675.00
John Deere® 4650, 4850, 8850	Rear Rim, 18" x 42" Open Center Double Bevel - Yellow Replaces R75935	R18X42-DBY	\$ 675.00
All Models with 9.5" or 14" Lug Space	Rear Rim, 18" x 42" Open Center Double Bevel Drops to Fit 38" Cast	R18X42-38-DB	\$ 1150.00
55 Series John Deere®	Rear Rim, 18" x 42" 12 Hole Inside Offset - 13.50, Outside Offset - 6.00	R18X42-12H-JD	\$ 1450.00
All Models	Rear Rim, 12" x 46" Open Center Double Bevel Drops to Fit 38" Cast	R12X46-38-DB	\$ 1675.00
55 & 60 Series John Deere®	Rear Rim, 16" x 46" 12 Hole Inside Offset - 11.50, Outside Offset - 5.50	R16X46-12H-JD	\$ 1150.00

Rims

Rims—Center Dish

Application	Description	Part Number	Retail Price
Magnum Series	Center Dish, 30" Dish - 10 Hole w/ 11" Pilot Fits 13" x 30" - 8 Loop Wheel	C30-10H	\$ 425.00

Rims

Rims—Dual

Application	Description	Part Number	Retail Price
Allis Chalmers®, Case®, International®, Massey Ferguson®	Dual Rim, 13" x 46" 10 Hole	R13X46-10HDRS	\$ 1125.00
John Deere®	Dual Rim, 15" x 50" 10 Hole Inside Offset - 1.50, Outside Offset - 14.50	R15X50-10H-DRY	\$ 1450.00
All Models	Dual Rim, 16" x 38" 9 Hole Inside Offset - 1.50, Outside Offset - 18.25	R16X38-9HDRS	\$ 670.00
All Models	Dual Rim, 16" x 38" 9 Hole Inside Offset - 1.50, Outside Offset - 18.25	R16X38-9HDRY	\$ 670.00
All Models	Dual Rim, 16" x 38" 10 Hole - Silver Inside Offset - 2.00, Outside Offset - 15.00	R16X38-10HDRS	\$ 825.00
All Models	Dual Rim, 16" x 38" 10 Hole - Yellow Inside Offset - 2.00, Outside Offset - 15.00	R16X38-10HDRY	\$ 825.00
International®, John Deere®	Dual Rim, 16" x 42" 10 Hole, OEM Style - Silver Inside Offset - 1.50, Outside Offset - 15.75	R16X42-10HROES	\$ 875.00
International®, John Deere®	Dual Rim, 16" x 42" 10 Hole, OEM Style - Yellow Inside Offset - 1.50, Outside Offset - 15.75	R16X42-10HROEY	\$ 875.00
All Models	Dual Rim, 16" x 42" 10 Hole, Star Center - Silver Inside Offset - 1.25, Outside Offset - 16.00	R16X42-10HDRSPS	\$ 845.00
All Models	Dual Rim, 16" x 42" 10 Hole, Star Center - Yellow Inside Offset - 1.25, Outside Offset - 16.00	R16X42-10HDRSPY	\$ 845.00
All Models	Dual Rim, 16" x 46" 10 Hole Inside Offset - 2.00, Outside Offset - 15.50	R16X46-10HDR	\$ 1150.00
John Deere®	Dual Rim, 16" x 46" 10 Hole Inside Offset - 2.00, Outside Offset - 15.00	R16X46-10H-DRY	\$ 1150.00
All Models	Dual Rim, 18" x 38" 9 Hole Inside Offset - 1.25, Outside Offset - 20.00	R18X38-9HDR	\$ 825.00
All Models	Dual Rim, 18" x 38" 10 Hole Inside Offset - 1.75, Outside Offset - 17.50	R18X38-10HDRS	\$ 885.00
All Models	Dual Rim, 18" x 38" 10 Hole Inside Offset - 2.00, Outside Offset - 17.50	R18X38-10HDRY	\$ 885.00
All Models	Dual Rim, 18" x 38" 10 Hole Inside Offset - 1.00, Outside Offset - 18.25	R18X38-10HDRW	\$ 885.00
All Models	Dual Rim, 18" x 42" 10 Hole Inside Offset - 2.00, Outside Offset - 17.25	R18X42-10HDRS	\$ 950.00
All Models	Dual Rim, 18" x 42" 10 Hole Inside Offset - 1.75, Outside Offset - 17.50	R18X42-10HDRY	\$ 950.00
John Deere® 9300, 9310, 9400, 9410, 9510, 9520	Dual Rim, 23" x 38" 10 Hole Inside Offset - 0.00, Outside Offset - 24.50, 11" Pilot	R23X38-10HDRY	\$ 1625.00

Rims



Dual Rim Clamps and Bolts

Application	Description	Part Number	Retail Price
All Models	Dual Rim J Bolt 23" Long	AM423J	\$ 35.00
Universal Tractors	Dual Clamp Reverse Angle Iron Style Use w/ AM423J Dual Rim J-Bolt	AMJBB	\$ 20.00



Rims—Combine

Application	Description	Part Number	Retail Price
International® w/ Regular Light Axle	Rim - Combine, 8" x 16" 8 Hole Inside Offset - 1.00, Outside Offset - 9.75	R8X16-8H-COMIH	\$ 145.00

Rims

Application	Description	Part Number	Retail Price
International®	Rim - Combine, 8" x 16" 8 Hole (Heavy Duty) Inside Offset - 1.00, Outside Offset - 9.50	R8X16-8H-HD-COMIH	\$ 175.00
International® w/ Regular Light Axle	Rim - Combine, 10" x 16" 8 Hole (Standard Duty) Inside Offset - 1.00, Outside Offset - 9.6875	R10X16-8H-COMIH	\$ 175.00
International® w/ Regular Light Axle	Rim - Combine, 10" x 16" 8 Hole (Heavy Duty) Inside Offset - 1.00, Outside Offset - 9.625	R10X16-8H-HD-COMIH	\$ 200.00
John Deere®, Massey Ferguson®	Rim - Combine, 10" x 24" 8 Hole Inside Offset - 6.50, Outside Offset - 4.00	R10X24-8H-COM	\$ 315.00
Allis Chalmers®	Rim - Combine, 10" x 24" 8 Hole Inside Offset - 7.00, Outside Offset - 3.75	R10X24-8H-COMAC	\$ 315.00
International® w/ Regular Light Axle	Rim - Combine, 10" x 24" 8 Hole Inside Offset - 1.00, Outside Offset - 9.25	R10X24-8H-COMIH	\$ 315.00
International® w/ Heavy Duty Axle	Rim - Combine, 10" x 24" 8 Hole (Heavy Duty)	R10X24-8H-HD-COMIH	\$ 390.00
International®	Rim - Combine, 12" x 24" 8 Hole Inside Offset - 7.25, Outside Offset - 5.25	R12X24-8H-COM	\$ 370.00
Allis Chalmers®, International® w/ Heavy Duty Axle	Rim - Combine, 12" x 24" 8 Hole	R12X24-8H-COMAC	\$ 370.00
International® w/ Regular Light Axle	Rim - Combine, 12" x 24" 8 Hole Inside Offset - 1.00, Outside Offset - 11.25	R12X24-8H-COMIH	\$ 350.00
International® w/ Heavy Duty Axle	Rim - Combine, 12" x 24" 8 Hole (Heavy Duty)	R12X24-8H-HD-COMIH	\$ 400.00
John Deere®	Rim - Combine, 12" x 24" 8 Hole Inside Offset - 6.50, Outside Offset 6.00	R12X24-8H-COMJD	\$ 380.00
John Deere® 9000 Series	Rim - Combine (Heavy Duty), 14" x 26" 8 Hole w/ 6" Pilot, Yellow, Inside Offset - 8.25, Outside Offset - 6.50	R14X26-8H-HDY	\$ 645.00
International®	Rim - Combine, 16" x 16.1" 8 Hole Inside Offset - 15.00, Outside Offset - 1.00	R16X16.1-8H-COM	\$ 315.00
John Deere® 6620 & Up w/ Factory 8 Bolt Rear Wheel Assist	Rim - Combine, 16" x 26" 8 Hole (Heavy Duty)	R16X26-8H-COM-HD	\$ 630.00
International®, John Deere®	Rim - Combine, 20" x 26" 8 Hole w/ 8" Pilot Inside Offset - 8.50, Outside Offset - 12.25	R20X26-8HLCOM	\$ 685.00
International®, John Deere®, Massey Ferguson®	Rim - Combine, 20" x 26" 8 Hole w/ 6" Pilot Inside Offset - 12.75, Outside Offset - 8.25	R20X26-8HSCOM	\$ 685.00
International®	Rim - Combine, 21" x 32" 10 Hole Inside Offset - 8.25, Outside Offset - 12.00	R21X32-10HCOM	\$ 1625.00
John Deere® 9000 Series	Rim - Combine, 21" x 32" 10 Hole Metric w/ 9.50" Pilot Inside Offset - 8.00, Outside Offset - 14.00	R21X32-10HCOM-M	\$ 1625.00
John Deere® 9000 Series	Rim - Combine, 21" X 32" 10 Hole Metric w/ 11" Pilot Inside Offset - 11.00, Outside Offset - 11.125	R21X32-10HCOM-ML	\$ 1625.00
John Deere® 6620 & Up w/ Factory 8 Bolt Rear Wheel Assist	Rim - Combine, 25" x 26" 8 Hole w/ 6" Pilot (Heavy Duty)	R25X26-8H-COM-HD	\$ 825.00
John Deere® S660, S670, S680, S690, S760, S770, S780, S785, S790	Rear Rim - Combine, 25" x 26" 8 Hole - Yellow	AMAXE10349	\$ 850.00
International®	Rim - Combine, 27" x 32" 10 Hole Inside Offset - 17.50, Outside Offset - 11.00	R27X32-10HCOMIH	\$ 1225.00
John Deere® 9000 Series	Rim - Combine, 27" x 32" 10 Hole Metric w/ 9.50" Pilot Inside Offset - 10.75, Outside Offset - 16.75	R27X32-10HCOM-M	\$ 1225.00
John Deere®	Rim - Combine, 27" x 32" 8 Hole Inside Offset - 16.25, Outside Offset - 11.75	R27X32-8HCOMJD	\$ 1225.00
John Deere® 9000 Series	Rim - Combine, 31" x 32" 10 Hole Metric w/ 9.50" Pilot Inside Offset - 20.00, Outside Offset - 12.50	R31X32-10HCOM-M	\$ 1275.00
John Deere® 9000 Series	Rim - Combine, 27" x 32" 10 Hole Metric w/ 11" Pilot Inside Offset - 10.75, Outside Offset - 16.75	R27X32-10HCOM-MBP	\$ 1225.00

Rims

Rims—Combine Dual

Application	Description	Part Number	Retail Price
Case IH®: 2144, 2166, 2188, 2344, 2366, 2377, 2388	Dual Rim - Straddle, Silver 16" x 38" 20 Hole, 15" Offset, 11" Pilot	R16X38-20H-SD	\$ 2025.00
Case IH®: 1660 ASN JJC0038346, 2144, 2166, 2188, 2344, 2366, 2377 SN HAJ292001-HAJ300000, 2388	Dual Rim - Straddle 16" x 42" 20 Hole Replaces 184458C2, 87393046	R16X42-20H-SD	\$ 2125.00
Case IH®: 2388	Dual Rim, Silver 18" x 42" 20 Hole Replaces 184456C2, 87393051	R18X42-20H-SD	\$ 2125.00
John Deere®: 9500, 9510, 9550, 9560, 9600, 9610, 9650, 9650CTS, 9650STS, 9660, 9750STS, CTS, CTS II	Dual Rim - Straddle 16" x 38" 10 Hole Metric, 15" Offset, 9.50" Pilot	R16X38-10H-SD	\$ 1750.00
	Dual Rim - Straddle 16" x 38" 10 Hole Metric, 15" Offset, 11" Pilot	R16X38-10H-SD-BP	\$ 1750.00
	Dual Rim - Straddle 16" x 42" 10 Hole Metric, 15" Offset, 11" Pilot	R16X42-10H-SD-BP	\$ 1900.00
John Deere®: 9600, 9610, 9650, 9650CTS, 9650STS, 9660, 9660CTS, 9660STS, 9750STS, 9760STS, 9860STS, CTS II	Dual Rim - Straddle 16" x 42" 10 Hole Metric, 15" Offset, 9.50" Pilot	R16X42-10H-SD	\$ 1900.00
John Deere®: 9500, 9510, 9550, 9560, 9600, 9610, 9650, 9650CTS, 9650STS, 9660, 9750STS, CTS, CTS II	Dual Rim - Straddle, Yellow 18" x 38" 10 Hole Metric, 15" Offset, 11" Pilot	R18X38-10H-SD-BP	\$ 1800.00
	Dual Rim - Straddle 18" x 42" 10 Hole Metric, 15" Offset, 11" Pilot	R18X42-10H-SD-BP	\$ 1825.00
John Deere®: 9670STS, 9770STS, 9870STS, S660, S670, S680, S690, S760, S770, S780, S790	Dual Rim - Straddle, Yellow 23" x 38" 10 Holes Metric, 13 3/4" Offset, 11" Pilot Replaces AXE39088	R23X38-10H-SD-BP	\$ 1950.00

Miscellaneous

Table of Contents

Drivelines.....	280	PTO Adapters.....	278
Drive Shafts.....	282	Quick Hitches.....	278
Idler Pulleys.....	277	Roller Chains and Components.....	280
Pickup Platform Belts.....	282	Schwartz Wide Front Ends.....	279

Idler Pulleys

These pressed-steel pulleys feature a single-row, radial-type, high-quality precision ground, pre-lubricated ball bearing. The bearing has contact-type seals to ensure positive retention of lubricant and full protection against dirt, dust or foreign matter.

Application	Description	Dimensions	Part Number	Retail Price
Universal Equipment	V - Idler Pulley Replaces 70260680	4" x 0.84" x 0.635"	IPAVI-64	\$ 15.50
Universal Equipment	V - Idler Pulley	4.37" x 1" x 0.635"	IPBVI-70	\$ 17.50
Universal Equipment	V - Idler Pulley	5" x 1" x 0.635"	IPBVI-80	\$ 32.50
Universal Equipment	V - Idler Pulley Replaces AH65015	5.25" x 1.31" x 0.635"	IPCVI-84	\$ 21.00
Universal Equipment	V - Idler Pulley Replaces 71347580, 824960C91, AN15237	7.31" x 1.31" x 0.635"	IPBCVI-117	\$ 25.50
Universal Equipment	V - Idler Pulley w/ 1/2" ID Sleeve Replaces 673214C91, 2446490W1, 71307305, 86996213, AE27688	7.31" x 1.31" x 0.635"	IPCVI-117	\$ 25.00
Universal Equipment	V - Idler Pulley Replaces 700709995	9" x 1.31" x 0.635"	IPCVI-144	\$ 30.50
Universal Equipment	Flat Idler Pulley	4" x 1.12" x 0.635"	IPABFI-64	\$ 16.50
Universal Equipment	Flat Idler Pulley Replaces AN202317	4.75" x 1.21" x 0.635"	IPABFI-76	\$ 20.00
Universal Equipment	Flat Idler Pulley Replaces AR541N	4.75" x 1.43" x 0.635"	IPBCFI-76	\$ 34.95
Universal Equipment	Flat Idler Pulley Replaces 853317, 7502212, 71145679, AN150710	5.75" x 1.43" x 0.635"	IPBCFI-92	\$ 22.50
Universal Equipment	Flat Idler Pulley Replaces 71174568, AE22622	5.75" x 1.75" x 0.635"	IPFPB2A-92	\$ 24.00
Universal Equipment	Flat Idler Pulley	5.75" x 2.06" x 0.635"	IP26FI-92	\$ 24.00
Universal Equipment	Flat Idler Pulley Replaces 853473, 71355162	5.75" x 2.43" x 0.635"	IP32FI-92	\$ 25.00
Universal Equipment	Flat Idler Pulley Replaces 1055520M1, AP24917	6.25" x 1.43" x 0.635"	IPBCFI-100	\$ 22.50
Universal Equipment	Flat Idler Pulley Replaces AE37341	6.50" x 1.51" x 0.635"	IP24FFI-104	\$ 28.50
Universal Equipment	Flat Idler Pulley Replaces 2447080W1	6.75" x 1.18" x 0.635"	IPABFI-108	\$ 24.00
Universal Equipment	Flat Idler Pulley Replaces AE45111, AM123792	6.75" x 1.43" x 0.635"	IPBCFI-108	\$ 24.50
Most Makes and Models	Flat Idler Pulley	7" x 1.37" x 0.50"	IPAG2613A	\$ 38.00
Universal Equipment	Flat Idler Pulley Replaces 71306443, AH66202	7.75" x 1.43" x 0.635"	IPBCFI-124	\$ 27.50
Universal Equipment	Flat Idler Pulley Replaces AH87119, AH93318	8" x 3.25" x 0.50"	IP212852128-108	\$ 50.00
Universal Equipment	Flat Idler Pulley Replaces 71364640, 86976165, 87108007, 87109318, AH97031	8.75" x 1.43" x 0.635"	IPBCFI-140	\$ 30.50

Miscellaneous

Application	Description	Dimensions	Part Number	Retail Price
Universal Equipment	Flat Idler Pulley Replaces 71153512, AH85276	9" x 1.93" x 0.635"	IPDFI-144	\$ 33.00
Universal Equipment	Flat Idler Pulley w/ Double Row of Bearings Replaces 1331251C1, AN274139	10" x 3.31" (Bore Size 5/8")	IP212842160-110	\$ 61.50
Universal Equipment	Flat Idler Pulley w/ Double Row of Bearings Replaces 763661, 2553560W1, 80763661, 86588003, AH94450, AN220598	9" x 2.03" (Bore Size 5/8")	IP212824144-110	\$ 46.00
Universal Equipment	Flat Idler Pulley w/ Double Row of Bearings	8" x 3.25" (Bore Size 5/8")	IP212852128-110	\$ 50.00
John Deere® Tractors: 5075M, 5085M, 5100M, 5115M, Utility: 1023E, 1025R, 1026R, 2025R, 2026R, 2210, 4010, 4110, 4115, 4210, 4310, 4410, 4510, 4610, 4710, Combine: 9780CTS SN 74502-77170	V-Idler Pulley, Steel	0.664" x 3.71" x 0.82"	AMAM118447	\$ 10.99
John Deere®: 9000 Series, CTS Series, 50 Series STS	Idler Pulley, Round Belt	3.53" x 3.14" x 0.83"	IP56RG54M06	\$ 15.00

PTO Adapters

Application	Description	Part Number	Retail Price
Tractors up to 70HP	PTO Adapter Small 540 to 1000 Spline Changes PTO from 1 3/8" x 6 spline to 1 3/8" x 21 spline and extends the PTO 4 1/8"	AMX59112	\$ 40.00
Tractors up to 70HP	PTO Adapter Small 1000 to 540 Spline, 6 3/8" Overall Length Reduces PTO from 1 3/8" x 21 spline to 1 3/8" x 6 spline and extends the PTO shaft 4 1/8"	AMX59108	\$ 40.00
Tractors up to 100HP	PTO Adapter Large 1000 to 540 Spline, 7 1/2" Overall Length Reduces PTO from 1 3/4" x 20 spline to 1 3/8" x 6 spline and extends the PTO shaft 4 5/8"	AMX59109	\$ 70.00
Tractors up to 100HP	PTO Adapter Large 1000 to Small 1000 Spline, 7" Overall Length Changes PTO from 1 3/4" x 20 Spline to 1 3/8" x 21 Spline and extends the PTO 4 5/8"	AMX59110	\$ 70.00



Quick Hitches

Application	Description	Part Number	Retail Price
Cat II	Quick Hitch, 4" x 6" Beam 36" Wide, Includes 1 1/8" Mounting Pins and Adapter Bushings	AMX741020	\$ 565.00
Cat III	Quick Hitch, 4" x 6" Beam 38" Wide, Includes 1 7/16" Mounting Pins	AMX741022	\$ 565.00
Cat III	Quick Hitch, 4" x 6" Beam 44" Wide, Includes 1 7/16" Mounting Pins	AMX741021	\$ 565.00

Miscellaneous



Schwartz Wide Front Ends

Application	Description	Part Number	Retail Price
Used on all standard duty front ends	Bushing, Knee Assembly - 1 5/8"	AM6030-3	\$ 9.00
Used on all heavy duty front ends	Bushing, Knee Assembly - 1 3/4"	AM7469	\$ 13.96
Used on all wide front ends	Bushing, Pivot Pin	AM6030-4	\$ 9.71
Used on all wide front ends	Bushing, Pivot Pin	AM6030-5	\$ 11.00
Used on all wide front ends	Pivot Pin, 1 1/4" X 6 11/16"	AM1393	\$ 23.68
Used on all wide front ends	Pivot Pin, 1" X 4 3/16"	AM1394	\$ 38.86
International®: H, Super H, 300, 350	Spindle Standard Duty, 1 5/8" Upright Diameter	AM3034	\$ 202.59
International®: M, Super M, MTA, 400, 450	Spindle Standard Duty, 1 5/8" Upright Diameter	AM3033	\$ 264.13
International®: 460, 544 GAS, 656, 544 Diesel	Spindle Standard Duty, 1 5/8" Upright Diameter	AM3273	\$ 173.60
International®: 504	Spindle Standard Duty, 1 5/8" Upright Diameter	AM3521	\$ 189.29
International®: 560, 706 Gas & LPG, 756 Gas & LPG, 806, 856, 656	Spindle Standard Duty, 1 5/8" Upright Diameter	AM3274	\$ 227.22
International®: 560, 706, 756, 806, 856	Spindle Heavy Duty, 1 3/4" Upright Diameter	AM7461	\$ 298.30
International®: 460, 544 GAS, 656, 544 Diesel	Spindle Heavy Duty, 1 3/4" Upright Diameter	AM9618	\$ 293.00
International®: M, Super M, MTA, 400, 450	Spindle Heavy Duty, 1 3/4" Upright Diameter	AM9617	\$ 293.00
John Deere®: 3010, 3020, 4010, 4020	Spindle Heavy Duty, 1 3/4" Upright Diameter	AM7456	\$ 303.85
John Deere®: 2510, 2520RC, 3010, 3020, 4000, 4010, 4020	Spindle Standard Duty, 1 5/8" Upright Diameter	AM3997	\$ 253.92
John Deere®: 60, 70, 620, 630, 720, 730	Spindle Standard Duty, 1 5/8" Upright Diameter	AM3035	\$ 252.92
White®, Oliver®: 770, 880, 1550, 1555, 1600, 1650, 1655 w/ Power Steering, 2-70	Spindle Standard Duty, 1 5/8" Upright Diameter	AM16455	\$ 238.64
Used on all wide front ends	Steering Arm, Left Hand	AM2130	\$ 91.22
Used on all wide front ends	Steering Arm, Right Hand	AM2129	\$ 92.34
Used on all standard duty front ends	Thrust Bearing, Spindle	AM6035-1	\$ 18.00
Used on all heavy duty front ends	Thrust Bearing, Spindle	AM6035-3	\$ 33.74
Used on all front ends with P/N prefixes of AMDU, AMDUH, or AMHDUH	Tie Rod, 18.75" (Center-to-Center)	AM2-2813	\$ 64.59
Used on all wide front ends	Tie Rod Tube Assembly	AM2-2812	\$ 70.80
International®: 300, 350, 400, 450, 504, 544, 560, 656, 700, 706, 730, 756, H, Super H, M, Super M	Tie Rod	AM2-2512	\$ 25.00
Used on all standard wide front ends	Knee Extension (Left or Right Hand) 11 5/8" Upright Length, 1 5/8" Upright Diameter	AM3036	\$ 356.48
Used on all standard wide front ends	Knee Extension (Left or Right Hand) 9 5/8" Upright Length, 1 5/8" Upright Diameter	AM3037	\$ 320.56
Used on all heavy duty wide front ends	Knee Extension (Right Hand) 11 5/8" Upright Length, 1 3/4" Upright Diameter	AM7465-2	\$ 479.14
Used on all heavy duty wide front ends	Knee Extension (Left Hand) 11 5/8" Upright Length, 1 3/4" Upright Diameter	AM7465-1	\$ 344.98
Used on all heavy duty wide front ends	Knee Extension (Left or Right Hand) 9 5/8" Upright Length, 1 3/4" Upright Diameter	AM7470-1	\$ 368.76

Miscellaneous

Roller Chains and Components

Application	Description	Part Number	Retail Price
Size 40	Chain, 10' Roll	AMX27396	\$ 18.00
	Connecting Link	AMX27419	\$ 0.45
	Offset Link	AMX27420	\$ 0.90
Size 41	Chain, 10' Roll	AMX27397	\$ 14.00
	Connecting Link	AMX27421	\$ 0.60
	Offset Link	AMX27422	\$ 0.90
Size 50	Chain, 10' Roll	AMX27390	\$ 26.00
	Chain, 50' Roll	AMX27331	\$ 90.00
	Connecting Link	AMX27381	\$ 1.25
	Offset Link	AMX27382	\$ 1.75
Size 60	Chain, 10' Roll	AMX27391	\$ 31.00
	Chain, 50' Roll	AMX27332	\$ 115.00
	Connecting Link	AMX27383	\$ 1.50
	Offset Link	AMX27384	\$ 2.00
Size 60 HD	Chain, 50' Roll	AMX27338	\$ 210.00
	Connecting Link	AMX27385	\$ 2.25
	Offset Link	AMX27386	\$ 3.00
Universal Combines	Idler Sprocket 17 Tooth, 1/2" Bore	IS5017-1/2	\$ 16.00
	Idler Sprocket 17 Tooth, 5/8" Bore	IS5017-5/8	\$ 21.00

Drivelines

Driveline by Application	Driveline by Assembly	Description	Part Number	Retail Price
Finishing Mowers: King Kutter® FM48, FM60, FM72, Rotary Cutters: King Kutter® L60-HD, L72 RD, P60-HD, P72 RD, Rhino® SE4, SE5, Woods® 60		Economy Rotary Cutter Driveline	AM14006442	\$ 205.00
Post Hole Diggers: Bush Hog® 2102, 2103, Land Pride® PD25, PD35, Rhino® SPHD		Post Hole Digger Driveline	AM14006453	\$ 229.00
	Rotary Cutters: Bondioli & Pavesi® 100 Series (5')	Economy Rotary Cutter Driveline	AM14006542	\$ 245.00
King Kutter® Finishing Mower: FM48, FM60, FM72, FM84, Kubota® Rotary Cutter: BL348A, B342A	Rotary Cutters: Bondioli & Pavesi® 100 Series (4')	Driveline w/ 1 3/8" 6 Spline QD Yoke	AM14006340	\$ 195.00
Round Balers: Case IH® 8445S, 8455T, Gehl® 1870, Hesston® 555S, 555T, John Deere® 466, 467, 566, 567, Vermeer® 604K - All 1000 RPM		Domestic 80° CV Driveline w/o Implement Yoke	AM14603558	\$ 1225.00
Spreaders: Kuhn® PTO Models, Land Pride® FS1000, FS500, FS700, Lely® and Sitrex® 3-Point Hitch Models	Rotary Cutters: Bondioli & Pavesi® 1000 Series	Driveline w/ 1 3/8" 6 Spline QD Yoke	AM14006127	\$ 116.00
Round Balers: Case IH® 8445S, 8455T, Gehl® 1870, Hesston® 555S, 555T, John Deere® 466, 467, 566, 567, Vermeer® 604K - All 540 RPM		Domestic 80° CV Driveline w/ 1 3/8" 6 Spline Tractor Yoke w/o Implement Yoke 48" Center-to-Center Replaces 87526444	AM14503558	\$ 1220.00
Rotary Cutters: Bush Hog® SQ7, SQ72, SQ84, 12, 305, 306, John Deere® 603, 613, 616, 717, King Cutters® L60-HD, L72 RD, P60-HD, P72 RD, Kubota® LM378, L360, L366, Land Pride® 25-34-50, Rotor Tillers: Bush Hog® RTH, Maletti® KZ80 Series		Driveline w/ 7" Shear Pin	AM14406639	\$ 485.00

Miscellaneous

Driveline by Application	Driveline by Assembly	Description	Part Number	Retail Price
Rotary Cutters: Bush Hog® SQ7, SQ72, SQ84, 12, 305, 306, John Deere® 603, 613, 616, 717, King Cutters® L60-HD, L72 RD, P60-HD, P72 RD, Kubota® LM378, L360, L366, Land Pride® 25-34-50, Rotor Tillers: Bush Hog® RTH, Maletti® KZ80 Series		Driveline, w/ 7" Friction Clutch	AM14106546	\$ 409.00
	Walterscheid® W Series 2400	Driveline w/ 1 3/8" 6 Spline QD Yoke	AM14006546	\$ 253.00
	Rotary Cutter: Bondioli & Pavesi® 100 Series (4' and 5')	Economy Rotary Cutter Driveline	AM14006432	\$ 202.00
Case IH® 1010, 1020 Headers - 22.5', 22' & 30'		Driveline	AM14007661SP	\$ 642.00
Case IH® Cutting Platforms: 1010, 1015, 1020		Driveshaft U-Joint 23.80 mm x 61.30 mm, w/ External Snap Ring Grease Zerk Located Under Caps Replaces BP412020004	AM1330586C1	\$ 59.58
John Deere® Platforms Using 2 Drivelines - 35" Long		Driveline w/ 1 3/8" 21 Spline Combine Yoke 1 1/8" Hex Yoke	AM14007635	\$ 387.00
John Deere® Round Balers: 466, 467, 566, 567		Driveline w/ 1 3/8" 6 Spline Tractor Yoke 1 3/8" 6 Spline Clutch Yoke, 540 RPM Replaces AE74295SPL	AM14503500	\$ 1284.34
John Deere® Round Balers: 466, 467, 566, 577		Driveline w/ 1 3/8" 21 Spline Tractor Yoke 1 3/8" 6 Spline Clutch Yoke, 1000 RPM	AM14603500	\$ 1920.00
John Deere® Round Balers: 435, 446, 456, 457 BSN 311101, 457S BSN 310501, 466, (467, 467S BSN 312600), 535, 546, 547, 556, 557 BSN 313951, 566, 567 BSN 314451		Tractor Half CV Driveline w/ Male Shaft 80° CV Driveline w/ 1 3/8" 21 Spline Tractor Yoke 35/44 Series, 1000 RPM Fits 1 11/16" 20 Spline Shaft Replaces 19603521, AE59638, AE74295	AMAFH217180	\$ 835.00
John Deere® Round Balers: 435, 447, 457 BSN 311001, 466, 467 BSN 312601, 535, 547 BSN 313851, 557 BSN 313951, 566, 567 BSN 314451		Tractor Half CV Driveline w/ Male Shaft 80° CV Driveline w/ 1 3/8" 6 Spline Tractor Yoke 35/44 Series Fits 1 11/16" 20 Spline Shaft 27" Shaft Length w/ Plastic Guard	AMAFH217179	\$ 885.36
John Deere® Round Balers: 447, 448, 457*, 467*, 547*, 557*, 567* *Verify correct spline before ordering, these models were originally equipped to accept either the large 1 11/16" spline or the smaller 1 5/16" spline		Tractor Half CV Driveline w/ Female Tube w/ 1 3/8" 6 Spline Tractor Yoke Cat 5, 35 Series, 540 RPM Fits 1 11/16" Spline Shaft Replaces AE73356	AM92-14503559	\$ 958.00
John Deere® Round Balers: 447, 449, 457, 458*, 458S, 459*, 467, 468*, 469, 547, 557*, 558, 559, 567, 568, 569 *Verify correct spline before ordering, these models were originally equipped to accept either the large 1 11/16" spline or the smaller 1 5/16" spline		Tractor Half CV Driveline w/ Female Tube w/ 1 3/8" 6 Spline Tractor Yoke Cat 4, 540 RPM Fits 1 5/16" Spline Shaft Replaces AFH21388	AM92-14558659	\$ 840.00
John Deere® Round Balers: 447 ASN 310001, 457 ASN 311101, 457S ASN 310501, 467 ASN 312601, 467S ASN 312101, 468 ASN 342250, 547 ASN 313851, 567 ASN 314451, 568 ASN 342250		Driveline w/ Female Tube w/ 1/38" 21 Spline Tractor Yoke Cat 5, 35 Series, 1000 RPM Ref# AE73350, AE74042	AM92-14603559	\$ 928.00
John Deere® Round Balers: 447, 457*, 468*, 468S*, 469*, 547, 557*, 568*, 569* *Verify correct spline before ordering, these models were originally equipped to accept either the large 1 11/16" spline or the smaller 1 5/16" spline		Tractor Half CV Driveline w/ Female Tube w/ 1 3/8" 21 Spline Tractor Yoke Cat 4, 1000 RPM Fits 1 5/16" Spline Shaft Replaces AE74691, AFH207723	AM92-14658659	\$ 844.00

Miscellaneous

Driveline by Application	Driveline by Assembly	Description	Part Number	Retail Price
John Deere® Round Baler: 448 540 RPM w/ Shearbolt Clutch		CV Center Housing Replaces CC27151	AMW384517	\$ 394.84
Swathers: Case IH®: 8312, Hesston®: 1340, 1345, Massey Ferguson®: PTD12		Double CV Driveline w/ 1 3/8" 21 Spline QD Tractor Yoke w/ 1 1/2" Round w/ 3/8" K-Way Machine End 1000 RPM	AM14656849	\$ 1440.00
Swathers: Case IH®: DC132, New Holland®: 1431		Double CV Driveline w/ 1 3/8" 21 Spline QD Tractor Yoke w/ 1 1/2" 23 Spline Machine End 1000 RPM	AM14656853	\$ 1715.00
Swathers: Case IH®: DC132, New Holland®: 1431		Double CV Driveline w/ 1 3/4" 20 Spline QD Tractor Yoke w/ 1 1/2" 23 Spline Machine End	AM14756853	\$ 1715.00

Drive Shafts

Driveline by Application	Driveline by Assembly	Description	Part Number	Retail Price
John Deere® Cornheads: 493, 592, 594, 692, 693, 694, 892, 893, 894, 1092, 1290, 1291, 1293, Platforms: 918, 920, 925D, 930D, 936D, Row Crop Heads: 50A Series	Walterscheid® W Series 2400	Contour Master Header Drive Shaft Replaces AH155077, AH220096	AM14007631	\$ 432.00
John Deere® Round Balers: 435, 446, (447, 457S BSN 3105000), 456, 457 BSN 3100000, 466, (467, 467S BSN 312600), 535, 546, (547, 557 BSN 313850), 556, 566, 567 BSN 314450		Front Half CV Drive Shaft w/ Male Shaft Cat 5, 35 Series, 540 RPM Replaces AE59635, AE74294	AM19503506	\$ 835.00
Woods® Rotary Cutters: 3180, 3240	Tractor Half CV Driveline: Walterscheid® WWE Series 2580	Complete CV Tractor Half Drive Shaft	AM93-14607951	\$ 935.00
Case IH® Combine: 1420, 1440, 1460, 1470, 1480, 1482, 1620, 1640, 1644, 1660, 1666, 1670, 1680, 1682, 1688, 2144, 2166, 2188, 2344, 2366, 2377, 2388, Header Platforms: 853A, 854A, 453A, Header Auger 454A, 1253A Header, Row Crop Headers: 653A, 654A, 655A, Walterscheid® W Series: 2400	Walterscheid® W Series 2400	Header Drive Shaft w/ 1 1/8" Hex End Yoke 35" Long Replaces 100952A1	AM14007633	\$ 432.00
John Deere® Rotary Cutters: 1517, 1518, 2018 w/o Offset Shear Bolt Clutch	Walterscheid® WWE Series 2580	Complete CV Drive Shaft w/ 1 3/8" x 6 Spline Tractor Yoke w/ 1 3/4" x 20 Spline Implement Yoke with Clamp w/o Offset Shearbolt Clutch Replaces 14517955, BW15803	AM14516855	\$ 1290.00
John Deere® Rotary Cutters: 1517, 1518, 2018, CX15, HX15, HX20	CV Driveline Assembly: Walterscheid® WWE Series 2580	Complete CV Drive Shaft w/ 1 3/4" x 20 Spline Tractor Yoke w/ 1 3/4" x 20 Spline Implement Yoke w/ Clamp w/o Offset Shearbolt Clutch Replaces BW15805	AM14716855	\$ 1290.00
Universal Fertilizer Spreader		Drive Shaft	AM14000620	\$ 232.00

Pickup Platform Belts

Application	Description	Part Number	Retail Price
AgriSteel® 3026A, John Deere® 60, 80	Pickup Belt, 20" x 50.75" Belt Only	AMAH62101	\$ 93.64
AgriSteel® 3026A, John Deere® 60, 80	Pickup Belt w/ Teeth, 20" x 50.75" 36 Tooth	AMAP22087	\$ 175.76
Case IH® 403, 503, 1015	Pickup Belt, 21.75" x 60.13" Belt Only	AM1316715C91	\$ 93.81

Miscellaneous

Application	Description	Part Number	Retail Price
Case IH® 403, 503, 1015	Pickup Belt w/ Teeth 21.75" x 60.13" 60 Tooth	AM1977190C1	\$ 206.30
Case IH® 810, 820, 914	Pickup Belt, 21.75" x 56.75" Belt Only	AM185528C93	\$ 101.22
Case IH® 810, 820, 914	Pickup Belt w/ Teeth, 21.75" x 56.75" 56 Tooth	AM185527C92	\$ 185.53
Case IH® 2015, 2016, New Holland® 75C, 76C	Front Pickup Belt w/ Teeth, 18.75" x 57.75" 42 Tooth	AM84229338	\$ 182.00
Case IH® 2015, 2016, SwathMaster® Newer Models	Front Pickup Belt, 18.75" x 57.75" w/ 1/4" Cleats, Bolt-On w/ Holes	AM84229342	\$ 88.99
Gleaner® 420, 4000, 4200, Case IH® 2015, 2016, New Holland® 75C, 76C, Massey Ferguson® 4200, 9720, Rake-Up® Older Models, SwathMaster® Older Models	Rear Pickup Belt, 18.75" x 57.75" w/ 1/4" Cleats, Bolt-On	AM31-100100-20	\$ 85.78
Gleaner® 60, 66	Upper Pickup Belt, 59.50" x 54" Rubber Cleats, Belt Only	AM525868	\$ 177.85
Gleaner® 60, 66	Lower Pickup Belt, 59.50" x 152" Rubber Cleats, Belt Only	AM525867	\$ 373.74
John Deere® 60, 88, Renn® 970	Pickup Belt, 22" x 50.75" 2 Roller, Belt Only	AMAH64826	\$ 89.54
John Deere® 60, 88, Renn® 970	Pickup Belt w/ Teeth, 22" x 50.75" 42 Tooth, 2 Roller	AMAH64825	\$ 197.32
John Deere® 615P	Front Pickup Belt, 44.48" x 57.30" w/ 0.375" Cleats, Bolt-Together Splice	AMH218051	\$ 227.64
John Deere® 615P	Front Pickup Belt w/ Teeth, 44.48" x 57.30" w/ 0.375" Cleats, Bolt-Together Splice	AMAH217737	\$ 375.00
John Deere®: 200, 212, 214, 615P, 912, 914, 914P	Teeth for Pickup Belt Package of 50 Replaces 1000349	AMH86248	\$ 60.00
John Deere® 615P	Pickup - Belt 44.48" x 57.30" Single V-Guide	AMAH218051	\$ 353.00
Massey Ferguson® MF67, Renn® 990, 992	Pickup Belt, 22" x 65.75" Belt Only	AM144-0905	\$ 101.83
Massey Ferguson® MF67, Renn® 990, 992	Pickup Belt w/ Teeth, 22" x 65.75" 70 Tooth (Not Installed)	AM144-0905WT	\$ 234.37
Melroe® 350, 351, 378, 388, 395	Front Conversion Pickup Belt, 17.75" x 45" w/o Teeth, w/ Holes	AM6528784	\$ 94.89
Melroe® 350, 351, 378, 388, 395	Rear Pickup Belt, 17.75" x 27.35"	AMPU17.75X27BO	\$ 50.06
Rake-Up® Older Models, SwathMaster® Older Models	Rear Pickup Belt, 18.75" x 56.25" w/ 1/4" Cleats Includes Pin and Lacing	AM311010001	\$ 105.74
Rake-Up® Newer Models, SwathMaster® Newer Models	Front Pickup Belt, 18.75" x 56.25" w/ 1/4" Cleats Includes Pin and Lacing	AM311010005	\$ 110.19
White® Most Models	Pickup Belt, 23.62" x 50.50" Belt Only	AM2730570	\$ 94.46
White® Most Models	Pickup Belt w/ Teeth, 23.62" x 50.50" 48 Tooth	AM2730570WT	\$ 220.00
Victory® Most Models	Front Pickup Belt, 17.50" x 53.50" w/ 0.53" Cleats	AM720010	\$ 78.78
Victory® Most Models	Rear Pickup Belt, 17.50" x 44.25" Belt Only	AM01300110002	\$ 69.90
Victory® Super Series	Front Pickup Belt, 17.50" x 44.25" w/ Holes	AM01290110001	\$ 70.36
Victory® Super Series	Rear Pickup Belt, 17.50" x 53.50" w/ 0.53" Cleats	AM01300511003	\$ 78.87

Allis Chalmers®—Tractor

Table of Contents

Air Cleaner Components	296	Mufflers and Exhaust.....	294
Air Conditioning and Components.....	308	Oil Pumps, Engine.....	286
Battery Boxes and Components.....	302	Overhaul Kits.....	284
Belts.....	290	PTO Adapters.....	300
Brakes and Components.....	301	PTO Shafts and Components.....	300
Camshafts and Lifters.....	285	Quick Hitches.....	301
Carburetors.....	291	Radiator Hoses.....	287
Connecting Rods.....	285	Radiators.....	287
Crankshaft Damper Pulleys.....	285	Shop Manuals and Collections.....	312
Crankshafts.....	285	Spindles.....	297
Cylinder Heads, Bare.....	286	Starters.....	296
Drawbars and Components.....	301	Steering Arms.....	299
Flywheel Components.....	289	Tachometers and Gauges.....	297
Fuel Lift Pumps.....	291	Three Point Hitch Components.....	302
Glass.....	307	Tie Rods and Components.....	297
Hydraulic Oil Coolers.....	300	Transmission Input Shafts.....	300
Hydraulic Pumps.....	300	Turbochargers.....	293
Injection Pumps.....	291	Water Pumps.....	289
Injectors.....	293	Wheel Bearing Kits.....	299
Lighting.....	302	Wheel Hubs and Components.....	298
Manifolds and Components.....	294		



Overhaul Kits

Application	Description		Retail Price	Core
D10 BSN 3501, D12 BSN 3001, D14, D15 Early	G138 and G149 Engine - Gas	Inframe Kit	\$ 616.00	
		Overhaul Kit	\$ 670.00	
D15	D175 Engine - Diesel	Inframe Kit	\$ 1002.00	
		Overhaul Kit	\$ 1190.00	
WC, WD, WF	W201 Engine - Gas	Inframe Kit	\$ 577.00	
		Overhaul Kit	\$ 507.00	
D17, 170, 175, Combine: E	G226 Engine - Gas	Inframe Kit	\$ 524.00	
		Overhaul Kit	\$ 514.00	
WD45	W226 Engine - Gas	Inframe Kit	\$ 477.00	
		Overhaul Kit	\$ 496.00	
6060, 6070, 6080, Combines: F2, F3	D433 and DT433 Engine - Diesel	Inframe Kit	\$ 812.00	
		Overhaul Kit	\$ 888.00	
180, 185, 190, 190XT, 200, 7000, Combines: F, G	D2900 and DT2900 Engine - Diesel	Inframe Kit	\$ 997.00	
		Overhaul Kit	\$ 1054.00	
7010, 7020, 8010, Combines: L, L2, M, M2	D2900 and DT2900 Engine - Diesel	Inframe Kit	\$ 973.00	
		Overhaul Kit	\$ 1120.00	

Allis Chalmers®—Tractor

Application	Description		Retail Price	Core
210, 220, 7030, 7040, 7045, 7050, 7060, 7080, 7580, D21, Combines: L, L2, L3, M, M2, M3, MH	D3500 and D3750 Engine - Diesel	Inframe Kit	\$ 1259.00	
		Overhaul Kit	\$ 1450.00	
8030, 8050, 8070, 4WD: 4W-220, Combines: N5, N6, R5, R6	670HI Engine - Diesel	Inframe Kit	\$ 1214.00	
		Overhaul Kit	\$ 1522.00	

Crankshafts



Application	Description	Part Number	Retail Price	Core
160, 6040	Crankshaft AD3.152 Engine Splined Snout	AM31312437	\$ 534.79	
D10, D12, D14, D15	Crankshaft	AM70240921	\$ 560.00	
Super 100, (170, 175, WD45 - w/ Gas) W226 Replaces 70213353, 70226526, 70229022, 70241291, U-3986	Crankshaft G226 226 CID 4 Cylinder Engine 4.50" Stroke, 4" - 4.001" Bore, 2.374" - 2.375" Rod, 2.435" - 2.4365" Front Main Journal, 2.477" - 2.478" Center Main Journal, 2.477" - 2.478" Rear Main Journal Flange - 4 Bolt Holes Snout - 1 Keyway	AM70226535	\$ 575.00	

Connecting Rods

All connecting rods are cleaned and inspected for defects prior to remanufacturing. Rods are then shot-peened for stress relief and the size is checked against OEM specifications. New piston pin bushings are installed in each rod and bored to the correct center-to-center dimensions. The center-to-center dimension greatly affects the performance of your engine and is a step that many remanufacturers ignore. Final assembly of our connecting rods include installation of new rod bolts and verifying product dimensions, including bend and twist, one final time.



Application	Description	Part Number	Retail Price	Core
180, 185, 190, 6060, 6080 - w/ Gas or Diesel	Reman Connecting Rod Cast # - 4020888	AMCR4020888-R	\$ 150.00	\$ 40.00
7030, 7040, 7045, 7050, 7060, D21	Reman Connecting Rod 1.50" Pin Diameter	AMCR3500S-R	\$ 175.00	\$ 60.00
7080, 7580, 8030, 8050, 8070, 4WD: 4W-220, Combine: N6	Reman Connecting Rod 1.75" Pin Diameter	AMCR3500L-R	\$ 255.00	\$ 80.00
685, N7	Reman Connecting Rod Cast # - 4322089	AMCR4322089-R	\$ 225.00	\$ 70.00

Crankshaft Damper Pulleys

Application	Description	Part Number	Retail Price	Core
7000, 7010, 7020, 8010	Crankshaft Damper Pulley Replaces 74007157	AM74009848	\$ 645.01	
8775, 8785, RT95, RT115, RT130 - w/ 6BT, 6B5.9L, 6BT5.9L or 6BTA5.9L Engine	Crankshaft Damper Pulley 0.753" ID, 8.22" OD, 2.10" Thick Replaces 3914454, J911422, J914454	AMJ958258	\$ 120.00	

Camshafts and Lifters



Application	Description	Part Number	Retail Price	Core
180, 185, 190, 190XT, F, L, L2, M, M2 - w/ Early D2900 Engines	Camshaft Timing gear is held on by a full 1/2 moon key	AM74027150	\$ 290.00	
180, 185, 190, 190XT, 200, 7000, 7010, 7020, 8010, Combines: F, F2, L, L2, M, M2, M3 - All w/ Late 2900 Engine	Camshaft Timing gear is held on by 1/2 of a 1/2 moon key	AM74023915	\$ 295.00	

Prices Subject to Change without Prior Notice. The use of original equipment manufacturer (OEM) part numbers or trademarks, e.g. Case® and John Deere®, are for reference purposes only and for indicating product use and compatibility. Our company and the listed replacement parts contained herein are not sponsored, approved or manufactured by the OEM. All parts are New unless designated Reman in the description.

Allis Chalmers®—Tractor

Application	Description	Part Number	Retail Price	Core
7030, 7040, 7045, 7050, 7060, 7080, 7580, 8030, 8050, 8070, 4WD: 4W-220, Combine: L, L3, M, M2, M3, N5, N6 - All w/ D3500 or 670 Engine	Camshaft Timing gear is held on by 1/2 of a 1/2 moon key	AM74029000	\$ 275.00	
All D2900 or D3500 Engines	Lifter	AM74026699	\$ 8.00	
160, 6040	Lifter w/o Adjusting Screw Replaces 957E6489, 731150M1, 731150V1, 860012, 81804255	AM0860012	\$ 4.65	

Cylinder Heads, Bare

Our remanufactured cylinder heads are cleaned, pressure-tested and resurfaced. New seats and guides are installed using OEM specifications. These heads are ready for final assembly.



Application	Description	Part Number	Retail Price	Core
D14 Gas	Reman Cylinder Head, Bare Cast # - 4367, 4859	AMCHAC138B	\$ 650.00	\$ 100.00
D15 Gas	Reman Cylinder Head, Bare Cast # - 5481, 4831, 5253	AMCHAC149B	\$ 650.00	\$ 100.00
D17 Diesel	Reman Cylinder Head, Bare Cast # - 4507716	AMCHAC262-D1B	\$ 850.00	\$ 100.00
D19 Diesel	Reman Cylinder Head, Bare Cast # - 4514790, 4514282, 4512284, 4516673, 4516681	AMCHAC262-D2B	\$ 850.00	\$ 100.00
D19 Gas	Reman Cylinder Head, Bare Cast # - 4512116, 4508570, 4508674, 4506583	AMCHAC262-GB	\$ 850.00	\$ 100.00
6060, 6070, 6080 - w/ 433 Diesel Engine	Reman Cylinder Head, Bare	AMCHAC433B	\$ 1100.00	\$ 100.00
190, 190XT, 200D	Reman Cylinder Head, Bare Closed on both ends Cast # - 4023894, 4021854, 4020683	AMCHAC2900-3B	\$ 1575.00	\$ 100.00
7010, 7020, 8010	Reman Cylinder Head, Bare Open on one end	AMCHAC2900-1B	\$ 1575.00	\$ 100.00
7010, 7020, 8010	Reman Cylinder Head, Bare Open on both ends	AMCHAC2900-2B	\$ 1575.00	\$ 100.00
D21 w/ 3500 Diesel Engine	Reman Cylinder Head, Bare Cast # - 4358374, 4026227, 4025002	AMCHAC3500-1B	\$ 1575.00	\$ 100.00
7030, 7040, 7045, 7050, 7060, 7080	Reman Cylinder Head, Bare Cast # - 4035246, 4029163, 4028163	AMCHAC3500-2B	\$ 1575.00	\$ 100.00
7050, 7060, 8030, 8050, 8070	Reman Cylinder Head, Bare Cast # - 4035246, 4036660, 4035180, 4029280	AMCHAC670B	\$ 1575.00	\$ 100.00
8550 Diesel	Reman Cylinder Head, Bare Cast # - 4393570, 4394445	AMCHAC6120B	\$ 1575.00	\$ 100.00
8010, Combine: L, M	Reman Cylinder Head, Bare Open on both ends, side thermostat	AMCHAC2900-4B	\$ 1575.00	\$ 100.00
N7	Reman Cylinder Head, Bare	AMCHAC685B	\$ 1100.00	\$ 100.00

Oil Pumps, Engine

All of our remanufactured engine oil pumps are disassembled, thoroughly cleaned and inspected. All worn parts are replaced and tolerances are checked to guarantee our oil pumps will perform to OEM specifications. The pump is reassembled and - as a safety measure - each pump is lubricated with Clevite Bearing Guard to ensure there is no damage during initial start up. Replacing the engine oil pump during an overhaul is a step many people overlook.



Application	Description	Part Number	Retail Price	Core
160, 6040	Engine Oil Pump Idler Gear Not Included Replaces 72080189, 78014150	AM41314078	\$ 50.00	

Allis Chalmers®—Tractor

Application	Description	Part Number	Retail Price	Core
180, 185, 190, 190XT	Reman Engine Oil Pump Cam Driven, Bolt-On Oil Pickup Tube	AM74022735-R	\$ 495.00	\$ 50.00
	Reman Engine Oil Pump Camshaft Driven, Pickup Screen Attaches w/ Wire Retainer	AM74022735E-R	\$ 495.00	\$ 50.00
180, 185, 190, 190XT, 200	Reman Engine Oil Pump Crank Driven	AM74008219-R	\$ 475.00	\$ 50.00
210, 220, 7030, 7040, 7050, 7060, 7080 - w/ D3500 Diesel Engine	Reman Engine Oil Pump Early Style Crank Driven	AM74036125-R	\$ 575.00	\$ 50.00
7030, 7040, 7045, 7050, 7060, 7080, 7580, 8030, 8050, 8070, 4WD: 4W-220 - All w/ D3500 Diesel Engine	Reman Engine Oil Pump Crank Driven	AM74036849-R	\$ 575.00	\$ 100.00
L2, L3, N5, N6 - w/ D3500/670 Diesel Engine	Reman Engine Oil Pump Crank Driven, Dual Gear	AM74035898-R	\$ 575.00	\$ 100.00



Radiators

Application	Description	Part Number	Retail Price	Core
190, 190XT	Radiator Overall: 24" x 23" x 3 1/4", 5 Rows, 7 Fins per Inch	AM70250729	\$ 550.00	
200	Radiator	AM70256351	\$ 620.00	
7030, 7040, 7045, 7050, 7060 BSN 6001	Radiator w/ Oil Cooler	AM70269240	\$ 1230.00	
B, C, CA, D10, D12	Radiator	AM70233232	\$ 185.00	
D17 Gas & LP	Radiator Overall: 19 1/4" x 24 1/4" Core: 18" x 19 1/4" x 2" 3 Rows, 7 Fins per Inch Overall Height Does Not Include Fill Neck	AM70229702	\$ 510.00	
WC, WD, WD45 - w/ Gas	Radiator	AM70228587	\$ 225.00	



Radiator Hoses

Application	Description	Part Number	Retail Price	Core
(170, 175 - w/ Gas Engine)	Radiator Hose, Upper 1.50" ID	AM70249759	\$ 22.20	
(170, 175 - w/ Diesel Engine)	Radiator Hose, Upper 1.875" ID	AM70249755	\$ 9.14	
180, 185, 190, 190XT, 190XT-III	Radiator Hose, Upper 1.75" & 2.125" ID Replaces 70243014V	AM70243014	\$ 16.25	
200	Radiator Hose, Upper 1.75" & 2.125" ID	AM70256331	\$ 14.96	
5015	Radiator Hose, Upper 1.08" ID	AM72100735	\$ 17.89	
5020	Radiator Hose, Upper 1.25" ID Replaces 3280168M1	AM72097704	\$ 18.56	
5030	Radiator Hose, Upper 1.375" ID	AM72098549	\$ 15.88	
5040, 5045, 5050	Radiator Hose, Upper 1.75" ID Replaces 677214A, 4950088	AM72089692	\$ 16.28	

Allis Chalmers®—Tractor

Application	Description	Part Number	Retail Price	Core
5220 w/ Synchro Transmission	Radiator Hose, Upper 1.062" & 1.25" ID	AM72102630	\$ 13.49	
6060, 6070, 6080	Radiator Hose, Upper 2.125" ID	AM70263406	\$ 21.66	
6140	Radiator Hose, Upper 1.34" & 1.437" ID	AM72099478	\$ 26.08	
7000	Radiator Hose, Upper 2.125" ID	AM70260327	\$ 33.61	
7010, 7020	Radiator Hose, Upper 2.25" & 2.50" ID	AM70262102	\$ 27.74	
7030, 7040, 7045, 7050, 7060, 7080, 7580	Radiator Hose, Upper 2.375" & 2.25" ID	AM70267816	\$ 28.29	
8010	Radiator Hose, Upper 2.312" & 2.40" ID	AM70276094	\$ 29.93	
8030, 8050 Early, 8070	Radiator Hose, Upper 2.312" & 2.375" ID	AM70276095	\$ 35.72	
D10, D12	Radiator Hose, Upper 1.203" ID	AM70231965	\$ 11.53	
D14	Radiator Hose, Upper 1.25" ID	AM70227889	\$ 11.58	
D15 Gas	Radiator Hose, Upper 1.25" ID	AM70233430	\$ 14.23	
D17 Gas	Radiator Hose, Upper 1.50" ID	AM70229636	\$ 12.13	
(D17 BSN 38963, WD45 - Diesel)	Radiator Hose, Upper 1.812" ID	AM70226893	\$ 5.36	
(D17 ASN 38964, D19 w/ 15/16" Filler Neck - Diesel)	Radiator Hose, Upper 1.75" ID	AM70235361	\$ 19.59	
D19 Gas	Radiator Hose, Upper 1.75" ID	AM70236594	\$ 19.18	
WC Engine ASN 98779, WD w/ Gas Engine BSN 289000, WF Engine BSN 289000	Radiator Hose, Upper 1.25" ID	AM70233153	\$ 7.94	
160	Radiator Hose, Lower 1.375" & 1.50" ID	AM72073294	\$ 22.34	
(170, 175 Gas)	Radiator Hose, Lower 1.50" ID	AM70249760	\$ 14.04	
(170, 175 Diesel)	Radiator Hose, Lower 1.50" ID	AM70249756	\$ 22.30	
180, 185, (190 190XT-III ASN 14450), 190XT	Radiator Hose, Lower 1.75" & 2.187" ID Replaces 70248233V	AM70248233	\$ 14.40	
190 BSN 14449, 190XT, 190XT-III BSN 14450	Radiator Hose, Lower 1.69", 2.125" ID Replaces 70243015V	AM70243015	\$ 14.92	
200	Radiator Hose, Lower 1.75", 2.125" ID	AM70256374	\$ 17.33	
5015	Radiator Hose, Lower 1.08" ID	AM72100734	\$ 22.74	
5020	Radiator Hose, Lower 1.312" ID Replaces 3280167M1	AM72097702	\$ 18.14	
5030	Radiator Hose, Lower 1.25" ID Replaces 3280650M1	AM72098630	\$ 20.67	
5040, 5045, 5050	Radiator Hose, Lower 1.437" ID	AM72089314	\$ 8.42	

Allis Chalmers®—Tractor

Application	Description	Part Number	Retail Price	Core
5220 w/ Hydrostatic Transmission	Radiator Hose, Lower 1.08" ID	AM72104395	\$ 20.03	
6060, 6070, 6080	Radiator Hose, Lower 2.312" ID	AM70263407	\$ 26.96	
7000	Radiator Hose, Lower 2.125" & 2.375" ID	AM70260326	\$ 28.94	
7030, 7040, 7045, 7050, 7060	Radiator Hose, Lower 2.25" & 2.375" ID	AM70267817	\$ 15.27	
7080, 8050 Late, 8070	Radiator Hose, Lower 2.250" & 2.375" ID	AM70268974	\$ 22.49	
8010	Radiator Hose, Lower 2.25" & 2.625" ID	AM70264171	\$ 55.27	
8030, 8050 Early	Radiator Hose, Lower 2.25" & 2.375" ID	AM70273688	\$ 15.15	
D15 Gas	Radiator Hose, Lower 1.25" ID	AM70233431	\$ 14.04	
D17 Gas	Radiator Hose, Lower 1.50" ID	AM70229209	\$ 12.51	
D17 Diesel BSN 38963	Radiator Hose, Lower 1.25" ID	AM70233153	\$ 7.94	
D17 Diesel ASN 38964, D19 Gas	Radiator Hose, Lower 1.50" & 1.75" ID	AM70235356	\$ 19.63	
D19 Diesel	Radiator Hose, Lower 1.562" & 1.812" ID	AM70236836	\$ 26.24	
B, C, CA, D10, D12, D14	Radiator Hose, Lower 1.25" ID	AM70207173	\$ 2.01	
WC, WD, WD45 Gas, WF	Radiator Hose, Lower 1.532" ID Replaces 1206-0009, 180085M1	AM70203090	\$ 8.92	
WD45 Diesel	Radiator Hose, Lower 1.50" ID	AM70227176	\$ 12.62	

Flywheel Components

Application	Description	Part Number	Retail Price	Core
D10 ASN 3501, D12 ASN 3001, D14 ASN19001, D15	Flywheel Ring Gear 116 Tooth, 10.865" ID, 11.785" OD	AM70233196	\$ 46.53	

Water Pumps

The remanufactured water pumps we supply have an extra step added to the remanufacturing process to ensure quality. Since the bearing and seal assembly are critical in performance, we ensure air-tight seals by vacuum testing our water pumps prior to packaging. This guarantees no leakage will occur after your water pump has been installed.



Application	Description	Part Number	Retail Price	Core
170, 175 - w/ Perkins® Diesel	Water Pump Cast # - 37711630	AM3641832M91	\$ 45.00	
170, D17, Combines: E, E3 - All w/ Gas	Reman Water Pump Cast # - 129433 w/ 7/8" hole	AM79003710	\$ 105.00	\$ 25.00
180, 185, 190, 190XT, D21 - w/ Gas or Diesel	Water Pump Cast # - 4029129-04 w/ 7/8" hole	AM74007554	\$ 96.50	
200, 210, 220, 7000	Reman Water Pump Cast # - 4029129-04 w/ 15/16" hole	AM74008840	\$ 112.00	\$ 25.00
5020, 5215, 5220	Water Pump Includes Mounting Gasket Replaces 72103891	AM3284086M92	\$ 84.00	

Prices Subject to Change without Prior Notice. The use of original equipment manufacturer (OEM) part numbers or trademarks, e.g. Case® and John Deere®, are for reference purposes only and for indicating product use and compatibility. Our company and the listed replacement parts contained herein are not sponsored, approved or manufactured by the OEM. All parts are New unless designated Reman in the description.

Allis Chalmers®—Tractor

Application	Description	Part Number	Retail Price	Core
5040, 5045, 5050	Water Pump	AM93191101	\$ 90.00	
6060, 6070, 6080, Combines: F2 Diesel ASN 39201 w/ D433 Engine, (F3 Diesel, K2 - Diesel w/ D433 Engine)	Reman Water Pump Cast # - 4007925	AM74009278	\$ 135.00	\$ 30.00
7010, 7020, 8010, Combines: L2, M2 Diesel w/ 649I Engine	Reman Water Pump Cast # - 4008611-02	AM74062321	\$ 125.00	\$ 30.00
(7030, 7040, 7045, 7050, 7060, 7080, 7580, 8030, 8050, 8070 - w/ D3500 or 670T Engine), 4WD: 4W-220 w/ D3500 or 670T Engine, Combines: L BSN 13000 w/ D3500 Engine, (L2, L3 ASN 13001), M BSN 15401 w/ D3500 Engine, (M2, M3 ASN 15401), MH2, MH3 w/ 670T or D3500 Engine, N5, N6, R5, R6	Water Pump Cast # - 4036544	AM74036573	\$ 112.50	
8775 ASN J117019, 8785 - w/ GT590 Cummins®	Water Pump 2-Bolt Flange Ref# 72515588	AMJ802970	\$ 55.13	
D17 Diesel Engine BSN 119938	Reman Water Pump Cast # - 126627	AM74516952	\$ 100.00	\$ 50.00
D17 Diesel Engine ASN 119938, D19 Gas w/ Long Filler Neck Radiator	Reman Water Pump Cast # - 134680	AM74516959	\$ 113.00	\$ 25.00
D19 Gas w/ Short Filler Neck Radiator or All Diesel, Combines: (A, A2 SN 397017-408560 w/ Gas), (C, C2 - Gas or Diesel), F BSN 12201 w/Gas	Reman Water Pump Cast # - 134445	AM74516962	\$ 100.00	\$ 25.00
WC, WD, WD45, WF - Gas or LPG	Water Pump	AM79016822	\$ 106.50	
WD45 Diesel	Reman Water Pump Cast # - 126627	AM74516949	\$ 105.00	\$ 30.00
Utility: ST30, ST34A All w/ Cab or ASN RA13834 w/o Cab, ST35, ST35X, ST40, ST40X, ST41A	Water Pump Includes Mounting Gasket Replaces 3757045M92, 3757045M93	AM3757045M91	\$ 100.00	
Combines: F Diesel, F2 Diesel w/ D2800 Engine BSN 39201, G Gas w/ G2800 Engine BSN 17001, G Diesel w/ D2800 Engine, K2 Diesel w/ D2800 Engine BSN 25201, M Diesel w/ D2900 120 HP Engine, M2 Diesel, M3 Diesel w/ 649T Engine	Reman Water Pump Cast # - 4021898	AM74007551	\$ 130.00	\$ 50.00
Combines: L ASN 2D-9660, L2, L3, M ASN 2D-9660, M2, MH ASN 2D-9660, MH2 - w/ D2900 Diesel Engine	Reman Water Pump Cast # - 4007621	AM74007666	\$ 150.00	\$ 50.00
Combines: L, M - w/ D2900 Diesel Engine BSN 2D-96660	Reman Water Pump Cast # - 4006790, 4023476	AM74007550	\$ 145.00	\$ 50.00
Combines: N7, R7	Reman Water Pump	AM74322280	\$ 270.00	\$ 30.00

Belts

Application	Description	Part Number	Retail Price	Core
7000	Fan Belt	AM70260328	\$ 18.05	
7010, 7020	Fan Belt	AM70254350	\$ 16.04	
	A/C Compressor Belt	AM70260149	\$ 24.64	
7030, 7040, 7050, 7060	Fan Belt	AM70267630	\$ 25.00	
	A/C Compressor Belt	AM70268485	\$ 10.00	
7080 BSN 3829, 7580 BSN 2612	Fan Belt	AM70269183	\$ 29.80	
	A/C Compressor Belt	AM70268485	\$ 10.00	
7080 ASN 3829, 7580 ASN 2612	Fan Belt	AM70269183	\$ 29.80	
	A/C Compressor Belt	AM70261802	\$ 9.13	
7650	Belt, Engine Blower	AM72257571	\$ 17.00	
8010	Fan Belt	AM70254350	\$ 16.04	
	A/C Compressor Belt	AM70260149	\$ 24.64	

Allis Chalmers®—Tractor

Application	Description	Part Number	Retail Price	Core
8030 BSN 1907, 8050 BSN 1837, 8070 BSN 1351	Fan Belt	AM70273193	\$ 40.20	
	A/C Compressor Belt	AM70268485	\$ 10.00	
8030 ASN 1907, 8050 ASN 1837, 8070 ASN 1351	Fan Belt	AM70273193	\$ 40.20	
	A/C Compressor Belt	AM70273705	\$ 8.56	
8550 BSN 1636	Fan Belt	AM70259566	\$ 39.09	
	Alt / Gen Belt	AM70259401	\$ 19.00	
	A/C Compressor Belt	AM20-0008475	\$ 9.35	
8550 ASN 1636	Fan Belt	AM70259566	\$ 39.09	
	Alt / Gen Belt	AM70259401	\$ 19.00	
	A/C Compressor Belt	AM70226935	\$ 13.45	
RT110A, RT120A, RT140A, RT155A, RT165A, RT180A	A/C Compressor Belt	AM4286263M1	\$ 22.20	
RT140A, RT155A	Fan Belt	AM378792M1	\$ 17.80	



Carburetors

Application	Description	Part Number	Retail Price	Core
D10, D12, WC, WD	Carburetor, Zenith	AMX82002	\$ 508.00	
D14, D15	Carburetor, Zenith	AMX82003	\$ 456.00	
D17, WD45	Reman Carburetor	AM70222089	\$ 195.00	\$ 100.00



Fuel Lift Pumps

Application	Description	Part Number	Retail Price	Core
160 w/ 3.152 Perkins Engine	Fuel Lift Pump 2-Bolt Mounting, w/ Glass Bowl	AM4222094M91	\$ 31.00	
170 (Engine BSN 236U93188, 248U8332), 175 (Engine BSN 236U93188, 248U8332)	Fuel Lift Pump 2-Bolt Mounting	AM4222104M91	\$ 24.00	
170 (Engine ASN 236U93188, 248U8332), 175 (Engine ASN 236U93188, 248U8332)	Fuel Lift Pump 4-Bolt Mounting, w/o Glass Bowl	AM4222091M91	\$ 33.00	
5040, 5045, 5050	Fuel Lift Pump	AM4757883	\$ 23.00	
Deutz® Engines: 912/913W/T, B/F3-4-5-6L, F3L-812D, F3L-912/912W, F3L-913, F4L-812D, F4L-912/912W, F5L-912/912W, F6L-812D, F6L-912/912W	Fuel Lift Pump Replaces 2239550, 4157603, 4231021	AM4238003	\$ 31.00	
D14, D17, D19	Fuel Strainer Assembly Use w/ 3/8" Standard Pipe Thread Replaces 70237944, AT326991	AMAM3100T	\$ 18.00	

Injection Pumps

All of our injection pumps are disassembled, thoroughly cleaned and inspected. All worn out parts are replaced and the pumps are reassembled with new gaskets. Pumps are tested for leaks and fuel delivery at low idle, high idle, full load, part load and at start up. Any pumps with an automatic advance system has the advance set. As an additional quality check, all pumps are tested with a special oil that will not varnish inside the pump.

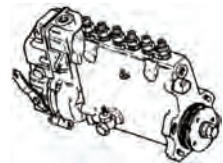

Application	Description	Part Number	Retail Price	Core
D21	Reman Injection Pump Roosa Master, Mfg # DCGFC629-2AG, 47AG, 25AG	AMPD21-DCGFC	\$ 1050.00	\$ 300.00

Allis Chalmers®—Tractor

Application	Description	Part Number	Retail Price	Core
180	Reman Injection Pump Roosa Master, Mfg # DBGFC637-75AF, 5JN	AMP180-DBGFC	\$ 1250.00	\$ 200.00
185	Reman Injection Pump Roosa Master, Mfg # DBGFC637-76AF, 4JN	AMP185-DBGFC	\$ 1250.00	\$ 200.00
190	Reman Injection Pump Roosa Master, Mfg # DBGFC637-13AF, 48AF, 51AF, 54AF	AMP190-DBGFC	\$ 975.00	\$ 300.00
190XT	Reman Injection Pump Roosa Master, Mfg # DBGFC637-9GR, 31AF, 49AF, 52AF	AMP190XT-DBGFC	\$ 975.00	\$ 300.00
200	Reman Injection Pump Roosa Master, Mfg # DBGFC637-3JN, 7JN, 10JN, 11GR	AMP200-DBGFC	\$ 975.00	\$ 300.00
210	Reman Injection Pump Roosa Master, Mfg # DCGFC631-16GR, 20GR, 1JN, 9JN	AMP210-DCGFC	\$ 1050.00	\$ 300.00
220	Reman Injection Pump Roosa Master, Mfg # DCGFC631-5GR, 19GR, 3JN, 10JN, 1AF	AMP220-DCGFC	\$ 1050.00	\$ 300.00
6060	Reman Injection Pump Roosa Master, Mfg # DB2437 JT3836	AMP6060-DB	\$ 1100.00	\$ 200.00
6080	Reman Injection Pump Roosa Master, Mfg # DB2437 JT3837	AMP6080-DB	\$ 1100.00	\$ 200.00
7000	Reman Injection Pump Roosa Master, Mfg # DM4629 ME2918	AMP7000-DM	\$ 1250.00	\$ 300.00
7010	Reman Injection Pump Roosa Master, Mfg # DM4629 ABA4035	AMP7010-DM	\$ 1250.00	\$ 300.00
7020	Reman Injection Pump Roosa Master, Mfg # DM4629 JN3193	AMP7020-DM	\$ 1250.00	\$ 300.00
7030	Reman Injection Pump Roosa Master, Mfg # DM4629 JN2622, ME2687	AMP7030-DM	\$ 1250.00	\$ 300.00
7040	Reman Injection Pump Roosa Master, Mfg # DM4629 JN3215	AMP7040-DM	\$ 1250.00	\$ 300.00
7045	Reman Injection Pump Roosa Master, Mfg # DM4629 JN3126	AMP7045-DM	\$ 1250.00	\$ 300.00
7050	Reman Injection Pump Roosa Master, Mfg # DM4629 ME2664	AMP7050-DM	\$ 1250.00	\$ 300.00
7060	Reman Injection Pump Roosa Master, Mfg # DM4629 JN3274	AMP7060-DM	\$ 1250.00	\$ 300.00
7080	Reman Injection Pump Roosa Master, Mfg # DM4631 MM3156	AMP7080-DM	\$ 1250.00	\$ 300.00
8010	Reman Injection Pump Bosch, Mfg # 100A9523-1	AMP8010	\$ 1225.00	\$ 300.00
8010	Reman Injection Pump Stanadyne, Mfg # DM4629-4120	AMP8010-DM	\$ 1250.00	\$ 300.00
8030	Reman Injection Pump Bosch, Mfg # 100A9534-1, A9547-1	AMP8030	\$ 1125.00	\$ 300.00
8050	Reman Injection Pump Bosch, Mfg # 100A9486-5, A9545-1	AMP8050-B100	\$ 1125.00	\$ 300.00
8070	Reman Injection Pump Bosch, Mfg # 100A9486-6	AMP8070	\$ 1225.00	\$ 300.00
F2	Reman Injection Pump Roosa Master, Mfg # DB2437 JT3646	AMPF2-DB	\$ 1100.00	\$ 300.00
L w/ D2900 Diesel Engine	Reman Injection Pump Roosa Master, Mfg # DBGFC637 30JT	AMPL29-DBGFC	\$ 975.00	\$ 300.00
M w/ D2900 Diesel Engine	Reman Injection Pump Roosa Master, Mfg # DBGFC637 30JT	AMPM29-DBGFC	\$ 975.00	\$ 300.00
L, M - w/ D2900 Diesel Engine	Reman Injection Pump Roosa Master, Mfg # DM 4629 3191	AMPL29-DM	\$ 1250.00	\$ 300.00
M2 w/ D2900 Diesel Engine	Reman Injection Pump Roosa Master, Mfg # DM4629-3775	AMPM29-DM	\$ 1250.00	\$ 300.00

Allis Chalmers®—Tractor

Application	Description	Part Number	Retail Price	Core
M2 w/ D2900 Diesel Engine	Reman Injection Pump Roosa Master, Mfg # DCGFC627-100JJ	AMPM2-29DCGFC	\$ 950.00	\$ 300.00
L w/ D3500 Diesel Engine	Reman Injection Pump Roosa Master, Mfg # DM 4629 KP3759	AMPL35-DM	\$ 1250.00	\$ 300.00
M w/ D3500 Diesel Engine	Reman Injection Pump Roosa Master, Mfg # DM4629 KP2832	AMPM35-DM	\$ 1250.00	\$ 300.00
N6	Reman Injection Pump Roosa Master, Mfg # DM4631RS3763	AMPN670-DM	\$ 1250.00	\$ 300.00

Injectors

Our remanufactured injectors are disassembled and thoroughly cleaned. The internal components are lapped to ensure there is no leakage. All tips are inspected for hole erosion and opening pressure; and the spray pattern is tested using OEM specifications.



Application	Description	Part Number	Retail Price	Core
190XT, 200	Reman Injector Holder # - 4060859, Valve # - 4036044	N190XT200	\$ 50.00	\$ 20.00
210, 220	Reman Injector Holder # - 4060859, Valve # - 4035508	N210220	\$ 50.00	\$ 40.00
7000, 7010	Reman Injector Holder # - 4060933, Valve # - 4007224	N70007010	\$ 45.00	\$ 20.00
7020 BSN 4392	Reman Injector, Early Style Holder # - 4060933, Valve # - 4007225	N7020	\$ 45.00	\$ 20.00
7020 ASN 4392	Reman Injector, Late Style Straight Type	N7020L	\$ 55.00	\$ 20.00
7030, 7040, 7045, 7050, 7060	Reman Injector Holder # - 4060933, Valve # - 4036044	N7060	\$ 50.00	\$ 20.00
7080, 7580	Reman Injector Holder # - 4060933, Valve # - 4035509	N70807580	\$ 50.00	\$ 20.00
8050, 8070, N6	Reman Injector, Late Style Bosch	N8050	\$ 50.00	\$ 40.00

Turbochargers



Application	Description	Part Number	Retail Price	Core
190XT, Combine: G	Reman Turbocharger 370F70, Rayjay Replacement	AMX36269	\$ 900.00	\$ 200.00
200, 7000, 7020, 8010	Turbocharger 317F70, 6E109, Rayjay Replacement Replaces 74008894, 74009171, 74024238	AM600590-2	\$ 800.00	
210, 220, 7030, 7040, 7050, 7060, Combines: (L, L2, L3, M, M2, M3 - w/ D3500 Engine)	Turbocharger T04B90, AiResearch Replaces 74029207	AM409080	\$ 395.00	
6060, 6070, 6080, Combines: F2, F3, K2	Turbocharger TA3101 Replaces 74009821, 74062759, 74063533	AM74009831	\$ 675.00	
7000, 7020	Reman Turbocharger 301F60, Rayjay Replacement	AMX36270	\$ 850.00	\$ 200.00
7040, 7060	Reman Turbocharger 301E76, Rayjay Replacement	AMX36271	\$ 875.00	\$ 200.00
7080, 7580, 8030, 8050, 8070, 4WD: 4W-220, Combines: N5, N6, R5, R6	Turbocharger T04B42, AiResearch	AM465360	\$ 425.00	

Allis Chalmers®—Tractor

Application	Description	Part Number	Retail Price	Core
D19, 190, 190XT, 200, 7000, 7010, 7020, 8010, Combines: (L, L2, L3, M, M2, M2R, M3 - w/ D2900 Engine)	Turbocharger T04B80, AiResearch	AM409040	\$ 365.00	



Manifolds and Components

Application	Description	Part Number	Retail Price	Core
190, 190XT, 200, 7000, 7010, 7020, 8010 - w/ D2900 Engine	Exhaust Manifold	AM74007653	\$ 134.00	
	Manifold Gasket, (3) Required	AMX36235	\$ 8.50	
190, 190XT, 200	Exhaust Elbow	AM70244418	\$ 105.00	
210, 220, 7000, 7010, 7020, D19, D21	Exhaust Elbow	AM70253661	\$ 67.00	
7030, 7040, 7045, 7050, 7060, 7080, 7580, 8030, 8050, 8070	Exhaust Manifold, Center Section Late Style, Requires (2) 74036815 Washers	AM74036828	\$ 60.00	
7030, 7040, 7045, 7050, 7060	Exhaust Elbow	AM70267640	\$ 108.09	
7030, 7040, 7045, 7050, 7060, 7080, 8030, 8050, 8070 - w/ D3500 Engine	Exhaust Manifold Consists of 74036501 Front, 74036503 Center and 74036504 Rear Sold As An Assembly Only	AM74036504K	\$ 260.00	
B, C, CA	Intake and Exhaust Manifold	AMAM2919	\$ 129.00	
	Manifold Gasket	AMX36232	\$ 10.00	
D17, WD, WD45	Intake and Exhaust Manifold	AM70226350	\$ 194.00	
	Manifold Gasket Set	AMX36233	\$ 15.00	
D14, D15 - w/ Gas	Intake and Exhaust Manifold	AM70234141	\$ 185.00	
	Manifold Gasket	AMX36234	\$ 11.50	
D19 w/ 262 CID Gas Engine	Exhaust Manifold	AM74516769	\$ 236.00	
	Manifold Gasket Ref# 74512715	AMX36215	\$ 18.50	
F, K - w/ 292 CID Chevy Engine	Exhaust Manifold	AM71178420	\$ 179.00	
	Manifold Gasket	AMX36236	\$ 15.00	

Mufflers and Exhaust

Our mufflers are manufactured by experienced craftsmen here in the United States. All mufflers have welded seams. Aluminized steel is used for critical components. These features ensure that our products resist the corrosive effects of air, heat and the by-products of combustion that work to shorten muffler life. Additionally, they are painted either silver or black to cosmetically match its OEM counterpart, as well as provide further protection from the elements.

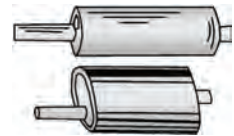

Application	Description	Part Number	Retail Price	Core
Universal Tractors	Exhaust Pipe Black Finish, Straight Pipe 4" ID, Overall Length 47.50"	AM400SP	\$ 59.00	
Universal Tractors	Exhaust Pipe Diameter 3.50", Length 48"	AMS312X48	\$ 57.00	
160 w/ Perkins Diesel, 6040 Diesel	Muffler, Round 1 11/16" Inlet, 35" Length	AM79010624V	\$ 46.00	
	Outlet Clamp	CL-134	\$ 4.00	
	Rain Cap	RC-1	\$ 12.00	
180 Gas or Diesel, 185 Diesel	Muffler, Oval 2 3/8" Inlet, 34" Length	AM70248883	\$ 56.50	
	Inlet Clamp	CL-212	\$ 7.00	
	Rain Cap	RC-2	\$ 13.00	

Allis Chalmers®—Tractor

Application	Description	Part Number	Retail Price	Core
190 Gas or Diesel (Below Hood)	Muffler, Horizontal 2 3/8" Inlet, 18" Length	AM70243283	\$ 76.00	
	Inlet Clamp	CL-212	\$ 7.00	
	Inlet Clamp	CL-300	\$ 6.00	
190 Diesel Turbo, 200 Late, 7000 Diesel BSN 8553	Muffler, Round 3" Inlet, 48" Length	AM70271755	\$ 73.00	
	Inlet Clamp	CL-300	\$ 6.00	
	Rain Cap	RC-4	\$ 16.00	
190XT, 200 Early, 210 Diesel, 220 Diesel	Muffler, Round 3" Inlet, 42" Length	AM70253660	\$ 56.00	
	Inlet Clamp	CL-300	\$ 6.00	
	Rain Cap	RC-4	\$ 16.00	
5020, 5030	Muffler, Round 3-Bolt Base Plate Inlet, 28" Length	AM72099119	\$ 210.00	
6060, 6070, 6080	Muffler, Oval 3" Inlet, 46" Length	AM70263428	\$ 115.00	
	Inlet Clamp	CL-300	\$ 6.00	
	Rain Cap	RC-4	\$ 16.00	
7000 ASN 8553, 7010, 7020, 7030, 7040, 7045, 7050, 7060	Muffler, Oval 3" Inlet, 48" Length	AM70261975	\$ 121.00	
	Inlet Clamp	CL-300	\$ 6.00	
	Rain Cap	RC-4	\$ 16.00	
7080, 7580	Muffler, Oval 4" Inlet, 49" Length	AM70269031	\$ 187.00	
	Clamp	CL-400	\$ 6.50	
	Rain Cap	RC-9	\$ 18.00	
8550, 4WD: 4W-305 (Aspirated)	Muffler, Oval 4" Inlet, 44 1/4" Length	AM70259460	\$ 256.00	
	Clamp	CL-400	\$ 6.50	
	Rain Cap	RC-9	\$ 18.00	
A, B, C, H, R	Muffler, Horizontal Round 2 3/8" Inlet, 27" Length	AM71124210	\$ 51.00	
	Inlet Clamp	CL-212	\$ 7.00	
B, C, CA	Muffler, Oval 1 1/2" Inlet, 9" Length	AM70210081	\$ 47.00	
	Inlet Clamp	CL-112	\$ 3.50	
B, C & CA (53-57) - Thru Hood, D10, D12, D14, D15 Gas BSN 9001	Muffler, Round 1 3/8" Inlet, 29" Length Includes brackets for mounting to headbolt and manifold	AM70233450	\$ 37.50	
	Rain Cap	RC-0	\$ 11.50	
D15 Gas ASN 9001	Muffler, Oval 13/4" Inlet, 27" Length	AM70237811	\$ 52.00	
	Inlet Clamp	CL-134	\$ 4.00	
	Rain Cap	RC-1	\$ 12.00	
D17 Gas ASN 42000	Muffler, Oval 1 15/16" Inlet, 27" Length	AM70246129	\$ 52.50	
	Inlet Clamp	CL-200	\$ 4.00	
	Rain Cap	RC-2	\$ 13.00	
D-19 Gas 61-63	Muffler, Oval 2 3/8" Inlet, 27" Length	AM79015993V	\$ 53.50	
	Inlet Clamp	CL-212	\$ 7.00	
	Rain Cap	RC-2	\$ 13.00	

Allis Chalmers®—Tractor

Application	Description	Part Number	Retail Price	Core
WD Gas 48-53	Muffler, Round 1 5/8" Inlet, 29" Length	AM70219534	\$ 27.75	
	Inlet Clamp	CL-158	\$ 4.00	
	Rain Cap	RC-1	\$ 12.00	
WD45 Gas, D17 Gas BSN 32000	Muffler 1 5/8" Inlet, 29" Length	AM70229531	\$ 34.50	
	Rain Cap	RC-1	\$ 12.00	
Deutz® Engines: 413, 511, 513, 912, 913, 914	Manifold Muffler 4 Cylinder	AM2160568	\$ 175.00	
Deutz® Engines: 912, 913, 914	Manifold Muffler 6 Cylinder	AM2247490	\$ 175.00	

Starters

All of our remanufactured starters are disassembled, cleaned and inspected. Almost all units receive new field coils. If it meets OEM specifications the armature is test turned and under cut, otherwise it is replaced with a quality factory remanufactured or new part. Starters with factory solenoids have the solenoids replaced with new parts. The drive is carefully inspected and if it does not meet specifications it is replaced with new or quality factory remanufactured drives.



Application	Description	Part Number	Retail Price	Core
180, 185, 190, 190XT, 200, 6060, 6070, 6080, 7000, 7010, 7020, 8010, Combine: F, G - All w/ Diesel	Starter, 12 Volt Lucas, Direct Drive, 10 Tooth, 2.80kW, 3-Bolt Mount	AM70273901	\$ 190.00	
WC, WF	Reman Starter, 6 Volt Delco 10MT	AM1107017	\$ 242.00	\$ 200.00
AGCO®: DT205B, DT225B, DT250B, DT275B	Starter, 12 Volt HD Planetary Gear Reduction, 10 Tooth, 4.20 kW, CW Rotation Replaces 4288993M91, 4288993M92, 4288993M93	AM4288991M4	\$ 425.00	
Combines: A76, R66, R76, S67, S68, S77, S78, S88	Starter, 12 Volt 11 Tooth, CW Rotation Replaces 84284540	AMV836873457	\$ 345.00	
160, 170, 175, 180, 185, 190, 190XT, 200, 210, 220, 440, 5040, 5045, 5050, 6040, 6060, 6070, 6080, 7000, 7010, 7020, 7030, 7040, 7045, 7050, 7060, 7080, 7580, 8010, 8030, 8050, 8070, 8550, 4WD: 4W-220, 4W-305	Neutral Starting Switch Replaces 121629C3, 83954C91, AH98872	AMX34147	\$ 30.00	

Air Cleaner Components

Application	Description	Part Number	Retail Price	Core
160, 6040, Combines: G, F2, L BSN 013000, Hesston® Swathers: 6550, 6550, 6655, 8100, 8200 Replaces 71125804	Small Precleaner Bowl 7" Diameter	AMP02-0227	\$ 10.00	
170, 175, 180, 185, 190, 190XT, 200, 210, 220, 6060, 6070, 6080, 7000, 7010, 7020, 7030, 7040, 7045, 7050, 7085, 7110, 7120, 7145, D19, Combines: G, L, M Replaces 70651270	Large Precleaner Bowl 10.50" Diameter	AMP01-6330	\$ 12.00	









Allis Chalmers®—Tractor



Tachometers and Gauges

Application	Description	Part Number	Retail Price	Core
D10, D12, D14, D15, D17, I40, I60, Backhoe-Loaders: I400, I600 - All w/ Gas or LPG	Oil Pressure Gauge, White Face 0-45 PSI, Chrome Bezel, Dash-Mounted Includes Bracket w/ Studs (2" Diameter w/ 1/8" NPT Male Thread) Replaces 228719, 70228718	AM70228719	\$ 29.10	

Tie Rods and Components

Application	Description	Part Number	Retail Price	Core
 170*, 175, 180, 185, 190XT, 200, D14*, D15*, D17*, D19*, WD*, WD45* *Male Tie Rod End must be cut to proper length prior to installation	Complete Tie Rod Assembly Includes AM70250140 Female Tie Rod End, AM70250141 Male Tie Rod End, Cap Screw, Nut and Lock Washer	AM70254660	\$ 50.00	
 170 w/ Roll Shift, 175 w/ Roll Shift, 6060, 6070	Tie Rod 3.75" Long, 0.813" Diameter, Right Hand Thread	AM70256151	\$ 26.00	
 170, 175 - w/ Roll Shift Front Axle	Tie Rod 15.72" Long, 1.125" Diameter	AM70256144	\$ 110.62	
 170, 175, 180, 185, 190XT, 200, D14, D15, D17, D19, WD, WD45	Tie Rod End, Female 17.25" Long Replaces 70254661	AM70250140	\$ 23.00	
 170*, 175, 180, 185, 190XT, 200, D14*, D15*, D17*, D19*, WD*, WD45* Note: Applications with (*) must be cut to proper length prior to installation	Tie Rod End, Male 16.50" Long Replaces 70254662	AM70250141	\$ 23.00	
 7000, 7010, 7020, 7030, 7040, 7045, 7050, 7060, 7080, 8010, 8050, 8070 - 2WD w/ Heavy Duty Axle	Tie Rod, Inner 4.946" Long, 1.125" Diameter, Right Hand Thread	AM70265527	\$ 27.00	
 7000, 7010, 7020, 7030, 7040, 7045, 7050, 7060, 7080, 8010, 8030, 8050, 8070 - w/ Heavy Duty Axle	Tie Rod, Outer 21" Long, 8 holes	AM70269353	\$ 65.00	
 8010, 8030, 8050, 8070 - w/ MFWD	Tie Rod End 4.825" Long, M30x1.50" Thread	AM4311552	\$ 54.00	
9130, 9150, 9435, 9455, 9620, 9650, 9655, 9675, 9695	Tie Rod 15.75" Long, 0.937" Diameter Shank	AM72161866	\$ 27.00	

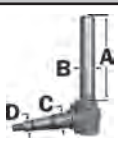
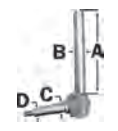

Spindles

Spindles are forged from high grades of alloy steel, machined and assembled to exact specifications that meet or exceed OEM specifications.

Application	Description	Part Number	Retail Price	Core
 Forklifts (Right Hand): 500, 600, Ind (Left Hand): 615, I60, I600	Spindle A - 8.75 B - 1.61 C - 1.625 D - 1.187	AM1022019	\$ 200.00	
	Wheel Bearing Kit	WBK-AC-2	\$ 38.00	
 D10, D12, D14, D15, D17 (Early w/ 5-Bolt Wheel)	Spindle A - 12.00 B - 1.61 C - 1.50 D - 1.187	Right or Left Hand AM70237434	\$ 314.65	
	Wheel Bearing Kit	WBK-AC-1	\$ 52.00	

Prices Subject to Change without Prior Notice. The use of original equipment manufacturer (OEM) part numbers or trademarks, e.g. Case® and John Deere®, are for reference purposes only and for indicating product use and compatibility. Our company and the listed replacement parts contained herein are not sponsored, approved or manufactured by the OEM. All parts are New unless designated Reman in the description.

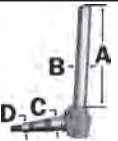
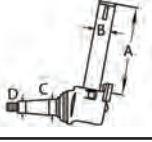
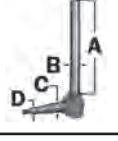
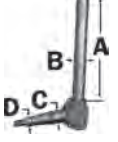
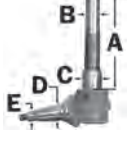
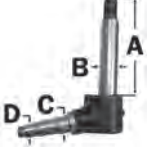
Allis Chalmers®—Tractor

	Application	Description		Part Number	Retail Price	Core
	170 Late, 175, 180, 185, D15, D17	Spindle	Right or Left Hand	AM70270038	\$ 165.00	
		A - 12.00 B - 1.61 C - 1.625 D - 1.187	Wheel Bearing Kit	WBK-AC-2	\$ 38.00	
	210, 220, D21	Spindle	Right Hand	AM70252094	\$ 447.84	
		A - 10.062 B - 1.876 C - 1.795 D - 1.375	Left Hand	AM70252093	\$ 447.84	
			Wheel Bearing Kit	WBK-AC-3	\$ 48.84	
	180, 185, 190, 190XT, 200, D19	Spindle	Right or Left Hand	AM70262782	\$ 165.00	
		A - 14.00 B - 1.61 C - 1.625 D - 1.187	Wheel Bearing Kit	WBK-AC-2	\$ 38.00	
	7000 Early	Spindle	Right or Left Hand	AM70261052	\$ 165.00	
		A - 13.125 B - 1.61 C - 1.625 D - 1.187	Wheel Bearing Kit	WBK-AC-2	\$ 38.00	
	7000 HD, 7010, 7020, 7030, 7040, 7045, 7050, 7060, 7080, 8010, 8030, 8050, 8070	Spindle	Right Hand	AM70267780	\$ 426.08	
		A - 11.625 B - 1.867 C - 2.437 D - 2.00 E - 1.375	Left Hand	AM70267779	\$ 419.16	
			Wheel Bearing Kit	WBK-AC-4	\$ 42.37	
	M&M®: 1870, 2270, (G900, G950, G1050 - HD), G955, G1350, G1355, G2155, Oliver®: 1865 (HD), 2255, White®: 2-135, 2-150, 2-155, 2-180, 160, 170, 185, 195	Spindle	Left or Right Hand	AM72160101	\$ 615.57	
		Replaces 11A26941 A - 12.30 B - 2.25 C - 2.00 D - 1.50				
	8745, 8765	Spindle Bushing		AM882327M1	\$ 19.74	
	(160, 170, 175, 180, 185, 190, 190XT, 200, 6060, 6070, 6080, D10, D12, D14, D15, D17, D19 - w/ Adjustable or Roll Shift Front Axle)	Knee Bushing		AM70211743	\$ 18.14	
	(210, 220, 7000 w/ Heavy Duty Axle, 7010, 7020, 7030, 7040, 7045, 7050, 7060, 7080, 8010, 8030, 8050, 8070, D21 - w/ Adjustable Front Axle)	Upper Spindle Bushing		AM70239452	\$ 17.80	

Wheel Hubs and Components







Application	Description	Part Number	Retail Price	Core
170 Late, 175, 180, 185, 190, 190XT, 200, 6070, 6080, 7000 Early, D15, D17 Early, D19, Forklifts: 500, 600, Ind: 615, I60, I600	Wheel Hub, 6-Bolt	AM70261418	\$ 45.00	
	Hub Cap Spin-On	AM70220403	\$ 16.72	

Allis Chalmers®—Tractor

Application	Description	Part Number	Retail Price	Core
210, 220, 7000, 7000HD, 7010, 7020, 7030, 7040, 7045, 7050, 7060, 7080, 8010, 8030, 8050, 8070, D21	Wheel Hub, 8-Bolt	AM70265167	\$ 90.00	
6060, 6070	Wheel Hub, 6-Bolt	AM70263039	\$ 55.00	
D10 ASN 3501, D12 SN 3001-9000, D14, D15 BSN 9001, D17 Series III BSN 42001, WD, WD45	Wheel Hub, 5-Bolt Includes Bearing Cups	AM70228897	\$ 78.50	

Wheel Bearing Kits

Application	Description	Part Number	Retail Price	Core
 170 Late, 175, 180, 185, 190, 190XT, 200, 210, 220, 7000 Early, D15, D17, D19	Wheel Bearing Kit	WBK-AC-2	\$ 38.00	
	Components:			
	Inner Cone	1 26882	\$ 13.50	
	Inner Cup	1 26823	\$ 7.00	
	Outer Cone	1 15118	\$ 8.00	
	Outer Cone	1 15250	\$ 4.75	
	Seal	1 AP19005	\$ 12.00	
	Sleeve	1 AP19010	\$ 5.00	
 210, 220, D21	Wheel Bearing Kit	WBK-AC-3	\$ 48.84	
	Components:			
	Inner Cone	1 14138A	\$ 7.00	
	Inner Cup	1 14274	\$ 5.50	
	Outer Cone	1 25590	\$ 11.00	
 7000, 7010, 7020, 7030, 7040, 7045, 7050, 7060, 8030, 8050, 8070	Wheel Bearing Kit	WBK-AC-4	\$ 42.37	
	Components:			
	Inner Cone	1 14138A	\$ 7.00	
	Inner Cup	1 14274	\$ 5.50	
	Outer Cone	1 LM104949	\$ 11.00	
	Outer Cup	1 LM104912	\$ 6.00	
 D10, D12, D15, D17 Early, WD	Wheel Bearing Kit Use w/ AM70228897 Wheel Hub, 5-Bolt	WBK-AC-1	\$ 45.00	
	Components:			
	Inner Cone	1 2777	\$ 16.50	
	Inner Cup	1 2720	\$ 5.00	
	Outer Cone	1 15118	\$ 8.00	
	Outer Cup	1 15250	\$ 4.75	
	Seal	1 AP19005	\$ 12.00	
Sleeve	1 AP19010	\$ 5.00		

Steering Arms



Application	Description	Part Number	Retail Price	Core
170 BSN 7500, 175 BSN 2035, 180, 185, 190, 190XT, 200, D14, D15, D17, D19	Steering Arm Right Hand	AM70245868	\$ 110.00	
	Steering Arm Left Hand	AM70245867	\$ 110.00	

Allis Chalmers®—Tractor

Application	Description	Part Number	Retail Price	Core
170 ASN 7501, 175 ASN 2036, 6060, 6070	Steering Arm	Right Hand	AM70256034	\$ 146.73
		Left Hand	AM70256031	\$ 146.73
7000 (Heavy Duty), 7010, 7020, 7030, 7040, 7045, 7050, 7060, 7080, 8010, 8030, 8050, 8070	Steering Arm	Right or Left Hand	AM70265087	\$ 139.38

Hydraulic Oil Coolers

Application	Description	Part Number	Retail Price	Core
185, 190, 190XT, 200, 210, 220	Hydraulic Oil Cooler Core: 6" x 19.50" x 1 3/4"	AM70272180	\$ 275.00	



Hydraulic Pumps

Application	Description	Part Number	Retail Price	Core
180, 185	Hydraulic Pump, Triple	AM70249437-N	\$ 1950.00	
190, 190XT	Hydraulic Pump, Triple	AM70248735-N	\$ 1950.00	
190, 190XT, 200, 210, 220 - Late	Hydraulic Pump, Dual	AM70257005-N	\$ 1400.00	
6060 ASN 4383, 6070, 6080 ASN 5284	Hydraulic Pump	AM70270905	\$ 1320.00	



Transmission Input Shafts

Application	Description	Part Number	Retail Price	Core
180, 185, 190 ASN 9001, 190XT, 200	Transmission Input Shaft 8.71" Long, 21, 19 & 15 Tooth	AM70256571	\$ 163.00	



PTO Shafts and Components

Application	Description	Part Number	Retail Price	Core
160, 170, 175, 180, 185 BSN 12525, 190, 190XT, 200	Bolt-On Style Flip-Flop Shaft 540/1000 RPM, 7.875" long, center mounting ring is 5.75" diameter, 4-bolt mounting	AM70255802	\$ 259.09	
175, 180, 185 ASN 12525, 7000	Bolt-On Style Flip-Flop Shaft 540/1000 RPM, 7.875" long, center mounting ring is 5.75" diameter, 6-bolt mounting	AM70260704	\$ 262.53	
7010, 7020, 7030, 7040, 7045, 7050, 7060, 8010, 8030, 8050	Bolt-On Style Flip-Flop Shaft 540/1000 RPM, 8.625" long, center mounting ring is 5.75" diameter, 6-bolt mounting	AM70266975	\$ 165.00	
WC, WD, WD45	PTO Housing	AM70224653	\$ 110.00	

PTO Adapters

Application	Description	Part Number	Retail Price	Core
Tractors up to 70HP	PTO Adapter Small 540 to 1000 Spline Changes PTO from 1 3/8" x 6 spline to 1 3/8" x 21 spline and extends the PTO shaft 4 1/8"	AMX59112	\$ 40.00	
Tractors up to 70HP	PTO Adapter Small 1000 to 540 Spline, 6 3/8" Overall Length Reduces PTO from 1 3/8" x 21 spline to 1 3/8" x 6 spline and extends the PTO shaft 4 1/8"	AMX59108	\$ 40.00	

Allis Chalmers®—Tractor

Application	Description	Part Number	Retail Price	Core
Tractors up to 100HP	PTO Adapter Large 1000 to 540 Spline, 7 1/2" Overall Length Reduces PTO from 1 3/4" x 20 spline to 1 3/8" x 6 spline and extends the PTO shaft 4 5/8"	AMX59109	\$ 70.00	
Tractors up to 100HP	PTO Adapter Large 1000 to Small 1000 Spline, 7" Overall Length Changes PTO from 1 3/4" x 20 Spline to 1 3/8" x 21 Spline and extends the PTO shaft 4 5/8"	AMX59110	\$ 70.00	



Brakes and Components

Application	Description	Part Number	Retail Price	Core
170, 180, 185, D15, D17	Brake Lining Kit for Bendix Brakes Used to reline 70248221 Disc and 70237418 Drum Includes (1) 6.50" OD x 3/16" Non-Asbestos Lining w/ Rivets (3.50" Center Hole) and (1) 5.375" OD x 3/16" Non-Asbestos Lining w/ Rivets (2.875" Center Hole)	AM70276914	\$ 38.00	
190, 190XT, D19	Brake Lining Kit for Bendix Brakes Includes (2) 6.50" OD x 3/16" non-asbestos linings w/ rivets (3.50" center hole) Replaces 70235607	AM70235628	\$ 25.00	
170, 175, 180, 185, D17 ASN 42001	Brake Drum 1.56" Wide, 7.25" Diameter	AM70237418	\$ 135.77	
D17 ASN 42001, D19, D21, 170, 175, 180, 185, 190, 190XT, 200 BSN 04000	Brake Band Replaces 70235610, 70276940, 70277438	AM70277379	\$ 40.32	



Drawbars and Components

All of our drawbars are cut, drilled and heat-treated to exact design and specifications that meet or exceed OEM specifications.

Application	Description	Part Number	Retail Price	Core
190, 190XT, 200, 7000, D19	Drawbar 2.50" x 1.25" x 52.25", (4) Holes at 1.72", 4.33", 5.70", 8.33" from Front	AM70239813	\$ 302.96	
170, 175, 180, 185, D17 Series 4	Drawbar w/ Offset 2.50" x 1.25" x 50.50"	AM70254452	\$ 135.00	



Quick Hitches

Application	Description	Part Number	Retail Price	Core
Cat II	Quick Hitch, 4" x 6" Beam 36" Wide, Includes 1 1/8" Mounting Pins and Adapter Bushings	AMX741020	\$ 565.00	
Cat III	Quick Hitch, 4" x 6" Beam 38" Wide, Includes 1 7/16" Mounting Pins	AMX741022	\$ 565.00	
Cat III	Quick Hitch, 4" x 6" Beam 44" Wide, Includes 1 7/16" Mounting Pins	AMX741021	\$ 565.00	
Most Models	Pull Arm Latch, CAT III Right or Left Hand For Flat/Hook Style Pull Arm Replaces 3903314M91, 86017137, CH167802	AMAL117727	\$ 60.00	

Allis Chalmers®—Tractor

Three Point Hitch Components





Application	Description	Part Number	Retail Price	Core
170, 175, 180, 185, 190, 190XT, 7000, D17 Series IV, D19	Lift Link Clevis	AM70257726	\$ 97.71	









Battery Boxes and Components

Application	Description	Part Number	Retail Price	Core
B, C, CA	Battery Box w/ Lid	AM70226026	\$ 94.00	







Lighting

Application	Description	Part Number	Retail Price	Core
 170, 175, 180, 185, 190, 190XT, 200, 6040, 6060, 6080, 7000, 7010, 7020, 7030, 7040, 7045, 7050, 7060, 7080 Replaces 267185, 70249146, 70249147, 70267185	LED Trapezoid Light Fender Mount 4.50" Sealed Beam Round Light 2800 Lumens, 40 Watts, 3.30 Amps For 12 Volt to 24 Volt Systems Rear Stud Mount w/ Built-In Heat Sink Includes Both Long and Short Rubber Bezels	AMTL2060	\$ 95.00	
	Headlight Sealed Beam, 12 Volt, 2-Wire	AMRE25126	\$ 45.00	
 9130, 9150, 9170, 9190 Replaces 72162190	LED Headlight Hood and Cab Mount 6.75" x 4.25" Rectangle Light Dual Hi/Lo Beam 3500 Lumens, 60 Watts, 5 Amps For 12 Volt to 24 Volt Systems Includes Connector and Adapter, Plug-and-Play	AMTL9020	\$ 99.00	
	LED Headlight Hood and Cab Mount 6.75" x 4.25" Rectangle Light Dual Hi/Lo Beam 3500 Lumens, 60 Watts, 5 Amps For 12 Volt to 24 Volt Systems Includes Connector, Plug-and-Play	AMRE46298	\$ 79.20	
 Universal Equipment	LED Floodlight All-Position Light 4.25" x 4.25" Square Light 2650 Lumens, 48 Watts, 4 Amps For 12 Volt to 24 Volt Systems Includes Mounting Bracket and Stainless Steel Hardware	AMTL105F	\$ 95.00	
 Universal Equipment	LED Floodlight All-Position Light 6.25" x 1.75" Rectangle Light 1300 Lumens, 18 Watts, 1.50 Amps For 12 Volt to 24 Volt Systems Includes Mounting Bracket and Stainless Steel Hardware	AMTL118F	\$ 50.00	
 Universal Equipment	LED Floodlight All-Position Light 5" Round Light 3200 Lumens, 40 Watts, 3.30 Amps For 12 Volt to 24 Volt Systems Includes Mounting Bracket and Stainless Steel Hardware	AMTL180	\$ 89.00	





Allis Chalmers®—Tractor

Application	Description	Part Number	Retail Price	Core
 Universal Equipment	LED Floodlight All-Position Light Round Light 6900 Lumens, 50 Watts, 4.10 Amps For 9 Volt to 32 Volt Systems Includes Mounting Bracket and Stainless Steel Hardware	AMTL500F	\$ 120.00	
	LED Floodlight All-Position Light 4.30" Round Light 5040 Lumens, 50 Watts, 4.10 Amps For 12 Volt to 24 Volt Systems Includes Stainless Steel Adjustable Mounting Bracket	AMAT305931	\$ 96.00	
 Universal Equipment	LED Floodlight All-Position Light 4.25" Round Light 2650 Lumens, 42 Watts, 3.50 Amps For 12 Volt to 24 Volt Systems Includes Mounting Bracket and Stainless Steel Hardware	AMTL115F	\$ 59.00	
Universal Equipment	LED Wide Floodlight All-Position Light 5" x 7" Rectangle Light 3800 Lumens, 35 Watts For 12 Volt to 24 Volt Systems	AMX34171	\$ 60.00	
 Universal Equipment	LED Floodlight, Sealed Beam Fender Mount 4.50" Diameter Round Light 1250 Lumens, 18 Watts, 1.50 Amps Trapezoid Pattern For 12 Volt to 24 Volt Systems	AMTL3010	\$ 40.00	
	LED Floodlight Fender Mount 4.50" Diameter Sealed Beam Round Light 1250 Lumens, 18 Watts, 1.20 Amps Trapezoid Pattern For 12 Volt to 24 Volt Systems Lasts 50 times longer than halogen lighting, vibration resistant w/ no filament failures, uses original mount and wiring, Operating temperature of -40°F to 140°F / -40°C to 60°C	AMRE336111	\$ 35.00	
 Universal Equipment	LED Floodlight Fender Mount 4.50" Diameter Sealed Beam Round Light 1440 Lumens, 18 Watts, 1.60 Amps Lasts 50 times longer than halogen lighting, vibration resistant w/ no filament failures, 2-terminal connection, Operating temperature of -40°F to 140°F / -40°C to 60°C	AMRE336112	\$ 67.75	
 160, 170, 175, 180, 185, 190, 200, 210, 6040, 6060, 6070, 6080, 7000, 7010, 7020, 7030, 7040, 7045, 7050, 7060, 7080	LED Floodlight Hood, Front and Rear Fender Mount 5" Diameter Round Light 2800 Lumens, 40 Watts, 3.30 Amps Trapezoid Pattern 1/2" rear stud mount w/ built-in heat sink for cooling, a brighter light and longer life, Includes both long and short rubber bezels, For use w/ stud mounted front fender lights	AMAR85859	\$ 90.00	
 Universal Equipment	LED Floodlight Cab and Fender Mount 3.50" x 6" Rectangle Light 3600 Lumens, 40 Watts, 3 Amps	AMX34146	\$ 65.00	





Allis Chalmers®—Tractor

Application	Description	Part Number	Retail Price	Core
 <p>220, 6060, 6070, 6080, 8010, 8030, 8050, 8070, 4WD: 4W-305 Replaces 700705183, 700705184, 20-1730T91</p>	<p>LED Flood/Spotlight Combo Cab, Front and Rear Fender Mount 4" x 6" Rectangle Light 4800 Lumens, 50 Watts, 4.16 Amps For 12 Volt to 24 Volt Systems</p>	AMTL175F	\$ 120.00	
	<p>LED Flood/Spotlight Combo Cab, Front and Rear Fender Mount 4" x 6" Rectangle Light 4800 Lumens, 50 Watts, 4 Amps For 12 Volt to 24 Volt Systems</p>	AM245897C91	\$ 92.00	
 <p>9435, 9455, 9635, 9655, 9675, 9695, 9755, 9765, 9775, 9785, 9815, DT160, DT180, DT200, DT225</p>	<p>LED Floodlight/Spotlight Combo Hood Mount 6" x 4" Rectangle Light Dual Hi/Lo Beam 3500 Lumens, 60 Watts, 5 Amps For 12 Volt to 24 Volt Systems Uses Original Mount and Wiring Includes Connector and Stainless Steel Hardware</p>	AMTL6040	\$ 110.00	
 <p>Universal Equipment</p>	<p>LED Spotlight All-Position Light 4.25" x 4.25" Square Light 1400 Lumens, 27 Watts, 2.20 Amps For 12 Volt to 24 Volt Systems</p>	AMTL100S	\$ 45.00	
 <p>Universal Equipment</p>	<p>LED Spotlight All-Position Light 6.25" x 1.75" Rectangle Light 1300 Lumens, 18 Watts, 1.50 Amps For 12 Volt to 24 Volt Systems Includes Mounting Bracket and Stainless Steel Hardware</p>	AMTL118S	\$ 50.00	
 <p>Universal Equipment</p>	<p>LED Spotlight All-Position Light Round Light 6900 Lumens, 50 Watts, 4.10 Amps For 9 Volt to 32 Volt Systems Includes Mounting Bracket and Stainless Steel Hardware</p>	AMTL500S	\$ 120.00	
 <p>Universal Equipment</p>	<p>LED Trapezoid Light Cab and Fender Mount 4.50" Diameter Round Light 2800 Lumens, 40 Watts, 3.30 Amps Trapezoid Pattern For 12 Volt to 24 Volt Systems Bottom Mount w/ Built-In Heat Sink Includes Mounting Bracket, Long and Short Rubber Bezels, and Stainless Steel Hardware Replaces 70269614</p>	AMTL2080	\$ 95.00	
	<p>LED Trapezoid Light Cab and Rear Fender Mount 4.50" Diameter Round Light 2800 Lumens, 40 Watts, 3.30 Amps Trapezoid Pattern For 12 Volt to 24 Volt Systems Bottom Mount w/ Built-In Heat Sink Includes Mounting Bracket, Long and Short Rubber Bezels and Stainless Steel Hardware Replaces 70269614</p>	AMX33121	\$ 76.00	



Allis Chalmers®—Tractor

Application	Description	Part Number	Retail Price	Core
 Universal Equipment	LED Warning Light Cab, Header or Swather Mount Can be used for Turn Signal, Brake or Running Lights 4.125" Diameter Round Light Double Sided, Amber Lenses 25 Bulbs per Side For 12 Volt to 24 Volt Systems	AMTLFL2	\$ 55.00	
	LED Warning Light Cab, Header or Swather Mount Can be used for Turn Signal, Brake or Running Lights 4.125" Diameter Round Light Double Sided, Amber Lenses 25 Bulbs per Side For 12 Volt to 24 Volt Systems	AMX1910149	\$ 44.00	
 Universal Equipment	LED Warning Light Cab, Header or Swather Mount Can be used for Turn Signal, Brake or Running Lights 4.125" Diameter Round Light Double Sided, Red and Amber Lenses 25 Bulbs per Side For 12 Volt to 24 Volt Systems	AMTLFL3	\$ 55.00	
	LED Warning Light Cab, Header or Swather Mount Can be used for Turn Signal, Brake or Running Lights 4.125" Diameter Round Light Double Sided, Red and Amber Lenses 25 Bulbs per Side For 12 Volt to 24 Volt Systems	AMX33126	\$ 44.00	
 Universal Equipment	LED Magnetic Warning Light All-Position Light 360° Flashing Light, Multiple Patterns 9.50" x 6.75" Rectangle Light Magnetic Base or Solid Mount For 12 Volt to 24 Volt Systems Includes Cigarette Lighter Adapter, Wiring and Switch	AMTL1100	\$ 170.00	
 Universal Equipment	LED Magnetic Warning Light All-Position Light 360° Flashing Light, Multiple Patterns 14" x 6.75" Rectangle Light Magnetic Base or Solid Mount For 12 Volt to 24 Volt Systems Includes Cigarette Lighter Adapter, Wiring and Switch	AMTL1200	\$ 190.00	
Universal Equipment	Warning Beacon 360° Flashing Beacon, Amber Lens For 0.9435" Diameter Pipe Replaces 84337818, AZ44705, AZ101891	AM82018390	\$ 45.64	
 Universal Equipment	LED Warning Beacon 360° Flashing Beacon 2.75" x 5.25" Light Polycarbonate Amber Lens and Housing For 12 Volt to 24 Volt Systems Includes Solid Mounting Pad and Stainless Steel Hardware	AMTL2100	\$ 30.00	

Allis Chalmers®—Tractor

	Application	Description	Part Number	Retail Price	Core
	Universal Equipment	LED Warning Beacon 360° Flashing Beacon, 3 Different Patterns 5" x 10" Light Amber Lens, 48 Watts, 4 Amps For 12 Volt to 24 Volt Systems Brackets Sold Separately	AMX33131	\$ 75.00	
	Universal Equipment	Warning Beacon Bracket	AMX33132	\$ 15.00	
	Universal Equipment	Warning Beacon Bracket	AMX33133	\$ 15.00	
	Universal Equipment	Warning Beacon Bracket	AMX33137	\$ 15.00	
	Universal Equipment	Warning Beacon Bracket	AMX33135	\$ 15.00	





Allis Chalmers®—Tractor

Application	Description	Part Number	Retail Price	Core
 Universal Equipment	LED Light Bar 4" Long, 1260 Lumens, Cree Bulbs	AMLED4	\$ 45.00	
	LED Light Bar Flood/Spotlight Combo 10" Long, 5700 Lumens, 50 Watts, 4.20 Amps For 12 Volt to 24 Volt Systems Includes Mounting Bracket and Stainless Steel Hardware	AMTL10SRC	\$ 129.00	
	LED Light Bar Floodlight/Spotlight Combo 14" Long, 5400 Lumens, 72 Watts, 6 Amps Die Cast Aluminum Housing, Polycarbonate Lens For 12 Volt to 24 Volt Systems Includes Mounting Bracket and Heavy Duty Stainless Steel Hardware	AMTLB410C	\$ 150.00	
	LED Light Bar Floodlight/Spotlight Combo 30" Long, 13600 Lumens, 150 Watts, 12.50 Amps For 12 Volt to 24 Volt Systems Includes Mounting Bracket and Stainless Steel Hardware	AMTL30SRC	\$ 230.00	
	LED Light Bar 30" Long, 13860 Lumens, Cree Bulbs	AMLED30	\$ 130.00	
	LED Light Bar Floodlight/Spotlight Combo 40" Long, 17300 Lumens, 200 Watts, 16.70 Amps For 12 Volt to 24 Volt Systems Includes Mounting Brackets and Stainless Steel Hardware	AMTL40SRC	\$ 300.00	
	LED Light Bar 40" Long, 18200 Lumens, Cree Bulbs	AMLED40	\$ 160.00	
	LED Light Bar Floodlight/Spotlight Combo 42" Long, 14500 Lumens, 240 Watts, 19 Amps For 12 Volt to 24 Volt Systems Includes Mounting Bracket and Stainless Steel Hardware Replaces 1163691	AMTLB440C	\$ 250.00	
	LED Light Bar, Curved 50" Long, 21500 Lumens, Cree Bulbs	AMLED50C	\$ 190.00	
	 Universal Equipment	LED Magnetic Work Light All-Position Light 3.25" Square Floodlight 900 Lumens Magnetic Base Includes Lithium Ion Battery, Cigarette Lighter and DC Charger	AMTL2460	\$ 79.00



Glass

Application	Description	Part Number	Retail Price	Core
8775, 8785, 9735, 9745, 9755, 9765, 9775, 9785, DT160, DT180, DT200, DT225, RT95, RT115, RT130, RT145, (RT100, RT120, RT135, RT150 - w/ Auto Quadrashift BSN N195047 or w/ Power Maxx CVT BSN N205026)	Door Glass, Right Hand	AM3907222M1	\$ 466.87	
	Door Glass, Left Hand	AM3907221M1	\$ 366.00	









Allis Chalmers®—Tractor

Application	Description	Part Number	Retail Price	Core
 7000, 7010, 7020, 7045, 7060, 7080, 7580, 8550 - Black Belly Tractors	Rear Side Glass	AM70591658L	\$ 51.00	
 7000, 7010, 7020, 7030, 7040, 7045, 7050, 7060, 7080	Rear Glass Replaces 70575473	AM70577185	\$ 120.00	
 160, 7000 BSN 8001, 7030, 7040, 7050, 7060 BSN 6001, 7080 BSN 3001, 7580 BSN 1605	Rear Side Glass, Right Hand	AM70577183	\$ 125.00	
	Rear Side Glass, Left Hand	AM70577184	\$ 141.50	
 200, 210, 220, 6060, 6070, 6080, 7000, 7010, 7020, 7030, 7040, 7045, 7050, 7060, 7080, 7580, 8050, 8070, 8550	Weatherstrip 250" (20') Long For Cab Door	AM79011812	\$ 60.42	
 6080, 8010, 8030, 8050, 8070	Weatherstrip 250" (20') Long For Rear Glass	AM79011812	\$ 60.42	

Air Conditioning and Components

Application	Description	Part Number	Retail Price
 7030, 7040, 7045, 7050, 7060, 7080, 7580, 8030, 8050, 8070, 4WD: 4W-220	Compressor Conversion Kit A6 or R4 to Sanden Includes Compressor, Mounting Brackets, Compressor Manifold, Binary Switch, Retrofit Adapters, O-Rings, Belt and Mounting Hardware Requires Pag Oil 100V, 6.76 oz (200 cc)	AMX10169	\$ 395.00
	Ultra Pag Double End Capped, 100V, 8 oz	AMX10267	\$ 12.00
	Universal Pag Oil, 8 oz	AMX10274	\$ 8.25
	Compressor, Sanden Requires Pag Oil 100V, 6.76 oz (200 cc)	AMX10236	\$ 245.00
	Ultra Pag Double End Capped, 100V, 8 oz	AMX10267	\$ 12.00
	Universal Pag Oil, 8 oz	AMX10274	\$ 8.25
 200, 210, 220, 7000, 7010, 7020, 7030, 7040, 7045, 7050, 7060, 7080, 7580, 8550 Replaces 70256782, 70272005	Compressor, A6 Style Superheat Compressor w/ Superheat Switch, 12 Volt, 5.58" Clutch Diameter, Coil Mounted at 2 o'clock Position	AMX10133	\$ 585.00
 200, 210, 220, 7000, 7010, 7020, 7030, 7040, 7045, 7050, 7060, 7080, 7580, 8550 Replaces 70256782, 70272002	Compressor w/ Dust Cover, HD Superheat Compressor, 12 Volt, w/ Single Groove Clutch, 5.58" (142 mm) Clutch Diameter, Can be used for 2 o'clock and 10 o'clock Positions, Must use Original Hoses and Belts, Replaces A6 Style w/ 10 Cylinder Nippondenso 10PA20 Style, Uses Less Power for Greater Efficiency Requires Pag Oil 46V, 7.00 oz (207 cc)	AMX10223	\$ 390.00
	Ultra Pag Double End Capped, 46V, 8 oz	AMX10266	\$ 12.00

Allis Chalmers®—Tractor

Application	Description	Part Number	Retail Price
 440 ASN 1461, (6240, 6250, 6260, 6265, 6275 w/ Star Cab), 7085, 7110, 7120, 7145 Replaces 4338042, 4363723, 7807944, 72085212	Compressor, Sanden Style 12 Volt, w/ 2-Groove Clutch, 6" (152 mm) Clutch Diameter, Vertical #8 and #10 Flare Connections, w/ R12 Charge Ports Requires R12 Mineral Oil, 5.91 oz (175 cc)	AMX10134	\$ 265.00
 6670 BSN 1153, 6680 BSN 1316, 6690 BSN 1928, 7600 BSN 1386, 7630 BSN 1065, 7650 BSN 1015, 8610 BSN 1388, 8630 BSN 1508 Replaces 72239750	Compressor, Sanden Style 12 Volt, w/ 2-Groove Clutch, 5.25" (133 mm) Clutch Diameter, Vertical Tube O-Ring, w/ R12 Charge Ports	AMX10132	\$ 330.00
 6670 ASN 1154, 6680 ASN 1317, 6690 ASN A1929, 7600 ASN 1387, 7630 ASN 1066, 7650 ASN 1016, 8610 ASN 1389, 8630 ASN 1509, 9130, 9150, 9170, 9190, 9630 BSN 921000, 9650 BSN 941000, 9670 BSN 961000, 9690 BSN 981000 Replaces 72162168, 72201567	Compressor, Sanden SD5H14 Style 12 Volt, w/ 2-Groove Clutch, 5.25" (133 mm) Clutch Diameter, Vertical Tube O-Ring, w/o Charge Ports Requires Synthetic Ester Oil 100V, 6.99 oz (207 cc)	AMX10131	\$ 310.00
 7000, 7010, 7020, 7030, 7040, 7045, 7050, 7060, 7080, 7580, 8550	Reman Frigidaire A6 Compressor Superheat Compressor, Superheat Switch Not Included, 12 Volt, w/ Single Groove Clutch, 5.58" (142 mm) Clutch Diameter, 0.50" Belt Width See Manufacturer for Oil Type and Quantity	AM50-013	\$ 345.00
 7080, 8010, 8030, 8050 Replaces 70272976	Compressor, A6 Style Hi-Pressure Compressor w/ Hi-Pressure Switch, 12 Volt, Coil Mounted at 2 o'clock Position, 5.58" Clutch Diameter	AMX10135	\$ 555.00
 8745, 8765, 8775, 8785, 9735, 9745, 9755, 9765, 9775, 9785, DT160, DT180, DT200, DT225, LT70, LT75A, LT85, LT90A, RT95, RT115, RT130, RT145 Replaces 3782613M2	Compressor w/ Dust Cover, Sanden 12 Volt, w/ 2-Groove Clutch, 5.50" (138 mm) Clutch Diameter, GM Pad Mount Requires Synthetic Ester Oil 100V, 6.42 oz (190 cc)	AMX10136	\$ 240.00
 9435, 9455, 9630 ASN 921001, 9635, 9650 ASN 941991, 9655, (9670, 9690 ASN 981001), 9675, 9695, 9815, GT45, GT45A, GT55, GT55A, GT65, GT65A, GT75, GT75A Replaces 72504984	Compressor, Sanden 12 Volt, w/ 2-Groove Clutch, 5.25" (133 mm) Clutch Diameter, Vertical Tube O-Ring, w/o Charge Ports Requires Synthetic Ester Oil 100V, 8.11 oz (240 cc)	AMX10130	\$ 365.00
 200, 210, 220, (7000, 7010, 7020, 7030, 7040, 7045, 7050, 7060, 7080, 7580, 8010, 8030, 8050, 8070, 8550 BSN 1636) Replaces 70256789, 70269743	Compressor Clutch w/o Coil A6 Clutch w/o Coil, 5.58" Single Groove Pulley Includes Dust Cover, Hub, Pulley and Bearing	AMX10229	\$ 145.00
 200 BSN 4000, 210, 220	Rotary Adjustable Thermostatic Switch 36" Capillary Tube	AMX10251	\$ 45.00
 9670, 9690 Replaces 71190643	High Pressure Switch Normally Closed, Opens at 375 PSI, Closes at 225 PSI 7/16"x20 Thread	AM539069R2	\$ 34.00
 Universal Equipment	High Pressure Switch Normally Open, Opens at 305 PSI, Closes at 395 PSI, 7/16"x20 Thread	AMX10276	\$ 35.00

Prices Subject to Change without Prior Notice. The use of original equipment manufacturer (OEM) part numbers or trademarks, e.g. Case® and John Deere®, are for reference purposes only and for indicating product use and compatibility. Our company and the listed replacement parts contained herein are not sponsored, approved or manufactured by the OEM. All parts are New unless designated Reman in the description.

Allis Chalmers®—Tractor





	Application	Description	Part Number	Retail Price
	Universal Equipment	Low Pressure Switch Normally Open, Opens at 6 PSI, Closes at 45 PSI, Standard 7/16"x20 Thread	AMX10277	\$ 55.00
	Universal Equipment	Low Pressure Switch Normally Open, Opens at 35 PSI, Closes at 46 PSI, Standard 7/16"x20 Thread	AMX10278	\$ 42.00
	180, 9130, 9150, 9170, 9190, 9630, 9650, 9670, 9690 Replaces 30-3347710, 72160880	Receiver Drier 3" x 8 1/4" Male Flare, Female Switch Port - OE Parker, R12 and R134a Compatible	AM72161835	\$ 30.00
	200, 210, 220, 220 FWA Replaces 70256818	Receiver Drier 3" x 6" Male Flare, R12 and R134a Compatible	AMX10211	\$ 22.00
	6060, 6070, 6080, 8010, 8030, 8050, 8070 Replaces 70264644, 70275847	Receiver Drier 4" x 8", Inlet - #6 3/8" Female O-Ring, Outlet - #6 3/8" Male O-Ring, Female Switch Port - 3/8" 24 O-Ring, R12 and R134a Compatible	AMX10155	\$ 22.00
	7000, 7010, 7020, 7030, 7040, 7045, 7050, 7060, 7080, 7580, 8550 Replaces 70258464, 70268464	Receiver Drier Receiver Drier, Import 4" x 7 1/2", Inlet - #6 Female O-Ring, Outlet - #6 Male O-Ring, R12 and R134a Compatible	AMX10154 AMX10208	\$ 25.00 \$ 22.00
	8745, 8765, 8775, 8785, 9735, 9745, 9755, 9765, 9775, 9785, DT160, DT180, DT180A, DT200, DT200A, DT220A, DT225, DT240A, LT70, LT75, LT75A, LT85, LT90, LT90A, RT100, RT100A, RT115, RT120, RT120A, RT130, RT135, RT140A, RT145, RT150, RT155A, RT165A, RT95	Receiver Drier 3" x 9" Male O-Ring, R12 and R134a Compatible	AM3712495M1	\$ 26.00
	AGCO®: ST34A, ST47A, ST52A, ST60A Replaces 6244522M91	Komatsu Receiver Drier XH9 Desiccant	AMX10239	\$ 40.00
	200 BSN 4000, 210, 220 FWA, 6060, 6070, 6080 Replaces 71506527	Expansion Valve Bulb Type, Externally Equalized, R12 and R134a Compatible, 12" Tube Length, Flare Connection	AMX10153	\$ 25.00
	200 ASN 4001, 7000 BSN 8000, 7030, 7040, 7050, 7060, 7080, 7580, 8550	Expansion Valve Bulb Type, R12 and R134a Compatible, 19" Tube Length, Flare Connection	AMX10146	\$ 20.00
	440 Replaces 72084697	Expansion Valve Internally Regulated w/ 12" Capacity Tube w/ Flare Connection, R12 and R134a Compatible	AMX10215	\$ 30.00

Allis Chalmers®—Tractor

	Application	Description	Part Number	Retail Price
	(6240, 6250, 6260, 6265, 6275 - w/ Star Cab), 6670, 6680, 6690, 6775, 7085, 7110, 7120, 7145, 7600, 7630, 7650, 8010, 8030, 8050, 8070, 8610, 8630, 9130, 9150, 9170, 9190, 9435, 9455, 9630, 9635, 9650, 9655, 9670, 9685, 9690, 9695, 9815 Replaces 71307202, 71504287, 72162195, 72274512, 72275588	Expansion Valve Block Type, R12 and R134a Compatible, O-Ring Connection	AMX10151	\$ 24.00
	7000 ASN 8001, 7010, 7020, 7045, 7060, 7080, 7580, 8550 Replaces 70261764	Expansion Valve Bulb Type, Externally Equalized, R12 and R134a Compatible, 14" Tube Length, O-Ring Connection	AMX10145	\$ 20.00
	7600, 7650, 8610, 8630, 8775, 8785, 9735, 9745, 9755, 9765, 9775, 9785, DT160, DT180, DT180A, DT200, DT200A, DT220A, DT225, DT240A, LT75, LT75A, LT85A, LT90, LT90A, LT95A, RT95, RT100, RT100A, RT110A, RT115, RT120, RT120A, RT130, RT135, RT140A, RT145, RT150, RT155A, RT165A, RT180A	Expansion Valve Flange Type, O-Ring Connection, R12 and R134a Compatible	AMX10260	\$ 25.00
	8745, 8765 Replaces 3901517M1	Expansion Valve Block Type, R12 and R134a Compatible, O-Ring Connection	AMX10150	\$ 26.00
	(190, 190XT - Heater Model Only), (210, 220 - w/ Stopler Cab) Replaces 70254964	Blower Motor Single Speed, Single Shaft, 2-Wire, Reversible, 5/16" Shaft Diameter, 1 1/2" Long	AMX10107	\$ 42.00
	200 ASN 4001 Replaces 70257336	Blower Motor Single Speed, Double Shaft, 2-Wire, Reversible, 5/16" Shaft Diameter, 2 1/2" Long	AMX10110	\$ 55.00
	440 ASN 1461, (6060, 6070, 6080 ASN 10306), 7000, (7010, 7020 BSN 2838), 7030, 7040, 7045 BSN 2838, 7050, 7060 BSN 7428, 7080 BSN 3523, 7580 BSN 2039, 8425, 8550 BSN 1521, 8630, 9130, 9150, 9170, 9190, 9435, 9455, 9630, 9635, 9650, 9655, 9670, 9675, 9690, 9695, 9815 Replaces 72085006, 70275685, 70578041, 72162089	Blower Motor 3-Speed, Double Shaft, 4-Wire, Reversible, 3/8" Shaft Diameter, 4 1/4" Long	AMX10120	\$ 80.00
	(6060, 6070, 6080 BSN 10305), (7010, 7045 ASN 2839), 7020 ASN 3358, 7060 ASN 7429, 7080 ASN 3524, 7580 ASN 2039, 8010, 8030, 8050, 8070, 8550 ASN 1521, 4WD: 4W-220, 4W-305 Replaces 72512754, 72512755	Blower Motor, Vented Single Speed, Double Shaft, 2-Wire, Reversible, 3/8" Shaft Diameter, 4 3/8" Long	AMX10118	\$ 108.00
	7000, 7010, 7020, 7045, 7060, 7080, 7580, 8010, 8050, 8070, 8550 Replaces 72512756, 72512755, 71501171	Blower Motor 12 Volt, Vented Motor, Reversible Single Speed, 2-Wire Motor w/ 3/8" Shaft	AMX10221	\$ 115.00
	7000, 7010, 7020, 7030, 7040, 7045, 7050, 7060, 7080, 7580 Replaces 70578042	Blower Wheel Reversible, Double Vented, Steel Wheel, 3 3/4" Diameter, 4" Long, 3/8" Shaft	AMX10212	\$ 19.00
	8785, 9765, 9775, 9785, AGCO® Tractors: DT180A, DT200A, DT220A, DT240A, LT75A, LT85A, LT90, LT90A, LT95A, RT95, RT100, RT100A, RT110A, RT115, RT120, RT120A, RT130, RT135, RT140A, RT145, RT150, RT155A, RT165A, RT180A, 8775, 9735, 9745	Blower Motor w/ Wheels 12 Volt, 2-Wire, 5/16" Shaft Diameter	AM3310831M91	\$ 110.00

Prices Subject to Change without Prior Notice. The use of original equipment manufacturer (OEM) part numbers or trademarks, e.g. Case® and John Deere®, are for reference purposes only and for indicating product use and compatibility. Our company and the listed replacement parts contained herein are not sponsored, approved or manufactured by the OEM. All parts are New unless designated Reman in the description.

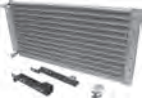
Allis Chalmers®—Tractor

	Application	Description	Part Number	Retail Price
	7010, 7020, 7030, 7040, 7045, 7050, 7060, 7080, 7580 - Early	Condenser 12" x 26" Fits both Flare and O-Ring fitting	AM70268462	\$ 265.00
	7010, 7020, 7030, 7040, 7045, 7050, 7060, 7080, 7580 - Late	Condenser 12" x 26" w/ O-Ring fitting	AM70262122L	\$ 195.00
	8010, 8030, 8050, 8070	Condenser 12" x 26"	AM70262122	\$ 225.00
	7000 BSN 8001, 7010, 7020, 7030, 7040, 7045, 7050, 7060, 7080, 7580, 8550	Evaporator Bulb Type Valve Overall: 27" x 6 3/4" x 6" Core: 20" x 6" x 2 1/2"	AM70269522	\$ 215.00
	8010, 8030, 8050, 8070, 4WD: 4W-220, 4W-305	Evaporator Block Type Valve Overall: 32 1/2" x 8 1/2" x 6 1/4" Core: 25" x 4 1/4" x 6"	AM71504002	\$ 275.00

Shop Manuals and Collections

I&T Shop Service Manuals provide the information you need to service virtually any make or model of wheel-type farm tractor. Easy-to-follow procedures, detailed illustrations and comprehensive specifications help guide you through complete tractor maintenance and repair with accuracy and efficiency.



Application	Description	Part Number	Retail Price
Models: B, C, CA, G, RC, WC, WD, WD45, WF	Allis Chalmers®	IT-AC-11	\$ 28.00
Models: 8010, 8030, 8050, 8070	Allis Chalmers®	IT-AC-36	\$ 31.00
Models: 180, 185, 190, 190XT, 200, 210, 220, 7000, 7010, 7020, 7030, 7040, 7045, 7050, 7060, 7080, D19, D21	Allis Chalmers® Collection	IT-AC-202	\$ 31.00
Models: 160, 170, 175, D10, D12, D14, D15, D17	Allis Chalmers® Collection	IT-AC-201	\$ 31.00
Models: 6240, 6250, 6260, 6265, 6275	Deutz-Allis®	IT-D-1	\$ 28.00

Gleaner®—Combine

Table of Contents

Accelerator Lug Roll Components.....	317	Cutter Bar Components.....	325
Air Conditioning and Components.....	331	Cylinder Bars and Kits.....	316
Auger Extension Kits.....	322	Discharge Bars.....	318
Augers—Bottom Bin Cross.....	321	Draper Belts.....	326
Augers—Grain Bin Loading.....	321	Elevator Chains.....	318
Augers & Tubes—Unloading.....	322	Elevator Chain Sprockets.....	319
Augers—Lower Clean Grain.....	320	Feeder Beater Parts—Misc.....	315
Augers—Lower Return.....	321	Feederhouse Chains.....	314
Beaters and Components.....	320	Feederhouse Chain Sprockets.....	315
Belts—A, C, C2, E.....	334	Feederhouse Drums and Shafts.....	315
Belts—A65, A66, A75, A76, A85, A86.....	350	Grain Tank Auger Floor Liner.....	322
Belts—C62.....	347	Guards and Cutter Bar Parts.....	326
Belts—E3, K, K2.....	335	Header Drive Shafts.....	326
Belts—F, F2, F3, G, GH.....	336	Hump Kits.....	316
Belts—Headers.....	334	Hydraulic Pumps.....	324
Belts—Hesston® 6550, 6555, 6600, 8200, 8400.....	348	Hydrostats and Components.....	314
Belts—L, L2, L3.....	340	Lighting.....	327
Belts—M, M2, M3, MH, MH2, MH3.....	338	Mainshafts.....	320
Belts—N5, N6, N7, R5, R6, R7.....	341	Platform Components.....	325
Belts—R40, R42, R50, R52.....	343	Raddle Chain False Bottoms.....	316
Belts—R55, R65, R75.....	346	Raddle Chains.....	316
Belts—R60, R70.....	344	Raddle Chain Sprockets and Idlers.....	316
Belts—R62, R66, R72, R76.....	345	Radiators.....	313
Belts—S67, S77.....	348	Rear Engine PTO Shafts and Dampers.....	313
Belts—S68, S78, S88, S96, S97, S98.....	349	Reel Components.....	325
Brakes and Components.....	314	Separator Components.....	320
Chaffer and Sieve Frame Components.....	323	Sickle Assemblies Without Heads.....	324
Chaffers—Long Finger Top.....	323	Sieves—Blunt Finger Bottom.....	323
Chaffers—Short Finger Top.....	322	Straw Chopper and Straw Spreader Components.....	324
Cleaning Fan Sprockets.....	318	Straw Walkers and Components.....	323
Concaves and Components.....	317	Thresher Shafts.....	317
Cornhead—Fenders and Snouts.....	332	Unloading Auger Collars.....	322
Cornhead—Row Unit Components.....	333		
Cornhead—Stalk Stompers.....	333		

Radiators



Application	Description	Part Number	Retail Price	Core
F2, F3 - w/ Diesel	Radiator	AM71340940	\$ 1020.00	

Rear Engine PTO Shafts and Dampers



Application	Description	Part Number	Retail Price	Core
L2 ASN 13001 w/ D3500 or 670T Diesel Engine	Engine PTO Shaft, Rear 25.125" Long, 10 Spline	AM71190214	\$ 403.63	
L3, M2, M3 - w/ D2900 or 649T Diesel Engine	Engine PTO Shaft, Rear 18.687" Long, 10 Spline	AM71192723	\$ 291.75	
F, F2, F3, G, L, L2, L3, M, M2, M3 - w/ D2900 Engine	Engine Damper Plate, Rear 1 3/8", 10 Spline Hub	AM71190940-N	\$ 160.00	

Gleaner®—Combine

Application	Description	Part Number	Retail Price	Core
L2, L3, M2, M3, N5, N6 - w/ D3500 (670 Series) Engine	Engine Damper Plate, Rear 1 3/4", 10 Spline Hub	AM71193764-N	\$ 245.00	
N7	Engine Damper Plate, Rear 10 Spline Hub	AM71318427-N	\$ 250.00	

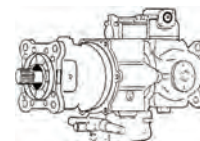

Hydrostats and Components

Application	Description	Part Number	Retail Price	Core
F, F2, F3, G, L, L2, L3, M, M2, M3, N5, N6	Hydrostat Output Shaft Fits Dynapower units, 11.25" Long, 17 & 34 Spline	AM71154856	\$ 165.00	



Brakes and Components

Application	Description	Part Number	Retail Price	Core
L ASN 2601, (L2, L3 SN 13001-28000), (M2, M3 SN 15401-25900), N5, N6, N7	Brake Disc	AM71184195	\$ 241.29	
C, C2, F, F2, K, K2, L	Brake Lining Kit for Bendix Brakes Includes (2) 6.50" OD x 3/16" non-asbestos linings with rivets (3.50" center hole) Replaces 70235607	AM70235628	\$ 25.00	



Feederhouse Chains

Our feederhouse chains utilize high-quality materials to meet or exceed OEM specifications. Slats are mounted using 3/8" grade 5 plated bolts and locknuts for easy replacement. Chains feature full side plates and high-strength steel for added durability. All feederhouse chains come with serrated slats unless otherwise noted. Call for different slats and chain configurations available to fit your application.

Application	Description	Part Number	Retail Price	Core
N5, N6, N7, R5, R6, R7, R60, R70	Front Feederhouse Chain 84 links - slat every 2nd & 4th link 3 Chain Assembly, CA557	AM71149915	\$ 685.00	
	Serrated Slat For 12.625" Chain Centers	AMX29121	\$ 18.00	
R40, R42 BSN 45000, R50, R52 BSN 55000	Front Feederhouse Chain 85 links - slat every 6th link 2 Chain Assembly, CA550	AM71149917	\$ 530.00	
	Serrated Slat For 15.675" Chain Centers	AM71344422	\$ 15.00	
R42 ASN 45001, R52 ASN 55001	Front Feederhouse Chain 97 links - slat every 6th link 2 Chain Assembly, CA557	AM71149938	\$ 630.00	
	Serrated Slat For 15.675" Chain Centers	AM71344422	\$ 15.00	
R62, R65 BSN HS62101, R72	Front Feederhouse Chain 97 links - slat every 2nd & 4th link 3 Chain Assembly, CA557 Replaces 71149871	AM71149958	\$ 895.00	
	Serrated Slat For 12.625" Chain Centers	AMX29121	\$ 18.00	
R65 ASN HS62101, R66 ASN HUT6101, R75 ASN HS72101, R76 ASN HUT7101, S67, S77	Front Feederhouse Chain, Serrated 48 Serrated Slats 4 Chain Assembly, CA557	AM71412327	\$ 1775.72	

Prices Subject to Change without Prior Notice. The use of original equipment manufacturer (OEM) part numbers or trademarks, e.g. Case® and John Deere®, are for reference purposes only and for indicating product use and compatibility. Our company and the listed replacement parts contained herein are not sponsored, approved or manufactured by the OEM. All parts are New unless designated Reman in the description.

Gleaner®—Combine

Application	Description	Part Number	Retail Price	Core
N5, N6, N7, R5, R6, R7, R60, R70	Rear Separator Chain 76 links - slat every 2nd & 4th link 3 Chain Assembly, CA550	AM71149833	\$ 595.00	
	Serrated Slat For 15.675" Chain Centers	AM71335675	\$ 15.00	
R40, R42, R50, R52	Rear Separator Chain 86 links - slat every 6th link 2 Chain Assembly, CA550	AM71149940	\$ 495.00	
	Serrated Slat For 15.675" Chain Centers	AM71344422	\$ 15.00	
R62, R65 BSN HS62101, R72	Rear Separator Chain 89 links - slat every 2nd & 4th link 3 Chain Assembly, CA557 Replaces 71149873	AM71149960	\$ 825.00	
	Serrated Slat For 12.625" Chain Centers	AMX29121	\$ 18.00	

Feederhouse Chain Sprockets

To extend the life of your chain assemblies, always replace the sprockets when installing a new chain.



Application	Description	Part Number	Retail Price	Core
C62 BSN HL26101, R42 ASN 44001, R52 ASN 54001, R62 ASN 64001, R72 ASN 74001	Feederhouse Chain Sprocket 13 Tooth, 1.75" Hex	AM71368861	\$ 58.00	
(C62, R65 ASN HM62101), R55, R66 ASN HUT6101, R75 ASN HM72101, R76 ASN HUT7101	Feederhouse Chain Sprocket 13 Tooth, 2" Hex Bore Replaces FM155	AM71394665	\$ 89.76	
N5, N6, N7, R5, R6, R7, R40 ASN 02001, R42 BSN 44001, R50 ASN 03501, R52 BSN 54001, R60, R62 BSN 64001, R70, R72 BSN 74001	Feederhouse Chain Sprocket 13 Tooth, 1.50" Hex	AM71357768	\$ 55.00	

Feederhouse Drums and Shafts

Application	Description	Part Number	Retail Price	Core
R65, R66, R75, R76, S67, S68	Upper Feederhouse Shaft	AM71394659	\$ 561.01	

Feeder Beater Parts—Misc.

Application	Description	Part Number	Retail Price	Core
M, M2, M3, MH2, MH3	Drum, Non-Floating	AM71184787	\$ 697.65	
L2, L3	Drum, Non-Floating	AM71184789	\$ 759.19	
L2, L3, M, M2, M3, MH2, MH3	Gudgeon Shaft, Splined	AM71302369	\$ 162.99	
F2, F3, K2, L2, L3, M2, M3, MH2, MH3	Finger 7 3/8" Long, 5/8" Fine Thread	AM71195242	\$ 8.00	
F, F2, F3, G, K2, L, L2, L3, M, M2, M3, MH2, MH3	Finger Guide, Poly 9/15" Diameter	AM71146965	\$ 5.98	
F, F2, F3, K2, L, L2, L3, M, M2, M3, MH2, MH3	Finger Guide, Steel 5/8" Diameter	AM71188840	\$ 11.78	

Gleaner®—Combine

Raddle Chains

Our raddle chains are made of CA550 chain and square steel tubing. Chains for hillside applications have special lugs attached to the steel slats to prevent grain sliding to the downhill side.



Application	Description	Part Number	Retail Price	Core
F, F2, F3	Raddle Chain	AM71309696	\$ 446.00	
K, K2	Raddle Chain	AM71309695	\$ 605.45	
L, L2, L3	Raddle Chain, Front Thresher	AM71309700	\$ 388.79	
	Raddle Chain, Rear Separator	AM71309697	\$ 473.00	
	Raddle Chain, Rear Separator - Hillside	AM71309697H	\$ 979.40	
M, M2, M3	Raddle Chain, Front Thresher	AM71309699	\$ 357.00	
	Raddle Chain, Rear Separator	AM71309698	\$ 457.00	

Raddle Chain False Bottoms

Application	Description	Part Number	Retail Price	Core
L, L2, L3	False Bottom Heavy Duty 12 gauge material is used, OEM is 16 gauge material	AM71154157	\$ 982.99	

Raddle Chain Sprockets and Idlers

Application	Description	Part Number	Retail Price	Core
L, L2, L3, M, M2, M3, MH, MH2, MH3	Raddle Chain Sprocket, Standard	AM71311147	\$ 48.54	
F3 ASN 51001, G, K2, L, L2, L3, M, M2, M3, MH, MH2, MH3	Raddle Chain Idler Fits 0.50" Round Shaft	AM71160426	\$ 42.80	

Hump Kits

The increased arc of the hump kit helps to prevent material build up between the feeder chain and rotor. It also increases the door sensitivity to foreign objects. 1992 and Later.

Application	Description	Part Number	Retail Price	Core
R40, R42, R50, R52	Hump Kit	AM71366830	\$ 308.16	
R60 ASN 16501, R62 ASN 67001, R70 ASN 12501, R72 ASN 77001	Hump Kit	AM71366837	\$ 355.18	

Cylinder Bars and Kits

All bars are carefully checked and sets are matched for equal weight distribution on the cylinder prior to shipment. Grade 8 fasteners are supplied for most models.



Application	Description	Part Number	Retail Price	Core
C, C2, M, M2, M3, MH, MH2, MH3	Rasp Bars, Set of 8 Hardware Included	Standard AM71124692	\$ 950.00	
N5, N6, N7, R5, R6, R7, R60 SN 12701-16500, R70 SN 8701-12500	Thresher Bars (8) Left Hand Bars w/ 1/2" x 1 1/4" NC Bolts	Chrome AM71355265	\$ 923.08	
R40, R42, R50, R52, R60 ASN 16501, R62, R70 ASN 12501, R72	Rasp Bar, Forward Bar Set of 2 - Narrow spaced teeth, 1/2"	Hardened AM71367933	\$ 93.08	
		Chrome AM71371511	\$ 115.00	
Note: Check Quantity Required for Application	Rasp Bar, Reverse Bar Set of 2 - Narrow spaced teeth, 1/2"	Hardened AM71367934	\$ 84.32	

Gleaner®—Combine

Application	Description	Part Number	Retail Price	Core
R40, R42, R50, R52, R60 ASN 16501 (P3 Processor), R62 ASN 63001, R70 ASN 12501 (P3 Processor), R72 ASN 73001, R75, R76	Rasp Bar, Forward Bar Set of 2 - Wide spaced teeth, 3/4"	Chrome AM71371520	\$ 100.00	
	Rasp Bar, Reverse Bar Set of 2 - Wide spaced teeth, 3/4"	Chrome AM71371526	\$ 139.19	

Note: Check Quantity Required for Application



Concaves and Components

Application	Description	Part Number	Retail Price	Core
A65, A66, A75, A76	Concave Set, Large Wire Set of 7 Corn and Soybean	AM104904W91	\$ 2850.00	
A65, A66, A75, A76	Concave High Wire, Narrow Space - Black	AM71390005	\$ 526.74	
F, F2, F3	Bar Channel w/ Hardware 37" Long	AM71139306	\$ 32.37	
L, L2, L3	7 Bar Concave	AM71185216	\$ 1561.49	
L, L2, L3	Bar Channel w/ Hardware 46.75" Long	AM71185115	\$ 36.40	
N5, N6, N7, R5 BSN 8001, R6 BSN 10301, R7 BSN 7001	8 Bar Concave	AM71329917	\$ 1323.09	
R40, R42, R50, R52	Thresher Concave Lo-wire, Narrow Spaced - Black	AM71369111	\$ 950.14	
R40, R50, R42, R52	Concave Grate Lo-wire, Narrow Spaced	AM71369136	\$ 945.01	
R62, R72	Thresher Concave Lo-wire, Narrow Spaced - Black	AM71370963	\$ 1537.82	
R62, R72	Concave Grate Lo-wire, Narrow Spaced	AM71377145	\$ 1715.38	



Accelerator Lug Roll Components

*Note: Will only work on units that have the bolt-on style accelerator lug rolls. Will not work with the early-version accelerator rolls.

Application	Description	Part Number	Retail Price	Core
N5*, N6*, N7*, R5, R6, R7, R40, R50, R70, R42, R52, R62, R72	Accelerator Lug Roll Kit Includes: (4) AM71352611 Lugs and (12) 3/8" x 5/8" Machine Screws	AM71339372	\$ 95.00	
	Accelerator Lug Roll	AM71352611	\$ 21.00	
N5*, N6*, N7*, R5, R6, R7, R60 SN 12701-17500, R70 SN 8701-13500	Accelerator Lug Roll Shaft	Front AM71339291 Rear AM71339287	\$ 175.00 \$ 175.00	

Thresher Shafts

Application	Description	Part Number	Retail Price	Core
N5, N6, N7, R5, R6, R7, R60, R62, R70, R72	Tube w/ Hub, Gearbox Input Shaft 9.27" Long, 47 Tooth	AM71340708	\$ 988.23	
L, L2, L3, M, M2, M3, N5, N6, N7, R40, R42, R52, R60, R62, R70, R72	Tube w/ Hub, Variable Speed Thresher Countershaft 6.16", 37 Tooth	AM71301962	\$ 492.31	

Gleaner®—Combine

Application	Description	Part Number	Retail Price	Core
L2, L3	Variable Speed Thresher Countershaft 67.59" Long	AM71318877	\$ 350.78	
M, M2, M3	Variable Speed Thresher Countershaft 63.95" Long	AM71318878	\$ 426.14	

Discharge Bars



Application	Description	Part Number	Retail Price	Core
R40 SN 1101-2000, R50 SN 1001-3500	Discharge Cylinder Bar, Short Discharge Cylinder Bar, Long	Hardened, 7" AMOGLDBL-4050H Chrome, 14" AM71348794	\$ 37.23 \$ 153.36	
R40 SN 2001-3000, R42, R50 SN 3501-4500, R52	Discharge Cylinder Bar, Long	Chrome, 11" AM71359342	\$ 122.34	
R60 ASN 16501, R62, R70 ASN 12501, R72	Discharge Cylinder Bar, Long	Chrome, 16" AM71359337	\$ 146.14	
N5 ASN 06101, N6 ASN 07301, N7, R5 ASN 08001, R6 ASN 10301, R7 SN 07001-08700, R40, R42, R50, R52 BSN 53001, R60, R62, R70, R72 ASN 73001	Blade, Impeller Processor Serrations on 1 Side	AM71357953	\$ 28.40	

Cleaning Fan Sprockets

Application	Description	Part Number	Retail Price	Core
F2, F3, K2, L, L2, M, M2	Cleaning Fan Sprocket, Single 15 Tooth, Left Hand Thread, 1" ID For 50 Chain	AM71158534	\$ 23.00	
L2, L3, M2, M3, MH2, MH3	Cleaning Fan Sprocket, Double 12 & 15 Tooth, Left Hand Thread For 50 Chain	AM71193821	\$ 40.00	

Elevator Chains

Elevator chains include rubber paddles attached with 5/16" plated bolts and nuts (unless noted in the individual description). Chains feature full side plates for added strength.



Application	Description	Part Number	Retail Price	Core
C, C2, F, F2, F3, G, K2	Clean Grain Elevator Chain 165 links - 4 3/4" x 3" paddle every 4th link	AM71149384	\$ 295.00	
L, L2, L3, M, M2, M3, MH, MH2 w/ Standard Capacity, MH3	Clean Grain Elevator Chain 160 links - 5 1/2" x 3 1/4" paddle every 4th link	AM71149453	\$ 135.77	
L, L2, L3, M2, M3, MH2, MH3 Hillside - w/ High Capacity Elevator	Clean Grain Elevator Chain 160 links - 7" x 3 3/4" paddle every 4th link	AM71149583	\$ 260.00	
N5, N6, N7, R5, R6, R7	Clean Grain Elevator Chain 133 links - 8 1/2" x 4 1/4" paddle every 4th link	AM71149578	\$ 453.85	
	Rubber Paddle 8 1/2" x 4 1/4"	AM71197156	\$ 5.42	
R40, R42, R50, R52	Clean Grain Elevator Chain 148 links - 7" x 3 3/4" paddle every 4th link	AM71149844	\$ 151.69	
C62, R40, R42, R50, R52, R62, R72	Return Grain Elevator Chain 123 links - 4 5/8" x 3" rubber paddle every 4th link	AM71149843	\$ 275.00	
R42 ASN 43001, R52 ASN 53001, R62, R72	Clean Grain Elevator Chain 152 links - 8 1/2" x 4 1/4" paddle every 4th link	AM71149814	\$ 355.00	
	Rubber Paddle 8 1/2" x 4 1/4"	AM71197156	\$ 5.42	

Gleaner®—Combine

Application	Description	Part Number	Retail Price	Core
F, F2, F3, G, K2	Return Grain Elevator Chain 165 links - 3 5/8" x 1 1/2" paddle every 8th link	AM71149475	\$ 220.00	
L, L2, L3, M, M2, M3, MH, MH2, MH3	Return Grain Elevator Chain 168 links - 4 3/4" x 1 3/8" paddle every 8th link	AM71149503	\$ 255.00	
	Rubber Paddle 4 3/4" x 1 3/8"	AM71153941	\$ 3.32	



Elevator Chain Sprockets

To extend the life of your chain assemblies, always replace the sprockets when installing a new chain.

Application	Description	Part Number	Retail Price	Core
A, E, F, G, K	Clean Grain Elevator Chain Sprocket, Upper 8 Tooth, 0.875" Round	AM71132829	\$ 33.00	
C62, R42, R52, R62, R72, S67, S77, S78, S88	Clean Grain Elevator Chain Sprocket, Upper 8 Tooth Sprocket w/o Hub	AM71373688	\$ 57.54	
L, L2, L3, M, M2, M3, MH, MH2, MH3	Clean Grain Elevator Chain Sprocket, Upper 8 Tooth, 1.00" Round	AM71147756	\$ 20.00	
N5 BSN 6101, N6 BSN 7301, N7 BSN 4501, R5, R6, R7	Clean Grain Elevator Chain Sprocket, Upper 8 Tooth, 1.00" Round	AM71195866	\$ 76.07	
N6 ASN 7301, N7 ASN 4501, R60, R70	Clean Grain Elevator Chain Sprocket, Upper 8 Tooth, 1.25" Round	AM71327970	\$ 90.80	
R40, R50	Clean Grain Elevator Chain Sprocket, Upper 8 Tooth, 1.00" Round	AM71361974	\$ 25.00	
R42, R52, R62 BSN 63001, R72 BSN 73001	Clean Grain Elevator Chain Sprocket, Upper 8 Tooth Sprocket w/o Hub	AM71365825	\$ 42.00	
A, E, F, G, K, L, L2, L3, M, M2, M3, MH, MH2, MH3	Clean Grain Elevator Chain Sprocket, Lower 8 Tooth, 1.00" Round	AM71147756	\$ 20.00	
C62, R42, R52, R62, R72, S67, S77, S78, S88	Clean Grain Elevator Chain Sprocket, Lower 8 Tooth Sprocket w/o Hub	AM71373688	\$ 57.54	
N5, N6, N7, R5, R6, R7	Clean Grain Elevator Chain Sprocket, Lower 8 Tooth w/ 5/16" Pin Hole, 1.25" Round	AM71196628	\$ 63.71	
N7 BSN 4501	Clean Grain Elevator Chain Sprocket, Lower 8 Tooth, 1.00" Round	AM71195866	\$ 76.07	
R5, R6, R7, R40, R50, R60, R70	Clean Grain Elevator Chain Sprocket, Lower 8 Tooth w/ 0.375" Pin Hole, 1.00" Round	AM71352665	\$ 39.00	
R42, R52, R62 BSN 63001, R72 BSN 73001	Clean Grain Elevator Chain Sprocket, Lower 8 Tooth Sprocket w/o Hub	AM71365825	\$ 42.00	
A, E, F, G, K	Return Grain Elevator Chain Sprocket, Upper 8 Tooth, 1.84" Round	AM71126055	\$ 28.00	
C62, R42, R52, R62, R72, S67, S77, S78, S88	Return Grain Elevator Chain Sprocket, Upper 8 Tooth Sprocket w/o Hub	AM71373688	\$ 57.54	
N5, N6, N7, R5, R6, R7, R60	Return Grain Elevator Chain Sprocket, Upper 8 Tooth, 1.00" Round	AM71147756	\$ 20.00	
R40, R50	Return Grain Elevator Chain Sprocket, Upper 8 Tooth, 1.00" Round	AM71361974	\$ 25.00	
R42, R52, R60, R70	Return Grain Elevator Chain Sprocket, Upper 8 Tooth Sprocket w/o Hub	AM71365825	\$ 42.00	
A, E, F, G, K	Return Grain Elevator Chain Sprocket, Lower 8 Tooth, 0.875" Round	AM71132829	\$ 33.00	
C62, R42, R52, R62, R72, S67, S77, S78, S88	Return Grain Elevator Chain Sprocket, Lower 8 Tooth Sprocket w/o Hub	AM71373688	\$ 57.54	
L, L2, L3, M, M2, M3, MH, MH2, MH3	Return Grain Elevator Chain Sprocket, Lower 8 Tooth, 1.00" Round	AM71147756	\$ 20.00	
N5, N6, N7, R5, R6, R7, R40, R50, R60, R70	Return Grain Elevator Chain Sprocket, Lower 8 Tooth, 1.00" Round	AM71361974	\$ 25.00	

Gleaner®—Combine

Application	Description	Part Number	Retail Price	Core
R42, R52, R60, R70	Return Grain Elevator Chain Sprocket, Lower 8 Tooth Sprocket w/o Hub	AM71365825	\$ 42.00	

Mainshafts

Application	Description	Part Number	Retail Price	Core
N5 SN 3191-6100, N6 SN 3856-7300, N7 SN 1768-4500	Mainshaft	AM71327295	\$ 275.00	
N5 ASN 6101, N6 ASN 7301, N7 ASN 4501, R5, R6, R7	Mainshaft, Right Hand	AM71341482	\$ 475.00	

Separator Components

Application	Description	Part Number	Retail Price	Core
F, F2, F3	Raddle Drive Shaft 50.12" Long	AM71138146	\$ 110.40	
R62 ASN 66001, R65, R66, R72 ASN 76001, R75, R76, S67, S77	Shaker Shoe Eccentric Shaft 70.06" Long	AM71371841	\$ 190.67	
R65 ASN HS62101, R66, R75 ASN HS72101, R76, S67, S77	Hex Shaft For Rear Conveyor	AM71395894	\$ 346.56	
F2, F3, K2, L, L2, L2 Rice, L3, M, M2, M2 Rice, M3, MH, MH2, MH3	Shoe Drive Sprocket, Left Hand 56 Tooth, 11.50" OD, 3.506" ID For 50 or 2050 chain	AM71158564	\$ 54.00	
G, L, L2, L2 Rice, L3, M, M2, M2 Rice, M3, MH, MH2, MH3	Shoe Drive Sprocket w/ Crank, Right Hand 13 Tooth Sprocket, 5.555" OD, 1.25" ID For 2050 Chain	AM71137876	\$ 55.00	

Beaters and Components

Heavy-duty, balanced beaters are made with abrasive-resistant 3/16" steel.

Application	Description	Part Number	Retail Price	Core
L, L2, L3	Separator Beater	AM71138247	\$ 595.40	
M, M2, M3, MH, MH2, MH3	Thresher Beater	AM71303606	\$ 584.54	
	Separator Beater	AM71158484	\$ 200.00	

Augers—Lower Clean Grain

All augers are made with continuous roll-formed flighting for accuracy and durability.



Application	Description	Part Number	Retail Price	Core
L Regular Capacity BSN 15000, L2	Lower Clean Grain Auger 89" Long, 6.50" Flighting Diameter, 1" Shaft Diameter	AM71180426	\$ 181.29	
	Bearing	NPS100RPC	\$ 6.50	
L High Capacity ASN 15500	Lower Clean Grain Auger Extended Wear, 90 3/4" Overall Length, Left Hand Flighting, 6 1/2" Flighting Diameter, 1" Shaft Diameter, 6 1/2" Pitch	AM71186212	\$ 214.00	
	Bearing	NPS100RPC	\$ 6.50	
L SN 15500-28000	Lower Clean Grain Auger, Extended Wear 91.50" Long, 6" Flighting Diameter	AM71189602	\$ 205.00	
	Bearing	NPS100RPC	\$ 6.50	

Gleaner®—Combine

Application	Description	Part Number	Retail Price	Core
(M, M2, M3 - High Capacity BSN 18400)	Lower Clean Grain Auger 82.80" Long	AM71187636	\$ 187.34	
	Bearing	NPS100RPC	\$ 6.50	
M2 SN 15401-18400	Lower Clean Grain Auger 81" Long	AM71180429	\$ 128.40	
	Bearing	NPS100RPC	\$ 6.50	
M2 ASN 15401, M3	Lower Clean Grain Auger, Extended Wear 83.50" Long	AM71189603	\$ 215.00	
M2, M3 S/N 15401-18400	Bearing	NPS100RPC	\$ 6.50	
N5, N6, N7, R5, R6, R7, R60, R70	Lower Clean Grain Auger Extended Wear, 89 1/2" Overall Length, Right Hand Flighting, 7" Flighting Diameter, 1 1/4" Shaft Diameter, 7" Pitch	AM71352664	\$ 299.00	
	Bearing - 2 Required	NA206-20	\$ 20.00	



Augers—Lower Return

All augers are made with continuous roll-formed flighting for accuracy and durability.

Application	Description	Part Number	Retail Price	Core
L SN 2601-15000	Lower Return Auger 80.75" Long	AM71180431	\$ 208.86	
	Bearing	NPS100RPC	\$ 6.50	
L SN 15500-28000	Lower Return Auger 81.00" Long	AM71300128	\$ 250.96	
	Bearing	NPS100RPC	\$ 6.50	
M BSN 18400	Lower Return Auger 72.625" Long	AM71180434	\$ 66.93	
	Bearing	NPS100RPC	\$ 6.50	
N5, N6, N7, R5, R6, R7, R60, R70	Lower Return Auger 76.25" Long	AM71339811	\$ 249.71	
	Bearing - (2) Required	WPS100GPC	\$ 15.00	
R40, R42 BSN 43000, R50, R52 BSN 53000	Lower Return Auger 62.125" Long	AM71357502	\$ 220.20	
	Bearing	WPS100GPC	\$ 15.00	
R62, R65, R66, R72, R75, R76, S67, S77	Lower Return Auger 70.385" Long	AM71364643	\$ 300.29	

Augers—Bottom Bin Cross

Application	Description	Part Number	Retail Price	Core
R66, R76, S67, S68, S77, S78, S88	Bottom Bin Cross Auger 14" Swivel Extended 121.875" Long, 2.375" Shaft Diameter	AM71426587	\$ 1162.84	

Augers—Grain Bin Loading

Application	Description	Part Number	Retail Price	Core
R40, R42, R50, R52 BSN 053001	Grain Bin Loading Auger 55.87" Long, 1.25" Shaft Diameter Replaces 71335973	AM71388935	\$ 453.49	

Gleaner®—Combine

Application	Description	Part Number	Retail Price	Core
R66, R76, S67, S68, S77, S78, S88	Grain Bin Loading Auger Extended Wear 73.312" Long	AM71426614	\$ 1260.75	

Augers & Tubes—Unloading

All augers are made with continuous roll-formed flighting for accuracy and durability.



Application	Description	Part Number	Retail Price	Core
L, M, N5, N6, N7	Unloading Auger 149.375" Long	AM71340154	\$ 760.48	
L, M, N5, N6, N7, R40, R42, R50, R52 Late	Unloading Auger, Extended Wear 164.125" Long	AM71340156	\$ 882.71	
R5, R6, R7, R60, R62, R70, R72	Unloading Auger, Extended Wear-Sectional 196.00" Long	AM71374184	\$ 1219.66	
L2, L3, M2, M3, N5, N6, N7, R40	Unloading Auger Tube 145.25" Long	AMTG83	\$ 465.00	

Unloading Auger Collars

These unloading auger collars feature nylon-coated plates (instead of ball bearings) to eliminate clogging and decrease wear.



Application	Description	Part Number	Retail Price	Core
F2 ASN 36201, F3 ASN 49601, K2 ASN 25201	Unloading Auger Collar Includes clamp and cover	AM71339770	\$ 1171.06	
L ASN 26001, L2, L3, M ASN 24701, M2, M3, N5 ASN 4501, N6 ASN 5101, N7, R40, R50	Unloading Auger Collar Includes clamp and cover	AM71373910	\$ 1730.80	

Auger Extension Kits

These kits extend the length of your unloading auger approximately three feet and increase your clearance for larger platforms and grain carts. Includes spring-loaded grain saver.

Application	Description	Part Number	Retail Price	Core
N5, N6, N7, R60, R62, R70, R72	Unloading Auger Extension Kit	AMGL2EXT-12	\$ 2025.00	
R65, R75, S77	Unloading Auger Extension Kit	AMGL2EXT-14	\$ 1735.00	

Grain Tank Auger Floor Liner

Application	Description	Part Number	Retail Price	Core
All Models	Grain Tank Auger Floor Liner Kit	AMX27143	\$ 220.00	

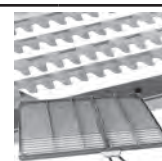

Chaffers—Short Finger Top

Adjustable short finger chaffer with 1 1/8" wire spacing. For use in cereal and fine seed crops.

Application	Description	Part Number	Retail Price	Core
L, L2 BSN 19501	Short Finger Top Chaffer, Short Shoe	52.69" x 49.34" AM71152658	\$ 928.94	
L2 ASN 19501, L3	Short Finger Top Chaffer, Long Shoe	52.69" x 56.60" AM71308755	\$ 740.00	
M2 ASN 21900, M3	Short Finger Top Chaffer, Long Shoe	44.69" x 56.60" AM71308754	\$ 731.94	
N5, N6, N7, R5, R6, R7, R60, R62, R70, R72	Short Finger Top Chaffer, Short Shoe	62.44" x 49.34" AM71323676	\$ 1253.61	
R40, R42, R50, R52	Short Finger Top Chaffer, Short Shoe	41.67" x 49.34" AM71330722	\$ 982.64	

Gleaner®—Combine

Application	Description	Part Number	Retail Price	Core
R62, R72, R75	Short Finger Top Chaffer, Long Shoe	62.44" x 63.94" AM71373460	\$ 795.00	



Chaffers—Long Finger Top

Adjustable long finger chaffers with 1 5/8" wire spacing. For use in large seed crops such as corn and beans.

Application	Description	Part Number	Retail Price	Core
L2 ASN 19501, L3	Long Finger Top Chaffer, Long Shoe	52.69" x 56.60" AM71320090	\$ 1093.02	
N5, N6, N7, R5, R6, R7, R60, R62, R70, R72	Long Finger Top Chaffer, Short Shoe	62.44" x 49.34" AM71323677	\$ 581.53	
R62, R72, R75	Long Finger Top Chaffer, Long Shoe	62.44" x 63.94" AM71373461	\$ 775.00	

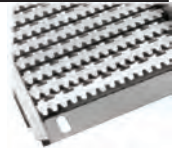

Sieves—Blunt Finger Bottom

Adjustable, blunt finger sieves with 1 1/8" wire spacing. For use in cereal and fine seed grains.

Application	Description	Part Number	Retail Price	Core
L, L2 BSN 19500	Blunt Finger Bottom Sieve, Short Shoe	51.00" x 44.75" AM71152664	\$ 812.34	
L2 ASN 19501, L3	Blunt Finger Bottom Sieve, Long Shoe	51.13" x 52.63" AM71308757	\$ 650.00	
N5, N6, N7, R5, R6, R7, R60, R62, R70, R72	Blunt Finger Bottom Sieve, Short Shoe	60.75" x 42.63" AM71322700	\$ 860.00	
R40, R42, R50, R52	Blunt Finger Bottom Sieve, Short Shoe	40.00" x 42.63" AM71330723	\$ 885.33	
R62, R72, R75	Blunt Finger Bottom Sieve, Long Shoe	60.75" x 57.25" AM71369796	\$ 615.00	

Chaffer and Sieve Frame Components

Application	Description	Part Number	Retail Price	Core
(F2, F3 SN 024201-027200), K2 BSN 027201	Shoe Drive Sprocket, Left Hand 56 Tooth, 11.50" OD For Size 50 or 2050 Chain	AM71189701	\$ 230.36	
L2, L3, M2, M3, N5, N6, N7, R5, R6, R7, R40, R42, R50, R52, R60, R62, R70, R72	Shoe Bushing 2.218" OD x 1.25" Long	AM71194972	\$ 9.73	
C, C2, E, E3, F, F2, F3, G, K, K2, L, L2, L3, M, M2, M3, N5, N6, N7, R5, R6, R7, R40, R42, R50, R52, R60, R62, R70, R72	Shoe Hanger Bushing 1.168" OD x 1.45" Long	AM71118097	\$ 6.37	



Straw Walkers and Components

Application	Description	Part Number	Retail Price	Core
F2 SN 36201-49600, F3 SN 39201-51001, K2 SN 25201-27200	Straw Walker, Lip-Type	AM71315196	\$ 410.52	
L, L2, L3	Straw Walker	AM71171501	\$ 637.58	
E, E2, E3, F, F2, F3, G, K, K2, L, L2, L3, M, M2, M3, MH, MH2, MH3	Straw Walker Wood Bearing Blocks Set of 2	AM71308646	\$ 12.00	
F, F2, F3 BSN 053001, K	Straw Walker Crank Drive Sprocket 19 Tooth	AM71137702	\$ 61.60	



Straw Chopper and Straw Spreader Components

Application	Description	Part Number	Retail Price	Core
L, L2, L3, M, M2, M3, MH, MH2, MH3	Straw Chopper Blade Kit Set of 3 Hardened-Steel Blades Includes Hardware	AM71310275	\$ 20.00	
N5, N6, N7, R5, R6, R7, R40, R42, R50, R52, R60, R62, R70, R72	Straw Chopper Blade Kit Set of 2 Blades Includes Mounting Hardware, Contains Long and Short Bolts for Inside or Outside Mounting	AM71376992	\$ 50.00	
A65, A66, A75, A76, A85, A86	Straw Chopper Blade, Paddle, Right Hand 6.77" Long, 0.187" Thick, 0.765" Hole Diameter	AM71382759	\$ 10.86	
	Straw Chopper Blade, Paddle, Left Hand 6.77" Long, 0.187" Thick, 0.765" Hole Diameter	AM71382758	\$ 10.86	
	Straw Chopper Blade Bushing Package of 4 0.412" ID, 1.25" OD	AM71382257	\$ 8.25	
R42 ASN 43001, R52 ASN 53001, R55, R62 ASN 63001, R65, R66, R72 ASN 73001, R75, R76	Rubber Curtain For Single Spreader	AM71370405	\$ 146.25	
R62 ASN 63001, R65, R66, R72 ASN 73001, R75, R76	Rubber Curtain, Right Hand For Dual Spreader	AM71374598	\$ 92.18	
	Rubber Curtain, Left Hand For Dual Spreader	AM71374603	\$ 72.89	

Hydraulic Pumps

Application	Description	Part Number	Retail Price	Core
C, F, G, K w/o Reservoir on Pump	Hydraulic Pump Single Stage Pump, ID # - 24305-LLA	AM71152819	\$ 535.00	
L, L2, L3, M, M2, M3	Hydraulic Pump Dual Stage Pump, ID # - 24386-LAQ	AM71348232	\$ 1295.00	

Sickle Assemblies Without Heads



Application	Description	Part Number	Retail Price	Core
300 Series (1985 and Later), 400 Series, 500 Series, 700 Rigid, 800 Flex, 7000 Rigid, 8000 Flex	Sickle Assembly w/o Head, Coarse	15' AM71342615	\$ 525.00	
	Sickle Assembly w/o Head, Coarse	16' AM71342616	\$ 550.00	
	Sickle Assembly w/o Head, Coarse	18' AM71342618	\$ 620.00	
	Sickle Assembly w/o Head, Coarse	20' AM71342620	\$ 695.00	
	Sickle Assembly w/o Head, Coarse	24' AM71342524	\$ 760.00	
	Sickle Assembly w/o Head, Coarse	27' AM71342527	\$ 850.00	
	Sickle Assembly w/o Head, Coarse	30' AM71342530	\$ 920.00	

Gleaner®—Combine

Cutter Bar Components

Application	Description	Part Number	Retail Price	Core
300 Series (1985 and Later), 400 Series, 500 Series, 700 Rigid, 800 Flex, 7000 Rigid, 8000 Flex	Wear Plate	AMX29058	\$ 4.00	
	Sickle Section, 3" Fine Sold in Multiples of 25, Priced Individually	AM71135136	\$ 2.35	
	Sickle Section, 3" Coarse Sold in Multiples of 25, Priced Individually	AM71135135LS	\$ 2.90	
	Hold Down Clip	AMX29059	\$ 6.00	

Reel Components

Application	Description	Part Number	Retail Price	Core
Platforms: 700, 800, 7000, 7200, 8000, 8200, 9250 Replaces 71389106	Reel Tine Nylon, Double Wing Unit, 6" Spacing Includes Hardware Sold in Multiples of 25, Priced Individually	AMX27222	\$ 2.25	
Platforms: 700, 800, 7000, 7200, 8000, 8200, 9250 Replaces 71389108	Reel Tine, Right Hand Wing 6" Spacing, Includes Hardware	AMX29057	\$ 3.76	
Platforms: 700, 800, 7000, 7200, 8000, 8200, 9250 Replaces 71389107	Reel Tine, Left Hand Wing Nylon, 6" Spacing Includes Hardware	AMX29056	\$ 3.76	
Platforms: 700, 800, 7000, 8000, Draper Platforms: 5000, 5100, AGCO® Platforms: 8000, 8050, Draper Platforms: 5000, 5200, Swathers: 8100, 8200, 8400	Reel Tine, Flexible Tear Drop Style Replaces 276306M1, 700708862, 800714195	AM86562205	\$ 2.26	
AGCO® Platform: 300 Replaces 2763156M1, 71345318	Reel Tine For Platforms w/ Tear Drop Bats and Tines Mounted to Rear of the Steel Bat	AM1970586C1	\$ 1.58	
AGCO® Platforms: 300 Series, 400 Series, 500 Series, 700 Series, 800 Series Replaces 71367261	Reel Tine Nylon, 3-Piece Double Wing Unit 4.50" Spacing Includes Hardware Sold in Multiples of 25, Priced Individually Replaces center tine, some modification required for right and left hand sides	AMTINE	\$ 2.00	
AGCO® Platforms: 300, 400, 500, 700, 800	Quick Fingers, 10 Pack	AMX27550	\$ 22.00	
AGCO® Platforms: 300, 400, 500, 700, 800, 7000, 7200, 8000, 8200	Reel Bearing	AMH136954	\$ 3.20	
Platform: 500	Reel Repair Kit, Roll Pin Style For reel pipes w/ 4 1/2" reel finger spacing and roll pins or plastic washers on each side of the plastic bearing	AMBN-KITRP	\$ 29.50	
Platforms: 7000, 7200, 8000, 8200	Reel Repair Kit, Hex Hole Style For Reel pipes w/ hex holes on the bottom of the pipes and 6" reel finger spacing	AMBN-KITHXH	\$ 35.00	

Platform Components

Application	Description	Part Number	Retail Price	Core
7200, 8200	Auger Finger 3/4"x10 UNC Right Hand Thread 0.75" OD, 10.94" Overall Length, 1.62" Thread Length	AM71453629	\$ 13.80	

Gleaner®—Combine

Guards and Cutter Bar Parts

Application	Description	Part Number	Retail Price	Core
Platform: 3020	Sickle Section, Fine Sold in Multiples of 25, Priced Individually Replaces 28280148	AM84429103	\$ 0.99	
Platforms: 300, 400, 500, 700, 800, 7000, 7200, 8000, 8200, 9250, 9255	Knife Guard, Double Pronged Replaces 7116504, 71386962	AM71341601	\$ 10.00	
Platforms: 400 Series, 500 Series, 700 Series, 800 Series, 8000 Series - w/ Cleancut System	Knife Guard, Double Prong Top	AM311794160	\$ 10.00	
AGCO® Platforms: 9020, 9125, 9140 Replaces 700707147, 700716292	Knife Guard, Double Pronged w/ Trash Bar Use w/ 3" Cutter Bar Knife	AM86615982	\$ 11.75	
AGCO® Platforms: 400, 500, 700, 700C, 800, 800C, 7000, 8000	Knife Clip, Low Profile Adjustable Replaces 1307280C3, 71346158, 86630786, H84412	AMX29115	\$ 14.75	
	Knife Clip, Low Profile Replaces 1307280C3, 71346158, 86630786, H84412	AMX27554	\$ 3.95	

Header Drive Shafts

Application	Description	Part Number	Retail Price	Core
R62, R65, R72, R75, S77	Pivot Shaft	AM71366039	\$ 205.68	
S67, S77	Jackshaft Header Drive, Variable Speed	AM71480995	\$ 236.75	





Draper Belts

Application	Description	Part Number	Retail Price	Core
Draper Platform: 600	Draper Belt 18', 41" x 150.50" Single V-Guide	AM700726373	\$ 392.00	
	Draper Belt 22', 41" x 205.55" Single V-Guide	AM700719982	\$ 457.00	
	Draper Belt 25', 41" x 229.25" Overall Dimensions Single V-Guide	AM700726014	\$ 502.00	
	Draper Belt 30', 41" x 289.65" Single V-Guide	AM700719983	\$ 625.00	
Draper Platform: 600	Draper Center Feeder Belt 60" x 57.46"	AM71401899	\$ 459.00	
	Side Draper Belt 36', Right and Left Hand, 41" x 348"	AM700726008	\$ 731.00	
	Side Draper Belt 36', Right and Left Hand, 41" x 396"	AM700726007	\$ 847.00	







Gleaner®—Combine

Application	Description	Part Number	Retail Price	Core
Draper Platform: 9250	Draper Center Feeder Belt 25', 30', 35' or 40', 51.50" x 62.99"	AM71413887	\$ 395.00	
	Side Draper Belt 25', Right and Left Hand, 41" x 243.70" Single V-Guide	AM71483146	\$ 599.00	
	Side Draper Belt 30', Right and Left Hand, 41" x 303.70" Single V-Guide	AM71483144	\$ 724.00	
	Side Draper Belt 35', Right and Left Hand, 41" x 363.70" Single V-Guide	AM71483142	\$ 843.00	
	Side Draper Belt 40', Right and Left Hand, 41" x 423.70" Single V-Guide	AM71483140	\$ 962.00	

Lighting

Application	Description	Part Number	Retail Price	Core
 Universal Equipment	LED Floodlight All-Position Light 4.25" x 4.25" Square Light 2650 Lumens, 48 Watts, 4 Amps For 12 Volt to 24 Volt Systems Includes Mounting Bracket and Stainless Steel Hardware	AMTL105F	\$ 95.00	
 Universal Equipment	LED Floodlight All-Position Light 6.25" x 1.75" Rectangle Light 1300 Lumens, 18 Watts, 1.50 Amps For 12 Volt to 24 Volt Systems Includes Mounting Bracket and Stainless Steel Hardware	AMTL118F	\$ 50.00	
 Universal Equipment	LED Floodlight All-Position Light 5" Round Light 3200 Lumens, 40 Watts, 3.30 Amps For 12 Volt to 24 Volt Systems Includes Mounting Bracket and Stainless Steel Hardware	AMTL180	\$ 89.00	
 Universal Equipment	LED Floodlight All-Position Light Round Light 6900 Lumens, 50 Watts, 4.10 Amps For 9 Volt to 32 Volt Systems Includes Mounting Bracket and Stainless Steel Hardware	AMTL500F	\$ 120.00	
	LED Floodlight All-Position Light 4.30" Round Light 5040 Lumens, 50 Watts, 4.10 Amps For 12 Volt to 24 Volt Systems Includes Stainless Steel Adjustable Mounting Bracket	AMAT305931	\$ 96.00	
 Universal Equipment	LED Floodlight All-Position Light 4.25" Round Light 2650 Lumens, 42 Watts, 3.50 Amps For 12 Volt to 24 Volt Systems Includes Mounting Bracket and Stainless Steel Hardware	AMTL115F	\$ 59.00	
Universal Equipment	LED Wide Floodlight All-Position Light 5" x 7" Rectangle Light 3800 Lumens, 35 Watts For 12 Volt to 24 Volt Systems	AMX34171	\$ 60.00	

Gleaner®—Combine





Application	Description	Part Number	Retail Price	Core
	Universal Equipment LED Floodlight, Sealed Beam Fender Mount 4.50" Diameter Round Light 1250 Lumens, 18 Watts, 1.50 Amps Trapezoid Pattern For 12 Volt to 24 Volt Systems	AMTL3010	\$ 40.00	
	LED Floodlight Fender Mount 4.50" Diameter Sealed Beam Round Light 1250 Lumens, 18 Watts, 1.20 Amps Trapezoid Pattern For 12 Volt to 24 Volt Systems Lasts 50 times longer than halogen lighting, vibration resistant w/ no filament failures, uses original mount and wiring, Operating temperature of -40°F to 140°F / -40°C to 60°C	AMRE336111	\$ 35.00	
	Universal Equipment LED Floodlight Fender Mount 4.50" Diameter Sealed Beam Round Light 1440 Lumens, 18 Watts, 1.60 Amps Lasts 50 times longer than halogen lighting, vibration resistant w/ no filament failures, 2-terminal connection, Operating temperature of -40°F to 140°F / -40°C to 60°C	AMRE336112	\$ 67.75	
	Universal Equipment LED Floodlight Cab and Fender Mount 3.50" x 6" Rectangle Light 3600 Lumens, 40 Watts, 3 Amps	AMX34146	\$ 65.00	
	Universal Equipment LED Spotlight All-Position Light 4.25" x 4.25" Square Light 1400 Lumens, 27 Watts, 2.20 Amps For 12 Volt to 24 Volt Systems	AMTL100S	\$ 45.00	
	Universal Equipment LED Spotlight All-Position Light 6.25" x 1.75" Rectangle Light 1300 Lumens, 18 Watts, 1.50 Amps For 12 Volt to 24 Volt Systems Includes Mounting Bracket and Stainless Steel Hardware	AMTL118S	\$ 50.00	
	Universal Equipment LED Spotlight All-Position Light Round Light 6900 Lumens, 50 Watts, 4.10 Amps For 9 Volt to 32 Volt Systems Includes Mounting Bracket and Stainless Steel Hardware	AMTL500S	\$ 120.00	
	Universal Equipment LED Trapezoid Light Cab and Fender Mount 4.50" Diameter Round Light 2800 Lumens, 40 Watts, 3.30 Amps Trapezoid Pattern For 12 Volt to 24 Volt Systems Bottom Mount w/ Built-In Heat Sink Includes Mounting Bracket, Long and Short Rubber Bezels and Stainless Steel Hardware	AMTL2080	\$ 95.00	
	LED Trapezoid Light Cab and Rear Fender Mount 4.50" Diameter Round Light 2800 Lumens, 40 Watts, 3.30 Amps Trapezoid Pattern For 12 Volt to 24 Volt Systems Bottom Mount w/ Built-In Heat Sink Includes Mounting Bracket, Long and Short Rubber Bezels and Stainless Steel Hardware	AMX33121	\$ 76.00	

Gleaner®—Combine

Application	Description	Part Number	Retail Price	Core
	Universal Equipment LED Warning Beacon 360° Flashing Beacon 2.75" x 5.25" Light Polycarbonate Amber Lens and Housing For 12 Volt to 24 Volt Systems Includes Solid Mounting Pad and Stainless Steel Hardware	AMTL2100	\$ 30.00	
	Universal Equipment LED Warning Light Cab, Header or Swather Mount Can be used for Turn Signal, Brake or Running Lights 4.125" Diameter Round Light Double Sided, Amber Lenses 25 Bulbs per Side For 12 Volt to 24 Volt Systems	AMTLFL2	\$ 55.00	
	LED Warning Light Cab, Header or Swather Mount Can be used for Turn Signal, Brake or Running Lights 4.125" Diameter Round Light Double Sided, Amber Lenses 25 Bulbs per Side For 12 Volt to 24 Volt Systems	AMX1910149	\$ 44.00	
	Universal Equipment LED Warning Light Cab, Header or Swather Mount Can be used for Turn Signal, Brake or Running Lights 4.125" Diameter Round Light Double Sided, Red and Amber Lenses 25 Bulbs per Side For 12 Volt to 24 Volt Systems	AMTLFL3	\$ 55.00	
	LED Warning Light Cab, Header or Swather Mount Can be used for Turn Signal, Brake or Running Lights 4.125" Diameter Round Light Double Sided, Red and Amber Lenses 25 Bulbs per Side For 12 Volt to 24 Volt Systems	AMX33126	\$ 44.00	
	Universal Equipment LED Magnetic Warning Light All-Position Light 360° Flashing Light, Multiple Patterns 9.50" x 6.75" Rectangle Light Magnetic Base or Solid Mount For 12 Volt to 24 Volt Systems Includes Cigarette Lighter Adapter, Wiring and Switch	AMTL1100	\$ 170.00	
	Universal Equipment LED Magnetic Warning Light All-Position Light 360° Flashing Light, Multiple Patterns 14" x 6.75" Rectangle Light Magnetic Base or Solid Mount For 12 Volt to 24 Volt Systems Includes Cigarette Lighter Adapter, Wiring and Switch	AMTL1200	\$ 190.00	
	Universal Equipment Warning Beacon 360° Flashing Beacon, Amber Lens For 0.9435" Diameter Pipe Replaces 84337818, AZ44705, AZ101891	AM82018390	\$ 45.64	
	Universal Equipment LED Warning Beacon 360° Flashing Beacon, 3 Different Patterns 5" x 10" Light Amber Lens, 48 Watts, 4 Amps For 12 Volt to 24 Volt Systems Brackets Sold Separately	AMX33131	\$ 75.00	
	Universal Equipment Warning Beacon Bracket	AMX33132	\$ 15.00	

Prices Subject to Change without Prior Notice. The use of original equipment manufacturer (OEM) part numbers or trademarks, e.g. Case® and John Deere®, are for reference purposes only and for indicating product use and compatibility. Our company and the listed replacement parts contained herein are not sponsored, approved or manufactured by the OEM. All parts are New unless designated Reman in the description.

Gleaner®—Combine





	Application	Description	Part Number	Retail Price	Core
	Universal Equipment	Warning Beacon Bracket	AMX33133	\$ 15.00	
	Universal Equipment	Warning Beacon Bracket	AMX33137	\$ 15.00	
	Universal Equipment	Warning Beacon Bracket	AMX33135	\$ 15.00	
	Universal Equipment	LED Light Bar 4" Long, 1260 Lumens, Cree Bulbs	AMLED4	\$ 45.00	
		LED Light Bar Flood/Spotlight Combo 10" Long, 5700 Lumens, 50 Watts, 4.20 Amps For 12 Volt to 24 Volt Systems Includes Mounting Bracket and Stainless Steel Hardware	AMTL10SRC	\$ 129.00	
		LED Light Bar Floodlight/Spotlight Combo 14" Long, 5400 Lumens, 72 Watts, 6 Amps Die Cast Aluminum Housing, Polycarbonate Lens For 12 Volt to 24 Volt Systems Includes Mounting Bracket and Heavy Duty Stainless Steel Hardware	AMTLB410C	\$ 150.00	
		LED Light Bar Floodlight/Spotlight Combo 30" Long, 13600 Lumens, 150 Watts, 12.50 Amps For 12 Volt to 24 Volt Systems Includes Mounting Bracket and Stainless Steel Hardware	AMTL30SRC	\$ 230.00	
		LED Light Bar 30" Long, 13860 Lumens, Cree Bulbs	AMLED30	\$ 130.00	
		LED Light Bar Floodlight/Spotlight Combo 40" Long, 17300 Lumens, 200 Watts, 16.70 Amps For 12 Volt to 24 Volt Systems Includes Mounting Brackets and Stainless Steel Hardware	AMTL40SRC	\$ 300.00	
		LED Light Bar 40" Long, 18200 Lumens, Cree Bulbs	AMLED40	\$ 160.00	
		LED Light Bar Floodlight/Spotlight Combo 42" Long, 14500 Lumens, 240 Watts, 19 Amps For 12 Volt to 24 Volt Systems Includes Mounting Bracket and Stainless Steel Hardware Replaces 1163691	AMTLB440C	\$ 250.00	
		LED Light Bar, Curved 50" Long, 21500 Lumens, Cree Bulbs	AMLED50C	\$ 190.00	
	Universal Equipment	LED Magnetic Work Light All-Position Light 3.25" Square Floodlight 900 Lumens Magnetic Base Includes Lithium Ion Battery, Cigarette Lighter and DC Charger	AMTL2460	\$ 79.00	

Gleaner®—Combine





Air Conditioning and Components

Application	Description	Part Number	Retail Price
 A65, A75, C62, R65, R75	Compressor, Sanden SD7H15 12 Volt, w/ 2-Groove Clutch, 5.25" (133 mm) Clutch Diameter, Horizontal Tube O-Ring, w/o Charge Ports Requires Synthetic Ester Oil 100V, 10.14 oz (300 cc) Premium Synthetic Ester Oil, 100V, 12 oz	AMX10187 AMX10273	\$ 270.00 \$ 11.00
 E3, F, F2, G, K, K2, L, L2, M, M2, MH, MH2 Replaces 71336549, 71336550, 71371464	Compressor, York Style Left Hand Suction, Rotolock Clutch Not Included Requires Synthetic Ester Oil 100V, See Manufacturer for Oil Quantity Double Groove Clutch for York Compressor, 7" Premium Synthetic Ester Oil, 100V, 12 oz	AMX10225 AM470 AMX10273	\$ 260.00 \$ 101.00 \$ 11.00
 R42 ASN 49001	Compressor, Sanden 12 Volt, w/ 2-Groove Clutch, 5.25" (133 mm) Clutch Diameter, Vertical Tube O-Ring, w/o Charge Ports Requires Synthetic Ester Oil 100V, 8.11 oz (240 cc) Premium Synthetic Ester Oil, 100V, 12 oz	AMX10130 AMX10273	\$ 365.00 \$ 11.00
 E3, F, F2, F3, G, K, K2, L, L2, L3, M, M2, M3, MH2, MH3, N5, N6, N7, R5, R6, R7, R40, R42, R50, R52, R60, R62, R70, R72 (Replaces 71162474), Hesston® Forage Harvesters: 4000, 7655, 7660, Swathers: 420, 520, 6400, 6600, 6610 (Replaces 7022163)	Rotary Adjustable Thermostatic Switch 36" Capillary Tube	AMX10251	\$ 45.00
 M, M2, M3, N5, N6, R5, R6, R7, R40, R42 BSN 043001, R50, R52 BSN 053001, R60, R62 BSN 063001, R70, R72 BSN 073001 Replaces 71190643	High Pressure Switch Normally Closed, Opens at 375 PSI, Closes at 225 PSI 7/16"x20 Thread	AM539069R2	\$ 34.00
 Universal Equipment	High Pressure Switch Normally Open, Opens at 305 PSI, Closes at 395 PSI, 7/16"x20 Thread	AMX10276	\$ 35.00
 Universal Equipment	Low Pressure Switch Normally Open, Opens at 6 PSI, Closes at 45 PSI, Standard 7/16"x20 Thread	AMX10277	\$ 55.00
 Universal Equipment	Low Pressure Switch Normally Open, Opens at 35 PSI, Closes at 46 PSI, Standard 7/16"x20 Thread	AMX10278	\$ 42.00
 A65, A66, A75, A76, A85, A86, R42, R52, R62, R65, R66, R72, R75, R76 Replaces 71369761	Receiver Drier 3" x 10 1/2" Male O-Ring, R12 and R134a Compatible	AMX10218	\$ 26.00
 F, G, K, E3 Replaces 71160968	Receiver Drier 3" x 6" Male Flare, R12 and R134a Compatible	AMX10211	\$ 22.00
 F2, F3, K2 SN 24201-27200, L2, L3 ASN 28001, M2, M3 ASN 25901, N5, N6, N7 Replaces 71193543	Receiver Drier 3" x 9" Male O-Ring, Male Switch Port, R12 and R134 Compatible	AMX10205	\$ 26.00

Gleaner®—Combine

Application	Description	Part Number	Retail Price
 C62, F2, F3, K2, L2, L3, M2, M3, N5, N6, N7, R5, R6, R7, R40, R42, R50, R52, R60, R62, R70, R72 Replaces 71307202, 71504287, 72162195, 72274512, 72275588	Expansion Valve Block Type, R12 and R134a Compatible, O-Ring Connection	AMX10151	\$ 24.00
 E3 (w/ Comfort or LaPorte Cab), F (SN 12201-32201 w/ Comfort Cab), G (ASN 17001 w/ Comfort Cab), K (BSN 24200 w/ Comfort or LaPorte Cab), L, M Replaces 71162473	Expansion Valve Bulb Type, Externally Equalized, R12 and R134a Compatible, 12" Tube Length, Flare Connection	AMX10153	\$ 25.00
 F, G, K, E2 Replaces 71160956	Expansion Valve Internally Regulated w/ 12" Capacity Tube w/ Flare Connection, R12 and R134a Compatible	AMX10215	\$ 30.00
 E3, F, F2, F3, G, K, K2, L, L2, L3, M, M2, M3, N5, N6, N7, R5, R6, R7, R42, R50, R52, R60, R62, R70, R72 Replaces 70257336	Blower Motor Single Speed, Double Shaft, 2-Wire, Reversible, 5/16" Shaft Diameter, 2 1/2" Long	AMX10110	\$ 55.00
 F2, F3, K2, L2, L3, M2, M3, MH2, MH3, N5, N6, N7, R5, R6, R7, R20, R40, R50, R60, R70	Evaporator Overall: 25" x 3 1/2" x 6"	AM71326717	\$ 315.00

Cornhead—Fenders and Snouts

Application	Description	Part Number	Retail Price	Core
 Models 1972-79	Outer Short Snout, Left Hand 33" Long	AM70573745	\$ 155.00	
	Outer Long Snout, Steel, Left Hand 38.50" Long	AM70598583	\$ 439.00	
Hugger Heads	Outside Snout, Steel, Left Hand	AM71364999	\$ 309.00	
 Models 1972-79	Outer Short Snout, Right Hand 33" Long	AM70573746	\$ 155.00	
	Outer Long Snout, Right Hand 38.50" Long	AM70598582	\$ 439.00	
Hugger Heads	Outside Snout, Steel, Right Hand	AM71365000	\$ 309.00	
All Models except Hugger Heads	Divider Point, Center/Outside	AM70595463	\$ 64.00	
Hugger Heads (Outside or Center)	Wear Tip, Cast For Steel Divider Point	AM71364963	\$ 40.00	
 Low Profile Models	Center Snout, Short Narrow 29" Long	AM70596555	\$ 228.00	
	Center Snout, Long Narrow, Steel 38" Long	AM71502917	\$ 399.00	
	Center Snout, Long/Short Wide 38" Long	AM70596556	\$ 399.00	
Hugger Heads - 28" or 30"	Center Snout, Narrow, Steel	AM71366376	\$ 387.00	
Hugger Heads - 36", 38", 40"	Center Snout, Wide, Steel	AM71366379	\$ 421.00	
 Models w/ Black Frame	Ear Savers, Inside Requires (1) Inside and (1) Outside per Row	AMX27181	\$ 22.50	
 Models w/ Metal Snout	Poly Skid Bubble Tip, Inside Snout	AMX27149	\$ 18.50	
	Poly Skid Bubble Tip, Outside Snout	AMX27148	\$ 18.50	

Gleaner®—Combine

Application	Description	Part Number	Retail Price	Core
 Models w/ Poly Snout	Poly Skid Bubble Tip, Inside Snout	AMX27151	\$ 18.50	
	Poly Skid Bubble Tip, Outside Snout	AMX27150	\$ 18.50	
Most Models	Poly Gathering Chain Guard White 8.90" x 23", Includes Hardware	AMX27152	\$ 21.00	

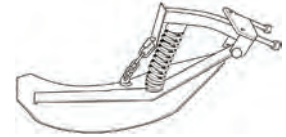









Cornhead—Stalk Stompers

Includes bracket.

Application	Description	Part Number	Retail Price	Core
1981-97 w/ Orange or Black Frame	Stalk Stomper Kit Includes Mounting Brackets	AMX27167	\$ 549.50	
3000 Series	Stalk Stomper Kit, 2 Row Covers 1 Row on Each side of Cornhead	AMX31077	\$ 1200.00	
	Stalk Stomper Kit, 4 Row Covers 2 Rows on Each side of Cornhead	AMX31078	\$ 1600.00	
	Stalk Stomper Kit, 6 Row Covers 3 Rows on Each side of Cornhead	AMX31079	\$ 2225.00	
	Stalk Stomper Kit, 6 Row Covers 3 Rows on Each side of Cornhead	AMX31080	\$ 2775.00	
	Stalk Stomper Kit, 12 Row Covers 6 Rows on Each side of Cornhead	AMX31081	\$ 3650.00	
	Header Mounting Bracket Accommodates 2" x 2" Square Toolbar	AMX30029	\$ 120.00	

Cornhead—Row Unit Components

Application	Description	Part Number	Retail Price	Core
 Hugger Heads	Gathering Chain Drive Sprocket 8 Tooth	AM71369591	\$ 22.00	
 1981-87 w/ Orange or Black Frame	Gathering Chain Drive Sprocket 9 Tooth, 0.94" Shaft	AM70577247	\$ 30.00	
 (240, 330, 335, 340, 430, 440, 630 - Prior to 1971)	Gathering Chain	AM70567135	\$ 56.00	
 1977-89 w/ Black Frame	Gathering Chain	AM70574793	\$ 45.00	
 Hugger Heads 1990 and Later	Gathering Chain	AM71505705	\$ 40.00	
 Hugger Heads 1990 and Later	Lower Idler Sprocket 8 Tooth	AM71359125	\$ 22.00	
 1977-89 w/ Black Frame	Lower Idler Sprocket 8 Tooth	AM70595084	\$ 17.00	
 Hugger Heads 1988 and Later	Stalk Roll Knife Single Blade (3) Required per Roll	AM71351081	\$ 18.50	

Gleaner®—Combine

Application	Description	Part Number	Retail Price	Core
(330, 335, 430, 435, 440, 630 - w/ Orange Frame)	Snapping Roll Drive Shaft 34.812" Long For Double Sprocket Drive Replaces 70567481	AM70569418	\$ 244.60	
	Snapping Roll Drive Shaft 36.062" Long For Double Sprocket Drive Replaces 70567481	AM70569422	\$ 307.53	

Belts—Headers

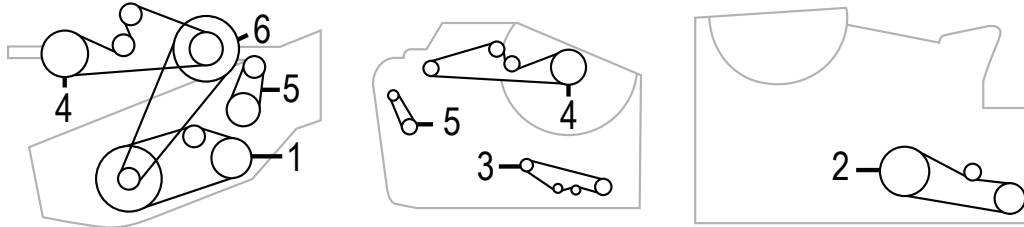

Application	Description	Part Number	Retail Price
1 F2, F3, K2	Conveyor Drive	AM71139622	\$ 20.06
2 20', 22', 24' - L, M ASN 6001, L2, L3, M2, M3, MH2 Header ASN 18401	Conveyor Drive	AM71175713	\$ 29.25
3 E3, K, K2, MH	Draper Pick Up Drive, 3 Roll	AM70519731	\$ 33.96
4 F2 (20' w/ Vari-Speed & HD Reel-Drive ASN 65001), LH, L, M, MH - Left or Right Hand	Reel Drive	AM71118003	\$ 49.54
4 F2, F3, K2 - BSN 6500, w/ Vari-Speed, F2, F3, K2 - Left Hand w/o Vari-Speed	Reel Drive	AM71125977	\$ 22.36
4 F, K - Vari-Speed Long Arms, G, GH - Short Arms	Reel Drive	AM70519007	\$ 47.00
5 A, R, C, C2, CR, CH ASN 5001, E3, F Rice, F2, F3, K, K2 (Short Arms), L, L2, M2 BSN 48000, MH2 BSN 51505	Reel Drive, Vari-Speed	AM71135618	\$ 30.00
6 F2, F3, K2	Reel Drive, Intermediate Std.	AM71123452	\$ 16.40

Belts—A, C, C2, E

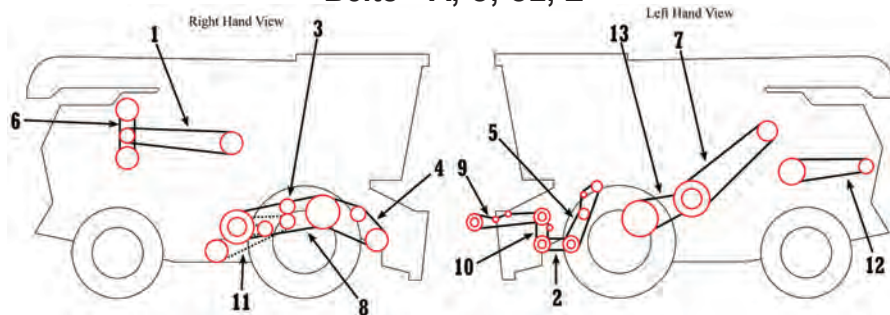

Application	Description	Part Number	Retail Price
1 C, C2 ASN 5001	Bin Unloader	AM71129986	\$ 39.50
2 A S/N 14053-30000, C, C2	Conveyor Drive	AM71125976	\$ 42.25
3 C ASN 7001, C2 ASN 7001	Countershaft	AM71165927	\$ 34.00
4 A, C, C2	Cylinder Drive	AM71125981	\$ 67.00
5 C, C2 ASN 7001	Harvester Drive	AM71132108	\$ 55.00
6 A S/N 14053-26500	Hydraulic Pump	AM71117027	\$ 14.00
6 C, C2	Hydraulic Pump	AM71152608	\$ 25.23

Gleaner®—Combine

Application	Description	Part Number	Retail Price
7 A S/N 14053-30000	Main Drive	AM71117540	\$ 76.25
7 C, C2	Main Drive	AM71125974	\$ 71.70
8 A, C BSN 7001, C2 BSN 7001	Pivot Drive	AM71125978	\$ 68.00
8 C, C2 ASN 7001	Pivot Drive	AM71135970	\$ 152.75
9 A S/N 14053-30000, C, C2 ASN 7001	Reel Drive	AM71125977	\$ 22.36
10 A ASN 25301, C, C2, E SN 6001-6801	Reel Drive, Intermediate	AM71123452	\$ 16.40
10 A S/N 14053-30000, E BSN 6001	Reel Drive, Intermediate	AM71116528	\$ 14.20
11 A, C, C2	Separator Fan	AM71125980	\$ 52.00
12 A	Spreader Drive	AM71116054	\$ 64.00
12 C, C2 SN 2801-7000	Spreader Drive	AM71128379	\$ 52.00
13 A S/N 14053-30000, C, C2	Traction Drive	AM71170490	\$ 93.20
NI C, C2	Generator and Fan	AM74512419	\$ 6.16

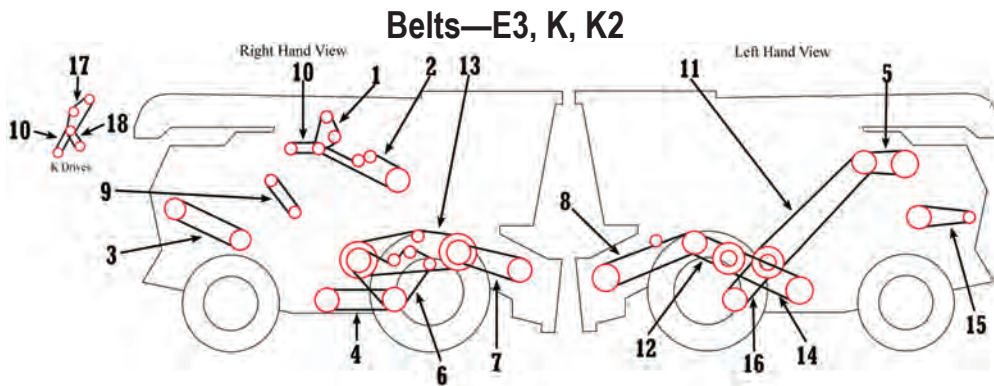

Application	Description	Part Number	Retail Price
1 K2	Alternator	AM71139187	\$ 8.37
2 K, K2	Bin Loading	AM71339772	\$ 39.00
2 E3	Bin Loading	AM71139962	\$ 71.00
3 K2 BSN 25201	Chopper Drive	AM71136325	\$ 81.00
3 K2 ASN 25201	Chopper Drive	AM71302279	\$ 72.50
3 E3, K	Chopper Drive	AM71142831	\$ 66.00
4 K	Cleaner Fan, Standard	AM71146659	\$ 26.00
4 K	Cleaner Fan, High Speed	AM71177255	\$ 35.00
5 K, K2	Compressor, A/C	AM71193749	\$ 17.40
5 E3 S/N 501-8200, K S/N 501-12201	Compressor, A/C Comfort Cab	AM71152788	\$ 16.77
5 E3 ASN 8201, K ASN 12201	Compressor, A/C Laport Cab	AM71166813	\$ 8.19
5 E3 BSN 5001, K BSN 5001	Hydraulic Pump, w/o Power Steering	AM71142239	\$ 17.84
6 E3	Countershaft	AM71139965	\$ 38.25
6 K	Countershaft, 2V Belt	AM71177548	\$ 70.00
6 K2	Countershaft, Separator Fan Set of 2	AM71188075	\$ 53.00
7 K, K2 ASN 5001	Cylinder Drive 903-1383 RPM	AM71147547	\$ 53.00
7 K, K2	Cylinder Drive 387-590 RPM	AM71147546	\$ 63.50
7 K, K2	Cylinder Drive 596-908 RPM	AM71146000	\$ 73.50
8 E3, K, K2 (Vari-Speed)	Draper Drive, 2 Roll	AM71130442	\$ 26.25
8 E3, K, K2 (Vari-Speed)	Draper Drive, 3 Roll	AM70519731	\$ 33.96
8 E3, K BSN 8201	Header Drive	AM71138949	\$ 91.43

Prices Subject to Change without Prior Notice. The use of original equipment manufacturer (OEM) part numbers or trademarks, e.g. Case® and John Deere®, are for reference purposes only and for indicating product use and compatibility. Our company and the listed replacement parts contained herein are not sponsored, approved or manufactured by the OEM. All parts are New unless designated Reman in the description.

Gleaner®—Combine

Application	Description	Part Number	Retail Price
8 K, K2 ASN 8201	Header Drive, Std.	AM71132108	\$ 55.00
8 K ASN 8201, K2 ASN 8201	Header Drive, Vari-Speed	AM71172514	\$ 149.00
9 E3, K	Grain Saver, Air Flow Gas	AM70563619	\$ 21.20
9 K2 Gas	Grain Saver, Air Flow	AM71190749	\$ 23.40
10 (E3, K ASN 12201)	Compressor, A/C	AM71142239	\$ 17.84
10 K2 ASN 25201	Hydraulic Pump	AM71300400	\$ 14.50
10 K2 BSN 25201	Hydraulic Pump, Gas	AM71146714	\$ 14.34
10 K BSN 12201	Hydraulic Pump, w/ Power Steering	AM71146713	\$ 7.00
10 E3	Hydraulic Pump, w/ Power Steering	AM71131774	\$ 12.40
11 E3	Main Drive	AM71139960	\$ 101.50
11 K ASN 12201	Main Drive	AM71170690	\$ 115.00
11 K2	Main Drive	AM71189170	\$ 88.00
11 K BSN 12201	Main Drive	AM71139961	\$ 90.00
11 K2	Main Drive, Gas 2V Belt	AM71153532	\$ 104.00
12 K, K2	Pivot Drive, Left Hand	AM71165927	\$ 34.00
13 K, K2, E3	Pivot, Right Hand	AM71139966	\$ 112.49
14 E3	Separator Fan	AM71139964	\$ 48.05
15 K2 BSN 25201	Spreader Drive	AM71127198	\$ 27.00
15 K2 ASN 25201	Spreader Drive	AM71308584	\$ 38.55
16 K2	Traction Drive, Standard	AM71318378	\$ 130.00
16 K, E3	Traction Drive, Non-Hydro	AM71139963	\$ 72.75
17 K, K2	Governor Gas	AM71146702	\$ 16.00
18 K ASN 12201	Countershaft, PTO	AM71148119	\$ 10.24
18 K Gas	Countershaft, PTO	AM71170283	\$ 29.00
18 K2 ASN 25201 Gas	Countershaft, PTO	AM71170678	\$ 11.96
18 K2 Diesel	Countershaft, PTO	AM71300399	\$ 12.72

Belts—F, F2, F3, G, GH

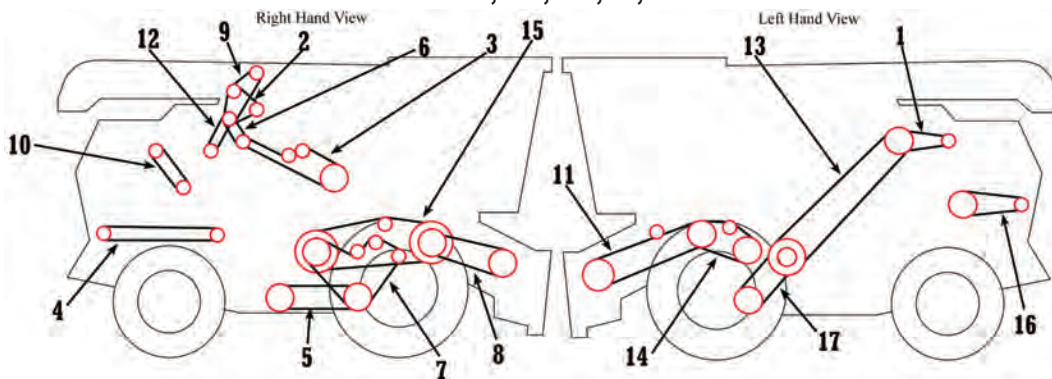

Application	Description	Part Number	Retail Price
1 F BSN 12201	A/C Compressor	AM71142239	\$ 17.84
1 F2 ASN 39201, F3 ASN 39201	A/C Compressor	AM71193749	\$ 17.40
2 F2 ASN 39201, F3 ASN 39201	Alternator	AM71139187	\$ 8.37
2 F2 BSN 39201	Alternator	AM71193420	\$ 8.69
2 F ASN 12201	Generator	AM71154358	\$ 19.25
3 F BSN 12201	Bin Unloader	AM71139962	\$ 71.00

Gleaner®—Combine

Application	Description	Part Number	Retail Price
3 F Gas ASN 12201, F2, F3 Gas, Diesel ASN 39201	Bin Unloader	AM71339772	\$ 39.00
3 F2 BSN 39201	Bin Unloader	AM71194116	\$ 38.25
3 G	Bin Unloader	AM71170191	\$ 45.00
4 F	Chopper Drive	AM71142831	\$ 66.00
4 F2 BSN 39201	Chopper Drive	AM71136325	\$ 81.00
4 F2, F3 ASN 39201	Chopper Drive	AM71302279	\$ 72.50
5 F BSN 5001	Separator Fan	AM71139964	\$ 48.05
5 F ASN 5001	Cleaner Fan, High Speed	AM71177255	\$ 35.00
5 F Rice	Cleaner Fan	AM71146659	\$ 26.00
6 F Gas S/N 12201-25800	Countershaft, PTO	AM71148119	\$ 10.24
6 F Gas ASN 25801	Countershaft, PTO	AM71170678	\$ 11.96
6 F2 Gas BSN 39201	Countershaft, PTO	AM71170678	\$ 11.96
6 F2 Gas S/N 39201-48200	Countershaft, PTO	AM71300398	\$ 12.86
6 F2 Diesel S/N 39201	Countershaft, PTO	AM71300399	\$ 12.72
7 F BSN 5001	Countershaft	AM71139965	\$ 38.25
7 F ASN 5001	Countershaft	AM71146271	\$ 91.84
7 F2, F3 (RH - Set)	Countershaft, Separator Fan Set of 2	AM71188075	\$ 53.00
8 F Std. S/N 9001-12201	Cylinder Drive	AM71147547	\$ 53.00
8 F ASN 12201	Cylinder Drive 387-590 RPM	AM71147546	\$ 63.50
8 F ASN 12201, F Rice	Cylinder Drive 596-908 RPM	AM71146000	\$ 73.50
8 F ASN 12201	Cylinder Drive 903-1383 RPM	AM71147547	\$ 53.00
8 F2, F3	Cylinder Drive 499-834 RPM	AM71175575	\$ 57.00
8 F2, F3	Cylinder Drive 633-1059 RPM	AM71145999	\$ 67.00
8 F2, F3, G ASN 12201	Cylinder Drive 803-1343 RPM	AM71147547	\$ 53.00
8 G, GH ASN 12201	Cylinder Drive 633-1059 RPM	AM71145999	\$ 67.00
8 F2, F3, G ASN 12201, GH ASN 17701	Cylinder Drive, Slow Speed 412-688 RPM	AM71151777	\$ 75.00
8 F BSN 5001, G BSN 12201	Cylinder, Std	AM71125981	\$ 67.00
9 F ASN 12201, F2	Governor, Gas	AM71148120	\$ 8.25
10 F2, F3 ASN 39201	Grain Saver, Air Flow	AM71190749	\$ 23.40
10 F ASN 12201	Grain Saver, Air Flow	AM71144488	\$ 16.75
10 F ASN 12201	Grain Saver, Air Flow	AM70563619	\$ 21.20
10 F BSN 12201	Grain Saver, Air Flow Gas	AM70559863	\$ 14.50
10 F2	Grain Saver, Air Flow, Field Installed	AM71190750	\$ 26.00
11 F Rice (w/o Vari-Speed), F2, F3	Header Drive, Std w/o Vari-Speed	AM71132108	\$ 55.00
11 F, F2, F3	Header Drive, Vari-Speed	AM71172514	\$ 149.00
12 F2, F3 - ASN 48201	Hydraulic Pump	AM71141744	\$ 18.00
12 F2 S/N 39201-48200	Hydraulic Pump	AM71300400	\$ 14.50
12 F2 BSN 39201	Hydraulic Pump	AM71146714	\$ 14.34
13 F, F Gas BSN 12201, F Rice	Main Drive, Diesel	AM71139961	\$ 90.00
13 F2, F3 - ASN 39201	Main Drive, Diesel	AM71189170	\$ 88.00
13 F2 BSN 39201	Main Drive	AM71194122	\$ 86.00
13 F S/N 12201-25800	Main Drive, Gas	AM71167409	\$ 95.00
13 F ASN 25801	Main Drive, Gas	AM71183767	\$ 106.30
13 F2 S/N 39201-48200	Main Drive, Gas	AM71192495	\$ 100.00
13 F2 BSN 38201	Main Drive, Gas 2V Belt	AM71153532	\$ 104.00
14 F, F2	Pilot Drive, Left Hand	AM71165927	\$ 34.00

Prices Subject to Change without Prior Notice. The use of original equipment manufacturer (OEM) part numbers or trademarks, e.g. Case® and John Deere®, are for reference purposes only and for indicating product use and compatibility. Our company and the listed replacement parts contained herein are not sponsored, approved or manufactured by the OEM. All parts are New unless designated Reman in the description.

Gleaner®—Combine

Application	Description	Part Number	Retail Price
15 F2, F3	Pivot, Right Hand	AM71157414	\$ 161.00
15 F Rice	Pivot, Right Hand	AM71139966	\$ 112.49
16 F ASN 12201, F2 BSN 39201	Spreader	AM71160836	\$ 56.00
16 F S/N 5001-12200, F Rice	Spreader, Single	AM71140991	\$ 40.00
17 F ASN 9001, F2 BSN 48201	Traction Drive, Hydro	AM71147546	\$ 63.50
17 F2 ASN 39201, F3	Traction Drive, Hydro	AM71161595	\$ 67.00
17 G	Traction Drive	AM71140810	\$ 136.00
17 F2, F3	Traction Drive	AM71318378	\$ 130.00
17 F	Traction Drive, Non-Hydro	AM71139963	\$ 72.75
NI F2 ASN 065000	Cutterbar Drive	AM71322834	\$ 39.00

Belts—M, M2, M3, MH, MH2, MH3

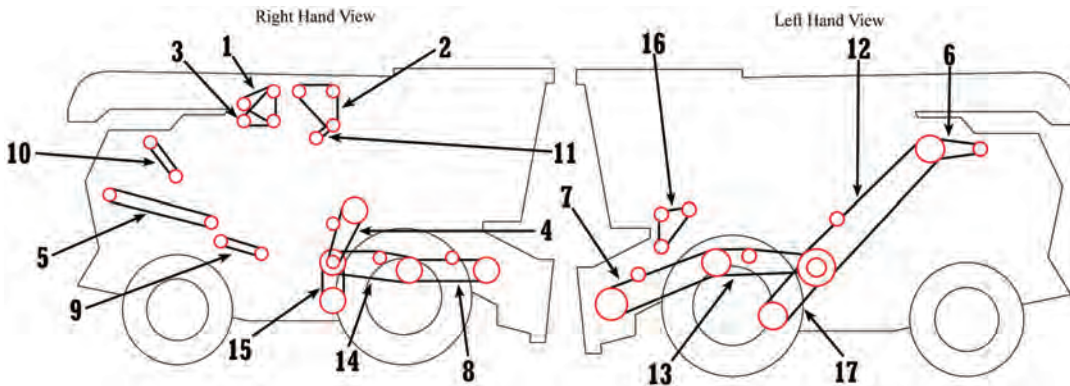

Application	Description	Part Number	Retail Price
1 M, MH	Alternator, D2900 Dual-Upper	AM71167004	\$ 8.04
1 M2, M3	Alternator, Dual-Upper	AM71193420	\$ 8.69
2 M	Alternator, Dual / Single Gas Set of 2	AM71165501	\$ 7.50
2 M ASN 4201, MH D2900 ASN 4201	Alternator, Single	AM71159298	\$ 19.90
2 M2, MH2	Alternator, D2900/649T	AM71193733	\$ 16.13
2 M2, M3 S/N 15401-25900	Alternator, Heavy-Duty 649T	AM71303453	\$ 24.25
2 M3, MH2, MH3	Alternator, Dual D3500-670 Upper	AM71186454	\$ 18.82
2 MH, MH2, MH3	Alternator, D3500-670T, Lower Dual	AM71184961	\$ 32.78
2 MH2	Alternator, Dual D2900-649T Upper	AM71194320	Call for Price
3 (M, M2, M3, MH, MH2, MH3 w/ D2900/649T)	Alternator, Dual - Lower	AM71184327	\$ 14.00
3 M2, M3	Alternator, Single, HD Set of 2	AM71181482	\$ 25.00
3 MH2	Alternator, D3500/670T, HD Set of 2	AM71195451	\$ 33.00
4 (M, MH BSN 11401)	Bin Unloader	AM71177597	\$ 52.00
4 (M, MH, MH2, MH3 ASN 11401)	Bin Unloader	AM71187728	\$ 45.00
4 MH3 ASN 25901	Bin Unloader	AM71339768	\$ 27.00
5 M, M2, MH, MH2, MH3 BSN 19901	Chopper, Straw	AM71173472	\$ 100.00
5 (M, MH2, MH3 ASN 19901)	Chopper, Straw	AM71300867	\$ 44.00
5 M, MH	Spreader, Straw	AM71172562	\$ 42.00
5 M2, M3, MH2, MH3	Spreader, Straw	AM71176400	\$ 47.00
6 M, MH	Compressor, A/C	AM71166813	\$ 8.19

Gleaner®—Combine

Application	Description	Part Number	Retail Price
6 M2, M3, MH2, MH3	Compressor, A/C	AM71193749	\$ 17.40
7 M, M2, M3	Countershaft, Thresher w/ Std Hdr Drv	AM71309214	\$ 83.00
7 M, M2, M3	Countershaft, Thresher w/ Vari-Speed	AM71300996	\$ 175.00
7 MH, MH2, MH3	Countershaft, Thresher Pvt to Cntr Set of 2	AM71179490	\$ 49.21
8 M, M2 - (639-1046 RPM), MH, MH2, MH3 - (412-688 RPM, BSN 19901)	Cylinder Drive	AM71161595	\$ 67.00
8 M, M2 - (503-834 RPM), MH, MH2 - (BSN 19901)	Cylinder Drive 499-834 RPM	AM71175989	\$ 85.00
8 M, M2, MH, MH2	Cylinder Drive 804-1343 RPM	AM71147546	\$ 63.50
8 (M2, M3 SN 19901-25900)	Cylinder Drive, 804-1318 RPM 2V Belt	AM71188635	\$ 50.00
8 M3 (Non-Hydro), MH2, MH3 ASN 19901	Cylinder Drive 804-1318 RPM	AM71337795	\$ 59.00
9 M Chopper BSN 15401, (M2, M3 S/N 18401-19900)	Grain Saver, Air Flow, Lower	AM71178442	\$ 74.00
9 M2, M3 (w/o Chopper, S/N 19901-25900)	Grain Saver, Air Flow, Lower	AM71300867	\$ 44.00
10 M	Grain Saver, Air Flow, Lower	AM71178329	\$ 31.00
10 M2, M3 S/N 18401-19900	Grain Saver, Air Flow, Lower	AM71306291	\$ 21.00
10 M2, M3 S/N 18401-25900	Grain Saver, Air Flow, Lower	AM71190876	\$ 18.00
11 M	Hyd. Pump Drive w/ 3" Hdr Lift Cyl. Gas	AM71175686	\$ 9.16
11 M (Gas)	Hyd. Pump Drive w/ 2.50" Hdr Lift Cyl.	AM71172977	\$ 14.00
11 (M, M2, M3 BSN 22101)	Hyd. Pump Drive w/ 2.50" Hdr Lift Cyl. Diesel	AM71173232	\$ 11.75
11 M, M2, M3	Hyd. Pump Drive, 2V Belt	AM71153532	\$ 104.00
11 M, M2, M3 (Dsl, BSN 22101)	Hyd. Pump Drive w/ 3" Hdr Lift Cyl.	AM71175687	\$ 10.24
11 M2 ASN 22101, M3	Hyd. Pump Drive	AM71317254	\$ 18.00
11 MH, MH2, MH3	Hyd. Pump Drive	AM71327638	\$ 25.86
12 M, M2, M3, MH2, MH3 - w/ D2900/649T Engine	Main Drive, 2V Belt	AM71153532	\$ 104.00
12 MH, MH2, MH3 - w/ D3500/670T Engine	Main Drive 3V Belt	AM71173998	\$ 129.00
13 M, M2, M3, MH, MH2, MH3	Pivot, Left Hand	AM71164177	\$ 61.00
14 M, M2, MH, MH2, MH3 BSN 19901	Pivot, Right Hand	AM71164350	\$ 149.00
14 (M2, MH2, MH3 ASN 19901), M3	Pivot, Right Hand	AM71194500	\$ 223.00
15 M, M2, M3, MH, MH2, MH3	Separator Fan	AM71176492	\$ 20.00
16 M2, M3 ASN 19901, MH2 ASN 21901 (When belt drive used)	Thresher Beater	AM71309140	\$ 33.00
17 M	Traction Drive, Standard	AM71167114	\$ 170.00
17 (M, M2 BSN 18401), MH BSN 11401	Traction Drive, Hydro 2V Belt	AM71177548	\$ 70.00
17 M ASN 11401, (M2, M3 SN 18401-26300), MH2, MH3, MH3 - w/ D2900/649T Engine	Traction Drive, Hydro 2V Belt	AM71188635	\$ 50.00
17 M2, M3	Traction Drive, Standard	AM71188155	\$ 154.00
17 M3 ASN 26301	Traction Drive, Hydro	AM71342214	\$ 63.50
17 (MH, MH2, MH3 ASN 11401)	Traction Drive, Hydro (D3500/670T)	AM71188636	\$ 82.00
NI MH, MH2, MH3	Countershaft, Swivel	AM71192282	\$ 45.77

Gleaner®—Combine

Belts—L, L2, L3

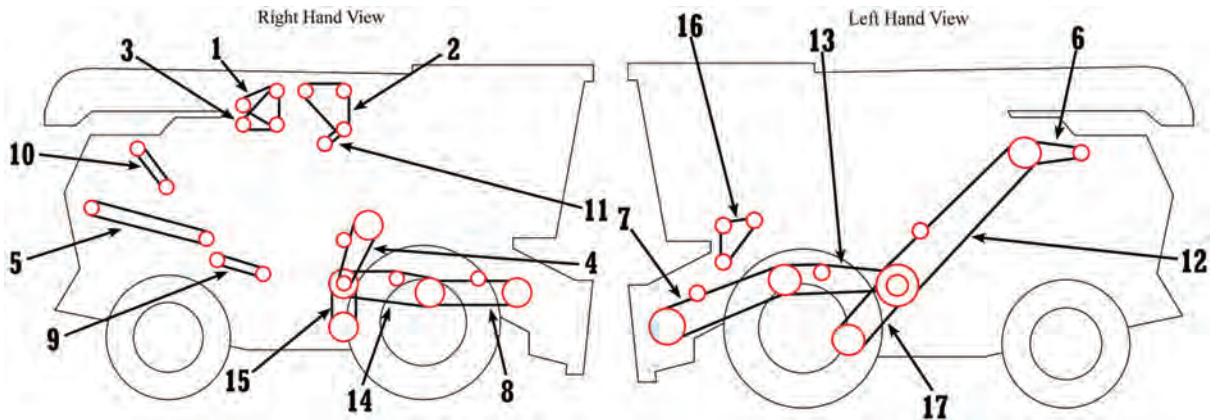

Application	Description	Part Number	Retail Price
1 L	Alternator, Dual D2900	AM71167004	\$ 8.04
1 L, L2, L3	Alternator, Dual Upper D3500/670T	AM71186454	\$ 18.82
1 L2, L3	Alternator, Upper D2900/649	AM71193420	\$ 8.69
2 L BSN 2601	Alternator, Dual / Single Set of 2	AM71165501	\$ 7.50
2 L BSN 4201	Alternator, D2900	AM71172696	\$ 18.64
2 L ASN 2601	Alternator, Dual / Single Set of 2	AM71175751	\$ 22.25
2 L ASN 4201	Alternator, D2900 Single	AM71159298	\$ 19.90
2 L, L2	Alternator, D3500/670T, HD 110 Amps Set of 2	AM71195451	\$ 33.00
2 L, L2	Alternator, D3500/670T 105 Amps Set of 2	AM71181482	\$ 25.00
2 L2	Alternator, D2900/649, HD	AM71303453	\$ 24.25
2 L2	Alternator, D2900/649T	AM71193733	\$ 16.13
3 L, L2, L3	Alternator, D2900/649, Dual - Lower	AM71184327	\$ 14.00
3 L, L2, L3	Alternator, D3500-670T, Lower Dual	AM71184961	\$ 32.78
4 L BSN 9001	Bin Unloader	AM71177597	\$ 52.00
4 (L, L2, L3 ASN 9001)	Bin Unloader	AM71187728	\$ 45.00
5 (L, L2, L3 BSN 17501)	Chopper, Straw	AM71173472	\$ 100.00
5 L2 ASN 17501, L3	Chopper, Straw	AM71300867	\$ 44.00
6 L	Compressor, A/C	AM71166813	\$ 8.19
6 L2, L3	Compressor, A/C	AM71193749	\$ 17.40
7 L BSN 4201	Countershaft, Header Vari-Speed	AM71173822	\$ 156.00
7 L	Countershaft, Thresher w/ Std Hdr Drv	AM71309214	\$ 83.00
7 L, L2, L3 S/N 4201-9183	Countershaft, Thresher Vari-Speed w/ Pin	AM71300996	\$ 175.00
8 L, L2 BSN 17501	Cylinder Drive 415-680 RPM	AM71161596	\$ 55.00
8 L, L2 BSN 17501	Cylinder Drive 503-834 RPM	AM71175989	\$ 85.00
8 L, L2 BSN 17501	Cylinder Drive 639-1036 RPM	AM71161595	\$ 67.00
8 L, L2 BSN 17501	Cylinder Drive 804-1318 RPM	AM71147546	\$ 63.50
8 L2 BSN 17501, L3	Cylinder Drive 804-1318 RPM	AM71337795	\$ 59.00
8 (L2, L3 SN 17501-28000)	Cylinder Drive, 804-1318 RPM 2V Belt	AM71188635	\$ 50.00
9 L2 S/N 13001-17500 w/o Chopper	Grain Saver, Air Flow, Lower	AM71178442	\$ 74.00

Gleaner®—Combine

Application	Description	Part Number	Retail Price
10 L	Grain Saver, Air Flow, Lower	AM71178329	\$ 31.00
10 L2 S/N 13001-17500	Grain Saver, Air Flow, Lower	AM71190876	\$ 18.00
10 L2, L3	Grain Saver, Air Flow, Lower	AM71306291	\$ 21.00
11 L	Hyd. Pump Drive w/ 2.50" Hdr Lift Cyl.	AM71173232	\$ 11.75
11 L	Hyd. Pump Drive w/ 3" Hdr Lift Cyl. Gas	AM71175687	\$ 10.24
11 L2 ASN 19501, L3	Hyd. Pump Drive w/ 3" Hdr Lift Cyl.	AM71317254	\$ 18.00
12 L ASN 2601, L2, L3	Main Drive, Diesel 3V Belt	AM71173998	\$ 129.00
12 L BSN 2601	Main Drive, Diesel 2V Belt	AM71153532	\$ 104.00
12 L	Main Drive, Gas	AM71166932	\$ 152.69
13 L, L2, L3	Pivot, Left Hand	AM71164177	\$ 61.00
14 (L, L2 BSN 17501)	Pivot, Right Hand	AM71164350	\$ 149.00
14 L2 ASN 17501, L3	Pivot, Right Hand	AM71194500	\$ 223.00
15 L BSN 2601	Separator Fan	AM71176312	\$ 17.00
15 (L, L2, L3 ASN 2601)	Separator Fan	AM71176492	\$ 20.00
16 L2 ASN 17501, L3	Thresher Beater	AM71309140	\$ 33.00
17 L BSN 2601	Traction Drive, Hydro	AM71161596	\$ 55.00
17 L BSN 2601	Traction Drive, Standard	AM71161806	\$ 167.00
17 L ASN 2601	Traction Drive, Standard	AM71167114	\$ 170.00
17 L2 BSN 15501	Traction Drive, Hydro	AM71177537	\$ 94.25
17 L2 S/N 15501-28349, L2 Rice ASN 13001, L3	Traction Drive, Hydro	AM71188636	\$ 82.00
17 L2, L3	Traction Drive, Non-Hydro	AM71188155	\$ 154.00
17 L3 ASN 28350	Traction Drive, Hydro	AM71342142	\$ 130.00

Belts—N5, N6, N7, R5, R6, R7

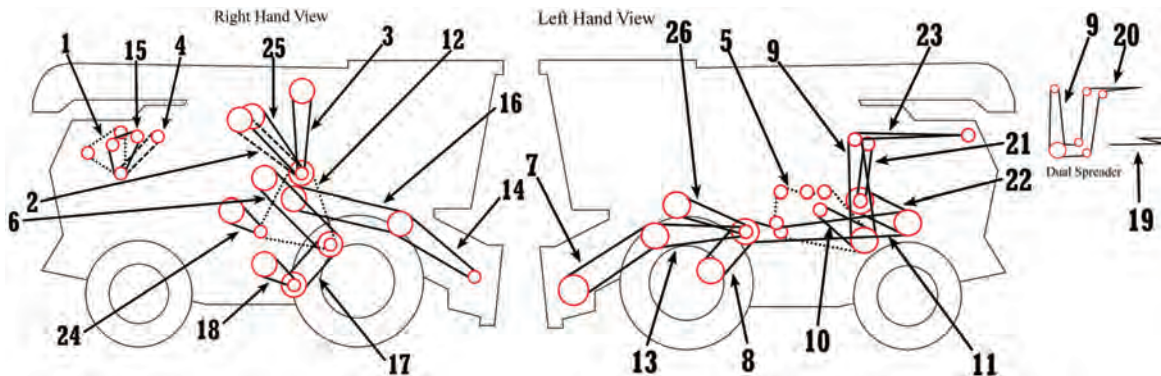

Application	Description	Part Number	Retail Price
1 N5 S/N 4501, N6 S/N 5101	Alternator, Heavy Duty	AM71306200	\$ 27.43
1 N5 S/N 4501, N6 S/N 5101	Alternator, Standard	AM71311927	\$ 10.00
1 N5 S/N 5401, N6 S/N 6201	Alternator, 105 Amp	AM71336137	\$ 19.30
1 N5 ASN 4501, N6 ASN 5101	Alternator, 110 Amp	AM71186454	\$ 18.82
1 N7	Alternator, Standard 105 Amp	AM71175687	\$ 10.24
1 R7	Alternator, Set	AM71175687	\$ 10.24
2 N5, N6 ASN 1501, N7, R5, R6, R7	Cage Sweep	AM71312339	\$ 14.50
2 N6 BSN 1501	Cage Sweep	AM71301877	\$ 34.23
3 N5, N6, N7, R5, R6, R7	Clean Grain Elevator	AM71325847	\$ 35.50

Prices Subject to Change without Prior Notice. The use of original equipment manufacturer (OEM) part numbers or trademarks, e.g. Case® and John Deere®, are for reference purposes only and for indicating product use and compatibility. Our company and the listed replacement parts contained herein are not sponsored, approved or manufactured by the OEM. All parts are New unless designated Reman in the description.

Gleaner®—Combine

	Application	Description	Part Number	Retail Price
4	N5, N6, R5, R6	Compressor Drive	AM71193420	\$ 8.69
4	N7, R7	Compressor Drive	AM71315910	\$ 9.22
5	N5, N6, N7, R5, R6, R7	Cylinder Auger Drive	AM71319657	\$ 42.00
6	N5, N6, N7, R5, R6, R7	Cylinder Drive	AM71364789	\$ 367.00
7	N5 ASN 4501, N6 ASN 5101, N7 ASN 2501	Header Drive, Constant Speed Set of 2	AM71320449	\$ 78.00
7	N5 BSN 4501, N6 BSN 5101, N7 BSN 2501	Header Drive, Constant Speed Set of 2	AM71301859	\$ 94.00
7	N5 ASN 4501, N6 ASN 5101, N7 ASN 2501, R5, R6, R7	Header Drive, Vari-Speed	AM71316268	\$ 182.00
7	N5 ASN 4501, N6 ASN 5101, N7 ASN 2501	Header Drive, Vari-Speed	AM71197876	\$ 204.19
8	R7	Hydro Drive	AM71342143	\$ 132.00
8	N5, N6, R5, R6	Hydro Drive	AM71197999	\$ 104.00
8	N7	Hydro Drive	AM71310381	\$ 179.00
9	N5 ASN 1702, N6 ASN 2371, N7 ASN 1262	Impeller Drive	AM71322418	\$ 18.50
9	R5, R6, R7	Impeller Drive	AM71358134	\$ 20.25
9	N5, N6, N7	Impeller Drive	AM71313804	\$ 21.25
10	N5 ASN 1702, N6 ASN 2371, N7 ASN 1262, R5, R6, R7	Jackshaft Drive, Impeller	AM71313804	\$ 21.25
11	N7	Main Drive	AM71307200	\$ 212.00
11	N6 BSN 5101	Main Drive	AM71314273	\$ 175.00
11	N5, N6 ASN 5101	Main Drive	AM71336997	\$ 168.00
12	N5 BSN 4501, N6 BSN 5101, N7 BSN 2501	Overfeed Auger Drive	AM71309685	\$ 78.00
12	N5 ASN 4501, N6 ASN 5101, N7 ASN 2501	Overfeed Auger Drive Set of 2	AM71325150	\$ 65.00
13	N5, N6, N7, R5, R6, R7	Pivot Drive, Left Hand	AM71310382	\$ 52.00
14	N5 ASN 4501, N6 ASN 5101, N7 ASN 2501, R5, R6, R7	Pivot Shaft Drive 2V Belt	AM71316263	\$ 90.00
14	N5 BSN 65101, N7 BSN 72501	Pivot Shaft Drive	AM71309150	\$ 63.00
15	N5, N6, R5, R6	Radiator Fan	AM71302482	\$ 13.84
16	N5, N6, N7, R5, R6, R7	Rear Feed Conveyor	AM71326830	\$ 62.00
17	N5, N6, N7, R5, R6, R7	Separator Fan Drive	AM71339886	\$ 39.00
18	N5, N6, N7, R5, R6, R7	Shoe Drive	AM71336307	\$ 19.00
19	R5, R6, R7	Spreader	AM71347561	\$ 33.00
20	R5, R6, R7 - (w/o Chopper)	Spreader Jackshaft Drive	AM71347560	\$ 46.70
21	N5, N6, N7, R5, R6, R7	Straw Chopper Drive	AM71358486	\$ 26.00
22	N5, N6, N7, R5, R6, R7	Straw Chopper, Jackshaft	AM71344935	\$ 31.00
23	N5, N6, N7, R5, R6, R7	Straw Spreader Drive	AM71326253	\$ 42.00
23	N5, N6, N7, R7	Spreader Drive, Rear Hood	AM71334919	\$ 30.00
24	N5, N6, N7, R5, R6, R7	Tailings Drive	AM71346200	\$ 17.30
25	N5, N6, N7, R5, R6, R7	Tailings Return	AM71337000	\$ 21.00
26	N5, N6, N7, R5, R6, R7	Unloader Drive, Left Hand	AM71310380	\$ 45.00
NI	N5 BSN 3001, N6 BSN 3501, N7 BSN 1701	Unloader Drive, Right Hand	AM71177795	\$ 47.00
NI	N6	Sickle Drive Belt	AM71324690	\$ 46.44

Gleaner®—Combine

Belts—R40, R42, R50, R52

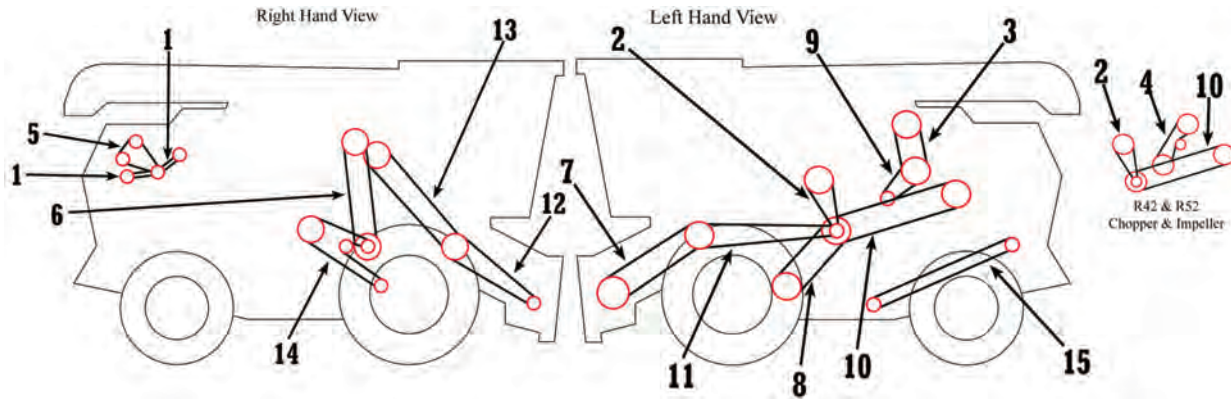

Gleaner®—Combine

Application	Description	Part Number	Retail Price
1 R40, R42, R50, R52	Alternator, Air Cooled	AM71352139	\$ 9.04
1 R42, R52	Alternator, Liquid Cooled	AM71352142	\$ 9.40
2 R40, R42, R50, R52	Bin Unloader Drive	AM71398366	\$ 42.00
3 R40, R50	Chopper and Impeller Drive	AM71336199	\$ 38.00
4 R42, R52	Chopper / Impeller Drive	AM71386695	\$ 67.00
5 R40, R42, R50, R52	Compressor Drive - Air Cooled	AM71352729	\$ 11.50
6 R40, R42, R50, R52	Cylinder Drive, Vari-Speed	AM71335788	\$ 315.00
7 R40, R50	Header Drive, Constant Speed Set of 2	AM71320449	\$ 78.00
7 R40, R50	Header Drive, Vari-Speed	AM71316268	\$ 182.00
7 R42, R52	Header Drive, Vari-Speed	AM71390886	\$ 260.00
8 R40, R42, R50, R52	Hydro Drive	AM71364912	\$ 82.00
9 R40, R42, R50, R52	Jackshaft Drive	AM71333673	\$ 33.00
9 R42 ASN 46001, R52 ASN 53001	Jackshaft Drive, Right Hand	AM71367469	\$ 70.00
10 R40, R42, R50, R52	Main Drive - Air Cooled	AM71351260	\$ 117.00
10 R42, R52	Main Drive - Liquid Cooled	AM71366207	\$ 255.00
11 R40, R42 BSN 43001, R50, R52 BSN 56001	Pivot Jackshaft Drive	AM71355232	\$ 95.00
11 R42 ASN 43001, R52 ASN 56001	Pivot Jack Shaft Drive	AM71374277	\$ 89.00
12 R42 ASN 43001, R52 ASN 56001	Pivot Jack Shaft Drive, Right Hand	AM71364155	\$ 70.00
12 R40 ASN 2001, R50 ASN 3501	Pivot Jack Shaft Drive, Right Hand	AM71354198	\$ 61.00
12 R40 BSN 2001, R50 BSN 3501	Pivot Jack Shaft Drive, Right Hand 2V Belt	AM71316263	\$ 90.00
12 R42 ASN 43001, R52 ASN 53001	Pivot Jack Shaft Drive, Right Hand	AM71374306	\$ 57.00
13 R40, R42, R50, R52	Rear Feed Conveyor	AM71335475	\$ 58.00
14 R40, R42, R50, R52	Separator Drive	AM71358255	\$ 88.00
15 R40, R42, R50, R52	Straw Spreader Drive	AM71355170	\$ 50.00
15 R42 BSN 46001, R52 BSN 56001	Shoe Drive	AM71364077	\$ 32.30
15 R42 ASN 46001, R52 ASN 56001	Shoe Drive	AM71374305	\$ 62.00
NI R42 ASN 43001, R52 ASN 53001	Clean Grain Elevator Drive	AM71368809	\$ 83.00

Gleaner®—Combine

Belts—R60, R70

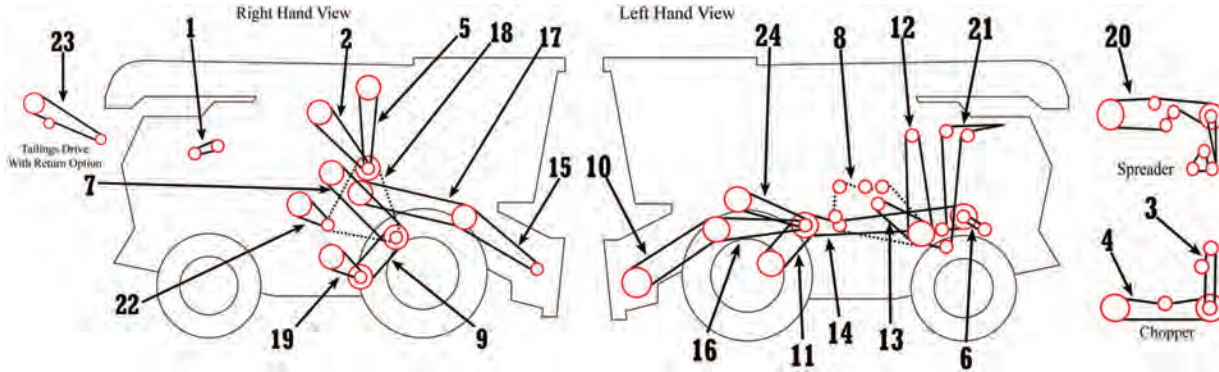

Application	Description	Part Number	Retail Price
1 R60, R70	Alternator	AM71352142	\$ 9.40
2 R60, R70	Cage Sweep	AM71312339	\$ 14.50
3 R60 BSN 16501, R70 BSN 12501	Chopper Drive	AM71358486	\$ 26.00
4 R60, R70	Chopper Jackshaft	AM71358487	\$ 74.00
5 R60, R70	Clean Grain Elevator	AM71325847	\$ 35.50
6 R60, R70	Compressor Drive	AM71193420	\$ 8.69
7 R60, R70	Cylinder Drive	AM71364789	\$ 367.00
8 R60 BSN 16501, R70 BSN 12501	Cylinder Drive	AM71319657	\$ 42.00
8 R60 ASN 16501, R70 ASN 12501	Cylinder Drive	AM71348772	\$ 36.50
9 R60, R70	Fan Drive	AM71339886	\$ 39.00
10 R60, R70	Header Drive, Vari-Speed	AM71316268	\$ 182.00
10 R60, R70	Header Drive, Constant Speed Set of 2	AM71320449	\$ 78.00
11 R60	Hydro Drive	AM71197999	\$ 104.00
11 R70	Hydro Drive	AM71342143	\$ 132.00
12 R60 BSN 16501, R70 BSN 12501	Impeller Drive	AM71358134	\$ 20.25
12 R60 ASN 16501, R70 ASN 12501	Impeller Drive Set of 2	AM71359681	\$ 48.50
13 R60 BSN 16501, R70 BSN 12501	Jackshaft Drive	AM71313804	\$ 21.25
13 R60 ASN 16501, R70 ASN 12501	Jackshaft Drive	AM71354210	\$ 37.00
14 R60	Main Drive	AM71348999	\$ 270.00
14 R70	Main Drive	AM71348989	\$ 242.00
15 R60 BSN 16501, R70 BSN 12501	Pivot Drive Shaft 2V Belt	AM71316263	\$ 90.00
15 R60 ASN 16501, R70 ASN 12501	Pivot Drive Shaft	AM71354198	\$ 61.00
16 R60, R70	Pivot Drive, Left Hand	AM71310382	\$ 52.00
17 R60 BSN 16501, R70 BSN 12501	Rear Feed Conveyor	AM71326830	\$ 62.00
17 R60 ASN 16501, R70 ASN 12501	Rear Feed Conveyor	AM71345800	\$ 68.93
18 R60, R70	Separator Drive Set of 2	AM71325150	\$ 65.00
19 R60, R70	Shoe Drive	AM71336307	\$ 19.00
20 R60, R70	Spreader	AM71347561	\$ 33.00
21 R60, R70	Spreader Jackshaft Drive	AM71347560	\$ 46.70
22 R60, R70	Tailings Drive	AM71345785	\$ 23.00
23 R60 BSN 16501, R70 BSN 12501	Tailings Drive, w/ Tailing Ret Option	AM71345785	\$ 23.00
23 R60 ASN 16501, R70 ASN 12501	Tailings Drive, w/ Tailing Ret Option	AM71337000	\$ 21.00
24 R60, R70	Unloader Drive, Left Hand	AM71310380	\$ 45.00

Gleaner®—Combine

Application	Description	Part Number	Retail Price
24 R60, R70	Unloader Drive, Power Engage	AM71356409	\$ 45.00

Belts—R62, R66, R72, R76

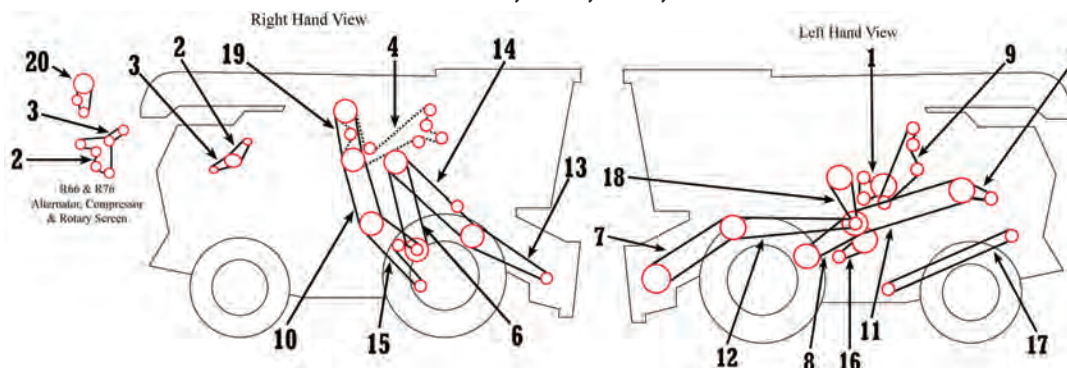

Application	Description	Part Number	Retail Price
1 R62, R72	Accelerator Roll / Dist Auger Drive	AM71354210	\$ 37.00
2 R62 ASN MJ62101	Alternator / Fan Drive	AM3943214	\$ 50.78
2 R72	Alternator Drive	AM3028521	\$ 12.39
2 R66, R76	Alternator / Fan Drive	AMV685121530	\$ 63.20
3 R62 BSN 64001 Note: Verify belt length before ordering	A/C Compressor Drive, 55.25"	AM71193420	\$ 8.69
3 R62 BSN 64001 Note: Verify belt length before ordering	A/C Compressor Drive, 44.125"	AM71369747	\$ 11.30
3 R66, R72 ASN 79001, R76 Note: Verify belt length before ordering	A/C Compressor Drive, 51.25"	AM71148120	\$ 8.25
4 R62, R66, R72, R76	Clean Grain Elevator Drive	AM71368809	\$ 83.00
5 R66, R76	Propel Pump Drive	AM71390561	\$ 98.00
6 R62, R66, R72, R76	Cylinder Drive	AM71448442	\$ 354.00
7 R62 BSN 63001, R72 BSN 73001	Header Drive, Vari-Speed	AM71364154	Call for Price
7 R62 S/N 63001-68000, R72 S/N 73001-78000	Header Drive, Vari-Speed	AM71390886	\$ 260.00
7 R62 ASN 68001, R66, R72 ASN 78001, R76	Header Drive, Vari-Speed	AM71390885	\$ 397.00
7 R62, R66, R72, R76	Header Drive, Constant Speed	AM71364514	\$ 110.00
8 R62 BSN 66001, R72 BSN 76001	Hydro Drive	AM71363595	\$ 96.00
8 R62 ASN 66001, R72 ASN 76001	Hydro Drive	AM71374276	\$ 160.00
9 R62, R66, R72, R76	Chopper / Impeller Drive	AM71386695	\$ 67.00
9 R65, R66, R75, R76	Rear Feed / Chopper, Fine Cut	AM71381955	\$ 75.00
10 R62 BSN 63001, R72 BSN 73001	Jackshaft Drive, RH	AM71363793	\$ 90.00
10 R62, R66, R72, R76	Jackshaft Drive, RH (Popcorn Special)	AM71368072	\$ 56.00
10 R62 ASN 63001, R66, R72 ASN 73001, R76	Jackshaft Drive, Right Hand	AM71367469	\$ 70.00
11 R62 (S1)	Main Drive - For Air Cooled Engine Only - 3 Rib	AM71363804	\$ 275.00
11 R72 (S2), R72 (Air Cooled)	Main Drive	AM71363805	\$ 197.00
11 R62 (Liquid Cooled) BSN 64001	Main Drive	AM71366207	\$ 255.00
11 R62 (Liquid Cooled) ASN 64001	Main Drive	AM71368135	\$ 233.73
11 R66, R72 Liquid Cooled, R76	Main Drive	AM71370279	\$ 232.00
12 R62 BSN 68001, R72 BSN 78001	Pivot Drive, LH	AM71355232	\$ 95.00
12 R62 ASN 68001 (2B), R72 ASN 78001 (2B)	Pivot Drive, LH	AM71355232	\$ 95.00
12 R62 ASN 68001 (2C), R66, R72 ASN 78001 (2C), R76	Pivot Drive, LH	AM71377787	\$ 120.00

Prices Subject to Change without Prior Notice. The use of original equipment manufacturer (OEM) part numbers or trademarks, e.g. Case® and John Deere®, are for reference purposes only and for indicating product use and compatibility. Our company and the listed replacement parts contained herein are not sponsored, approved or manufactured by the OEM. All parts are New unless designated Reman in the description.

Gleaner®—Combine

Application	Description	Part Number	Retail Price
13 R62 BSN 63001, R72 BSN 73001	Pivot Shaft Drive	AM71364155	\$ 70.00
13 R62 ASN 63001, R72 ASN 73001	Pivot Shaft Drive, RH	AM71374306	\$ 57.00
13 R66, R76	Pivot Shaft Drive, RH	AM71427254	\$ 130.00
14 R62, R66, R72, R76	Rear Feed Conveyor	AM71335475	\$ 58.00
15 R62, R66, R72, R76	Separator Drive	AM71363802	\$ 95.00
16 R62 BSN 66001, R72 BSN 76001	Shoe Drive	AM71364077	\$ 32.30
16 R62 ASN 66001, R66, R72 ASN 76001, R76	Shoe Drive	AM71374305	\$ 62.00
17 R62, R66, R72, R76	Spreader Drive	AM71355170	\$ 50.00
18 R62, R72	Unloader Drive, Power Engage	AM71398366	\$ 42.00
18 R62, R66, R72, R76	Bin Unloader Countershaft	AM71380601	\$ 75.00
19 R62, R66, R72, R76	Tailings Drive, STD	AM71367459	\$ 43.25
19 R62, R66, R72, R76	Tailing Drive, w/ Tailings Return	AM71367460	\$ 85.00
20 R66, R76	Rotary Screen	AM71396754	\$ 16.25

Belts—R55, R65, R75

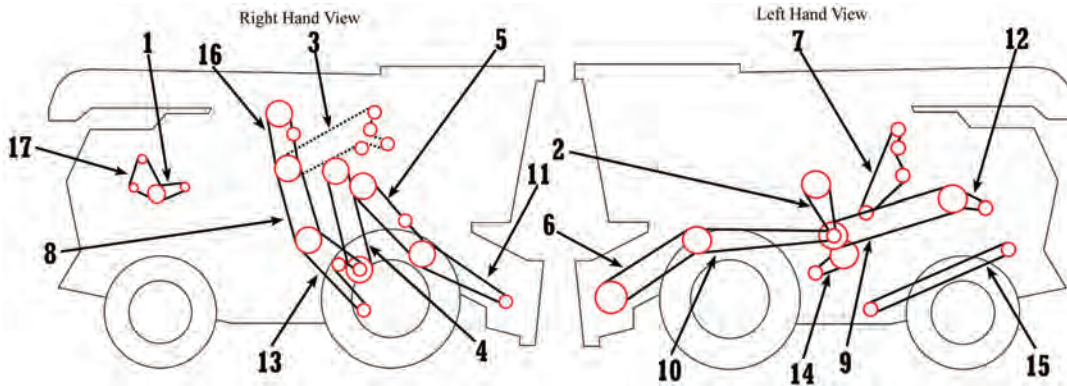

Application	Description	Part Number	Retail Price
1 R55, R65 BSN HR62101	A/C Compressor Drive	AM71369747	\$ 11.30
1 R65 ASN HR62101, R75	A/C Compressor Drive	AM71148120	\$ 8.25
2 R55, R65, R75	Bin Unloader Drive, LH	AM71398366	\$ 42.00
2 R65, R75	Bin Unloader Drive, LH w/ Turrent	AM71380601	\$ 75.00
3 R55, R65, R75	Clean Grain Elevator Drive	AM71368809	\$ 83.00
4 R55	Cylinder Drive	AM71335788	\$ 315.00
4 R65, R75	Cylinder Drive	AM71448442	\$ 354.00
5 R55, R65, R75	Feeder Conveyor, Rear	AM71335475	\$ 58.00
6 R55	Header Drive, Vari-Speed	AM71390886	\$ 260.00
6 R65, R75	Header Drive, Variable Speed	AM71390885	\$ 397.00
6 R55, R65, R75	Header Drive, Constant Speed	AM71448442	\$ 354.00
7 R55, R65, R75	Chopper / Impeller Drive	AM71386695	\$ 67.00
7 R55, R65, R75	Chopper / Impeller Drive, Fine Cut	AM71381955	\$ 75.00
8 R55, R65, R75	Jackshaft Drive, Right Hand	AM71367469	\$ 70.00
8 R65, R75	Jackshaft Drive, RH (Popcorn Special)	AM71368072	\$ 56.00
9 R55	Main Drive	AM71366207	\$ 255.00
9 R65 BSN HR62101	Main Drive	AM71368135	\$ 233.73
9 R65 ASN 62101, R75	Main Drive	AM71370279	\$ 232.00
10 R55	Pivot Jackshaft Drive	AM71355232	\$ 95.00

Gleaner®—Combine

Application	Description	Part Number	Retail Price
10 R65, R75	Pivot Jackshaft Drive	AM71377787	\$ 120.00
11 R55, R65 BSN HS62101, R75 BSN HS72101	Pivot Jackshaft Drive, RH	AM71374306	\$ 57.00
12 R65 BSN HR62101	Pump Drive	AM71390209	\$ 106.37
12 R65 ASN HR62101, R75	Pump Drive	AM71390561	\$ 98.00
13 R55	Separator Drive	AM71358255	\$ 88.00
13 R65, R75	Separator Drive	AM71363802	\$ 95.00
14 R55, R65, R75	Shoe Drive	AM71374305	\$ 62.00
15 R55, R65, R75	Straw Spreader Drive	AM71355170	\$ 50.00
16 R55, R65, R75	Tailing Drive	AM71367459	\$ 43.25
16 R55, R65, R75	Tailing Drive, w/ Tailings Return	AM71367460	\$ 85.00
17 R75 BSN HR72101	Alternator Drive	AM3028521	\$ 12.39
17 R75 BSN HR72101	Fan Drive, 48.00° STD	AMA3288601	\$ 23.00
17 R75 BSN HR72101	Fan Drive, 48.50° OPT	AMA3288623	\$ 27.00
17 R65 ASN HR62101, R75 ASN HR72101	Alternator / Fan Drive	AMV685121585	\$ 55.61
17 R65, R75 Engine ASN T11858	Alternator / Fan Drive	AMV685121530	\$ 63.20
NI R65, R75	Spreader Pump Drive	AM71379787	\$ 52.37
NI R55	Hydro Drive	AM71374277	\$ 89.00

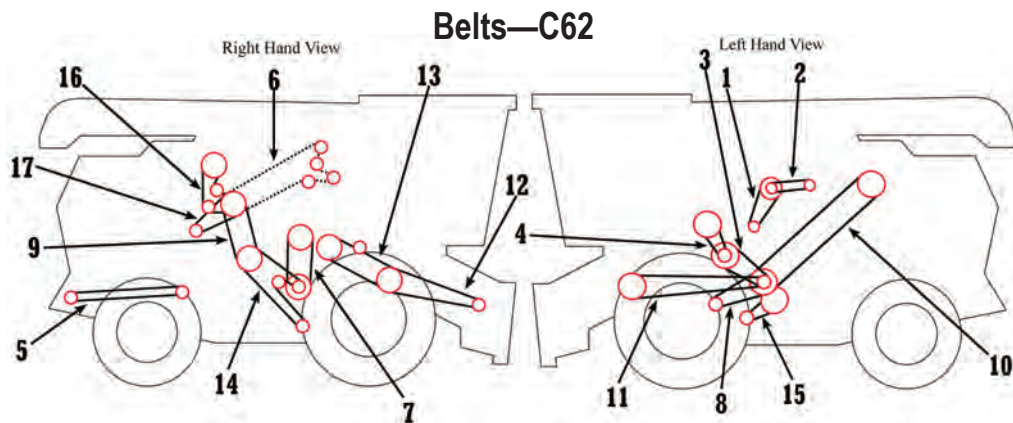

Application	Description	Part Number	Retail Price
1 C62	Front Beater Drive	AM71382504	\$ 84.50
2 C62	Rear Beater Drive	AM71381952	\$ 66.00
3 C62	Bin Unloader Drive, LH	AM71380601	\$ 75.00
6 C62	Clean Grain Elevator Drive	AM71368809	\$ 83.00
7 C62	Cylinder Drive	AM71381413	\$ 362.00
8 C62	Hydro Drive	AM71374276	\$ 160.00
9 C62	Jackshaft Drive, Right Hand	AM71367469	\$ 70.00
10 C62	Main Drive	AM71380485	\$ 276.00
11 C62	Walking Drive	AM71380655	\$ 50.00
12 C62	Pivot Jack Shaft Drive, RH	AM71374306	\$ 57.00
13 C62	Rear Feed Conveyor	AM71381955	\$ 75.00
14 C62	Separator Drive	AM71358255	\$ 88.00
15 C62	Shoe Drive	AM71374305	\$ 62.00
16 C62	Tailing Drive	AM71367460	\$ 85.00
17 C62	Walking Drive	AM71380655	\$ 50.00

Prices Subject to Change without Prior Notice. The use of original equipment manufacturer (OEM) part numbers or trademarks, e.g. Case® and John Deere®, are for reference purposes only and for indicating product use and compatibility. Our company and the listed replacement parts contained herein are not sponsored, approved or manufactured by the OEM. All parts are New unless designated Reman in the description.

Gleaner®—Combine

Belts—Hesston® 6550, 6555, 6600, 8200, 8400

Application	Description	Part Number	Retail Price
8400	Reel Drive	AM55574	\$ 43.00
8200	Reel Drive	AM857219	\$ 42.00
6600	Reel Drive	AM57471	\$ 45.76
8200	Sickle Drive	AM700705430	\$ 61.95
8200	Header Drive, Set of 3	AM700705503	\$ 147.00
8200	Header Drive	AM7855331	\$ 54.50
8200	Trans Drive	AM7855349	\$ 69.58
6550, 6555	Pitman Drive	AM855718	\$ 26.76
6600 S/N 660H-50-660H-1773	Sickle Drive	AM856559	\$ 33.00
6600 ASN 660H-1850	Sickle Drive	AM857862	\$ 28.03

Belts—S67, S77

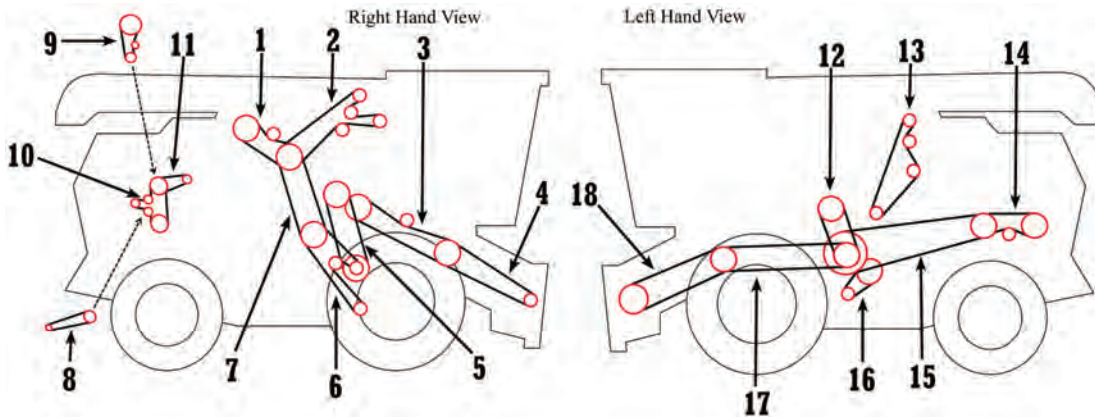

Application	Description	Part Number	Retail Price
1 S67, S77	Tailing Drive, w/ Tailings Return	AM71367460	\$ 85.00
2 S67, S77	Clean Grain Elevator Drive	AM71368809	\$ 83.00
3 S67, S77	Rear Feed Conveyor	AM71335475	\$ 58.00
4 S67 ASN BHTV6501	Pivot Shaft Drive, RH	AM71427254	\$ 130.00
4 S77 ASN BHTV7501	Pivot Shaft Drive, RH	AM71427254	\$ 130.00
4 S67 ASN CHTV6501	Pivot Shaft Drive, RH	AM71449944	\$ 92.50
4 S77 ASN CHTV7501	Pivot Shaft Drive, RH	AM71449944	\$ 92.50
5 S67, S77	Rotor Drive	AM71427223	\$ 425.50
6 S67 ASN BHTV6501	Separator Drive	AM71432846	\$ 140.00
6 S77 ASN BHTV7501	Separator Drive	AM71432846	\$ 140.00
6 S67 ASN CHTV6501, S77 ASN CHTV7501	Separator Drive	AM71441879	\$ 138.00
7 S67, S77	Jackshaft Drive, Right Hand	AM71367469	\$ 70.00
8 S67, S77	Aspirator Fan Drive	AM71438552	\$ 24.24
9 S67, S77	Rotary Screen	AM71396754	\$ 16.25
10 S67, S77	Alternator and Fan	AM71444986	\$ 36.00
11 S67 ASN BHTV6501	A/C Compressor Drive	AM71148120	\$ 8.25
11 S77 ASN BHTV7501	A/C Compressor Drive	AM71148120	\$ 8.25
11 S67 ASN CHTV6501	A/C Compressor Drive	AM71449337	\$ 10.00
11 S77 ASN CHTV7501	A/C Compressor Drive	AM71449337	\$ 10.00
13 S67 ASN BHTV6501	Impeller Drive	AM71441005	\$ 89.63

Gleaner®—Combine

Application	Description	Part Number	Retail Price
13 S77 ASN BHTV7501	Impeller Drive	AM71441005	\$ 89.63
13 S67 ASN CHTV6501, S77 ASN CHTV7501	Impeller Blade	AM71444306	\$ 80.00
13 S67, S77	Chopper Drive (Fine Cut)	AM71432802	\$ 112.14
14 S67, S77	Propel Pump Drive	AM71390561	\$ 98.00
15 S67, S77	Main Clutch Shaft Drive	AM71370279	\$ 232.00
16 S67, S77	Shoe Drive	AM71428995	\$ 52.07
17 S67 ASN BHTV6501	Pivot Jackshaft Drive	AM71377787	\$ 120.00
17 S77 ASN BHTV7501	Pivot Jackshaft Drive	AM71377787	\$ 120.00
17 S67 ASN CHTV6501, S77 ASN CHTV7501	Jackshaft Pivot Drive, Left Hand Pivot	AM71449942	\$ 165.00
18 S67 ASN BHTV6501	Header Drive, Variable Speed	AM71456526	\$ 397.00
18 S77 ASN BHTV7501	Header Drive, Variable Speed	AM71456526	\$ 397.00
18 S67 ASN CHTV6501, S77 ASN CHTV7501	Header Drive, Variable Speed	AM71447319	\$ 454.12
18 S67 BSN BHTV6101	Header Drive, Fixed Speed	AM71364514	\$ 110.00
18 S77 BSN BHTV7101	Header Drive, Constant Speed	AM71364514	\$ 110.00
18 S67 ASN BHTV6101	Header Drive, Fixed Speed	AM71438655	\$ 180.00
18 S77 ASN BHTV7101	Header Drive, Fixed Speed	AM71438655	\$ 180.00
18 S67 ASN CHTV6501, S77 ASN CHTV7501	Header Drive, Fixed Speed	AM71449945	\$ 245.00
NI S67, S77	Water Pump	AMV685010894	Call for Price
NI S67, S77	Water Pump	AMV685040894	\$ 73.53

Belts—S68, S78, S88, S96, S97, S98

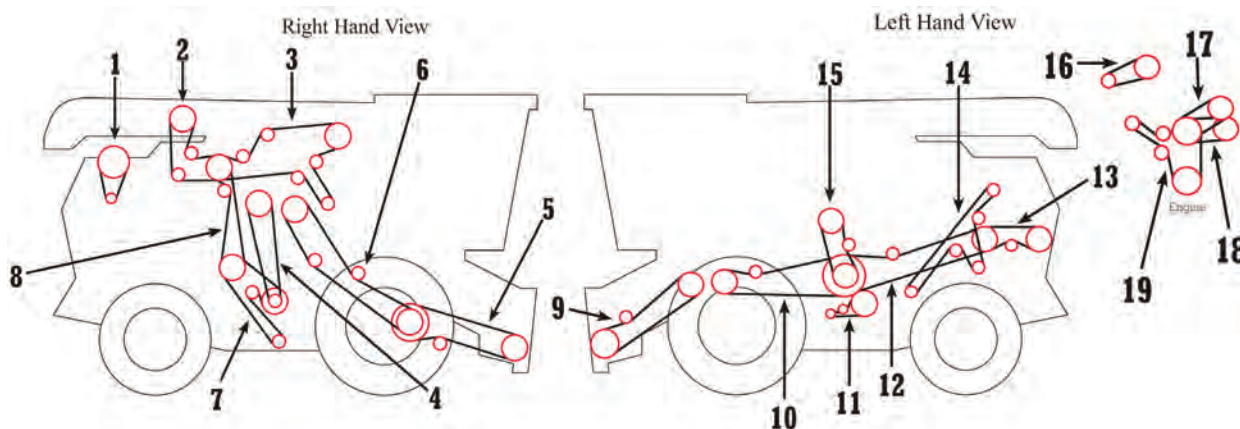

Application	Description	Part Number	Retail Price
1 S68, S78, S88, S96, S97, S98	Rotary Screen	AM71396754	\$ 16.25
2 S68, S78, S88, S96, S97, S98	Tailing Drive	AM71367460	\$ 85.00
3 (S68, S78, S88 BSN FHTVX101)	Clean Grain Elevator Drive	AM71368809	\$ 83.00
4 S68, S78, S88, S96, S97, S98	Rotor Drive	AM71478529	\$ 567.72
6 S68, S78, S88	Feed Conveyor, Rear	AM71456988	\$ 144.00
6 S96, S97, S98	Feed Conveyor, Rear	AM71475925	\$ 168.00
7 S68, S78, S88, S96, S97, S98	Separator Drive	AM71441879	\$ 138.00
8 S68, S78, S88, S96, S97, S98	Jackshaft Drive, Right Hand	AM71367469	\$ 70.00
9 S68, S78, S88	Header Drive, Fixed Speed	AM71449945	\$ 245.00
9 S68, S78, S88	Header Drive, Variable Speed	AM71447319	\$ 454.12
10 S68, S78, S88, S96, S97, S98	Jackshaft Pivot Drive	AM71449942	\$ 165.00
11 S68, S78, S88, S96, S97, S98	Shoe Drive	AM71428995	\$ 52.07

Prices Subject to Change without Prior Notice. The use of original equipment manufacturer (OEM) part numbers or trademarks, e.g. Case® and John Deere®, are for reference purposes only and for indicating product use and compatibility. Our company and the listed replacement parts contained herein are not sponsored, approved or manufactured by the OEM. All parts are New unless designated Reman in the description.

Gleaner®—Combine

Application	Description	Part Number	Retail Price
12 S68, S78, S88	Main Drive	AM71370279	\$ 232.00
13 S68, S78, S88, S96, S97, S98	Pump Drive, PTO	AM71390561	\$ 98.00
14 S68, S78, S88, S96, S97, S98	Impeller Blade	AM71444306	\$ 80.00
14 S68, S78, S88, S96, S97, S98	Fine Cut Chopper	AM71471836	\$ 114.33
15 S68, S78, S88, S96, S97, S98	Bin Unloader Drive	AM71464666	\$ 105.00
16 S68, S78, S88, S96, S97, S98	Aspirator Fan Drive	AM71438552	\$ 24.24
18 S68, S78, S88, S96, S97, S98	Water Pump	AMV685040894	\$ 73.53
19 S68, S96, S97, S98	Alternator	AM71444986	\$ 36.00
19 S78, S88, S96	Alternator	AM71448150	\$ 48.00

Belts—A65, A66, A75, A76, A85, A86

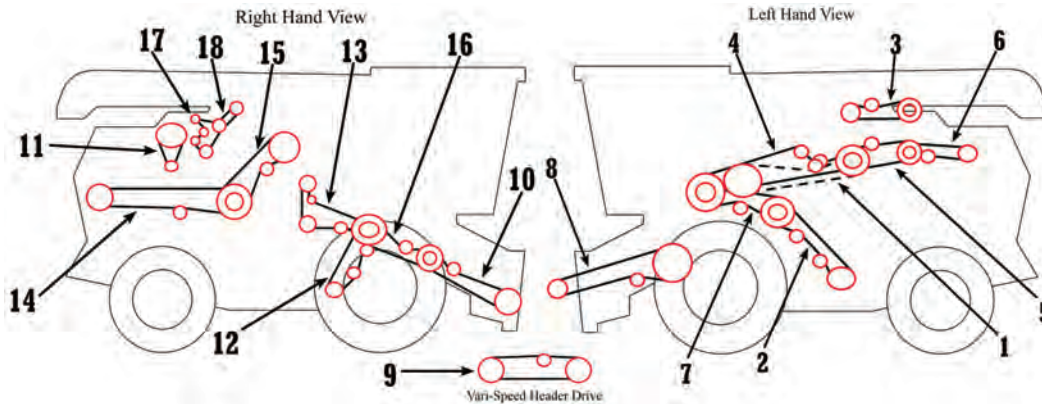

Application	Description	Part Number	Retail Price
1 A66, A76, A85, A86	Unloader Drive	AM71410767	\$ 87.00
1 A65, A75	Unloader Drive	AM101102M1	\$ 100.39
2 A66, A76, A86	Grain Elevator Drive	AM71410765	\$ 76.00
2 A65, A75, A85	Grain Elevator Drive	AM71403685	\$ 50.64
3 A75, A76	Pump Drive, Propel	AM71418978	\$ 120.00
3 A85, A86	Pump Drive, Propel	AM71406286	\$ 86.00
4 A66, A75, A76, A85, A86	Beater Drive	AM71388216	\$ 210.33
4 A65	Beater Drive, 175.30"	AM71386352	\$ 131.91
5 A65, A66, A75, A76	Main Countershaft	AM71390188	\$ 109.89
5 A75, A76	Main Countershaft	AM71403721	\$ 175.00
6 A75, A76	Pump Drive, Rotor	AM71418976	\$ 113.00
6 A65, A66	Pump Drive, Rotor	AM71418984	\$ 151.99
6 A85, A86	Pump Drive, Rotor	AM71406285	\$ 99.00
7 A65, A66, A75, A76, A85, A86	Shaker Shoe Pitman Drive	AM71390199	\$ 71.45
8 A66, A76, A86	Feeder, Pivot Shaft	AM71427255	\$ 76.00
8 A65, A75, A85	Feeder, Pivot Shaft	AM71398388	\$ 77.41
9 A65, A75, A85	Header Countershaft, Vari-Speed	AM71399505	\$ 412.80
9 A66, A76, A86	Header Countershaft, Vari-Speed	AM71423444	\$ 437.00
10 A65, A66, A75, A76, A85, A86	Header Countershaft, Fixed Speed	AM71399519	\$ 227.36
11 A65, A66, A75, A76, A85, A86	Rotary Screen	AM71396754	\$ 16.25
12 A65, A66, A75, A76	Fan Drive, Vari-Speed	AM71394352	\$ 86.00
12 A85, A86	Cleaning Fan, Vari-Speed	AM71400662	\$ 80.00
13 A65, A66, A75, A76, A85, A86	Return Elevator Drive	AM71385801	\$ 38.10

Gleaner®—Combine

	Application	Description	Part Number	Retail Price
14	A65, A66, A75, A76, A85, A86	Chopper (Secondary)	AM71406339	\$ 121.63
14	A65, A66, A75, A76, A85, A86	Spreader Drive (Secondary)	AM1680230W1	\$ 62.00
14	A86	Chopper, MAV (Secondary)	AM71430816	\$ 264.03
15	A65, A75	Jackshaft Spreader Drive	AM1680230W1	\$ 62.00
15	A65, A75	Chopper (Primary)	AM71406361	\$ 76.81
15	A66, A76, A85, A86	Jackshaft Spreader (Primary)	AM71414420	\$ 63.00
15	A66, A76, A85, A86	Chopper (Primary)	AM71406338	\$ 75.08
15	A86	Chopper, MAV (Primary)	AM71424226	\$ 102.92
16	A65, A66, A75, A76, A85, A86	Beater to Feederhouse Jackshaft	AM71398384	\$ 128.43
17	A65, A75 Engine BSN T11858	Fan and Alternator	AMV685121585	\$ 55.61
17	A65, A66, A75, A76 Engine ASN T11858	Fan and Alternator	AMV685121530	\$ 63.20
17	A85	Fan and Alternator	AM71407841	\$ 64.86
17	A86	Fan and Alternator	AM288-1607	\$ 64.86
18	A65, A66, A75, A76	A/C Compressor	AM71148120	\$ 8.25

Allis Chalmers®—Industrial / Construction

Table of Contents

Crankshafts 352

Crankshafts

Application	Description	Part Number	Retail Price	Core
Backhoe-Loader: 540	Crankshaft 172D 172 CID 2.8 Liter 4 Cylinder Diesel Engine 3.60" Stroke, 3.8998" - 3.9018" Bore, 2.2978" - 2.2988" Rod, 2.4978" - 2.4988" Main Flange - No Centering Ring, Flat, 6 Bolt Holes, 1 Dowel Hole Snout - Splined, 1 Keyway, w/ 74 Tooth Straight Balance Gear Replaces B9NN6302B	AMEZJL6300BA-2	\$ 610.00	
Loaders: TL10 SN 638-1800, TL11 BSN 73, TL12 BSN 1281 Replaces 70213353, 70226526, 70229022, 70241291, U-3986	Crankshaft G226 226 CID 4 Cylinder Engine 4.50" Stroke, 4" - 4.001" Bore, 2.374" - 2.375" Rod, 2.435" - 2.4365" Front Main Journal, 2.477" - 2.478" Center Main Journal, 2.477" - 2.478" Rear Main Journal Flange - 4 Bolt Holes Snout - 1 Keyway	AM70226535	\$ 575.00	

Amadas®—Peanut Combine

Table of Contents

Belts—511	353	Belts—9665, 9865, 9965A.....	356
Belts—520, 522, 522A, 525, 525W	353	Belts—9797T, 9897T, 9997T, 9998F	357
Belts—600, 622, 625, 660, 662, 663	354	Belts—9900, 9960, A9900.....	357
Belts—2108, 2110	355	Belts—9970	358
Belts—8557	355	Belts—9997A, 9997B, 9997E, 9997F.....	358
Belts—9097, 9297, 9597, 9797, 9897	356	Belts—M2100A, M2100D, M2100T, M9997A, M9997T.....	359

Belts—511

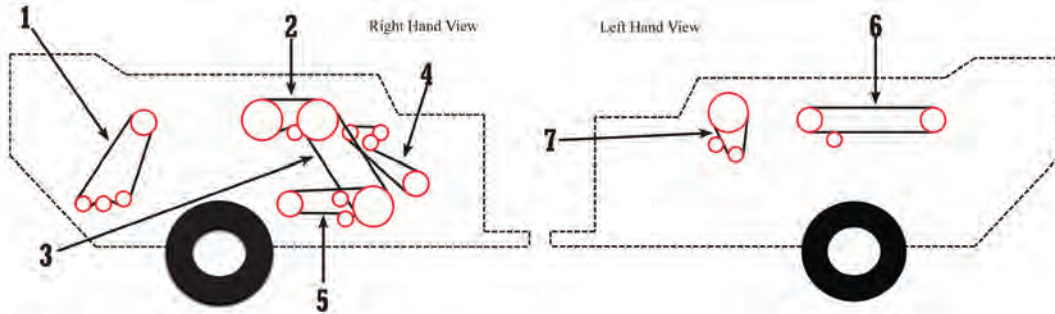

Application	Description	Part Number	Retail Price
1 511	Stemmer Drive	AMBB128	\$ 70.25
2 511	Cylinder Drive, 4th Cylinder	AMC88	\$ 30.00
3 511	Cylinder Drive, 3rd Cylinder	AMC144	\$ 48.55
4 511	Infeed Table Drive	AMBB128	\$ 70.25
5 511	Cleaning Fan Drive, Primary	AMB112	\$ 25.31
6 511	Cylinder Drive, Fluffer	AMB144	\$ 31.01
7 511	Fan Drive, Recleaner	AM4L560	\$ 8.54

Belts—520, 522, 522A, 525, 525W

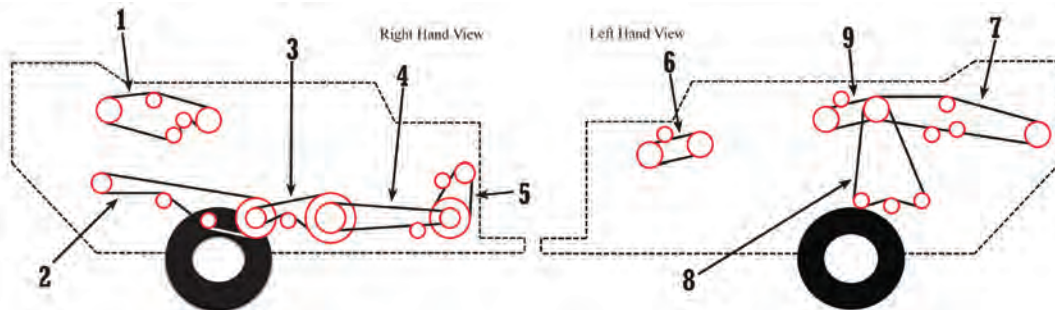

Application	Description	Part Number	Retail Price
1 520, 522	Straw Rack Drive	AM4069	\$ 26.68
1 522A, 525, 525W	Straw Rack Drive	AMB136	\$ 26.68
2 520, 522 1st Edition	Pneumatic Conveyor Drive Set of 2	AM4001	\$ 51.89
2 522 2nd Edition and Later	Pneumatic Conveyor Drive	AM4069	\$ 26.68
2 522A, 525, 525W	Pneumatic Conveyor Drive	AMB136	\$ 26.68
3 520	Fan Drive, Cleaning	AM4068	\$ 38.10
3 522	Fan Drive, Cleaning	AM4180	\$ 31.73
3 522A, 525, 525W	Fan Drive, Cleaning	AMC112	\$ 31.73
4 520, 522	Main Drive	AM4066	\$ 48.55

Amadas®—Peanut Combine

Prices Subject to Change without Prior Notice. The use of original equipment manufacturer (OEM) part numbers or trademarks, e.g. Case® and John Deere®, are for reference purposes only and for indicating product use and compatibility. Our company and the listed replacement parts contained herein are not sponsored, approved or manufactured by the OEM. All parts are New unless designated Reman in the description.

Amadas®—Peanut Combine

Application	Description	Part Number	Retail Price
4 522A 2nd Edition	Main Drive	AMC144	\$ 48.55
4 522A 3rd & 4th Edition, 525, 525W	Main Drive Use w/ 545 RPM Set Up	AMC144	\$ 48.55
4 522A 3rd & 4th Edition, 525, 525W	Main Drive Use w/ 1000 RPM Set Up	AMC148	\$ 42.28
6 520	Feeder Drive	AM4008	\$ 18.99
7 522	Vine Spreader Drive	AM4179	\$ 35.67
7 522A	Vine Spreader Drive	AMB158	\$ 35.67
8 520	Stemmer Drive	AM4070	\$ 53.00
8 522	Stemmer Drive	AM4184	\$ 70.25
8 522A, 525, 525W	Stemmer Drive	AMBB128	\$ 70.25
9 522A 2nd Edition	Drive	AMB48	\$ 8.42
9 522A 3rd Edition	Drive	AMB43	\$ 10.62

Belts—600, 622, 625, 660, 662, 663



Application	Description	Part Number	Retail Price
1 600	Digger/Inverter Set of 2	AM4007	\$ 45.40
1 622	Digger/Inverter	AM2B128	\$ 68.97
1 660	Digger/Inverter Set of 2	AM4001	\$ 51.89
1 625	Main Drive	AMC158	\$ 63.11
1 662, 663	Inverter Drive Set of 2	AM4087	\$ 33.23
2 625	Inverter Drive Set of 2	AMB55	\$ 33.23
3 662, 663	Conveyor Drive	AM4107	\$ 68.97

Amadas®—Peanut Combine

Belts—2108, 2110

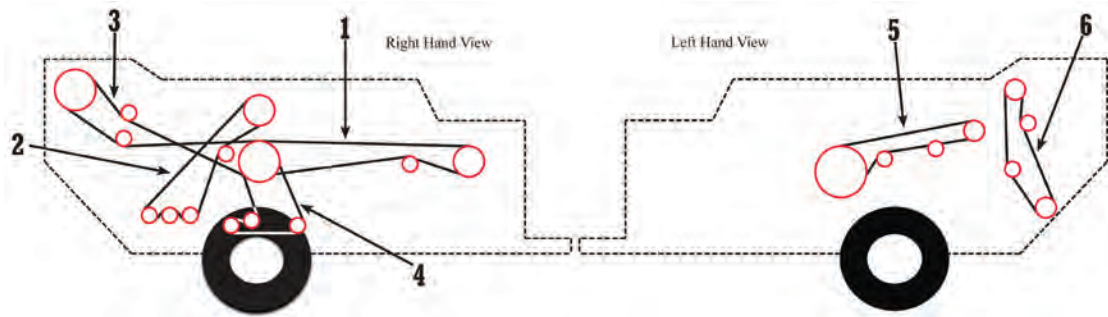

Application	Description	Part Number	Retail Price
1 2108, 2110	Drive	AM4C240	\$ 327.68
2 2108, 2110	Drive	AMBB155	\$ 50.39
3 2108, 2110	Drive	AMC285	\$ 93.19
4 2108, 2110	Drive	AMCC158	\$ 137.51
5 2108, 2110	Drive	AM3B240	\$ 231.51
6 2108, 2110	Drive Use w/ OPT Vine Spreader	AMB136	\$ 26.68

Belts—8557

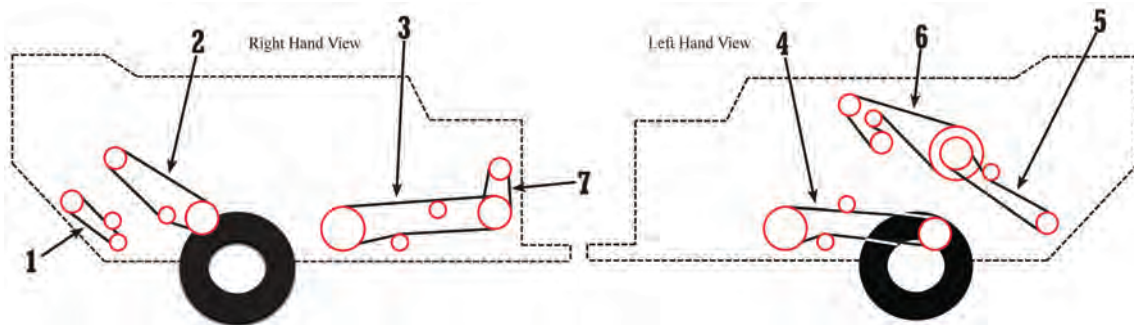

Application	Description	Part Number	Retail Price
1 8557 ASN 23273	Drive	AMA66	\$ 9.49
2 8557	Pneumatic Conveyor Drive	AMB108	\$ 24.34
3 8557	Countershaft Drive	AMC158	\$ 63.11
4 8557	Fan Drive, Cleaning	AMC180	\$ 54.00
5 8557	Stemmer Saw Drive	AMB112	\$ 25.31
6 8557	Straw Walker Drive	AMBB144	\$ 46.04
7 (8557 SN 27439-27521, SN A01001-A01100 & SN A28439-A29128)	Hydraulic Pump Drive	AMB54	\$ 14.82

Amadas®—Peanut Combine

Belts—9097, 9297, 9597, 9797, 9897

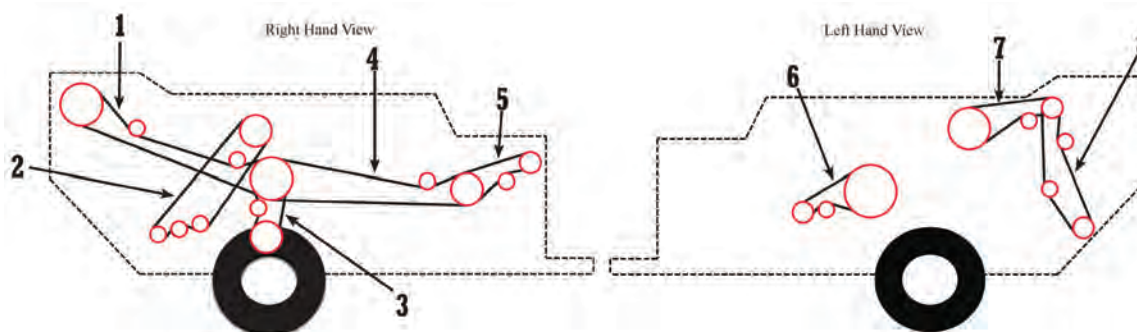

Application	Description	Part Number	Retail Price
1 2108, 2110	Drive	AM4C240	\$ 327.68
2 2108, 2110	Drive	AMBB155	\$ 50.39
3 2108, 2110	Drive	AMC285	\$ 93.19
4 2108, 2110	Drive	AMCC158	\$ 137.51
5 2108, 2110	Drive	AM3B240	\$ 231.51
6 2108, 2110	Drive Use w/ OPT Vine Spreader	AMB136	\$ 26.68

Belts—9665, 9865, 9965A

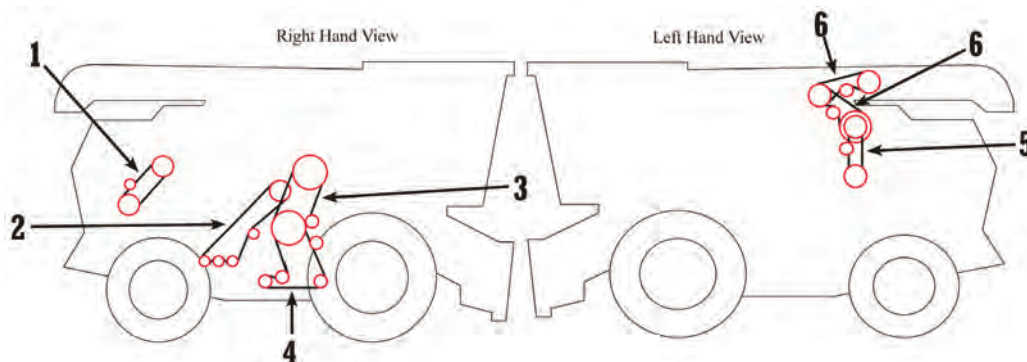

Application	Description	Part Number	Retail Price
1 9665	Drive	AMB93	\$ 22.78
1 9865, 9965A	Drive	AMB91	\$ 31.93
2 9665, 9865, 9965A	Drive	AMBB144	\$ 46.04
3 9665, 9865	Drive	AM3C148	\$ 236.19
3 9965A	Drive	AM4C148	\$ 243.26
4 9665, 9865	Drive	AMCC240	\$ 222.88
4 9965A	Drive	AMCC158	\$ 137.51
5 9665	Drive	AM2B77	\$ 52.26
5 9865, 9965A	Drive	AM2B85	\$ 48.25
6 9665, 9665A, 9865	Drive	AMC75	\$ 23.73

Amadas®—Peanut Combine

Belts—9797T, 9897T, 9997T, 9998F

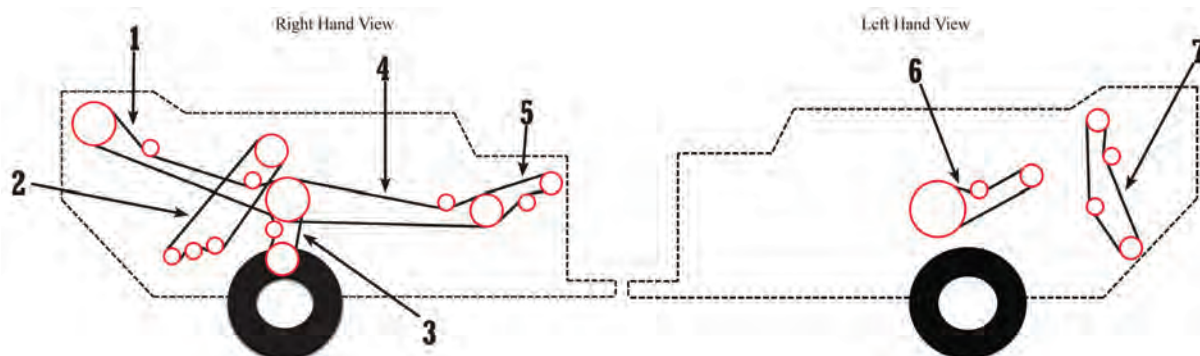

Application	Description	Part Number	Retail Price
1 2108, 2110	Drive	AM4C240	\$ 327.68
2 2108, 2110	Drive	AMBB155	\$ 50.39
3 2108, 2110	Drive	AMC285	\$ 93.19
4 2108, 2110	Drive	AMCC158	\$ 137.51
5 2108, 2110	Drive	AM3B240	\$ 231.51
6 2108, 2110	Drive Use w/ OPT Vine Spreader	AMB136	\$ 26.68

Belts—9900, 9960, A9900

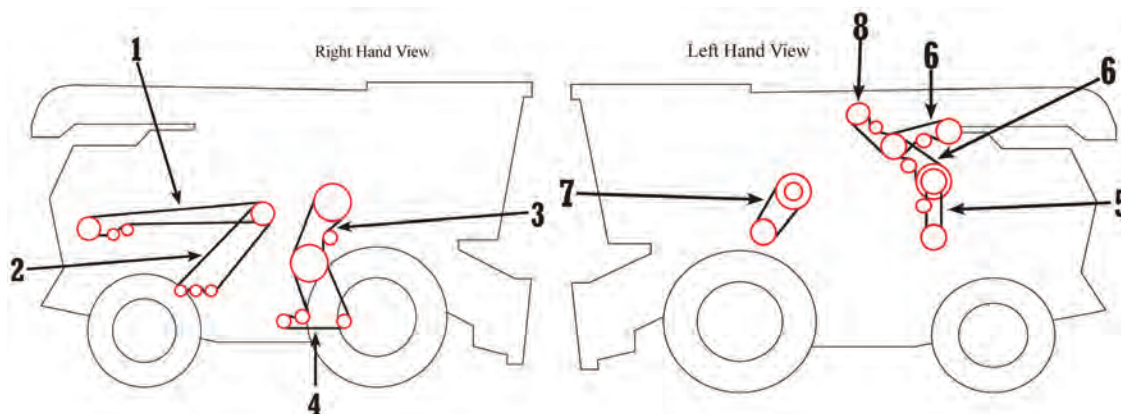

Application	Description	Part Number	Retail Price
1 9900, 9960, A9900	Vine Spreader Drive	AMB225	\$ 47.40
2 9900, 9960, A9900	Drive	AMBB144	\$ 46.04
3 9900, 9960, A9900	Drive	AM4C148	\$ 243.26
4 9900, 9960, A9900	Drive	AMCC158	\$ 137.51
5 9900, 9960 BSN 420000, A9900	Drive	AM2B85	\$ 48.25
5 9960 ASN 420000	Drive	AM3B85	\$ 84.11
6 9900, 9960, A9900	Drive	AMC75	\$ 23.73
7 9900, 9960, A9900	Drive, Variable Speed	AM4878	\$ 102.00
8 9960 BSN 420000	Drive	AMC68	\$ 24.00
8 9960 ASN 420000	Drive	AMC67	\$ 28.20

Amadas®—Peanut Combine

Amadas®—Peanut Combine

Belts—9970

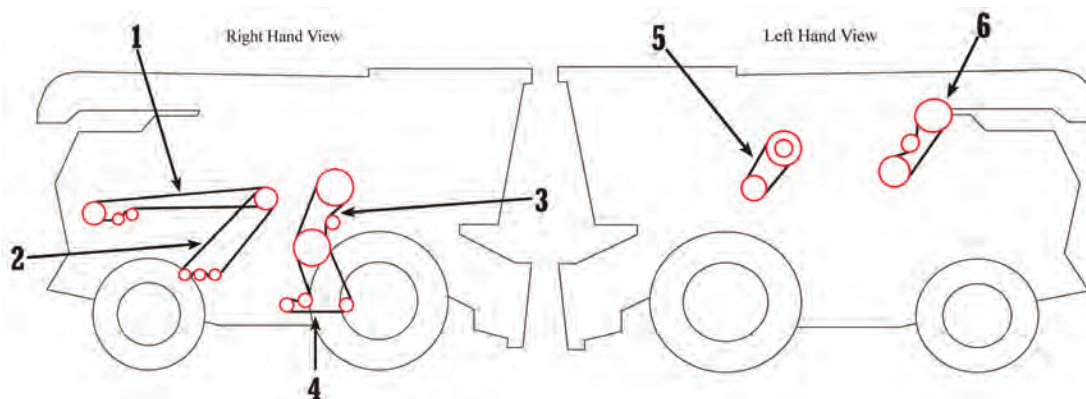

Application	Description	Part Number	Retail Price
1 9970	Drive	AMB225	\$ 47.40
2 9970	Drive	AMBB144	\$ 46.04
3 9970	Drive	AM4C148	\$ 243.26
4 9970	Drive	AMCC158	\$ 137.51
5 9970	Drive, Variable Speed	AM4878	\$ 102.00
6 9970	Drive	AM3GBCX100	\$ 149.00

Belts—9997A, 9997B, 9997E, 9997F

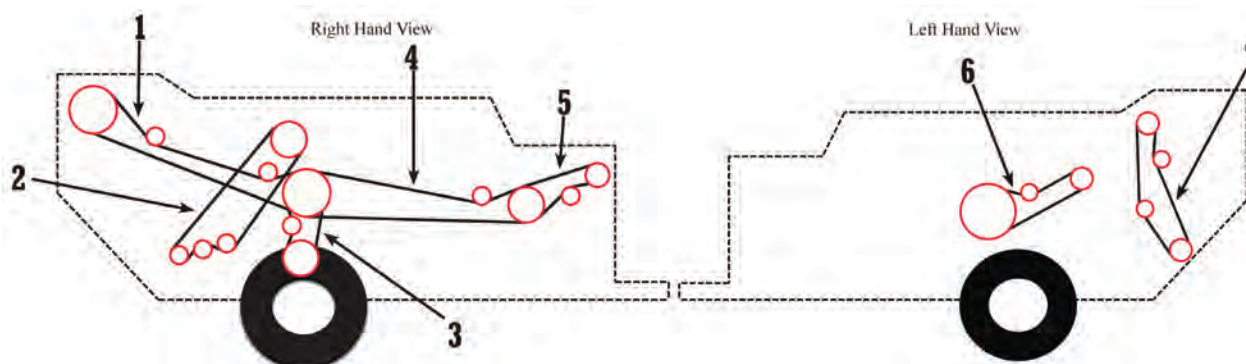

Application	Description	Part Number	Retail Price
1 9997A, 9997B, 9997E, 9997F	Drive	AMC285	\$ 93.19
2 9997A, 9997B, 9997E, 9997F	Drive	AMBB155	\$ 50.39
2 9997E, 9997F	Straw Walker Drive	AMBB144	\$ 46.04
3 9997A, 9997B, 9997E, 9997F	Drive	AMCX101	\$ 64.59
4 9997A, 9997B, 9997E, 9997F	Drive	AM4C240	\$ 327.68
5 9997A, 9997B, 9997E, 9997F BSN 420000	Drive	AMB105	\$ 22.69
6 9997A, 9997B	Drive	AM2B180	\$ 124.01
6 9997E, 9997F	Drive	AMBX124	\$ 25.48
7 9997A, 9997B, 9997E, 9997F	Drive	AMB136	\$ 26.68
	Use w/ OPT Vine Spreader		

Amadas®—Peanut Combine

Belts—M2100A, M2100D, M2100T, M9997A, M9997T

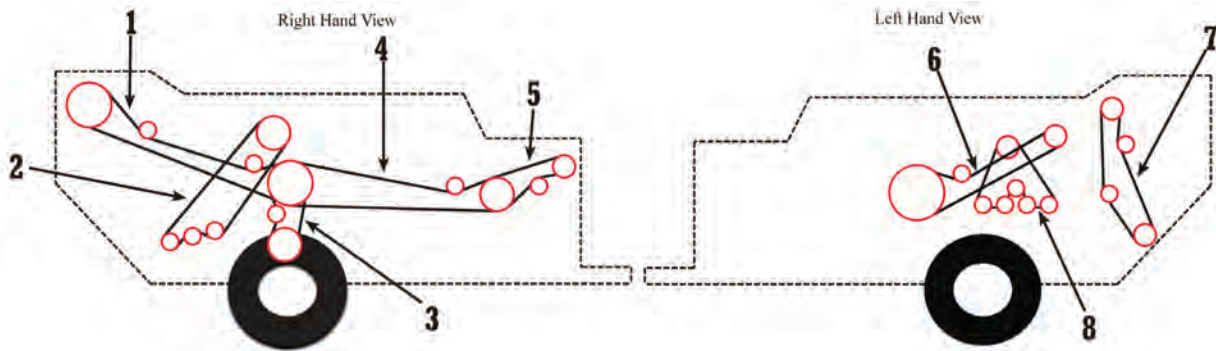

Application	Description	Part Number	Retail Price
1 M2100A, M2100D, M2100T, M9997A, M9997T	Drive	AMC285	\$ 93.19
2 M2100A, M2100D, M2100T, M9997A, M9997T	Drive	AMBB155	\$ 50.39
3 M2100A, M2100D, M2100T, M9997A, M9997T	Drive	AMCX101	\$ 64.59
4 M2100A, M2100D, M2100T, M9997A, M9997T	Drive	AM4C240	\$ 327.68
5 M2100A, M2100D, M2100T SN 410000-419999, M9997A, M9997T	Drive	AMB105	\$ 22.69
6 M2100A, M2100D, M2100T, M9997A, M9997T	Drive	AM2B180	\$ 124.01
7 M2100A, M2100D, M2100T, M9997A, M9997T	Drive Use w/ OPT Vine Spreader	AMB136	\$ 26.68
8 M2100D, M2100T SN 420000-429999	Drive	AMB116	\$ 22.16

Bobcat®—Industrial / Construction

Table of Contents

Radiators	360	Starters	360
-----------------	-----	----------------	-----

Radiators

Application	Description	Part Number	Retail Price	Core
Excavators: 430, 430D, 435, 435D, 435G	Radiator Overall: 26" x 18 5/8" Core: 21 1/2" x 18 1/4" x 2 3/4" 3 Rows, 10 Fins per Inch	AM6679831	\$ 595.00	

Starters

Application	Description	Part Number	Retail Price	Core
Wheel Loaders: 2000, 2400, 2410 - Diesel	Starter, 12 Volt HD Planetary Gear Reduction, 10 Tooth Steel Pinions, Steel Ring Gear, 4kW, CW Rotation For Diesel Engines Replaces 1113391, 1113672	AMX34112	\$ 285.00	
	Solenoid Use w/ AMX34112 Starter	AMX34113	\$ 60.00	

Air Cleaner Components	373	Injectors	370
Air Conditioning and Components	388	Lighting	381
Alternators	373	Longblock Assemblies	361
Axle Pivot Components	378	Manifolds and Components	371
Battery Boxes and Components	381	Mufflers and Exhaust	371
Belts	368	Oil Pumps, Engine	364
Brakes and Components	380	Overhaul Kits	362
Brake Shafts and Side Gears	380	Power Steering Cylinders and Components	375
Cab Doors	387	Power Steering Pumps	379
Cables	387	PTO Adapters	379
Cab Roofs	386	PTO Shafts	379
Camshafts and Lifters	364	Quick Hitches	381
Carburetors	369	Radiator Hoses	366
Connecting Rods	364	Radiators	365
Crankshafts	363	Remote Valve Components	378
Cylinder Heads, Bare	364	Ring Gears and Pinions	380
Drawbars and Components	380	Sensors	374
Flywheels and Components	367	Shop Manuals and Collections	390
Front Weight Bracket	381	Shortblock Assemblies	361
Fuel Lift Pumps	369	Spindles	375
Fuel Tanks and Components	388	Starters	373
Gas Struts	387	Steering Arms	377
Glass	386	Tie Rods and Components	374
Hammer Straps	381	Turbochargers	371
Hydraulic Oil Coolers	378	Water Pumps	367
Hydraulic Pumps and Components	378	Wheel Bearing Kits	377
Injection Pumps	369	Wheel Hubs and Components	376

Longblock Assemblies

Our remanufactured longblocks meet the highest standards in quality. All remanufactured components are inspected for structural integrity, cracks and dimensional specifications and then remanufactured back to OEM specifications. The components are then assembled using the highest quality new parts. We back this with one of the best warranties in the industry.



Application	Description	Part Number	Retail Price	Core
1896, 2096 - w/ 5.9 Turbo Engine	Longblock Assembly Replaces J920758, J286312	LBCUM5.9TA-N	\$ 6220.00	\$ 1000.00

Shortblock Assemblies

Our remanufactured shortblocks meet the highest standards in quality. All remanufactured components are inspected for structural integrity, cracks and dimensional specifications and then remanufactured back to OEM specifications. The components are then assembled using the highest quality new parts. We back this with one of the best warranties in the industry.



Application	Description	Part Number	Retail Price	Core
550 Early, 650 Early, Backhoe-Loader: 580 Super L - All w/ 3.9T 4 Cylinder Cummins® Engine	Reman Shortblock Assembly	SBCUM3.9T	\$ 3825.00	\$ 1000.00
850 Early w/ 5.9 6 Cylinder Cummins®	Reman Shortblock Assembly	SBCUM5.9	\$ 4250.00	\$ 1000.00
5.9T 6 Cylinder Cummins®	Reman Shortblock Assembly	SBCUM5.9T	\$ 4250.00	\$ 1000.00
970 w/ 401B 6 Cylinder Diesel	Reman Shortblock Assembly	SBCA401BD970	\$ 5500.00	\$ 1000.00
1070 Early w/ 451BD 6 Cylinder Diesel	Reman Shortblock Assembly	SBCA451E1070	\$ 5500.00	\$ 1000.00
1070 Late w/ 451BD 6 Cylinder Diesel	Reman Shortblock Assembly	SBCA451L1070	\$ 5500.00	\$ 1000.00
1175 Early, 1270 - w/ 451 6 Cylinder Diesel	Reman Shortblock Assembly	SBCA451TE1175	\$ 5500.00	\$ 1000.00
1175 Late, 1270 - w/ 451 6 Cylinder Diesel	Reman Shortblock Assembly	SBCA451TL1175	\$ 5500.00	\$ 1000.00

Case®—Tractor

Case®—Tractor

Application	Description	Part Number	Retail Price	Core
1370 Early, 2470 - w/ 504BDT 6 Cylinder Diesel	Reman Shortblock Assembly	SBCA504TE1370	\$ 5950.00	\$ 1000.00
1370 Late, 2390, 2394, 2470, 2590, 2594, 4490 - w/ 504BDT 6 Cylinder Diesel	Reman Shortblock Assembly	SBCA504TL1370	\$ 5950.00	\$ 1000.00
2090, 2094 - w/ 504BD 6 Cylinder Diesel	Reman Shortblock Assembly	SBCA5042090	\$ 5950.00	\$ 1250.00
2290, 2294 - w/ 504BD 6 Cylinder Diesel	Reman Shortblock Assembly	SBCA504T2290	\$ 5950.00	\$ 1250.00
2670, 4690, 4694 - w/ 504BT 6 Cylinder Diesel	Reman Shortblock Assembly	SBCA504T4690	\$ 5950.00	\$ 1000.00



Overhaul Kits

Application	Description		Retail Price	Core
870 w/ Reworked Counterbore, Ind/Const: 780CK w/o Turbo, W14 Engine BSN 2571281	A336BD Engine - Diesel	Inframe Kit	\$ 1563.00	
		Overhaul Kit	\$ 1515.00	
930 Draft-o-Matic ASN 8258382	A401D Engine - Diesel	Inframe Kit	\$ 1356.00	
		Overhaul Kit	\$ 1429.00	
970, Ind/Const: 1150 ASN 7110299, W8E, W9E, W10E, W18, W20, W20B	A401BD and A401BDT Engine - Diesel	Inframe Kit	\$ 1238.00	
		Overhaul Kit	\$ 1501.00	
1030	A451D and A451DT Engine - Diesel	Inframe Kit	\$ 1356.00	
		Overhaul Kit	\$ 1515.00	
1090	A451BD and A451BDT Engine - Diesel	Inframe Kit	\$ 1370.00	
		Overhaul Kit	\$ 1490.00	
1170, 1270 BSN 8766001	A451BDT Engine - Diesel	Inframe Kit	\$ 1356.00	
		Overhaul Kit	\$ 1434.00	
2290, 2294	A504BD Engine - Diesel	Inframe Kit	\$ 1572.00	
		Overhaul Kit	\$ 1763.00	
1370, 1470, 1570, 2390 Engine BSN 10339531, 2470, 2590 Engine BSN 10338579, 4490 Engine BSN 10338517, Ind/Const: 1450, (1450B, 1455B Engine BSN 10335337)	A504BDT Engine - Diesel	Inframe Kit	\$ 1335.00	
		Overhaul Kit	\$ 1194.00	
2670, 4690, 4694, Ind/Const: W36	A504BDTI Engine - Diesel	Inframe Kit	\$ 1922.00	
		Overhaul Kit	\$ 1971.00	
780*, (880A*, 880B* ASN 530000), 885, Ind/Const: 380CK *David Brown® Selectamatic Models	AD3/55 Engine - Diesel	Inframe Kit	\$ 438.00	
		Overhaul Kit	\$ 481.00	
995, 996, 1200 David Brown®, 1210, 1212, 1290 w/ Independent Clutch ASN 11052359, 1294, 1390, Ind/Const: 580G	AD4/55 Engine - Diesel	Inframe Kit	\$ 548.00	
		Overhaul Kit	\$ 595.00	
1394	AD4/55T Engine - Diesel	Inframe Kit	\$ 500.00	
		Overhaul Kit	\$ 521.00	
990 SN 467871-800000	AD4/47 Engine - Diesel	Inframe Kit	\$ 874.00	
		Overhaul Kit	\$ 947.00	
990 Case® ASN 850000 or David Brown® SN 800001-850000, 1290 w/ Continuous Clutch BSN 11052410	AD4/49 Engine - Diesel	Inframe Kit	\$ 559.00	
		Overhaul Kit	\$ 607.00	

Case®—Tractor

Application	Description		Retail Price	Core
1896	5.9T Engine - Diesel	Inframe Kit	\$ 521.00	
		Overhaul Kit	\$ 626.00	
2096	5.9TA Engine - Diesel	Inframe Kit	\$ 526.00	
		Overhaul Kit	\$ 602.00	



Crankshafts

Application	Description	Part Number	Retail Price	Core
430, 440, 441, 470, 480, 504, 530, 570, 630, 640 Replaces 976321, A39151, G11740, G11741	Crankshaft 188 4 Cylinder Diesel Engine 4.125" Stroke, 3.811" - 3.812" Bore, 2.0605" - 2.0615" Rod, 2.873" - 2.874" Main Flange - No Centering Ring, 4 Bolt Holes, Splined, Pilot Hole has 13 Splines Snout - Threaded, 2 Keyways	AMA151015	\$ 575.00	
430, 440, 441, 470, 480, 504, 530, 570, 630, 640, Ind: 580, 580B Replaces A39151, A76321, A151015, G11740, G11741	Crankshaft 188 4 Cylinder Engine 4.125" Stroke, (Diesel) 3.811" - 3.812", (Gas) 3.813" - 3.8145" Bore, - 2.0605" - 2.0615" Rod, 2.873" - 2.874" Main Flange - No Centering, Flat, 4 Bolt Holes, w/ Bushing Snout - Threaded, 2 Keyways This Crankshaft is not Splined in Pilot Hole	AMA39150	\$ 575.00	
990 Late Replaces 5321N	Crankshaft 195 CID 3.0 Liter 4 Cylinder, AD4/49 Engines 4" Stroke, 3.940" Bore, 2.373" Rod, 2.499" Main Flange - No Centering Ring, Flat, 4 Unthreaded Bolt Holes, 1 Dowel Hole, w/ Rope Seal Snout - Splined, Keyed and Threaded	AMD917985	\$ 432.00	
990 Early, 995, 996, 1200, 1210, 1212, 1390, 1410, 1412 Replaces 666000, 908453, 917935, 961007, K179935, K905196	Crankshaft 219 Small Mains 219 CID 3.6 Liter 4 Cylinder Engine and AD4/55 Engine 4.500" Stroke, 3.9388" - 3.9396" Bore, 2.373" - 2.3735" Rod, 2.499" - 2.4995" Main Flange - No Centering Ring, Flat, 4 Unthreaded Bolt Holes, 1 Dowel Hole, Rope Seal Snout - Splined, Keyed and Threaded	AMK961007	\$ 450.00	
1410, 1490, 1494 Replaces 5317N, 43322, D928, K928416	Crankshaft 219 Large Mains 219 CID 3.6 Liter 4 Cylinder Engine and AD4/55 Engine 4.500" Stroke, 3.9388" - 3.9396" Bore, 2.498" - 2.4985" Rod, 2.624" - 2.6245" Main Flange - No Centering Ring, Flat, 4 Unthreaded Bolt Holes, 1 Dowel Hole, Rope Seal Snout - Splined, Keyed and Threaded	AMK928415	\$ 480.00	
1896, 2096 Replaces 3929037, 3907604, 3908032	Crankshaft 6-590 Consolidated Diesel, 6B, 6BT, 6BTA - 5.9 Liter Externally Balanced Cummins® Engines 4.724" Stroke, 4.0157" - 4.0173" Bore, 2.716" - 2.717" Rod, 3.2672" - 3.2682" Main Flange - Flat, No Centering Ring, 8 Bolt Holes Snout - Straight, 4 Bolt Holes, No Keyways, No Splines	AM3907804	\$ 650.00	
2870, 4890, 4894	Crankshaft 674 674 CID 11.0 Liter 6 Cylinder Scania® Diesel Engine 5.709" Stroke, 5" - 5.001" Bore, 3.3162" - 3.3171" Rod, 3.9999" - 4.0008" Main Flange - No Centering Ring, Flat, 8 Bolt Holes, 3 Dowel Holes Snout - 1 Bolt Hole, 1 Keyway	AMA46616	\$ 2075.00	

Case®—Tractor

Connecting Rods

All connecting rods are cleaned and inspected for defects prior to remanufacturing. Rods are then shot-peened for stress relief and the size is checked against OEM specifications. New piston pin bushings are installed in each rod and bored to the correct center-to-center dimensions. The center-to-center dimension greatly affects the performance of your engine and is a step that many remanufacturers ignore. Final assembly of our connecting rods include installation of new rod bolts and verifying product dimensions, including bend and twist, one final time.



Application	Description	Part Number	Retail Price	Core
830, 1030 - w/ Diesel Engine	Reman Connecting Rod Cast # - A24425	AMCRA24425-R	\$ 127.00	\$ 40.00
930	Reman Connecting Rod	AMCRA27845-R	\$ 125.00	\$ 40.00
970, 1070	Reman Connecting Rod Cast # - A58789	AMCRA58789-R	\$ 165.00	\$ 40.00
1175, 1270, 2090, 2290	Reman Connecting Rod Cast # - A62954	AMCRA62954-R	\$ 205.00	\$ 60.00
1370, 1470, 1570, 2390, 2470, 2670, 4490, 4690	Reman Connecting Rod Cast # - A65032-R	AMCRA65032-R	\$ 165.00	\$ 60.00

Camshafts and Lifters



Application	Description	Part Number	Retail Price	Core
188 or 207 Case® Engine	Camshaft	AMA153521	\$ 165.00	
	Lifter	AMG47077	\$ 7.00	
401 or 504 Engine	Camshaft - Long Nose	AMA66743	\$ 295.00	
	Camshaft - Short Nose	AMA66124	\$ 285.00	
1370, 1470, 1570, 2090, 2390, 2470, 2590, 2670, 4490, 4690 - w/ 504 Engine				
1370, 2090, 2094, 2390, 2394, 2470, 2590, 2594, 2670, 4490, 4690, 4694 - w/ 401, 451 and 504 Case® Engines	Lifter	AMA182179	\$ 13.59	

Cylinder Heads

Our remanufactured cylinder heads are cleaned, pressure-tested and resurfaced. New seats and guides are installed using OEM specifications. These heads are ready for final assembly.



Application	Description	Part Number	Retail Price	Core
1370, 2470 - w/ 504 Engine	Reman Cylinder Head, Bare Pencil Injectors Not Included Cast # - A60558, A60559, A66194	AMCHCS504-1B	\$ 500.00	\$ 100.00
1570, 2090, 2094, 2290, 2294, 2390, 2394, 2590, 2594, 2670, 3294, 4490, 4494, 4690, 4694	Reman Cylinder Head w/ Valves Cast # - A67351, A138261, A138337, A152437, A156738	AMCHCS504-2WV	\$ 675.00	\$ 125.00

Oil Pumps, Engine

All of our remanufactured engine oil pumps are disassembled, thoroughly cleaned and inspected. All worn parts are replaced and tolerances are checked to guarantee our oil pumps will perform to OEM specifications. The pump is reassembled and - as a safety measure - each pump is lubricated with Clevite Bearing Guard to ensure there is no damage during initial start up. Replacing the engine oil pump during an overhaul is a step many people overlook.



Application	Description	Part Number	Retail Price	Core
(430, 530 SN 8297801-8650135), (470, 570 ASN 8656925) - w/ 188 Diesel Engine	Engine Oil Pump	AMA38372	\$ 265.00	
930, 1030	Reman Engine Oil Pump	AMA61810-R	\$ 525.00	\$ 100.00
970, 1070, 1170, 1175, 1270, 1370	Reman Engine Oil Pump 1 Gear Style Pump - Narrow Gear	AMA153000R	\$ 715.00	\$ 50.00
1270 ASN 8736001, 1370 ASN 8727601, 1570, 2390, 2394, 2470 ASN 876294, 2590, 2594, 2670, 3294, 3394, 3594, 4490, 4494, 4690, 4694, Crawlers: 40D ASN 6270716, 40E ASN 6271140, 50E ASN 6280543, 1080, 1080B, 1187, 1187B, 1280, 1280B, 1450B, 1455B, Loaders: W30, W36 BSN 17754000	Engine Oil Pump 2 Gear Style Pump	AMA152998	\$ 608.50	

Case®—Tractor

Application	Description	Part Number	Retail Price	Core
1270, 1370, 1570, 2390, 2394, 2470, 2590, 2594, 2670, 4490, 4494, 4690, 4694	Reman Engine Oil Pump 2 Gear Style Pump	AMA152998R	\$ 655.00	\$ 50.00
2090, 2094, 2290, 2294, 2390, 2394, 2590, 2594, 3394, 3594	Reman Engine Oil Pump 1 Gear Style Pump - Wide Gear Cast # - 968329	AMA153805R	\$ 630.00	\$ 50.00
Crawler: 1850K, Excavator: CX330, Wheel Loader: 821C	Engine Oil Pump Replaces 3948072, 87775216, J942723	AMJ948072	\$ 235.00	
1896, 2096	Engine Oil Pan Replaces J901288	AMJ915703	\$ 240.00	
1896 BSN 17895000 w/ 5.9 Cummins® Engine	Oil Pump Pickup Tube Replaces J934942	AMJ909373	\$ 140.00	
1270 ASN 8736000, 1370 ASN 8727600, 1570, 2390, 2394, 2470, 2594, 2670, 2690, 3294, 3394, 3594, 4490, 4494, 4690, 4694	Pressure Relief Valve	AMA75286	\$ 90.00	



Radiators

Application	Description	Part Number	Retail Price	Core
Ind: 430CK, 480B, 480CK, 530CK, 580CK, 580B - w/ Gas or Diesel	Radiator Overall: 19" x 26" Core: 18 5/16" x 17 5/8" x 2 1/8" 3 Rows, 8 Fins per Inch Replaces A35604	AMA39344	\$ 345.00	
Ind: 480C	Radiator Overall: 18 3/4" x 25 7/8" Core: 18 1/4" x 17 5/8" x 1 3/4" 3 Rows, 9 Fins per Inch	AMD89104	\$ 382.00	
530C Diesel, 580B, 580C	Radiator Overall: 18 3/4" x 26" Core: 18 1/4" x 17 3/4" x 1 7/8" 3 Rows, 8 Fins per Inch	AMD89103	\$ 291.00	
930, 930CK	Radiator	AMA33459	\$ 680.00	
970, 1070, 1175, 1270, 1370	Radiator Overall: 23 1/2" x 31 1/2" Core: 22 1/2" x 23 3/4" x 3 1/8" 5 Rows, 9 Fins per Inch Replaces A62852, A64484	AMA66330	\$ 805.00	
1030 - w/o Oil Cooler	Radiator Core: 18.00" x 25 3/4" x 3 3/8" 6 Rows, 8 Fins per Inch	AMA60171	\$ 830.00	
1896, 2096	Radiator Replaces A171652	AMA171653	\$ 400.00	
2090*, 2094, 2290*, 2294 *A166776 Radiator Cap Required	Radiator Overall: 23 1/4" x 30 5/8" Core: 22 1/4" x 23 3/4" x 3 3/8" 6 Rows, 8 Fins per Inch	AMA165922	\$ 695.00	
2390, 2394, 2590, 2594, 3394, 3594	Radiator Overall: 28 1/2" x 35 1/4" Core: 27 1/2" x 26 1/2" x 3 1/2" 5 Rows, 8 Fins per Inch Replaces A147140	AMA184365	\$ 1110.00	
4890, 4894	Radiator Overall: 32" x 41 1/2" Core: 29 1/8" x 32 1/4" x 3 3/4" 6 Rows, 9 Fins per Inch	AMA166304	\$ 1875.00	

Case®—Tractor

Application	Description	Part Number	Retail Price	Core
1896, 2096. Ind/Const: 480E, 480ELL, 480F, 550, 550E, 550G, 570LXT, 580K, 580L, 580SE, 584E, 586E, 590, 621, 650G, 680K, 680L, 721, 760, 780C, 780D, 821, 1085B, 1085C, 1086B, 1150E, 1150G, 1155E, 1187, 1550, W11B, W14B, W14C	Radiator Cap 16 PSI, Fits 3/4" Deep Neck, w/ Drop-Type Vacuum Valve Replaces 87774949, A171919, L302981	AMA170241	\$ 5.50	



Radiator Hoses

Application	Description	Part Number	Retail Price	Core
730, 830 - Gas or Diesel	Radiator Hose, Upper 6.375" Long, 2.50" ID	AMA24293	\$ 16.89	
770, 870 - Gas	Radiator Hose, Upper 2.50" ID	AMA59864	\$ 21.08	
970, 1070, 1090, 1170, 1175, 1570	Radiator Hose, Upper 2.53" ID	AMA59887	\$ 29.39	
990, 995, 996, 1200 ASN 705365, 1210, 1212	Radiator Hose, Upper 1.50" ID	AMK921972	\$ 14.08	
1030	Radiator Hose, Upper 2.50" ID	AMA60169	\$ 24.15	
1190, 1194, 1290, 1294, 1390, 1394, David Brown®: 770 Selectamatic, 780, 880, 885 Synchronomatic	Radiator Hose, Upper 1.50" ID Replaces 825656M1, 828147M1, K37575	AMK200730	\$ 14.46	
1200 SN 700001-705364	Radiator Hose, Upper 1.50" ID Replaces 83905554, D5NN8260CV, K916316	AMD5NN8260C	\$ 12.66	
1270, 1370	Radiator Hose, Upper 2.50" ID	AMA63727	\$ 39.24	
1410, 1412	Radiator Hose, Upper 1.50" ID	AMK946849	\$ 26.01	
1490, 1494	Radiator Hose, Upper 1.50" & 1.94" ID	AMK201747	\$ 17.96	
1594, 1690, 1694	Radiator Hose, Upper 1.94" ID	AMK201718	\$ 22.15	
2090, 2094, 2290, 2294	Radiator Hose, Upper 2.50" & 2.625" ID	AMA143930	\$ 26.00	
2390, 2394, 2590, 2594, 3294, 3394, 3594	Radiator Hose, Upper 2.50" ID Replaces A166381	AMA141495	\$ 28.00	
Ind: 480FLL, Backhoe-Loaders: 480E, 480ELL, 480F, 580E, Forklifts: (584E, 585E, 586E ASN JYG0251722)	Radiator Hose, Upper	AMA170431	\$ 21.25	
(700, 800 - Gas), (730, 830 - Gas or Diesel)	Radiator Hose, Lower 2" ID	AMA20384	\$ 20.07	
770 Selectamatic w/ 50 mm Radiator Block, 780	Radiator Hose, Lower 1.90" ID	AMK912034	\$ 27.34	
770 Selectamatic w/ 80 mm Radiator Block, 780 ASN 603212, 880 ASN 550032 w/ MFWD, 885 Synchronomatic	Radiator Hose, Lower 1.50" ID	AMK915206	\$ 17.88	
(770, 870, 970 ASN 8675000 - Gas or Diesel), 1070 ASN 8675000 Diesel	Radiator Hose, Lower 2.25" ID	AMA59865	\$ 23.50	
930, 930CK, 940 - Gas or Diesel	Radiator Hose, Lower 2.25" ID	AMA34079	\$ 33.47	
970 Gas or Diesel 1070 ASN 8675001	Radiator Hose, Lower 2.25" & 2.625" ID	AMA62649	\$ 19.97	
990 BSN 866384, 995 ASN 943287, 996 BSN 98778, 1200, 1210 ASN 729733, 1212 ASN 1004296	Radiator Hose, Lower 1.50" ID	AMK926603	\$ 16.72	
990 ASN 866385, 995 ASN 943288, 996 ASN 98779, 1210 BSN 729732, 1212 BSN 1004295	Radiator Hose, Lower 1.50" ID	AMK948453	\$ 23.52	

Case®—Tractor

Application	Description	Part Number	Retail Price	Core
1030	Radiator Hose, Lower 2" & 2.375" ID	AMA57353	\$ 30.75	
1090, 1170, 1175	Radiator Hose, Lower 2.625" ID	AMA61931	\$ 20.92	
1190, 1194	Radiator Hose, Lower 1.50" ID	AMK200874	\$ 25.35	
1594, 1690, 1694	Radiator Hose, Lower 1.50" ID	AMK203619	\$ 27.28	
1290, 1294, 1390, 1394	Radiator Hose, Lower 1.50" ID	AMK201976	\$ 29.26	
1410, 1412	Radiator Hose, Lower 1.50" ID	AMK945287	\$ 24.82	
1490, 1494	Radiator Hose, Lower 1.50" ID	AMK203350	\$ 20.26	
1270, 1370, 1570	Radiator Hose, Lower 2.625" ID	AMA145619	\$ 35.77	
1896, 2096	Radiator Hose, Lower 2.25" ID	AMA169930	\$ 16.59	
2090, 2094, 2290, 2294	Radiator Hose, Lower 2.625" ID	AMA143931	\$ 28.00	
2390, 2394, 2590, 2594, 3294, 3394, 3594	Radiator Hose, Lower 2.625" ID	AMA141496	\$ 18.00	
David Brown®: 880 BSN 550031	Radiator Hose, Lower 1.50" ID	AMK912039	\$ 33.55	



Flywheels and Components

Application	Description	Part Number	Retail Price	Core
2090, 2094, 2290, 2294, 2390, 2394, 2470, 2590, 2594, 2670, 3294, 4490, 4494, 4690, 4694	Flywheel Fits Tractors w/ 12 Speed Transmissions Can replace A66613 if (6) A58629 Washers are purchased from the OEM	AMA153946	\$ 450.00	
730, 830, 930CK, 930DOM, 1030, 1200, 1200TK, 1470, 1896, 2090, 2094, 2096, 2290, 2294, 2390, 2394, 2470, 2590, 2594, 2670, 3294, 3394, 3594, 4490, 4494, 4690, 4694	Flywheel Ring Gear	AMA27920	\$ 125.47	

Water Pumps

The remanufactured water pumps we supply have an extra step added to the remanufacturing process to ensure quality. Since the bearing and seal assembly are critical in performance, we ensure air-tight seals by vacuum testing our water pumps prior to packaging. This guarantees no leakage will occur after your water pump has been installed.



Application	Description	Part Number	Retail Price	Core
200, 200B, 210, 300, 300B, 311, 320B, 400B, 420, 420B, 420C, 430, 431, 480B, 480C, 480CK, 500B, 530, 580B, 580CK, 600, 600B, 660, VA, VAC - w/ Gas	Water Pump	AMA148401	\$ 68.50	
400, 700, 800 - w/ Gas or Diesel	Reman Water Pump Short shaft 1 13/16" above bearing Cast # - A11495, A23305, 6456A	AMA153927	\$ 130.00	\$ 25.00
(430, 530 w/ 188 Diesel Engine), (470, 570 w/ Gas or Diesel), 630 Diesel	Water Pump	AMA146584	\$ 48.00	
480E, 480ELL, 480F, 480FLL, 570LLT, 580E - w/ 4-390, 4T-3T390, 4TA390, 6-590, 6T590, 6TA590, 1896 and 2096 Engines	Water Pump	AMJ802970	\$ 55.13	

Case®—Tractor

Application	Description	Part Number	Retail Price	Core
730, 830 - w/ Gas or Diesel	Reman Water Pump Long shaft 2.50" above bearing	AMA153454	\$ 130.00	\$ 30.00
770, 870, 970, 1070 - w/ Gas or Diesel	Reman Water Pump	AMA152179	\$ 95.00	\$ 25.00
770, 880	Water Pump	AMK952713	\$ 146.00	
(930, 940 w/ Gas or Diesel), 1200	Reman Water Pump	AMA24809	\$ 145.00	\$ 30.00
990, 995, 1210, 1212	Water Pump	AMK915842	\$ 67.00	
990, 1210, 1212, 1410, 1412	Water Pump	AMK200679	\$ 77.00	
1030 Diesel	Reman Water Pump	AMA34009	\$ 136.00	\$ 30.00
1090, 1170, 1175, 1270, 1370, 1570, 2470 - Diesel	Reman Water Pump	AMA152154	\$ 84.50	\$ 25.00
1290, 1294, 1390, 1394, 1494	Water Pump Replaces Cast # - K201749	AMK201750	\$ 110.00	
1470*, 1570 ASN 10013839, 2090* (Large Impeller), 2290* (Large Impeller), 2294, 2390*, 2394, 2590*, 2594, 3294, 3594, 4490, 4494 *Water pumps with keyed shaft require capscrew and spacer kit A114A15	Water Pump 4.50" Diameter Impeller Replaces Cast # - A58642	AMA157145	\$ 89.00	
1490	Water Pump Includes Mounting Gasket Replaces K201815	AMK262856	\$ 140.00	
1594, 1690	Water Pump	AMK200759	\$ 73.25	
2670*, 4690, 4694 - w/ Diesel *BSN 10020824 models require capscrew and A114A15 spacer kit	Reman Water Pump Replaces Cast # - A58642	AMA157146	\$ 140.00	\$ 25.00
4890 (w/ 3-Bolt Cooler Tube Attachment), 4894	Reman Water Pump Stamped # - 353296 Replaces Cast # - 290865	AMA70690	\$ 310.00	\$ 75.00
4890 Diesel (w/ 2-Bolt Cooler Tube Attachment)	Reman Water Pump Stamped # - 353297 Replaces Cast # - 358233	AMA70862	\$ 310.00	\$ 75.00
David Brown®: 990 BSN 866384, 995 BSN 943287, 996 BSN 987778, 1200 Selectamatic, 1210 BSN 729733, 1212 BSN 1004296	Water Pump Single Groove Pulley Marked C915326 or K915326 Includes Mounting Gasket Replaces K915842	AMAK952127	\$ 115.00	
2096	Belt Tensioner	AM87326910	\$ 50.00	
1896 ASN 17895000, 2096 SN 17897500-17897505 and ASN 17897509	Thermostat Housing Replaces J903756	AMJ914409	\$ 57.00	

Belts

Application	Description	Part Number	Retail Price	Core
1070 BSN 8639001	Fan Belt, Water Pump Belt	AMA65143	\$ 61.00	
	A/C Compressor Belt	AMA65692	\$ 45.00	
1070 ASN 8639001, 1170 ASN 8686964, 1175 ASN 8686964, 1370	Fan Belt, Water Pump Belt	AMA65143	\$ 61.00	
	A/C Compressor Belt	AMA65717	\$ 20.00	
1394, 1494 - w/o A/C	Fan Belt, Alt / Gen Belt, Water Pump Belt	AMK68073	\$ 9.35	
1394, 1494 - w/ A/C	Fan Belt, Alt / Gen Belt, Water Pump Belt	AMK308448	\$ 11.40	
1394 w/ A/C	A/C Compressor Belt	AMK307429	\$ 9.83	
1470	Fan Belt, Water Pump Belt	AMT38546	\$ 35.63	
1570	Fan Belt, Water Pump Belt	AMA65143	\$ 61.00	
	A/C Compressor Belt	AMA65717	\$ 20.00	
1896	Fan Belt, Water Pump Belt	AMJ911570	\$ 46.00	
	A/C Compressor Belt	AMA169970	\$ 13.25	
2090, 2094, 2290, 2294, 2390, 2394 - w/o A/C	Fan Belt, Water Pump Belt	AMA57130	\$ 20.50	
2090, 2094, 2290, 2294, 2390, 2394 - w/ A/C	Fan Belt, Water Pump Belt	AMA145325	\$ 28.83	
	A/C Compressor Belt	AMA9628	\$ 12.00	

Case®—Tractor

Application	Description	Part Number	Retail Price	Core
2470 BSN 8762940	Fan Belt, Water Pump Belt	AMA61048	\$ 41.00	
	A/C Compressor Belt	AMA75577	\$ 13.10	
2470 ASN 8762940	Fan Belt, Water Pump Belt	AMA61048	\$ 41.00	
2590, 2594 - w/ A/C	Fan Belt, Water Pump Belt	AMA145325	\$ 28.83	
	A/C Compressor Belt	AMA9628	\$ 12.00	
2590, 2594 - w/o A/C	Fan Belt, Water Pump Belt	AMA57130	\$ 20.50	

Carburetors

Application	Description	Part Number	Retail Price	Core
530, 540, 600, 630, 640	Carburetor	AMX82007	\$ 550.00	

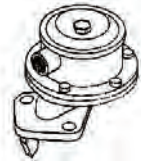

Fuel Lift Pumps

Application	Description	Part Number	Retail Price	Core
770A, 770B, 780, (880A, 880B SN 530001-563379), 885 SN 885N1646001-885N1647360, 1190 ASN 11030001, 1190E, 1194	Fuel Lift Pump Replaces K908819	AMK311938	\$ 30.00	
990, 995, 1210, 1212, 1290, 1390, 1394, 1410, 1412, 1494, 1594, 1690	Fuel Lift Pump w/ Glass Bowl Replaces K944997	AMK311939	\$ 32.00	
1896, 2096, Ind: 760, 860, Backhoe-Loaders: 480E, 480F, 580 Super E, 580 Super K, 580 Super L, 580K, 580L, 584E, 585E, 586E, 590 Super L, 680K, 680L, 688, 780C, 780D, Excavators: 880D, 1085B, 9010, 9020, 9030, 9030B, Loaders: 621, 621B, 855D, 855E, 1155E	Fuel Lift Pump Replaces 3904374, J904374	AMJ928143	\$ 28.50	
1896, 2096, Ind/Const: 455C, 480E, 480ELL, 480F, 480FLL, 550, 550E, 550G, 570LXT, 580K, 580L, 580SE, 580SK, 580SL, 584E, 585E, 586E, 590SL, 650G, 660, 686G, 686GXR, 688, 760, 860, 9010, 9010B, 9020, 9020B, W11B	Fuel Primer Pump Replaces 3914319	AM3918000	\$ 62.50	
Ind/Const: 121E, 221E, 321E, 521D, 580M, 580N, 580SM, 580SN, 590SM, 590SN, 621D ASN JEE0135501, TX742, TX842, TX945, TX1055	Fuel Lift Pump Replaces 84268475, 84269570, 504146090	AM2830266	\$ 36.00	

Injection Pumps

All of our injection pumps are disassembled, thoroughly cleaned and inspected. All worn out parts are replaced and the pumps are reassembled with new gaskets. Pumps are tested for leaks and fuel delivery at low idle, high idle, full load, part load and at start up. Any pumps with an automatic advance system has the advance set. As an additional quality check, all pumps are tested with a special oil that will not varnish inside the pump.

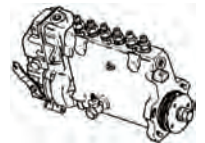

Application	Description	Part Number	Retail Price	Core
930	Reman Injection Pump Bosch, Mfg # - PES6A 80C 420 LS2054	AMP930-PES	\$ 1350.00	\$ 200.00
870	Reman Injection Pump Bosch, Mfg # - PES4A 85C 420 LS2263	AMP870-PES	\$ 1350.00	\$ 200.00
970, 1070	Reman Injection Pump Bosch, Mfg # - PES6A 85C 420 LS2264	AMP1070-PES	\$ 1425.00	\$ 200.00
1170	Reman Injection Pump Bosch, Mfg # - PES6A 90D 420 LS2354	AMP1170-PES	\$ 1425.00	\$ 200.00
1175	Reman Injection Pump Bosch, Mfg # - PES6A 90D 420 LS2461	AMP1175-PES	\$ 1425.00	\$ 200.00
1270	Reman Injection Pump Bosch, Mfg # - PES6A 90D 420 LS2354	AMP1270-PES	\$ 1425.00	\$ 200.00
1370	Reman Injection Pump Bosch, Mfg # - PES6A 95D 420 LS3007/3024	AMP1370-PES	\$ 1425.00	\$ 200.00

Case®—Tractor

Application	Description	Part Number	Retail Price	Core
1470	Reman Injection Pump Bosch, Mfg # - PES6A 95C 420 LS3007	AMP1470-PES	\$ 1425.00	\$ 200.00
1570	Reman Injection Pump Bosch, Mfg # - PES6A 100D 420 LS3024	AMP1570-PES	\$ 1425.00	\$ 200.00
2090	Reman Injection Pump Bosch, Mfg # - PES6A 95D 420 LS2551	AMP2090-PES	\$ 1425.00	\$ 200.00
2096	Reman Injection Pump Bosch, Mfg # - 0460426058	AMP2096-VER	\$ 1075.00	\$ 200.00
2290	Reman Injection Pump Bosch, Mfg # - PES6A 95D 420 LS2551	AMP2290-PES	\$ 1425.00	\$ 200.00
2390	Reman Injection Pump Bosch, Mfg # - PES6A 100D 720 RS3024	AMP2390-PES	\$ 1425.00	\$ 200.00
2470	Reman Injection Pump Bosch, Mfg # - PES6A 95D 420 LS3007/3024	AMP2470-PES	\$ 1425.00	\$ 200.00
2590	Reman Injection Pump Bosch, Mfg # - PES6A 100D 420 LS3024	AMP2590-PES	\$ 1425.00	\$ 200.00
2670	Reman Injection Pump Bosch, Mfg # - PES6A 100D 420 LS3007/3024	AMP2670-PES	\$ 1425.00	\$ 200.00
2870	Reman Injection Pump Bosch, Mfg # - PES6A 110A 720 RS3014	AMP2870-PES	\$ 1750.00	\$ 200.00
4490	Reman Injection Pump Bosch, Mfg # - PES6A 95D 320 LS2647	AMP4490-PES	\$ 1425.00	\$ 200.00
4690	Reman Injection Pump Bosch, Mfg # - PES6A 100D 420 LS3024	AMP4690-PES	\$ 1425.00	\$ 200.00
4890	Reman Injection Pump Bosch, Mfg # - PE6P 110A 720 RS	AMP4890-PES	\$ 1875.00	\$ 300.00
2090, 2290, 2390, 2590	Stop Control Cable	AMA143982	\$ 80.73	

Injectors

Our remanufactured injectors are disassembled and thoroughly cleaned. The internal components are lapped to ensure there is no leakage. All tips are inspected for hole erosion and opening pressure; and the spray pattern is tested using OEM specifications.



Application	Description	Part Number	Retail Price	Core
770, 870, 970, 1070, 1175, 1270, 1370, 1470, 2470	Injector Pencil # - 18084, 19745, 20345, 20349, 20668, 20670, 20672	AMA138323	\$ 45.00	
430, 470, 530, 570, Combine: 660, Swathers: 1150, 1255	Injector Pencil # - 20671	AMA140829	\$ 40.00	
830, 930, 1030	Reman Injector Holder # - KB80SA-390/4 Valve # - DNOSD137	NKB-SD137	\$ 85.00	\$ 20.00
2090	Reman Injector Holder # - AKD98M6562A Valve # - ADB150M187-7	NAKD-M187-7	\$ 50.00	\$ 20.00
2290	Reman Injector Holder # - AKD98M6562A Valve # - ADB150M211-7	NAKD-M211-7	\$ 50.00	\$ 20.00
2390, 2590, 4490	Reman Injector Holder # - AKD98M6562A Valve # - ADB150M195-7	NAKD-M195-7	\$ 50.00	\$ 20.00
2390, 2590, 4490	Reman Injector w/ New Tip Holder # - AKD98M6562A Valve # - ADB150M195-7	NAKD-M195-7RC	\$ 120.00	\$ 20.00
2670, 4690	Reman Injector Holder # - AKD98M6562A Valve # - ADB150M176-7	NAKD-M176-7	\$ 45.00	\$ 35.00

Case®—Tractor

Application	Description	Part Number	Retail Price	Core
2670, 4690	Reman Injector w/ New Tip Holder # - AKD98M6562A Valve # - ADB150M176-7	NAKD-M176-7RC	\$ 85.00	\$ 20.00



Turbochargers

Application	Description	Part Number	Retail Price	Core
1170, 1175, 1270 Replaces A43361	Turbocharger T04B37, AiResearch 3" OD on Intake	AM465260	\$ 535.00	
1370, 1470, 1570, 2290, 2294, 2394, 2470, 2590, 2594, 2670, 3294, 3594, 4490, 4494, 4690, 4694 Replaces A60104, A76341, A157336	Turbocharger T04B19, AiResearch	AM409640-4	\$ 365.00	
1170, 1175, 1270, 1370, 1470, 1570, 2470, 2670	Exhaust Sleeve Sealing rings not included	AMA65554	\$ 70.00	



Manifolds and Components

Application	Description	Part Number	Retail Price	Core
430, 470, 530, 570, 630, Ind/Const: 310E, 310F, 310G, 350, 350B, 420C, 450, 480, 480B, 480C, 480D, 480LL, 580B, 580C, 580D, 584, 584C, 585C, 585D, 586C, 586D - w/ 188 or 207 Diesel Engine	Exhaust Manifold Plates or Hardware Not Included Replaces G2113, A39233, A-G2113	AMA182084	\$ 172.00	
730, 830 - w/ Gas	Exhaust Manifold	AMA20867	\$ 337.00	
1175, 1270, 1370, 1470, 1570, 2290, 2294, 2390, 2394, 2470, 2590, 2594, 2670, 3294, 3394, 3594, 4490, 4494, 4690, 4694	Exhaust Manifold - Center Section	AMA76322	\$ 105.00	
	Exhaust Manifold - End Section	AMA65917	\$ 65.00	
	Manifold Gasket Set Ref# 1342786C1	AMX36256	\$ 24.00	
1170, 1175, 1270, 1370	Exhaust Elbow	AMA61265	\$ 110.00	
1470, 1570	Exhaust Elbow	AMA61941	\$ 99.00	
2470	Exhaust Elbow	AMA76049	\$ 388.00	

Mufflers and Exhaust

Our mufflers are manufactured by experienced craftsmen here in the United States. All mufflers have welded seams. Aluminized steel is used for critical components. These features ensure that our products resist the corrosive effects of air, heat and the by-products of combustion that work to shorten muffler life. Additionally, they are painted either silver or black to cosmetically match its OEM counterpart, as well as provide further protection from the elements.

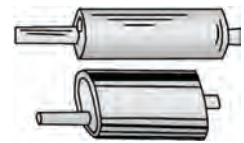

Application	Description	Part Number	Retail Price	Core
Universal Tractors	Exhaust Pipe Black Finish, Straight Pipe 4" ID, Overall Length 47.50"	AM400SP	\$ 59.00	
Universal Tractors	Exhaust Pipe Diameter 3.50", Length 48"	AMS312X48	\$ 57.00	
530, 630, 640, 641 - w/ Gas or Diesel 60-69	Muffler, Round Inlet 2 1/2", Length 29"	AMG45239	\$ 32.50	
730, 740, 830, 840 - w/ Gas or Diesel	Muffler, Round Inlet 2 1/2", Length 26"	AMA24314	\$ 33.00	
	Inlet Clamp	CL-212	\$ 7.00	
	Rain Cap	RC-3	\$ 14.50	

Case®—Tractor

Application	Description	Part Number	Retail Price	Core
(930, 940 - w/ Gas or Diesel), (930CK, 1030 - w/ Diesel)	Muffler, Round Inlet 2 3/4", Length 32"	AMA24103	\$ 55.00	
	Inlet Clamp	CL-234	\$ 11.00	
	Rain Cap	RC-7	\$ 14.50	
770, 780, 880, 885, 990, 995*, 996*, 1200*, 1210, 1212 *Requires B928257 Adaptor	Muffler, Oval Inlet 1 7/8", Length 34"	AMK928712	\$ 57.50	
	Inlet Clamp	CL-178	\$ 4.00	
	Rain Cap	RC-2	\$ 13.00	
770, 870 - w/ Gas or Diesel	Muffler Vertical Round, Inlet 2 3/4", Length 44"	AMA59764	\$ 55.00	
	Inlet Clamp	CL-234	\$ 11.00	
	Rain Cap	RC-7	\$ 14.50	
970, 1070 - w/ Gas or Diesel	Muffler, Oval Inlet 2 3/4", Length 44"	AMA139865	\$ 93.50	
	Inlet Clamp	CL-234	\$ 11.00	
	Rain Cap	RC-7	\$ 14.50	
	Muffler, Round Inlet 2 3/4", Length 44"	AMA59765	\$ 61.50	
	Inlet Clamp	CL-234	\$ 11.00	
	Rain Cap	RC-7	\$ 14.50	
(1170, 1175, 1270 - w/ D451T Engine), 1370 w/ D504T Engine	Muffler, Round Inlet 3 1/2", Length 42"	AMA64990	\$ 66.00	
	Inlet Clamp	CL-312	\$ 6.50	
	Rain Cap	RC-8	\$ 16.50	
1270 ASN 8736000, 1370 ASN 8727000, 1570, 2470 BSN 8762940	Exhaust Pipe Length 20.50 Extension Pipe w/ Angled Outlet Use w/ AMA66780 or AMA13588	AMA76060	\$ 65.00	
	Clamp	CL-412	\$ 7.50	
1370 w/ Aspirator	Muffler, Oval Inlet 3 1/2", Length 27"	AMA66780	\$ 207.50	
	Inlet Clamp	CL-312	\$ 6.50	
	Rain Cap	RC-10	\$ 21.00	
1370	Muffler Eliminator 3 1/2" ID x 4" OD x 48" Tall Replaces A66199, A66780	AMKC1370ASP	\$ 161.00	
1570 w/ Aspirator	Muffler, Oval Inlet 3 1/2", Length 27"	AMA135881	\$ 207.50	
	Inlet Clamp	CL-312	\$ 6.50	
2290, 2294 - Units w/o Loader	Muffler, Oval Inlet 3 1/2", Length 31" (w/ Side Inlet)	AMA147065	\$ 230.00	
	Inlet Clamp	CL-312	\$ 6.50	
	Rain Cap	RC-10	\$ 21.00	
2090, 2094 - Non-Aspirated	Muffler, Oval Inlet 4-Hole Base Plate, Length 29 1/2"	AMA160176	\$ 253.00	
	Inlet Clamp	CL-212	\$ 7.00	
	Rain Cap	RC-3	\$ 14.50	
2090, 2094, 2290, 2294, 2390, 2394, 2590, 2594	Exhaust Pipe Extension Pipe w/ Angled Outlet Use w/ AMA147065 or AMA147100	AMA141777	\$ 87.00	
	Clamp	CL-412	\$ 7.50	
	2290, 2294	Exhaust Pipe Replaces A147064	AMA180997	\$ 145.00

Case®—Tractor

Application	Description	Part Number	Retail Price	Core
2390, 2394, 2590, 2594	Muffler, Oval Inlet 4", Length 31"	AMA147100	\$ 221.00	
	Clamp	CL-400	\$ 6.50	
	Rain Cap	RC-9	\$ 18.00	
2470	Muffler, Oval Inlet 4", Length 27" - w/ Side Aspirator	AMA147044	\$ 211.50	
	Inlet Clamp	CL-312	\$ 6.50	
	Rain Cap	RC-9	\$ 18.00	
2670	Muffler, Oval Inlet 4", Length 54" Muffler has a curved Aspirator 1 1/4" w/ 2 hole base plate	AMA147046	\$ 258.50	
	Clamp	CL-400	\$ 6.50	
4690, 4694	Muffler	AMA162464	\$ 287.00	
Ind/Const: 480B, 480C, 480D, 480LL, 580B, 580C, 580D, 580SD, 584D, 585D, 586D	Muffler Inlet 2.50", Length 33"	AMA39561	\$ 60.00	

Starters

All of our remanufactured starters are disassembled, cleaned and inspected. Almost all units receive new field coils. If it meets OEM specifications the armature is test turned and under cut, otherwise it is replaced with a quality factory remanufactured or new part. Starters with factory solenoids have the solenoids replaced with new parts. The drive is carefully inspected and if it does not meet specifications it is replaced with new or quality factory remanufactured drives.



Application	Description	Part Number	Retail Price	Core
Ind: 21E, 121E, 221E, 321E	Starter Bosch, 10 Tooth, 4kW, CW Rotation Bosch Mfg # - 504357110 Iskra Mfg # - IS1109	AM84151331	\$ 275.00	

Air Cleaner Components

Application	Description	Part Number	Retail Price	Core
970, 1070, 1090, 1170, 1175, 1270, 1370 Replaces A42467	Large Precleaner Bowl 10.50" Diameter	AMP01-6330	\$ 12.00	
David Brown®: 1200 Selectamatic ASN 705365	Air Cleaner Hose 1.50" ID	AMK921974	\$ 40.31	



Alternators

Application	Description	Part Number	Retail Price	Core
770, 870, 970, 1070, 1175, 1270, 1370, 1570, 2470	Alternator	AM213-4011	\$ 82.00	
1896, 2096	Alternator 105 Amps, Plug at 6 o'clock position, 3-Pin	AMA181766	\$ 143.50	
(1896, 2096 ASN 1789500)	Reman Alternator Bosch Type, 12 Volt, 65 Amps, IR/EF	AMRE533516	\$ 188.59	\$ 20.00
1896 ASN 17895000-002, 2096, Ind/Const: 650G, 650H, 650K, 750H, 750K, 850H, 850K, 1150H	Alternator Bosch, 12 Volt, 95 Amps, IR/EF, CW Rotation, w/o Pulley	AMA187623	\$ 105.00	
2094, 2294, 2394, 2594, 3294, 3394, 3594, 4494, 4694, 4894, 4994	Alternator 105 Amps	AMA163085	\$ 141.00	
Ind/Const: (570MXT, 586G - Series III), (580M, 580 Super M, 590 Super M - Series II and Series III)	Alternator 14 Volt, 60 Amps Replaces 84254289, 84416587, Denso 022119090	AM87422777	\$ 161.00	

Case®—Tractor

Sensors

Application	Description	Part Number	Retail Price	Core
2090, 2094, 2290, 2294, 2390, 2394, 2590, 2594, 2870, 3294, 4490, 4690, 4890	Temperature Sending Switch Replaces A166057, D65446	AM84300765	\$ 36.35	

Tie Rods and Components

Application	Description	Part Number	Retail Price	Core
 (730, 830, 930, 1030 ASN 8332878)	Tie Rod 16 Thread	AMA41520	\$ 33.00	
 (730, 830, 1030 ASN 8332877), 770, 870, 930 ASN 8339077, 970, 1070, 1090 ASN 8678073, 1170 BSN 8678074, 1175	Tie Rod Clamp	AMA41561	\$ 5.32	
 770, 870, 970, 1070, (1090, 1170 BSN 8678074), 1175	Tie Rod Assembly	AM112201	\$ 95.00	
 770, 870, 970, 1070, (1090, 1170 BSN 8678074), 1175	Tie Rod 17.25" Long, 0.937" Diameter, 8 Notches	AMA143028	\$ 30.00	
 770, 870, 970, 1070, (1090, 1170 BSN 8678074), 1175	Tie Rod 3.75" Long, 1" Diameter Right Hand Thread	AMA44762	\$ 20.00	
 770, 870, 970, 1070, (1090, 1170 BSN 8678074), 1175	Tie Rod Tube 18.375" Long	AMA59659	\$ 17.00	
 780, 850, 880, 885, 950, 990, 995, 996, 1190, 1194, 1200, 1210, 1212, 1290, 1294, 1390, 1394, 1490	Tie Rod End, Right and Left Hand 3.75" Long, 20 NF Right Hand Thread Replaces K252853	AMK908071	\$ 21.00	
 1090, 1170, 1270, 1370, 1570	Tie Rod 17.68" Long, 1" Diameter, 8 Holes	AMA43374	\$ 40.00	
 1090, 1170 ASN 8678074, 1270, 1370, 1570	Tie Rod 4" Long, 1" Diameter Right Hand Thread	AMA43376	\$ 22.00	
 1394, Ind: 480B, 480C, 480CK, 480D, 480LL, 530CK, 580B, 580C, 580CK, 580D, 580F, 584D, 584E, 584FL, 585D, 585E, 586D, 586E, Trenchers: 760, 860	Tie Rod End 2.19" Long, 0.687" Diameter 18 Right Hand Thread	AMA40962	\$ 14.00	
 1896, 2090, 2094, 2096, 2290, 2294, 2390, 2394, 2590, 2594	Tie Rod Tube 18.62" Long, 1.25" Diameter, 8 Holes	AMA143876	\$ 40.00	
 1896, 2090, 2094, 2096, 2294 - w/ Standard or Long Axles w/ Standard Wheel Base	Tie Rod 18.75" Long, 1.25" Diameter, 8 Holes	AMA160199	\$ 33.00	
 1896, 2090, 2094, 2096, 2290, 2294, 2390, 2394, 2590, 2594	Tie Rod Tube 37" Long, 1.26" ID	AMA149033	\$ 175.00	
 (1896, 2096 BSN 17895962), 2294, 3294, 3394, 3594 - w/ ZF MFWD Axle	Ball Joint 9" Overall Length M24x1.50" Right Hand Thread M28x1.50" Right Hand Thread	AMA52166	\$ 226.61	
 2090, 2094, 2290, 2294, 2390 Late, 2394, 2590, 2594	Tie Rod 3.75" Long, 0.812" Diameter Right Hand Thread Replaces A162214	AMA160200	\$ 25.00	
 2090, 2094, 2290, 2294, 2390 Late, 2394, 2590, 2594	Tie Rod 20.56" Long, 1.25" Diameter, 8 Holes	AMA160197	\$ 40.00	
 Ind: 380B w/ Non-Adjustable Axle	Tie Rod End 4.06" Long, 0.812" Diameter 16 UN Right Hand Thread	AM379327R91	\$ 25.00	

Case®—Tractor

Application	Description	Part Number	Retail Price	Core
 Ind: 380B w/ Non-Adjustable Axle	Tie Rod End	AM379326R91	\$ 25.00	
	4.06" Long, 0.812" Diameter 16 UN Left Hand Thread			
Ind: 380B	Tie Rod Tube	AM3116408R3	\$ 29.25	
	16.187" Long, 7/8" ID 16 Internal Thread Replaces 3116408R1, 3116408R2			

Power Steering Cylinders and Components

Application	Description	Part Number	Retail Price	Core
1896, 2090, 2094, 2096, 2290, 2294, 2390, 2394, 2590, 2594	Power Steering Cylinder End 3.375" Long, 0.875" Diameter 14 Right Hand Thread	AML59042	\$ 60.00	

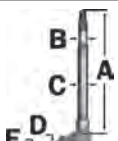
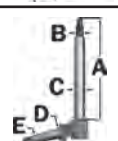
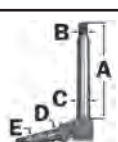
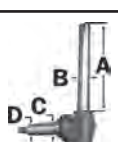
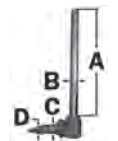

Spindles

Spindles are forged from high grades of alloy steel, machined and assembled to exact specifications that meet or exceed OEM specifications.

Application	Description	Part Number	Retail Price	Core
300, 300B, 400B, 500B, 600B, 630	Spindle A - 16.1875 B - 1.366 C - 1.50 D - 0.812	Right or Left Hand AMG13962	\$ 200.00	
 730, 830, 930, 1030	Spindle	Right Hand	AMA57274	\$ 220.00
	A - 17.125	Left Hand	AMA57275	\$ 220.00
	B - 1.465	Wheel Bearing Kit	WBK-CA-2	\$ 35.00
	C - 2.00	Wheel Bearing Kit	WBK-CA-4	\$ 70.00
	D - 1.75 E - 1.375			
 730, 830, 930, 1030	Spindle	Right or Left Hand	AMA57441	\$ 220.00
	A - 18.25	Wheel Bearing Kit	WBK-CA-2	\$ 35.00
	B - 1.50	Wheel Bearing Kit	WBK-CA-4	\$ 70.00
	C - 2.00			
	D - 1.75 E - 1.375			
 730, 830, 930, 1030 - w/ Wheatland Front End	Spindle	Right or Left Hand	AMA57512	\$ 405.19
	A - 18.25	Wheel Bearing Kit	WBK-CA-2	\$ 35.00
	B - 1.465	Wheel Bearing Kit	WBK-CA-4	\$ 70.00
	C - 2.00			
	D - 1.75 E - 1.375			
 770, 870, 970, 1070, 1175	Spindle	Right or Left Hand	AMA176152	\$ 235.00
	A - 14.50	Wheel Bearing Kit	WBK-CA-2	\$ 35.00
	B - 1.465			
	C - 2.00			
	D - 1.75 E - 1.375			
 880, 880A, 880B, 990, 995, 996, 1290, 1294, 1390, 1394	Spindle	Right or Left Hand	AMK262209	\$ 258.37
	A - 10.00	Wheel Bearing Kit	WBK-CA-7	\$ 18.00
	B - 1.374			
	C - 1.50			
	D - 1.375			
 880, 990, 995, 996, 1290, 1294, 1390, 1394	Spindle	Right or Left Hand	AMK262211	\$ 175.00
	A - 18.125	Wheel Bearing Kit	WBK-CA-7	\$ 18.00
	B - 1.374			
	C - 1.50			
	D - 1.375			

Case®—Tractor

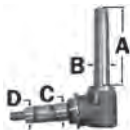
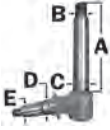
Case®—Tractor

Application	Description	Part Number	Retail Price	Core	
	885, 990, 995, 996, 1190, 1194, 1290, 1294, 1390, 1394	Spindle A - 7.25 B - 1.374 C - 1.50 D - 1.375	Right or Left Hand Wheel Bearing Kit	AMK262207 WBK-CA-7	\$ 266.48 \$ 18.00
	930, 1030 - Late	Spindle A - 16.00 B - 1.50 C - 2.00 D - 1.75 E - 1.375	Right or Left Hand Wheel Bearing Kit Wheel Bearing Kit	AMA57443 WBK-CA-2 WBK-CA-4	\$ 220.00 \$ 35.00 \$ 70.00
	1270, 1370, 1570	Spindle A - 12.625 B - 1.725 C - 2.235 D - 2.165 E - 1.78	Right or Left Hand Wheel Bearing Kit	AMA162068 WBK-CA-3	\$ 265.00 \$ 45.00
	(2090, 2290 Early), 2094, 2294	Spindle A - 12.25 B - 1.465 C - 2.00 D - 1.75 E - 1.375	Right or Left Hand Wheel Bearing Kit	AMA167024 WBK-CA-2	\$ 235.00 \$ 35.00
	2090 Late, 2290, 2390, 2394, 2590, 2594	Spindle A - 12.50 B - 1.725 C - 2.234 D - 2.165 E - 1.78	Right or Left Hand Wheel Bearing Kit	AMA161274 WBK-CA-3	\$ 245.00 \$ 45.00
	Ind: 380B, 480A, 580A, 580B Identify by tractor color: for yellow paint w/ red trim, not for late models w/ dark yellow paint and brown trim	Spindle Replaces A135648 A - 11.225 B - 1.75 C - 2.00 D - 1.75 E - 1.375	Right or Left Hand Wheel Bearing Kit	AMA154657 WBK-CA-2	\$ 448.38 \$ 35.00







Wheel Hubs and Components

Application	Description	Part Number	Retail Price	Core
770, 830, 870, 930, 970, 1030, 1070, 1175, 1896, 2090, 2094, 2096, 2290, 2294, 3390, Ind: 430B, 430CK	Wheel Hub, 6-Bolt	AMA57336	\$ 100.00	
770, 870, 1070, 1175, 1270, (1896, 2096 - w/ Standard Wheel Base), 2090, 2094, 2290, 2294, Ind: 380B, 480A, 580A, 580B, 580CK	Wheel Hub, 8-Bolt	AMA51157	\$ 85.00	
1270, 1370, 1570, 1896, 2090 Late, 2096, 2290, 2390, 2394, 2590, 2594	Wheel Hub, 8-Bolt	AMA66759	\$ 100.00	

Case®—Tractor

Wheel Bearing Kits

Application	Description	Part Number	Retail Price	Core
 200, 300, 430, 530	Wheel Bearing Kit	WBK-CA-1	\$ 25.00	
	Components:			
	Inner Cone	1 LM48548	\$ 6.00	
	Inner Cup	1 LM48510	\$ 4.00	
	Outer Cone	1 LM11949	\$ 2.99	
	Outer Cup	1 LM11910	\$ 1.70	
	Seal	1 AP19050	\$ 11.00	
 730, 770, 830, 870, 930, 970, 1030, 1070, 1175, 1896, 2090 Early, 2094, 2096, 2290 Early, 2294, Ind: 380B, 480A, 580A, 580B - All w/ Hubs w/o Retainers	Wheel Bearing Kit Includes 2-Piece Seal w/o Retainer	WBK-CA-2	\$ 35.00	
	Components:			
	Inner Cone	1 25580	\$ 9.50	
	Inner Cup	1 25520	\$ 4.00	
	Outer Cone	1 25877	\$ 8.25	
	Outer Cup	1 25820	\$ 5.25	
	Seal	1 AP19035	\$ 9.00	
 730, 830, 930, 1030 - w/ Hubs w/ Retainers	Wheel Bearing Kit Includes 1-Piece Seal w/ Retainer	WBK-CA-4	\$ 70.00	
	Components:			
	Inner Cup	1 25520	\$ 4.00	
	Inner Cone	1 25580	\$ 9.50	
	Outer Cup	1 25820	\$ 5.25	
	Outer Cone	1 25877	\$ 8.25	
	Seal	1 AMA27139	\$ 45.87	
 880, 880A, 880B, 885, 990, 995, 996, 1190, 1194, 1290, 1294, 1390, 1394	Wheel Bearing Kit	WBK-CA-7	\$ 18.00	
 (1270, 1370, 1570, 2090, 2290 Late), 2390, 2394, 2590, 2594	Wheel Bearing Kit	WBK-CA-3	\$ 45.00	
	Components:			
	Inner Cone	1 LM603049	\$ 7.25	
	Inner Cup	1 LM603011	\$ 3.25	
	Outer Cup	1 JLM506810	\$ 9.00	
	Outer Cone	1 JLM506849	\$ 16.00	
	Seal	1 AP19040	\$ 9.00	
	Seal	1 AP19045	\$ 11.00	

Steering Arms



Application	Description	Part Number	Retail Price	Core
Ind: 480, 480B, 580, 580B	Steering Arm 16 Tooth, Tapered Spline	Right Hand	AMA137742	\$ 302.93
		Left Hand	AMA137741	\$ 278.97
730, 830, (930, 1030 Early)	Steering Arm, Center Tapered Hole, Long Arm 0.60" to 0.70", Short Arm 0.75" to 0.85"		AMA34798	\$ 287.11
		Steering Arm, Center Tapered Hole, Both Arms 0.60" to 0.70"	AMA24652	\$ 278.80
770, 870, 930, 970, 1030 Late, 1070, 1175	Steering Arm 17 Tooth Tapered Spline	Right Hand	AMA57323	\$ 107.00
		Left Hand	AMA57322	\$ 107.00
2090, 2094, 2290 Early, 2294	Steering Arm 17 Tooth	Right Hand	AMA160124	\$ 139.05
		Left Hand	AMA160125	\$ 95.00

Prices Subject to Change without Prior Notice. The use of original equipment manufacturer (OEM) part numbers or trademarks, e.g. Case® and John Deere®, are for reference purposes only and for indicating product use and compatibility. Our company and the listed replacement parts contained herein are not sponsored, approved or manufactured by the OEM. All parts are New unless designated Reman in the description.

Case®—Tractor

Application	Description	Part Number	Retail Price	Core
1090, 1170, 1270, 1370, 1570	Steering Arm, Left Hand	AMA61405	\$ 265.07	
2090, 2290 Late, 2294, 2390, 2394, 2590, 2594	Steering Arm	Right Hand AMA147121	\$ 44.00	
	20 Tooth	Left Hand AMA147122	\$ 70.00	



Axle Pivot Components

Application	Description	Part Number	Retail Price	Core
770, 870, 970, 1070, 1175	Pivot Pin, Front 5.78" Long, 1.25" Diameter	AMA60568	\$ 65.00	
	Pivot Pin, Rear 2.81" Long, 1.25" Diameter	AMA59628	\$ 75.00	
1170, 1270, 1370, 1570	Pivot Pin, Front w/ Snap Ring Groove 7.93" Long, 1.50" Diameter	AMA143996	\$ 37.86	
	Pivot Pin, Rear w/ Snap Ring Groove 4.41" Long, 1.50" Diameter	AMA143994	\$ 106.78	
770, 870, 970, 1070, 1175	Rear Pivot Support	AMA59614	\$ 125.00	
870, 970, 1070, 1175	Front Pivot Support 1.25" Pivot Pin Hole	AMA66039	\$ 150.00	
1270, 1370, 1570	Front Pivot Support 1.50" Pivot Pin Hole	AMA147407	\$ 296.31	
2090, 2094, 2290, 2390, 2590	Bushing	AMA149887	\$ 20.00	

Remote Valve Components

Application	Description	Part Number	Retail Price	Core
1896, 2090, 2094, 2096, 2290, 2294, 2390, 2394, 2590, 2594, 3294, 3394, 3594, 4490, 4494, 4690, 4694, 4890, 4894, 4994	Hydraulic Valve Mounting Stud 3/8" x 9-7/8" Use w/ Third Remote Valve	AMA147507	\$ 36.00	
	Hydraulic Valve Mounting Stud 3/8" x 9-7/8" Use w/ Fourth Valve	AMA147508	\$ 70.00	

Hydraulic Oil Coolers

Application	Description	Part Number	Retail Price	Core
1270, 1370, 1570	Hydraulic Oil Cooler Core: 23.50" x 9" x 2 1/2" Replaces A139666, A147154	AMA147528	\$ 475.00	



Hydraulic Pumps and Components

Application	Description	Part Number	Retail Price	Core
730, 830, 930, 1030	Reman Hydraulic Pump	AMA34214R	\$ 775.00	\$ 200.00
770, 870, 970, 1070, 1090, 1170, 1175	Hydraulic Pump	AMA62051	\$ 1225.00	
780, 880, 885, 990, 995, 996, 1190, 1194, 1290, 1294, 1390, Ind: 380CK, 380RR	Hydraulic Pump, Single 3-Bolt Belly Mount Replaces K913394, K914466, K917541, K918995, K928578, K962926	AMK962635	\$ 395.00	
1200, 1210, 1212, 1390, 1394, 1490, 1494	Hydraulic Pump, Single Replaces K200916, K307945, K944907	AMK919048	\$ 155.00	

Case®—Tractor

Application	Description	Part Number	Retail Price	Core
1200, 1210, 1212, 1290, 1390, 1394, 1490, 1494	Hydraulic Pump, Tandem	AMK916535	\$ 755.00	
1270, 1370, 1570	Reman Hydraulic Pump	AMA63302R	\$ 950.00	\$ 200.00
1394, 1410, 1412, 1490, 1494, 1594	Hydraulic Pump Replaces K200337, VPK1029	AMK949605	\$ 135.00	
1896, 2090, 2094, 2096, 2290, 2294, 3294	Reman Hydraulic Pump	AMA166504R	\$ 1575.00	\$ 500.00
2390, 2394, 2590, 2594	Reman Hydraulic Pump	AMA166505R	\$ 1575.00	\$ 500.00
2470 Transmission BSN 2429430	Reman Hydraulic Pump, Triple	AMA75475	\$ 750.00	\$ 100.00
2470, 2670	Hydraulic Pump, Triple	AMA141223-N	\$ 2750.00	
2870	Reman Hydraulic Pump	AMA150825R	\$ 1575.00	\$ 500.00
4490, 4494, 4690, 4694	Reman Hydraulic Pump	AMA166507R	\$ 1575.00	\$ 500.00
Ind: 480C, 580C, 580F	Hydraulic Pump	AMD53690	\$ 696.06	
1896, 2096, 2394, 2594, 3394, 3594	Compensator Valve Replaces A49438, A49493	AMA49832	\$ 900.00	

Power Steering Pumps

Application	Description	Part Number	Retail Price	Core
990, 990 Selectamatic, 995, 1200 Selectamatic, 1210, 1212	Power Steering Pump w/o Reservoir	AMK918993	\$ 385.00	
1290, 1390, 1490	Power Steering Pump w/ Reservoir	AMK957318	\$ 385.00	

PTO Shafts



Application	Description	Part Number	Retail Price	Core
730, 830, 930, 1030	PTO Output Shaft Single Speed 540 RPM PTO, 13 11/16" Long	AMA64592	\$ 150.00	
770, 870, 970, 1070, 1175	PTO Output Shaft Dual Speed, Flip-Flop, 11" Long	AMA58214	\$ 286.21	
1896, 2090, 2094, 2096, 2290, 2294	PTO Output Shaft Dual Speed, Flip-Flop, 12 3/16" Long	AMA140655	\$ 204.04	

PTO Adapters

Application	Description	Part Number	Retail Price	Core
Tractors up to 70HP	PTO Adapter Small 540 to 1000 Spline Changes PTO from 1 3/8" x 6 spline to 1 3/8 x 21 spline and extends the PTO shaft 4 1/8"	AMX59112	\$ 40.00	
Tractors up to 70HP	PTO Adapter Small 1000 to 540 Spline, 6 3/8" Overall Length Reduces PTO from 1 3/8" x 21 spline to 1 3/8" x 6 spline and extends the PTO shaft 4 1/8"	AMX59108	\$ 40.00	
Tractors up to 100HP	PTO Adapter Large 1000 to 540 Spline, 7 1/2" Overall Length Reduces PTO from 1 3/4" x 20 spline to 1 3/8" x 6 spline and extends the PTO shaft 4 5/8"	AMX59109	\$ 70.00	
Tractors up to 100HP	PTO Adapter Large 1000 to Small 1000 Spline, 7" Overall Length Changes PTO from 1 3/4" x 20 Spline to 1 3/8" x 21 Spline and extends the PTO shaft 4 5/8"	AMX59110	\$ 70.00	



Ring Gears and Pinions

Application	Description	Part Number	Retail Price	Core
Ind: 200B, 300, 300B, 310, 430, 440-1, 470, 480B, 530, 570, 580B, VAC	Ring Gear and Pinion Set 7 & 43 Tooth, 12 Holes	AMA50997	\$ 475.00	
Ind: 480C, 480D, 580C, 580D	Ring Gear and Pinion Set Bolt-on for splined center wheel	AMA51980	\$ 495.00	
970, 1070, 1090	Ring Gear and Pinion Set	AMA179357	\$ 435.00	

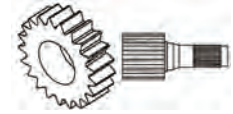

Brake Shafts and Side Gears

Application	Description	Part Number	Retail Price	Core
1270, 1370, 2390, 2394	Brake Shaft 11.625" Long, 13 Tooth, 36 Splines Replaces A66789, A148020, A153938	AMA168168	\$ 370.00	
1570, 2590	Brake Shaft 13" Long, 13 Tooth, 41 & 36 Splines Replaces A67147, A153939	AMA168169	\$ 546.43	
1896 Transmission BSN 16264523, 2090, 2094, 2096 Transmission BSN 16264559, 2290, 2294 Transmission BSN 16264554	Brake Shaft 13.25" Long, 13 Tooth, 36 Splines	AMA168167	\$ 686.11	
2470, 2670	Brake Shaft 10.563" Long, 13 Tooth, 30 Splines	AMA76594	\$ 499.71	
1896, 2094, 2096	Pinion Gear 2.62" OD, 25 Tooth Replaces A150253	AMA168174	\$ 90.00	
(1270, 1370 ASN 10032467), 1570, 2390, 2394 BSN 16260432, 2590	Planetary Gear 3.125" OD, 25 Tooth Replaces A150011, A153220, A153937	AMA168175	\$ 253.20	

Brakes and Components

Application	Description	Part Number	Retail Price	Core
400, 730, 770 BSN 8682416, 800, 830, (870, 970 BSN 8675001), 930, 1030	Brake Disc, Bonded 24 Spline, 4" ID, 7" OD Replaces A40794, 1975466C1, 1975466C2	AMA44712	\$ 17.00	
770 ASN 8682417, (870, 970 ASN 8675002), 1070	Brake Disc, Bonded 24 Spline, 5" ID, 8" OD Replaces A65189, A65336	AM1975469C1	\$ 17.00	

Drawbars and Components

All of our drawbars are cut, drilled and heat-treated to exact design and specifications that meet or exceed OEM specifications.



Application	Description	Part Number	Retail Price	Core
970, 1070	Drawbar - Standard Duty 2.50" x 1.25" x 45.875", (1) 1.067" Diameter Hole from Front	AMA65750	\$ 210.67	
1270 ASN 8717277, 1370, 1570, 2390, 2394, 2590, 2594	Drawbar 3" x 1.75" x 53" w/ 4.25" Offset (1) 1.281" Diameter Hole 1.75" from End	AMA160849	\$ 217.00	
1896, 2090, 2094, 2096, 2290, 2294	Drawbar - Standard Duty 2.50" x 1.25" x 56.00"	AMA137939	\$ 135.00	
730, 830, 930, 970, 1030, 1070	Drawbar Bracket, Front For tractors w/o 3-point hitch	AMA57201	\$ 161.26	
770, 870, 970, 1070, 1175	Drawbar Bracket, Front For tractors w/ 3-Point Hitch	AMA59603	\$ 344.89	



Hammer Straps

Application	Description	Part Number	Retail Price	Core
970, 1070, 1175, 2090, 2290	Drawbar Hammer Strap	AMA64384	\$ 140.00	
1090, 1170, 1175, 1270, 1370, 1570, 2390, 2394, 2590, 2594, 3294, 3394, 3594	Drawbar Hammer Strap	AMA61557	\$ 195.00	
1896, 2090, 2094, 2290, 2294, 3294	Drawbar Hammer Strap	AMA161230	\$ 175.00	



Quick Hitches

Application	Description	Part Number	Retail Price	Core
Cat II	Quick Hitch, 4" x 6" Beam 36" Wide, Includes 1 1/8" Mounting Pins and Adapter Bushings	AMX741020	\$ 565.00	
Cat III	Quick Hitch, 4" x 6" Beam 38" Wide, Includes 1 7/16" Mounting Pins	AMX741022	\$ 565.00	
Cat III	Quick Hitch, 4" x 6" Beam 44" Wide, Includes 1 7/16" Mounting Pins	AMX741021	\$ 565.00	





Battery Boxes and Components

Application	Description	Part Number	Retail Price	Core
2090, 2094, 2096, 2290, 2294, 2390, 2394, 2590, 2594, 3294, 3394, 3594	Battery Box Cover	AMA161331	\$ 100.00	

Front Weight Bracket







Application	Description	Part Number	Retail Price	Core
1896, 2096, 2394, 2594, 3394, 3594	Front Weight Mounting Frame 18 Weights	AM1342125C2	\$ 450.00	

Lighting









Application	Description	Part Number	Retail Price	Core
 (730, 830, 930, 1030 Comfort King), 770, 870, 970, 1070, 1170, 1175, 1270, 1370, 1470, 1570, 2090, 2094, 2290, 2294, 2390, 2394, 2470, 2590, 2594, 2670, 2870, 3294, 3394, 3594, 4490, 4494, 4690, 4694, 4890, 4894, 4994, Ind/Const: 480B, 480C, 580B Replaces A32536, A59701, A64498	LED Trapezoid Light Fender Mount 4.50" Sealed Beam Round Light 2800 Lumens, 40 Watts, 3.30 Amps For 12 Volt to 24 Volt Systems Rear Stud Mount w/ Built-In Heat Sink Includes Both Long and Short Rubber Bezels	AMTL2060	\$ 95.00	
 Universal Equipment	LED Floodlight All-Position Light 4.25" x 4.25" Square Light 2650 Lumens, 48 Watts, 4 Amps For 12 Volt to 24 Volt Systems Includes Mounting Bracket and Stainless Steel Hardware	AMRE25126	\$ 45.00	
		AMTL105F	\$ 95.00	

Case®—Tractor

Case®—Tractor





Application	Description	Part Number	Retail Price	Core
 Universal Equipment	LED Floodlight All-Position Light 6.25" x 1.75" Rectangle Light 1300 Lumens, 18 Watts, 1.50 Amps For 12 Volt to 24 Volt Systems Includes Mounting Bracket and Stainless Steel Hardware	AMTL118F	\$ 50.00	
 Universal Equipment	LED Floodlight All-Position Light 5" Round Light 3200 Lumens, 40 Watts, 3.30 Amps For 12 Volt to 24 Volt Systems Includes Mounting Bracket and Stainless Steel Hardware	AMTL180	\$ 89.00	
 Universal Equipment	LED Floodlight All-Position Light Round Light 6900 Lumens, 50 Watts, 4.10 Amps For 9 Volt to 32 Volt Systems Includes Mounting Bracket and Stainless Steel Hardware	AMTL500F	\$ 120.00	
	LED Floodlight All-Position Light 4.30" Round Light 5040 Lumens, 50 Watts, 4.10 Amps For 12 Volt to 24 Volt Systems Includes Stainless Steel Adjustable Mounting Bracket	AMAT305931	\$ 96.00	
 Universal Equipment	LED Floodlight All-Position Light 4.25" Round Light 2650 Lumens, 42 Watts, 3.50 Amps For 12 Volt to 24 Volt Systems Includes Mounting Bracket and Stainless Steel Hardware	AMTL115F	\$ 59.00	
Universal Equipment	LED Wide Floodlight All-Position Light 5" x 7" Rectangle Light 3800 Lumens, 35 Watts For 12 Volt to 24 Volt Systems Replaces 47682629, 47682620, 84236850, 87555142, 87584890	AMX34171	\$ 60.00	
 Most Models	Compact LED Wide Floodlight 4.25" x 4.50" x 3" Round Light 6900 Lumens, 50 Watts, 4.10 Amps 90° Flood Pattern For 9 Volt to 32 Volt Systems Includes Mounting Bracket and Stainless Steel Hardware	AMTL500WF	\$ 120.00	
 Universal Equipment	LED Floodlight, Sealed Beam Fender Mount 4.50" Diameter Round Light 1250 Lumens, 18 Watts, 1.50 Amps Trapezoid Pattern For 12 Volt to 24 Volt Systems Replaces D70115, D71409, A11280	AMTL3010	\$ 40.00	
	LED Floodlight Fender Mount 4.50" Diameter Sealed Beam Round Light 1250 Lumens, 18 Watts, 1.20 Amps Trapezoid Pattern For 12 Volt to 24 Volt Systems Lasts 50 times longer than halogen lighting, vibration resistant w/ no filament failures, uses original mount and wiring, Operating temperature of -40°F to 140°F / -40°C to 60°C Replaces A11280, D70115, D71409	AMRE336111	\$ 35.00	

Case®—Tractor







	Application	Description	Part Number	Retail Price	Core
	Universal Equipment	LED Floodlight Fender Mount 4.50" Diameter Sealed Beam Round Light 1440 Lumens, 18 Watts, 1.60 Amps Lasts 50 times longer than halogen lighting, vibration resistant w/ no filament failures, 2-terminal connection, Operating temperature of -40°F to 140°F / -40°C to 60°C	AMRE336112	\$ 67.75	
	Universal Equipment	LED Floodlight Cab and Fender Mount 3.50" x 6" Rectangle Light 3600 Lumens, 40 Watts, 3 Amps	AMX34146	\$ 65.00	
	1294, 1394, 1494, 1594, 1690, 1896, 2090, 2094, 2096, 2290, 2294, 2390, 2394, 2590, 2594, 2870, 3294, 3394, 3594, 4490, 4494, 4690, 4694, 4890, 4894, 4994	LED Floodlight/Spotlight Cab Mount 4" x 6.50" Rectangle Light Dual Hi/Lo Beam 3500 Lumens, 60 Watts, 5 Amps For 12 Volt to 24 Volt Systems Replaces 138225A1, 183162A1, 353657A1, 87367623	AMTL6090	\$ 99.00	
		LED Floodlight/Spotlight Cab Mount 4" x 6.50" Rectangle Light Dual Hi/Lo Beam 3500 Lumens, 60 Watts, 5 Amps For 12 Volt to 24 Volt Systems Replaces 138225A1, 183162A1, 353657A1	AM87367623	\$ 79.20	
	Ind/Const: 650G, 650H, 750H, 850H, 1150H, Backhoe-Loaders: 580K, 580SK, 590 Replaces 92263C1, 178345A1, 180097A1, 275335A1, 305256A1, 1983210C1, 87435762, 87773385	LED Floodlight Lower Front, Cab, Fender and ROPS 6" x 3.50" x 6" Rectangle Light 3600 Lumens, 40 Watts, 3.30 Amps For 12 Volt to 24 Volt Systems Includes Connector, Plug-and-Play	AMTL3030	\$ 90.00	
		LED Floodlight Lower Front, Cab, Fender and ROPS 6" x 3.50" x 6" Rectangle Light 3600 Lumens, 40 Watts, 3.30 Amps For 12 Volt to 24 Volt Systems Includes Connector, Plug-and-Play	AM92269C1	\$ 72.00	
	Universal Equipment	LED Spotlight All-Position Light 4.25" x 4.25" Square Light 1400 Lumens, 27 Watts, 2.20 Amps For 12 Volt to 24 Volt Systems	AMTL100S	\$ 45.00	
	Universal Equipment	LED Spotlight All-Position Light 6.25" x 1.75" Rectangle Light 1300 Lumens, 18 Watts, 1.50 Amps For 12 Volt to 24 Volt Systems Includes Mounting Bracket and Stainless Steel Hardware	AMTL118S	\$ 50.00	
	Universal Equipment	LED Spotlight All-Position Light Round Light 6900 Lumens, 50 Watts, 4.10 Amps For 9 Volt to 32 Volt Systems Includes Mounting Bracket and Stainless Steel Hardware	AMTL500S	\$ 120.00	
	1190, 1290, 1390, 1490, 1690, 2090, 2290, 2390, 2590, 4490, 4690, 4890	LED Trapezoid Light Fender Mount 4.50" Sealed Beam Round Light 2200 Lumens, 24 Watts, 2 Amps For 12 Volt to 24 Volt Systems Uses Original Mount and Wiring Replaces RE336111	AMTL3015	\$ 50.00	

Case®—Tractor

Case®—Tractor



	Application	Description	Part Number	Retail Price	Core
	Universal Equipment	LED Trapezoid Light Cab and Fender Mount 4.50" Diameter Round Light 2800 Lumens, 40 Watts, 3.30 Amps Trapezoid Pattern For 12 Volt to 24 Volt Systems Bottom Mount w/ Built-In Heat Sink Includes Mounting Bracket, Long and Short Rubber Bezels, and Stainless Steel Hardware Replaces A145495, 131368C92	AMTL2080	\$ 95.00	
		LED Trapezoid Light Cab and Rear Fender Mount 4.50" Diameter Round Light 2800 Lumens, 40 Watts, 3.30 Amps Trapezoid Pattern For 12 Volt to 24 Volt Systems Bottom Mount w/ Built-In Heat Sink Includes Mounting Bracket, Long and Short Rubber Bezels and Stainless Steel Hardware Replaces A145495, 131368C92	AMX33121	\$ 76.00	
	Universal Equipment	LED Warning Light Cab, Header or Swather Mount Can be used for Turn Signal, Brake or Running Lights 4.125" Diameter Round Light Double Sided, Amber Lenses 25 Bulbs per Side For 12 Volt to 24 Volt Systems	AMTLFL2	\$ 55.00	
		LED Warning Light Cab, Header or Swather Mount Can be used for Turn Signal, Brake or Running Lights 4.125" Diameter Round Light Double Sided, Amber Lenses 25 Bulbs per Side For 12 Volt to 24 Volt Systems	AMX1910149	\$ 44.00	
	Universal Equipment	LED Warning Light Cab, Header or Swather Mount Can be used for Turn Signal, Brake or Running Lights 4.125" Diameter Round Light Double Sided, Red and Amber Lenses 25 Bulbs per Side For 12 Volt to 24 Volt Systems	AMTLFL3	\$ 55.00	
		LED Warning Light Cab, Header or Swather Mount Can be used for Turn Signal, Brake or Running Lights 4.125" Diameter Round Light Double Sided, Red and Amber Lenses 25 Bulbs per Side For 12 Volt to 24 Volt Systems	AMX33126	\$ 44.00	
	Universal Equipment	LED Magnetic Warning Light All-Position Light 360° Flashing Light, Multiple Patterns 9.50" x 6.75" Rectangle Light Magnetic Base or Solid Mount For 12 Volt to 24 Volt Systems Includes Cigarette Lighter Adapter, Wiring and Switch	AMTL1100	\$ 170.00	
	Universal Equipment	LED Magnetic Warning Light All-Position Light 360° Flashing Light, Multiple Patterns 14" x 6.75" Rectangle Light Magnetic Base or Solid Mount For 12 Volt to 24 Volt Systems Includes Cigarette Lighter Adapter, Wiring and Switch	AMTL1200	\$ 190.00	

Case®—Tractor

Application	Description	Part Number	Retail Price	Core
Universal Equipment	Warning Beacon 360° Flashing Beacon, Amber Lens For 0.9435" Diameter Pipe Replaces 84337818, AZ44705, AZ101891	AM82018390	\$ 45.64	
 Universal Equipment	LED Warning Beacon 360° Flashing Beacon 2.75" x 5.25" Light Polycarbonate Amber Lens and Housing For 12 Volt to 24 Volt Systems Includes Solid Mounting Pad and Stainless Steel Hardware	AMTL2100	\$ 30.00	
 Universal Equipment	LED Warning Beacon 360° Flashing Beacon, 3 Different Patterns 5" x 10" Light Amber Lens, 48 Watts, 4 Amps For 12 Volt to 24 Volt Systems Brackets Sold Separately	AMX33131	\$ 75.00	
 Universal Equipment	Warning Beacon Bracket	AMX33132	\$ 15.00	
 Universal Equipment	Warning Beacon Bracket	AMX33133	\$ 15.00	
 Universal Equipment	Warning Beacon Bracket	AMX33137	\$ 15.00	
 Universal Equipment	Warning Beacon Bracket	AMX33135	\$ 15.00	

Case®—Tractor



Case®—Tractor

Application	Description	Part Number	Retail Price	Core
 Universal Equipment	LED Light Bar 4" Long, 1260 Lumens, Cree Bulbs	AMLED4	\$ 45.00	
	LED Light Bar Flood/Spotlight Combo 10" Long, 5700 Lumens, 50 Watts, 4.20 Amps For 12 Volt to 24 Volt Systems Includes Mounting Bracket and Stainless Steel Hardware	AMTL10SRC	\$ 129.00	
	LED Light Bar Floodlight/Spotlight Combo 14" Long, 5400 Lumens, 72 Watts, 6 Amps Die Cast Aluminum Housing, Polycarbonate Lens For 12 Volt to 24 Volt Systems Includes Mounting Bracket and Heavy Duty Stainless Steel Hardware	AMTLB410C	\$ 150.00	
	LED Light Bar Floodlight/Spotlight Combo 30" Long, 13600 Lumens, 150 Watts, 12.50 Amps For 12 Volt to 24 Volt Systems Includes Mounting Bracket and Stainless Steel Hardware	AMTL30SRC	\$ 230.00	
	LED Light Bar 30" Long, 13860 Lumens, Cree Bulbs	AMLED30	\$ 130.00	
	LED Light Bar Floodlight/Spotlight Combo 40" Long, 17300 Lumens, 200 Watts, 16.70 Amps For 12 Volt to 24 Volt Systems Includes Mounting Brackets and Stainless Steel Hardware	AMTL40SRC	\$ 300.00	
	LED Light Bar 40" Long, 18200 Lumens, Cree Bulbs	AMLED40	\$ 160.00	
	LED Light Bar Floodlight/Spotlight Combo 42" Long, 14500 Lumens, 240 Watts, 19 Amps For 12 Volt to 24 Volt Systems Includes Mounting Bracket and Stainless Steel Hardware Replaces 1163691	AMTLB440C	\$ 250.00	
	LED Light Bar, Curved 50" Long, 21500 Lumens, Cree Bulbs	AMLED50C	\$ 190.00	
	 Universal Equipment	LED Magnetic Work Light All-Position Light 3.25" Square Floodlight 900 Lumens Magnetic Base Includes Lithium Ion Battery, Cigarette Lighter and DC Charger	AMTL2460	\$ 79.00



Cab Roofs

Application	Description	Part Number	Retail Price	Core
1896, 2096, 2294, 2394, 2594, 3294, 3394, 3594, 4494, 4694, 4994	Cab Roof Replaces A181470	AMA177245	\$ 750.00	

Glass

Application	Description	Part Number	Retail Price	Core
 1896, 2090, 2094, 2096, 2290, 2294, 2390, 2394, 2590, 2594, 3294, 3394, 3594, 4490, 4690, 4890	Side Glass, Upper Fits upper door glass or right hand side glass	AMF63307	\$ 118.64	
 1896, 2094, 2096, 2294, 2394, 2594, 3294, 3394, 3594, 4494, 4694, 4894, 4994	Rear Window	AMF98367	\$ 350.00	

Case®—Tractor

Application	Description	Part Number	Retail Price	Core
 2090, 2290, 2390, 2590	Rear Window	AMF64517	\$ 95.00	
 770, 870, 970, 1070, 1090, 1170, 1175, 1270, 1370, 1490, 1570, 1690, 1896, 2090, 2094, 2096, 2290, 2294, 2390, 2394, 2470, 2590, 2594, 2670, 2870, 3294, 3394, 3594, 4490, 4494, 4694, 4890, 4894, 4994	Weatherstrip 300" (25') Long For Window Seal	AMA42677X	\$ 123.28	
 1270, 1370, 1490, 1570, 1690, 1896, 2090, 2096, 2290, 2394, 2470, 2594, 2670, 2870, 4490, 4494, 4690, 4694, 4890, 4894, 4994	Weatherstrip 177.00" Long For Cab Door Replaces F64267, F64403, F64773, F64775	AMR53628	\$ 28.34	
970, 1270, 1370, 1896, 2090, 2094, 2096, 2290, 2294, 2390, 2394, 2470, 2590, 2594, 2670, 3294, 3394, 3594, 4490, 4494, 4690, 4694, 4890, 4894, 4994	Weatherstrip 156" Long For Rear Window Replaces F64499	AMF64499	\$ 107.68	

Cables

Application	Description	Part Number	Retail Price	Core
1896, 2090, 2094, 2096, 2290, 2294, 2390 ASN 8847357, 2394, 2590 BSN 8847358, 2594, 3294, 3394, 3594	Clutch Operating Cable 70" Long, 5/16"x24 Threaded Ends Replaces A160703, A161778	AM179044A1	\$ 135.50	

Cab Doors

Door frame only. No glass, seal or hardware included.



Application	Description	Part Number	Retail Price	Core
870, 970, 1070, 1175	Cab Door Frame	AMF89671	\$ 385.00	
1270, 1370, 1570	Cab Door Frame	AMF89691	\$ 365.00	
1896, 2090, 2094, 2096, 2290, 2294, 2296, 3294	Cab Door Frame	AMF988028	\$ 385.00	
2390, 2394, 2590, 2594, 3394, 3594	Cab Door Frame	AMF97065	\$ 395.00	

Gas Struts



Application	Description	Part Number	Retail Price	Core
1896, 2094, 2096, 2294, 2394, 2594, 3294, 3394, 3594	Gas Strut, Door Replaces A181297, F64937	AM98153C1	\$ 19.00	
1896 ASN 17895000, 2096 SN 17897500-17897505 & ASN 17897510, 2394, 3594 Replaces A185714	Gas Strut, Door	AM1280263C1	\$ 19.00	
1896 ASN 17894999, 2096 SN 17895000-17897505 and ASN 17897509, 2394, 2594, 3394, 3594	Stud, Door Gas Strut Replaces 142597A1	AM3234063R1	\$ 7.00	







Fuel Tanks and Components

Made of high-quality polyethylene material.

Application	Description	Part Number	Retail Price	Core
770, 870, 970, 1070, 1090, 1170, 1175	Fuel Tank Includes fuel cap	AMA143073	\$ 395.00	
770, 870, 970, 1070, 1090, 1170, 1175	Fuel Sending Unit	AMA62092	\$ 42.59	

Air Conditioning and Components

Application	Description	Part Number	Retail Price
 770, 870, 970, 1070, 1090, 1170, 1175, 1490, 1690	Compressor Conversion Kit York Style to Aftermarket Sanden Style Includes Compressor, Mounting Brackets, Compressor Manifold, O-Rings and Mounting Hardware See Manufacturer for Oil Type and Quantity	AMX10263	\$ 450.00
	Premium Synthetic Ester Oil, 100V, 12 oz	AMX10273	\$ 11.00
 (1070, 1170 ASN 8686964), 1270, 1370, 1570	Compressor Conversion Kit York Style to Seltec Style Includes Compressor, Mounting Bracket, O-Rings, Service Valves and Mounting Hardware Requires Synthetic Ester Oil 100V, 5.10 oz (151 cc)	AMX10230	\$ 420.00
	Premium Synthetic Ester Oil, 100V, 12 oz	AMX10273	\$ 11.00
 2090*, 2094*, 2290*, 2294*, 2390, 2394, 2590, 2594, 3294, 3394, 3594 *Requires AMX10170 Compressor to Condenser Hose	Compressor Conversion Kit York to Sanden Includes Compressor, Mounting Brackets, O-Rings, Belt, Service Valves and Mounting Hardware Requires Pag Oil 100V, 7.10 oz (210 cc)	AMX10166	\$ 395.00
	Compressor to Condenser Hose Replaces A145696	AMX10170	\$ 50.00
	Ultra Pag Double End Capped, 100V, 8 oz	AMX10267	\$ 12.00
	Universal Pag Oil, 8 oz	AMX10274	\$ 8.25
	Compressor, Sanden SD5H14 12 Volt, w/ 2-Groove Clutch, 5.25" Clutch Diameter, 3 1/4" Inside Ear Measurement (Front to Rear), Vertical #8 and #10 O-Ring, w/o Charge Ports, w/ 1-Wire Bullet Connector Requires Pag Oil 100V, 6.00 oz (177 cc)	AM86508521	\$ 195.00
	Ultra Pag Double End Capped, 100V, 8 oz	AMX10267	\$ 12.00
	Universal Pag Oil, 8 oz	AMX10274	\$ 8.25
 770, 870, 970, 1070, 1090, 1170, 1175, 1270, 1370, 1470, 1490, 1570, 1690, 2090, 2094, 2290, 2294, 2390, 2394, 2470, 2590, 2594, 2670, 3294, 3394, 3594 Replaces A64710, A66245, A141060	Compressor, York Style Left Hand Suction, Rotolock Clutch Not Included Requires Synthetic Ester Oil 100V, See Manufacturer for Oil Quantity	AMX10225	\$ 260.00
	Double Groove Clutch for York Compressor, 7"	AM470	\$ 101.00
	Premium Synthetic Ester Oil, 100V, 12 oz	AMX10273	\$ 11.00
 1394, 1494, 1594 Replaces 60-2921T91, 60-2921T94, K303739, K307237	Compressor, Sanden SD510HD Style 12 Volt, w/ 2-Groove Clutch, 5.19" (132 mm) Clutch Diameter, Vertical #8 and #10 Flare Fittings, w/ R12 Charge Ports Requires Pag Oil 100V, 4.56 oz (135 cc)	AMX10126	\$ 200.00
	Ultra Pag Double End Capped, 100V, 8 oz	AMX10267	\$ 12.00
	Universal Pag Oil, 8 oz	AMX10274	\$ 8.25

Case®—Tractor

Case®—Tractor

Application	Description	Part Number	Retail Price
 1896, 2096, 4494, 4694, Backhoe: 580K Replaces A177068	Compressor, Sanden SD510 Style 12 Volt, w/ 2-Groove Clutch, 5.19" (132 mm) Clutch Diameter, 0.50" Belt Width, Vertical #8 and #10 O-Ring, w/ R12 Charge Ports Requires Pag Oil 100V, 4.56 oz (135 cc)	AMX10220	\$ 325.00
	Ultra Pag Double End Capped, 100V, 8 oz	AMX10267	\$ 12.00
	Universal Pag Oil, 8 oz	AMX10274	\$ 8.25
 (3220, 3230 ASN 11070000), 4210, 4240 Replaces 1999755C2, 1999755C3, 86993462, 1977959C1	Compressor, Sanden SD7H15 12 Volt, w/ 2-Groove Clutch, 6" Clutch Diameter, Horizontal Tube O-Ring Requires Synthetic Ester Oil 100V, 9.60 oz (285 cc)	AMX10125	\$ 240.00
	Premium Synthetic Ester Oil, 100V, 12 oz	AMX10273	\$ 11.00
 1294, 1394, 1490, 1494, 1594, 1690, 1896, 2090, 2094, 2096, 2290, 2294, 2390, 2394, 2470 ASN 7864002, 2590, 2594, 2670 ASN 7864002, 2870, 3294, 3394, 3594, 4490, 4494, 4690, 4694, 4890, 4894, 4994 Replaces A176304, L73646	Rotary Adjustable Thermostatic Switch 3/6" Capillary Tube	AMX10251	\$ 45.00
	Universal Equipment	High Pressure Switch Normally Open, Opens at 305 PSI, Closes at 395 PSI, 7/16"x20 Thread	AMX10276
 Universal Equipment	Low Pressure Switch Normally Open, Opens at 6 PSI, Closes at 45 PSI, Standard 7/16"x20 Thread	AMX10277	\$ 55.00
	Universal Equipment	Low Pressure Switch Normally Open, Opens at 35 PSI, Closes at 46 PSI, Standard 7/16"x20 Thread	AMX10278
 770, 870, 970, 1070, 1090, 1170, 1175, 1270, 1370, 1394, 1470, 1490, 1494, 1570, 1594, 1690, 1896, 2090, 2094, 2096, 2290, 2294, 2390, 2394, 2470, 2590, 2594, 2670, 2870, 3294, 3394, 3594, 4490, 4494, 4694, 4890, 4894, 4994 Replaces A61688, T39837, A76312, A76085	Receiver Drier 2 3/4" x 10 1/4", Inlet - #6 Male O-Ring, Outlet - #6 Male O-Ring, Switch Port - 1 3/8" - 24 Female O-Ring, Top Sight Glass, R12 and R134a Compatible	AMX10163	\$ 25.00
	770, 870, 970, 1070, 1090, 1170, 1175, 1270, 1370, 1570 Replaces 124050A1, A79312	Receiver Drier 2 1/2" x 8" Male O-Ring, R12 & R134a Compatible	AMX10237
 770, 870, 970, 1070, 1090, 1170, 1175, 1270 Agri King, 1370, 1394, 1490, 1494, 1570, 2090, 2094, 2096, 2290, 2294, 2390, 2394, 2470, 2590, 2594, 2670, 2870, 3294, 3394, 3594, 4490, 4494, 4690, 4694, 4890, 4894, 4994 Replaces A42625, F63726	Expansion Valve Bulb Type, Externally Equalized, R12 and R134a Compatible, 12" Tube Length, Flare Connection	AMX10153	\$ 25.00
	1470, 1594, 1690, 1896	Expansion Valve Bulb Type, R12 and R134a Compatible, 19" Tube Length, Flare Connection	AMX10146
 Ind: 221E	Expansion Valve Block Type, R12 and R134a Compatible, O-Ring Connection	AMX10150	\$ 26.00

Prices Subject to Change without Prior Notice. The use of original equipment manufacturer (OEM) part numbers or trademarks, e.g. Case® and John Deere®, are for reference purposes only and for indicating product use and compatibility. Our company and the listed replacement parts contained herein are not sponsored, approved or manufactured by the OEM. All parts are New unless designated Reman in the description.

Case®—Tractor

Case®—Tractor

Application	Description	Part Number	Retail Price
 1490, 1690, 2090, 2094, 2290, 2294 Replaces A145898, A145910, A145911, F64304, F64305	Hose Kit, 5 Pc. For York Compressor Only	AMX10262	\$ 235.00
 2390, (2394, 2594 BSN 12093701), 2590, 3294	Hose Kit, 5-Piece Replaces A145696, A145697, A145698	AMX10285	\$ 240.00
 Ind: 221E	Blower Motor Assembly 12 Volt Replaces 87663947, 87663956	AM87663955	\$ 155.00
 770, 870, 970, 1070, 1090, 1170, 1175, 1270, 1370, 1570, 2470, 2670 BSN 7864001 Replaces F89750	Blower Motor 2-Speed, Double Shaft, 2-Wire, Reversible, 5/16" Shaft Diameter, 1 7/8" Long	AMX10116	\$ 75.00
 1896, 2090, 2094, 2096, 2290, 2294, 2390, 2394, 2590, 2594, 2670 ASN 2864003, 2870, 3294, 3394, 3594, 4490, 4494, 4690, 4694, 4890, 4894, 4994 Replaces F36903, F42775, F45196, F96901	Blower Motor Single Speed, Double Shaft, 2-Wire, Reversible, 5/16" Shaft Diameter, 3 5/8" Long	AMX10111	\$ 55.00
 1896, 2094, 2096, 2294, 2394, 2594, 3294, 3394, 3594, 4494, 4694, 4894, 4994	Blower Wheel Replaces F45020, F45021	AMF64935	\$ 34.00
 1490, 1896, 2090, 2094, 2096, 2290, 2294	Condenser Overall: 23" x 12" Core: 18 1/2" x 11" x 3" 4 Rows	AMA145899	\$ 315.00
 2390, 2394, 2590, 2594, 3294, 3394, 3594	Condenser Core: 21" x 11" x 3"	AMA145695	\$ 325.00
 4490, 4494, 4690, 4694, 4890, 4894, 4994	Condenser May Require (7) 14982890 Hoses Core: 24.75" x 2.25" x 12"	AMA152071	\$ 350.00
 (870, 970, 1070 ASN 8675001), 1170, 1175, 1270, 1370, 2470 Cab BSN 7864002	Evaporator Bulb Type Valve Overall: 35" x 8 3/4" x 5" Core: 29 1/2" x 2 1/2" x 5"	AMF63646	\$ 250.00
 1490, 1690, 2090, 2094, 2290, 2294, 2390, 2394, (2470, 2670 ASN 7864002), 2590, 2594, 2870, 3294, 4490, 4494, 4690, 4694, 4890, 4894, 4994	Evaporator Bulb Type Valve Core: 28" x 2 1/2" x 5" Overall: 34" x 8 1/2" x 5"	AMF63870	\$ 245.00
 (1896, 2096 ASN 12104351), (2294, 3294 ASN 12107380), (2394, 2594 ASN 12093701), 3394, 3594, (4494, 4694 ASN 12112500)	Evaporator w/ Heater Core	AMF66203	\$ 315.00

Shop Manuals and Collections

I&T Shop Service Manuals provide the information you need to service virtually any make or model of wheel-type farm tractor. Easy-to-follow procedures, detailed illustrations and comprehensive specifications help guide you through complete tractor maintenance and repair with accuracy and efficiency.



Application	Description	Part Number	Retail Price
Models: 2090, 2094, 2290, 2294, 2390, 2394, 2590, 2594	J.I. Case®	IT-C-37	\$ 28.00
Models: 1190, 1194, 1290, 1294, 1390, 1394, 1490, 1494, 1594, 1690	David Brown®	IT-C-36	\$ 28.00
Models: 1896, 2096	Case / International®	IT-C-38	\$ 28.00
Models: 385, 485, 585, 685, 885	Case / International®	IT-C-39	\$ 28.00

Case®—Tractor

Application	Description	Part Number	Retail Price
Series: C, D, L, LA, S, V, VA, Series: 200B, 300, 300B, 350, 400B, 500B, 600B, Series: 400, 700B, 800B	J.I. Case Collection®	IT-C-201	\$ 31.00
Series: 500, 600, 900B, Series: 430, 470, 530, 570, 630, Series: 730, 830, 930, 1030	J.I. Case Collection®	IT-C-202	\$ 31.00
Series: 770, 870, 970, 1070, 1090, 1170, 1175, Models: 885, 995, 1210, 1212, 1410, 1412, Models: 770, 780, 880 ASN 52100, 990 ASN 467870, 1200, 3800, 4600, Series: 1270, 1370, 1570	J.I. Case Collection®	IT-C-203	\$ 31.00

Case®—Industrial / Construction

Table of Contents

Crankshafts	392	Radiators	393
Engine Fans	393	Rear Wheel Drive	394
Hydraulic Pumps	393	Turbocharger Components.....	393
Hydrostat Components.....	393		

Crankshafts

Application	Description	Part Number	Retail Price	Core
Backhoe-Loaders: 480C, 580B, 580C, W3, W5A, Crawlers/Dozers: 310E, 310F, 310G, 350, 450 Replaces 976321, A39151, G11740, G11741	Crankshaft 188 4 Cylinder Diesel Engine 4.125" Stroke, 3.811" - 3.812" Bore, 2.0605" - 2.0615" Rod, 2.873" - 2.874" Main Flange - No Centering Ring, 4 Bolt Holes, Splined, Pilot Hole has 13 Splines Snout - Threaded, 2 Keyways	AMA151015	\$ 575.00	
Backhoe-Loaders: 480C, 580C, W3, W5A, Case® Crawlers/Dozers: 310E, 310F, 310G, 350, 450 Replaces A39151, A76321, A151015, G11740, G11741	Crankshaft 188 4 Cylinder Engine 4.125" Stroke, (Diesel) 3.811" - 3.812", (Gas) 3.813" - 3.8145" Bore, - 2.0605" - 2.0615" Rod, 2.873" - 2.874" Main Flange - No Centering, Flat, 4 Bolt Holes, w/ Bushing Snout - Threaded, 2 Keyways This Crankshaft is not Splined in Pilot Hole	AMA39150	\$ 575.00	
Backhoe-Loaders: 580C, 580D, Crawlers/Dozers: 350, 450, 450B Replaces 976321	Crankshaft 207 Non-Turbo 4 Cylinder Diesel Engine 4.125" Stroke, 4" - 4.001" Bore, 2.248" - 2.249" Rod, 2.873" - 2.874" Main Flange - No Centering Ring, 4 Bolt Holes Snout - Threaded, No Splines, 2 Keyways	AMA144011	\$ 575.00	
Backhoe-Loader: 580K Replaces 3903827, J908031, J918323	Crankshaft 4-390, 4B, 4BT, 4BTA - 239 CID 3.9 Liter 4 Cylinder Externally Balanced Cummins® Engines 4.724" Stroke, 4.0157"-4.0173" Bore, 2.716" - 2.717" Rod, 3.2672" - 3.2682" Main Flange - No Centering Ring, Flat, 8 Bolt Holes, 2 Dowels Snout - 4 Bolt Holes	AM3907803	\$ 620.00	
Wheel Loaders: 621, 621C, 721B, 721C, 821B, 821C	Crankshaft 6-590 Consolidated Diesel, 6B, 6BT, 6BTA - 5.9 Liter Externally Balanced Cummins® Engines 4.724" Stroke, 4.0157" - 4.0173" Bore, 2.716" - 2.717" Rod, 3.2672" - 3.2682" Main Flange - Flat, No Centering Ring, 8 Bolt Holes Snout - Straight, 4 Bolt Holes, No Keyways, No Splines	AM3907804	\$ 650.00	

Radiators

Application	Description	Part Number	Retail Price	Core
Backhoe-Loaders: 530CK Gas w/ Torque Converter or Diesel w/ Case-O-Matic®, 580CK w/ Power Shuttle BSN 8685801 or Diesel B Series w/ Power Shuttle	Radiator Overall: 26" x 19" Core: 18 1/4" x 18 1/8" x 1 3/4" 3 Rows, 8 Fins per Inch Oil Cooler Ports are on the Grille Side	AMA39345	\$ 400.00	
Backhoe-Loaders: 580, 580K, 580K-I, 580K-III, 580SK	Radiator	AMA172038	\$ 375.00	



Engine Fans

Application	Description	Part Number	Retail Price	Core
Excavators: CX210, CX240, CX290	Engine Fan 8 Blade, 6-Bolt Hub Replaces 87778091	AM278432A1	\$ 350.00	

Turbocharger Components

Application	Description	Part Number	Retail Price	Core
Crawlers/Dozers: (850E, 1150E, 1150G, 1155E - w/ Cummins® 6T-590 Engine), 850G, Excavator: 888 w/ Cummins® 6T-590 Engine, Wheel Loaders: (621B, 621C - w/ Cummins® 6T-590 Engine), (721B, 721 - w/ Cummins® 6TA-830 Engine), 721C, 821, 821B, 821C BSN JJE0155000	Turbo Supply Hose 21.1875" Long Replaces 71367996, J909548	AMJ918562	\$ 43.59	

Hydraulic Pumps

Application	Description	Part Number	Retail Price	Core
Graders: (845, 865 ASN 20100), 845 DHP, 845B, (865, 865B, 885, 885B - AWD), 865 VHP, 865B, 885 ASN 24101, 885B	Hydraulic Pump 90 cc	AM75323556	\$ 4250.00	
Wheel Loaders: 621D, 621E, 621F, 621G	Hydraulic Pump Replaces 377608A1, 75320405, 76082592	AM47773405	\$ 2103.00	
Wheel Loaders: 721D, 721E, 721F	Hydraulic Pump, Front 63 cc Replaces 8604947, 87435911	AM8602879	\$ 3210.00	
Wheel Loaders: 721D, 721E, 721F Non-Tier 4B	Hydraulic Pump, Rear 43 cc	AM8602880	\$ 2090.00	
Wheel Loaders: 821E, 821F, 821G	Hydraulic Pump, Front 43 cc Replaces 47777726	AM87332520	\$ 1950.00	
Wheel Loaders: 821E, 821F, 821G	Hydraulic Pump, Rear 65 cc Replaces 47777727	AM87332521	\$ 1695.00	
Wheel Loader: 921E	Hydraulic Pump, Front Replaces 87553127	AM84164303	\$ 3212.00	
Wheel Loader: 921E	Hydraulic Pump Replaces 87553128	AM84164304	\$ 4948.00	
Wheel Loaders: 1021F, 1021G, 1121G	Hydraulic Pump, Rear Replaces 84327051	AM48009612	\$ 2705.00	
Wheel Loaders: 1021F, 1021G, 1121F, 1121G	Hydraulic Pump, Front Replaces 84327082	AM48009611	\$ 2748.00	

Hydrostat Components

Application	Description	Part Number	Retail Price	Core
Backhoe-Loaders: (580N, 580N EP, 590SN - MY19), 580SN MY19 w/ Power Lift w/o Dual Batteries, 580SN WT MY19 Tier 3 w/ Power Lift, 580SN WT MY19 Tier 4 w/ Power Lift w/o Dual Batteries	Hydrostat Motor 71 cc Replaces 48041764, 84218968	AM84218965	\$ 2295.00	

Case®—Industrial / Construction

Rear Wheel Drive

Application	Description	Part Number	Retail Price	Core
Wheel Loaders: 21D, 21E, 121E, 221D Tier 2, 221E, 321D Tier 2 NA, 321E, Crawlers/Dozers: 650K, 650L, 650M LT, 650M WT, 750K, 750L, 850K, 850L	Hydraulic Wheel Motor 80 cc	AM401629A2	\$ 3960.00	

Case IH®—Tractor

Table of Contents

Air Cleaner Components	415	Mechanical Front Wheel Drive Parts	417
Air Conditioning and Components	469	MFWD Differentials and Components	423
Alternators	415	MFWD Driveshafts	426
Battery Box and Components	448	MFWD Hub Components	420
Belts	407	MFWD Hubs and Housings	417
Brakes and Components	438	Mufflers and Exhaust	413
Cab Components—Miscellaneous	461	Oil Coolers, Engine	402
Cab Doors	449	Oil Pumps, Engine	401
Cab Roofs	449	Overhaul Kits	397
Camshafts and Lifters	399	Power Steering Cylinders and Components	433
Clear View Cap Kits	476	Power Steering Orbit Motors	434
Connecting Rods	399	PTO Adapters	445
Crankshaft Damper Pulleys	399	PTO Assemblies and Components	436
Crankshafts	398	PTO Shafts	444
Cylinder Blocks, Bare	397	Quick Hitches	446
Cylinder Heads, Complete	400	Radiator Hoses	404
Drawbars	440	Radiators and Components	402
Fan Clutches	407	Rear Axle Components	438
Fenders, Platforms and Components	449	Remote Valves	441
Flywheel and Ring Gears	405	Rockshaft Components	445
Front Weights and Weight Brackets	448	Sensors	416
Fuel Components	408	Shift Kit and Components	401
Fuel Lift Pumps	407	Shortblock Assemblies	397
Gas Struts	467	Spindles and Steering Arms	428
Glass	463	Starters	414
Hammer Straps	440	Steps	449
Hoods and Grilles	448	Tachometers and Instrument Clusters	415
Hydraulic Lift Components	447	Tie Rods and Components	429
Hydraulic Oil Coolers	441	Toplink Assemblies and Components	447
Hydraulic Pumps and Components	442	Track Parts	475
Injection Pumps	409	Transmission Components	434
Injectors	408	Transmission Discs	435
Lift Link Assemblies and Components	445	Turbochargers	411
Lighting	449	Water Pumps and Components	405
Longblock Assemblies	395	Wheel Hubs	429
Lower Lift Links	469		
Manifold and Components	413		

Longblock Assemblies

Our remanufactured longblocks meet the highest standards in quality. All remanufactured components are inspected for structural integrity, cracks and dimensional specifications and then remanufactured back to OEM specifications. The components are then assembled using the highest quality new parts. We back this with one of the best warranties in the industry.



Application	Description	Part Number	Retail Price	Core
5120	Longblock Assembly Externally Balanced	LBCUM3.9TA-N	\$ 5100.00	\$ 1000.00
5140, 5240, 5250 - w/ 5.9 Turbo Engine	Longblock Assembly Replaces J920758, J286312	LBCUM5.9TA-N	\$ 6220.00	\$ 1000.00
7110, 7120, 7210 - w/ Cummins® 8.3T 6 Cylinder Engine	Reman Longblock Assembly Core charge includes similar block core only	LBCUM8.3T7220	\$ 8300.00	\$ 1500.00

Case IH®—Tractor

Application	Description	Part Number	Retail Price	Core
7130, 7140, 7150 - w/ 8.3T 6 Cylinder Cummins® Engine	Reman Longblock Assembly Core charge includes similar block core only	LBCUM8.3T1680	\$ 8300.00	\$ 1500.00
7230, 7240 - w/ Cummins® 8.3T 6 Cylinder Engine	Reman Longblock Assembly Core charge includes similar block core only	LBCUM8.3T1688	\$ 8700.00	\$ 1500.00
7250, 8950 - w/ Cummins® 8.3T 6 Cylinder Engine	Reman Longblock Assembly Core charge includes similar block core only Cast # - 3923275, 3926567, 3938058	LBCUM8.3T8950	\$ 8700.00	\$ 1500.00
7250, 8950 - w/ 8.3T 6 Cylinder Cummins® Engine	Reman Longblock Assembly w/ Auxiliary Hydraulic Pump in timing cover Core charge includes similar block core only	LBCUM8.3T8950AUX	\$ 8700.00	\$ 1500.00
8910, 8920, 8930, 8940 - w/ 8.3T 6 Cylinder Cummins® Engine	Reman Longblock Assembly Core charge includes similar block core only	LBCUM8.3T8940	\$ 8700.00	\$ 1500.00
8910, 8920, 8930, 8940 - w/ 8.3T 6 Cylinder Cummins® Engine	Reman Longblock Assembly w/ Auxiliary Hydraulic Pump in timing cover Core charge includes similar block core only	LBCUM8.3T8940AUX	\$ 8700.00	\$ 1500.00
MX100, MX135, MX150, MX170 - w/ Basic 5.9 Engine	Reman Longblock Assembly 4-Bolt Replaces J935583, J936257	LBCUM5.9TA-4B-N	\$ 5500.00	\$ 1000.00
MX240, MX255, MX270, MX285, STX275	Reman Longblock Assembly	LBCUM8304HPCR24V	\$ 11000.00	\$ 2000.00
Magnum®: 180, 190	New Engine, Complete 6.7 Liter, Tier 4 Replaces 84188409, 84385274, 84412177	AM5801425058	\$ 14500.00	\$ 5000.00
Magnum®: 190	New Engine, Complete 6.7 Liter, 195 HP Replaces 84144339, 84197590, 87732313	AM504371406	\$ 12500.00	\$ 5000.00
Magnum®: 225	New Engine, Complete 6.7 Liter, 225 HP	AM504371404	\$ 12500.00	\$ 5000.00
Magnum®: 225	Reman Engine, Complete 6.7 Liter, 225 HP Replaces 504371404ER	AM84197595ER	\$ 12500.00	\$ 5000.00
Maxxum®: 115	New Engine, Complete 6.7 Liter NEF 67 Replaces 50427568ER	AM87318901ER	\$ 11000.00	\$ 5000.00
Puma®: 115, 125, 145	New Engine, Complete 6.7 Liter NEF 67 Replaces 87312077ER, 87516256ER	AM87312078ER	\$ 12500.00	\$ 5000.00
MXU110	Reman Engine, Complete 4.5 Liter NF 45	AM87318785ER	\$ 8500.00	\$ 2500.00
Steiger®: 400, 500	New Engine, Complete Cursor 13, Tier 4, w/ Brake Replaces 84187143, 84250903, 5801509340	AM504384978	\$ 26500.00	\$ 7500.00

Case IH®—Tractor



Shortblock Assemblies

Our remanufactured shortblocks meet the highest standards in quality. All remanufactured components are inspected for structural integrity, cracks and dimensional specifications and then remanufactured back to OEM specifications. The components are then assembled using the highest quality new parts. We back this with one of the best warranties in the industry.

Application	Description	Part Number	Retail Price	Core
8.3T 6 Cylinder Cummins® Engine	Reman Shortblock Assembly	SBCU8.3TA	\$ 5700.00	\$ 1000.00

Cylinder Blocks, Bare

Application	Description	Part Number	Retail Price	Core
7110, 7120, 7130, 7140, 7150 - w/ 8.3 Cummins® Engine	Bare Cylinder Block	AM3971411	\$ 3250.00	



Overhaul Kits

Application	Description		Retail Price	Core
5130, 5230, Ind/Const: 680K, 680L, 850E, 855D, 855E, W14B, W14C	5.9 Engine - Diesel	Inframe Kit	\$ 535.00	
		Overhaul Kit	\$ 649.00	
MX100, MX110, MX120, MX135, MX150, MX170, Ind/Const: 621B, 621C, 850G, 1150G, Sprayers: Patriot 3150, SPX3150, SPX3185 Prior to 10/2002, Swathers: 8850 ASN CFH0099164, 8880	5.9 Engine - Diesel	Inframe Kit	\$ 504.00	
		Overhaul Kit	\$ 629.00	
5140, 5240, 5250, Ind/Const: 621, 621B BSN JEE053350, 680L, 780C, 780D, 850D, 850E, 850G BSN JYG0254015, 855D, 855E, 1150E, 1150G BSN JYG0218475, 1155E, W14B, W14C, Combine: 1620 ASN JJC0032629, Swather: 8850 BSN CFH0099165	5.9T Engine - Diesel	Inframe Kit	\$ 521.00	
		Overhaul Kit	\$ 626.00	
Combines: 1640 ASN JJC0034704, 1644 Engine BSN 44937696, Cotton Pickers: 1800, 1822 ASN JJC0012690, 2022	5.9TA Engine - Diesel	Inframe Kit	\$ 526.00	
		Overhaul Kit	\$ 602.00	
7110, 7120, 7130, 9110, 9210, Combine: 1660	8.3 Engine - Diesel Engine BSN 44500128	Inframe Kit	\$ 1140.00	
		Overhaul Kit	\$ 1280.00	
7110, 7120, 7130, 7210, (7220, 7230 BSN JJA0064978), 9210, 9310 BSN JEE0036501, Combines: 1660 ASN JJC0038346, 1666, 2166 BSN JJC0180000	8.3 Engine - Diesel Engine SN 44706126-45636465	Inframe Kit	\$ 1140.00	
		Overhaul Kit	\$ 1280.00	
7140, 7150, 9130, 9230, 9240, Combines: 1670, 1680, Cotton Pickers: 1844, 2044	8.3 Engine - Diesel Engine BSN 44706127	Inframe Kit	\$ 1140.00	
		Overhaul Kit	\$ 1280.00	
7140, 7150, (7240, 7250 BSN JJA064978), 9230, 9240, 9330 BSN JEE0036501, Combines: 1670, 1680, 1688, 2188 BSN JJC0191483, Cotton Pickers: 2055, 2155 BSN JJC0156230	8.3 Engine - Diesel Engine SN 44706126-45636465	Inframe Kit	\$ 1140.00	
		Overhaul Kit	\$ 1280.00	
(7220, 7230, 7240, 7250 ASN JJA0064977), 8910, 8920, 8930, 8940, 8950, (9310, 9330 ASN JJE0036500), MX180, MX200, MX220, Combines: 2166 ASN JJC0179999, 2188 ASN JJC0191482, 2366, 2388 BSN JJC0273001, Cotton Pickers: 2155 ASN JJC0156229, 2555	8.3 Engine - Diesel Engine SN 44706126-45636465, 12/1997 and Later	Inframe Kit	\$ 1140.00	
		Overhaul Kit	\$ 1280.00	

Prices Subject to Change without Prior Notice. The use of original equipment manufacturer (OEM) part numbers or trademarks, e.g. Case® and John Deere®, are for reference purposes only and for indicating product use and compatibility. Our company and the listed replacement parts contained herein are not sponsored, approved or manufactured by the OEM. All parts are New unless designated Reman in the description.

Case IH®—Tractor

Application	Description		Retail Price	Core
7220, 7230, 7240, 7250, 8910, 8920, 8930, 8940, 8950, MX180, MX200, MX220, Combines: 2366 BSN JJC0255701, 2388 BSN JJC0273001, Cotton Pickers: 2555, CPX420, Patriot Sprayer: SPX4260	8.3 Engine - Diesel Engine ASN 45636564, 12/1997 and Later	Inframe Kit	\$ 1140.00	
		Overhaul Kit	\$ 1280.00	

Crankshafts



Application	Description	Part Number	Retail Price	Core
For Case IH® Combines w/ L-10 Cummins® 6 Cylinder Engine	Crankshaft 5.354" Stroke, 4.9213" Bore, 3.1097" - 3.1107" Rod, 4.4888" - 4.4904" Main Flange - No Centering Ring, Flat, 8 Bolt Holes, 2 Dowel Holes Offset Snout - 5 Bolt Holes, 1 Keyway, w/ 40 Tooth Timing Gear, Right Hand Helix, Long Snout, External Damper	AM3819624	\$ 1750.00	
5120, 5220 Replaces 3903827, J908031, J918323	Crankshaft 4-390, 4B, 4BT, 4BTA - 239 CID 3.9 Liter 4 Cylinder Externally Balanced Cummins® Engines 4.724" Stroke, 4.0157"-4.0173" Bore, 2.716" - 2.717" Rod, 3.2672" - 3.2682" Main Flange - No Centering Ring, Flat, 8 Bolt Holes, 2 Dowels Snout - 4 Bolt Holes	AM3907803	\$ 620.00	
7110, 7120, 7130, 7140, 7150, 7210, 7220, 7230, 7240, 7250, Combines: 1660, 1666, 1670, 1680, 1688, 2166, 2188 Replaces 390562, 3917320, SE390136	Crankshaft 6-830 Consolidated Diesel, 6C, 6CT - 505 CID 8.3 Liter 6 Cylinder Cummins® Engines 5.315" Stroke, 4.4882" - 4.4897" Bore, 2.9916" - 2.9926" Rod, 3.8568" - 3.8588" Main Flange - Flat, 8 Bolt Holes, 1 Dowel Snout - Straight, 4 Bolt Holes	AM3917443	\$ 950.00	
JX1085C, JX1095C, MXU100, MXU110, Farmall®: 85C, 85U, 90, 95, 95C, 95U, 105U, Maxxum®: 100, 110, 120, 130 Replaces 2830396, 2831069, 2831335, 2831336, 2856774, 2859419, 4891107, 504240990	Crankshaft 4.5 Liter Engine Rear Gear Train, 6 Front Bolt Holes, 1 Dowel Hole, 8 Rear Bolt Holes	AM504359387	\$ 875.00	
MXU125, MXU130, MXU135, Maxxum®: 115, 125, 140, Puma®: 115, 125, 130, 140, 145, 155, 160, 165, 170, 180, 185, 195, 200, 210, 215, 230 Replaces 2830398, 2831071, 2831402, 2856281, 2856282, 2859446, 504347348	Crankshaft 6.7 Liter Mechanical Injection Engine	AM504203869	\$ 1565.00	
(STX380, STX430 SN Z6F100023-Z6F105001), Steiger®: 380, 385, 430, 435, 485, Combines: 7010, 8010, 9010, 9120	Crankshaft Cursor 13 Engine	AM99438979	\$ 2750.00	
Magnum®: 180, 190, 210, 225, Patriot Sprayers: 3230, 3330, SPX3320 Replaces 2852305, 2852306, 2856284, 504057570, 504057571	Crankshaft 6.7 Liter Electronic Engine	AM504203872	\$ 1265.00	
Combines: 1460, 1480	Crankshaft D436, DT436 - 436 CID 7.1 Liter 6 Cylinder Diesel Engines 5.040" Stroke Flange - Flat, 8 Bolt Holes Snout - Straight, 3 Bolt Holes, 1 Keyway	AM675051C1	\$ 1425.00	
Combines: 1640, 1644, 2144 Replaces 3929037, 3907604, 3908032	Crankshaft 6-590 Consolidated Diesel, 6B, 6BT, 6BTA - 5.9 Liter Externally Balanced Cummins® Engines 4.724" Stroke, 4.0157" - 4.0173" Bore, 2.716" - 2.717" Rod, 3.2672" - 3.2682" Main Flange - Flat, No Centering Ring, 8 Bolt Holes Snout - Straight, 4 Bolt Holes, No Keyways, No Splines	AM3907804	\$ 650.00	

Case IH®—Tractor



Connecting Rods

Application	Description	Part Number	Retail Price	Core
1640 BSN JJC0034705 w/ D466 Engine, 1660 BSN JJC0038346 w/ DT466B Engine, 1680 BSN JJC0045689 w/ DT1-466C Engine, Cotton Pickers: (1822, 1844 - w/ Navistar® Engine)	Connecting Rod	AM688923C91	\$ 128.50	
	Reman Connecting Rod Replaces 688923C91, 671659C1, 675640C91, 684294C91	AMCR688922-R	\$ 100.00	\$ 20.00
5120, 5130, 5140, 5220, 5230, 5240, 5250, Combines: 1644, 2144, 2344, Cotton Pickers: 1800, 2022, 2044 - All w/ 3.9, 3.9T, 3.9TA, 6-590, 6T-590 or 6TA-590 Engine	Connecting Rod	AMJ942581	\$ 86.00	
7110, 7120, 7130, 7140, 7150, 7210, 7220, 7230, 7240, 7250, 8910, 8920, 8930, 8940, 8950, 9110, 9130, 9210, 9230, 9240, 9310, 9330, MX180, MX200, MX210, MX220, MX230, MX240, MX255, MX270, MX285, STX275, STX325, Combines: 1660, 1666, 1670, 1680, 1688, 2166, 2188, 2366, 2388, Cotton Pickers: 1822 ASN JJC0012691, 1844 ASN JJC0002462, 2022, 2044, 2055, 2155, 2555, Patriot Sprayer: SPX4260, Power Units: 6830T, 6830TA, 6831T, 6831TA, PX190, PX215, PX240 - All w/Cummins® 6T-830 or 6TA-830 Diesel Engines	Connecting Rod	AMJ901383	\$ 67.71	
MX275, MX305, (STX275, STX325 - w/ 6TAA-9004 Engine), STX330, Magnum®: 275, 305, 335, Steiger®: 330, 335, Combine: 7088, Cotton Pickers: 620 Express, 625, Module Express, CPX620 ASN Y6T011701, Titan Floaters: 3020, 3520, 4020, 4520	Connecting Rod Bolt Replaces J944679	AM3944679	\$ 2.70	

Crankshaft Damper Pulleys

Application	Description	Part Number	Retail Price	Core
1896, 2096, 5130, 5140, 5230, 5240, 5250, MX100, MX110, MX120, MX150, MX170 - w/ 6BT, 6B5.9L, 6BT5.9L or 6BTA5.9L Engine	Crankshaft Damper Pulley 0.753" ID, 8.22" OD, 2.10" Thick Replaces 3914454, J911422, J914454	AMJ958258	\$ 120.00	
7110, 7120, 7130, 7140, 7150, 7210, 7220, 7230, 7240, 7250, 8910, 8920, 8930, 8940, 8950, 9310, 9330, Combines: 1666, 1688, 2166, 2188, 2366, 2388, Cotton Pickers: 420, 2055, 2155, 2555, Sprayer: SPX4260	Crankshaft Damper Pulley 2.24" Thick, 0.95" ID, 9.67" OD Replaces 39255568, J910907, J914456	AMJ925568	\$ 125.00	
MX180, MX200, MX215, MX220, MX240, MX245, MX270, MX275, MX285, Magnum®: 215, 245, 255, 275, Combines: 2366 ASN JJC0255700, 2377, 2388 ASN JJC0273000, 2577, 2588, Cotton Picker: 420 w/ Tier 3 Engine, Patriot Sprayers: 4420, SPX4410 - All w/ 6CT, 6CTA, 6CTAA or QSC 8.3 Liter Cummins® Engine	Crankshaft Damper Pulley Replaces 87773050, J910907, J914456	AMJ925570	\$ 95.00	
MXM120, MXM130, MXM140, MXM155	Crankshaft Damper Pulley 10 Spline, 13.701" OD, 1.575" Spline Diameter Replaces 5187845	AM87304267	\$ 392.00	
STX275, STX325 - w/ QSC 8.3 Liter Engine	Crankshaft Damper Pulley Replaces 6902058, 76192468, 76192723	AMJ925567	\$ 125.00	

Camshafts and Lifters



Application	Description	Part Number	Retail Price	Core
1440, 1460, 1470, 1480, 1640, Cotton Picker: 1822	Camshaft and Lifter Kit 0.996" Lifter Diameter Includes Gear, Key and Thrust Washer	AMCB1012	\$ 537.00	
5120, 5150, 5220, Swathers: 6000, 6500, 8820, 8825, 8825HP, 8830, 8840, 8860, 8860HP	Camshaft 3.9 Cummins® Engine	AMJ929039	\$ 95.00	

Prices Subject to Change without Prior Notice. The use of original equipment manufacturer (OEM) part numbers or trademarks, e.g. Case® and John Deere®, are for reference purposes only and for indicating product use and compatibility. Our company and the listed replacement parts contained herein are not sponsored, approved or manufactured by the OEM. All parts are New unless designated Reman in the description.

Case IH®—Tractor

Application	Description	Part Number	Retail Price	Core
5130, 5140, 5230, 5240, 5250	Camshaft 5.9 Cummins® Engine	AMJ929042	\$ 165.00	
7110, 7120, 7130, 7140, 7150, 7210, 7220, 7230, 7240, 7250	Camshaft 8.3 Cummins® Engine	AMJ917882	\$ 255.00	
5120, 5130, 5140, 5220, 5230, 5240, 5250, 7110, 7120, 7130, 7140, 7150, 7210, 7220, 7230, 7240, 7250, MX100, MX110, MX120, MX135, MX150, MX170, MX180, MX200, MX210, MX220, MX230	Lifter 3.9, 5.9 and 8.3 Cummins® Engines	AM3931623	\$ 8.00	
5120, 5130, 5140, 5220, 5230, 5240, 5250	Push Rod 4-390, 4T-390, 4TA-390, 6-590, 6T-590 and 6TA-590 Engines	AMJ923262	\$ 6.00	
7110, 7120, 7130, 7140, 7150, 7220, 7230, 7240, 8910, 8920, 8930, 8940, 8950, 9210, 9230, 9240, 9310, 9330, MX180, MX200, MX210, MX220, MX230, Combines: 1660, 1666, 1670, 1680, 1688, 2166, 2188, 2366, 2388, Cotton Pickers: 1822, 1844, 2022, 2044, 2055, 2155, 2555, CPX420, Sprayers: SPX4260	Push Rod 8.3 Cummins® Engine	AMJ905194	\$ 10.25	
4210, 7110, 7120, 7130, 7140, 7150, 7220, 7230, 7240, 7250, 8910, 8920, 8930, 8940, 8950, 9240, 9310, 9330, MX180, MX200, MX210, MX220, MX230, Combines: 1660, 1666, 1670, 1680, 1688, 2166, 2188, 2377, 2388, Cotton Pickers: 2022, 2044, 2055, 2155, 2555, Sprayer: SPX4260	Rocker Arm Assembly 12 Valve, 8.3 Cummins® Engine Includes (2) Rockers, Shaft and Mounting Blocks Replaces 3901717, J901717	AMX36278	\$ 30.00	
MX100, MX110, MX120, MX150, MX170, Cotton Pickers: 2022, 2044, 2144, 2344, Sprayers: SPX3150, SPX3185, SPX3200, SPX3208	Rocker Arm Assembly 3.9 and 5.9 Cummins® Engines Replaces J922488	AMJ910814	\$ 40.00	



Cylinder Heads, Complete

Application	Description	Part Number	Retail Price	Core
5120, 5220 - w/ 4T-390 or 4TA-390 Engine	Complete Cylinder Head w/ Valves Replaces 3933494	AMJ929736	\$ 715.00	
5130, 5140, 5230, 5240, 5250, Combines: 1640, 1644, 2144, Cotton Pickers: 1800, 2022, 2044 - All w/ 6-590, 6T-590 and 6TA-590 Engines	Complete Cylinder Head	AMJ917287WV	\$ 750.00	
7110, 7120, 7130, 7140, 7150, 7210, 7220, 7230, 7240, 7250, 9310, 9330 - w/ 8.3 Cummins® Engine	Complete Cylinder Head w/ Valves	AMJ925644	\$ 925.00	
7110, 7120, 7130, 7140, 7150, 7220, 7230, 7240, 8910, 8920, 8930, 8940, 8950, 9210, 9230, 9240, 9310, 9330, MX Series, STX Series, Combines: 1660, 1666, 1670, 1680, 1688, 2166, 2188, 2366, 2388 - All w/ 8.3 Cummins® Engine BSN 44487830	Head Bolt, 70 mm Long Head Bolt, 150 mm Long Only Fits Block Cast Numbers: 3905847, 3914018	AMJ907234 AMJ907233	\$ 7.30 \$ 7.60	
7110, 7120, 7130, 7140, 7150, 7220, 7230, 7240, 8910, 8920, 8930, 8940, 8950, 9210, 9230, 9240, 9310, 9330, MX Series, STX Series, Combine: 1660, 1666, 1670, 1680, 1688, 2166, 2188, 2366, 2388 - All w/ 8.3 Cummins® Engine ASN 44487830	Head Bolt, 80 mm Long Only Fits Block Cast Numbers: 3914255, 3920035, 3923275, 3926567, 3968602 Head Bolt, 160 mm long	AMJ917729 AMJ917728	\$ 4.25 \$ 6.70	

Case IH®—Tractor



Shift Kit and Components

This bolt-on kit alters the shift pattern so you can easily shift from high-reverse to 7th gear, eliminating shifting by the lower gears every time you change direction. The kit also makes the high-reverses available on older 2-reverse tractors.

Application	Description	Part Number	Retail Price	Core
7110, 7120, 7130, 7140, 7150, 7210, 7220, 7230, 7240, 7250, 8910, 8920, 8930, 8940, 8950 - w/ 2-Reverse Transmission	Shift Kit Includes shift plate cover, park lock lever, gear indicator decal and instructions This kit will allow you to shift from high reverse to 7th gear in one motion	AMX19133	\$ 450.00	
7110, 7120, 7130, 7140, 7150, 7210, 7220, 7230, 7240, 7250, 8910, 8920, 8930, 8940, 8950 - w/ 4-Reverse Transmission	Shift Kit Includes shift plate cover, park lock lever, gear indicator decal and instructions This kit will allow you to shift from high reverse to 7th gear in one motion	AMX19109	\$ 450.00	
7110, 7120, 7130, 7140, 7150, 7210, 7220, 7230, 7240, 7250, 8910, 8920, 8930, 8940, 8950	Shift Cable, Speed Selector	AM1343929C2	\$ 78.50	

Oil Pumps, Engine



Application	Description	Part Number	Retail Price	Core
Magnum®: 180, 190, 210, 225, Patriot Sprayers: 3230, 3240, 3330, 3340, SPX3320 - All w/ N67 6 Cylinder Engine	Engine Oil Pump	AM504047581	\$ 152.97	
5110, 5220 - w/ 3.9 Cummins® Engine	Engine Oil Pump	AMJ926202	\$ 70.00	
5130, 5140, 5230, 5240, 5250 - w/ 5.9 Cummins®	Engine Oil Pump	AMJ926303	\$ 120.00	
7210, 7220, 7230, 7240, 7250, 8910, 8920, 8930, 8940, 8950, 9210, 9230, MX180, MX200, MX220 - w/ 8.3 Cummins® Engine	Engine Oil Pump	AMJ930338	\$ 85.00	
C50, C60, CX50, CX60	Engine Oil Pump Idler Gear Not Included Replaces 41314078, 41314187	AM41314078	\$ 50.00	
MX210, MX230, MX240, MX255, MX270, MX285, STX275, STX325, Magnum: 255, Combines: 2366, 2377, 2388, Cotton Pickers: CPX610, CPX620, Floaters: FLX3010, FLX3300B, FLX3510, FLX4010, FLX4300, FLX4375, FLX4510, Sprayer: SPX4410	Engine Oil Pump Replaces 3948072, 87775216, J942723	AMJ948072	\$ 235.00	
MX215, MX245, MX275, MX305, STX280, STX330, Magnum®: 215, 245, Combines: 2377, 2388	Engine Oil Pump	AM3991123	\$ 146.28	
1620, 1640, 1644, 2144, 2344, Cotton Pickers: 1800, 1822 ASN JJC0012690, 1844, 2022, 2044, Patriot Sprayers: 3150, 3185, 3210, SPX3150, SPX3185, SPX3200, SPX3200B, SPX3310, Swathers: 8850, 8880, 8880HP	Engine Oil Pan Replaces J901288	AMJ915703	\$ 240.00	
(5130, 5140, 5230, 5240, 5250 - w/ 5.9 Cummins® Engine), Combines: (1620 ASN JJC0032629, 1640 ASN JJC0034704, 1644, 2144 - w/ 5.9 Cummins® Engine)	Oil Pump Pickup Tube Replaces J934942	AMJ909373	\$ 140.00	
(5120, 5220 - w/ 3.9 Cummins® Engine)	Oil Pump Pickup Tube	AMJ916790	\$ 40.00	
MX215, MX245, MX275, MX305, STX275, STX280, STX325, STX330, Magnum®: 215, 245, 275, 305, 335, Steiger®: 280, 330, 335, Combines: (2377, 2388 ASN HAJ0295001), 2577, 2588, 7088, Cotton Pickers: (420, 620 - Express), 625 Module Express, CPX420, CPX620 ASN Y6T011701, Floaters: FLX3010, FLX3510, FLX4010, FLX4510, Titan Floaters: 3020, 3520, 4020, 4520, Sprayer: SPX4410, Patriot Sprayer: 4420	Gasket, Oil Pump Pickup Tube Replaces 3914302, 87775049, A77583, J908540, J914302	AM87447959	\$ 3.00	
Cotton Picker: 1822, 1844	Oil Pan Drain Plug Replaces 445096	AM688067C1	\$ 5.00	

Case IH®—Tractor



Oil Coolers, Engine

Application	Description	Part Number	Retail Price	Core
Maxxum®: 110, 120, 130	Oil Cooler N45 Fiat Diesel, 5 Fins	AM2853722	\$ 139.54	
7110, 7120, 7130, 7140, 7150, 7210, 7220, 7230, 7240, 7250, 8910, 8920, 8930, 8940, 8950, 9210, 9230, 9240, 9330, MX180, MX200, MX210, MX220, MX230, MX255, MX270, MX285 - w/ 8.3 Cummins® Engine	Oil Cooler 12 Fins	AMJ918175	\$ 135.00	
STX280, STX330 SN Z6F100023-Z6F105001, Magnum®: 225, 250, 280, 310, 335, MX215, Steiger® 4WD: 280, 330, 335, Combines: (2377, 2388 SN HAJ292001-HAJ300000), Cotton Pickers: 420, 620, CPX620, Patriot Sprayer: 4420	Oil Cooler 8.9 Cummins®, 14 Fins	AM87452245	\$ 195.00	



Radiators and Components

Application	Description	Part Number	Retail Price	Core
Farmall®: 65A, 75A	Fan Shroud	AM87757220	\$ 16.00	
(Farmall®: 110A, 120A, 125A, 140A), MXU115, MXU125, MXU135	Radiator Outlet is right of center, 3/8" vent tube on top of tank, 5/8" vent tube on bottom of tank Replaces 82033774	AM87306756	\$ 1190.00	
Puma®: 115, 125, 140, 155	Radiator 6 Rows Replaces 87575996, 87575998, 87737096	AM87737098	\$ 890.97	
	Radiator Aluminum Core: 20.72" x 23.44" x 4.80" 4 Rows, 4.80 Fins per Inch Replaces 84160716, 87575998, 87737096	AM87575996	\$ 978.50	
Maxxum®: 125, 140	Radiator	AM87574213	\$ 871.18	
Magnum®: 235, 260, 290, 310, 315, 340, 380	Radiator Core: 20 1/2" x 24 7/8" x 5 1/4" 5 Rows, 10 Fins per Inch	AM84262310	\$ 1150.00	
Magnum®: 380	Radiator Core: 27 1/8" x 21" x 5 1/4"	AM47515718	\$ 1125.00	
5120, 5130, 5140, 5220, 5230, 5240, 5250	Radiator Core: 19 1/4" x 19 3/8" x 3 3/8" Replaces 104753A1	AM104753A2	\$ 375.00	
7110, 7120, 7130, 7140, 7150, (7210, 7220, 7230, 7240, 7250 BSN JJA0064978)	Radiator Overall: 28 5/8" x 32 5/8" Core: 28" x 26 1/2" x 3 1/4" 5 Rows, 8 Fins per Inch	AMA190663	\$ 750.00	
	Fan Shroud	AM1289320C1	\$ 195.00	
(7210, 7220, 7230 ASN JJA0064978), 8910, 8920, 8930	Radiator Core: 28 1/8" x 28 1/2" 5 Rows, 8 Fins per Inch	AM140501A2	\$ 945.00	
(7230, 7240 ASN JJA0064978), 7250 ASN JJA0064978, 8930, 8940, 8950, 4WD: 9310, 9330	Radiator Replaces 232545A1	AM131751A2	\$ 1340.00	
9170, 9270	Radiator Overall: 34" x 46 3/8" Core: 33" x 38 7/8" x 3 5/16" 6 Rows, 8 Fins per Inch	AM90-7647T1	\$ 2530.00	
C50, C60, C70, C80, C100, CX50, CX60, CX70, CX80, CX90, CX100, MX80C	Radiator Core: 17 5/8" x 21 5/8" x 3 3/8" 5 Rows, 9 Fins per Inch Replaces 222890A4, 222890A5, 222892A5, 239979A3, 303494A2	AM303495A2	\$ 595.00	
DX35, DX40, Farmall®: 40	Radiator Core: 17 5/8" x 16 3/4" x 1 7/8"	AM87305450	\$ 400.00	

Case IH®—Tractor

Application	Description	Part Number	Retail Price	Core
MX100, MX110, MX120, MX135, MX150, MX170	Radiator Core: 21 3/8" x 22 1/2" x 4"	AM135691A3	\$ 895.00	
MX180, MX200, MX220	Radiator Core: 20 7/8" x 20 9/16" x 3 7/8"	AM256325A1	\$ 1210.00	
MX210, MX230, MX255, MX285	Radiator Core: 20 1/4" x 28 5/8" x 4" Outlet Connection on Lower Left Grille Side Fan Shroud Replaces 87415556, 87415556I	AM417858A2 AM84269969	\$ 871.50 \$ 968.00	
MX275, MX305, Magnum®: 275, 305, 335	Radiator Overall: 23" x 29.50" x 4"	AM87390680	\$ 955.00	
MXM120, MXM130	Radiator Overall: 31" x 22 1/4" Core: 22 1/8" x 21" x 4"	AM87352188	\$ 1110.00	
MXM140, MXM155, MXU115, MXU125, MXU135	Radiator There is a 5/8" heater bypass connection to the right of the outlet connection Overall: 31" x 22 1/4" Core: 23 1/2" x 20 1/2" x 5"	AM87352191	\$ 1110.00	
(MXM175, MXM190 ASN ACM256706)	Radiator Core: 21 1/4" x 27 3/4" x 5" 7 Rows, 7 Fins per Inch Outlet is left of center Replaces 82033525, 82033792, 82038688, 87306754	AM87352193	\$ 810.00	
Steiger® 4WD: 450, 500, 550, 600, Quadtrac® 4WD: 470, 500	Radiator Overall: 32 3/16" x 53 1/2" Core: 32" x 45 1/2" x 5 3/16" 5 Rows, 10 Fins per Inch	AM84286669	\$ 2800.00	
Backhoe-Loaders: 480E, 480E LL, 480F, 480F LL, 580E, 580SE, 584E, 585E, 586E	Radiator Core: 19 1/4" x 19 3/8" x 2 1/8" 3 Rows, 8 Fins per Inch	AMA171080	\$ 330.00	
Utility: D25, D29, D33, DX25, DX29, DX33, DX35	Radiator Core: 15.50" x 15.75" x 1.75" Includes Bracket for Shield Screen w/ Remote Drain	AM86402723	\$ 578.00	
Utility: DX31, DX34, Farmall®: 31, 35	Radiator Core: 17.625" x 14.875" x 1.75" 2 Rows, 10 Fins per Inch	AM87305451	\$ 369.00	
Utility: D45, DX45	Radiator Core: 17.625" x 16.75" x 2.25" 2 Rows, 10 Fins per Inch	AM87305449	\$ 532.00	
Utility: DC35, DC40, DX35, DX40	Radiator Core: 17 3/8" x 14 3/4" 3 Rows Includes Cap Replaces 86400443, 86401465, 86402465	AM86402724	\$ 385.00	
Steiger® 4WD: 500, 550, 600, Quadtrac® 4WD: 450, 470, 500, 550, 600	Charge Air Cooler	AM84286668	\$ 2250.00	
385, 485, 3220, 3230, 4210, 4230, 4240	Radiator Cap w/ Cover Replaces 532029R1, 532029R2, 532672R91, 1500626C91	AM1500626C92	\$ 9.50	
650, 660, 5120, 5130, 5140, 5220, 5240, 5250, 7110, 7120, 7130, 7140, 7150, 7210, 7220, 7230, 7240, 7250, 8910, 8920, 8930, 8940, 8950, 9310, 9330, C50, C60, C70, C80, C90, C100, CX50, CX60, CX70, CX80, CX90, CX100, MX100, MX110, MX120, MX135	Radiator Cap 16 PSI, Fits 3/4" Deep Neck, w/ Drop-Type Vacuum Valve Replaces Replaces 87774949, A171919, L302981	AMA170241	\$ 5.50	
2090, 2094, 2290, 2294, 2394, 2594, 3294, 3394, 3594, 4494, 4694, 4894, 4994, (8910, 8920, 8930, 8940, 8950 - w/ Deaeration System)	Radiator Cap 10 lbs Pressure Replaces A149609	AMA166776	\$ 10.59	

Case IH®—Tractor

Application	Description	Part Number	Retail Price	Core
JX55, JX60, JX65, JX70, JX70U, JX75, JX80, JX80U, JX85, JX90, JX90U, JX95, JX95HC, JX100U, JX1060C, JX1070C, JX1070N, JX1070U, JX1075C, JX1075N, JX1080U, JX1085C, JX1090U, JX1095C, JX1095N, JX1100U, Farmall®: 45A, 55A, 60, 65A, 65C, 70, 75A, 75C, 75N, 75N, 80, 85C, 85N, 90, 95, 95C, 95N, 95U, 105N, 105U, 105V	Rubber Mount	AM5108225	\$ 8.00	
MXM120, MXM130, MXM140, MXM155, MXM175, MXM190, Farmall®: 85C, 95C, 105C, 115C, Magnum®: 180, 200, 220, 240, 260, 290, 310, 315, 340, 370, 380, Steiger®: 350, 370, 380, 385, 400, 420, 430, 435, 450, 470, 485, 500, 540, 550, 580, 620, STX380, STX430, Steiger® Quadtrac®: 370, 420, 450, 470, 500, 540, 580, 620	Coolant Temperature Sensor	AM82017881	\$ 26.40	

Radiator Hoses



Application	Description	Part Number	Retail Price	Core
235	Radiator Hose, Upper 1.25" & 1.375" ID	AM1275081C1	\$ 13.70	
245, 255, 265	Radiator Hose, Upper 1.25" & 1.437" ID	AM1962545C1	\$ 22.33	
(585, 595, 685, 695, 885, 895 - w/ A/C), (3220, 3230, 4210, 4230 BSN JJE0910720)	Radiator Hose, Upper 1.75" & 2" ID	AM84496C1	\$ 14.71	
585, 595, 685, 695, 885, 895, 995 - w/o A/C	Radiator Hose, Upper	AM402207R1	\$ 15.44	
995 w/ A/C, (3220, 4240 BSN JJE0910720)	Radiator Hose, Upper 1.75" & 2" ID	AM1536489C1	\$ 14.14	
1440, 1460, 1470, 1480, 1640 BSN JJC0034705, 1660 BSN JJC0038346	Radiator Hose, Upper 2", 2.25" ID Replaces 548216C1	AM548216R1	\$ 25.71	
5120, 5130, 5140, 5220, 5230, 5240, 5250	Radiator Hose, Upper 1.75" ID	AMT103198	\$ 19.50	
7110, 7120, 7130, 7140, 7150, (7210, 7220, 7230, 7240, 7250 BSN JJA0064978)	Radiator Hose, Upper 2.25" ID Replaces 1998729C1	AM1289072C1	\$ 22.04	
(7210, 7220, 7230, 7240, 7250 ASN JJA0064977), 8910, 8920, 8930, 8940, 8950	Radiator Hose, Upper 2.312" ID	AM184299A1	\$ 45.22	
MX100, MX110, MX120, MX135, MX150, MX170	Radiator Hose, Upper 1.73" & 2.25" ID	AM141569A2	\$ 21.41	
235	Radiator Hose, Lower 1.062" & 1.375" ID	AM1269609C1	\$ 17.10	
265	Radiator Hose, Lower 1.25" & 1.40" ID	AM1963544C1	\$ 19.75	
275	Radiator Hose, Lower 1.312" & 1.375" ID	AM1961831C1	\$ 33.16	
(585, 595, 885, 995 - w/ A/C or Tropical Cooling), 685, 695, (3220, 3230, 4210, 4230, 4240 BSN JJE0910720)	Radiator Hose, Lower	AM84497C2	\$ 21.08	
5120, 5130, 5140, 5220, 5230, 5240, 5250	Radiator Hose, Lower 2.25" ID	AMT103197	\$ 16.50	
7110, 7120, 7130, 7140, 7150, (7210, 7220, 7230, 7240, 7250 BSN JJA0064979)	Radiator Hose, Lower 2.25" ID Replaces 1334477C1	AM252305A1	\$ 10.13	
(7210, 7220, 7230, 7240, 7250 ASN JJA00649787), 8930, 8940	Radiator Hose, Lower	AM186489A1	\$ 18.39	
8910, 8920, 8930, 8940, 8950	Radiator Hose, Lower 2.312" & 2.625" ID Replaces 186489A1, 235912A1, 235912A2	AM254335A1	\$ 22.70	

Case IH®—Tractor

Application	Description	Part Number	Retail Price	Core
MX100, MX110, MX120, MX135, MX150, MX170	Radiator Hose, Lower 2.25" ID	AM141570A1	\$ 14.02	
(Farmall 65A, Farmall 75A - Prior to 09/2018)	Radiator Hose, Lower	AM87473908	\$ 12.00	
DX55	Bypass Hose 0.54" ID Replaces 83966732, 87772767, 87780789	AMSBA145536051	\$ 6.39	

Flywheel and Ring Gears

Application	Description	Part Number	Retail Price	Core
884 ASN 9397, 885, 885XL, 895, 895XL, 4230, 424	Flywheel Use w/ 12" Clutch	AM1808413C92	\$ 936.53	
4230, 4240	Flywheel Ring Gear 128 Tooth, 0.5625" Wide, 4.625" ID, 16.125" OD	AM3218637R1	\$ 138.42	
5120, 5130, 5140, 5220, 5230, 5240, 5250	Torque Limiter Pressure Plate	AMA159102	\$ 113.45	
7110, 7120, 7130, 7140, 7150, 7210, 7220, 7230, 7240, 7250, 7288, 8910, 8920, 8930, 8940, 8950	Drive Plate 13 Spline, 13.87" OD Replaces 92590C1, 92590C2, 1251902C1, 1251902C2, 184429C1, 188013C91, 230233A1	AM184429C2	\$ 135.00	



Water Pumps and Components

Application	Description	Part Number	Retail Price	Core
Farmall®: 85C, 85U, 90, 95, 95C, 95U, 105U, Maxxum®: 100, 110, 120, 125, 130, 140	Water Pump w/o O-Ring Seal	AM2852114	\$ 60.00	
Magnum®: 180, 190, 210, 225, 110, 115, 120, 125, 130, 140, Puma®: 115, 125, 130, 140, 145, 155, 160, 165, 170, 180, 185, 195, 200, 210, 215, 225, 230	Water Pump	AM2854835	\$ 75.00	
1440	Water Pump Includes Mounting Gasket Replaces 673623C92, 677415C93	AM673623C91	\$ 120.00	
5120, 5130, 5140, 5220, 5230, 5240, 5250 - w/ 4-390, 4T-390, 4TA390, 6-590, 6T590 or 6TA590 Engine	Water Pump	AMJ802970	\$ 55.13	
	Bearing, Support Assembly	AMJ910739	\$ 51.50	
5120, 5130, 5140, 5220, 5230, 5240, 5250, MX100, MX110, MX120, MX135, MX150, MX170, Combines: 1620, 1640, 1644, 2144, 2344, Cotton Pickers: 1800, 1822 ASN JJC0012690, 1844, 2022, 2044, Patriot Sprayers: 3150, 3185, 3210, SPX3150, SPX3185, SPX3200B	Thermostat Housing Replaces J903756	AMJ914409	\$ 57.00	
7110, 7120, 7130, 7140, 7150, 8910, 8920, 8930, 8940, 8950, 9110, 9130, 9210, 9230, 9240, 9250, 9260, MX180 - w/ 6T830 or 6TA830 Engine	Water Pump Replaces A77704	AMJ802975	\$ 72.06	
	Bearing, Support Assembly	AMJ910739	\$ 51.50	
C80, C90, C100, CX80, CX90 BSN JJE1008568, CX100	Water Pump Includes Mounting Gasket	AM293515A1	\$ 94.00	
C80, C90, C100, CX80, CX90, CX100, MX80C, MX90C ASN JJE1008569, MX100C	Water Pump Includes Mounting Gasket	AM311781A1	\$ 154.00	
C100, CX100	Water Pump w/o Pulley Includes Mounting Gasket	AMU5MW0106	\$ 76.00	
CX50, CX60, C50, C60	Water Pump Includes Mounting Gasket Replaces 4131A051, 4222656M91, 4224105M91	AM365375A1	\$ 152.00	

Case IH®—Tractor

Application	Description	Part Number	Retail Price	Core
D33, D35, D40, D45, DX31, DX33, DX34, DX35, DX40, DX45, DX48, DX55, DX60, Farmall®: 31, 35, 40, 45, 45A, 45B, 50, 55, 55A	Water Pump	AMSBA145017790	\$ 151.52	
MX210, MX230, MX240, MX255, MX270, MX285, STX275, STX325, Combines: 2366, 2388, Cotton Picker: CPX610, Sprayer: SPX4410	Water Pump Replaces 87308650, 87774990, J940052	AMJ804927	\$ 80.00	
MX215, MX245, MX275, MX305, Magnum®: 215, 245, 255, 275, 305, 335	Water Pump Replaces 86993431	AM87453208	\$ 142.00	
MXM120, MXM130	Water Pump Replaces 87384587	AM87802491	\$ 275.00	
MXM120, MXM130, MXM140, MXM155, MXM175, MXM190	Water Pump w/o O-Ring Seal w/ Dual Serpentine Pulley, Threaded Hub for Fan Clutch	AM87384588	\$ 100.00	
MXM140, MXM155, MXM175, MXM190	Water Pump Replaces 87384586	AM87802490	\$ 245.00	
(STX380, STX430 SN Z6F100023-Z6F105001), Steiger®: (80, 430 ASN Z6F105001), 385, 435, 485, Combines: 8010, 8120, AFX8010	Water Pump Replaces 504079715	AM504102491	\$ 110.00	
Combines: 715, 1420, 1440, Cotton Stripper: 9000 - All w/ D310 or D358 Engine	Water Pump w/ Hub	AM3132676R93	\$ 80.00	
Combines: 151, 181, 303, 403, 615, 715	Water Pump Gas Engines - C221, C263, C291, C301 Diesel Engines - D166, D188, D236, D282 Replaces 534270R91, 701128C94	AM601816C92	\$ 90.00	
Utility: D25, D29, DX25, DX29	Water Pump Includes Mounting Gasket Replaces 87761849, SBA145016891, SBA145017660	AMSBA145017661	\$ 120.00	
7110, 7120, 7130, 7150, 7210, 7220, 7230, 7240, 7250, 8910, 8920, 8930, 8940, 9210, 9230, 9240, 9310, MX180, MX200, MX220, Cotton Pickers: 2022, 2044, 2055, 2155, 2555, CPX420, Sprayer: SPX4260	Water Elbow Hose 1.875" & 2.28" ID	AMJ920762	\$ 12.57	
5120, 5130, 5140, 5220, 5230, 5240, 5250, 7110, 7120, 7130, 7140, 7150, 7210, 7220, 7230, 7240, 7250, 8910, 8920, 8930, 8940, 8950, 9110, 9130, 9210, 9230, 9240, 9250, 9260, 9310, 9330, MX100, MX110, MX120, MX135, MX150, MX170, MX180, MX200, MX220, Combines: 1620, 1640, 1660, 1666, 1680, 1688, 2144, 2166, 2188, 2344, 2366, 2388	Belt Tensioner	AM87326910	\$ 50.00	
MXM120, MXM130, MXM140, MXM155, MXM175, MXM190	Belt Tensioner	AM87801838	\$ 108.45	
MX210, MX230, MX240, MX255, MX270, MX285, STX275, (STX280, STX330 SN Z6F100023-Z6F105001), STX325, Steiger®: (280, 330 ASN Z6F105001), 335, Combines: 2366 ASN JJC0255700, 2377 SN HAJ0292001-HAJ0300000, 2388, Cotton Pickers: CPX610, CPX620, Sprayer: SPX4410 Replaces 87409564, 87775209, J934819, J945527, J945849	Belt Tensioner	AM87436755	\$ 78.00	
MXU100, MXU110, MXU115, MXU125, MXU130, MXU135, Maxxum®: 100 w/ Tier 3 Limited, (110, 115, 125 - w/ Tier 3 Value, Limited and Pro), (120, 130 - w/ Tier 3 Pro), 140 w/ Tier 3 Limited and Pro, Puma®: 115, 125, 140, 155	Belt Tensioner Replaces 2852161, 2853680, 2854611, 2855622, 2856687, 87415847, 87415848, 87803067	AM504028028	\$ 78.50	
Combines: 2377, 2388, 2577, 2588, 5088, 6088, 7088, Cotton Pickers: 420, 620, 625	Belt Tensioner	AM87317615	\$ 165.00	

Case IH®—Tractor



Fan Clutches

Application	Description	Part Number	Retail Price	Core
7110, 7120, 7130, 7140, 7150, 7220, 7230, 7240, 7250	Fan Clutch Assembly Replaces 102422A1, A173943	AM442985A1	\$ 675.00	
C70, C80, C90, C100, CX90, CX100, MX80, MX90, MX100	Fan Clutch Assembly Replaces 226165A3	AM226165A2	\$ 145.00	
CX70, CX80, MX80C	Fan Clutch Assembly	AM246462A2	\$ 359.30	
MX100, MX110, MX120, MX135	Fan Clutch Assembly	AM188922A1	\$ 105.00	
MX150, MX170	Fan Clutch Assembly	AM283132A1	\$ 120.00	
MXM120, MXM130, MXM140, MXM155, MXM175, MXM190	Fan Clutch Assembly	AM82025803	\$ 360.00	
MX215, MX245, MX275, MX305, Magnum®: 215, 245, 255, 275, 305	Fan Clutch Assembly	AM87446414	\$ 287.00	
7110, 7120, 7130, 7140, 7150, (7210, 7220, 7230, 7240, 7250 BSN JJA0064978), 8910*, 8920*, 8930*, 8940*, 8950*, MX180, MX200, MX210, MX220, MX230, MX240, MX255, MX270, MX285 *Must also purchase 87022278 Spacer	Fan Adapter Replaces Fan Clutch	AMX36273	\$ 160.00	
(Farmall 65A, Farmall 75A - Prior to 09/2018)	Fan 6 Blade	AM87479461	\$ 66.00	
MX180, MX200, MX220, MX240, MX255, MX270, MX285	Fan 8 Blade, 6-Bolt Hub Replaces 87778091	AM278432A1	\$ 350.00	
5120, 5130, 5140, 5220, 5230, 5240, 5250, MX100, MX110, MX120, MX135, MX150, MX170, Cotton Pickers: (2022, 2044 - w/ 6TA-590 Cummins® Engine)	Fan Pulley Support Replaces 5261322, 84585624, J911205	AM87428288	\$ 204.00	
7110, 7120, 7130, 7140, 7150, 7210, 7220, 7230, 7240, 7250, 8910, 8920, 8930, 8940, 8950, 9110, 9130, 9210, 9230, 9240, 9310, 9330, MX180, MX200, MX210, MX220, MX230, MX240, MX270, STX275, STX280, STX325, STX330, Steiger®: 280, 330, 335, Combines: 1660, 1666, 1670, 1680, 1688, 2166, 2188, 2366, 2388, Cotton Pickers: (420, 620, 2055, 2155, 2555 - Express), 625 Module Express, 1822, 1844, 2022, 2044, CPX610, CPX620	Fan Pulley Support	AMJ942896	\$ 141.50	
(Farmall 65A, Farmall 75A - Prior to 09/2018)	Fan Drive Spacer	AM87479460	\$ 17.00	

Belts

Application	Description	Part Number	Retail Price	Core
Farmall®: 75C	Fan Belt	AM47497868	\$ 37.87	
	A/C Compressor Belt	AM47408660	\$ 16.97	
7110, 7120, 7130, 7140, 7150	Fan Belt, Alt / Gen Belt, Water Pump	AMJ911567	\$ 31.01	
	A/C Compressor Belt	AM131403C1	\$ 16.00	
MX255, MX285	Fan Belt, Alt / Gen Belt, Water Pump	AM87402831	\$ 33.75	
MXM120, MXM130, MXM140, MXM155, MXM175, MXM190	Belt Tensioner	AMAH155348	\$ 75.00	

Fuel Lift Pumps



Application	Description	Part Number	Retail Price	Core
5120, 5130, 5140, 5220, 5230, 5240	Fuel Lift Pump Replaces 3904374, J904374	AMJ928143	\$ 28.50	
8930, 8940, 8950, (MX180, MX200, MX220 ASN JJA0105000), MX210, MX230, Combines: 2366 ASN JJC0255700, 2388 ASN JJC0273000 - All w/ 6T-830 or 6TA-830 Cummins® Diesel Engine	Fuel Lift Pump	AMJ936316	\$ 71.00	

Prices Subject to Change without Prior Notice. The use of original equipment manufacturer (OEM) part numbers or trademarks, e.g. Case® and John Deere®, are for reference purposes only and for indicating product use and compatibility. Our company and the listed replacement parts contained herein are not sponsored, approved or manufactured by the OEM. All parts are New unless designated Reman in the description.

Case IH®—Tractor

Application	Description	Part Number	Retail Price	Core
MX240, MX255, MX270, MX285	Fuel Lift Pump Replaces J944386, J945502	AM87585287	\$ 545.00	
JX1070U, JX1080U, JX1085C, JX1090C, JX1090U, JX1100U, MXU100, MXU110, MXU115, MXU130, Farmall®: 60, 65A, 65C, 70, 75A, 75C, 75N, 80, 85C, 85N, 85U, 90, 95, 95C, 95N, 95U, 105N, 105U, 105V, 110A, 120A, Maxxum®: 100, 110, 115, 125, 140, Ind/Const: 586G	Fuel Lift Pump Replaces 84268475, 84269570, 504146090	AM2830266	\$ 36.00	
MXM120, MXM130, MXM140, MXM155, MXM175, MXM190	Fuel Lift Pump	AM87802238	\$ 77.00	
7110, 7120, 7130, 7140, 7150, 7210, (7220, 7230, 7240, 7250 BSN JJA0064978), 9110, 9130, 9210, 9230, 9240, (9310, 9330 BSN JEE0036001), Ind: 570MXT, 580M, 580SM, 585G, 586G, 588G, 590SM	Fuel Transfer Pump Replaces 87473337, J917998	AM87648717	\$ 80.00	
MX100, MX110, MX120, MX135, MX150, MX170	Fuel Transfer Pump 2-hole mount w/ manual priming plunger Gasket not included Replaces 87473338	AMJ936317	\$ 66.00	
5120, 5130, 5140, 5150, 5220, 5230, 5240, 5250	Fuel Primer Pump Replaces 3914319	AM3918000	\$ 62.50	

Fuel Components

Application	Description	Part Number	Retail Price	Core
MX100, MX110, MX120, MX135	Fuel Tank	AM243275A4	\$ 1050.00	
MX180, MX200, MX210, MX220, MX230, MX240, MX255, MX270, MX285	Fuel Tank Replaces 255029A3, 255029A4, 87773724	AM255029A5	\$ 665.00	
MX180, MX200, MX210, MX215, MX220, MX240, MX255, MX270, Magnum®: 225, 250, 255, 280, 310, 335	Deaeration Reservoir Replaces 294547A1	AM87413715	\$ 224.00	
Loaders: 521D, 821C - w/ 4BT Cummins® Engine	Fuel Pump Shut Off 24 Volt Replaces 3991168, J991168	AM87420953	\$ 89.00	
Steiger®: 500	Fuel Cooler Core: 41 1/4" x 5" x 1/2"	AM84377883	\$ 420.00	
Steiger®: 420, 470, 500, 540, 580, 620, Quadtrac®: 420, 470, 500, 540, 580, 620	Sensor, Fuel Pressure	AM5801567640	\$ 200.00	
7110, 7120, 7130, 7140, 7150, 7210, 7220, 7230, 7240, 7250, 8910, 8920, 8930, 8940, 8950	Fuel Tank Hose 1.625" ID	AM97013C1	\$ 32.92	

Injectors

Our remanufactured injectors are disassembled and thoroughly cleaned. The internal components are lapped to ensure there is no leakage. All tips are inspected for hole erosion and opening pressure; and the spray pattern is tested using OEM specifications.



Application	Description	Part Number	Retail Price	Core
MX100, MX110, MX120, MX135, MX150, MX170, Combines: 2144, 2344, Backhoe-Loaders: 580 Super L, 580 Super M, 590 Super L, 590 Super M	Injector	AMJ929490	\$ 40.00	
5120, 5130, 5140, 5220, 5230, 5240, 5250, Ind/Const: 580SK, 590, 621B, 650G, 850E, 850G, 855E, 1150E, 1150G, 1155E, Excavators: 688, 1088, 9010, 9010B, 9020, 9020B, 9030, 9030B	Fuel Injector, 7 mm Tip	AMJ919343	\$ 45.00	
5130, 5230, 5240, 5250	Fuel Injector, 7 mm Tip	AMJ919304	\$ 50.00	
5130, 5230, 5240, 5250	Fuel Injector, 9 mm Tip	AMJ914474	\$ 54.50	
7130, 7140, 7150, 7230, 7240, 7250	Injector, 14 mm Inlet	AMJ919602	\$ 55.00	
7110, 7120, 7130, 7140, 7150, 7210, 7220, 7230, 9110, 9130, 9210, 9230, 9310, 9330, Combines: 1666, 2166 - All w/ 6T-830 Engine	Injector, 12 mm Inlet	AMJ908507	\$ 50.00	

Case IH®—Tractor

Application	Description	Part Number	Retail Price	Core
7220, 7230, 7240, 7250, 8910, 8920, 8930, 8940, 8950, 9310, 9330, MX180, MX200, MX220, Combines: 2166, 2188 - All w/ Emission Certified Engine	Injector	AMJ930525	\$ 45.00	
7240, 9310, 9330 - w/ 6TA-830 Engine	Injector, 12 mm Inlet	AMJ908511	\$ 45.00	
7250, 8950, MX200, MX220, Combine: 2188, Cotton Pickers: 2155, 2555 - All w/ Emission Certified Engine	Injector	AMJ926787	\$ 60.00	
Combine: 2388	Reman Injector Replaces J931735	NKBAL-155P270	\$ 55.00	\$ 35.00
Combines: 1440, 1460, 1470, 1480, 1482, 1640 BSN JJC0034705, 1660 BSN JJC0038346, 1670, 1680 BSN JJC0045689, Cotton Pickers: 1822, 1844 - All w/ D312, D360, D414, DT414, D436, DT436, D466 and DT466 Engines	Injector Sleeve	AM675442C1	\$ 8.00	

Injection Pumps

All of our injection pumps are disassembled, thoroughly cleaned and inspected. All worn out parts are replaced and the pumps are reassembled with new gaskets. Pumps are tested for leaks and fuel delivery at low idle, high idle, full load, part load and at start up. Any pumps with an automatic advance system has the advance set. As an additional quality check, all pumps are tested with a special oil that will not varnish inside the pump.

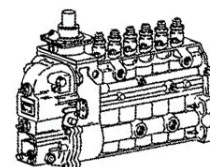

Application	Description	Part Number	Retail Price	Core
5120 Early w/ Aneroid	Reman Injection Pump Bosch # - 0460 424 068 Mfg # - VE4 12F 1100R 391 Replaces 3917526	AMP5120E	\$ 975.00	\$ 200.00
5120 Late w/o Aneroid, 5220 w/ Aneroid	Reman Injection Pump Bosch # - 0460 424 056 Mfg # - VE4 12F1100R 370 Replaces 3917934	AMP5220	\$ 1075.00	\$ 200.00
5130, 5230 - Early w/ Electric Shutoff	Reman Injection Pump Mfg # - DPA 3363F860 Replaces 3916803	AMP5230E	\$ 1075.00	\$ 200.00
5130, 5230 - Late w/ Electric Shutoff	Reman Injection Pump Mfg # - DPA 3369F180 Replaces 3923593	AMP5230L	\$ 1075.00	\$ 200.00
5140, 5240	Reman Injection Pump Bosch # - 0460 426 140 Mfg # - VE6 12F1100R 371 Replaces 3917935	AMP5240	\$ 1075.00	\$ 200.00
5150 w/ Aneroid	Reman Injection Pump Bosch # - 0460 427 217 Mfg # - VE6 12F1100R 512 Replaces 3924983	AMP5150	\$ 975.00	\$ 200.00
5250	Reman Injection Pump Bosch # - 0460 426 201 Mfg # - VE6 12F11R 371-2 Replaces 3921906	AMP5250	\$ 1075.00	\$ 200.00
7110	Reman Injection Pump Bosch, Mfg # - PES6A100D320/3RS2691 Pump # - 9400 230 109	AMP7110-PES	\$ 1600.00	\$ 200.00
7120	Reman Injection Pump Bosch, Mfg # - PES6A100D320/3RS7691 Pump # - 9400 230 111	AMP7120-PES	\$ 1600.00	\$ 200.00
7130	Reman Injection Pump Bosch, Mfg # - PES6A100D320/3RS2691 Pump # - 9400 230 110	AMP7130-PES	\$ 1600.00	\$ 200.00
7140	Reman Injection Pump Bosch, Mfg # - PES6MW100/120RS1137-1 Pump # - 0403 466 113	AMP7140-PES	\$ 1600.00	\$ 200.00

Case IH®—Tractor

Application	Description	Part Number	Retail Price	Core
7210	Reman Injection Pump Bosch, Mfg # - PES6A100D320/3RS2691 Pump # - 0400 866 212	AMP7210-PES	\$ 1600.00	\$ 200.00
7220	Reman Injection Pump Bosch, Mfg # - PES6A100D320/3RS2641 Pump # - 0400 866 181	AMP7220-PES	\$ 1600.00	\$ 200.00
7230	Reman Injection Pump Bosch, Mfg # - PES6MW100/120RS1238 Pump # - 0403 466 154	AMP7230-PES	\$ 1600.00	\$ 300.00
7240	Reman Injection Pump Bosch, Mfg # - PES6MW100/120RS1137	AMP7240-PES	\$ 1600.00	\$ 300.00
7250	Reman Injection Pump Bosch, Mfg # - PES6NB110B120RND057 Pump # - 092000-057	AMP7250-PES	\$ 1925.00	\$ 700.00
8910	Reman Injection Pump Bosch, Mfg # - PES6MW 1238, 0 403 466 176 Replaces JR931934	AMP8910-PES	\$ 1775.00	\$ 550.00
8920	Reman Injection Pump Bosch, Mfg # - PES6MW1238, 0 403 466 152 Replaces JR926878	AMP8920-PES	\$ 1775.00	\$ 550.00
8930	Reman Injection Pump Bosch, Mfg # - PES6MW1240, 0 403 466 161 Replaces JR926882	AMP8930-PES	\$ 1775.00	\$ 550.00
8940	Reman Injection Pump Small DVH Bosch, Mfg # - PES6MW100/120RS1242, 0 403 466 169 Replaces JR935106	AMP8940-PES	\$ 1775.00	\$ 550.00
8950	Reman Injection Pump Bosch, Mfg # - PES6P 3353, 0 402 036 762 Replaces JR926776	AMP8950-PES	\$ 1895.00	\$ 550.00
MX100	Reman Injection Pump Bosch, Mfg # - PES6A 2881 /3932476, F002AOZ041 Replaces JR932476	AMPMX100-PES	\$ 1775.00	\$ 550.00
MX110	Reman Injection Pump Bosch, Mfg # - PES6A 2881, 3932477, F002AOZ042 Replaces JR932477	AMPMX110-PES	\$ 1775.00	\$ 550.00
MX120	Reman Injection Pump Bosch, Mfg # - PES6A 2881, 3932478, F002AOZ043 Replaces JR932478	AMPMX120-PES	\$ 1775.00	\$ 550.00
MX135	Reman Injection Pump Bosch, Mfg # - PES6A 2881, 3932479, F002AOZ039 Replaces JR932479	AMPMX135-PES	\$ 1775.00	\$ 550.00
MX150	Reman Injection Pump Bosch, Mfg # - PES6A 2881, 3933621, F002AOZ070 Replaces JR933621	AMPMX150-PES	\$ 1775.00	\$ 550.00
MX170	Reman Injection Pump Bosch, Mfg # - PES6A 2881, F002AOZ069 Replaces JR933623	AMPMX170-PES	\$ 1775.00	\$ 550.00
MX180	Reman Injection Pump Bosch, Mfg # - PES6MW 1238, 0 403 466 181 Replaces JR930526	AMPMX180-PES	\$ 1895.00	\$ 550.00

Case IH®—Tractor

Application	Description	Part Number	Retail Price	Core
MX200	Reman Injection Pump Bosch, Mfg # - PES6P 3431, 0 402 066 716 Replaces JR93053	AMPMX200-PES	\$ 1950.00	\$ 750.00
MX210	Reman Injection Pump Bosch, Mfg # - PES6P 3431, 0 402 066 738 Replaces JR938383	AMPMX210-PES	\$ 1950.00	\$ 750.00
MX220	Reman Injection Pump Bosch, Mfg # - PES6P 3397, 0 402 066 715 Replaces JR930529	AMPMX220-PES	\$ 1950.00	\$ 750.00
MX230	Reman Injection Pump Bosch, Mfg # - PES6P, 0 402 066 736 Replaces 86694167, 86994168	AMPMX230-PES	\$ 1950.00	\$ 750.00
7110, 7120 7130, 7140, 7150, 7210, 7220, 7230, 7240, 7250, 9310, 9330	Fuel Solenoid Fuel Stop Solenoid, 12 Volt	AMJ928160	\$ 99.00	
7110, 7120, 7130, 7140, 7150, 9210, 9230, 9240, 9260	Fuel Solenoid Pull-Type Solenoid, 12 Volt	AMJ921978	\$ 175.00	
MX100, MX110, MX120, MX135, MX150, MX170	Fuel Solenoid Fuel Stop Solenoid, 12 Volt, Uses 5/8" mount holes	AM87420952	\$ 45.00	
MX240, MX255, MX270, MX285	CAPS Pump Replacement Kit Includes In-Line "P" 7100 Fuel Injection Pump HD, Fuel Injection Lines, Installation Components and Hardware	AMX36274	\$ 10480.00	
385 SN 5001-5287, 485, 585, 885 - w/ VA Injection Pump	Fuel Shutoff Cable 50.50" Long Replaces 3129712R1	AM3234947R2	\$ 42.43	
C50, C60, C70, C80, C90, C100, CX50, CX60, CX70, CX80, CX90, CX100, MX80C, MX90C, MX100C	Fuel Shut Off Solenoid Replaces 217608A1, 340521A1, 1896464M1	AM218323A1	\$ 20.00	
7210 ASN JJA0064977, 7220, 7230, 7240, 8910, 8920, 8930, 8940, 8950, 9310, 9330, MX180, MX200, MX220	Fuel Shutoff Solenoid Replaces 87773078, J930233	AM87420950	\$ 183.34	
3220	Fuel Shutoff Cable 38 1/2" Long	AM1333003C1	\$ 46.75	
3220 ASN 11070000, 3230, 4210, 4230, 4240	Fuel Shutoff Cable 53 3/4" Long Replaces 1965053C2, 1333179C1	AM1965053C2	\$ 39.71	
(585, 595, 695, 895, 995, 3220, 3230, 4210, 4230, 4240 - w/ Cab), 685, 885	Throttle Cable 57" Long	AM3401585R3	\$ 40.59	
7110, 7120, 7130, 7140, 7150, 7210, 7220, 7230, 7240, 7250, 8910, 8920, 8930, 8940, 8950	Foot Throttle Cable 72.75" Long	AM97173C4	\$ 64.89	



Turbochargers

Application	Description	Part Number	Retail Price	Core
5120, 5220, Swather: 8840 - All w/ Cummins® 3.9T Engine	Turbocharger, Holset Replaces J802290, J919135	AM3522900	\$ 475.00	
5140, 5240, 5250, Combines: 1620, 1640, 1644, 2144, Cotton Picker: 2022 - All w/ Cummins® 5.9T Engine	Turbocharger, Holset Replaces J919113, J802289	AM3522778	\$ 305.00	
7110, 7120, 7130, 7140, 7210, 7220, 7230, 7240, 9110, 9130, 9210, 9230, 9310, 9330, Combines: 1660, 1666, 1670, 1680, 2166, Cotton Picker: 2044 - All w/ Cummins® 8.3T Engine	Turbocharger, Holset Style Requires (2) J919687 Fittings and (1) J921530 Hose Replaces J909308, J802303	AM3524034	\$ 345.00	
7150, 7250 w/ Emissions Certified Engine ASN JJA006479	Turbocharger Replaces J536309	AM3536309	\$ 475.00	

Prices Subject to Change without Prior Notice. The use of original equipment manufacturer (OEM) part numbers or trademarks, e.g. Case® and John Deere®, are for reference purposes only and for indicating product use and compatibility. Our company and the listed replacement parts contained herein are not sponsored, approved or manufactured by the OEM. All parts are New unless designated Reman in the description.

Case IH®—Tractor

Application	Description	Part Number	Retail Price	Core
(7220, 7230, 8930 - w/ Emissions Certified Engine ASN JJA006479), 8910, 8920	Turbocharger Replaces J802824	AM3535789	\$ 360.00	
7240 w/ Emissions Certified Engine ASN JJA006479, 8940	Turbocharger Replaces J802859	AM3537130	\$ 425.00	
8950	Reman Turbocharger Replaces J802826	AM3535787	\$ 910.00	\$ 200.00
9170, 9180	Turbocharger T46, Borg-Warner®: 167050 Replaces 3801968	AM3036309	\$ 615.00	
9250	Reman Turbocharger H2D, Borg-Warner®: 168824	AM3525237	\$ 725.00	\$ 300.00
9370	Reman Turbocharger HT60, Borg-Warner®: 172065	AM3536805	\$ 770.00	\$ 300.00
DX48, DX55, DX60, Farmall®: 55, 60	Turbocharger Replaces 4T507, 87772751, 87780726, 135756172	AMSBA135756171	\$ 517.00	
JX65, JX70, JX90, JX95, JX1070C, JX1070N, JX1075C, JX1075N	Turbocharger Replaces 454163-5002S	AM99462782	\$ 425.00	
MX100, MX110, MX120, MX135, MX150, MX170	Turbocharger Replaces J802770	AM3537132	\$ 575.00	
MX180	Reman Turbocharger Replaces J802896	AM3538696	\$ 1310.00	\$ 200.00
MX200, MX220	Reman Turbocharger Replaces J802898	AM3538698	\$ 825.00	\$ 297.00
MX215, MX245, MX275, MX305, Magnum®: 215, 245, 275, 305, 335	Turbocharger Replaces 84186718, 87355507, 87357062R	AM87357062	\$ 2575.00	\$ 200.00
MX240, MX255, MX270, MX285, STX275, STX325	Turbocharger Replaces J800426	AM3590348	\$ 475.00	
Combine: 915 Early	Reman Turbocharger 3LD229, Schwitzer Replaces 702277C91, 749605C91	AM146718	\$ 690.00	\$ 200.00
Combines: 915 Late, (1460, 1480 ASN 103041)	Turbocharger T04B18, AiResearch Replaces 675795C91, 684240C91, A184785	AM409570-16	\$ 365.00	
Combines: 1470, (1480 BSN 103041, 1660, 1680 - w/ 466 Engine), Cotton Pickers: 1822, 1844	Turbocharger T04B25, AiResearch Replaces A184781	AM409770	\$ 700.00	
Combines: 2144, 2344	Reman Turbocharger HX35W Replaces J802695	AM3536319	\$ 910.00	\$ 300.00
Combines: 2377, 2388	Reman Turbocharger HX40W Replaces 87351239, J802888	AM3598070	\$ 975.00	\$ 400.00
Magnum®: 235, 250, 260, 280, 290, 310, 315, 340, 370, 380	Cooler, Air-to-Air Replaces 84345657	AM47449415	\$ 800.00	
MX200, MX210, MX220, MX230, MX240, MX255, MX270, MX285, P215, P240, PX215, PX240, STX275	Cooler, Air-to-Air Core: 23 7/16" x 2 5/8" x 25 1/2" 3" Inlet and Outlet	AM437249A1	\$ 1245.00	
MXM120, MXM130, MXM140, MXM155	Cooler, Air-to-Air Core: 17 7/8" x 2 3/4" x 14 3/4" 2 1/2" Inlet and Outlet	AM82028450	\$ 715.00	
(5140, 5240, 5250 - w/ Cummins® 6T-590 Engine), Cotton Pickers: 420, (2022, 2044, 2055, 2155 - w/ Cummins® 6TA-830 Engine), 2555	Turbo Supply Hose 21.1875" Long Replaces 71367996, J909548	AMJ918562	\$ 43.59	
Combines: 915, 1460, 1470, 1480 - w/ DT414, DT436 or DT466 Engine	Exhaust Sleeve	AM675317C2	\$ 44.00	
Combines: 1460, 1470, 1480, 1660, 1680 BSN 45689 - w/ DT414 or DT436 Engine	Exhaust Sleeve	AM107594C1	\$ 65.00	

Case IH®—Tractor



Manifold and Components

Application	Description	Part Number	Retail Price	Core
7110, 7120, 7130, 7140, 7150	Exhaust Elbow, Aspirated	AMA184565	\$ 170.00	
	Exhaust Elbow, Non-Aspirated	AMA184564	\$ 109.00	
7110, 7120, 7130, 7140, 7150, 7210, 7220, 7230, 7240, 7250, 8910, 8920, 8930, 8940, 8950, 9110, 9130, 9210, 9230, 9240, MX180, MX200, MX220	Exhaust Manifold Replaces 3906720, 3929779, 3932183	AMJ932183	\$ 220.00	
MX215, MX245, MX275, MX305, STX280, STX330, Magnum®: 215, 245, 275, 305, 335, Steiger®: (280, 330 ASN Z6F105001), 335, Combines: 2377 SN HAJ292002-300001, 2388 SN HAJ292001-HAJ300000, 2577, 2588, Cotton Pickers: 420, 620, 625, CPX620, Sprayer: 4420	Exhaust Manifold - Front Section	AM87344861	\$ 175.00	
MX240, MX255, MX270, MX285, STX275, STX325, Cotton Pickers: CPX610, CPX620, Sprayers: FLX4010, SPX4410	Exhaust Manifold Use w/ J943841 Exhaust Manifold Replaces J943850	AMJ937477	\$ 126.00	
MX215, MX240, MX245, MX270, MX275, MX285, MX305, Magnum®: 215, 245, 275, 305, 335, Steiger®: 280, 330, 335, STX275, STX280, STX325, STX330, Combines: (2377, 2388 (ASN HAJ0295001), 2577, 2588, 7088, Cotton Pickers: 420 Express (Tier 3), 620 Express, 625 Module Express, CPX620, Floaters: 3020 Titan, 3520 Titan, 4020 Titan, 4520 Titan, FLX3010, FLX3300B, FLX3303B, FLX3510, FLX4010, FLX4300, FLX4375, FLX4510, Patriot Sprayers: 4420, SPX4410	Manifold Gasket	AM84368103AM	\$ 8.00	

Mufflers and Exhaust

Our mufflers are manufactured by experienced craftsmen here in the United States. All mufflers have welded seams. Aluminized steel is used for critical components. These features ensure that our products resist the corrosive effects of air, heat and the by-products of combustion that work to shorten muffler life. Additionally, they are painted either silver or black to cosmetically match its OEM counterpart, as well as provide further protection from the elements.



Application	Description	Part Number	Retail Price	Core
Universal Tractors	Exhaust Pipe Black Finish, Straight Pipe 4" ID, Overall Length 47.50"	AM400SP	\$ 59.00	
	Exhaust Pipe Diameter 3.50", Length 48"	AMS312X48	\$ 57.00	
385, 395, 485, 495, 585, 595, 685, 690, 885, 895, 985	Muffler Vertical Oval, Inlet 2 5/16", Length 46 1/2"	AM83207C1	\$ 100.00	
995	Muffler Vertical Tapered Round, Inlet 3", Length 52 1/2"	AM3404966R4	\$ 145.00	
5120, 5130, 5140, 5220, 5230, 5240, 5250	Exhaust Pipe Inlet 3 3/16", Length 38 1/4"	AMA189049	\$ 70.00	
5120, 5220	Muffler Horizontal Oval, Inlet 3", Length 21"	AMA184460	\$ 265.00	
5130, 5140, 5230, 5240, 5250	Muffler Replaces A184475, A184515	AM87704568	\$ 170.00	
7110, 7120, 7130, 7140	Muffler	AMA184157	\$ 635.00	
	Muffler Eliminator	AMX39105	\$ 250.00	
7110, 7120, 7130, 7140, 7150	Exhaust Elbow, Lower	AM1342006C1	\$ 115.00	
7150	Muffler Eliminator	AMX39106	\$ 250.00	

Case IH®—Tractor

Application	Description	Part Number	Retail Price	Core
7210, 7220, 7230, 7240, 7250, 8910, 8920, 8930, 8940, 8950	Exhaust Chrome Stack Kit Includes Chrome Stack, Chrome Clamp and Lower Mounting Stand Replaces 1348936C2	AM1347836C3C	\$ 675.00	
	Gasket Replaces 1998778C1	AM1998778C2	\$ 35.00	
9170, 9180, 9270, 9280, 9370, 9380, 9390	Muffler Inlet 5"	AM90-8295T1	\$ 475.75	
	Muffler Eliminator	AMX39102	\$ 593.00	
JX55, JX60, JX65, JX70, JX75, JX80, JX85, JX90, JX95, JX1060C, JX1070N	Muffler Vertical Oval Body, Inlet 2", Length 14"	AM5172649	\$ 144.00	
JX70, JX80	Muffler Vertical / Oval, Length 9 1/2", Inlet 2 1/4"	AM84358641	\$ 80.00	
MX180, MX200, MX210, MX230, MX240, MX245, MX255, MX270, MX275, MX285, MX305	Exhaust Chrome Stack Kit, Curved Includes 72" Curved Chrome Stack (6" ID), 6" Chrome Clamp and Lower Mounting Stand w/ Aspirator Replaces 220-215, 87369371	AM255270A4	\$ 925.00	
	Gasket	AM226775A1	\$ 21.50	
MX215, MX245, MX275, MX305, Magnum®: 215, 245, 255, 275, 305, 335	Muffler Pipe	AM87520146	\$ 272.00	
MXM120, MXM130, MXM140, MXM155	Muffler, Underhood	AM82022922	\$ 381.00	
Combines: 1660, 1680	Muffler Eliminator, Aspirator	AM1275826C1	\$ 294.00	



Starters

Application	Description	Part Number	Retail Price	Core
Magnum®: 220, 225, 235, 240, 250, 255, 260, 270, 280, 290, 305, 310, 315, 335, 340, 370	Starter, 12 Volt Gear Reduction, 10 Tooth, 4.20kW Note: Special Order Item Replaces 84213446	AM87425232	\$ 375.00	
Magnum®: 235, 250, 260, 280, 290, 310, 315, 340, 370, 380	Starter Replaces 500357253	AM87750408	\$ 975.00	
715 ASN 23000	Starter, 12 Volt Delco Replaces 121913C91	AM1109258	\$ 70.00	
5130, 5140, 5230, 5240, 5250, MX100, MX110, MX120, MX135, MX150, MX170	Starter, 12 Volt Bosch, 9 Tooth, CW Rotation	AM114799A1	\$ 200.00	
7110, 7120, 7130, 7140, 7150, 7210, 7220, 7230, 7240, 7250, 8910, 8920, 8930, 8940, 8950, (9110, 9130 BSN JCB00003600), 9210, 9230, 9240, 9310, 9330, Combines: 1620, 1640, 1644, 1660, 1666, 1670, 1680, 1682, 1688, 2144, 2166, 2188, (2366, 2388 ASN JJC0274450), 2377, 2577, 2588, 5088, 6088, 7088, Cotton Pickers: 420, 620, 625, 1800, 1822, 1844, 2022, 2044, 2055, 2155, 2555 BSN JCB00003600, CPX620 ASN Y6T011501 - All w/ 8.3 Cummins® Engine	Starter, 12 Volt HD Planetary Gear Reduction, 10 Tooth Steel Pinions, Steel Ring Gear, 4.2kW, CW Rotation Replaces 91902C2, 84146320, 87419387, A162469, A187728, AR187728	AM193432A2	\$ 295.00	
CS78, CS80, CS85, CS86, CS94, CS95 Pro, CS105 Pro, CS110, CS120, CS130, CS150, CVX120, CVX130, CVX140, CVX150, CVX160, CVX170, CVX175, CVX190, CVX195, CVX1135, CVX1145, CVX1155, CVX1170, CVX1190, CVX1195	Starter, 12 Volt 11 Tooth, CW Rotation Replaces 84284540	AMV836873457	\$ 345.00	
JX60, JX70, JX75, JX80, JX85, JX90, JX95, JX100U, JX1095N	Starter, 12 Volt Replaces 82980757, 87538219, 500338952	AM5801441814	\$ 190.00	

Case IH®—Tractor

Application	Description	Part Number	Retail Price	Core
JX1080U, JX1085C, JX1095C, JX1095N, JX1095U, JXU75, JXU85, JXU95, JXU105, JXU115, MXU100, MXU110, MXU115, MXU125, MXU130, MXU135, Farmall®: 95A, 105A, 115A, Maxxum®: 100, 110, 115, 120, 125, 130, 135, 140, 150, 180, Puma®: 125, 130, 140, 145, 155, 160, 165, 170, 180, 185, 195, 200, 205, 210, 215, 225, 230, McCormick®: MC120, MC135, MTX120, MTX135, MTX150, TTX190, TTX210, TTX230, X6.420, X6.430, X7.440, X7.450, X7.460, X7.660, X7.670, X7.680, X70.40, X70.50, X70.60, X70.70, X70.80, XTX145, XTX165, XTX185, XTX200, XTX215	Starter Bosch, 10 Tooth, 4kW, CW Rotation Bosch Mfg # - 504357110 Iskra Mfg # - IS1109	AM84151331	\$ 275.00	
Combine: 1420, 1440, 1460, 1470, 1480	Reman Starter, 12 Volt Delco 35MT	AM1113444	\$ 295.00	\$ 100.00
Swathers: WD1203, WD1204, WD1903, WD1904, WD2303, WDX1002S, WDX1202, WDX1202S	Starter, 12 Volt Gear Reduction, 10 Tooth, 4.20kW Replaces 87054526	AM87577368	\$ 300.00	
Utility: D25, D29, D33, DX25, DX29, DX31, DX33, Farmall®: 31	Starter, 12 Volt 9 Tooth	AMSBA185086551	\$ 89.00	
Utility: D35, D40, D45, (DX34, DX35 - Class 3), DX40, DX45, DX55, DX60, Farmall®: 35, 40, 45, 50, 55, 60	Starter, 12 Volt 11 Tooth	AMSBA185086530	\$ 128.00	
Swathers: WDX901, WDX1002S, WDX1101, WDX1202S, WDX1701	Ignition Switch Replaces 529713, 8641833, 80641833	AM641833	\$ 20.31	

Air Cleaner Components

Application	Description	Part Number	Retail Price	Core
Farmall®: 110A, 120A, 130A, 140A, Magnum®: 180, 200, 220, 240, 250, 280, 310, 340, 380, Maxxum®: 115, 125, 135, 145, 150, Puma®: 150, 165, 185, 200, 220, Steiger® 4WD: 370, 420, 470, 500, 540, 580, 620, Quadtrac®: 370, 420, 470, 500, 540, 580, 620	Sensor, Nox Replaces 47688088	AM84422747	\$ 420.00	
Combines: 615, 715, 815, 915	Large Precleaner Bowl 10.50" Diameter	AMP01-6330	\$ 12.00	

Tachometers and Instrument Clusters

Application	Description	Part Number	Retail Price	Core
585 w/ Cab, 685, 885	Tachometer Cable 59.50" Long	AM1970911C1	\$ 64.66	
7110, 7120, 7130, 7140, 7150, 7210, 7220, 7230, 7240, 7250, 8910, 8920, 8930, 8940, 8950	Reman Instrument Cluster Replaces 1938128C1, 1938128C2, 1964859C6R	AM1964859C5R	\$ 920.00	\$ 250.00

Alternators

Application	Description	Part Number	Retail Price	Core
Magnum®: 220, 225, 240, 250, 255, 270, 280, 305	Alternator, 14 Volt 175 Amps Note: Special Order Item Replaces 87645567	AM87418226	\$ 335.00	
4000 ASN 4501, 5000 ASN 1901, 5120, 5130, 5140, 5220, 5230, 5240, 5250, CS78, CS94, MX80C, MX90C, MX100, MX100C, MX110, MX120, MX135, MX150, MX170	Alternator w/o Pulley Bosch, 12 Volt, 95 Amps, IR/EF, CW Rotation	AMA187623	\$ 105.00	
5120, 5130, 5140, 5220, 5230, 5240, 5250, MX100, MX110, MX120, MX135	Reman Alternator Bosch Type, 12 Volt, 65 Amps, IR/EF	AMRE533516	\$ 188.59	\$ 20.00
7110, 7120, 7130, 7140, 7210, 7220, 7230, 7240, 8910, 8920, 8930, 8940, 8950, MX180, MX200, MX220, MX240	Alternator w/o Pulley Bosch 135 Amps, 12 Volt, Internally Regulated Replaces 91448C2R	AM91448C2	\$ 140.00	



Case IH®—Tractor

Application	Description	Part Number	Retail Price	Core
9110, 9130	Alternator 105 Amps	AMA163085	\$ 141.00	
	Alternator 105 Amps, Plug at 6 o'clock position, 3-Pin	AMA181766	\$ 143.50	
9210, 9230, 9240, 9250, 9260, 9270, 9280, 9310, 9330, 9350, 9370, 9380, 9390	Alternator Delco 21SI Type, 12 Volt, 125 Amps, 1-Wire Hookup	AM1987560C1	\$ 171.00	
JX60, JX70, JX80, JX90, JX95 - w/ Cab	Alternator 14 Volt, 65 Amps Replaces 84402418, 84402419, 84522025	AM84402417	\$ 160.00	
MX180, MX200, MX220, MX240, MX270, STX275, STX325, STX375, STX425, STX440, STX450, STX500, (MX210, MX230, MX255, MX285 BSN JAW135316)	Alternator w/o Pulley 12 Volt, 135 Amps, IR, CW Rotation Replaces 91448C1, 86994128	AM125849A1	\$ 217.00	
(MX210, MX230, MX255, MX285 ASN JAZ135316)	Alternator w/o Pulley 12 Volt, 150 Amps, IR/IF, CW Rotation	AM87452821	\$ 190.00	
MX215, MX245, MX275, MX305, Magnum®: 215, 245, 255, 275, 305, 335, Steiger® 4WD: 420, 450, 470, 500, 550, 600, Quadtrac® 4WD: 420, 450, 470, 500, 550, 600	Alternator 12 Volt, 200 Amps, IR/IF	AM87715398	\$ 345.00	
MXM120, MXM130, MXM140, MXM155, MXM175, MXM190	Alternator, 14 Volt 120 Amps Note: Special Order Item Replaces 47744887	AM87361085	\$ 225.00	
MXU100, MXU115, MXU125, MXU130, MXU132, Farmall®: 120, 130, Maxxum®: 100, 110, 115, 120, 125, 130, 135, 140, Puma®: 125, 130, 145, 155, 160	Alternator, 14 Volt 120 Amps Note: Special Order Item Replaces 84141452	AM87361082	\$ 215.00	

Sensors





Application	Description	Part Number	Retail Price	Core
Farmall®: 80N, 80V, 90C, 90N, 90V, 100C, 100N, 100V, 110C, 110N, 110U, 110V, 120C, 120U, Backhoe-Loaders: 580N, 580 Super N, 590 Super N	Sensor, Exhaust Pressure	AM5801382522	\$ 104.00	
Farmall®: 90C, 100C, 110A, 110C, 110U, 120A, 120C, 120U, 130A, 140A, Magnum®: 180, 200, 220, 240, 250, 280, 310, 340, 380, Maxxum®: 115, 125, 135, 145, 150, Puma®: 150, 165, 185, 200, 220, 240, Backhoe-Loader: 570N, Forklifts: 586H, 588H, Wheel Loaders: 521F, 521G, 621F, 621G, 721F, 821F, 821G, 921F, 921G, 1021G, 1121G, Steiger® 4WD: 350, 370, 400, 420, 450, 500, 540, 580, 620, Quadtrac®: 370, 420, 470, 500, 540, 580, 620	Temperature Sender, Exhaust Temperature Replaces 47367178, 87482353, LB52S00001P1	AM47478880	\$ 60.00	
Maxxum®: 110, 115, 120, 125, 130, 140, MXU110, MXU125, MXU135, Puma®: 115, 125, 140, 150, 155, 180, 185, 195, 200, 210, 220, 225, 240, STX380, STX430, Backhoe-Loaders: 580SM, 580SN, 590SM, 590SN, Wheel Loaders: 521F, 621E, 621F, 721D, 721E, 721F, 821F, 921F, 1021F, Steiger® 4WD: 380, 385, 430, 435, 485	Sensor, Oil Pressure and Temperature Replaces 4890193	AM504358206	\$ 78.00	
Farmall®: 110A, 120A, 130A, 140A, Magnum®: 180, 200, 220, 240, 250, 280, 310, 340, 380, Maxxum®: 115, 125, 135, 145, 150, Puma®: 150, 165, 185, 200, 220, 240, Steiger® 4WD: 370, 420, 470, 500, 540, 580, 620, Quadtrac® 4WD: 370, 420, 470, 500, 540, 580, 620	Sensor, Def/AdBlue Quality Replaces 84553250	AM47520143	\$ 320.00	
Magnum®: 180, 190, 210, 225, Maxxum®: 110, 115, 120, 125, 130, 135, 140, 145, Puma®: 115, 125, 130, 140, 145, 150, 155, 160, 165, 170, 180, 185, 195, 200, 210, 215, 225, 230	Sensor, Fuel Pressure Replaces 2859145, 504123163, 504222094	AM2854542	\$ 170.00	

Case IH®—Tractor

Application	Description	Part Number	Retail Price	Core
Magnum®: 180, 200, 220, 250, 280, 310, 340, 380, Maxxum®: 115, 125, 135, 145, 150, Wheel Loaders: 521F, 521G, 621F, 621G, 721F, 721G, 821F, 821G, 921F, 921G, Steiger® 4WD: 370, 420, 470, 500, 540, 580, 620, Quadtrac®: 370, 420, 470, 500, 540, 580, 620	Sensor, 8-Pin/NH3/Ammonia Replaces 47368956, 84382712	AM47520140	\$ 425.00	
Magnum® Tractor: 235, Backhoe-Loaders: 580N, 580 Super N, 590 Super N, Wheel Loaders: 512F, 521G, 621F, 621G, 721F, 721G, 821G, 921G, 1021G, 1121G	Switch, Engine Exhaust Pressure Replaces 2859674, 4890193, 6901334	AM504358206	\$ 78.00	
Magnum®: 250, 280, 310, 340, 380	Sensor, Def/AdBlue Tank Level Replaces 47682727, 84161271, LB50P01001P1	AM47512674	\$ 260.00	
MX215, Magnum®: 225, 235, 250, 255, 260, 280, 290, 310, 315, 340, 370, 380, Maxxum®: 115, 125, 135, 145, 150, Optum™: 270, 300, Puma®: 140, 150, 165, 185, 200, 220, 240, Steiger® 4WD: 350, 370, 400, 420, 450, 470, 500, 540, 550, 580, 600, 620, Quadtrac® 4WD: 370, 400, 450, 470, 500, 540, 550, 580, 600, 620	Electric Module	AM87601142	\$ 43.00	
MXU110, MXU125, MXU135, Magnum®: 180, 190, 210, 225, 235, 110, 115, 120, 125, 130, 140, Puma®: 115, 125, 130, 140, 145, 155, 160, 165, 170, 180, 185, 195, 210, 215, 225, 230, Backhoe-Loaders: 580N, 580 Super N, 580SM, 580SN, 590SM, 590SN, 590 Super N, Wheel Loaders: 521E, 521F, 521G, 621E, 721D, 721F, 721G, 821E, 921G, 1021G, 1121G	Sensor, MAP Temperature/Pressure Replaces 2852821, 4896794, 504073323	AM504372225	\$ 49.00	
STX380, STX430, Steiger® 4WD: 380, 385, 430, 435, 485	Sensor, Clogged Fuel Filter Indicator	AM500346371	\$ 40.00	
Wheel Loaders: 1021G, 1121G	Sensor, Exhaust Pressure	AM5801376024	\$ 56.00	
Wheel Loaders: 1021G, 1121F, 1121G	Sensor, Crankcase Pressure	AM504364902	\$ 183.00	

Mechanical Front Wheel Drive Parts











MFWD Hubs and Housings

Application	Description	Part Number	Retail Price	Core
MX100, MX110, MX120, MX135	Axle Housing	AM247513A1	\$ 2825.00	
MX210, MX215, MX230, MX245, Magnum®: 180, 190, 210, 215, 225, 245	Axle Housing Suspended Axles w/ 10-Bolt Hubs w/ Differential Lock	AM87404289	\$ 4500.00	
 MX210, MX215, MX230, MX245, Magnum®: 215, 245	Axle Housing For Standard Axles w/ 10-Bolt Hubs w/ or w/o Differential Lock For Specialty Axles w/ 10-Bolt Hubs w/o Differential Lock	AM87404246	\$ 3750.00	
 MX210, MX215, MX230, MX245, MX255, MX275, MX285, MX305, Magnum®: 215, (235, 260, 290 - w/ Class 4.75 Axle w/o CVT), 245, 255, 275, 305	Axle Housing For Standard Axles w/ 12-Bolt Hubs w/ or w/o Differential Lock	AM87404249	\$ 3300.00	
 (MX210, MX230 BSN MY00182861 w/ 10-Bolt Hubs), (MX210, MX215, MX230, MX245, MX255, MX275, MX285, MX305 - w/ 12-Bolt Hubs), Magnum®: (215, 245, 275, 305 - w/ 12-Bolt Hubs), (235, 260, 290, 315 - w/ Class 4.75 Axle w/o CVT)	Axle Housing For Suspended Axles w/ Differential Lock	AM87404290	\$ 4400.00	
5120, 5130, 5140, 5220, 5230, 5240, 5250, MX100, MX110, MX120, MX135, MX150, MX170	Upper Bearing, King Pin 1.378" ID, 2.047" OD, 0.65" Thick Replaces N14372	AM9967999	\$ 33.67	
 MX210, MX215, MX230, MX245, MX255, MX275, MX285, MX305, Magnum®: 215, (235, 260, 290, 315 - w/ Class 4.75 DANA® Axle w/o CVT), 245, 275, 305	Cradle For Suspended Axles	AM87406430	\$ 1500.00	

Mechanical Front Wheel Drive Parts













Case IH®—Tractor

Case IH®—Tractor

Application	Description	Part Number	Retail Price	Core
 MX210, MX215, MX230, MX245, MX255, MX275, MX285, MX305, Magnum®: 180, 190, 200, 210, 215, 220, 225, 235, 240, 245, 250, 255, 260, 275, 280, 290, 305, 310, 315, 335, 340, 370, 380	Pivot Pin	AM87400196	\$ 350.00	
(MX210, MX215, MX230, MX245, MX305 - w/ Suspended Axles w/ 10-Bolt or 12-Bolt Hubs w/ and w/o Differential Lock), (MX255, MX275, MX285 - w/ Suspended Axles w/ 12-Bolt Hubs w/ Differential Lock), Magnum®: (215, 245 - w/ Suspended Axles w/ 10-Bolt or 12-Bolt Hubs w/ and w/o Differential Lock), (275, 305 - w/ Suspended Axles w/ 12-Bolt Hubs w/ Differential Lock)	Front Axle Pin	AM87406480	\$ 135.00	
MX210, MX215, MX230, MX245, MX255, MX275, MX285, MX305, Magnum®: 215, 245, 275, 305 - All w/ Suspended Axle	Suspension Cylinder Pin For Upper and Lower Ends of Cylinder	AM87406468	\$ 145.00	
	Swing Arm Pin	AM87406453	\$ 245.00	
MX210, MX215, MX230, MX245, MX275, MX285, MX305, Magnum® 180, 190, 210, 215, 225, 235, 245, 260, 275, 290, 305, 315	Pivot Pin For Suspended Suspension	AM87406467	\$ 300.00	
(MX210, MX215, MX230, MX245, MX255, MX275, MX285, MX305 - w/ Suspended Axles), Magnum®: (215, 245, 275, 305 - w/ Suspended Axles), (235, 260, 290, 315 - w/ Suspended Axles w/o CVT w/ DANA® Class 4.75 Axle)	Pin, Upper Swing Arm	AM87406452	\$ 200.00	
	Pin, Lower Swing Arm	AM87406451	\$ 265.00	
 MX210, MX215, MX230, MX245, MX255, MX275, MX285, MX305, Magnum®: 215, (235, 260, 290, 315 - w/ Class 4.75 DANA® Axle w/o CVT), 245, 275, 305	Suspension Cylinder, Right Hand	AM87406484	\$ 980.00	
	Suspension Cylinder, Left Hand For Suspended Axles	AM87406483	\$ 985.00	
 MX215, Magnum®: 225, 235, 250, 260, 280, 290, 310, 315, 335, 340, 370, 380, Optum®: 270, 300	Control Valve For Suspended Axle	AM87668716	\$ 1285.00	
 MX210, MX215, MX230, MX245, MX255, MX275, MX285, MX305, Magnum®: 215, (235, 260, 290, 315 - w/ Class 4.75 DANA® Axle w/o CVT), 245, 275, 305	Lower Swing Arm For Suspended Axles	AM87406431	\$ 2050.00	
 7110*, 7120*, 7130*, 7140*, 7150*, 7230*, 7240*, 7250*, 8910, 8920, 8930, 8940, 8950 *Requires metric bolts, wheel nuts and (2) AM231014A1 8000 Series trunnion pins	Hub Assembly w/ Knuckle, Right Hand	AMX4110102	\$ 4750.00	
	Hub Assembly w/ Knuckle, Left Hand	AMX4110103	\$ 4750.00	
 7110*, 7120*, 7130*, 7140*, 7150*, 7230*, 7240*, 7250*, 8910, 8920, 8930, 8940, 8950 *Requires (2) AM231014A1 8000 Series Trunnion Pins	Hub Assembly	AMX411116	\$ 3500.00	
 MX80C, MX90C, MX100, MX100C, MX110, MX120, MX135	Complete Corner, Right Hand	AM323911A3	\$ 2486.40	
	Complete Corner, Left Hand	AM323912A3	\$ 2552.00	
 7110*, 7120*, 7130*, 7140*, 7150*, 7230*, 7240*, 7250*, 8910, 8920, 8930, 8940, 8950 *Requires metric bolts, wheel nuts and (2) AM231014A1 8000 Series trunnion pins	Steering Knuckle, Right Hand Replaces 248233A1	AM128875A1	\$ 1000.00	
	Steering Knuckle, Left Hand Replaces 248232A1	AM128867A1	\$ 1000.00	
 MX80C, MX90C, MX100, MX100C, MX110, MX120, MX135	Steering Knuckle, Right Hand	AM366814A1	\$ 588.00	
	Steering Knuckle, Left Hand	AM366813A1	\$ 588.00	
 MX150, MX170	Steering Knuckle, Right Hand Replaces 296426A1, 366816A1	AM84395910	\$ 912.00	

Case IH®—Tractor

Mechanical Front Wheel Drive Parts





	Application	Description	Part Number	Retail Price	Core
	MX180, MX200, MX210, MX220, MX230	Steering Knuckle, Right Hand	AM295163A2	\$ 1195.00	
		Steering Knuckle, Left Hand	AM295162A2	\$ 1140.00	
	MX210, MX230, MX240 ASN 105000, MX255, MX270 ASN 105000, MX280	Steering Knuckle, Right Hand	AM292564A2	\$ 1400.00	
		Steering Knuckle, Left Hand	AM292560A2	\$ 1240.00	
		12-Bolt Hubs on Standard and Suspended Axles			
	7110, 7120, 7130, 7140, 7150, 7210, 7220, 7230, 7240, 7250, 8930, 8940, 8950, MX180, MX200, MX210, MX215, MX220, MX230, MX245, MX255, MX275, MX285, Magnum®: 180, 190, 210, 215, 225, 245, 255	Shim Kit Replaces 1277247C1, B94587, B94585	AM1981236C1	\$ 20.00	
	MX210, MX215, MX230, MX245, MX255, MX275, MX285, MX305, Magnum®: 215, 245, 255, 275, 305	Shim Kit	AM310960A1	\$ 100.00	
	5120, 5130, 5140, 5150, 5220, 5230, 5240, 5250	Trunnion, Upper Replaces 1995414C1, B503049, CAR125149	AM81863173	\$ 96.50	
	MX80C, MX90C, MX100, MX100C, MX110, MX120, MX135, MX150, MX170	Trunnion, Upper	AM247517A1	\$ 91.20	
	5120, 5130, 5140, 5150, 5220, 5230, 5240, 5250	Trunnion, Lower Replaces 3475348M1, 83952503, 153326212	AMN13504	\$ 73.50	
	JX75, JX80, JX80U w/ Class 2 Axle, JX85, JX90, JX90U, JX95, JX100U, JX1080U, JX1090U, JX1100U, MXM120, MXM130, MXM140, MXU100, MXU110, MXU115, MXU125, MXU130, MXU135, Farmall®: 90, 95	Trunnion	AM5137239	\$ 68.22	
	MX80C, MX90C, MX100, MX100C, MX110, MX120, MX135, MX150, MX170	Trunnion Replaces 122259A1, 3311329M91, 3311331M91, 3523550M1, 6190566M1, 47108554, 81863002, 82850292, 137700410855, CAR12881	AM9968025	\$ 120.00	
	7110, 7120, 7130, 7140, 7150, 7210, 7220, 7230, 7240, 7250	Trunnion Cap	AM86505030	\$ 210.00	
	8910, 8920, 8930, 8940, 8950	Trunnion Cap	AM231014A1	\$ 150.00	
	(MX180, MX200, MX220 ASN 105000), MX210, MX230	Trunnion Cap For 10-Bolt Hubs	AM378409A1	\$ 80.00	
	MX210, MX230, MX240 ASN 105000, MX255, MX270 ASN 105000, MX285	Trunnion Cap For 12-Bolt Hubs	AM378410A1	\$ 75.00	

Case IH®—Tractor

Case IH®—Tractor















Application	Description	Part Number	Retail Price	Core
 (MX210, MX215, MX230, MX245 - w/ Suspended Axle w/ 12-Bolt Hubs w/ Differential Lock), (MX210, MX230, MX255, MX285 BSN MY00182905 w/ Standard Axle w/ 12-Bolt Hubs w/ Differential Lock), (MX210, MX230, MX255, MX285 - w/ Standard Axle w/ 12-Bolt Hubs w/o Differential Lock), (MX215, MX245, MX275, MX305 - w/ Standard Axle w/ 12-Bolt Hubs w/ and w/o Differential Lock), (MX240, MX270, (MX255, MX275, MX285, MX305 - w/ Suspended Axle w/ 12-Bolt Hubs w/ and w/o Differential Lock), Magnum®: (215, 245 - w/ Suspended Axle w/ 12-Bolt Hubs w/ Differential Lock), (215, 245, 275, 305 - w/ Standard Axle w/ 12-Bolt Hubs w/ and w/o Differential Lock), (235, 260, 290, 315 - w/ DANA® Class 4.75 Axle w/o CVT), (275, 305 - w/ Suspended Axle w/ 12-Bolt Hubs w/ and w/o Differential Lock)	Shim Kit For Upper and Lower Trunnion Caps	AM313557A1	\$ 100.00	
MX210, MX215, MX230, MX240, MX245, MX255, MX270, MX275, MX285, MX305, Magnum®: 215, 235, 245, 255, 260, 275, 290, 305, 315	Trunnion Bearing, Pivot Housing Replaces 070HC103	AM368728A1	\$ 132.00	
(MX210, MX215, MX230, MX245, MX255, MX275, MX285, MX305 - w/ Suspended Axles), Magnum®: (235, 260, 290, 305 - w/ Suspended Axles w/o CVT w/ DANA® Class 4.75 Axle)	Plate	AM87406476	\$ 375.00	
Magnum®: 235, 250, 260, 280, 290, 310, 315, 340, 370, 380	Axle Position Sensor	AM429690A1	\$ 139.00	

MFWD Hub Components















Application	Description	Part Number	Retail Price	Core
7110, 7120, 7210, 7220, 7230, 7240, 7250	Carrier Flange Assembly 3-Pin Hub 86017447, 87780417, B94587	AM86020261	\$ 1800.00	
 7110, 7120, 7130, 7140, 7150, 7230, 7240, 7250, 8910, 8920, 8930, 8940, 8950	Carrier Flange Assembly 4-Pin Hub	AM291060A1	\$ 1550.00	
MX180, MX200	Carrier Flange Assembly 3-Pin Hub, 10-Bolt Flange Includes Flange, Gears, Needle Bearings and Thrust Washers	AM302175A2	\$ 1465.00	
 MX180, MX200, MX245, MX255, MX275, MX285, Magnum®: 215, 245, 255, 275	Carrier Flange Assembly 4-Pin Hub, 10-Bolt Flange Includes Flange, Gears, Needle Bearings and Thrust Washers	AM302251A2	\$ 1500.00	
 MX80C, MX90C, MX100, MX100C, MX110, MX120, MX135	Final Drive Hub Replaces 6914448	AM247555A1	\$ 184.00	
 MX100, MX110, MX120, MX135, MX150, MX170	Final Drive Hub Replaces 222691A1, 310492A1, 85808264	AM85817684	\$ 216.80	
7110, 7120, 7130, 7140, 7150, 7210, 7220, 7230, 7240, 7250	Flange Assembly 10-Bolt Replaces 1961760C1	AM1349338C1	\$ 725.00	
 8910, 8920, 8930, 8940, 8950	Flange Assembly	AM231022A1	\$ 595.00	

Case IH®—Tractor

Mechanical Front Wheel Drive Parts



	Application	Description	Part Number	Retail Price	Core
	MX80C, MX90C, MX100, MX100C, MX110, MX120, MX135	Flange Assembly	AM365615A1	\$ 386.40	
	MX150, MX170	Flange Assembly	AM300164A1	\$ 750.00	
	MX180, MX200, MX210, MX215, MX220, MX230, MX245, MX255, MX275, MX285, Magnum®: 180, 190, 210, 215, 225, 245, 255, 275	Flange Assembly 10-Bolt Hub Replaces 295165A1, 87588833	AM302173A1	\$ 595.00	
	MX180, MX200, MX210, MX215, MX220, MX230, MX245, MX255, MX275, MX285, Magnum®: 180, 190, 210, 215, 225, 245, 255, 275	Flange 10-Bolt Hub Bolts and Bearings Not Included	AM87588833	\$ 625.00	
	MX210, MX230, MX240, MX255, MX270, MX285	Flange Assembly	AM302172A1	\$ 750.00	
	MX210, MX230, MX240, MX255, MX270, MX285	Top Hat Assembly 12-Bolt	AM302174A1	\$ 1900.00	
	MX100, MX110, MX120, MX135	Hub, Outer	AM247569A1	\$ 775.00	
	MX180, MX200	Planetary Gear Kit	AM316329A2	\$ 625.00	
	MX210, MX215, MX230, MX245, MX255, MX275, MX285, MX305, Magnum®: 215, 245, 255, 275, 305	Planetary Gear Kit For 10-Bolt Hub	AM316330A2	\$ 650.00	
	MX210, MX215, MX230, MX245, MX255, MX275, MX285, MX305, Magnum®: 215, 245, 255, 275, 305	Planetary Gear Kit For 12-Bolt Hub	AM316328A1	\$ 1060.00	
	MX150, MX170	Planetary Pinion Carrier Replaces 47108227	AM300163A1	\$ 1275.00	
	Magnum®: (290, 305, 310, 315, 335, 340 - Class 5)	Planetary Pinion Gear For Standard Suspension	AM87674600	\$ 595.00	
	(385, 485 ASN 18000 w/ APL330 Axle), (395, 495, 695, 895 - w/ ZF Front Axle), (685, 885 - w/ APL330 Axle)	Planetary Pinion Gear Replaces 83946053, 4472352014, ZP4472352014	AM81325C1	\$ 59.00	
	585, 685, 885, Ind: 248 ASN 1590	Planetary Pinion Gear 26 Tooth Replaces 3230261R1, L35588	AMZP1927562	\$ 157.70	
	7110, 7120, 7130, 7140, 7150, 7230, 7240, 7250, 8910, 8920, 8930, 8940, 8950	Planetary Pinion Gear	AM1349038C1	\$ 115.00	
	MX80C, MX90C, MX100, MX100C, MX110, MX120, MX135	Planetary Pinion Gear Replaces 6914461	AM247551A1	\$ 115.00	
	MX150, MX170	Planetary Pinion Gear (6) Required Replaces 175979A1	AM85808271	\$ 166.00	
	(385, 485 ASN 18000 w/ APL325 or APL330 Axle), (395, 495, 695, 895 - w/ ZF Front Axle), (685, 885 - w/ APL330 Axle)	Planetary Pinion Shaft 18 Spline, 4.67" Long	AM81435C1	\$ 70.00	
	MX180, MX200, MX210, MX220, MX230	Retainer	AM251190A1	\$ 120.00	

Case IH®—Tractor





Application	Description	Part Number	Retail Price	Core
 MX150, MX200, MX210, MX220, MX230	Ring Gear Assembly 10-Bolt Hubs, 4-Gear Planetary	AM281984A1	\$ 950.00	
 MX210, MX215, MX230, MX240, MX245, MX255, MX270, MX285, MX305, Magnum®: 215, 245, 255, 275, 305	Ring Gear Assembly For 12-Bolt Hub	AM281985A1	\$ 865.00	
385, 395, 485, 495, 585, 595, 685, 885, 895 - w/ APL330 Axle	Ring Gear Replaces 4472352015	AM81434C1	\$ 370.00	
5120, 5130, 5140, 5150, 5220, 5230, 5240, 5250	Ring Gear Replaces 83952533, H437677, K395126	AM9968069	\$ 315.53	
5120, 5130, 5140, 5150, 5220, 5230, 5240, 5250	Ring Gear Replaces 3475610M1, 83954696, 137700420856	AMN13513	\$ 99.50	
 7110, 7120, 7130, 7140, 7150, 7230, 7240, 7250, 8910, 8920, 8930, 8940, 8950	Ring Gear Replaces 86505064	AM1277250C1	\$ 545.00	
 MX80C, MX90C, MX100, MX100C, MX110, MX120, MX135	Ring Gear	AM247548A1	\$ 247.20	
 MX100, MX110, MX120, MX135, MX150, MX170	Ring Gear Replaces 1-33-742-710, 175976A1, 47109037, 81863005, CAR125186	AM85808265	\$ 356.80	
5120, 5130, 5140, 5150	Inner Plate, Planetary Ring Gear Replaces 44079R1, 9968065, 83952534	AMH437678	\$ 131.00	
 Farmall®: 85U, 95U, 105A, 105U, 115U, 120A, Maxxum®: 110, 115, 120, 125, 130, 135, 140, 145, 150, Puma®: 115, 125, 130, 140, 145, 150, 155, 160, 165	Seal	AM87349641	\$ 51.45	
 7110, 7120, 7130, 7140, 7150, 7210, 7220, 7230, 7240, 7250, 8910, 8920, 8930, 8940, 8950	Seal	AM1349339C1	\$ 37.50	
 MX210, MX215, MX230, MX245, MX255, MX275, MX285, Magnum®: 180, 190, 215, 225, 245, 275	Seal	AM87588941	\$ 80.00	
 Magnum®: (270, 290, 305, 315, 335, 340 - Class 5)	Sun Shaft For Standard and Suspended MFWD	AM87674583	\$ 630.00	
 7110, 7120, 7130, 7140, 7150, 7230, 7240, 7250, 8910, 8920, 8930, 8940, 8950	Sun Shaft Replaces 1961770C1, 86016137	AM250728A1	\$ 175.00	
 MX80C, MX90C, MX100, MX100C, MX110, MX120, MX135 - w/ 20:19 Axle Ratio Will not work on 20:22 Axle Ratio	Sun Shaft	AM319759A3	\$ 320.00	
 MX180, MX200, MX210, MX220, MX230	Sun Shaft For 10-Bolt Hub	AM302198A2	\$ 270.00	
 MX210, MX215, MX230, MX245, MX255, MX275, MX285, MX305, Magnum®: 215, 245, 255, 275, 305	Sun Shaft	AM281982A3	\$ 315.00	
 8910, 8920, 8930, 8940, 8950, MX180, MX200, MX210, MX215, MX230, MX240, MX245, MX255, MX270, MX275, MX285, MX305, Magnum®: 180 Non Tier 4B, 190, 210, 215, (225, 275, 290 - w/ DANA® MFWD Axle), (235, 260, 305, 315 - w/ DANA® MFWD Axle w/o CVT), 245, 255	Oil Seal, Sunshaft 0.499" Wide, 1.563" ID, 2.129" OD Replaces 86508079, 87759992	AM128647A1	\$ 45.00	
Magnum®: 290, 315, 340 - w/ DANA® Class V Axle	Upper Trunnion Bearing	AM87674552	\$ 184.00	
Magnum®: ((290, 340 - w/o CVT), 335 - w/ DANA® Class V Axle)	Upper Trunnion Bearing, MFWD Pivot Housing	AM87674552	\$ 184.00	

Case IH®—Tractor



Mechanical Front Wheel Drive Parts

Application	Description	Part Number	Retail Price	Core
 MX180, MX200, MX210, MX220, MX230	Inner Bearing, Cone	AM1277343C1	\$ 66.50	
(MX210, MX215, MX230, MX240, MX245, MX255, MX270, MX275, MX285, MX305 - w/ 12-Bolt Hubs), Magnum®: (215, 245, 275, 305 - w/ 12-Bolt Hubs), (235, 260, 290, 315 - Tier 2 w/ Class 4.75 Axle w/o CVT)	Bearing Cup, Inner Planetary Hub 1.9375" Wide, 7.1875" OD	AML31698	\$ 72.00	
 (7110, 7120, 7130, 7140, 7150, 7210, 7220, 7230, 7240, 7250, 8910, 8920, 8930, 8940, 8950 - w/ MFWD Axle)	Needle Bearing	AM78831C1	\$ 0.65	

MFWD Differentials and Components

Application	Description	Part Number	Retail Price	Core
7110, 7120, 7130, 7140, 7150, 7210, 7220, 7230, 7240, 7250	Differential Carrier Assembly, MFWD	AM1961734C1	\$ 4500.00	
MX210, MX215, MX230, MX245, MX255, MX275, MX285, MX305, Magnum®: 180, 190, 210, 215, 225, 235, 245, 260, 275, 290, 305, 315	Differential Carrier Assembly, MFWD For Axles w/ 10-Bolt Hubs w/ Differential Lock Replaces 87404543	AM87324474	\$ 7000.00	
 MX210, MX215, MX230, MX245, MX255, MX275, MX285, MX305, Magnum®: 215, 245, 275, 305	Differential Carrier Assembly, MFWD For Axles w/ 10-Bolt or 12-Bolt Hubs w/o Differential Lock Replaces 345688A1, 345688A2	AM345688A4	\$ 1750.00	
MX210, MX215, MX230, MX245, MX275, Magnum®: 180, 190, 210, 215, 225, 245, 255, 275	Differential Carrier Assembly, MFWD For Axles w/ 10-Bolt Hubs w/o Differential Lock Replaces 87404055	AM87324562	\$ 4750.00	
 MX210, MX215, MX230, MX245, MX255, MX275, MX285, MX305, Magnum®: 215, 235, 245, 255, 275, 305 - w/ 12-Bolt Hubs	Differential Carrier Assembly, MFWD For Axles w/o Differential Lock Replaces 87404092	AM87324564	\$ 7300.00	
 MX210, MX230, MX255, MX285	Differential Carrier Assembly, MFWD For Axles w/ 12-Bolt Hubs w/ Differential Lock Replaces 87324510	AM87404542	\$ 11200.00	
((MX210, MX230, MX255, MX285 ASN MY00193740), MX215, MX245, MX275, MX305 - w/ 12-Bolt Hubs w/ Differential Lock), Magnum®: (215, 245, 275, 305 - w/ 12-Bolt Hubs w/ Differential Lock), (235, 260, 290, 315 - w/ Class 4.75 Axle w/o CVT)	Differential Carrier, MFWD Bare Carrier Ring Gear and Pinion Not Included	AM87324513	\$ 1650.00	
(MX210, MX215, MX230, MX245 - w/ 10-Bolt Hubs w/ Differential Lock), (MX210, MX215, MX230, MX245, MX255, MX275, MX285, MX305 - w/ 12-Bolt Hubs w/ Differential Lock), Magnum®: (215, 245 - w/ 10-Bolt Hubs w/ Differential Lock), (215, 245, 275, 305 - w/ 12-Bolt Hubs w/ Differential Lock), (235, 260, 290, 315 - w/ Class 4.75 Axle w/o CVT)	Differential Housing Assembly, MFWD w/ Bare Carrier Differential, Ring Gear and Pinion Not Included Replaces 87310140, 87404545	AM87324492	\$ 5250.00	
 7110, 7120, 7130, 7140, 7150, 7210, 7220, 7230, 7240, 7250, 8910, 8920, 8930, 8940, 8950, MX180, MX200, MX210, MX215, MX220, MX230, MX240 ASN JJA0105000, MX245, MX270, MX275, Magnum®: 180, 190, 210, 215, 225, 245, 275	Ring Gear and Pinion Set, MFWD Replaces 84427940	AM1968293C1	\$ 320.00	
 MX100, MX110, MX120, MX135, MX150, MX170	Ring Gear and Pinion Set, MFWD 10 and 31 Tooth, 20.29" Ratio	AM247559A1	\$ 1585.00	

Case IH®—Tractor

Application	Description	Part Number	Retail Price	Core
 (MX180, MX200, MX220 ASN JJA0105000), MX210, MX230, MX240, MX255, MX270, MX285	Ring Gear and Pinion Set, MFWD 30 km/hr	AM321516A1	\$ 655.00	
MX210, MX215, MX230, MX245, MX255, MX275, MX285, MX305, Magnum®: 215, 235, 245, 255, 260, 275, 290, 305, 315	Ring Gear and Pinion Set, MFWD 12-Bolt	AM87324538	\$ 950.00	
(MX210, MX230 ASN MY00195879 - w/ 10-Bolt Hubs w/ Differential Lock), (MX215, MX245 - w/ 10-Bolt and 12-Bolt Hubs w/ Differential Lock), ((MX210, MX230, MX255, MX285 ASN MY00193740), MX275, MX305 - All w/ 12-Bolt Hubs w/ Differential Lock), Magnum®: (215, 245 - w/ 10-Bolt and 12-Bolt Hubs w/ Differential Lock), (235, 260, 290, 315 - w/ Class 4.75 Axle w/o CVT), (275, 305 - w/ 12-Bolt Hubs w/ Differential Lock)	Differential Gear Kit, MFWD Includes Bevel Gears, Pinion Gears, Cross Shaft, Thrust Washers	AM87324491	\$ 1250.00	
(MX180, MX200, MX220, MX240, MX270 ASN JJA104999), MX210, MX215, MX230, MX245, (MX255, MX285 - w/ 12-Bolt Hubs), MX275, MX305, Magnum®: 215, 245, 275, 305	Differential Clutch Disc and Gear Kit, MFWD Includes Bevel Gears, Pinion Gears, Cross Shaft, Clutch Discs, Clutch Plates and Thrust Washers For Axles w/o Differential Lock Replaces 377176A1, 87775804	AM377176A3	\$ 1350.00	
(MX210, MX230 BSN MY00164725 w/ 10-Bolt Hubs), (MX210, MX230, MX255, MX285 BSN MY00182905 w/ 12-Bolt Hubs)	Differential Clutch Disc Kit, MFWD Includes (13) Clutch Discs and (14) Clutch Plates For Axles w/ Differential Lock	AM87405209	\$ 725.00	
(MX210, MX230 ASN MY00195879 w/ 10-Bolt Hubs w/ Differential Lock), ((MX210, MX230, MX255, MX285 ASN MY00193740), MX275, MX305 - w/ 12-Bolt Hubs w/ Differential Lock), (MX215, MX245 - w/ 10-Bolt and 12-Bolt Hubs w/ Differential Lock), Magnum®: (215, 245 - w/ 10-Bolt and 12-Bolt Hubs w/ Differential Lock), (235, 260, 290, 315 - Tier 2 w/ Class 4.75 Axle w/o CVT), (275, 305 - w/ 12-Bolt Hubs w/ Differential Lock)	Differential Clutch Disc Kit, MFWD Includes (9) Clutch Discs and (10) Clutch Plates	AM87324488	\$ 515.00	
 Magnum®: 180, 190, 200, 210, 215, 220, 225, 235, 240, 245, 250, 260, 275, 280, 285, 290, 305	Disc and Plate Kit For 10-Bolt Hub w/ Differential Lock	AM377177A3	\$ 470.00	
(MX210, MX230 BSN MY00164725 w/ 10-Bolt Hubs), (MX210, MX230, MX255, MX285 BSN MY00182905 w/ 12-Bolt Hubs)	Differential Clutch Driver, MFWD For Axles w/ Differential Lock	AM87404485	\$ 360.00	
(MX210, MX230 BSN MY00164725 w/ 10-Bolt Hubs), (MX210, MX230, MX255, MX285 BSN MY00182905 w/ 12-Bolt Hubs)	Differential Clutch Piston, MFWD For Axles w/ Differential Lock	AM87404477	\$ 275.00	
((MX210, MX230 ASN MY00195879), MX215, MX245 - All w/ 10-Bolt Hubs), ((MX210, MX230, MX285 ASN MY00193740), MX215, MX245, MX255 ASN MY00184588, MX305 - All w/ 12-Bolt Hubs), Magnum®: (215, 245 - w/ 10-Bolt Hubs), (215, 245, 275, 305 - w/ 12-Bolt Hubs)	Differential Clutch Piston, MFWD For Axles w/ Differential Lock	AM87324486	\$ 220.00	
3220 ASN 11070000, 3230, 4210, 4230, 4240, 5120, 5130, 5140, 5220, 5230, 5240, 5250 - w/ Cab	Solenoid, MFWD Differential Lock	AM1971474C3	\$ 162.68	

Case IH®—Tractor





Mechanical Front Wheel Drive Parts

Application	Description	Part Number	Retail Price	Core
(MX210, MX230, MX255, MX285 ASN MY00193740 w/ 12-Bolt Hubs w/ Differential Lock), (MX210, MX230, MX255, MX285 ASN MY00195744 w/ 12-Bolt Hubs w/o Differential Lock), (MX215, MX245, MX275, MX305 - w/ 12-Bolt Hubs w/ or w/o Differential Lock), Magnum®: (215, 245, 275, 305 - w/ 12-Bolt Hubs w/ or w/o Differential Lock), (235, 260, 290 - w/ Class 4.75 Axle w/o CVT), 315 w/ Class 4.75 Axle w/ or w/o CVT	Differential Carrier Yoke, MFWD	AM87324528	\$ 300.00	
MX210, MX215, MX230, MX245, MX255, MX275, MX285, Magnum®: (215, 245, 275, 305 - w/ 12-Bolt Hubs w/ or w/o Differential Lock), (235, 260, 290, 315 - w/ Class 4.75 Axle w/o CVT)	Differential Carrier Bearing Cone, MFWD	AM87324516	\$ 365.00	
MX210, MX215, MX230, MX245, MX275, Magnum®: 180, 190, 210, 215, 225, 245, 255, 275	End Yoke For Axles w/ 10-Bolt Hub w/ Differential Lock	AM87324552	\$ 250.00	
(MX210, MX215, MX230, MX245 - w/ 10-Bolt Hubs w/ Differential Lock), (MX210, MX215, MX230, MX245, MX255, MX275, MX285, MX305 - w/ 12-Bolt Hubs w/ Differential Lock), Magnum®: (215, 245 - w/ 10-Bolt Hubs w/ Differential Lock), (215, 245, 275, 305 - w/ 12-Bolt Hubs w/ Differential Lock), (235, 260, 290, 315 - w/o CVT w/ DANA® Class 4.75 Differential)	Seal Retainer	AM87404997	\$ 350.00	
(MX210, MX215, MX230, MX245 - w/ 10-Bolt Hubs w/ Differential Lock and w/ 12-Bolt Hubs w/ Differential Lock), (MX255, MX275, MX285, MX305 - w/ 12-Bolt Hubs w/ Differential Lock), Magnum®: (235, 260, 290, 315 - w/ DANA® Class 4.75 Differential w/o CVT)	Seal	AM87404471	\$ 85.00	
(MX210, MX230, MX255, MX285, MX215, MX245, MX275, MX305 - w/ Standard Axle w/ 12-Bolt Hubs w/ and w/o Differential Lock), ((MX210, MX230, MX255, MX285 ASN MY00184588), MX215, MX245, MX275, MX305 - w/ Suspended Axle w/ 12-Bolt Hubs w/ Differential Lock), ((MX255, MX285 ASN MY00195684), MX275, MX305 - w/ Suspended Axle w/ 12-Bolt Hubs w/o Differential Lock), Magnum®: (215, 245, 275, 305 - w/ Standard Axle w/ 12-Bolt Hubs w/ and w/o Differential Lock or w/ Suspended Axle w/ 12-Bolt Hubs w/ Differential Lock), (235, 260, 290 - w/o CVT and w/ DANA® Class 4.75 Differential), (275, 305 - w/ Suspended Axle w/ 12-Bolt Hubs w/o Differential Lock), 315 w/ DANA® Class 4.75 Differential *Models ASN MY00193740 w/ Differential Lock or ASN MY00195744 w/o Differential Lock	Shim Kit, Differential Pinion Shaft	AM87324518	\$ 200.00	

Case IH®—Tractor













Application	Description	Part Number	Retail Price	Core
((MX210, MX230 ASN MY00184588), MX215, MX245 - w/ Suspended Axle w/ 12-Bolt Hubs w/ Differential Lock), (MX210*, MX215, MX230*, MX245, MX255*, MX275, MX285*, MX305 - w/ Standard Axle w/ 12-Bolt Hubs w/ or w/o Differential Lock), (MX255**, MX285**, MX305 - w/ Suspended Axle w/ 12-Bolt Hubs w/ and w/o Differential Lock), MX275 w/ Suspended Axle w/ 12-Bolt Hubs w/o Differential Lock, Magnum®: (215, 245 - w/ Suspended Axle w/ 12-Bolt Hubs w/ Differential Lock), (215, 245, 275, 305 - w/ Standard Axle w/ 12-Bolt Hubs w/ or w/o Differential Lock), (235, 260, 290 w/o CVT and w/ DANA® Class 4.75 Differential), (275, 305 - w/ Suspended Axle w/ 12-Bolt Hubs w/ and w/o Differential Lock), 315 w/ DANA® Class 4.75 Differential *ASN MY00193740 w/ Differential Lock or ASN MY00195744 w/o Differential Lock **ASN MY00184588 w/ Differential Lock or ASN MY00195684 w/o Differential Lock	Shim Kit, Differential Carrier Yoke	AM87324536	\$ 180.00	
7110, 7120, 7130, 7140, 7150, 7210, 7220, 7230, 7240, 7250, 8910, 8920, 8930, 8940, 8950, MX180, MX200, (MX210, MX215, MX230, MX245 - w/ 10-Bolt or 12-Bolt Hubs), MX220, MX240, MX275 w/o Differential Lock w/ 10-Bolt Hubs, (MX255, MX275, MX285, MX305 - w/ 12-Bolt Hubs), Magnum®: (215, 245 - w/ 10-Bolt or 12-Bolt Hubs), (235, 260, 290, 315 - w/ Class 4.75 Axle), 275 w/ 10-Bolt Hubs, (275 w/ Differential Lock, 305 - w/ 12-Bolt Hubs)	Adjusting Ring, MFWD Differential Bearing	AM1277233C1	\$ 180.00	
(MX210, MX215, MX230, MX245, MX255, MX275, MX285, MX305, Magnum®: (215, 245 - w/ 10-Bolt or 12-Bolt Hubs w/ Differential Lock), (235, 260, 290 - w/o CVT and w/ DANA® Class 4.75 Differential), 315 w/ DANA® Class 4.75 Differential, (275, 305 - w/ 12-Bolt Hubs w/ Differential Lock)	Nipple Coupling, MFWD	AM87404480	\$ 95.00	

MFWD Driveshafts

Application	Description	Part Number	Retail Price	Core
 (MX80C, MX90C, MX100C - w/ 20:19 Axle Ratio), MX100, MX110, MX120, MX135	Drive Shaft Assembly	AM319758A3	\$ 940.00	
 (MX180, MX200, MX220, MX240, MX270 ASN 105000), MX210, MX230, MX255, MX285	Drive Shaft Assembly, Right Hand For Axles w/o Differential Lock	AM395734A1	\$ 975.00	
	Drive Shaft Assembly, Left Hand For Axles w/o Differential Lock	AM395735A1	\$ 975.00	
 (MX210, MX230* - w/ Standard or Suspended Axle w/ 10-Bolt Hubs), (MX210, MX230, MX255, MX285** - w/ Standard or Suspended Axle w/ 12-Bolt Hubs)	Drive Shaft Assembly, Right Hand For Axles w/ Differential Lock	AM87404999	\$ 700.00	
	Drive Shaft Assembly, Left Hand For Axles w/ Differential Lock	AM87405000	\$ 675.00	
	*BSN MY00164725 w/ Standard Axle or BSN MY00182861 w/ Suspended Axle **BSN MY00182905 w/ standard Axle or BSN MY00178966 w/ Suspended Axle			
 7230, 7240, 7250, 8910, 8920, 8930, 8940, 8950, MX180, MX200, MX220, MX240, MX270	Drive Shaft Shield	AM282500A2	\$ 175.00	

Case IH®—Tractor

Mechanical Front Wheel Drive Parts





Application	Description	Part Number	Retail Price	Core
 MX210, MX215, MX230, MX245, MX255, MX275, MX285, MX305, Magnum®: 180, 190, 210, 215, 225, 235, 245, 260, 275, 290, 305, 315	Axle Shaft Assembly, Right Hand w/ Differential Lock	AM87324476	\$ 780.00	
 8910, 8920, 8930, 8940, 8950	Axle Shaft, Right Hand Axle Shaft, Left Hand	AM250733A1 AM250732A1	\$ 540.00 \$ 679.00	
(MX180, MX200, MX220, MX240, MX270 BSN JJA0107600)	Axle Shaft, Right Hand Replaces 302763A1, 395734A1, 87776177	AM302762A1	\$ 340.00	
 7110, 7120, 7130, 7140, 7150, 7230, 7240, 7250	Front Drive Line With Hub and (2) U-Joints	AM93381C1-K	\$ 150.00	
 MX210, MX215, MX230, MX245, MX255, MX275, MX285, MX305, Magnum®: 215, 245, 255, 275, 305	Inner Yoke, Right Hand w/ Differential Lock Inner Yoke, Left Hand w/ Differential Lock	AM87325892 AM87307641	\$ 815.00 \$ 875.00	
 MX210, MX215, MX230, MX245, MX255, MX275, MX285, MX305, Magnum®: 215, 245, 255, 275, 305	Inner Yoke, Right Hand w/o Differential Lock Inner Yoke, Left Hand w/o Differential Lock	AM395741A1 AM395743A1	\$ 715.00 \$ 800.00	
 MX210, MX215, MX230, MX245, MX255, MX275, MX285, MX305, Magnum®: 215, 245, 255, 275, 305	Outer Yoke	AM395737A1	\$ 300.00	
 MX210, MX215, MX230, MX245, MX255, MX275, MX285, MX305, Magnum®: 215, 245, 255, 275, 305	Center Yoke	AM395740A1	\$ 245.00	
 8910, 8920, 8930, 8940, 8950, MX180, MX200, MX220, MX240, MX270	U-Joint Yoke, Center Replaces 231020A1	AM231020A2	\$ 325.00	
 8910, 8920, 8930, 8940, 8950, MX180, MX200, MX220, MX240, MX270	U-Joint Yoke, Outer Replaces 231021A1	AM231021A2	\$ 195.00	
MX180, MX200, MX220, MX240, MX270 SN JJA0105000-JJA0107599	U-Joint Kit, Spider Includes (2) U-Joints, (2) Caps and (2) Snap Rings	AM381174A1	\$ 90.00	
 7110, 7120, 7130, 7140, 7150	U-Joint, Spider Replaces 126761, 133137C91, 84355343	AM1961778C1	\$ 55.00	
 8910, 8920, 8930, 8940, 8950, (MX180, MX200, MX220, MX240, MX270 BSN JJA0107599)	U-Joint, Spider	AM247298A1	\$ 48.00	
MX100, MX110, MX120, MX135, MX150, MX170	U-Joint, Spider	AM229108A1	\$ 100.00	
 MX150, MX170	Flange Replaces 220072A2, 247561A1	AM247247A1	\$ 165.00	
 Magnum®: 290, 305, 310, 315 - Class 5	Steer Sensor Cable For Standard and Suspended MFWD	AM87674584	\$ 285.00	
MXM175, MXM190, Maxxum®: 100, 110 Excluding CVX, 115, (120, 130 - Excluding CVT and CVX), 125, 135, 140, 145, 150, Optum™: (270, 300 - CVX), Puma®: 165, (170, 215, 225, 230, 240 - CVT or CVX), 180 MultiController or CVX, (185, 200, 220 - Tier 4B CVT or CVX), 195, 210	Friction Disc, MFWD Engagement Clutch	AM5163844	\$ 9.63	

Case IH®—Tractor

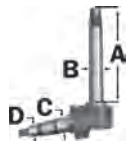
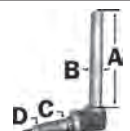

MFWD	Application	Description	Part Number	Retail Price	Core
	MX180, MX200, MX210, MX215, MX220, MX230, MX240, MX245, MX255, MX270, MX275, MX285, MX305, Magnum®: 180, 190, 210, 215, 225, 235, 245, 255, 260, 275, 290, 305, 315	Seal	AM302957A1	\$ 24.00	

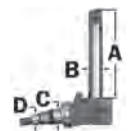
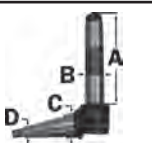
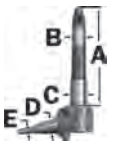
Spindles and Steering Arms

Spindles are forged from high grades of alloy steel, machined and assembled to exact specifications that meet or exceed OEM specifications.

	Application	Description		Part Number	Retail Price	Core
	485, 495, (585, 685, 695 - w/ High Clearance Bolster w/o Cab), 595, 3220, 3230, 4210, 4230, 4240 - All w/ Swept-Back Axle	Spindle A - 8.312 B - 1.667 C - 1.375 D - 0.842	Right or Left Hand	AM1332982C1	\$ 273.23	
	685 w/ High Clearance Bolster w/o Cab, 885, 895, 995, 3220, 3230, 4210, 4230, 4240, C50, C60, C70, C80, C90, C100, CX50, CX60, CX70, CX80, CX90, CX100 - w/ Straight Adjustable Axle	Spindle A - 9.50 B - 1.667 C - 1.78 D - 1.375	Right or Left Hand	AM3125872R91	\$ 388.73	
	3220, 3230, 4210, 4230, 4240, C50, C60, C70, C80, C90, C100, CX50, CX60, CX70, CX80, CX90, CX100	Spindle A - 12.125 B - 1.667 C - 1.78 D - 1.375	Right or Left Hand	AM67535C91	\$ 213.99	
	3230, 4210, 4230, 4240, CX70, CX80, CX90, CX100, MX80C, MX90C, MX100	Spindle A - 11.25 B - 1.667 C - 1.78 D - 1.375	Right or Left Hand	AM3121261R91	\$ 218.49	
	5120, 5130, 5140, 5220, 5230, 5240, 5250	Spindle A - 12.884 B - 2.178 C - 2.364 D - 1.77	Right Hand Left Hand	AM1533043C2 AM1533042C2	\$ 300.00 \$ 300.00	
	7110, 7120, 7130, 7140, 7150, 7210, 7220, 7230, 7240, 7250, 8910, 8920, 8930, 8940, 8950, MX100, MX110, MX120, MX135, MX150, MX170, MX180, MX200, MX210, MX220, MX230, MXM120, MXM130, MXM140, MXM155, MXM175, MXM190	Spindle Replaces 1259519C2, 1259519C92, 86503132, 87773201 A - 12.00 B - 2.499 C - 2.624 D - 1.687	Right or Left Hand	AM1259519C3	\$ 478.17	
	MXU100, MXU110, MXU115, MXU125, MXU130, MXU135, Maxxum®: 100, 110, 115	Spindle A - 12.00 B - 1.722 C - 1.934 D - 1.625 E - 0.843	Right or Left Hand	AME9NN3105EB	\$ 162.00	
	5120, 5130, 5140, 5220, 5230, 5240, 5250	Steering Arm	Right Hand	AM1533018C1	\$ 385.00	

Case IH®—Tractor



	Application	Description		Part Number	Retail Price	Core
	7110, 7120, 7130, 7140, 7150, 7210, 7220, 7230, 7240, 7250, 8910, 8920, 8930, 8940, 8950, MX100, MX110, MX120, MX135, MX150, MX170	Steering Arm 36 Tooth	Right Hand	AM1259527C2	\$ 102.11	
			Left Hand	AM1259526C2	\$ 120.13	
	MX180, MX200, MX210, MX220, MX230, MXM190	Steering Arm	Right Hand	AM235392A1	\$ 300.00	
			Left Hand	AM235393A1	\$ 300.00	
	(5088, 5288, 5488 w/ Adjustable High Capacity Front Axle), 7110, 7120, 7130, 7140, 7150, 7210, 7220, 7230, 7240, 7250, 8910, 8920, 8930, 8940, 8950, MX100, MX110, MX120, MX135, MX150, MX170, MX180, MX200, MX210, MX220, MX230, MXM120, MXM130, MXM140, MXM155, MXM175, MXM190, Cotton Pickers: (1800, 1844, 2022, 2044, 2055, 2155, 2555, CPX420 - w/ Adjustable Axle w/o Guide Power)	Spindle Bushing		AM1259518C1	\$ 36.23	

Wheel Hubs







Application	Description	Part Number	Retail Price	Core
3220 ASN 11070000, 3230, 4210, 4230, 4240, C50, C60, C70, C80, C90, C100, CX50, CX60, CX70, CX80, CX90, CX100, MX80C, MX90C, MX100C	Wheel Hub, 6-Bolt Includes Installed Studs Replaces 67527C92	AM67527C91	\$ 110.00	
(5120, 5130, 5140, 5220, 5230, 5240, 5250 ASN JJF1011413*) *Models BSN JJF1011412 Requires (6) 133112A1 Wheel Bolts	Wheel Hub, 6-Bolt Replaces T102034	AM1533896C1	\$ 443.59	
7110, 7120, 7130, 7140, 7150, 7210, 7220, 7230, 7240, 7250, 8910, 8920, 8930, 8940, 8950, MX100, MX110, MX120, MX135, MX150, MX170, MX180, MX200, MX210, MX220, MX230	Wheel Hub, 8-Bolt	AM1259528C1	\$ 332.50	

Tie Rods and Components













Application	Description	Part Number	Retail Price	Core
 Maxxum®: 115, 125, 140, Puma®: 115, 125, 140, 155	Tie Rod Assembly 58 7/8" Long M18x1.50" Right Hand Thread M24x1.50" Right Hand Thread	AM87332622	\$ 175.00	
 Magnum®: 210, 215, 220, 225, 235, 240, 245, 250, 260, 275, 280, 285	Tie Rod For 12-Bolt Axle	AM435664A1	\$ 200.00	
 385, 395, 3220, 3230, 4210, C50, C60, C70, C80, C90, C100, CX50, CX60, CX70, CX80, CX90, CX100, MX80C, MX90C, MX100C	Tie Rod 3.75" Long, 0.875" Diameter 16 Right Hand Thread	AM1537872C1	\$ 65.00	
385, 485 w/ Swept-Back Axle, 585	Tie Rod Tube 16.44" Long, 1" OD Replaces 527659R1	AM527659R2	\$ 36.50	
385, 485, 585 - w/ Straight Adjustable Axle	Tie Rod Tube 16.19" Long, 1" OD	AM67529C1	\$ 40.00	

Prices Subject to Change without Prior Notice. The use of original equipment manufacturer (OEM) part numbers or trademarks, e.g. Case® and John Deere®, are for reference purposes only and for indicating product use and compatibility. Our company and the listed replacement parts contained herein are not sponsored, approved or manufactured by the OEM. All parts are New unless designated Reman in the description.













Case IH®—Tractor

Application	Description	Part Number	Retail Price	Core
395, 485, 495, 585, 595, 685, 695, 885, 895	Ball Joint 7.54" Overall Length M20x1.50" Right Hand External Thread M22x1.50" Right Hand External Thread Replaces 1968463C1, 1968468C1, 83957098	AMZP0501310060	\$ 52.50	
395, 495, 595, 695, 895, 995, 3220, 3230, 4210, 4230, 4240, C50, C60, C70, C80, C90, C100, CX50, CX60, CX70, CX80, CX90, CX100, (MX80C, MX90C, MX100C - w/ 20:14 Ratio Axle) - w/ MFWD Axle	Tie Rod End 6.625" Long M18x1.50" Left Hand Internal Thread Replaces 1537611C1, 81875596, 81878537	AMVPJ3210	\$ 118.80	
395, 495, (585, 685, 885 ASN 18000), 595, 695, 895, 995 - w/ ZF Front Axle	Outer Tie Rod 9.75" Long M22x1.50" Right Hand Thread	AM1968464C1	\$ 47.50	
395, 495, 595, 695, 895, 995, 2120, 2130, 2140, 2150, 3220, 3230, 4210, 4230, 4240, C50, C60, C70, C80, C90, C100, CX70, CX80, CX90, CX100, JX1070N, JX1075N, JX1095N, MX80C, MX90C, MX100C, Farnall®: 75N, 85N, 95N	Ball Joint, Left Hand 7.04" Long M20x1.50" Right Hand Thread M18x1.50" Left Hand Thread Replaces 48084983, 83957148, 87714488	AMCAR49006	\$ 61.75	
2120, 2130, 2140	Tie Rod End, Right Hand 4" Long M20x1.50" Right Hand Thread Replaces 1966150C1, 83930109, K261842	AM48084965	\$ 78.50	
2120, 2130, 2140 - w/ Diesel Engine	Tie Rod End, Left Hand 4" Long M20x1.50" Left Hand Thread Replaces 107634, 1966151C1, K261841	AM48084966	\$ 39.00	
3220, 3230, 4210, 4230, 4240, C50, C60, C70, C80, C90, C100, CX50, CX60, CX70, CX80, CX90, CX100, (MX80C, MX90C, MX100C - w/ 20:14 Ratio Axle)	Tie Rod End, Right Hand 1.10" Long, 6.75" Diameter 18 mmx2.50" Right Hand Thread Replaces 137048A1	AM81878543	\$ 149.88	
 5120, 5130, 5140, 5150, 5220, 5230, 5240, 5250	Tie Rod and Coupling, Left Hand Replaces 48084958	AM1997712C2	\$ 210.00	
 5120, 5130, 5140, 5150, 5220, 5230, 5240, 5250	Tie Rod End, Right Hand 8" Long M24x1.50" Right Hand Thread	AM126145A1	\$ 113.50	
 5120, 5130, 5140, 5220, 5230, 5240, 5250	Tie Rod and Coupling 205 mm Long M22x1.50" Left Hand Thread Replaces 199713C1	AM1997713C2	\$ 210.00	
 5120, 5130, 5140, 5220, 5230, 5240, 5250	Tie Rod 4.125" Long M24x1.50" Right Hand Thread	AM1531204C1	\$ 15.00	
 5120, 5130, 5140, 5220, 5230, 5240, 5250	Tie Rod 36.87" Long, 1.10" Diameter	AM1531203C1	\$ 40.00	
5120, 5130, 5140, 5220, 5230, 5240, 5250 - w/ MFWD	Tie Rod End 8" Long M24x1.50 Left Hand Thread Replaces D149730	AM126144A1	\$ 80.00	

Case IH®—Tractor

Application	Description	Part Number	Retail Price	Core
 5130, 5140, 5230, 5240, 5250 - w/ 68"-96" Axle Extensions	Tie Rod Tube 35.87" Long, 1.25" OD, 8 Cross Holes M24x1.50" Internal Thread	AM1534224C1	\$ 42.71	
 7110, 7120, 7130, 7140, 7150 - w/ MFWD	Tie Rod 5.375" Long, 1.125" Diameter 12 Right Hand Thread	AM1277451C1	\$ 35.00	
 7110, 7120, 7130, 7140, 7150 - w/ MFWD	Tie Rod 5.375" Long, 1.125" Diameter 12 Left Hand Thread	AM1277452C1	\$ 35.00	
 7110, 7120, 7130, 7140, 7150, 7210, 7220, 7230, 7240, 7250, 8910, 8920, 8930, 8940, 8950 - w/ Front Wheel Assist	Tie Rod End, Right Hand	AM128604A1	\$ 90.00	
 7110, 7120, 7130, 7140, 7150, 7210, 7220, 7230, 7240, 7250, 8910, 8920, 8930, 8940, 8950 - w/ Front Wheel Assist	Tie Rod End, Left Hand	AM128609A1	\$ 90.00	
 7110, 7120, 7130, 7140, 7150, 7210, 7220, 7230, 7240, 7250, 8910, 8920, 8930, 8940, 8950, MX100, MX110, MX120, MX135, MX180, MX200, MX220, MXM120, MXM130, MXM140, MXM155, MXM175, MXM190, Puma®: 165, 180, 195, 210 - 2WD	Tie Rod 4.10" Long, 1.125" Diameter 12 Right Hand Thread	AM1280658C1	\$ 26.00	
 7110, 7120, 7130, 7140, 7150, 7210, 7220, 7230, 7240, 7250, 8910, 8920, 8930, 8940, 8950, MX100, MX110, MX120, MX135, MX180, MX200, MX220, MXM120, MXM130, MXM140, MXM155, MXM175, MXM190, Puma®: 165, 180, 195, 210 - 2WD	Tie Rod 7 Holes, 15.275" Long, 1.185" Diameter	AM1280662C1	\$ 35.00	
 7110, 7120, 7130, 7140, 7150, 7210, 7220, 7230, 7240, 7250, 8910, 8920, 8930, 8940, 8950, MX100, MX110, MX120, MX135, MX150, MX170, MX180, MX200, MX210, MX220, MX230, MXM120, MXM130, MXM140, MXM155, MXM175, MXM190 - 2WD	Tie Rod Tube 17.06" Long	AM1280657C1	\$ 30.00	
 8910, 8920, 8930, 8940, 8950	Tie Rod Tube 33.44" Long	AM247290A1	\$ 65.00	
 JX55, JX60, JX65, JX70, JX75, JX80, JX85, JX90, JX95, Farmall®: 60, 70, 80, 90, 95	Tie Rod End 21 3/8" Long Replaces 5086980	AM5085085	\$ 60.00	
 JX55, JX60, JX65, JX70, Farmall®: 60, 70	Tie Rod 51.94" Long 1 1/8" Internal Threads	AM5135075	\$ 200.00	
JX70U, JX80U, JX90U, JX100U, JX1070U, JX1080U, JX1090U, JX1100U, Farmall®: 65C, 75C, 85U, 90C, 95U, 100C, 105U, 110C, 120C	Tie Rod End 4" Long M24x1.50" Right Hand Thread	AM5178390	\$ 58.50	
 MX180, MX200, MX210, MX215, MX220, MX230, MX240, MX245, MX255, MX270, MX275, MX285, MX305, Magnum®: 215, 245, 255, 275, 305	Tie Rod M38 Right Hand Thread	AM87455743	\$ 295.00	

Case IH®—Tractor

	Application	Description	Part Number	Retail Price	Core
	MX180, MX200, MX210, MX215, MX220, MX230, MX240, MX245, MX255, MX270, MX275, MX285, MX305, Magnum®: 215, 245, 255, 275, 305	Tie Rod M38 Left Hand Thread	AM87455742	\$ 295.00	
	MX180, MX200, MX210, MX215, MX220, MX230, MX240, MX245, MX255, MX270, MX275, MX285, MX305, Magnums: 215, 245, 255, 275, 305	Tie Rod Tube M38 Internal Thread	AM87455737	\$ 95.00	
	MX180, MX200, MX210, MX215, MX220, MX230, MX240, MX245, MX255, MX270, MX275, MX285, MX305, Magnum®: 215, 245, 255, 275, 305	Jam Nut M38 Right Hand Thread	AM87455739	\$ 37.00	
	MX180, MX200, MX210, MX215, MX220, MX230, MX240, MX245, MX255, MX270, MX275, MX285, MX305, Magnum®: 215, 245, 255, 275, 305	Jam Nut M38 Left Hand Thread	AM87455741	\$ 37.00	
	MX180, MX200, MX210, MX220, MX230, MXM120, MXM130, MXM140, MXM155, MXM175, MXM190	Tie Rod End 4" Long 7/8"x14 Right Hand Internal Thread	AM44995130	\$ 85.00	
	MX210, MX215, MX230, MX245, MX275, Magnum®: 180, 190, 210, 215, 225, 245, 255, 275	Tie Rod Tube For 10-Bolt Axle	AM87455775	\$ 250.00	
	MX210, MX215, MX230, MX245, MX275, Magnum®: 180, 190, 210, 215, 225, 245, 255, 275	Tie Rod, Right Hand 20.21" Long M36x1.50" Right Hand Thread	AM87455779	\$ 425.00	
	MX210, MX215, MX230, MX245, MX275, Magnum®: 180, 190, 210, 215, 225, 245, 255, 275	Tie Rod, Left Hand 20.21" Long M36x1.50" Left Hand Thread	AM87455778	\$ 425.00	
	MX215, MX245, MX275, Magnum®: 180, 190, 210, 215, 225, 245, 275 - All w/ MFWD	Tie Rod Assembly Left Hand Thread Replaces 302645A1, 302647A1, 87776108	AM87455774	\$ 650.00	
	MXM120, MXM130, MXM140, MXM155, MXM175, MXM190, Magnum®: 180, 190, 210, 225, 235, 260, Puma®: 165, 180, 195, 210, 225	Tie Rod End, Left Hand 4.31" Long M24x1.50" Right Hand Thread	AM5198880	\$ 65.00	
	MXU100, MXU110, MXU115	Tie Rod Assembly 54.375" Long M18x1.50" Right Hand Thread M24x1.50" Right Hand Thread	AM5196358	\$ 200.00	
	(MXU100, MXU110, MXU115, MXU125, MXU130, MXU135 - Excluding Pro MultiController), Maxxum®: (100, 110, 115 - Tier 3 Limited or Tier 3 Value)	Outer Tie Rod, Right Hand 19.875" Long, 1.375" Diameter Replaces E9NN3278AA	AM81864106	\$ 119.38	
	MXU100, MXU110, MXU115, MXU125, MXU130, MXU135, Maxxum®: 100, 110, 115, 125, 135, 140, 145, 150	Tie Rod End 3.75" Long, 0.875" ID 14 UNF Right Hand Thread	AM81863813	\$ 39.00	
	MXU100, MXU110, MXU115, MXU125, MXU130, MXU135, Maxxum®: 100, 110, 115, 125, 140	Tie Rod End 4" Long 1 1/4"x12 UNC Right Hand Thread	AM81863815	\$ 200.00	
	MXU100, MXU110, MXU115, MXU125, MXU135, Maxxum®: 100, 110, 115, 120, 125, 130, 140, Puma®: 115, 125, 140	Tie Rod Assembly 58.875" Long M18x1.50" Right Hand Thread M24x1.50" Right Hand Thread	AM5197798	\$ 225.00	

Case IH®—Tractor

Application	Description	Part Number	Retail Price	Core
 MXU100, MXU115, Maxxum®: 100, 110, 115, 125, 135, 140, 145 - All w/ Heavy Duty Axle	Tie Rod 20.50" Long, 1.362" Diameter	AM81863803	\$ 186.00	

Power Steering Cylinders and Components



Application	Description	Part Number	Retail Price	Core
Maxxum®: 100, 110, 115, 120, 125, 130, 140, Puma®: 115, 125, 130, 140, 145, 160 - All w/ MFWD	Power Steering Cylinder Replaces 47582858	AM87521950	\$ 262.00	
Magnum®: 235, 275, 290, 305, 315, 335, 340, 370	Power Steering Cylinder	Right Hand	AM87674620	\$ 1200.00
		Left Hand	AM87674621	\$ 1200.00
Magnum®: 235, 260, 280, 290, 310, 315, 340, 370, 380 - w/ Class 5 Axles	Power Steering Cylinder	AM84336641	\$ 380.00	
485XL, 495XL, 585XL, 595XL, 685XL, 885XL, 895XL, 3210, 3220, 3230, 4210, 4230, 4240, C50, C60, C70, C80, C90, C100, CX50, CX60, CX70, CX80, CX90, CX100, MX80C, MX90C, MX100C	Power Steering Cylinder Replaces 549667R1, 549667R91, 549667R93, 84336125	AM188842A1	\$ 325.00	
5130, 5140, 7130, 7140 - w/ Auto-Guide Steering	Power Steering Cylinder	AM84385653	\$ 2300.00	
7110, 7120, 7130, 7140, 7150, 7210, 7220, 7230, 7240, 7250 - w/ MFWD	Power Steering Cylinder	Right Hand	AM277766A1	\$ 475.00
		Left Hand	AM277765A1	\$ 475.00
		Seal Kit Replaces 1957983C1	AM197267A1	\$ 80.00
8910, 8920, 8930, 8940, 8950 - w/ Front Wheel Assist	Power Steering Cylinder 9" Stroke Replaces 435663A1	Right Hand	AM231008A1	\$ 495.00
		Power Steering Cylinder 9" Stroke Replaces 435662A1	Left Hand	AM231007A1
JX60, JX70, JX75, JX80, JX85, JX90, JX95, JX100, Farnall®: 85A, 95A, 105A, 115A	Power Steering Cylinder For 0.971 Diameter Pin	AM5134221	\$ 335.00	
MX120, MX230, MX240, MX255, MX270, MX285	Power Steering Cylinder DANA® MFWD, Right or Left Hand Replaces 293678A2, 87455650	AM293678A2	\$ 585.00	
MX150, MX170	Power Steering Cylinder	AM300173A1	\$ 710.00	
	Power Steering Ball Joint	AM311446A1	\$ 100.00	
MX210, MX215, MX230, MX245, MX255, MX275, MX285, MX305, Magnum®: 215, 235, 245, 255, 260, 275, 290, 305, 315	Power Steering Cylinder For 12-Bolt Axle	Right Hand	AM87455648	\$ 1995.00
		Left Hand	AM87455647	\$ 1995.00
	Seal Kit Use w/ AM87455647 or AM87455648 Power Steering Cylinder	AM87455632	\$ 180.00	
MX210, MX215, MX230, MX245, MX275, Magnum®: 180, 190, 210, 215, 225, 245, 255, 275	Power Steering Cylinder For 10-Bolt Hub	Right Hand	AM87455637	\$ 730.00
		Left Hand	AM87455636	\$ 700.00
MXM190 w/ MFWD	Power Steering Cylinder Replaces 5164022, 82991196	AM87302891	\$ 304.00	
Ind/Const: 570LXT, 570MXT, 580K, 580L, 580 Super L, 580M, 580 Super M, 580SK, 585G, 586G, 588G	Power Steering Cylinder	AMG107720	\$ 725.00	
485, 495, 585, 595, 685, 695, 885, 895, 995	Power Steering Cylinder End 2.75" Long 7/8"x14 UNF Right Hand Thread For Cast Iron Non-Adjustable Front Axle	AM378817R91	\$ 73.50	
585 BSN 180001, 685, 885	Power Steering Cylinder End 4.812" Long M30x1.50" Right Hand Thread Replaces 3141529R93	AM3141529R91	\$ 104.09	

Case IH®—Tractor

Application	Description	Part Number	Retail Price	Core
5120, 5130, 5140, 5220, 5230, 5240, 5250	Power Steering Cylinder End 4.31" Long, 1.34" OD M22x1.50" Right Hand Thread Replaces 3233186R91	AMT102913	\$ 129.00	
	Power Steering Cylinder End 8.25" Long M22x1.50" Right Hand Thread and M24x1.50" Left Hand Thread	AM83957796	\$ 80.00	
7110, 7120, 7130, 7140, 7150, 7210, 7220, 7230, 7240, 7250, 8910, 8920, 8930, 8940	Power Steering Cylinder End, MFWD	AM1277261C1	\$ 120.00	
7110, 7120, 7130, 7140, 7150, 7210, 7220, 7230, 7240, 7250, 8910, 8920, 8930, 8940, 8950, MX100, MX110, MX120, MX135, MX150, MX170, Cotton Pickers: 1800, 1822 ASN 12691, 1844 ASN 2462, 2022 ASN 13388, 2044 ASN 3300, 2055, 2155, 2555 - All w/ 2WD	Power Steering Cylinder End 0.875" ID, 14 NF Thread Replaces Cylinder End Manufactured by TRW or O&S Bearing Replaces 71820C91	AM1280566C2	\$ 40.00	
MX80C, MX90C, MX110, MX100, MX100C, MX120, MX125, MX150, MX170 - w/ MFWD	Power Steering Cylinder End 10.25" Long	AM247523A1	\$ 120.00	
MX210, MX215, MX230, MX240, MX255, MX285, Magnum®: 235, 255, 260, 290, 315	Power Steering Cylinder End 3.13" Long, 1.41" Diameter 1"x16 UNF Right Hand Thread	AM87455628	\$ 204.00	
MXU100, MXU110, MXU115, Maxxum®: 100, 110, 115	Power Steering Cylinder End 2.875" Long, 1.25" Diameter 12 Right Hand Thread	AM81864115	\$ 35.00	
(1896 BSN 17895000, 2096 ASN 17897500, 5120, 5130, 5140, 5220, 5230, 5240, 5250, MX80C, MX90C, MX100, MX100C, MX110, MX120, MX135, MX150, MX170 - w/ Carraro™ MFWD), McCormick®: (MC80, MC90, MC95, MC100, MC105, MC115, MTX110, MTX120, MTX125, MTX135, MTX140, MTX150, MTX155, MTX165, MTX175, MTX185, MTX200 - w/ Carraro™ MFWD, 2002 and Later)	Power Steering Ball Joint 8.21" Long M22x1.50" and M24x1.50" Right Hand Thread Replaces 247522A1, 83957792, N14377	AM9968018	\$ 75.00	
(MX210, MX215, MX230, MX245, MX255, MX275, MX285, MX305 - w/ 10-Bolt Hubs), Magnum®: (215, 245, 255 w/ Differential Lock - w/ 10-Bolt or 12-Bolt Hubs), 275 w/ Differential Lock w/ 10-Bolt Hubs, (275, 305 - w/ 12-Bolt Hubs)	Power Steering Cylinder Pin	AM292565A1	\$ 135.00	

Power Steering Orbit Motors

Application	Description	Part Number	Retail Price	Core
JX55, JX60, JX65, JX70, JX75, JX80, JX85, JX90, JX95, Farmall®: 65A, 75A, 85A, 95A, 105A, 115A	Power Steering Orbit Motor Replaces 5126023, 5140383, 5146638	AM5165251	\$ 1058.00	



Transmission Components

Application	Description	Part Number	Retail Price	Core
7110, 7120, 7130, 7140, 7150, 7210, 7220, 7230, 7240, 7250, 8910, 8920, 8930, 8940, 8950, MX180, MX200, MX210, MX230, MX240, MX255, MX270, MX285	Clutch Disc (9) Required	AM1285975C2	\$ 21.00	
	Transmission Separator Plate (9) Required	AM1285974C1	\$ 9.50	
7110, 7120, 7130, 7140, 7150, 7210, 7220, 7230, 7240, 7250, 8910, 8920, 8930, 8940, 8950, MX180, MX200, MX210, MX215, MX220, MX230, MX240, MX245, MX255, MX270, MX275, MX285, MX305, Magnum®: 215, 245, 255, 275, 305, 335	Transmission Separator Plate 0.44" Thick, 4.25" ID, 6.187" OD Replaces 92934C2	AM87622084	\$ 8.72	

Case IH®—Tractor

Application	Description	Part Number	Retail Price	Core
7110, 7120, 7130, 7140	IPTO Gasket Kit and Clutch Pack Heavy Duty Includes Gasket Kit, (11) 381490 Friction Discs, (10) 381489 Separator Plates and (3) HH1289335 Pistons	AMX59113	\$ 325.00	
7110, 7120, 7130, 7140, 7150, 7210, 7220, 7230, 7240, 7250, 8910, 8920, 8930, 8940, 8950	Park Lock Cover	AM94809C3	\$ 325.00	
(7110, 7120, 7130, 7140, 7150 Transmission ASN AJB0055132), 7210, 7220, 7230, 7240, 7250	Transmission Input Shaft w/o Creeper Replaces 1997440C1	AM1997440C2	\$ 1500.00	
MX215, MX245, MX275, MX305, Magnum®: 215, 235, 245, 250, 255, 260, 275, 280, 290, 305, 310, 315, 335, 340	Constant Mesh on Countershaft Driven, 23 Tooth	AM1285990C2	\$ 264.00	
Magnum®: 180, 190, 200, 210, 220, 225, 235, 240, 250, 260, 280, 290, 310, 315, 340	Input/Output Gear 30 Tooth	AM87740760	\$ 384.00	
Magnum®: 235, 250, 260, 280, 290, 310, 315, 340, 370, 380	Transmission Input Yoke 33 Spline	AM84170776	\$ 192.60	
JX1060X, JX1070C, JX1070N, JX1075C, JX1075N, JX1085C, JX1095C, JX1095N, MXM175, MXM190, MXU100, MXU110, MXU115, MXU125, MXU130, MXU135, Farmall®: 65C, 75C, 85C, 85U, 95C, 95U, 105U, Magnum®: 180, 190, 200, 210, 220, 225, 240, Maxxum®: 100, 110, 115, 120, 125, 130, 135, 140, 145, 150, Puma®: 115, 125, 130, 140, 145, 155, 160, 165, 170, 180, 185, 195, 200, 210, 215, 220, 225, 230, 240	Pressure Switch 2 Prong	AM87395493	\$ 41.60	
MX215	Transmission Controller Replaces 87534006, 87560224, 87567055	AM87617962	\$ 785.00	
Puma®: 170, 185, 200, 215	Friction Disc, Transmission Engagement Clutch	AM5163844	\$ 9.63	
5120, 5130, 5140, 5220, 5230, 5240, 5250	Solenoid, Transmission Shuttle Valve	AM1971474C3	\$ 162.68	
7110, 7120, 7130, 7140, 7150, 7210, 7220, 7230, 7240, 7250, 8910, 8920, 8930, 8940, 8950	Shift Cable 65 1/2" Long	AM96612C3	\$ 68.00	
Backhoe Loaders: 580M, 580 Super M, 580N, 580 Super N, 590 Super M, 590 Super N	Charge Pump	AM87429970	\$ 750.00	

Transmission Discs





Application	Description	Part Number	Retail Price	Core
7110, 7120, 7130, 7140, 7150, 7210, 7220, 7230, 7240, 7250, 8910, 8920, 8930, 8940, 8950	Transmission Disc 48 Tooth, 4.125" ID, 5.50" OD	AM92935C5	\$ 13.76	
7110, 7120, 7210, 7220, 7230, 7240, 7250, 8910, 8920, 8930, 8940, 8950, MX180, MX200, MX210, MX215, MX220, MX230, MX240, MX245, MX255, MX270, MX275, MX285, MX305, Magnum®: 215, 235, 245, 250, 255, 260, 275, 280, 290, 305, 310, 315, 335, 340, 370, 380	Transmission Disc	AM1342645C3	\$ 50.40	



Case IH®—Tractor

Application	Description	Part Number	Retail Price	Core
MXM120, MXM130, MXM140, MXM155, MXM175, MXM190, Magnum®: (180, 200, 220 - Excluding Tier 4B w/ CVT), 190, 210, Puma®: 115, 125, 130, 140, 145, 150, 155, 160, 165 Non Tier 4B 2007-11 or Tier 4B Prior to MY15, 170 12/2010-14, (180, 210 - w/o CVT), (185, 200 - Non Tier 4B w/o CVT 2010-14 or Tier 4B w/o CVT 04/2014-10/15), 195, 215, 220 Tier 4B w/o CVT	Transmission Clutch Pack Includes (6) Inner Spline Discs and (6) Outer Spline Discs Replaces 5167875, 5167876	AM87530788	\$ 70.53	
MXM120, MXM130, MXM140, MXM155, MXM175, MXM190, Magnum®: 180, 190, 200, 210, 220, Puma®: 115, 125, 130, 140, 145, 150, 155, 160, 165, 170, 180, 185, 195, 200, 210, 215, 220	Transmission Clutch Pack Note: Please verify model year and serial number for fit before ordering Includes (8) Inner Spline Discs and (8) Outer Spline Discs Replaces 5165058, 5165059	AM87530789	\$ 105.55	
MXM120, MXM130, MXM140, MXM155, Puma®: 115, 125, 130, 140, 150, 155, 160, 165	Transmission Clutch Pack Note: Please verify model year and serial number for fit before ordering Includes (8) Inner Spline Discs and (8) Outer Spline Discs	AM87530796	\$ 125.55	





PTO Assemblies and Components

Application	Description	Part Number	Retail Price	Core
 7110, 7120 - w/ Dual Speed PTO	PTO Housing Cover, Rear	AM1342698C1	\$ 295.00	
7110, 7120, 7130, 7140	Reman Single Speed Pumpkin Assembly 1000 RPM, 1 3/8" Output Shaft Diameter For Hydraulic PTO	AM9031	\$ 2500.00	\$ 1000.00
7130, 7140, 7150, 7230, 7240, 7250, 8930, 8940, 8950	Reman Single Speed Pumpkin Assembly 1000 RPM, 1.75" Shaft	AM9030	\$ 2500.00	\$ 1000.00
 7110, 7120, 7130, 7140, 7150	Reman Dual Speed Pumpkin Assembly 540/1000 RPM, 1 3/8" Output Shaft Diameter For Hydraulic PTO	AM9023	\$ 3000.00	\$ 2000.00
7210, 7220, 7230, 7240, 7250, 8910, 8920, 8930, 8940, 8950	Reman Dual Speed Pumpkin Assembly 540/1000 RPM Replaces 313783A3	AM9025	\$ 5000.00	\$ 2000.00
 7110, 7120, 7130, 7140	Dual Speed Conversion Kit Will not work on the rectangular style PTO assembly	AMX59103	\$ 1500.00	
 7110, 7120, 7130, 7140, 7150	PTO Clutch Kit Includes (11) Friction Discs and (10) Separator Plates	AM1277392C1	\$ 95.00	
 7110, 7120, 7130, 7140, 7150, 7210, 7220, 7230, 7240, 7250, 8910, 8920, 8930, 8940, 8950	PTO Clutch Disc 51 Spline, 3.73" ID, 5.30" OD Replaces 381490R4, 1277392C1, 1997688C1	AM381490R1	\$ 4.00	

Case IH®—Tractor

	Application	Description	Part Number	Retail Price	Core
	7110, 7120, 7130, 7140, 7150, 7210, 7220, 7230, 7240, 7250, 8910, 8920, 8930, 8940, 8950	PTO Separator Plate 4.07" ID, 5.30" OD Replaces 1277392C1, 1997688C1	AM381489R3	\$ 4.00	
	JX70U, JX80U, JX90U, JX100U, JX1070U, JX1080U, JX1090U, JX1100U, JXU75, JXU85, JXU95, JXU105, JXU115, Farmall®: 95U, 105U	PTO Clutch Disc 44 Spline, 3.85" ID, 5.23" OD, 0.059" Thick	AM5165950	\$ 7.25	
	7110, 7120	PTO Idler Shaft	AM381507R1	\$ 40.00	
	7110, 7120	PTO Gear, Driven	AM381506R1	\$ 375.00	
	7210, 7220, 7230, 7240, 7250, 8910, 8920, 8930, 8940, 8950	PTO Gear, Driven	AM1997823C1	\$ 275.00	
	7110, 7120	PTO Gear, Idler 27 Tooth	AM381509R1	\$ 195.00	
	7210, 7220, 7230, 7240, 7250, 8910, 8920, 8930, 8940, 8950	PTO Gear, Idler	AM1997822C1	\$ 275.00	
	7110, 7120, 7130, 7140	PTO Clutch Piston	AM68080C2	\$ 100.00	
	7110, 7120, 7130, 7140, 7288, 7488	Clutch Cup	AM1268999C1	\$ 275.00	
	7110, 7120, 7130, 7140	Clutch Backing Disc	AM92490C1	\$ 115.00	
	7110, 7120, 7130, 7140	Drive Shaft Magnum® PTO	AM92510C1	\$ 225.00	
	7110, 7120, 7130, 7140	Clutch Carrier Magnum® PTO	AM92492C2	\$ 395.00	
	MXM120, MXM130, MXM140, MXM155, MXM175, MXM190	PTO Damper Replaces 47126791, 47127097	AM87302871	\$ 235.00	
	MXM120, MXM130, MXM140, MXM155, MXM175, MXM190, MXU100, MXU110, MXU115, MXU125, MXU130, MXU135	PTO Brake Band Replaces 81819772, 83924796, 83956644, 89845550, C7NNB726D, EONNB726AA	AME0NNB726AB	\$ 34.37	
	7110, 7120, 7220, 7230, 7240, 8910, 8920, 8930, 8940, 8950	PTO Output Shaft Bearing Replaces 92588C1, 381483R91, 381483R92	AM92588C2	\$ 90.00	
	7110, 7120	PTO Back Plate Spacer	AM1349266C1	\$ 60.00	

Case IH®—Tractor

Application	Description	Part Number	Retail Price	Core
 7110, 7120	Spacer For Independent PTO Output Shaft, 540 RPM	AM381505R1	\$ 26.00	
 7110, 7120	PTO Shaft Seal Backup Washer For Independent PTO Shaft, 540 RPM on Dual Speed PTO	AM393211R1	\$ 15.00	
 7110, 7120 - w/ Dual Speed or Single Speed 1000, 1 3/8" PTO	PTO Idler Gear Thrust Washer	AM381508R1	\$ 30.00	
MXM175, MXM190, MXU100, MXU115, MXU125, MXU130, MXU135, Maxxum®: 100, 110, 115, 120, 125, 130, 135, 140, 145, 150, Optum®: (270, 300 - Tier 4B CVX Non MY18), Puma®: 115, 125, 130, 140, 145, 150 Tier 4B CVT or CVX, 155, 160, 165, 170, 180, 185, 195, 200, 210, 215, (220, 225, 230, 240 - CVT or CVX)	Friction Disc, PTO Clutch	AM5163844	\$ 9.63	
 7110, 7120, (7130, 7140 Transmission ASN AJB00059709), 7150, (7210, 7220 - w/ Dual Speed PTO), 7230, 7240, 7250	PTO Clutch Cup Seal Ring	AM381485R1	\$ 6.00	
 (7230, 7240, 7250, 8930, 8940, 8950 - w/ Single 1000 RPM PTO)	PTO Oil Seal Replaces A140930	AM1349466C1	\$ 55.00	

Rear Axle Components



Application	Description	Part Number	Retail Price	Core
7130, 7140, 7150, 7230, 7240, 7250, 8930, 8940, 8950, MX200, MX210, MX220, MX230, MX240, MX255, MX270	Sunshaft Right Hand Left Hand	AM94652C3 AM94651C2	\$ 664.76 \$ 689.24	
7110 (w/ 96" & 112" Axle), 7120 (w/ 96", 112" & 118" Axle)	Planetary Gear, 27 Tooth	AM1251840C1	\$ 143.52	

Brakes and Components



Application	Description	Part Number	Retail Price	Core
Maxxum®: 110, 120, 130	Master Cylinder Replaces 47132767	AM84535046	\$ 232.18	
Magnum®: 180, 190, 200, 210, 220, 225, 240, Puma®: 165, 170, 180, 185, 195, 200, 210, 215, 220, 225, 240	Brake Shoe, Parking Replaces 5196714	AM84152436	\$ 37.00	
Magnum®: 235, 250, 260, 280, 290, 310, 315, 340, 370, 380	Brake Disc	AM84141962	\$ 82.00	
385, 395, 485, 495, (585, 595, 685, 695, 885, 895, 995 - w/o Cab), 3220, 3230, 4210, 4230, 4240, C50, C60, C70, C80, C90, C100	Master Cylinder 0.553" Eyelet ID Replaces 1287843C91	AM1287843C92	\$ 129.00	
5120, 5130, 5140, 5150, 5220, 5230, 5240, 5250	Brake Plate, Backing Replaces 1995365C2, A188686, A188736	AM1995365C1	\$ 165.00	
5120, 5130, 5140, 5150, 5220, 5230, 5240, 5250, MX80C, MX90C, MX100, MX100C, MX110, MX120, MX135	Brake Piston	AM123938A1	\$ 168.64	

Case IH®—Tractor

Application	Description	Part Number	Retail Price	Core
5120, 5130, 5140, 5150, 5220, 5230, 5240, 5250, MX80C, MX90C, MX100, MX100C, MX110, MX120, MX135, MX150, MX170	Parking Brake Plate Replaces 233661A1, 1341163C1, A188109	AM1341163C3	\$ 48.56	
5120, 5130, 5140, 5220, 5230, 5240, MX100, MX110, MX120, MX135	Brake Disc (1) Required per Side	AMA190067	\$ 35.00	
5150, MX80C, MX90C, MX100, MX100C, MX110, MX120, MX135, MX150, MX170	Brake Discs Set of 2 Replaces 233661A1	AM1345726C1	\$ 143.52	
7110, 7120, 7130, 7140, 7150	Brake Piston	AM120490C1	\$ 128.95	
7110, 7120, 7130, 7140, 7150, 7210, 7220, 7230, 7240, 7250	Brake Plate Kit	AM1264581C91	\$ 775.00	
7110, 7120, 7130, 7140, 7150, 7210, 7220, 7230, 7240, 7250, 8910, 8920	Brake Return Adjuster Plate (1) Required per Side	AM139189C1	\$ 44.00	
7110, 7120, 7130, 7140, 7150, 7210, 7220, 7230, 7240, 7250, 8910, 8920, 8930, 8940, 8950	Brake Piston Hydraulic Activated (3) Required	AM1289335C5	\$ 45.00	
	Brake Piston w/ Kevlar Pads (3) Required	AM1289335C5K	\$ 80.00	
	Park Cable	AM1267745C3	\$ 68.00	
7110, 7120, 7130, 7140, 7150, 7210, 7220, 7230, 7240, 7250, 8910, 8920, 8930, 8940, 8950, MX150, MX170, MX180, MX200, MX210, MX220, MX230, MX240, MX255, MX270, MX285	Brake Plate, Separator	AM120486C1	\$ 35.00	
	Brake Disc	AM120488C2	\$ 60.00	
	(3) Required per side up to and including MX180 (4) Required per side on MX200 and later			
CX50, CX60, CX70, CX80, CX90, CX100, MX80C, MX90C, MX100, MX100C, MX110, MX120, MX135	Master Cylinder	AM226301A1	\$ 275.00	
JX70U, JX80U, JX90U, JX100U, MXM120, MXM130, MXM140, MXM155	Master Cylinder Replaces 82006194, 82018664	AM84558759	\$ 136.44	
MX100, MX110, MX120, MX135	Master Cylinder 2.50" Center-to-Center Mounting Holes	AM252458A1	\$ 155.00	
MX180, MX200, MX210, MX220, MX230, MX240, MX255, MX270, MX285	Brake Disc, Parking 3.50 mm Thick, 6.87" ID Replaces 87776014	AM195067A2	\$ 60.00	
MXM175, MXM190, Magnum®: 180, 190, 200, 210, 220, 225, 240, Puma®: 170, 180, 185, 195, 200, 210, 215, 220, 225, 230, 240	Brake Pad, Parking Center Shoes, 4.20 mm Thick	AM5196706	\$ 35.00	
MXM190, Magnum®: 180, 190, 200, 210, 220, 225, 240, Puma®: 165, 170, 180, 185, 195, 200, 210, 215, 220, 225, 230, 240	Brake Plate, Separator and Parking Replaces 5196708	AM47663732	\$ 30.00	
MXU100, MXU110, MXU115, MXU125, MXU130, MXU135, Farnall®: 105U, 110U, 115U, 120U, Maxxum®: 100, 110, 115, 120, 125, 130, 135, 140, 145, 150	Brake Plate Splined, 4.134" ID, 7.441" OD, 0.177" Wide	AM47127225	\$ 18.93	
MXU110, MXU115, MXU125, MXU130, MXU135, Maxxum®: 100, 110, 115, 120, 125, 130, 135, 140, 145, 150	Brake Piston	AM5191494	\$ 171.27	
MXU110, MXU115, MXU125, MXU130, MXU135, Maxxum®: 100, 110, 115, 120, 125, 130, 140	Brake Disc	AM5191497	\$ 124.00	
MXU100, MXU115, MXU125, MXU135, Maxxum®: 100, 110, 115, 120, 125, 130, 140	Brake Disc	AM47131048	\$ 425.00	
MXM120, MXM130, MXM140, MXM155	Pressure Ring	AM5152350	\$ 140.50	
(MXM120, MXM130, MXM140, MXM155 BSN C4806)	Friction Disc, Handbrake 34 Spline 4.126" ID, 7.067" OD, 0.236" Thick	AM5146036	\$ 51.12	

Case IH®—Tractor





Drawbars

All of our drawbars are cut, drilled and heat-treated to exact design and specifications that meet or exceed OEM specifications.





Application	Description	Part Number	Retail Price	Core
Farmall®: 45A, 55A, 65A, 75A	Drawbar	AM47375437	\$ 164.70	
Magnum®: (180 w/ Non Tier 4B Engine, 190, 210, 225 - w/ Standard Drawbar), Optum™: 270, 300, Puma®: 165 2007-12, 170, 180, 185, 195, 200, 210, 215, 220, 225, 230, 240	Drawbar Replaces 87303691, 87561341	AM87561441	\$ 520.00	
(5120, 5130, 5140, 5220, 5230, 5240, 5250 - Late), MX80C, MX90C, MX100, MX110, MX120, MX135	Drawbar, Offset 2.50" x 1.50" x 50.75"	AM104642A2	\$ 587.24	
7110, 7120, 7210, 7220, 8910, 8920	Drawbar, Offset 3" x 1.50" x 58.69", (4) Holes: 1.445", 5.445", 9.445" & 12.93" from Front	AM1286970C3	\$ 217.00	
7130, 7140, 7150, 7230, 7240, 7250, 8930, 8940, 8950	Drawbar 3" x 60.62" x 1.75", (4) Holes at 1.50", 5.50", 9.50" & 21.50" from Front	AM1286969C3	\$ 275.00	
8910, 8920, 8930, 8940, 8950, MX180, MX200, MX220, MX240, MX270	Drawbar, HD 3" x 2" x 57.13" w/ 1.38" Offset Replaces 294015A1, 294015A2	AM294015A3	\$ 525.00	
MX210, MX230, MX255, MX285	Drawbar 5" x 2" x 57.125", (6) Holes: 1.625", 3.8125", 7.375", 9.50", 11.625" & 13.75" from Front	AM426511A1	\$ 1014.85	
MX210, MX215, MX230, MX245, MX255, MX275, MX285, MX305, Magnum®: 215, 235, 245, 250, 260, 275, 280, 290, 305, 310, 315, 335, 340, 370, 380	Drawbar Replaces 310529A1, 719663006, 719663016	AM87680426	\$ 860.00	
MX215, MX245, MX275, MX305, Magnum®: 215, 235, 245, 250, 260, 275, 280, 290, 305, 310, 315, 335, 340, 370, 380	Drawbar Replaces 277702A1, 87773807	AM277702A2	\$ 695.00	
MX215, MX245, MX275, MX305, Magnum®: 215, 245, 275, 305, 335	Drawbar Replaces 232515A1, 87773618	AM232515A2	\$ 815.00	
MX215, MX245, MX275, MX305, Magnum®: 215, 235, 245, 250, 260, 275, 290, 305, 310, 315, 335, 340, 370, 380	Drawbar Cat IV	AM87688072	\$ 1556.88	
MXM120, MXM130, MXM140, MXM155, MXM175, MXM190	Drawbar	AM82028265	\$ 316.00	
MXM175, MXM190	Drawbar	AM82028979	\$ 615.00	

Hammer Straps

Application	Description	Part Number	Retail Price	Core
 7110, 7120, 7130, 7140, 7150, 7210, 7220, 7230, 7240, 7250, 8910, 8920, 8930, 8940, 8950	Hammer Strap Kit For Straight Drawbar Includes Hammer Strap, Short Spacer and Long Spacer Replaces 1286984C1, 1331939C1	AM1286924C1-K	\$ 295.00	
 7110, 7120, 7130, 7140, 7150, 7210, 7220, 7230, 7240, 7250, 8910, 8920, 8930, 8940, 8950	Hammer Strap Assembly, Welded For straight drawbar	AM1286984C1-K	\$ 285.00	
 7110, 7120, 7130, 7140, 7150, 7210, 7220, 7230, 7240, 7250	Hammer Strap For Straight Drawbar	AM1348030C1	\$ 279.53	
 7110, 7120, 7130, 7140, 7150, 7210, 7220, 7230, 7240, 7250, 8920, 8930, 8940 8950	Hammer Strap	AM1286984C1	\$ 120.00	
 MX150, MX170, MX180, MX200, MX210, MX220, MX230, MX240, MX255, MX270, MX285 Replaces 232615A2	Hammer Strap	AM232615A3	\$ 135.00	

Case IH®—Tractor

Application	Description	Part Number	Retail Price	Core
 MX215, MX245, MX275, MX305, Magnum®: 215, 235, 245, 250, 260, 275, 280, 290, 305, 310, 315, 335, 340, 370, 380, Steiger®: 350, 370, 400, 420, 450, 470, 500, 540, 550, 580, 600, 620, Quadtrac®: 370, 420, 450, 470, 500, 540, 550, 580, 600, 620	Hammer Strap Replaces 375719A1	AM87615031	\$ 369.00	
 7130, 7140, 7150, 7230, 7240, 7250, 8930, 8940, 8950, (MX180, MX200, MX220, MX240, MX270 - High Capacity)	Hammer Strap Spacer Replaces 1286983C2	AM1286983C1	\$ 69.66	

Remote Valves

Application	Description	Part Number	Retail Price	Core
MXU100, MXU110, MXU115, MXU125, MXU135, Maxxum®: 100, 110, 115, 120, 125, 130, 140, Puma®: 125, 140, 155	Remote Valve	AM84125295	\$ 2600.00	
7110, 7120, 7130, 7140, 7150, 7210, 7220, 7230, 7240, 7250, 8910, 8920, 8930, 8940, 8950, Magnum®: 215, 245, 255, 275, 305, 335, MX180, MX200, MX210, MX215, MX220, MX230, MX240, MX245, MX255, MX270, MX275, MX285, MX305, STX275, STX280, STX325, STX330, STX375, STX380, STX425, STX430, STX440, STX450, STX480, STX500, STX530, Steiger: 280, 330, 335, 380, 385, 430, 435, 480, 485, 530, 535	Internal Female Coupler Kit Recommended to purchase in quantities of two (pressure and return) Genuine OEM Coupler includes HA345193 O-Ring and Seal Kit Replaces 93328C1, 275182A1, 87776294	AM84262367	\$ 160.00	
(7110, 7120, 7130, 7140, 7150 Transmission SN AJB0018756-AJB0060499)	Hydraulic Coupler Push-Pull Style, 0.50" Body Size, 1"-14 ORFS Thread Size Recommended to purchase in quantities of two (pressure and return) Replaces 1342102C1	AM1342102C3	\$ 110.00	
7110, 7120, 7130, 7140, 7150, 7210, 7220, 7230, 7240, 7250, 8910, 8920, 8930, 8940, 8950	Hydraulic Coupler Mounting Plate	AM120012C1	\$ 35.00	
MX80C, MX90C, MX100, MX100C, MX110, MX120, MX135, (MX180, MX220, MX240, MX270 BSN JJA0105000)	Hydraulic Coupler Recommended to purchase in quantities of two (pressure and return) Replaces 195315A1, 84207573	AM195315A2	\$ 69.00	
MX150, MX170, MX180, MX200, MX210, MX220, MX230, MX240, MX255, MX270, MX285	Hydraulic Quick Coupler Recommended to purchase in quantities of two (pressure and return) Replaces 257481A2	AM257481A1	\$ 135.00	
MXM120, MXM130, MXM140, MXM155, MXM175, MXM190, MXU100, MXU110, MXU115, MXU125, MXU135, Magnum®: 180, 190, 210, 220, 225, 240	Hydraulic Remote Valve Coupling M22x1.50" Male Thread Quick Release	AM47370116	\$ 74.80	
Quadtrac®: 9310, 9330, 9350, 9370, 9380	Hydraulic Valve Mounting Stud 3/8" x 9-7/8" Use w/ Third Remote Valve	AMA147507	\$ 36.00	

Hydraulic Oil Coolers

Application	Description	Part Number	Retail Price	Core
Magnum®: 180, 190, 210	Hydraulic Oil Cooler	AM84217213	\$ 895.00	
Magnum®: 235, 250, 260, 280, 290, 310, 315, 340	Hydraulic Oil Cooler	AM84254901	\$ 729.00	
(7110, 7120, 7130, 7140, 7150 BSN JJA0027702)	Hydraulic Oil Cooler Core: 23 5/8" x 14" x 3 1/4"	AMA184765	\$ 850.00	

Case IH®—Tractor

Application	Description	Part Number	Retail Price	Core
(7110, 7120, 7130, 7140, 7150 ASN JJA0027700), 7210, 7220, (7230, 7240, 7250 BSN JJA0064978)	Hydraulic Oil Cooler Replaces 1348392C1, A189495	AM1348392C2	\$ 1340.00	
(7210, 7220, 7230, 7240, 7250 ASN JJA0064977), 8910, 8920, 8930, 8940, 8950	Hydraulic Oil Cooler Core: 24.25" x 24" x 1.75"	AM181582A2	\$ 1065.00	
9150, 9170, 9180, 9240, 9250, 9260, 9270, 9280, 9370, 9380, Steiger®: Bearcat 1000, Cougar 1000 12/1985 and Later, Lion 1000, Panther 1000 10/1986 and Later	Hydraulic Oil Cooler Core: 31.50" x 17.325" x 2.75"	AM90-6708T1	\$ 725.00	
DX35 ASN HBA015014, DX40, DX45, Farmall®: 40, 40B, 45, 45B, 45C, 50, 50B, 55C	Hydraulic Oil Cooler Core: 15" x 16" x 1 1/8"	AM87344149	\$ 285.00	
MX180, MX200, MX220, MX240, MX270	Hydraulic Oil Cooler, Right Hand Overall: 6" x 30" x 7 1/2" Core: 4" x 25 5/8" x 5" Replaces 248874A3, 248874A4	AM248874A5	\$ 900.00	
	Hydraulic Oil Cooler, Left Hand Overall: 6" x 30" x 7 1/2" Core: 4" x 25 5/8" x 5" Replaces 248873A3, 248873A4	AM248873A5	\$ 1100.00	
(STX275, STX325, STX375, STX425, STX450, STX500 ASN JEE0099501), (STX280, STX330, STX380, STX430 SN Z6F100023-Z6F105001), Steiger®: (330, 335, 380, 385, 430, 435 - 4WD)	Hydraulic Oil Cooler Core: 36" x 29" x 2 1/2" Replaces 345228A1, 361082A1	AM87312759	\$ 1007.00	
Steiger®: 500, 550, 600, Quadtrac®: 450, 470, 500, 550, 600	Hydraulic Oil Cooler Core: 24.60" x 19.50" x 4"	AM84252569	\$ 1286.00	
	Transmission Oil Cooler Core: 19.50" x 24.60" x 4"	AM84210954	\$ 1250.00	
MX100, MX110, MX135, MX150, MX170	Condenser w/ Oil Cooler	AM139870A1	\$ 490.00	

Hydraulic Pumps and Components

Application	Description	Part Number	Retail Price	Core
Farmall®: 105U w/ Tier 4A Efficient Power Engine, 110U, 115U 03/10/2013 and Later, 120U	Hydraulic Pump	AM47456761	\$ 1050.00	
Magnum®: 235, 250, 260, 280, 290, 310, (310, 340, 380 - Rowtrac™), 315, 340, 370, 380	Hydraulic Pump 63 cc, 41.30 GPM, Standard Capacity Replaces 87538166	AM87538174	\$ 1822.10	
Magnum®: 235, 250, 260, 280, 290, 310, (310, 380 - Rowtrac™), 340, 370, 380	Hydraulic Pump 85 cc, 55.60 GPM, High Capacity	AM47473854	\$ 1683.40	
Maxxum®: 100 Tier 3 Limited, (110, 115, 125, 135 - Excluding Tier 3 Value and CVT), (120, 145 - Non CVT), 130, 140, 150, Puma®: 115, 125, (130, 160 - Non CVT), 140, 145, (150, 165 - Tier 4B and MY18 CVT), 155	Hydraulic Pump 45 cc, 29.80 GPM Replaces 8416091	AM84471387	\$ 2151.75	
Puma®: 165, 170, 180, 185, 195, 200, 210, 215, 220	Hydraulic Pump	AM84471388	\$ 2040.00	
Quadtrac®: 370, 420, (420, 470, 500 - Rowtrac™ Optional Equipment), 450, 470, 500, 535, 540, 550, 580, 600, 620, Steiger®: (350, 400, 450 - Rowtrac™), (350, 400, 450, 470 HD, 500 HD, 540, 540 HD, 580 HD, 620 HD - Optional Equipment), (370, 420, 470, 500, 580 - Optional Equipment on MY17), 420 HD, 535, 550, 600, 620	Hydraulic Pump 85 cc Mega Flow Pump Replaces 84178463	AM47764642	\$ 1731.85	
Quadtrac®: 450, 500, 550, 600, Steiger®: 500, 550, 600	Hydraulic Pump Replaces 84194336	AM47528844	\$ 1744.02	
5120, 5130, 5140, 5220, 5230, 5240, 5250	Hydraulic Pump Replaces 1343659C1	AM1343659C2	\$ 3074.00	

Case IH®—Tractor

Application	Description	Part Number	Retail Price	Core
7110, 7120, 7130, 7140, 7150	Hydraulic Gear Pump w/o Seal Replaces 1954132C2 (w/ Seal)	AM1341835C1	\$ 2695.00	\$ 500.00
7110, 7120, 7130, 7140, 7150, 7210, 7220, 7230, 7240, 7250, 8910, 8920, 8930, 8940, 8950	Hydraulic Piston Pump	AM1346423C1	\$ 1700.00	
7110, 7120, 7130, 7140, 7150, 7210, 7220, 7230, 7240, 7250, 8910, 8930, 8940, 8950, STX275, STX280, STX325, STX330, STX375, STX380, STX425, STX430, STX440, STX450, STX480, STX500, STX530	Reman Hydraulic Pump	AM432244A3	\$ 850.00	\$ 500.00
D25, D29, D33, DX21, DX23, DX24, DX25, DX26, DX29, DX33	Hydraulic Pump	AMSBA340451060	\$ 500.00	
D25, D29, D33, DX25, DX29, DX33	Hydraulic Pump Replaces SBA340450490	AMSBA340450491	\$ 675.00	
D35, D40, D45, DX35, DX40, DX45, Farmall®: 40, 45, 50	Hydraulic Pump	AMSBA340450991	\$ 675.00	
JX55, JX60, JX65, JX70 12/2005 and Later, JX80, JX85, JX90, JX95 Excluding Straddle Mount	Hydraulic Pump - Engine Mount 19.33 cc, 10.80 GPM Replaces 2040333, 5093658, 5094394, 5169770, 5179414, 5179711, 5179714, 9967782, 47562399, 82987745, 87716629, 87737605	AM84530154	\$ 125.00	
JX70U	Hydraulic Pump Replaces 5129486, 5169039	AM5179728	\$ 110.00	
(JX80, JX90 - Standard), JX95 Straddle Mount, JX95HC Plus	Hydraulic Pump 14.35 cc, 10.80 GPM Replaces 1909915, 1909919, 1930068, 5086286, 5094391, 5113284, 5120849, 5129483, 5169772, 5179719, 8280127, 9967928, 84467651, 85086286, 87325370, 87721169, 87737603, 153634445, 320446000	AM84530156	\$ 195.00	
JX1060C, JX1070C, JX1075C, JX1085C, JX1095C	Hydraulic Pump	AM5168841	\$ 445.20	
(MX80C, MX90C, MX100C ASN JJE1101024), (MX100, MX120, MX135 - w/ Transmission ASN JKA0138085), MX110	Hydraulic Pump 41 cc	AM394268A2	\$ 1900.00	
MX150, MX170	Hydraulic Pump	AM394269A2	\$ 1725.00	
MX180, MX200, MX220, MX240, MX270	Hydraulic Pump Replaces 278069A1	AM278069A2	\$ 2625.00	
MX210, MX230, MX255, MX285	Hydraulic Pump High Capacity	AM87429252	\$ 2318.00	
MX210, MX230, MX255, MX285	Hydraulic Pump 56 cc, Standard Flow	AM87429249	\$ 1785.00	
MX215, MX245, MX275, MX305, Magnum®: 215, 245, 275, 305, 335	Hydraulic Pump High Capacity	AM87442128	\$ 2221.10	
MX215, MX245, MX275, MX305, Magnum®: 235, 250, 260, 280, 290, 310, 310 Rowtrac™, 315, 335, 340, 370, 380	Hydraulic Pump 45 cc Twin Flow	AM87538170	\$ 1033.60	
MXM120, MXM130, MXM140, MXM155, MXM175, MXM190	Hydraulic Pump	AM47129423	\$ 703.20	
MXM120, MXM130, MXM140, MXM155, MXM175, MXM190, Puma®: 165, 180, 195, 210	Hydraulic Pump	AM47133946	\$ 3468.00	
MXM140, MXM155, MXM175, MXM190, MXU100, MXU110, MXU115, MXU125, MXU135, Maxxum®: 100 Tier 3 Limited, (110, 115, 125, 140 - Tier 3 Limited and Pro), (120, 130 - Tier 3 Pro), Puma®: 165, 180, 195, 210	Hydraulic Pump Used in 45 cc pumps, 113 Liters per Minute Replaces 47127050, 87725827	AM5198694	\$ 2575.00	
MXU100, MXU110, MXU115, MXU125, MXU135, Maxxum®: 110, 115, 120, 125, 130, 135, 140, 145, 150	Hydraulic Pump 80 Liters per Minute	AM5192659	\$ 505.00	

Prices Subject to Change without Prior Notice. The use of original equipment manufacturer (OEM) part numbers or trademarks, e.g. Case® and John Deere®, are for reference purposes only and for indicating product use and compatibility. Our company and the listed replacement parts contained herein are not sponsored, approved or manufactured by the OEM. All parts are New unless designated Reman in the description.

Case IH®—Tractor

Application	Description	Part Number	Retail Price	Core
STX280, STX330, STX380, STX425, STX430, STX440, STX450, STX480, STX500, STX530, Quadtrac®: (370, 420, 470, 500 - Rowtrac™), 470, 500, 540, 550, 580, 600, 620, Steiger®: 280, 330, 335, 350, (350, 400, 450, 500 - Rowtrac™) 370, 380, 385, 400, 420, 430, 435, 450, 470, 480, 485, 500, 500 HD, 530, 535, 540, 540 HD, 550, 580, 580 HD, 600, 620, 620 HD	Hydraulic Pump 100 cc, High Capacity Replaces 47639533	AM87308196	\$ 3667.95	
STX280, STX330, STX380, STX430, STX480, STX530, Quadtrac®: (370, 420, 470, 500 - Rowtrac™), 450, 470, 500, 540, 550, 580, 600, 620, Steiger®: 280, 330, 335, 350, (350, 400, 450, 500 - Rowtrac™), 370, 380, 385, 420, 430, 435, 450, 470, 480, 485, 500, 530, 535, 540, 550, 580, 600, 620	Hydraulic Pump 71 cc Standard Capacity	AM87308197	\$ 2650.00	
Quadtrac®: 535, 540, 580, 620, Steiger®: 535, 540, 580, 620	Hydraulic Fan Drive Pump Replaces 84194336	AM47528844	\$ 1744.02	
STX425, STX450, STX500	Hydraulic Fan Drive Pump 100 cc	AM413152A1	\$ 1927.55	
(STX480, STX530 SN Z6F100023-Z6F105001), Steiger®: (480, 530 ASN Z6F105001), 485, 535	Hydraulic Fan Drive Pump 45 cc	AM87434402	\$ 1663.45	
7110, 7120, 7130, 7140, 7150	Reman Hydraulic Gear Pump w/o Seal Replaces 1954132C2 w/ Seal)	AM1341835C1R	\$ 1695.00	\$ 500.00
7110, 7120, 7130, 7140, 7150, 7210, 7220, 7230, 7240, 7250, 8910, 8920, 8930, 8940, 8950	Compensator Valve Replaces A49438, A49493	AMA49832	\$ 900.00	
7210, 7220, 7230, 7240, 7250, 8910, 8920, 8930, 8940, 8950	Accumulator Comes Uncharged Replaces 117941A2, 117941A3, 1542670C1	AM84484077	\$ 195.00	
JX60, JX70 12/2005 and Later, (JX80, JX90 Upgrade Models), JX95	Hydraulic Lift Pump 11.26 cc Replaces 1901322, 1930061, 5085685, 5088382, 5094395, 5094396, 5129481, 5143767, 5179722, 8273385, 8273973, 9967929, 84467650, 87325369, 87725756, 153633457	AM84530166	\$ 195.00	
JX70U, JX80U, JX90U, JX100U, JX1060C, JX1070C, JX1075C, MXM120, MXM130, MXM140	Hydraulic Lift Pump 19.33 cc Replaces 5129493, 5143768, 5169041, 5179726	AM84530167	\$ 220.00	
JX1060C, JX1070C, JX1075C	Hydraulic Steering Pump Replaces 569306, 1901323, 1930058, 5088381, 5120406, 5129478, 5179730, 44900783, 87326060, 98420895, 153630659, 153634396, 153634432	AM5179729	\$ 125.00	

PTO Shafts

Application	Description	Part Number	Retail Price	Core
5120, 5130, 5140, 5220, 5230, 5240, 5250	PTO Shaft 540/1000 RPM, 10.95" Long, 6 Tooth Front Spline	AM226824A2	\$ 120.00	
(7110, 7120 PTO Housing BSN 35685)	PTO Shaft 1000 RPM, 13.19" Long, 17 Tooth Front Spline	AM92501C1	\$ 483.15	
(7110, 7120 PTO Housing ASN 35685)	PTO Shaft 1000 RPM, 13.19" Long, 17 Tooth Front Spline	AM1349263C1	\$ 425.00	
7110, 7120, 7220, 7230, 7240, 7250, 8910, 8920, 8930, 8940, 8950	PTO Shaft 540 RPM, 10.435" Long, 13 Tooth Front Spline	AM148663C1	\$ 145.00	
(7130, 7140 Transmission BSN AJB0059710)	PTO Shaft 1000 RPM, 15.22" Long, 17 Tooth Front Spline	AM92500C1	\$ 871.35	
(7130, 7140 Transmission ASN AJB0059710), 7150, 7230, 7240, 7250, 8930, 8940, 8950	PTO Shaft 1000 RPM, 17.29" Long, 17 Tooth, 20 Spline	AM308611A1	\$ 1009.04	

Case IH®—Tractor

Application	Description	Part Number	Retail Price	Core
MX150, MX170	PTO Shaft 540/1000 RPM, 21 Spline, 1 3/8" Spline Diameter	AM179157A1	\$ 219.18	
MX180, MX200, MX210, (MX215, MX245, MX275, MX305 BSN Z7RZ05000), MX220, MX230, MX240, MX255, MX270, MX285, Magnum®: (215, 245, 255, 275, 305, 335 BSN Z7RZ05000)	PTO Shaft 540 RPM, 1 3/8" Diameter	AM226045A2	\$ 250.00	
MX180, MX200, MX210, MX215, MX220, MX230, MX240, MX245, MX255, MX270, MX275, MX285, MX305, Magnum®: 215, 245, 255, 275, 305, 335	PTO Shaft 1000 RPM, 21 Spline, 1 3/8" Spline Diameter	AM226042A2	\$ 250.00	
MXM175, MXM190, Maxxum®: 100, 110, 115, 120, 125, 130, 140, Puma®: 165, 170, 185, 195, 200, 210, 215, 220, 225, 230, 240	PTO Shaft, 1000 RPM 20 Spline, 1 3/4" Spline Diameter	AM47132584	\$ 184.00	
MXM120, MXM130, MXM140, MXM155, MXM175, MXM190, MXU100, MXU110, MXU115, MXU125, MXU130, MXU135, Maxxum®: 100, 110, 115, 120, 125, 130, 140, Puma®: 115, 125, 140, 155, 165, 180, 195, 210, 225	PTO Shaft 1000 RPM, 21 Spline, 1 3/8" Spline Diameter	AM47130744	\$ 131.00	
MXM120, MXM130, MXM140, MXM155, MXM175, MXM190, MXU100, MXU110, MXU115, MXU125, MXU130, MXU135, Magnum®: 180, 190, 210, 225, Maxxum®: 110, 115, 120, 125, 130, 140, Puma®: 115, 125, 130, 140, 145, 155, 160, 165, 170, 180, 185, 195, 200, 210, 215, 225, 230	PTO Shaft, 540 RPM 6 Tooth Front Spline Replaces 5182612, 5182613	AM47130743	\$ 180.00	

PTO Adapters

Application	Description	Part Number	Retail Price	Core
Tractors up to 70HP	PTO Adapter Small 540 to 1000 Spline, 4 1/8" Overall Length Changes PTO from 1 3/8" x 6 spline to 1 3/8" x 21 spline and extends the PTO shaft 4 1/8"	AMX59112	\$ 40.00	
Tractors up to 70HP	PTO Adapter Small 1000 to 540 Spline, 6 3/8" Overall Length Reduces PTO from 1 3/8" x 21 spline to 1 3/8" x 6 spline and extends the PTO shaft 4 1/8"	AMX59108	\$ 40.00	
Tractors up to 100HP	PTO Adapter Large 1000 to 540 Spline, 7 1/2" Overall Length Reduces PTO from 1 3/4" x 20 spline to 1 3/8" x 6 spline and extends the PTO shaft 4 5/8"	AMX59109	\$ 70.00	
Tractors up to 100HP	PTO Adapter Large 1000 to Small 1000 Spline, 7" Overall Length Reduces PTO from 1 3/4" x 20 spline to 1 3/8" x 21 spline and extends the PTO shaft 4 5/8"	AMX59110	\$ 70.00	

Rockshaft Components

Application	Description	Part Number	Retail Price	Core
MXM120, MXM130, MXM140, MXM155	Rockshaft Lift Arm Left Hand Replaces 5171960	AM87317739	\$ 235.00	
MXM140, MXM155	Rockshaft Lift Arm Right Hand	AM87317740	\$ 235.00	

Lift Link Assemblies and Components



Application	Description	Part Number	Retail Price	Core
Magnum®: 180, 190, 200, 210, 220, 225, 240, 250, 280, 310, Puma®: 165, 170, 180, 185, 195, 200, 210, 215, 230	Lift Link Assembly Replaces 5188140, 47133994	AM84253931	\$ 257.00	

Case IH®—Tractor

Application	Description	Part Number	Retail Price	Core
7110, 7120, 7130, 7140, 7150, 7210, 7220, 7230, 7240, 7250	Lift Link Assembly, Cat III Center Casting Measures 17" Replaces 1272944C2	AMX741019	\$ 250.00	
	Components:			
	Leveling Screw Housing	1 AM149836C4	\$ 135.00	
	Upper Adj. Lift Link	1 AMX741023	\$ 135.00	
	Lower Adj. Lift Link	1 AM149837C1	\$ 65.00	
	Turnbuckle Lock	1 AM123464C3	\$ 8.00	
7110, 7120, 7130, 7140, 7150	Lift Link, Upper Adjustment Screw 11.50" Long, 1.25"-7 Right Hand Screw Thread	AM149838C1	\$ 50.00	
7110*, 7120*, 7130*, 7140*, 7150*, 7210, 7220, 7230, 7240, 7250, 8910, 8920, 8930, 8940, 8950, 9210, 9230, 9240, 9250, 9260, 9310, 9330, 9350, MX80C, MX90C, MX100, MX100C, MX110, MX120, MX135, MX150, MX170	Draft Load Sensing Pin Elimination Kit Allows for normal function of the 3-point hitch, but disables the electronic draft control For models with electronic draft control, using triangular electrical connectors located under the rear of the cab	AMX33142	\$ 145.00	
*Will not fit early-style tractors using the round connectors	Draft Load Sensing Pin Elimination Kit Allows for normal function of the 3-point hitch and the electronic draft control using only one functioning draft load sensing pin For models with electronic draft control, using triangular electrical connectors located under the rear of the cab	AMX33143	\$ 160.00	
5120, 5130, 5140, 5220, 5230, 5240, 5250	Solenoid, Draft Control	AM1971474C3	\$ 162.68	

Lower Lift Links



Application	Description	Part Number	Retail Price	Core
7120, 7130, 7140, 7150, 7210, 7220, 7230, 7240, 7250	Lower Lift Link, Cat III Rigid	Right Hand AM134318A2	\$ 425.00	
7120, 7130, 7140, 7150, 7210, 7220, 7230, 7240, 7250	Lower Lift Link, Cat III Adjustable	Left Hand AMX741017 (Not Available)		
	Components:			
	Front Lift Link, Left Hand	1 AM130316A1	\$ 275.00	
	Latch	1 AM398399R1	\$ 25.41	
	Stiffner Latch Plate	2 AM382193R1	\$ 7.00	
	Spring Latch Plate	2 AM382192R1	\$ 5.00	
MX80C, MX90C, MX100, MX100C, MX110, MX120, MX135	Telescopic Stabilizer Assembly	AM112923A1	\$ 107.00	



Quick Hitches

Application	Description	Part Number	Retail Price	Core
Cat II	Quick Hitch, 4" x 6" Beam 36" Wide, Includes 1 1/8" Mounting Pins and Adapter Bushings	AMX741020	\$ 565.00	
Cat III	Quick Hitch, 4" x 6" Beam 38" Wide, Includes 1 7/16" Mounting Pins	AMX741022	\$ 565.00	
Cat III	Quick Hitch, 4" x 6" Beam 44" Wide, Includes 1 7/16" Mounting Pins	AMX741021	\$ 565.00	

Case IH®—Tractor



Toplink Assemblies and Components

Application	Description	Part Number	Retail Price	Core
7110, 7120, 7130, 7140, 7150, 7210, 7220, 7230, 7240, 7250, 8910, 8920, 8930, 8940, 8950, 9310, 9330, 9350	Toplink Assembly, Cat III Center Link Body has 1 3/4" Thread	AM1331855C3	\$ 225.00	
	Components:			
	Center Link End - Front	1 AM1981988C1	\$ 125.00	
	Center Link End - Rear	1 AM1282082C2	\$ 110.00	
	Center Link Body	1 AM1954223C1	\$ 85.00	
	Center Link Handle	1 AM1331863C2	\$ 35.00	
MXU100, MXU110, MXU115, MXU125, MXU130, MXU135, Maxxum®: 100, 110, 115, 120, 125, 130, 140, Puma®: 115, 125, 140, 155	Toplink Assembly	AM47125175	\$ 485.00	
7110, 7120, 7130, 7140, 7150, 7210, 7220, 7230, 7240, 7250, 8910, 8920, 8930, 8940, 8950	Upper Yoke	AM1266968C1	\$ 135.00	
	Swivel Block	AM1272669C3	\$ 80.00	
7110, 7120, 7130, 7140, 7150, 7210, 7220, 7230, 7240, 7250, 8910, 8920, 8930, 8940, 8950, 9110, 9130, 9150, 9210, 9230, 9240, 9250, 7260, 9310, 9330, 9350	Turnbuckle Lock	AM123464C3	\$ 8.00	
7110, 7120, 7130, 7140, 7150, 7210, 7220, 7230, 7240, 7250, 8910, 8920, 8930, 8940, 8950, 9310, 9330, 9350	Toplink Handle Retainer	AMIHHR	\$ 0.75	
MX100, MX110, MX120, MX135	Front Toplink End Replaces 224072A1	AM224072A2	\$ 665.00	



Hydraulic Lift Components

Application	Description	Part Number	Retail Price	Core
Puma®: 125, 140, 155, 165, 180, 195, 210, 225	Hydraulic Lift Cylinder	AM87392350	\$ 360.00	
7110, 7120, 7130, 7140, 7150, 7210, 7220, 7230, 7240, 7250, 8910, 8920, 8930, 8940, 8950	Rockshaft Cylinder Housing	AM1289125C2	\$ 695.00	
8930, 8940, 8950	Rockshaft Bell Crank	AM84923C3	\$ 695.00	
7210, 7220, 7230, 7240, 7250, 8910, 8920, 8930, 8940, 8950	Control Lever 4th Remote	AM1999722C2	\$ 85.00	
8910, 8920, 8930, 8940, 8950, CX50, CX60, CX70, CX80, CX90, CX100, MX80C, MX90C, MX100, MX100C, MX110, MX120, MX135, MX150, MX170, MX180, MX200, MX210, MX215, MX220, MX230, MX240, MX245, MX255, MX270, MX275, MX285, MX305, STX280, STX330, STX375 ASN JEE099501, STX380, STX425, STX430, STX450, STX480, STX500, STX530, Magnum®: 215, 245, 255, 275, 305, 335, Steiger®: 280, 330, 335, 380, 385, 430, 435, 480, 485, 530, 535	Solenoid, Hitch Valve Replaces 87775314	AM188105A1	\$ 70.00	

Case IH®—Tractor

Front Weights and Weight Brackets

Application	Description	Part Number	Retail Price	Core
MX210, MX230, MX255, MX285, MXM120, MXM140, MXM155, MXM175, MXM190, MXU100, MXU110, MXU115, MXU125, MXU135, (STX275, STX375, STX425, STX450, STX500 ASN JEE0099501)	Weight	AM405846A3	\$ 125.00	
MX210, MX230, MX255, MX285	Weight Bracket Holds 10 Weights	AM405844A2	\$ 450.00	
7110, 7120, 7130, 7140, 7150, 7210, 7220, 7230, 7240, 7250	Front Weight Mounting Frame Holds 18 Weights	AM1342125C2	\$ 450.00	

Battery Box and Components

Application	Description	Part Number	Retail Price	Core
7110, 7120, 7130, 7140, 7150, 7210, 7220, 7230, 7240, 7250, 8910, 8920, 8930, 8940, 8950	Battery Box Replaces 96650C3	AM1955202C1	\$ 485.00	
	Battery Cover, Top	AM96656C1	\$ 70.00	
	Battery Cover, Front	AM96657C2	\$ 225.00	
(7110, 7120, 7130, 7140, 7150 BSN JJA039446)	Hydraulic Filter Access Panel	AM96766C2	\$ 344.00	
(7110, 7120, 7130, 7140, 7150 ASN JJA0039446), 7210, 7220, 7230, 7240, 7250, 8910, 8920, 8930, 8940, 8950	Filter Cover	AM1348227C1	\$ 155.00	

Hoods and Grilles

Application	Description	Part Number	Retail Price	Core
7110, 7120, 7130, 7140, 7210, 7220, 7230, 7240, 7250, 8910, 8920, 8930, 8940, 8950	Hood Panel, Front Lower Primer Coated, Ready for Paint	Left Hand AM195934A1	\$ 528.00	
	Hood Panel, Rear Lower Primer Coated, Ready for Paint	Left Hand AM1289399C3	\$ 528.00	
	Hood Panel, Lower Primer Coated, Ready for Paint	Right Hand AM128014A1	\$ 696.00	
7110*, 7120*, 7130*, 7140*, 7150*, 7210, 7220, 7230, 7240, 7250 *Requires 112994A1 and 112995A1 Angle Brackets	Lower Grille Shell Primer Coated, Ready for Paint	AM179095A1	\$ 696.00	
MX100, MX110, MX120, MX135, MX150, MX170 - w/o Front PTO and Hitch	Grille Assembly	AM228517A5	\$ 395.00	
MX180, MX200, MX220, MX240, MX270	Grille Replaces 389681A2, 87448498	AM84176843	\$ 1235.00	
(5120, 5130, 5140, 5220, 5230, 5240, 5250 BSN JF1019253)	Front Grille Latch	AM1531768C1	\$ 19.00	
MX180, MX200, MX210, MX220, MX230, MX240, MX255, MX270, MX285, MXU110, MXU115, MXU130	Latch	AMR55002	\$ 53.00	
5120, 5130, 5140, 5220, 5230, 5240, 5250	Hood Seal	Right Hand AM1531457C1 Left Hand AM1531458C1	\$ 19.06 \$ 19.06	
7110	Decal Set, Hood Replaces 1334444C1, 1334445C1, 1342044C1, 1342045C1	AMX19127	\$ 98.00	
7130	Decal Set, Hood Replaces 1334444C1, 1334445C1, 1342048C1, 1342049C1	AMX19128	\$ 107.00	
7140	Decal Set, Hood Replaces 1334444C1, 1334445C1, 1342050C1, 1342051C1	AMX19129	\$ 107.00	
7230	Decal Set, Hood	AMX19130	\$ 107.00	

Case IH®—Tractor

Application	Description	Part Number	Retail Price	Core
8930	Decal Set, Hood	AMX19131	\$ 107.00	



Steps

Application	Description	Part Number	Retail Price	Core
7110, 7120, 7130, 7140, 7150, 8910, 8920, 8930, 8940, 8950	Steel Step Replaces middle and lower steps on tractor applications	AM97050C3	\$ 60.00	
MX180, MX200, MX210, MX220, MX230, MX240, MX255, MX270, MX285, STX275, STX325, STX375, (STX425, STX450, STX500 ASN JEE50099501), STX440	Step	AM257375A1	\$ 40.00	



Cab Doors

Door frame only. No glass, seal or hardware included.

Application	Description	Part Number	Retail Price	Core
7110, 7120, 7130, 7140, 7150, 7210, 7220, 7230, 7240, 7250, 8910, 8920, 8930, 8940, 8950	Cab Door Frame Primer Coated, Ready for Paint	AM1343890C2	\$ 675.00	



Cab Roofs

Application	Description	Part Number	Retail Price	Core
Magnum®: 7110, 7120, 7130, 7140, 7150, 7210, 7220, 7230, 7240, 7250, 8910, 8920, 8930, 8940, 8950	Cab Roof ABS plastic w/ gel-coated cover, pre-drilled, ready to install	AM96755C6	\$ 1825.00	

Fenders, Platforms and Components





Application	Description	Part Number	Retail Price	Core
7110, 7120, 7130, 7140, 7150, 7210, 7220, 7230, 7240, 7250, 8910, 8920, 8930, 8940, 8950	Fender, Right Hand	AM97004C2	\$ 427.00	
	Fender, Left Hand	AM97003C2	\$ 403.00	
MX215, MX245, MX275, MX305, Magnum®: 180, 190, 210, 225, 235, 245, 260, 275, 290, 305, 315, 335, 340, 370	Fender, Left Hand Narrow Replaces 84586136, 87643174, 87643177	AM87703696	\$ 900.00	

Lighting



Application	Description	Part Number	Retail Price	Core
3220, 3230, 4210, 4230, 4240, 5120, 5130, 5140, 5220, 5230, 5240, 5250	LED Light Kit Includes Right Hand and Left Hand LED Headlight*, (6) Fender Mount LED Floodlights** and Stainless Steel Mounting Hardware Plug-and-Play Installation *4000 Lumens, 50 Watts, 4.16 Amps **3600 Lumens, 40 Watts, 3.33 Amps	AMX34158	\$ 820.00	





Case IH®—Tractor

Application	Description	Part Number	Retail Price	Core
 <p>7110, 7120, 7130, 7140, 7150, 7210, 7220, 7230, 7240, 7250, 8910, 8920, 8930, 8940, 8950</p>	<p>LED Light Kit Includes Right and Left Hand LED Headlights*, (2) Side Mount LED Floodlights** and (6) Upper Front Cab/Rear Fender Mount LED Floodlights For 12 Volt to 24 Volt Systems Plug-and-Play Installation *7000 Lumens, 100 Watts, 8.30 Amps **3600 Lumens, 40 Watts, 3.30 Amps</p>	AMX34164	\$ 1000.00	
 <p>9110, 9130, 9150, 9170, 9180, 9210, 9230, 9240, 9260, 9270, 9280, 9310, 9330, 9350, 9370, 9380, 9390, Steiger®: Bearcat 1000, Cougar 1000, CR-1225, CR- 1280, KR-1225, KR-1280, Panther 1000, Puma 1000, Wildcat 1000</p>	<p>LED Light Kit Requires the installation of connector onto wiring harness, pigtail connectors are provided Includes (2) LED Headlights, Hi/Lo Beams*, (8) LED Work Lights** and (8) Mating Deutsch Pigtails for Work Lights *3500 Lumens, 60 Watts, 5 Amps **3600 Lumens, 40 Watts, 3.33 Amps</p>	AMX34175	\$ 870.00	
 <p>MX110, MX120, MX135, MX150, MX170</p>	<p>LED Light Kit Includes Right Hand and Left LED Headlight**, (4) Bottom Mount LED Floodlights*, (2) Fender Mount LED Floodlights*, (2) Side Mount LED Floodlights* and Stainless Steel Mounting Hardware For 12 Volt to 24 Volt Systems Plug-and-Play Installation *3600 Lumens, 40 Watts, 3.30-3.33 Amps **6000 Lumens, 80 Watts, 6.60 Amps</p>	AMX34159	\$ 1000.00	
 <p>MX180, MX200, MX210, MX220, MX230, MX240, MX255, MX270, MX285</p>	<p>LED Light Kit Includes Center LED Headlight**, Right Hand and Left Hand LED Headlight***, Right Hand and Left Hand LED Corner Light with Work Light****, Right Hand and Left Hand LED Corner Light*****, (2) Bottom Mount LED Floodlights*, (2) Fender Mount LED Floodlights*, (2) Side Mount LED Floodlights* and Stainless Steel Hardware For 12 to 24 Volt Systems Plug-and-Play Installation *3600 Lumens, 40 Watts, 3.30-3.33 Amps **7200 Lumens, 108 Watts, 9 Amps ***5300 Lumens, 70 Watts, 5.80 Amps ****3000 Lumens, 30 Watts, 3.30 Amps *****17 Watts, 2.40 Amps</p>	AMX34157	\$ 1300.00	
 <p>MX215, MX245, MX275, MX305, Magnum®: 180, 190, 200, 210, 215, 220, 225, 235, 240, 245, 250, 260, 275, 280, 290, 305, 310, 315, 335, 340, 370, 380</p>	<p>LED Light Kit Includes (3) Front Headlights**, (2) LED Headlight Bulbs, Right Hand and Left Hand LED Corner Light w/ Work Light***, Right Hand and Left Hand LED Corner Light****, (2) Bottom Mount LED Floodlight*, (2) Fender Mount LED Floodlight* and (2) Side Mount LED Floodlight* For 12 to 24 Volt Systems Direct Replacement, Plug-and-Play Installation *3600 Lumens, 40 Watts, 3.30-3.33 Amps **3200 Lumens, 32 Watts, 2.60 Amps ***3000 Lumens, 30 Watts, 3.30 Amps ****17 Watts, 2.40 Amps</p>	AMX34156	\$ 1160.00	







Case IH®—Tractor

Application	Description	Part Number	Retail Price	Core
 <p>STX275, STX280, STX325, STX330, STX375, STX380, STX425, STX430, STX440, STX450, STX480, STX485, STX500, STX530, Steiger®: 330, 335, 380, 385, 430, 435, 480, 485, 530, 535</p>	<p>LED Light Kit Includes Right Hand and Left Hand Headlight*, Center Headlight**, (10) Work Lights on Fenders and Cab*** and Stainless Steel Hardware For 12 Volt to 24 Volt Systems Plug-and-Play Installation *5300 Lumens, 70 Watts, 5.80 Amps **7200 Lumens, 108 Watts, 9 Amps ***3600 Lumens, 40 Watts, 3.30 Amps</p>	AMX34176	\$ 1340.00	
 <p>CS80, CS85, CS90, CS95, CS100, CS105, CVX140, CVX150, CVX160, CVX175, CVX195, MXU100, MXU110, MXU125, MXU130, MXU135, Maxxum®: 110, 115, 120, 125, 130, 140, Puma®: 125, 130, 140, 145, 150, 155, 160, 165, 170, 180, 185, 195, 200, 210, 215, 225, 230</p>	<p>LED Upper Cab Light 6" x 3" x 2.50" Rectangle Light 3000 Lumens, 40 Watts, 3.33 Amps For 12 Volt to 24 Volt Systems Due to cab variations, please verify correct part number before ordering</p> <p>LED Upper Cab Light 6" x 3" x 2.50" Rectangle Light 3000 Lumens, 40 Watts, 3.33 Amps For 12 Volt to 24 Volt Systems Due to cab variations, please verify correct part number before ordering</p>	AMTL7040 AM82031078	\$ 90.00 \$ 72.00	
 <p>395, 495, 595, 695, 895, 995, 3220, 3230, 4210, 4230, 4240, 5120, 5130, 5140, 5220, 5230, 5240, 5250, C50, C60, C70, C80, C90, C100, CX50, CX60, CX70, CX80, CX90, CX100</p>	<p>LED Headlight, Right Hand Rectangle Light 4000 Lumens, 50 Watts, 4.16 Amps For 12 Volt to 24 Volt Systems Plug-and-Play Includes Stainless Steel Hardware Replaces 196482C2</p> <p>LED Headlight, Left Hand Rectangle Light 4000 Lumens, 50 Watts, 4.16 Amps For 12 Volt to 24 Volt Systems Plug-and-Play Includes Stainless Steel Hardware Replaces 196481C2</p>	AMTL5140R AMTL5140L	\$ 175.00 \$ 175.00	







Case IH®—Tractor

Application	Description	Part Number	Retail Price	Core
	7110, 7120, 7130, 7140, 7150, 7210, 7220, 7230, 7240, 7250, 8910, 8920, 8930, 8940, 8950	LED Headlight, Right Hand Corner Mount 10" x 5" x 5.50" Floodlight/Spotlight Combo Light 7000 Lumens, 100 Watts, 8.30 Amps For 12 Volt to 24 Volt Systems Plug-and-Play for Direct Replacement Includes Stainless Steel Hardware Replaces 91971C2	AMTL7140R	\$ 180.00
		LED Headlight, Left Hand Corner Mount 10" x 5" x 5.50" Floodlight/Spotlight Combo Light 7000 Lumens, 100 Watts, 8.30 Amps For 12 Volt to 24 Volt Systems Plug-and-Play for Direct Replacement Includes Stainless Steel Hardware Replaces 91972C2	AMTL7140L	\$ 180.00
		LED Headlight, Right Hand Corner Mount 10" x 5" x 5.50" Floodlight/Spotlight Combo Light 7000 Lumens, 100 Watts, 8.30 Amps For 12 Volt to 24 Volt Systems Plug-and-Play for Direct Replacement Includes Stainless Steel Hardware	AM91972C2	\$ 140.00
		LED Headlight, Left Hand Corner Mount 10" x 5" x 5.50" Floodlight/Spotlight Combo Light 7000 Lumens, 100 Watts, 8.30 Amps For 12 Volt to 24 Volt Systems Plug-and-Play for Direct Replacement Includes Stainless Steel Hardware	AM91971C2	\$ 140.00
	CX70, CX80, CX90, CX100, JX70U, JX80U, JX90U, JX100U, JX1060C, JX1070C, JX1075C, JX1080U, JX1085C, JX1090U, JX1095C, JX1100U, MX180, MX200, MX210, MX220, MX230, MX240, MX255, MX270, MX285, MXM120, MXM130, MXM140, MXM155, MXM175, MXM190, MXU100, MXU110, MXU115, MXU125, MXU130, MXU135, STX275, STX280, STX325, STX330, STX375, STX380, STX425, STX430, STX440, STX450, STX480, STX485, STX500, STX530, Farmall®: 85C, 85U, 95C, 95U, 105U, Steiger®: 280, 330, 335, 350, 380, 385, 430, 435, 480, 485, 530, 535	LED Headlight, Right Hand 5300 Lumens, 70 Watts, 5.80 Amps For 12 Volt to 24 Volt Systems Includes Stainless Steel Hardware Replaces 232450A2, 365841A1, 87429390	AM232448A2	\$ 180.00
		LED Headlight, Left Hand 5300 Lumens, 70 Watts, 5.80 Amps For 12 Volt to 24 Volt Systems Includes Stainless Steel Hardware Replaces 232451A2, 365842A1, 87429389	AM232449A1	\$ 180.00



Case IH®—Tractor

Application	Description	Part Number	Retail Price	Core
 MX100, MX110, MX120, MX135, MX150, MX170	LED Headlight, Right Hand 6000 Lumens, 80 Watts, 6.60 Amps For 12 Volt to 24 Volt Systems Plug-and-Play for Direct Replacement Includes Stainless Steel Mounting Hardware Replaces 178318A1, 178320A1, 148322A1	AMTL6200R	\$ 180.00	
	LED Headlight, Left Hand Flood/Spotlight Combo 6000 Lumens, 80 Watts, 6.60 Amps For 12 Volt to 24 Volt Systems Plug-and-Play for Direct Replacement Includes Stainless Steel Mounting Hardware Replaces 178311A1, 178313A1, 178315A1, 178317A1, 178319A1, 178321A1	AMTL6200L	\$ 180.00	
 MX215, MX220, MX230, MX240, MX245, MX255, MX275, MX285, MX305, STX275, STX280, STX325, STX330, STX375, STX380, STX425, STX430, STX450, STX480, STX500, STX530, Magnum®: 180, 190, 200, 210, 215, 220, 225, 235, 240, 245, 250, 260, 275, 280, 290, 305, 310, 315, 335, 340, 370, 380, Puma®: 115, 125, 130, 140, 145, 150, 155, 160, 165, 170, 180, 185, 195, 200, 210, 215, 220, 225, 230, 240, Steiger®: 330, 335, 350, 370, 380, 385, 400, 450, 470, 485, 500, 530QT, 535, 540, 550, 580, 600, 620 Replaces 87328621, 87539115	LED Headlight Front Mount 3.37" Diameter Round Light 3200 Lumens, 32 Watts, 2.60 Amps For 12 Volt to 24 Volt Systems Replaces the factory bulb/housing Plug-and-Play Installation	AMTL6020	\$ 95.00	
	LED Headlight Front Mount 3.37" Diameter Round Light 3200 Lumens, 40 Watts, 2.60 Amps For 12 Volt to 24 Volt Systems Will Bolt into Factory Light Housing Plug-and-Play Installation	AMX34172	\$ 76.00	
 MX180, MX200, MX210, MX220, MX230, MX240, MX255, MX270, MX285, STX275, STX280, STX325, STX330, STX375, STX380, STX425, STX430, STX440, STX450, STX480, STX500, STX530, Steiger®: 280, 330, 335, 380, 385, 430, 435, 480, 485, 530, 535	LED Headlight, Center 4.25" x 10.50" Rectangle Light 7200 Lumens, 108 Watts, 9 Amps For 12 Volt to 24 Volt Systems Replaces 232454A2, 232455A2	AMTL6010	\$ 175.00	
 3220 ASN 11070000, 3230, 4210, 4230, 4240, 5120, 5130, 5140, 5220, 5230, 5240, 5250, C50, C60, C70, C80, C90, C100, CX50, CX60, CX70, CX80, CX90, CX100	Headlight, Right Hand Includes Hardware Replaces 1964579C2, 1964881C1	AM1964881C2	\$ 127.00	
	Headlight, Left Hand Include Hardware Replaces 1964580C2, 1964882C1	AM1964882C2	\$ 127.00	
 MX215, MX245, MX275, MX305, Magnum®: 180, 190, 200, 210, 215, 220, 225, 235, 240, 245, 250, 260, 275, 280, 290, 305, 310, 315, 335, 340, 370, 380	Headlight, Right Hand	AM87309030	\$ 140.00	
	Headlight, Left Hand	AM87309029	\$ 125.60	
 Universal Equipment	LED Floodlight All-Position Light 4.25" x 4.25" Square Light 2650 Lumens, 48 Watts, 4 Amps For 12 Volt to 24 Volt Systems Includes Mounting Bracket and Stainless Steel Hardware	AMTL105F	\$ 95.00	





Case IH®—Tractor

Application	Description	Part Number	Retail Price	Core
 Universal Equipment	LED Floodlight All-Position Light 6.25" x 1.75" Rectangle Light 1300 Lumens, 18 Watts, 1.50 Amps For 12 Volt to 24 Volt Systems Includes Mounting Bracket and Stainless Steel Hardware	AMTL118F	\$ 50.00	
 Universal Equipment	LED Floodlight All-Position Light 5" Round Light 3200 Lumens, 40 Watts, 3.30 Amps For 12 Volt to 24 Volt Systems Includes Mounting Bracket and Stainless Steel Hardware	AMTL180	\$ 89.00	
 Universal Equipment	LED Floodlight All-Position Light 4.25" Round Light 2650 Lumens, 42 Watts, 3.50 Amps For 12 Volt to 24 Volt Systems Includes Mounting Bracket and Stainless Steel Hardware	AMTL115F	\$ 59.00	
 Universal Equipment	LED Floodlight All-Position Light Round Light 6900 Lumens, 50 Watts, 4.10 Amps For 9 Volt to 32 Volt Systems Includes Mounting Bracket and Stainless Steel Hardware	AMTL500F	\$ 120.00	
	LED Floodlight All-Position Light 4.30" Round Light 5040 Lumens, 50 Watts, 4.10 Amps For 12 Volt to 24 Volt Systems Includes Stainless Steel Adjustable Mounting Bracket Replaces 84236850, 87555142, 87584890	AMAT305931	\$ 96.00	
 Universal Equipment	LED Wide Floodlight All-Position Light 5" x 7" Rectangle Light 3800 Lumens, 35 Watts For 12 Volt to 24 Volt Systems Replaces 47682629, 47682620, 84236850, 87555142, 87584890	AMX34171	\$ 60.00	
 9110, 9130, 9150, 9170, 9180, 9210, 9230, 9240, 9250, 9260, 9270, 9280, 9310, 9330, 9350, 9370, 9380, 9390, Steiger®: Bearcat 1000, Cougar 1000, CR1225, CR1280, KR1225	LED Floodlight Front Grille Mount 5.75" x 8.25" Rectangle Light 3500 Lumens, 60 Watts, 5 Amps For 12 Volt to 24 Volt Systems Includes Correct Mounting Frame/Bracket (2) Required Replaces 60-6730T91, 60-6731T1	AMTL2020	\$ 110.00	
	LED Floodlight Front Grille Mount 5.75" x 8.25" Rectangle Light 3500 Lumens, 60 Watts, 5 Amps For 12 Volt to 24 Volt Systems Includes Correct Mounting Frame/Bracket (2) Required Replaces 60-6730T91, 60-6731T1	AM20-2063T1	\$ 88.00	







Case IH®—Tractor

	Application	Description	Part Number	Retail Price	Core
	9110, 9130, 9150, 9170, 9180, 9210, 9230, 9240, 9260, 9280, 9310, 9330, 9350, 9370, 9380, 9390, CX50, CX60, CX70, CX80, CX90, CX100, MX80C, MX90C, MX100, MX100C, MX110, MX120, MX135, MX150, MX170, MX180, MX200, MX210, MX215, MX220, MX230, MX240, MX245, MX255, MX270, MX275, MX285, MX305, Magnum®: 215, 235, 245, 255, 275, 305, 335	LED Floodlight Fender Mount w/ Hollow Bolt 6" x 3.50" Rectangle Light 3600 Lumens, 40 Watts, 3.33 Amps For 12 Volt to 24 Volt Systems Uses Original Wiring Includes Deutsch Connector, Mounting Bracket and Stainless Steel Hardware	AMTL3085	\$ 90.00	
	Universal Equipment	LED Floodlight, Sealed Beam Fender Mount 4.50" Diameter Round Light 1250 Lumens, 18 Watts, 1.50 Amps Trapezoid Pattern For 12 Volt to 24 Volt Systems Replaces 131203C1, 373662R1, 373662R91	AMTL3010	\$ 40.00	
		LED Floodlight Fender Mount 4.50" Diameter Sealed Beam Round Light 1250 Lumens, 18 Watts, 1.20 Amps Trapezoid Pattern For 12 Volt to 24 Volt Systems Lasts 50 times longer than halogen lighting, vibration resistant w/ no filament failures, uses original mount and wiring, Operating temperature of -40°F to 140°F / -40°C to 60°C Replaces 131203C1, 373662R1, 373662R91	AMRE336111	\$ 35.00	
	Universal Equipment	LED Floodlight Fender Mount 4.50" Diameter Sealed Beam Round Light 1440 Lumens, 18 Watts, 1.60 Amps Lasts 50 times longer than halogen lighting, vibration resistant w/ no filament failures, 2-terminal connection, Operating temperature of -40°F to 140°F / -40°C to 60°C Replaces 131203C1	AMRE336112	\$ 67.75	

Case IH®—Tractor





	Application	Description	Part Number	Retail Price	Core
	5120, 5130, 5140, 5220, 5230, 5240, 5250, 7110, 7120, 7130, 7140, 7150, 7210, 7220, 7230, 7240, 7250, 8910, 8920, 8930, 8940, 8950, 9110, 9130, 9150, 9170, 9180, 9210, 9230, 9250, 9270, 9280, (CX50, CX60, CX70, CX80, CX90, CX100, MX100, MX100C, MX110, MX120, MX135, MX150, MX170 - w/ Diesel Engine), MX80C, MX90C, MX180, MX200, MX210, MX215, MX220, MX230, MX240, MX245, MX255, MX270, MX275, MX285, MX305, STX275, (STX280, STX330, STX380, STX430, STX480, STX530 SN Z6F100023-Z6F105001), STX285, STX325, STX375, (STX425, STX450, STX500 ASN JEE0099501), STX440, STX450, STX485, Magnum®: 215, 245, 255, 260, 275, 305, 335, Steiger® 4WD: 280, 330, 335, 380, 385, 430, 435, 480, 485, 530, 535 Replaces 92263C1, 178345A1, 180097A1, 275335A1, 305256A1, 1983210C1, 87435762, 87773385	LED Floodlight Lower Front, Cab, Fender and ROPS 6" x 3.50" x 6" Rectangle Light 3600 Lumens, 40 Watts, 3.30 Amps For 12 Volt to 24 Volt Systems Includes Connector, Plug-and-Play	AMTL3030	\$ 90.00	
		LED Floodlight Lower Front, Cab, Fender and ROPS 6" x 3.50" x 6" Rectangle Light 3600 Lumens, 40 Watts, 3.30 Amps For 12 Volt to 24 Volt Systems Includes Connector, Plug-and-Play	AM92269C1	\$ 72.00	
	5120, 5130, 5140, 5220, 5230, 5240, 5250, 7110, 7120, 7130, 7140, 7150, 7210, 7220, 7230, 7240, 7250, 8910, 8920, 8930, 8940, 8950, 9110, 9130, 9150, 9170, 9180, 9210, 9230, 9250, 9270, 9280, CX50, CX60, MX80C, MX90C, MX100, MX100C, MX110, MX120, MX135, MX150, MX170, STX275, STX285, STX325, STX375, STX425, STX430, STX440, STX450, STX480, STX485, STX500, STX530	LED Floodlight Side Mount 3.50" x 6" Rectangle Light 3600 Lumens, 40 Watts, 3.33 Amps Includes Connector for plug-and-play installation	AM92266C2	\$ 85.00	
	5130, 5140, 5220, 5230, 5240, 5250, 7110, 7120, 7130, 7140, 7150, 7210, 7220, 7230, 7240, 7250, 8910, 8920, 8930, 8940, 8950, MX80C, MX100, MX120, MX135, MX150, MX170, STX275, STX280, STX325, STX330, STX375, STX380, STX425, STX430, STX440, STX450, STX480, STX485, STX500, STX530, Steiger®: 330, 335, 380, 385, 430, 485, 535	LED Floodlight Side Mount 6" x 3.50" Rectangle Light 3600 Lumens, 40 Watts, 3.30 Amps For 12 Volt to 24 Volt Systems Uses Original Mount and Wiring Includes Swivel Mounting Bracket and Hardware	AMTL3070	\$ 90.00	
		LED Floodlight Side Mount 6" x 3.50" Rectangle Light 3600 Lumens, 40 Watts, 3.30 Amps For 12 Volt to 24 Volt Systems Uses Original Mount and Wiring Includes Swivel Mounting Bracket and Hardware	AM92266C1	\$ 68.00	
	MX180, MX200, MX210, MX215, MX220, MX230, MX240, MX245, MX255, MX275, MX285, MX305, Magnum®: 215, 245, 255, 260, 275, 305, 335	LED Floodlight Side Mount 6" x 3.50" x 3" Rectangle Light 3600 Lumens, 40 Watts, 3.30 Amps For 12 Volt to 24 Volt Systems Requires Splicing into Original Wiring	AMTL3075	\$ 90.00	

Case IH®—Tractor









Application	Description	Part Number	Retail Price	Core
 <p>MX180, MX200, MX210, MX215, MX220, MX230, MX240, MX245, MX255, MX270, MX275, MX285, MX305, Magnum®: 215, 245, 255, 275, 305</p>	<p>LED Floodlight Cab Mount 6" x 3" Rectangle Light 3600 Lumens, 40 Watts, 3.33 Amps For 12 Volt to 24 Volt Systems Uses Original Mount and Wiring Includes Deutsch Connector, Mounting Bracket and Stainless Steel Hardware Replaces 9824851</p>	AMTL3050	\$ 90.00	
 <p>Universal Equipment</p>	<p>LED Floodlight Cab and Fender Mount 3.50" x 6" Rectangle Light 3600 Lumens, 40 Watts, 3 Amps</p>	AMX34146	\$ 65.00	
 <p>Steiger®: 1225, 1280, 1325, 1360, 1400, CM Series, KM Series, KR Series, KS Series, ST Series Replaces 91666C91, 245555C1</p>	<p>LED Flood/Spotlight Combo Cab, Front and Rear Fender Mount 4" x 6" Rectangle Light 4800 Lumens, 50 Watts, 4.16 Amps For 12 Volt to 24 Volt Systems</p>	AMTL175F	\$ 120.00	
	<p>LED Flood/Spotlight Combo Cab, Front and Rear Fender Mount 4" x 6" Rectangle Light 4800 Lumens, 50 Watts, 4 Amps For 12 Volt to 24 Volt Systems</p>	AM245897C91	\$ 92.00	
 <p>Universal Equipment</p>	<p>LED Spotlight All-Position Light 4.25" x 4.25" Square Light 1400 Lumens, 27 Watts, 2.20 Amps For 12 Volt to 24 Volt Systems</p>	AMTL100S	\$ 45.00	
 <p>Universal Equipment</p>	<p>LED Spotlight All-Position Light 6.25" x 1.75" Rectangle Light 1300 Lumens, 18 Watts, 1.50 Amps For 12 Volt to 24 Volt Systems Includes Mounting Bracket and Stainless Steel Hardware</p>	AMTL118S	\$ 50.00	
 <p>Universal Equipment</p>	<p>LED Spotlight All-Position Light Round Light 6900 Lumens, 50 Watts, 4.10 Amps For 9 Volt to 32 Volt Systems Includes Mounting Bracket and Stainless Steel Hardware</p>	AMTL500S	\$ 120.00	
 <p>Universal Equipment</p>	<p>LED Trapezoid Light Cab and Fender Mount 4.50" Diameter Round Light 2800 Lumens, 40 Watts, 3.30 Amps Trapezoid Pattern For 12 Volt to 24 Volt Systems Bottom Mount w/ Built-In Heat Sink Includes Mounting Bracket, Long and Short Rubber Bezels, and Stainless Steel Hardware Replaces 131368C92</p>	AMTL2080	\$ 95.00	
	<p>LED Trapezoid Light Cab and Rear Fender Mount 4.50" Diameter Round Light 2800 Lumens, 40 Watts, 3.30 Amps Trapezoid Pattern For 12 Volt to 24 Volt Systems Bottom Mount w/ Built-In Heat Sink Includes Mounting Bracket, Long and Short Rubber Bezels and Stainless Steel Hardware Replaces 131368C92</p>	AMX33121	\$ 76.00	

Prices Subject to Change without Prior Notice. The use of original equipment manufacturer (OEM) part numbers or trademarks, e.g. Case® and John Deere®, are for reference purposes only and for indicating product use and compatibility. Our company and the listed replacement parts contained herein are not sponsored, approved or manufactured by the OEM. All parts are New unless designated Reman in the description.



Case IH®—Tractor

	Application	Description	Part Number	Retail Price	Core
	595, 695, 895, 995, 3220, 3230, 4210, 4230, 4240, 5120, 5130, 5140, 5220, 5230, 5240, 5250	LED Warning Light, Right Hand Cab Mount 4.75" x 3.25" x 2.50" Rectangle Light Amber Lens, 7 Watts, 0.60 Amp For 12 Volt to 24 Volt Systems Includes Stainless Steel Hardware Replaces 1983404C1	AMTL7010R	\$ 50.00	
		LED Warning Light, Left Hand Cab Mount 4.75" x 3.25" x 2.50" Rectangle Light Amber Lens, 7 Watts, 0.60 Amp For 12 Volt to 24 Volt Systems Included Stainless Steel Hardware Replaces 1983404C1	AMTL7010L	\$ 50.00	
	7110, 7120, 7130, 7140, 7150, 7210, 7220, 7230, 7240, 7250, 8910, 8920, 8930, 8940, 8950, CX50, CX60, CX70, CX80, CX90, CX100, MX80C, MX90C, MX100, MX100C, MX110, MX135, MX150	LED Warning Light Cab Mount 3.15" x 6.75" Rectangle Light 9 Watts, 0.75 Amp For 12 Volt to 24 Volt Systems Replaces 92260C1, 107324C91, 130882C91, 216044C91, 216044C92, 9706415, 83977683, 86012669, 86014019, 86016518, 86023276, 87053368	AMX34180	\$ 50.00	
		LED Warning Light Cab Mount 3.15" x 6.75" Rectangle Light 9 Watts, 0.75 Amps For 12 Volt to 24 Volt Systems Replaces 92260C1, 107324C91, 130882C91, 216044C91, 216044C92, 9706415, 83977683, 86012669, 86014019, 86016518, 86023276, 87053368	AM92185C1	\$ 40.00	
	9110, 9130, 9150, 9170, 9210, 9230, 9240, 9250, 9260, 9270, 9280, 9310, 9330, 9350, 9370, 9380, 9390 Replaces 22-665T1, 20-1950T91, 60-6246T1, A187626	LED Warning Light Cab Mount 2" x 7.75" Rectangle Light Amber Lens 9 Watts, 0.75 Amp For 12 Volt to 24 Volt Systems Requires 6 ohm Load Resistor if 4 Lights are installed	AMX34184	\$ 50.00	
		LED Warning Light Cab Mount 2" x 7.75" Rectangle Light Amber Lens 9 Watts, 0.75 Amp For 12 Volt to 24 Volt Systems Requires 6 ohm Load Resistor if 4 Lights are installed	AMAR60250	\$ 40.00	
	Universal Equipment	LED Warning Light Cab, Header or Swather Mount Can be used for Turn Signal, Brake or Running Lights 4.125" Diameter Round Light Double Sided, Amber Lenses 25 Bulbs per Side For 12 Volt to 24 Volt Systems	AMTLFL2	\$ 55.00	
		LED Warning Light Cab, Header or Swather Mount Can be used for Turn Signal, Brake or Running Lights 4.125" Diameter Round Light Double Sided, Amber Lenses 25 Bulbs per Side For 12 Volt to 24 Volt Systems	AMX1910149	\$ 44.00	





Case IH®—Tractor

Application	Description	Part Number	Retail Price	Core
 Universal Equipment	LED Warning Light Cab, Header or Swather Mount Can be used for Turn Signal, Brake or Running Lights 4.125" Diameter Round Light Double Sided, Red and Amber Lenses 25 Bulbs per Side For 12 Volt to 24 Volt Systems	AMTLFL3	\$ 55.00	
	LED Warning Light Cab, Header or Swather Mount Can be used for Turn Signal, Brake or Running Lights 4.125" Diameter Round Light Double Sided, Red and Amber Lenses 25 Bulbs per Side For 12 Volt to 24 Volt Systems	AMX33126	\$ 44.00	
 Universal Equipment	LED Magnetic Warning Light All-Position Light 360° Flashing Light, Multiple Patterns 9.50" x 6.75" Rectangle Light Magnetic Base or Solid Mount For 12 Volt to 24 Volt Systems Includes Cigarette Lighter Adapter, Wiring and Switch	AMTL1100	\$ 170.00	
 Universal Equipment	LED Magnetic Warning Light All-Position Light 360° Flashing Light, Multiple Patterns 14" x 6.75" Rectangle Light Magnetic Base or Solid Mount For 12 Volt to 24 Volt Systems Includes Cigarette Lighter Adapter, Wiring and Switch	AMTL1200	\$ 190.00	
Universal Equipment	Warning Beacon 360° Flashing Beacon, Amber Lens For 0.9435" Diameter Pipe Replaces 84337818, AZ44705, AZ101891	AM82018390	\$ 45.64	
 Universal Equipment	LED Warning Beacon 360° Flashing Beacon 2.75" x 5.25" Light Polycarbonate Amber Lens and Housing For 12 Volt to 24 Volt Systems Includes Solid Mounting Pad and Stainless Steel Hardware	AMTL2100	\$ 30.00	
 Universal Equipment	LED Warning Beacon 360° Flashing Beacon, 3 Different Patterns 5" x 10" Light Amber Lens, 48 Watts, 4 Amps For 12 Volt to 24 Volt Systems Brackets Sold Separately	AMX33131	\$ 75.00	
 Universal Equipment	Warning Beacon Bracket	AMX33132	\$ 15.00	
 Universal Equipment	Warning Beacon Bracket	AMX33133	\$ 15.00	
 Universal Equipment	Warning Beacon Bracket	AMX33137	\$ 15.00	

Case IH®—Tractor

Application	Description	Part Number	Retail Price	Core
 Universal Equipment	Warning Beacon Bracket	AMX33135	\$ 15.00	
 Universal Equipment	LED Light Bar 4" Long, 1260 Lumens, Cree Bulbs	AMLED4	\$ 45.00	
	LED Light Bar Flood/Spotlight Combo 10" Long, 5700 Lumens, 50 Watts, 4.20 Amps For 12 Volt to 24 Volt Systems Includes Mounting Bracket and Stainless Steel Hardware	AMTL10SRC	\$ 129.00	
	LED Light Bar Floodlight/Spotlight Combo 14" Long, 5400 Lumens, 72 Watts, 6 Amps Die Cast Aluminum Housing, Polycarbonate Lens For 12 Volt to 24 Volt Systems Includes Mounting Bracket and Heavy Duty Stainless Steel Hardware	AMTLB410C	\$ 150.00	
	LED Light Bar Floodlight/Spotlight Combo 30" Long, 13600 Lumens, 150 Watts, 12.50 Amps For 12 Volt to 24 Volt Systems Includes Mounting Bracket and Stainless Steel Hardware	AMTL30SRC	\$ 230.00	
	LED Light Bar 30" Long, 13860 Lumens, Cree Bulbs	AMLED30	\$ 130.00	
	LED Light Bar Floodlight/Spotlight Combo 40" Long, 17300 Lumens, 200 Watts, 16.70 Amps For 12 Volt to 24 Volt Systems Includes Mounting Brackets and Stainless Steel Hardware	AMTL40SRC	\$ 300.00	
	LED Light Bar 40" Long, 18200 Lumens, Cree Bulbs	AMLED40	\$ 160.00	
	LED Light Bar Floodlight/Spotlight Combo 42" Long, 14500 Lumens, 240 Watts, 19 Amps For 12 Volt to 24 Volt Systems Includes Mounting Bracket and Stainless Steel Hardware Replaces 1163691	AMTLB440C	\$ 250.00	
	LED Light Bar, Curved 50" Long, 21500 Lumens, Cree Bulbs	AMLED50C	\$ 190.00	

Case IH®—Tractor

Application	Description	Part Number	Retail Price	Core
 <p>JX70U, JX80U, JX90U, JX100U, MX180, MX200, MX210, MX215, MX220, MX230, MX240, MX255, MX270, MX285, MXM120, MXM130, MXM140, MXM155, MXM175, MXM190, Magnum®: 235, 250, 260, 280, 290, 310, 315, 340, 370, 380</p>	LED Front Corner Light w/ Work Light, Right Hand Corner Light: Amber Lens, 17 Watts, 2.40 Amps, Built-in Resistor (12 Watts) Work Light: Floodlight, 3300 Lumens, 30 Watts, 3.30 Amps For 12 Volt to 24 Volt Systems Plug-and-Play for Direct Replacement Replaces 279220A1	AMTL6120R	\$ 120.00	
	LED Front Corner Light w/ Work Light, Left Hand Corner Light: Amber Lens, 17 Watts, 2.40 Amps, Built-in Resistor (12 Watts) Work Light: Floodlight, 3300 Lumens, 30 Watts, 3.30 Amps For 12 Volt to 24 Volt Systems Plug-and-Play for Direct Replacement Replaces 279219A1	AMTL6120L	\$ 120.00	
 <p>JX70U, JX80U, JX90U, JX100U, JX1070C, JX1075C, JX1085C, JX1095C, MX180, MX200, MX210, MX215, MX220, MX230, MX240, MX245, MX255, MX270, MX275, MX285, MX305, MXM120, MXM130, MXM140, MXM155, MXM175, MXM190, Magnum®: 180, 190, 210, 215, 225, 235, 245, 250, 255, 260, 275, 280, 290, 305, 310, 315, 335, 340, 370, 380</p>	LED Rear Corner Light, Right Hand Amber Lens, 17 Watts, 2.40 Amps Built-In Resistor, 12 Watts For 12 Volt to 24 Volt Systems Plug-and-Play for Direct Replacement	AM279223A1	\$ 60.00	
	LED Rear Corner Light, Left Hand Amber Lens, 17 Watts, 2.40 Amps Built-In Resistor, 12 Watts For 12 Volt to 24 Volt Systems Plug-and-Play for Direct Replacement	AM279224A1	\$ 60.00	
 <p>MX210, MX230, MX255, MX285</p>	LED Corner Light w/ Tail Light, Right Hand Corner Light: Amber Lens, 17 Watts, 2.40 Amps, Built-In Resistor (12 Watts) Tail Light: Red Lens, 30 Watts, 3.30 Amps For 12 Volt to 24 Volt Systems Plug-and-Play for Direct Replacement Replaces 357540A1	AMTL6145R	\$ 120.00	
	LED Corner Light w/ Tail Light, Left Hand Corner Light Specifications: Amber Lens, 17 Watts, 2.40 Amps, Built-In Resistor (12 Watts) Tail Light: Red Lens, 30 Watts, 3.30 Amps For 12 Volt to 24 Volt Systems Plug-and-Play for Direct Replacement Replaces 357541A1	AMTL6145L	\$ 120.00	
 <p>Universal Equipment</p>	LED Magnetic Work Light All-Position Light 3.25" Square Floodlight 900 Lumens Magnetic Base Includes Lithium Ion Battery, Cigarette Lighter and DC Charger	AMTL2460	\$ 79.00	
 <p>C50, C60, C70, C80, C90, C100, CX50, CX60, CX70, CX80, CX90, CX100, MX80C, MX90C, MX100, MX100C, MX110, MX120, MX135, MX150, MX170</p>	Rotary Switch, 4-Position	AM177249A1	\$ 60.00	

Case IH®—Tractor

Cab Components—Miscellaneous

Application	Description	Part Number	Retail Price	Core
7110, 7120, 7130, 7140, 7150, 7210, 7220, 7230, 7240, 7250, 8910, 8920, 8930, 8940, 8950	Cab Mount Kit (4) Required	AM1286905C2	\$ 60.00	

Prices Subject to Change without Prior Notice. The use of original equipment manufacturer (OEM) part numbers or trademarks, e.g. Case® and John Deere®, are for reference purposes only and for indicating product use and compatibility. Our company and the listed replacement parts contained herein are not sponsored, approved or manufactured by the OEM. All parts are New unless designated Reman in the description.





Case IH®—Tractor

Application	Description	Part Number	Retail Price	Core
Magnum®: 180, 190, 210, 225, Puma®: 115, 125, 140, 155, 165, 170, 180, 185, 195, 200, 210, 215, 225, 230	Reman Monitor Replaces 293255A3, 295133A5, 87668610	AM84604338R	\$ 1650.00	\$ 500.00
(MX215, MX245, MX275, MX305 ASN Z6RZ04000), Magnum®: 215, 245, 275, 305, 335	Reman AFS Display Monitor Universal Display Plus Monitor (2) Data Card Ports located on Left Hand Side of Monitor and (2) Electrical Ports located on Bottom of Monitor	AM295133A3	\$ 1650.00	\$ 500.00
7110, 7120, 7130, 7140, 7150, 7210, 7220, 7230, 7240, 7250, 8910, 8920, 8930, 8940, 8950	Monitor Bracket Well-suited for use w/ multiple monitors, less restriction of operator's view improves safety. Assembly hardware and tray pad included, monitor mounting hardware not included.	AMSS3190	\$ 180.00	
(MX210, MX215, MX230, MX245, MX255, MX285, MX305, Magnum®: 180, 190, 210, 215, 225, 235, 245, 260, 275, 290, 305, 315, 335, 340, 370 - Prior to 2013)	Monitor Bracket Well-suited for use w/ multiple monitors, less restriction of operator's view improves safety. Assembly hardware and tray pad included, monitor mounting hardware not included.	AMSS3178	\$ 202.00	
MX210, MX215, MX230, MX245, MX255, MX285, MX305, Magnum: 180, 190, 210, 215, 225, 235, 245, 260, 275, 290, 305, 315, 335, 340, 370 - All 2014 and Later	Monitor Bracket Well-suited for use w/ multiple monitors, less restriction of operator's view improves safety. Assembly hardware and tray pad included, monitor mounting hardware not included.	AMSS3192	\$ 180.00	
5120, 5130, 5140, 5220, 5230, 5240, 5250, 7110, 7120, 7130, 7140, 7150, 7210, 7220, 7230, 7240, 7250, 8910, 8920, 8930, 8940, 8950, CX50, CX60, CX70, CX80, CX90, CX100, MX80C, MX90C, MX100C, MX110, MX120, MX135, MX150, MX170, MX180, MX200, MX210, MX220, MX230, MX240, MX255, MX270, MX285	Windshield Wiper Motor, Front 12 Volt Replaces 427087A, 87714999	AMA186256	\$ 145.00	
MXM120, MXM130, MXM140, MXM155, MXM175, MXM190	Windshield Wiper Motor Replaces 82858505	AM82016930	\$ 210.00	
Maxxum®: 115, 125, 135, 145, 150	Windshield Wiper Motor	AM84572268	\$ 116.80	
5120, 5130, 5140, 5220, 5230, 5240, 5250	Mirror Mount Rod Assembly	Right Hand Left Hand	AM1535638C1 AM1535639C1	\$ 40.00 \$ 41.00
5120, 5130, 5140, 5220, 5230, 5240, 5250	Mirror Extension Kit Features Extendable Mirrors, Breakaway System, Collapsible Forward and Backward, Mirror Length of 22" to 36", Extendable to 14", Powder Coat Finish, Includes 8" x 11" Wide-Angle Convex Mirror and All Mounting Hardware	Right Hand Left Hand	AMSS3134 AMSS3133	\$ 211.00 \$ 211.00
7110, 7120, 7130, 7140, 7150, 7210, 7220, 7230, 7240, 7250	Mirror Extension Kit Features Extendable Mirrors, Breakaway System, Collapsible forward and backward, Mirror length of 22" to 36", Extendable to 14", Powder coat finish Includes 8" x 11" Wide-Angle Convex Mirror and All Mounting Hardware	Right Hand Left Hand	AMSS3128 AMSS3132	\$ 211.00 \$ 211.00
8910, 8920, 8930, 8940, 8950, MX180, MX200, MX210, MX215, MX220, MX230, MX240, MX245, MX255, MX270, MX275, MX285, MX305	Mirror Extension Kit Features Extendable Mirrors, Breakaway System, Collapsible Forward and Backward, Mirror Length of 22" to 36", Extendable to 14", Powder Coat Finish, Includes 8" x 11" Wide-Angle Convex Mirror and All Mounting Hardware	Right Hand Left Hand	AMSS3131 AMSS3130	\$ 211.00 \$ 211.00
CX50, CX60, CX70, CX80, CX90, CX100, MXU100, MXU110, MXU115, MXU125, MXU130, MXU135, Puma®: 165, 170, 180, 185, 195, 200, 210, 215, 220, 225, 230, 240	Rear View Mirror 5.709" x 7.677" Convex Mirror, Universal Clamp Mounting Replaces 259201A1	AM87398308	\$ 32.03	

Case IH®—Tractor













Application	Description	Part Number	Retail Price	Core
7110, 7120, 7130, 7140, 7150, 7210, 7220, 7230, 7240, 7250, 8910, 8920, 8930, 8940, 8950	Door Panel Thermoformed gray plastic liner with foam insulation pre-formed pieces, OEM gray/black matrix cloth center covering, fastens to the tractor using existing hardware Replaces 97082C5	AM97082C6	\$ 211.00	
7110, 7120, 7130, 7140, 7150, 7210, 7220, 7230, 7240, 7250, 8910, 8920, 8930, 8940, 8950	Front Lower Panel Below Cab Primer Coated, Ready for Paint	Right Hand AM1348226C1 Left Hand AM96764C2	\$ 192.00 \$ 192.00	
7110, 7120, 7130, 7140, 7150, 7210, 7220, 7230, 7240, 7250, 8910, 8920, 8930, 8940, 8950	Front Lower Panel Primer Coated, Ready for Paint	Right Hand AM96710C1 Left Hand AM96709C1	\$ 192.00 \$ 192.00	
7110, 7120, 7130, 7140, 7150	Lower Panel Plastic Replaces 97076C2	Right Hand AM1987285C1	\$ 140.00	
7210, 7220, 7230, 7240, 7250, 8910, 8920, 8930, 8940, 8950	Lower Panel	Right Hand AM123399A1	\$ 284.00	
Puma®: 125, 140, 155, 165, 180, 195, 210, 225	Cab Mount Isolator	AM87396965	\$ 78.00	
Combines: 1420, 1440, 1460, 1480, 1620, 1640, 1644, 1660, 1670, 1680, 1688	Cab Mount Isolator Replaces 117722C1, 117722C2, 117722C3	AM117722C4	\$ 25.00	
7110, 7120, 7130, 7140, 7150 - Early w/ Filter Heated Fender	Cab Corner, Lower Primer Coated, Ready for Paint	Right Hand AM96765C1	\$ 172.00	
7210, 7220, 7230, 7240, 7250, 8910, 8920, 8930, 8940, 8950	Console Cover	AM193925A1	\$ 355.00	
Magnum®: 235, 250, 260, 280, 290, 310, 315, 340, 370, 380, Steiger®: 350, 400, 450, 500, 550, 600, Quadtrac®: 450, 500, 550, 600	Joystick Multi-Function Handle, Powershift w/ Creeper	AM84567332	\$ 995.00	
7110	Decal Set, Hood Replaces 1334444C1, 1334445C1, 1342044C1, 1342045C1	AMX19127	\$ 98.00	
7130	Decal Set, Hood Replaces 1334444C1, 1334445C1, 1342048C1, 1342049C1	AMX19128	\$ 107.00	
7140	Decal Set, Hood Replaces 1334444C1, 1334445C1, 1342050C1, 1342051C1	AMX19129	\$ 107.00	
7230	Decal Set, Hood	AMX19130	\$ 107.00	
8930	Decal Set, Hood	AMX19131	\$ 107.00	

Glass











Application	Description	Part Number	Retail Price	Core
 Maxxum®: 100, 110, 115, 120, 125, 130, 140, MXU100, MXU110, MXU115, MXU125, MXU130, MXU135	Front Windshield Glass Hinged	AM82032042	\$ 255.00	
 5120, 5130, 5140, 5150, 5220, 5230, 5240, 5250	Front Windshield Glass Replaces 1330875C1	AM248715A1	\$ 365.00	
 7110, 7120, 7130, 7140, 7150, 7210, 7220, 7230, 7240, 7250, 8910, 8920, 8930, 8940, 8950	Front Windshield Glass Replaces 96594C2, 1340195C2	AM1340195C1	\$ 282.46	
 CX50, CX60, CX70, CX80, CX90, CX100, MX80C, MX90C, MX100C	Front Windshield Glass	AM255024A1	\$ 485.00	

Prices Subject to Change without Prior Notice. The use of original equipment manufacturer (OEM) part numbers or trademarks, e.g. Case® and John Deere®, are for reference purposes only and for indicating product use and compatibility. Our company and the listed replacement parts contained herein are not sponsored, approved or manufactured by the OEM. All parts are New unless designated Reman in the description.















Case IH®—Tractor

	Application	Description	Part Number	Retail Price	Core
	CX50, CX60, CX70, CX80, CX90, CX100, MX80C, MX90C, MX100, MX100C, MX110, MX120, MX135, MX150, MX170	Front Windshield Glass Replaces 190032A4, 190032A5, 190034A4	AM190034A5	\$ 140.00	
	CX70, CX80, CX90, CX100	Front Windshield Glass Replaces 238520A2	AM238520A3	\$ 485.00	
	CX70, CX80, CX90, CX100	Front Windshield Glass European Style Replaces 238682A4	AM238682A3	\$ 325.00	
	JX70U, JX80U, JX90U, JX100U, JX1070U, JX1080U, JX1090U, JX1100U, Farmall®: 85U, 95U, 105U	Front Windshield Glass	AM82002183	\$ 340.00	
	MXM120, MXM130, MXM140, MXM155, MXM175, MXM190	Front Windshield Glass	AM82000296	\$ 185.00	
	5120, 5130, 5140, 5150, 5220, 5230, 5240, 5250	Lower Front Glass, Right Hand Replaces 1330877C1	AM248717A1	\$ 74.00	
		Lower Front Glass, Left Hand Replaces 1330876C1	AM248716A1	\$ 85.00	
	CX50, CX60, CX70, CX80, CX90, CX100, MX80C, MX90C, MX100, MX100C, MX110, MX120, MX135, MX150, MX170	Lower Front Glass, Right Hand Replaces 190029A4	AM190029A5	\$ 95.00	
		Lower Front Glass, Left Hand Replaces 190030A4	AM190030A5	\$ 78.79	
	MXM120, MXM130, MXM140, MXM155, MXM175, MXM190	Lower Front Glass, Right Hand	AM82001924	\$ 60.00	
		Lower Front Glass, Left Hand	AM82001923	\$ 60.00	
	MXU100, MXU110, MXU115, MXU125, MXU130, MXU135, Maxxum®: 100, 110, 115, 120, 125, 130, 140	Lower Front Glass, Right Hand Replaces 82030487	AM87566891	\$ 128.00	
		Lower Front Glass, Left Hand Replaces 82030488	AM87566892	\$ 114.00	
	MXU100, MXU110, MXU115, MXU125, MXU130, MXU135, Maxxum®: 100, 110, 115, 120, 125, 130, 140, Puma®: 115, 125, 130, 140, 145, 155, 160, 200, 215, 230	Lower Front Glass, Right Hand Replaces 82030485	AM87304259	\$ 91.00	
		Lower Front Glass, Left Hand Replaces 82030486	AM87304261	\$ 118.00	
	MX210, MX215, MX245, MX255, MX275, MX285, MX305, Magnum®: 180, 190, 210, 215, 220, 225, 235, 240, 245, 250, 255, 260, 275, 280, 290, 305, 310, 315, 335, 340, 370, 380	Cab Glass, Right Hand Replaces 242536A5, 87773671	AM87417671	\$ 595.00	
	5120, 5130, 5140, 5150, 5220, 5230, 5240, 5250	Side Glass, Right Hand Replaces 1330903C1	AM248719A1	\$ 145.00	
		Side Glass, Left Hand Replaces 1330902C1	AM248718A1	\$ 117.05	
	7110, 7120, 7130, 7140, 7150, 7210, 7220, 7230, 7240, 7250, 8910, 8920, 8930, 8940, 8950	Side Glass, Right Hand Tinted	AM96671C3	\$ 115.00	







Case IH®—Tractor

	Application	Description	Part Number	Retail Price	Core
	7110, 7120, 7130, 7140, 7150, 7210, 7220, 7230, 7240, 7250, 8910, 8920, 8930, 8940, 8950	Side Glass, Left Hand	AM1340200C1	\$ 137.22	
	MXM120, MXM130, MXM140, MXM155, MXM175, MXM190	Side Glass, Right Hand	AM82029320	\$ 117.32	
		Side Glass, Left Hand	AM82029321	\$ 128.67	
	MXM120, MXM130, MXM140, MXM155, MXM175, MXM190	Side Glass, Right Hand Replaces 82009812, 82029320	AM83995321	\$ 118.00	
		Side Glass, Left Hand Replaces 82009813, 82029321	AM83995322	\$ 110.00	
	Maxxum®: 100, 110, 115, 120, 125, 130, 135, 140, 145, 150	Door Glass, Right Hand Replaces 82027356, 87528172	AM84280178	\$ 480.00	
	7110, 7120, 7130, 7140, 7150, 7210, 7220, 7230, 7240, 7250, 8910, 8920, 8930, 8940, 8950	Door Glass, Left Hand	AM1340194C1	\$ 120.00	
	CX50, CX60, CX70, CX80, CX90, CX100, MX80C, MX90C, MX100, MX100C, MX110, MX120, MX135, MX150, MX170	Door Glass, Right Hand Replaces 192004A4, 192004A5	AM192004A6	\$ 225.00	
		Door Glass, Left Hand	AM192003A5	\$ 265.00	
	JX55, JX60, JX65, JX70, JX75, JX80, JX85, JX90, JX95, Farmall®: 90, 95	Door Glass, Right Hand	AM87620223	\$ 320.34	
		Door Glass, Left Hand	AM87620234	\$ 320.34	
	MX215, MX245, MX275, MX305, Magnum®: 180, 190, 200, 215, 220, 225, 235, 240, 250, 255, 260, 275, 280, 290, 305, 310, 315, 335, 340, 370, 380	Door Glass, Left Hand	AM344730A2	\$ 325.00	
	MXM120, MXM130, MXM140, MXM155, MXM175, MXM190	Door Glass, Right Hand	AM82036000	\$ 292.42	
		Door Glass, Left Hand	AM82036001	\$ 230.00	
	MXU100, MXU110, MXU115, MXU125, MXU130, MXU135	Door Glass, Left Hand Replaces 82027357, 87560786	AM87528171	\$ 410.00	
	(5120, 5130, 5140, 5220, 5230, 5240, 5250 BSN JJF1020099)	Upper Door Glass, Right Hand Replaces 1330930C1	AM1330930C2	\$ 323.08	
		Upper Door Glass, Left Hand Replaces 1330931C1	AM1330931C2	\$ 285.00	

Case IH®—Tractor

	Application	Description	Part Number	Retail Price	Core
	(5120, 5130, 5140, 5150, 5220, 5230, 5240, 5250 ASN JJF1020700)	Upper Door Glass, Right Hand Replaces 1546817C1, 1546817C2	AM248723A1	\$ 350.00	
		Upper Door Glass, Left Hand Replaces 1546818C1, 1546818C2	AM248724A1	\$ 355.00	
	5120, 5130, 5140, 5150, 5220, 5230, 5240, 5250	Lower Door Glass, Right Hand Replaces 1999626C1, 1999626C2	AM248726A1	\$ 75.00	
		Lower Door Glass, Left Hand Replaces 1999625C1, 1999625C2	AM248725A1	\$ 85.00	
	7110, 7120, 7130, 7140, 7150	Rear Glass Tinted	AM1340198C1	\$ 97.99	
	7210, 7220, 7230, 7240, 7250	Rear Glass	AM232329A1	\$ 125.00	
	8910, 8920, 8930, 8940, 8950	Rear Glass	AM240875A1	\$ 80.00	
	CX50, CX60, CX70, CX80, CX90, CX100, MX80C, MX90C, MX100, MX100C, MX110, MX120, MX135, MX150, MX170	Rear Glass, Right Hand Replaces 192002A2	AM192002A3	\$ 55.53	
		Rear Glass, Left Hand Replaces 192001A2	AM192001A3	\$ 58.23	
	MX215, MX245, MX275, MX305, Magnum®: 180, 190, 200, 210, 215, 220, 225, 235, 240, 250, 255, 260, 275, 280, 290, 310, 315, 335, 340, 370, 380, Patriot® Sprayers: 3230, 3240, 3330, SPX3320	Rear Glass Tinted Replaces 242667A4	AM87309738	\$ 315.00	
	MXU100, MXU110, MXU115, MXU125, MXU130 MXU135, Maxxum®: 100, 110, 115, 120, 125, 130, 135, 140, 145, 150, Puma®: 115, 125, 130, 140, 145, 150, 155, 160, 165, 170, 180, 185, 195, 200, 210, 215, 220, 225, 230, 240	Rear Glass Replaces 82030887, 87663400	AM87744542	\$ 250.00	
	5120, 5130, 5140, 5150, 5220, 5230, 5240, 5250	Upper Rear Glass Replaces 1330904C1	AM1330904C2	\$ 238.46	
	5120, 5130, 5140, 5150, 5220, 5230, 5240, 5250	Upper Rear Glass Replaces 127442A1	AM248720A1	\$ 275.00	
	JX70U, JX80U, JX90U, JX100U, JX1080U, JX1090U, JX1100U, Farmall®: 85U, 95U, 105U	Upper Rear Glass Replaces 5178304, 82005316, VPM7343	AM82016997	\$ 150.00	
	CX50, CX60, CX70, CX80, CX90, CX100, MX80C, MX90C, MX100, MX100C, MX110, MX120, MX135, MX150, MX170	Upper Rear Glass Replaces 284947A1	AM284947A2	\$ 145.00	
	MXM120, MXM130, MXM140, MXM155, MXM175, MXM190	Upper Rear Glass	AM82014988	\$ 145.00	
	5120, 5130, 5140, 5150, 5220, 5230, 5240, 5250	Lower Rear Glass	AM1981934C1	\$ 75.00	

Case IH®—Tractor

Application	Description	Part Number	Retail Price	Core
 JX70U, JX80U, JX90U, JX100U, JX1070U, JX1080U, JX1090U, JX1100U, MXM120, MXM130, MXM140, MXM155, MXM175, MXM190, Farmall®: 85U, 95U, 105U	Lower Rear Glass	AM82000485	\$ 27.00	
 7110, 7120, 7130, 7140, 7150, 7210, 7220, 7230, 7240, 7250, 8910, 8920, 8930, 8940, 8950	Weatherstrip For Lower Front Cab Windshield, Right or Left Hand Replaces 1981771C1, 1276394C2	AM1981771C2	\$ 10.00	
 7110, 7130, 7140, 7150, 7210, 7220, 7230, 7240, 7250, 8910, 8920, 8930, 8940, 8950	Weatherstrip For Cab Window, Right Hand	AM1987247C2	\$ 26.56	
 7110, 7120, 7130, 7140, 7150, 7210, 7220, 7230, 7240, 7250, 8910, 8920, 8930, 8940, 8950	Weatherstrip 176" Long For Cab Door	AM1990761C2	\$ 29.63	
(MX215, MX245 ASN Z8RZ08527), (MX275, MX305 ASN Z8RZ08528), Magnum®: 180, 190, 200, 210, (215, 245, 275, 305, 335 ASN Z8RZ08527), 220, 225, 235, 240, 250, 260, 280, 290, 310, 315, 340, 370, 380	Weatherstrip For Cab Door	AM84160023	\$ 23.10	
 MX180, MX200, MX210, (MX215, MX245, MX275, MX305 BSN Z8RZ0852), MX220, MX230, MX240, MX255, MX270, MX285, Magnum®: (215, 245, 275, 305, 335 BSN Z8RZ0852)	Weatherstrip For Cab Door	AM87534532	\$ 23.10	
 7110, 7120, 7130, 7140, 7150	Weatherstrip For Rear Cab Window	AM1990790C1	\$ 32.00	
8910, 8920, 8930, 8940, 8950	Weatherstrip For Rear Cab Window	AM240876A1	\$ 35.33	
MX180, MX200, MX210, MX215, MX220, MX230, MX240, MX245, MX255, MX270, MX275, MX285, MX305, Magnum®: 180, 190, 200, 210, 215, 220, 225, 235, 240, 245, 250, 255, 260, 275, 280, 290, 305, 310, 315, 335, 340, 370, 380	Weatherstrip For Rear Cab Window	AM87534532	\$ 23.10	

Gas Struts



Application	Description	Part Number	Retail Price	Core
Magnum®: 235, 250, 260, 280, 290, 310, 315, 340, 370, 380	Gas Strut, Hood	AM84286709	\$ 40.00	
5120, 5220	Gas Strut, Hood Replaces T103262	AM1531489C1	\$ 20.00	
5130, 5140, 5230, 5240, 5250	Gas Strut, Hood Replaces T103183	AM1531490C1	\$ 12.00	
7110, 7120, 7130, 7140, 7150, 7210, 7220, 7230, 7240, 7250, 8910, 8920, 8930, 8940, 8950	Gas Strut, Hood Replaces 1968168C2	AM1968168C3	\$ 19.00	
CX70, CX80, CX90, CX100, MX80, MX90, MX100	Gas Strut, Hood Replaces 299233A1	AM338193A1	\$ 40.00	
JX55, JX65, JX75, JX85, JX95	Gas Strut, Hood	AM5097656	\$ 39.36	
MX180, MX200, MX210, MX220, MX230, MX240, MX255, MX270, MX285	Gas Strut, Hood	AM252636A1	\$ 19.00	
MX215, MX245, MX275, MX305, Magnum®: 215, 245, 255, 275, 305, 335	Gas Strut, Hood	AM87386500	\$ 57.50	
MXM120, MXM130, MXM140, MXM155	Gas Strut, Hood Replaces 82007029	AM82019392	\$ 25.00	







Prices Subject to Change without Prior Notice. The use of original equipment manufacturer (OEM) part numbers or trademarks, e.g. Case® and John Deere®, are for reference purposes only and for indicating product use and compatibility. Our company and the listed replacement parts contained herein are not sponsored, approved or manufactured by the OEM. All parts are New unless designated Reman in the description.

Case IH®—Tractor









Application	Description	Part Number	Retail Price	Core
5220, 5230, 5240, 5250	Gas Strut, Hood Latch	AM108157A1	\$ 15.00	
485, 495, 585, 595, 685, 895, 995, 3220, 3230, 4210, 4230, 4240, 5120, 5130, 5140, CX70, CX80, CX90, CX100, MX100, MX110, MX120, MX135	Gas Strut, Roof Hatch Replaces 3399422R1, 3399422R2, 1987021C2, 1987021C1, J3036997	AM3399422R3	\$ 19.00	
MXM120, MXM130, MXM135, MXM140, MXM150, MXM155, MXM165, MXM175, MXM180, MXM190, JX70U, JX80U, JX90U, JX100U, JX1070U, JX1080U, JX1090U, JX1100U	Gas Strut, Roof Hatch	AM82002925	\$ 19.00	
5120, 5130, 5140, 5220, 5230, 5240, 5250, CX50, CX60, CX70, CX70, CX80, CX90, CX100, MX80, MX80C, MX90, MX90C, MX100, MX110, MX120, MX135, MX150, MX170	Gas Strut, Door	AM1977416C1	\$ 19.00	
7110, 7120, 7130, 7140, 7150, 7210, 7220, 7230, 7240, 7250, 8910, 8920, 8930, 8940, 8950, (9110, 9130, 9150, 9170, 9180 ASN JCB0003600), 9210, 9230, (9240, 9250, 9260 BSN JEE0033501 w/ Return Spring or Stop Bolt Latch LEV), (9240, 9250, 9260 ASN JEE0033501 w/ Angle Latch, Actuating), (9270, 9280 ASN JCB0027096 w/ Powershift or Synchroshift), 9310, 9330, 9350, 9370, 9380, 9390, MX180, MX200, MX210, MX215, MX220, MX230, MX240, MX245, MX255, MX270, MX275, MX285, MX305, Magnum®: 215, 245, 255, 275	Gas Strut, Door	AM1280263C1	\$ 19.00	
(JX55, JX60, JX65, JX70, JX75, JX80, JX85, JX90, JX95 ASN D5656)	Gas Strut, Door Replaces 87652519	AM84168525	\$ 19.00	
MXM120, MXM130, MXM135, MXM140, MXM150, MXM155, MXM165, MXM175, MXM180, MXM190	Gas Strut, Door	AM82027922	\$ 19.00	
CX50, CX60, CX70, CX80, CX90, CX100, MX80, MX80C, MX90, MX90C, MX100, MX100C, MX110, MX120, MX135, MX150, MX170	Gas Strut, Front and Rear Window	AM189447A2	\$ 19.00	
5120, 5130, 5140, 5220, 5230, 5240, 5250	Gas Strut, Rear Window Replaces 1971235C1	AM1971235C2	\$ 19.00	
(7110, 7120, 7130, 7140, 7150 BSN JJA0044634)	Gas Strut, Rear Window	AM96817C1	\$ 32.00	
(7110, 7120, 7130, 7140, 7150 ASN JJA0044634), 7210, 7220, 7230, 7240, 7250, 8910, 8920, 8930, 8940, 8950	Gas Strut, Rear Window	AM1343825C1	\$ 19.00	
DX40, DX45, DX55, DX60, Farmall®: 40, 45, 55, 60	Gas Strut, Rear Window	AM84320293	\$ 19.00	
MX180, MX200, MX210, MX220, MX230, MX240, MX255, MX270, MX285, Magnum®: 215, 245, 255, 275	Gas Strut, Rear Window	AM252550A2	\$ 28.00	
MXM120, MXM130, MXM140, MXM155, MXM175, MXM190 Replaces 81865239	Gas Strut, Rear Window	AM82019393	\$ 19.00	
MXU100, MXU110, MXU115, MXU125, MXU130, MXU135, Puma®: 115, 125, 140, 155, 165, 180, 195, 210, 225	Gas Strut, Rear Window	AM82022486	\$ 19.00	
585, 595, 685, 695, 885, 895, 995, 3220, 3230, 4210, 4230, 4240, 5120, 5130, 5140, 5220, 5230, 5240, 5250, 7110, 7120, 7130, 7140, 7150, 7210, 7220, 7230, 7240, 7250, 8910, 8920, 8930, 8940, 8950, (9110, 9130, 9150, 9170, 9180 ASN JCB0003599), 9210, 9230, 9240, 9250, 9260, 9270, 9280, 9310, 9330, 9350, 9370, 9380, 9390, CX50, CX60, CX70, CX80, CX90, CX100, MX80C, MX90C, MX100, MX100C, MX110, MX120, MX135, MX150, MX170, MX180, MX200, MX210, MX215, MX220, MX230, MX240, MX245, MX255, MX270, MX285, MX305, Magnum®: 215, 245, 255, 275, 305, 335, Steiger® Quadtrac®: 280, 330, 335, 380, 385, 430, 435, 480, 485, 530, 535, STX275, STX280, STX325, STX330, STX375, STX380, STX425, STX430, STX440, STX450, STX480, STX500, STX530	Stud, Door Gas Strut Replaces 142597A1	AM3234063R1	\$ 7.00	

Case IH®—Tractor

Air Conditioning and Components

Application	Description	Part Number	Retail Price
 <p>Farmall®: 60 Tier 3, (65C, 75C, 85C, 105N Non Tier 4), 70, 75N, 80, 85N, 85U, 90, 95, 95C, 95N, 95U, 105U, 105V</p>	Compressor, Sanden SD7H15 12 Volt, w/ 4-Groove Serpentine Clutch, 4.409" (112 mm) Clutch Diameter Requires Pag Oil 100V, 6.46 oz (190 cc)	AM87519620	\$ 275.00
	Ultra Pag Double End Capped, 100V, 8 oz	AMX10267	\$ 12.00
	Universal Pag Oil, 8 oz	AMX10274	\$ 8.25
 <p>245, 255, 275, 385, 435, 485, 535, MX210, MX215, MX230, MX245, MX255, MX275, MX285, MX305, STX375, STX380, STX425, STX430, STX440, STX450, STX480, STX500, STX530, Magnum®: 215, 245, 255, 275, 305, 335, 4WD: 380, 430, 480, 530 Replaces 317008A2, 317008A3, 86992688, 87775469, 504078610</p>	Compressor, Sanden SD7H15HD 12 Volt, w/ 8-Groove Clutch, 5.98" (152 mm) Clutch Diameter, Horizontal Tube O-Ring, Direct Mount Requires Pag Oil 100V, 9.64 oz (285 cc)	AM86993463	\$ 275.00
	Ultra Pag Double End Capped, 100V, 8 oz	AMX10267	\$ 12.00
	Universal Pag Oil, 8 oz	AMX10274	\$ 8.25
 <p>5120*, 5130*, 5140*, 5220*, 5230*, 5240*, 5250*, 7110*, 7120*, 7130*, 7140*, 7150*, 7210, 7220, 7230, 7240, 7250, 8870, 8910, 8920, 8930, 8940, 8950, (9210, 9230, 9240, 9250, 9260, 9270, 9280 ASN JEE0031850), 9310, 9330, 9350, 9370, 9380, 9390, C70, C80, C90, C100, CS100, CS110, CS120, CS130, CS150, CVX1135, CVX1145, CVX1155, CVX1170, CVX1190, CVX1195, CX50, CX60, CX70, CX80, CX90, CX100, MX80C, MX90C, MX100, MX100C, MX110, MX120, MX135, MX150, MX170, MX180, MX200, MX220, MX240, MX270, STX275, STX280, STX325, Magnum®: 190, 210, 225, 250, 280, 310, Quadtrac® *Optional R134a Compressor Replaces 1977959C1, 1999755C2, 1999755C3, 86993462</p>	Compressor, Sanden SD7H15 12 Volt, w/ 2-Groove Clutch, 6" Clutch Diameter, Horizontal Tube O-Ring Requires Synthetic Ester Oil 100V, 9.60 oz (285 cc)	AMX10125	\$ 240.00
	Premium Synthetic Ester Oil, 100V, 12 oz	AMX10273	\$ 11.00
 <p>9110, 9130, 9140, 9170, 9180, 9190, (9210, 9230, 9240, 9250, 9260, 9270, 9280 BSN JEE0031849) Replaces 60-2921T91, 60-2921T94, K303739, K307237</p>	Compressor, Sanden SD510HD Style 12 Volt, w/ 2-Groove Clutch, 5.19" (132 mm) Clutch Diameter, Vertical #8 and #10 Flare Fittings, w/ R12 Charge Ports Requires Pag Oil 100V, 4.56 oz (135 cc)	AMX10126	\$ 200.00
	Ultra Pag Double End Capped, 100V, 8 oz	AMX10267	\$ 12.00
	Universal Pag Oil, 8 oz	AMX10274	\$ 8.25
 <p>JX55, JX60, JX65, JX70, JX70U, JX80, JX80U, JX85, JX90, JX90U, JX95, JX100U, JX1080U, JX1085U, JX1090U, JX1095C</p>	Compressor, Sanden 12 Volt, w/ 2-Groove Clutch, 5.25" (133 mm) Clutch Diameter, Vertical Tube O-Ring, w/o Charge Ports Requires Synthetic Ester Oil 100V, 8.11 oz (240 cc)	AMX10130	\$ 365.00
	Premium Synthetic Ester Oil, 100V, 12 oz	AMX10273	\$ 11.00
 <p>MXM120, MXM130, MXM140, MXM155, MXM175, MXM190 Replaces 82008689, 82002069</p>	Compressor, Sanden SD7H15 Style 12 Volt, w/ 8-Groove Clutch for Serpentine Belt, 4.68" (119 mm) Clutch Diameter, Vertical #8 and #10 O-Ring Requires Synthetic Ester Oil 100V, 4.56 oz (135 cc)	AM82016158	\$ 265.00
	Premium Synthetic Ester Oil, 100V, 12 oz	AMX10273	\$ 11.00
 <p>MXU100, MXU110, MXU115, MXU125, MXU130, MXU135, Maxxum®: 100, 110, 115, 120, 125, 130, 140, Puma®: 115, 125, 140, 155 Replaces 87709785</p>	Compressor, Sanden SD7H15 Style 12 Volt, w/ 4-Groove Clutch for Serpentine Belt, 4.409" (112 mm) Clutch Diameter, 2-Wire, WV Head, Direct Mount Requires Synthetic Ester Oil 100V, See Manufacturer for Oil Quantity	AM87802912	\$ 265.00
	Premium Synthetic Ester Oil, 100V, 12 oz	AMX10273	\$ 11.00









Case IH®—Tractor

	Application	Description	Part Number	Retail Price
	Steiger®: Bearcat, CM IV, Cougar, KM IV, Panther, PT/PTA, SM IV, ST III, Tiger, Super Wildcat, Wildcat III, Ind: CA Series, CU Series	Compressor, Sanden SD508 Style 12 Volt, w/ 2-Groove Clutch, 5.19" (132 mm) Clutch Diameter, Vertical #8 and #10 Flare Fittings, w/ R12 Charge Ports Requires R12 Mineral Oil, 5.91 oz (175 cc)	AMX10178	\$ 255.00
	Steiger®: Bearcat, Wildcat, Super Wildcat	Compressor, York Style Left Hand Suction, Rotolock Clutch Not Included Requires Synthetic Ester Oil 100V, See Manufacturer for Oil Quantity Double Groove Clutch for York Compressor, 7" Premium Synthetic Ester Oil, 100V, 12 oz	AMX10225 AM470 AMX10273	\$ 260.00 \$ 101.00 \$ 11.00
	3220, 3230, 4210, 4240, 5120, 5130, 5140, 5220, 5230, 5240, 5250, 7210, 7220, 7230, 7240, 7250, 8910, 8920, 8930, 8940, 8950, 9210, 9230, 9240, 9250, 9260, 9270, 9280, 9310, 9330, 9350, 9370, 9380, 9390, C70, C80, C90, C100, CX50, CX60, CX70, CX80, CX90, CX100, MX80C, MX90C, MX100, MX110, MX120, MX135, MX150, MX170, MX180, MX200, MX220, MX240, MX270, STX275, STX325 Replaces 135324A1, 47108807, 47110444, 700713455	Compressor Clutch SD7H15 Clutch w/ 12 Volt Coil, 2-Groove, 5.98" Clutch Diameter, 0.47" Groove Width Use w/ AMX10125 Compressor	AM135324A2	\$ 120.00
	MX210, MX215, MX230, MX245, MX255, MX275, MX285, MX305, STX380, STX430, STX480, STX530, Magnum®: 215, 245, 250, 255, 275, 280, 305, 310, 335, 340, 380, Steiger®: 350, 380, 400, 450, 480, 500, 530	Compressor Clutch SD7H15 Clutch w/ 12 Volt Coil, 8-Groove, 5.98" (152 mm) Clutch Diameter, Key-Type Hub Replaces 8775538	AM403585A1	\$ 132.00
	MXM120, MXM130, MXM140, MXM155, MXM175, MXM190	Compressor Clutch SD7H15 Clutch w/ 12 Volt Coil, 8-Groove, 4.68" (119 mm) Clutch Diameter, 3.56 mm Groove Width, Key-Type Hub, Dust Cover Not Included Replaces 82025343	AM87334399	\$ 180.00
	MXU100, MXU110, MXU115, MXU125, MXU130, MXU135, Maxxum®: 100, 110, 115, 120, 125, 130, 140, Puma®: 115, 125, 140, 155	Compressor Clutch SD7H15 Clutch w/ 12 Volt Coil, 4-Groove, 4.41" (112 mm) Clutch Diameter, Key-Type Hub	AM87334407	\$ 175.00
	Universal Equipment	Low Pressure Switch Normally Open, Opens at 6 PSI, Closes at 45 PSI, Standard 7/16"x20 Thread	AMX10277	\$ 55.00
	Universal Equipment	Low Pressure Switch Normally Open, Opens at 35 PSI, Closes at 46 PSI, Standard 7/16"x20 Thread	AMX10278	\$ 42.00
	Magnum®: 180, 200, 220, 235, 240, 250, 260, 280, 290, 310, 315, 340, 370, 380, Maxxum®: 110, 115, 120, 125, 130, 135, 140, 145, 150, Puma®: 125, 130, 140, 145, 150, 155, 160, 165, 170, 185, 200, 215, 220, 230, 240, Quadtrac® Tractors: 370, 420, 450, 470, 500, 540, 580, 600, 620, Steiger®: 370, 420, 470, 500, 540, 550, 580, 600, 620	Low Pressure Switch Normally Open, Opens at 20 PSI, Closes at 7 PSI, 10 mm Metric Thread	AM84419250	\$ 65.20
	Backhoe-Loaders: 580L, 580M, 580SK, 580SL, 580SM, 590L, 590SL, 590SM, Loaders: 521D, 621B, 621D, 621E, 621F, 721B, 721D, 721E, 721F, 821B, 821C, 821F, 921, 921B, 921C, 921F, 1021F, 1121F	Low Pressure Switch Normally Closed, Opens at 23 PSI, Closes at 7 PSI, 10 mm Metric Thread	AM122579A1	\$ 44.00
	Universal Equipment	High Pressure Switch Normally Open, Opens at 305 PSI, Closes at 395 PSI, 7/16"x20 Thread	AMX10276	\$ 35.00

Case IH®—Tractor

Application	Description	Part Number	Retail Price
 <p>Backhoe-Loaders: 580L, 580M, 580N, 580SL, 580SM, 580SN, 590L, 590SL, 590SM, 590SN, Loaders: 521D, 521F, 621B, 621C, 621D, 621E, 621F, 721B, 721C, 721D, 721E, 721F, 821B, 821C, 821F, 921B, 921C, 921F, 1021F, 1121F, Crawlers: 650G, 650H, 750H, 850G, 850H, 1050H, 1150G</p>	<p>High Pressure Switch Normally Open, Opens at 275 PSI, Closes at 330 PSI, 10 mm Metric Thread Replaces 544975C1, 1651985C1, AG262906</p>	AM232948A1	\$ 37.00
 <p>MXU100, MXU110, MXU115, MXU125, MXU130, MXU135, Maxxum®: 100, 110, 115, 120, 125, 130, 140, Optum™: (270, 300 - w/ CVT), Puma®: 115, 125, 130, 140, 145, 150, 155, 160, 165, 170, 180, 185, 195, 200, 210, 215, 220, 225, 230, 240</p>	<p>Trinary Switch 7/16"x20 Female Thread Replaces 82019426, 87699591</p>	AM84233818	\$ 56.00
 <p>3220, 3230, 4210, 4230, 4240, 5120, 5130, 5140, 5220, 5230, 5240, 5250, 7110, 7120, 7130, 7140, 7150, 7210, 7220, 7230, 7240, 7250, 8910, 8920, 8930, 8940, 8950, 9310, 9330, 9350, 9370, 9380, 9390, CX50, CX60, CX70, CX80, CX90, CX100, MX80C, MX90C, MX100, MX110, MX120, MX135, MX150, MX170, MX180, MX200, MX210, MX220, MX230, MX240, MX255, MX270, MX285, Quadtrac® Replaces 143469C2, 1990758C2</p>	<p>Receiver Drier 4" x 7 3/4", Inlet - #6, 3/8" Male O-Ring, Outlet - #6, 3/8" Female O-Ring, Front Mount, R12 and R134a Compatible</p>	AMX10161	\$ 30.00
 <p>9110, 9130, 9150, 9170, 9180, 9210, 9230, 9240, 9250, 9260, 9270, 9280, Steiger®: Bearcat 1000, Cougar, Cougar 1000, CS Series IV, Lion 1000, Panther 1000, PT, PTA, Puma 1000, ST Series III, Tiger III & IV, Wildcat 1000 Replaces 60-5818T3</p>	<p>Receiver Drier 3" x 9 1/2" Male Flare, Male Switch Port, R12 and R134a Compatible</p>	AMX10210	\$ 32.00
 <p>JX55, JX60, JX65, JX70, JX70U, JX75, JX80, JX80U, JX85, JX90, JX90U, JX95, JX100U, JX1060C, JX1070C, JX1075C, JX1080U, JX1085C, JX1090U, JX1095C, JX1100U, Farmall®: 70, 85U, 90, 95, 95U, 105U</p>	<p>Receiver Drier w/o High Pressure Switch</p>	AM5165615	\$ 38.00
 <p>MX215, MX245, MX275, MX305, STX275, STX280, STX325, STX330, STX375, STX380, STX425, STX430, STX440, STX450, STX480, STX500, STX530, Magnum®: 180, 190, 210, 215, 225, 245, 250, 255, 275, 280, 305, 310, 335, Steiger®: 280, 330, 335, 380, 385, 430, 435, 480, 485, 530, 535 Replaces 295006A1</p>	<p>Receiver Drier Receiver Drier, Import 4" x 7 1/2", Inlet - #6 Female O-Ring, Outlet - #6 Male O-Ring, R12 and R134a Compatible</p>	AMX10154 AMX10208	\$ 25.00 \$ 22.00
 <p>MXM120, MXM130, MXM140, MXM155, MXM175, MXM190, MXU100, MXU100X, MXU115, MXU125, MXU130, MXU135, MXV100, MXV110, DX40, DX55, Maxxum®: 100, 110, 115, 120, 125, 130, 140, Puma®: 115, 125, 140, 155, 165, 180, 195, 210, 225 Replaces 82023593</p>	<p>Receiver Drier 2 1/2" x 6" Male and Female O-Ring, R12 and R134a Compatible</p>	AMX10214	\$ 33.00

Case IH®—Tractor















	Application	Description	Part Number	Retail Price
	3220, 3230, 4210, 4230, 4240, 5120, 5130, 5140, 5220, 5230, 5240, 5250, 7110, 7120, 7130, 7140, 7150, 7210, 7220, 7230, 7240, 7250, 8910, 8920, 8930, 8940, 8950, 9110, 9130, 9150, 9170, 9180, 9210, 9230, 9240, 9250, 9260, 9270, 9280, 9310, 9330, 9350, 9370, 9380, 9390, CX50, CX60, CX70, CS80, CX90, CX100, MX80C, MX90C, MX100, MX100C, MX110, MX120, MX135, MX150, MX170, MX180, MX200, MX210, MX215, MX220, MX230, MX240, MX245, MX255, MX270, MX275, MX285, MX305, Magnum®: 180, 190, 210, 215, 225, 245, 250, 255, 275, 280, 305, 310, 335, Quadtrac®, STX275, STX280, STX325, STX330, STX375, STX380, STX425, STX430, STX440, STX450, STX480, STX500, STX530, Steiger®: 280, 330, 335, 380, 385, 430, 435, 480, 485, 530, 535, Bearcat, Cougar, Lion, Panther, Wildcat Replaces 386535A1, 1990756C2	Expansion Valve Block Type, R12 and R134a Compatible, O-Ring Connection	AMX10150	\$ 26.00
	919, Steiger: Tiger, Wildcat, PT/PTA, Cougar, Panther, Bearcat, Super Wildcat Replaces 01-7844	Expansion Valve Internally Regulated w/ 12" Capacity Tube w/ Flare Connection, R12 and R134a Compatible	AMX10215	\$ 30.00
	CS100, CS110, CS120, CS130, CS150, CVX1135, CVX1145, CVX1155, CVX1170, CVX1190, CVX1195 Replaces 118321C1, 4322165	Expansion Valve Block Type, R12 and R134a Compatible, O-Ring Connection	AMX10151	\$ 24.00
	JX55, JX60, JX65, JX70, JX75, JX80, JX85, JX90, JX95, MXM120, MXM130, MXM140, MXM155, MXM175, MXM190, Farmall®: 60, 70, 80, 90, 95, 110A, 120A, 125A, 140A	Expansion Valve	AM82034858	\$ 50.00
	JX70U, JX80U, JX90U, JX100U, JX1060C, JX1070C, JX1070U, JX1075C, JX1080U, JX1085C, JX1090U, JX1095C, JX1100U, JXU75, JXU85, JXU95, JXU105	Expansion Valve Flange Type, O-Ring Connection, R12 and R134a Compatible	AMX10260	\$ 25.00
	MXU100, MXU110, MXU115, MXU125, MXU130, MXU135, Farmall®: 40, 40B, 45, 45B, 45C, 50, 50B, 50C, 55, 60, Maxxum®: 110, 115, 120, 125, 130, 135, 140, 145, 150, Puma®: 115, 125, 130, 140, 145, 150, 155, 160, 165, 170, 180, 185, 195, 200, 210, 215, 220, 225, 230, 240	Expansion Valve Flange Type, O-Ring Connection	AM82023542	\$ 45.00
	(5120, 5130, 5140, 5220, 5230, 5240, 5250 BSN JJF1034500)	Compressor to Condenser Hose	AMX10284	\$ 55.00
	7110, 7120, 7130, 7140, 7150	Return Line Suction Hose	AM98108C2	\$ 106.27
	4210, 4230, 4240, 5120, 5130, 5140, 5220, 5230, 5240, 5250, 7110, 7120, 7130, 7140, 7150, 7210, 7220, 7230, 7240, 7250, 8910, 8920, 8930, 8940, 8950, (9210, 9230, 9240, 9250, 9260, 9270, 9280 ASN JCB0028400), 9310, 9330, 9350, 9370, 9380, 9390, Quadtrac® Replaces 1340492C1, 1340492C2, 1340492C3, 1535284C1, 1977564C2, 1974779C1, 355189A1, 335190A1	Blower Motor Assembly w/o Resistor 12 Volt, Includes Wiring Harness	AMX10121	\$ 180.00

Case IH®—Tractor











	Application	Description	Part Number	Retail Price
	245, 255, 275, MX180, MX200, MX210, MX215, MX220, MX230, MX240, MX245	Blower Motor Assembly Replaces 330137A1	AM87107380	\$ 125.00
	CX50, CX60, CX70, CX80, CX90, CX100, MX80C, MX90C, MX100C	Blower Motor Assembly 12 Volt, Heavy Duty High Output, Increased Air Flow	AM372499A1	\$ 180.00
	CX50, CX60, CX70, CX80, CX90, CX100, MX80C, MX90C, MX100, MX100C, MX110, MX120, MX135, MX150, MX170	Blower Motor Assembly 12 Volt, Resistor and Wiring Harness Not Included	AM178454A2	\$ 160.00
	MX180, MX200, MX210, MX215, MX220, MX230, MX240, MX245, MX255, MX270, MX275, MX285, MX305, STX275, STX280, STX325, STX330, STX375, STX440, Magnum®: 215, 245, 255, 275, 305, 335	Blower Motor Assembly 12 Volt, Resistor Not Included Replaces 323610A1	AM84222524	\$ 150.00
	Magnum®: 215, 245, 255, 275, 305, 335	Blower Motor Resistor	AM401360A1	\$ 50.00
	MX215, MXU100, MXU110, MXU115, MXU125, MXU130, MXU135, Maxxum®: 100, 110, 115, 120, 125, 130, 135, 140, 145, 150, Magnum®: 225, 235, 250, 260, 280, 290, 310, 315, 335, 340, 370, 380, Puma®: 115, 125, 130, 140, 145, 155, 160, 165, 170, 180, 185, 195, 200, 210, Quadtrac®: 370, 400, 450, 470, 500, 540, 550, 580, 600, 620	Blower Motor Assembly 12 Volt Replaces 87663947, 87663956	AM87663955	\$ 155.00
	(8270, 9280 ASN JEE0031850), 9310, 9330, 9350, 9370, 9380, 9390 Replaces 60-6851T1	Blower Motor 12 Volt, Single Speed, Single Shaft, 2-Wire, Reversible, 5/16" Shaft Diameter, 1" Long	AMX10108	\$ 85.00
	9110, 9130, 9150, 9170, 9180, (9210, 9230, 9240, 9250, 9260, 9270, 9280 BSN JEE0031849) Replaces 60-5613T2	Blower Motor 12 Volt, Single Speed, Double Shaft, 2-Wire, Reversible, 3/8" Shaft Diameter, 3" and 4 1/4" Long	AMX10117	\$ 105.00
	9190 ASN 131-00213 Replaces 60-2564T1	Blower Motor Single Speed, Double Shaft, 2-Wire, Reversible, 5/16" Shaft Diameter, 1/8" Long	AMX10114	\$ 145.00
	JX55, JX60, JX65, JX70, JX75, JX80, JX85, JX90, JX95, MXM120, MXM130, MXM140, MXM155, MXM175, MXM190 Replaces 81870361	Blower Motor Double Shaft, 2-Wire, 5/16" Shaft Diameter, 2 1/4" and 2 1/2" Long	AMX10115	\$ 100.00
	MXM120, MXM130, MXM140, MXM155, MXM175, MXM190 Replaces 81870361	Blower Motor, 12 Volt Single Speed, Reversible, 2-Wire, Single Shaft, 1 1/2" Shaft Length, 5/16" Diameter, 6" Overall Length, 3" Overall Diameter	AMX10123	\$ 80.00
	CX50, CX60, CX70, CX75, CX80, CX85, CX90, CX95, CX100, DX60, MX80C, MX90C, MX100, MX100C, MX110, MX120, MX135, MX150, MX170, Farmall®: 40, 45, 50, 55, 60	Blower Motor Switch 3-Speed Replaces 168822C1, 168822C2, AH84588	AMX10261	\$ 16.00
	Farmall®: 65C, 75C, 85U, 95U, 105U Non-Tier 4	Condenser Serpentine Style Rows Core: 19" x 14" x 1.25"	AM87542953	\$ 240.00
	Puma®: 115, 125, 140, 155	Condenser Core: 15.625" x 20.50" x 0.875" Replaces 87574212	AM87641371	\$ 375.00

Case IH®—Tractor

Case IH®—Tractor

Application	Description	Part Number	Retail Price
 Magnum®: 235, 260, 290, 315, 340	Condenser w/ Fuel Cooler Overall: 30 5/8" x 16 3/4" Core: 24 3/4" x 13" x 2 5/8" 3 Rows	AM84345653	\$ 378.00
 7110, 7120, 7130, 7140, 7150, (7210, 7220, 7230, 7240, 7250 BSN JJA0064978)	Condenser Overall: 28" x 11" Core: 21" x 11" x 2 5/8"	AMA184700	\$ 230.00
 (7210, 7220, 7230, 7240, 7250 ASN JJA0064978), 8910, 8920, 8930, 8940, 8950	Condenser	AM181583A1	\$ 350.00
 CX50, CX60, CX70, CX80, CX90, CX100, MX80C, MX90C, MX100C	Condenser Core: 10 3/8" x 19 1/2" x 2 5/8"	AM222893A5	\$ 315.00
 9150, 9170, 9180, 9240, 9250, 9260, 9270, 9280, 9350, 9370, 9380, 9390, Steiger®: Bearcat 1000, Cougar 1000 01/1986-12/1986, Lion 1000 09/1986-12/1987, Panther 1000 01/1987-12/1998	Condenser Overall: 30.25" x 14" Core: 27.75" x 13.75" x 2.25" 2 Rows Replaces 60-4335T2	AM60-6711T1	\$ 395.00
 JX55, JX60, JX65, JX70, JX75, JX80, JX85, JX90, JX95	Condenser Core: 18" x 12" x 2.75" Replaces 5094971, 5096603	AM84215855	\$ 295.00
 JX70, JX95HC, (JX80, JX90, JX95 - Tier 2), Farmall®: (60, 70, 80, 90, 95 - Tier 3)	Condenser Non-Serviceable Must Use Original Mounting Brackets Serpentine Style Rows Core: 15.50" x 20" x 1.25"	AM84342887	\$ 375.00
 JX70U, JX80U, JX90U, JX100U	Condenser Core: 19.25" x 15.75" x 2"	AM5166770	\$ 425.00
 MX100, MX110, MX135, MX150, MX170	Condenser w/ Oil Cooler Core: 25" x 23 1/2" x 3"	AM139870A1	\$ 490.00
 MX180, MX200, MX220, MX240, MX270	Condenser	AM246841A2	\$ 415.00
 MX215, MX305, Magnum®: 180, 335	Condenser w/ Fuel Cooler	AM87360035	\$ 320.00
 MXM120, MXM130, MXM140, MXM155, MXM175, MXM190 Replaces 82019424, 82019425, 82023592	Condenser Core: 20" x 2 3/4" x 11 3/4"	AM82033407	\$ 315.00
 MXU100, MXU110, MXU115, MXU125, MXU130, MXU135, Farmall®: 110A, 120A, 125A, 140A, Maxxum®: 100, 110, 115	Condenser Replaces 82022311, 82035720, 87532909	AM84156148	\$ 350.00
 STX275, STX280, STX325, STX330, STX375, STX380, STX425, STX430, STX450, STX500, Steiger® 4WD: 280, 335, 380, 385, 430, 435, 485	Condenser	AM87315600	\$ 481.00
 Steiger® 4WD: 500, 550, 600, Quadtrac® 4WD: 450, 470, 500, 550, 600	Condenser	AM84210956	\$ 793.00

Case IH®—Tractor

	Application	Description	Part Number	Retail Price
	5120, 5130, 5140, 5220, 5230, 5240, 5250, 7110, 7120, 7130, 7140, 7150, 7210, 7220, 7230, 7240, 7250, 8910, 8920, 8930, 8940, 8950	Evaporator w/ Heater Core	AM98369C3	\$ 255.00
	9110, 9130, 9150, 9170, 9180, (9210, 9230, 9240, 9250, 9260, 9270, 9280 BSN JCB0028399)	Evaporator w/ Heater Core Block Type Valve Core: 17 1/2" x 8" x 3 3/4"	AM60-4042T1	\$ 350.00
	(9210, 9230, 9240, 9250, 9260, 9270, 9280 ASN JCB0028400), 9310, 9330, 9350, 9370, 9380, 9390	Evaporator w/ Heater Core Block Type Valve Core: 21" x 9 1/4" x 8 1/2"	AM60-6677T1	\$ 490.00
	CX50, CX60, CX70, CX80, CX90, CX100, CX105, MX80C, MX90C, MX100, MX100C, MX110, MX120, MX135, MX150, MX170	Evaporator Core: 37" x 4 3/8" x 5"	AM251389A1	\$ 280.00
	JX80, JX90, MXM120, MXM130, MXM140, MXM155, MXM175, MXM190	Evaporator Core: 25 1/2" x 3 1/8" x 5"	AM82034855	\$ 350.00
	MX180, MX200, MX220, MX240, MX270	Evaporator Core: 16 1/4" x 4 3/8" x 10 1/2" Replaces 322847A1	AM322847A2	\$ 350.00
	MX210, MX230, MX255, MX285	Evaporator w/ Heater Core	AM86990263	\$ 455.00
	MX215, MX245, MX275, MX305, STX275, STX280, STX325, STX330, STX375, STX380, STX425, STX430, STX450, STX480, STX500, STX530, Magnum®: 180, 190, 200, 210, 215, 220, 225, 235, 240, 245, 250, 255, 260, 275, 280, 290, 305, 310, 315, 335, 340, 370, 380, Steiger®: 280, 330, 335, 350, 370, 380, 385, 400, 420, 430, 435, 450, 470, 480, 485, 500, 530, 540, 550, 580, 600, 620, Quadtrac® 4WD: 370, 420, 450, 470, 500, 540, 550, 580, 600, 620	Evaporator	AM86990262	\$ 340.00
	MXM120, MXM130, MXM140, MXM155, MXM175, MXM190	Evaporator Core: 25 1/2" x 5" 82034855	AM82009238	\$ 350.00
	MXU100, MXU110, MXU115, MXU125, MXU130, MXU135, Maxxum®: 100, 110, 115, 120, 125, 130, 140, Puma®: 225	Evaporator Core: 18 3/4" x 5" x 6 3/4"	AM82033007	\$ 315.00
	MXU100, MXU110, MXU115, MXU125, MXU130, MXU135, Maxxum®: 100, 110, 115, 120, 125, 130, 135, 140, 145, 150, Puma®: 115, 125, 130, 140, 145, 150, 155, 160, 165, 170, 180, 185, 195 200, 210, 215, 220, 225, 230, 240	Evaporator Core: 18 1/2" x 3 3/4" x 5"	AM82033008	\$ 265.00

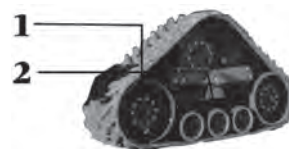

Track Parts

	Application	Description	Part Number	Retail Price	Core
1	STX375 Quad, STX425 Quad, STX450 Quad, STX500 Quad	Reman Front Idler Wheel, Spoked 10-Bolt, 8.75" Diameter, 9.50" Wide, 8.75" Pilot Hole Diameter Replaces 47762193	AM87752138-R	\$ 550.00	\$ 250.00
	STX375 Quad, STX425 Quad, STX450 Quad, STX500 Quad	Reman Front Idler Wheel 10-Bolt, 27.60" Diameter, 9.41" Wide	AM87441101-R	\$ 550.00	\$ 250.00
	Steiger® Quadtrac®	Reman Front Idler Wheel, Poly 10-Bolt, 23.75" Diameter, 9.50" Wide	AM199761A3-R	\$ 550.00	\$ 250.00

Case IH®—Tractor

Application	Description	Part Number	Retail Price	Core
1 Steiger® Quadtrac®	Reman Front Idler Wheel, Narrow 25.60" Diameter, 5" Wide, 8.80" Pilot Hole Diameter	AM84478789-R	\$ 850.00	\$ 250.00
Steiger® Quadtrac®	Front Idler Wheel, Poly 10-Bolt, 27.50" Diameter, 9.50" Wide, 8.75" Pilot Hole Diameter Replaces 47762193	AM323903A2	\$ 1770.00	\$ 250.00
Steiger® Quadtrac®	Reman Front Idler Wheel, Poly 10-Bolt, 27.50" Diameter, 9.50" Wide, 8.75" Pilot Hole Diameter	AM323903A2-R	\$ 550.00	\$ 250.00
2 STX375 Quad, STX425 Quad, STX440 Quad, STX450 Quad, STX500 Quad	Reman Mid-Roller, Poly Cast, Small Seal, 6-Bolt, 13.40" Diameter, 10.50" Wide, 3.25" Pilot Hole Diameter	AM87746541-R	\$ 550.00	\$ 250.00
(STX375 Quad, STX425 Quad, STX450 Quad, STX500 Quad ASN JEE0099501), Steiger®: 485, Quadtrac®, Combines: 7010, 7120, 8010, 8120, 8230, 9230	Mid-Roller 6-Bolt, 13.40" Diameter, 10.50" Wide, 3.25" Pilot Hole Diameter Replaces 48065298, 87438307	AM84162383	\$ 790.00	\$ 250.00
Steiger® Quadtrac®	Reman Mid-Roller, Poly Cast	AM251343A3-R	\$ 450.00	\$ 150.00
Steiger® Quadtrac®	Mid-Roller 6-Bolt, 3.25" Diameter, 10.50" Wide, 3.25" Pilot Hole Diameter	AM87746541	\$ 870.00	\$ 250.00
Steiger® Quadtrac®	Mid-Roller Cast, 13.40" Diameter, 4.50" Wide, 3.50" Pilot Hole Diameter Replaces 47528102, 48145599	AM47827306	\$ 840.00	\$ 250.00
2 Steiger® Quadtrac®	Reman Mid-Roller Cast, 13.40" Diameter, 4.50" Wide, 3.50" Pilot Hole Diameter Replaces 47528102, 48145599	AM47827306-R	\$ 550.00	\$ 250.00
Steiger® Quadtrac®	Reman Mid-Roller, Wide 13.40" Diameter, 8" Wide, 3.50" Pilot Hole Diameter Replaces 48145600	AM47590204R	\$ 550.00	\$ 250.00
Steiger® Quadtrac®	Reman Mid-Roller 6-Bolt, 13.40" Diameter, 10.50" Wide, 3.25" Pilot Hole Diameter Replaces 48065298, 84162383	AM84162383-R	\$ 550.00	\$ 250.00
Steiger® Quadtrac®	Mid-Roller 6-Bolt, 13.40" Diameter, 10.50" Wide, 3.25" Pilot Hole Diameter	AM47487681	\$ 925.00	\$ 250.00
Steiger® Quadtrac®	Reman Mid-Roller 6-Bolt, 13.40" Diameter, 10.50" Wide, 3.25" Pilot Hole Diameter	AM47487681-R	\$ 550.00	\$ 250.00

Clear View Cap Kits

Application	Description	Part Number	Retail Price	Core
STX275, STX280, STX325, STX330, STX375, STX380, STX425, SX430, STX440, STX450, STX480, STX500, STX530	Cap Kit, Clear View Includes 16 Idler & 24 Roller Caps and Plugs	AMX92000	\$ 745.00	

Case IH®—Combine

Table of Contents

Air Cleaner Components	479	Elevator Drive Shafts	517
Air Conditioning and Components	574	Elevator Drive Sprockets and Components	510
Alternators	480	Elevator Gearboxes	516
Auger Components—Bare Header / Platform	554	Elevator Head Shafts	517
Auger Extension Kits	539	Elevator Housings	512
Augers & Components—Distribution	526	Elevator Housing Sheet Metal	512
Augers & Components—Grain Delivery Leveling	524	Exhausts	479
Augers & Components—Horizontal Unloading	530	Fan Components	518
Augers & Components—Lower Clean Grain	519	Feederhouse Bottoms	495
Augers & Components—Lower Tailing Return	521	Feederhouse Chain Roller Kits	493
Augers & Components—Vertical Unloading	528	Feederhouse Chains	487
Augers—Grain Tank Bottom	536	Feederhouse Chain Sprockets	492
Augers—Top Tailing Return	523	Feederhouse Components	490
Auger Tube Donuts	539	Feederhouse Lower Shafts and Brackets	493
Axle Center Tubes	571	Feed Reverser Components	495
Axle Drive Shafts and Couplers	485	Final Drives and Components	484
Beater Components	517	Fuel Components	479
Belts—1420	593	Fuel Lift Pumps	479
Belts—1440, 1460, 1480	594	Gas Struts	573
Belts—1620	595	Glass	572
Belts—1640, 1660, 1680	596	Grain Drains	518
Belts—1644, 1666, 1688, 2144, 2166, 2188	597	Grain Pans and Components	545
Belts—2344, 2366, 2377, 2388, 2577, 2588	598	Grain Tank Auger Floor Liners	540
Belts—5088, 6088, 7088	599	Grain Tank Components	539
Belts—5130, 6130, 7130	600	Grain Tank Extensions	250
Belts—5140, 6140, 7140	601	Guards and Cutter Bar Parts	550
Belts—5150, 6150, 7150	602	Header Lift Cylinders and Components	558
Belts—615, 715	591	Hydraulic Oil Coolers	553
Belts—7010, 7120, 8010, 8120, 9120	603	Hydraulic Pump Drive Hubs and Components	553
Belts—7230, 8230, 9230	604	Hydrostats and Components	482
Belts—7240, 8240, 9240	605	Impeller Blade Kits (Elephant Ears)	501
Belts—7250, 8250, 9250	606	Injectors	408
Belts—815, 915	592	Lighting	561
Belts—Cotton Pickers & Swathers	607	Longblock Assemblies	478
Belts—Platforms	607	Platform Components	557
Brakes and Components	487	Platform Floor Sheets	556
Cab Components—Miscellaneous	568	Poly Skid Plate Kits and Components	560
Chaffer and Sieve Frames and Components	542	Power Steering Cylinders and Components	570
Chaffers—Adjustable Air Foil Top	541	Radiator Hoses and Thermostats	480
Chaffers—Long Finger Top	541	Radiators and Components	479
Chaffers—Rigid Air Foil	542	Reel Components	555
Chaffers—Short Finger Top	540	Return Elevator Boots	516
Chaff Spreaders and Components	552	Rock Drums and Components	494
Clean Grain Elevator Boot Kits and Parts	514	Rotor Assemblies and Components	504
Cleaning Fan Shafts and Components	506	Rotor Bars—Specialty Rotors	499
Concave Components	499	Rotor Bars—Standard Rotors	499
Concaves—Helical	498	Rotor Front Kits and Components	504
Concave Sets	497	Rotor Grates and Components	500
Cornhead—Augers and Auger Liners	581	Rotor Transition Cones and Components	502
Cornhead—Complete Polytin Heads	578	Rotor Vane Repair Kits	506
Cornhead—Fenders and Snouts	578	Row Crop Dividers	557
Cornhead—Hydraulic Deck Plate Kits	584	Sensors	481
Cornhead—Row Unit Components	584	Separator Gearbox Components	507
Cornhead—Stalk Stompers and Components	582	Separator Jackshafts, Sheaves and Components	508
Cylinder Bars and Kits	497	Sickle Assemblies With Heads	550
Distribution Auger Pans and Components	527		
Draper Belts and Components	558		
Elevator Chains	508		
Elevator Chain Sprockets	509		

Table of Contents Continued on Next Page

Case IH®—Combine

Table of Contents - Continued

Sickle Assemblies Without Heads	548	Transmission Components	483
Sickle Drives and Components	554	Transmissions	483
Sickle Knife Heads	548	Unloading Auger Bevel Gears	519
Sieves—Lower	542	Unloading Auger Elbows and Components	534
Spindles	571	Unloading Auger Housings and Components	518
Steering Arms	569	Unloading Auger Swing Cylinders	519
Steps	572	Unloading Drive Components	535
Straw Chopper Blades and Components	547	Unloading Gearbox Shafts	519
Straw Chopper Drive Components	546	Upper Sprocket Tubes	493
Straw Choppers	546	Vane Transports and Components	503
Straw Spreader Shafts and Components	537	Wear Bars	501
Straw Walkers and Parts	546	Weight Brackets	572
Tie Rods and Components	569	Wheel Hubs	571
Tip-Up Assemblies	251		

Longblock Assemblies

Our remanufactured longblocks meet the highest standards in quality. All remanufactured components are inspected for structural integrity, cracks and dimensional specifications and then remanufactured back to OEM specifications. The components are then assembled using the highest quality new parts. We back this with one of the best warranties in the industry.



Application	Description	Part Number	Retail Price	Core
1460 w/ DT436 6 Cylinder Engine	Reman Longblock Assembly Vent in Valve Cover	LBHT436T2	\$ 5600.00	\$ 1500.00
1480, 1680 - w/ DT466 6 Cylinder Engine	Reman Longblock Assembly Vent in Valve Cover	LBHT466T2	\$ 5600.00	\$ 1500.00
1660, 1666, 2166 - w/ Cummins® 8.3T 6 Cylinder Engine	Reman Longblock Assembly Core charge includes similar block core only	LBCUM8.3T7220	\$ 8300.00	\$ 1500.00
1688, 2188, Cotton Pickers: 2044, 2555 - All w/ Cummins® 8.3T 6 Cylinder Engine	Reman Longblock Assembly Core charge includes similar block core only	LBCUM8.3T1688	\$ 8700.00	\$ 1500.00
1680, Cotton Pickers: 1822, 2022, 2055, 2155 BSN JJC0156230 - All w/ 8.3T 6 Cylinder Cummins® Engine	Reman Longblock Assembly Core charge includes similar block core only	LBCUM8.3T1680	\$ 8300.00	\$ 1500.00
2366, 2377, 2388, 2577, Sprayers: 4420, SPX4410	Reman Longblock Assembly	LBCUM8304HPCR24V	\$ 11000.00	\$ 2000.00
2388 BSN 273000 w/ 8.3 Turbo Engine	Reman Longblock Assembly	LBCUM8.3TE2388	\$ 9600.00	\$ 1500.00
2388 ASN 273000 w/ 8.3 Turbo Engine	Reman Longblock Assembly	LBCUM8.3TL2388	\$ 9900.00	\$ 1500.00
2388, 2588	Reman Longblock Assembly Electronic, 24 Valve	LBCUM8.3T2588	\$ 9900.00	\$ 2000.00
7088, Cotton Pickers: 620, 625	Reman Longblock Assembly Replaces 87603080, 87603080R	LBCUM8.9	\$ 12500.00	\$ 5000.00
Cotton Pickers: 2155 ASN JJC0156230, 2255, CPX420, Sprayer: SPX4260 - All w/ Cummins® 8.3T 6 Cylinder Engine	Reman Longblock Assembly Core charge includes similar block core only Cast # - 3923275, 3926567, 3938058	LBCUM8.3T8950	\$ 8700.00	\$ 1500.00
Cotton Pickers: 2555, CPX420 05/2005-06/13 - w/ 8.3T 6 Cylinder Cummins® Engine	Reman Longblock Assembly w/ Auxiliary Hydraulic Pump in timing cover Core charge includes similar block core only	LBCUM8.3T8950AUX	\$ 8700.00	\$ 1500.00
Swathers: 8820, 8825, 8825HP, 8830, 8860, 8860HP	Longblock Assembly Externally Balanced	LBCUM3.9-N	\$ 5100.00	\$ 1000.00
Swathers: 8825, 8825HP, 8840, 8860, 8860HP, 8870	Longblock Assembly Externally Balanced	LBCUM3.9TA-N	\$ 5100.00	\$ 1000.00
Swather: 8860	Reman Longblock Assembly 4-Bolt Injection Pump Mount	LBCUM3.9TA-4B	\$ 5100.00	\$ 1000.00
Case IH® Combine	New Engine, Complete Cursor 16, Tier 2 Replaces 5801897471	AM47702763	\$ 65000.00	\$ 7500.00

Case IH®—Combine

Application	Description	Part Number	Retail Price	Core
7010, 8010, 9010, 9120	New Engine, Complete Cursor 13, F3BE0684N E915	AM5801383426	\$ 39500.00	\$ 5000.00

Exhausts

Application	Description	Part Number	Retail Price	Core
2388 SN JJC0267150-JJC0272999	Exhaust Pipe	AM364150A1	\$ 175.00	

Fuel Lift Pumps

Application	Description	Part Number	Retail Price	Core
1660, 1666, 1670, 1680, 2144, 2166, Cotton Pickers: 1822, 1844, 2022, 2044, 2055	Fuel Transfer Pump Replaces 87473337, J917998	AM87648717	\$ 80.00	
2344, 2366, 2377, 2388, 2577, 2588	Fuel Pump Replaces 302867A1	AM87472310	\$ 204.00	
2344, 2366, 2388, Cotton Picker: 2555	Fuel Transfer Pump 2-hole mount w/ manual priming plunger, gasket not included Replaces 87473338	AMJ936317	\$ 66.00	

Fuel Components

Application	Description	Part Number	Retail Price	Core
7240, 8240, 9240	Sensor, Fuel Pressure	AM5801567640	\$ 200.00	
	Sensor, Low Fuel Pressure Replaces 504343022	AM5801483105	\$ 445.00	
	Sender Unit For Fuel Level	AM47408083	\$ 140.00	

Air Cleaner Components

Application	Description	Part Number	Retail Price	Core
1460, 1480, 1640, 1644, 1660, 1666, 1680, 1688, 2144, 2166, 2188, 2344, 2366 BSN JJC0255700	Rotary Screen Shaft Replaces 118143A1, 234067A1, 1979590C1	AM234067A3	\$ 168.62	
9240	Sensor, Air Intake	AM504307953	\$ 76.00	
9240	Pressure Switch, Air Intake	AM47614038	\$ 17.00	

Radiators and Components

Application	Description	Part Number	Retail Price	Core
715, 815, 915, 1440	Radiator Overall: 25 3/4" x 33 3/4" Core: 24 3/4" x 28 1/8" x 4 1/8" Replaces 55650C2	AM55650C3	\$ 1300.00	
1460, 1480, 1640 BSN JJC0034705, 1660 BSN JJC0038346	Radiator Overall: 28 3/4" x 38 1/2" x 4 3/16"	AMA189213	\$ 1075.00	
1620 ASN JJC0032629, 1640 ASN JJC0034704, 1644, 1660 ASN JJC0038345, 1666, 1680 ASN JJC0045688, 2144 BSN JJC0173150, 2166 BSN JJC0180000, 2344	Radiator Overall: 31 7/8" x 38 3/4" x 5 7/16"	AM1547946C3	\$ 1700.00	



Case IH®—Combine

Application	Description	Part Number	Retail Price	Core
1680 BSN JJC0045689 w/ IHC Engine	Radiator Overall: 26 1/8" x 43.00" x 3 9/16" 4 Rows *Overall width does not include the bracket Replaces 1265697C91	AMA189212	\$ 1515.00	
1688, 2188 BSN JJC019483	Radiator Replaces 117403A1, A189479	AM116154A1	\$ 1875.00	
2188 ASN JJC0191483, 2366 BSN JJC0255700, 2388 BSN JJC0273000	Radiator	AM194951A1	\$ 2020.00	
2377 SN HAJ292001-HAJ300000, 2388 ASN HAJ295001, 2577, 2588, 5088, 5130, 5140, 5150, 6088, 6130, 6140, 6150, 7088, 7130, 7140, 7150, 9230	Radiator Overall: 29 1/4" x 40 3/4" x 4 1/2" 5 Rows, 7 Fins per Inch	AM87302088	\$ 1765.00	
7010, 7120, 7230, 8010 ASN HAJ202000, 8120	Radiator	AM87378361	\$ 1700.00	
Swathers: WD1203, WD1903, WD2303	Radiator	AM87340496	\$ 1647.00	
1440, 1460, 1480, 1620, 1640, 1644, 1660, 1666, 1670, 1680, 1688, 2166, 2188, Cotton Pickers: 420, 1800, 1822, 1844, 2022, 2044, 2055, 2155, 2555, CPX420	Radiator Cap Coolant Reservoir	AM437702C1	\$ 17.00	
1620, 1640, 1644, 1660, 1666, 1680, 1688, 2166, 2188, 2344, 2366, 2388, 2488	Radiator Cap 16 PSI, Fits 3/4" Deep Neck, w/ Drop-Type Vacuum Valve Replaces 90-6633T1, 4029/09070, 303494A2, 303496A2, 72186008, 76084259, 87774949, A171919, L302981, P2537495, W2537495	AMA170241	\$ 5.50	
2344, 2366, 2388 BSN JJC0276540, Cotton Pickers: CPX610, CPX620	Coolant Reservoir	AM251245A1	\$ 94.00	
1440, 1460, 1470, 1480, 1640, 1644, 1660, 1666, 1670, 1680, 1688, 2144, 2166, 2188, Cotton Pickers: 1800, 1822, 1844, 2022, 2044, 2055, 2155, 2555	Overflow Tank Replaces 437703C2, 437703C3	AM437703C1	\$ 48.00	
5140, 6140, 7010, 7120, 7140, 8010, 8120, 9120	Coolant Temperature Sensor	AM82017881	\$ 26.40	

Radiator Hoses and Thermostats

Application	Description	Part Number	Retail Price	Core
1460, 1470, 1480, 1640 BSN JJC0034705, 1660 BSN JJC0038346, 1670 BSN JJC0080540, 1680 BSN JJC0045689	Radiator Hose, Lower 2.062" & 2.812" ID	AM121759C1	\$ 48.29	
815, 915, 1440, 1460, 1470, 1480, 1640, 1660, 1670, 1680	Thermostat Opening temperature of 190°F	AM684739C1	\$ 45.00	
1440, 1460, 1470, 1480, 1640, 1660, 1670, 1680, Cotton Pickers: 1822, 1844	Thermostat By-Pass Hose 1.16" ID	AM672242C2	\$ 6.68	



Alternators

Application	Description	Part Number	Retail Price	Core
1640, 1660, 1666, 1680, 1688, Cotton Pickers: 1800, 2022, 2044, 2055	Alternator w/o Pulley Bosch 12 Volt, 135 Amps IR Replaces 91448C2R	AM91448C2	\$ 140.00	
1660 BSN 38346, 1680 BSN 45689	Alternator 105 Amps	AMA163085	\$ 141.00	
2144, 2166, 2188, 2344, 2366, 2377, 2388, 2577, 2588, 7088, Cotton Pickers: 420, 2155, 2555, CPX420, Floaters: FLX3010, FLX3300B, FLX3510, FLX4010, FLX4300, FLX4375, FLX4510, Sprayers: SPX4260, SPX4410	Alternator w/o Pulley 12 Volt, 135 Amps, IR, CW Rotation Replaces 91448C1, 86994128	AM125849A1	\$ 217.00	
5088, 6088, 7088	Alternator 12 Volt, 200 Amps, IR/IF	AM87715398	\$ 345.00	

Case IH®—Combine

Application	Description	Part Number	Retail Price	Core
8120, 9120	Alternator 14 Volt, 220 Amps Note: Special Order Item	AM87592254	\$ 665.00	

Sensors

Application	Description	Part Number	Retail Price	Core
1620, 1640, 1644, 1660, 1666, 1670, 1680, 1688, 2144, 2166, 2188, 2344, 2366, 2377, 2388, 2577, 2588	Transmitter, Straw Chopper	AM245410C1	\$ 105.00	
2377 SN HAJ292001-HAJ300000, 2388 ASN HAJ292001, 2577, 2588, 7010, 7120, 8010, 9010, AFX8010	Sensor, Feeder Pressure Replaces 122761A1, 84186707	AM86975430	\$ 165.00	
5088, 5130, 5140, 6088, 6130, 6140, 7088, 7130, 7140, 7230, 7240, 8230, 8240, 9230, 9240	Sensor, Grain Tank Cover/Spreader	AM87392235	\$ 29.00	
5088, 5130, 5140, 6088, 6130, 6140, 7010, 7088, 7120, 7130, 7140, 7230, 7240, 8240, 9120, 9230, 9240, Swathers: WD1204, WD1504, WD1904, WD2304	Sensor, Feeder and Lateral Tilt Replaces 87649361, 87649363	AM87330286	\$ 117.00	
5130, 5140, 6130, 6140, 7130, 7140, 7230, 7240, 8230, 8240, 9230, 9240	Switch, Auto-Guidance Sensor, Def/AdBlue Tank Level Replaces 47682727, 84161271, LB50P01001P1	AM84370690 AM47512674	\$ 26.00 \$ 260.00	
5140, 6140, 7140, 7240, 8240, 9240	Switch, Engine Exhaust Pressure Replaces 2859674, 4890193, 6901334 Sensor, Exhaust Pressure	AM504358206 AM5801376024	\$ 78.00 \$ 56.00	
5140, 6140, 7140, 7240, 8240, 9240, Swathers: WD1204, WD1504, WD1904, WD2104, WD2304, WD2504, Patriot Sprayers: 2250, 3240, 3340, 4440, Titan Floaters: 3040, 3540, 4040, 4540	Sensor, Def/AdBlue Quality Replaces 84553250	AM47520143	\$ 320.00	
5140, 6140, 7120, 7140, 7240, 8120, 8240, 9120, Patriot Sprayers: 2240, 2250, 3230, 3330, 4430, SPX3320	Sensor, MAP Temperature/Pressure Replaces 2852821, 4896794, 504073323	AM504372225	\$ 49.00	
5140, 6140, 7140, 7240, 8240, 9240, Patriot Sprayers: 2240, 2250, 3240, 4430, 4440, Titan Floaters: 3040, 3540, 4040, 4540	Temperature Sender, Exhaust Temperature Replaces 47367178, 87482353, LB52S00001P1	AM47478880	\$ 60.00	
5140, 6140, 7140, 7240, 8240, 9240, Patriot Sprayers: 2250, 3240, 3340, 4440, Titan Floaters: 3040, 3540, 4040, 4540	Sensor, 8-Pin/NH3/Ammonia Replaces 47368956, 84382712	AM47520140	\$ 425.00	
5140, Patriot Sprayers: 2240, 3230, 3330, SPX3320	Sensor, Fuel Pressure Replaces 2859145, 504123163, 504222094	AM2854542	\$ 170.00	
6140, 7140, 7240, 8240, 9240	Sensor, Crankcase Pressure	AM504364902	\$ 183.00	
7010, 7120, 7230, 7240, 8010, 8120, 8230, 8240, 9010, 9120, 9230, 9240	Sensor, Feeder Speed Replaces 87000101, 87105603	AM87662555	\$ 119.00	
7010, 7120, 7230, 8010, 8120, 8230, 9010, 9120, 9230	Sensor, Transmission Position Replaces 84269118	AM84457942	\$ 355.00	
7010, 7120, 7230, 8010, 8120, 8230, 9010, 9120, 9230, AFX8010	Sensor, Auto-Guidance Replaces 84161942, 86616461, 87387458	AM84058862	\$ 70.00	
7010, 7120, 7230, 8010, 8230, 9010, 9120, 9230, AFX8010	Sensor, Rotor Gearbox Speed Replaces 87105603	AM87662555	\$ 119.00	
7010, 7120, 8010, 8120	Sensor, Clogged Fuel Filter Indicator	AM500346371	\$ 40.00	
7010, 7120, 8010, 8120, 9010, 9120, AFX8010, Patriot Sprayers: 3230, 3330, SPX3320, Titan Floaters: 3030, 3530, 4030, 4530	Sensor, Oil Pressure and Temperature Replaces 4890193	AM504358206	\$ 78.00	

Prices Subject to Change without Prior Notice. The use of original equipment manufacturer (OEM) part numbers or trademarks, e.g. Case® and John Deere®, are for reference purposes only and for indicating product use and compatibility. Our company and the listed replacement parts contained herein are not sponsored, approved or manufactured by the OEM. All parts are New unless designated Reman in the description.

Case IH®—Combine

Application	Description	Part Number	Retail Price	Core
7010, 7120, 8010, 8120, 9010, 9120, AFX8010, Pickup Platform: 2016	Sensor, Transmission Speed Replaces 86593627	AM84058860	\$ 64.00	
7010, 7120, 8010, 8120, 9010, 9120, AFX8010	Sensor, Spreader Position Proximity	AM84058863	\$ 78.00	
7230, 7240, 8230, 8240, 9230, 9240	Switch, Unload Auger Fold	AM84370692	\$ 29.00	
7240, 8240, 9240	Sensor, Hydraulic Reservoir Level	AM47492948	\$ 92.00	
	Sensor, Fuel Pressure and Temperature	AM5801526037	\$ 125.00	
9240	Sensor, Exhaust Pressure	AM5801382522	\$ 104.00	
Patriot Sprayers: 3240, 3340, 4430	Electric Module	AM87601142	\$ 43.00	

Hydrostats and Components

Our hydrostats are remanufactured by a remanufacturing facility recognized by Sauer/Sundstrand. All units are assembled by a factory-trained technician, using genuine new and remanufactured replacement parts. All units are fully tested to factory specifications for maximum performance.

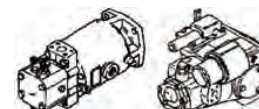

Application	Description	Part Number	Retail Price	Core
1460, 1480, 1660, 1680	Reman Hydrostat, Eaton Single Speed Screw-in Fittings	H1460E1-54/54	\$ 3850.00	\$ 500.00
	Reman Hydrostat, Eaton Dual Speed Screw-in Fittings	H1460E2-54/54	\$ 4195.00	\$ 600.00
1660, 1666, 1680, 1688	Reman Hydrostat, Eaton Dual Speed Both w/ Split Flange Hoses	H1660E2-54/54	\$ 4195.00	\$ 600.00
(1660, 1680 Late), 1688, 2188, 2388	Reman Hydrostat, Eaton Single Speed, Both w/ Split Flange Hoses	H1660LE1-54/54	\$ 3850.00	\$ 500.00
2188	Reman Hydrostat, Eaton 2-Piece RB, Dual Speed	H2188E2-64/54	\$ 4350.00	\$ 750.00
2388	Reman Hydrostat, Eaton	H2388E2-64/54	\$ 4350.00	\$ 600.00
Cotton Pickers: 622, 782, 1400	Reman Hydrostat, Eaton	H1400E-46/33	\$ 3550.00	\$ 500.00
	Reman Hydrostat, Sundstrand	H1400S-22/21	\$ 3550.00	\$ 500.00
Cotton Picker: 782	Reman Hydrostat, Eaton	H782E-46/33	\$ 3550.00	\$ 500.00
	Reman Hydrostat, Sundstrand	H782S-22/21	\$ 3550.00	\$ 500.00
Cotton Picker: 1822	Reman Hydrostat, Eaton	H1822E1-46/33	\$ 3550.00	\$ 500.00
	Reman Hydrostat, Eaton	H1822E2-46/33	\$ 3550.00	\$ 500.00
Cotton Picker: 1844	Reman Hydrostat, Eaton	H1844E1-54/33	\$ 3550.00	\$ 500.00
	Reman Hydrostat, Eaton	H1844E2-54/33	\$ 3550.00	\$ 500.00
Cotton Picker: 2022	Reman Hydrostat, Eaton	H2022E-46/33	\$ 3550.00	\$ 500.00
Cotton Picker: 2044	Reman Hydrostat, Eaton	H2044E-54/33	\$ 3550.00	\$ 500.00
7120, 7130, 7230, 7240, 7250, 8120, 8230, 8240, 9120, 9230, 9240	Hydrostat Motor 125 cc Replaces 84168175	AM47919915	\$ 2427.25	
2366, 2377, 2388, 2577, 2588, 5088, 5130, 5140, 5150, 6088, 6130, 6140, 6150, 7088, 7130, 7140, 7150, Cotton Pickers: 420, 620, 625, 2055, 2555, CPX420, CPX610, CPX620	Hydrostatic Motor Shaft 21 & 26 Spline, 12.40" Long	AM403147A1	\$ 295.00	
(7010, 8010, 9010 ASN HAJ202000), 7120, 7230, 7240, 7250, 8120, 8230, 8240, 8250, 9120, 9230, 9240, 9250 - w/ Thru Drive	Hydrostat Pump 71 cc	AM87577617	\$ 3775.30	
7120, (7130, 7240, 8230, 8240, 9230, 9240 - w/o Thru Drive), 8120, 9120	Hydrostat Pump 125 cc	AM87634754	\$ 6949.25	
2366, 2377, 2388 - Corn, Grain & Rice	Hydrostatic Pump Shaft	AM403149A1	\$ 255.00	

Case IH®—Combine

Application	Description	Part Number	Retail Price	Core
6088, 7088	Hydrostatic Pump Shaft 125 CC/REV	AM87699759	\$ 460.00	
1688, 2188, 2388	Hydro Input Shaft	AM1980169C1	\$ 250.00	
1460, 1480, 1660, 1680 BSN 45689	Hydro Output Shaft For Eaton Hydrostats	AM1980136C1	\$ 330.02	
1640, 1660, 1666, 1670, 1680, 1688, 2166, 2188, 2366, 2388, Cotton Pickers: 2055, 2155, 2555	Hydro Output Shaft	AM1980137C1	\$ 368.00	
5088, 6088, 7088	Auxiliary Drive Hub 21 Spline For 105 cc Hydrostatic Pump	AM87545088	\$ 120.00	
	Auxiliary Drive Hub 27 Spline For 25 cc Hydrostatic Pump	AM87545084	\$ 123.00	



Transmissions

Application	Description	Part Number	Retail Price	Core
1440	Reman Transmission	AMT1440	\$ 2000.00	\$ 1000.00
1460 Early	Reman Transmission	Wheat AMT1460EW	\$ 2450.00	\$ 500.00
		Corn AMT1460EC	\$ 2450.00	\$ 500.00
1460 Late	Reman Transmission	Wheat AMT1460LW	\$ 2450.00	\$ 500.00
		Corn AMT1460LC	\$ 2450.00	\$ 500.00
1480 Early	Reman Transmission	Wheat AMT1480EW	\$ 2450.00	\$ 500.00
		Corn AMT1480EC	\$ 2450.00	\$ 500.00
1480 Late	Reman Transmission	Corn AMT1480LC	\$ 2450.00	\$ 500.00
1660 Early	Reman Transmission	AMT1660EC	\$ 2750.00	\$ 500.00
1680 Early	Reman Transmission	AMT1680W	\$ 2750.00	\$ 1000.00
(1660, 1680 Late), 1666, 1688	Reman Transmission	AMT1688C	\$ 3500.00	\$ 1500.00
2144, 2166, 2188	Reman Transmission	AMT2188C	\$ 4500.00	\$ 1500.00
2344, 2366, 2377, 2388	Reman Transmission 34 & 38 Tooth Replaces 236706A1	AMT2388CR	\$ 4500.00	\$ 1500.00
		AMT2388C	\$ 4500.00	\$ 1500.00
2577, 2588, 5088, 6088, 7088	Reman Transmission 34 & 38 Tooth Replaces 84168421	Rice AM87393465	\$ 6500.00	\$ 1500.00
		AM87393461	\$ 6500.00	\$ 1500.00
5130, 5140, 6130, 6140, 7130, 7140	Reman Transmission	AM84602050	\$ 6500.00	\$ 2000.00



Transmission Components



Application	Description	Part Number	Retail Price	Core
1644, 1660 ASN JJC0038346, 1666, 1680 ASN JJC0045689, 1688, Cotton Picker: 2055	Differential Shaft	AM1342912C1	\$ 310.00	
7010, 7120, 7230, 7240, 8010, 8120, 8230, 8240, 9010, 9120, 9230, 9240, AFX8010	Differential Shaft w/ Lock 8 & 22 Spline, 17.09" Long	AM84069688	\$ 241.33	

Case IH®—Combine







Application	Description	Part Number	Retail Price	Core
2144 BSN JJC0173150, 2166 BSN JJC0182025, 2188 BSN JJC0193725, Cotton Picker: 2155	Transmission Output Shaft	AM1997455C1	\$ 400.00	
2144 ASN JJC0131750, 2166 ASN JJC0182025, 2188 ASN JJC0193725, 2344, 2366, 2377, 2388, 2577, 2588, 7088, Cotton Pickers: 420, 620, 625, 2555, CPX410, CPX610, CPX620	Transmission Output Shaft	AM236378A1	\$ 366.00	
7010, 7120, 7230, 7240, 8010, 8120, 8230, 8240, 9010, 9120, 9230, 9240, AFX8010	Transmission Output Shaft 8 & 22 Spline, 13.85" Long	AM84069687	\$ 200.00	
915 ASN 1250, 1460, 1470, 1480, 1600, 1644 ASN JJC0098060, 1666, 1670, 1680, 1688, 2144, 2166, 2188, 2344, 2366, 2377, 2388 BSN JJC0276540 & ASN HAJ0292001	Cluster Gear 59, 39 & 27 Tooth	AM530699R1	\$ 585.00	
	2nd & 3rd Gear Sliding, 26 & 46 Tooth	AM530700R1	\$ 260.00	
2388, 2577, 2588, 5088, 5130, 5140, 6088, 6130, 6140, 7088, 7130, 7140	Cluster Gear 27, 39 & 59 Tooth	AM87305298	\$ 1135.00	
	2nd & 3rd Gear Sliding, 26 & 46 Tooth	AM87305299	\$ 675.00	
2144, 2166, 2188, 2344, 2366, 2388, 2577, 2588, 5088, 6088, 7088	Gear, Change Driven 35 Tooth	AM1997649C1	\$ 225.00	
2144 ASN JJC0173150, 2166 ASN JJC0182025, 2188, 2344, 2377 ASN HAJ0292001, 2388 BSN JJC0276540 & BSN HAJ0292001, (2577, 2588 ASN HAJ0300001), 5088, 6088, 7088	Gear, Input Pinion 26 Tooth	AM184217C1	\$ 490.70	
2144, 2166, 2188, 2344, 2366, 2377 SN HAJ292001-HAJ300000, 2388, 2577, 2588, 5088, 5130, 5140, 6088, 6130, 6140, 7088, 7130, 7140, Cotton Pickers: 420, 620, 625, 635, 2555, CPX420, CPX610, CPX620	Bevel Gear 28 Tooth	AM236377A1	\$ 272.63	
1420, 1440, 1620, 1640, 1644 BSN JJC0098060, Cotton Pickers: 1822 ASN JJC0012000, 1844 ASN JJC0001999, 2022, 2044	Bearing Seal, Differential Bearing Cage	AM380182R91	\$ 14.00	
2144, 2166, 2188, 2344, 2366, 2377, 2388, 2577, 2588, 5088, 6088, 7088	Main Shaft Drive 37 Tooth	AM1997650C1	\$ 386.90	



Final Drives and Components

Application	Description	OE Part Number	Part Number	Retail Price	Core
1460-1660 BSN 41095	Reman Final Drive, 66 Tooth	92769C93	FD1460	\$ 2000.00	\$ 200.00
1480	Reman Final Drive, 66 Tooth	92770C92	FD1480	\$ 2000.00	\$ 500.00
1680 BSN 48625	Reman Final Drive, 66 Tooth	92770C92	FD1680-66	\$ 2000.00	\$ 500.00
1644 ASN 98060, 1660 41095-103799, 1666, 1680 ASN 48625, 1688	Reman Final Drive, 75 Tooth Replaces 134293C1	134297C1	FD1680-75	\$ 2500.00	\$ 1000.00
2144, 2166, 2344, 2366	Reman Final Drive, 73 Tooth Standard Duty Housing # - 140780A2, Axle # - 138279A1	141577A2	FD2166	\$ 2500.00	\$ 1000.00
2144, 2166, 2188, 2344 BSN 174224, 2366 BSN 245120, 2388 BSN 266791	Reman Final Drive, 73 Tooth Heavy Duty, 1" Thick Pilot Housing # - 135285A2, Axle # - 135288A2	1997415C3	FD2188	\$ 2500.00	\$ 1000.00
2344 ASN 174325, 2366 ASN 245121, 2388 ASN 266792	Reman Final Drive, 73 Tooth Heavy Duty, 2" Thick Pilot Housing # - 135285A2, Axle # - 335948A1	1997415C4	FD2188HD	\$ 3250.00	\$ 1500.00
5088, 5130, 5140, 6088, 6130, 6140, 7088, 7130, 7140	Reman Final Drive	87695215	FD7088	\$ 3500.00	\$ 1000.00
1420, 1440, 1620, 1640, 1644, Cotton Pickers: 1400, 1800, 1822, 1844, 2022, 2044	 Final Drive Coupler 12 Spline, 3.312" Long Replaces 184226C1, 184226C2, 3177224R1	184342C1	AM184342C1	\$ 70.21	
503, 615, 715, Cotton Pickers: 414, 420, Cotton Harvester: 95	 Pinion Shaft	376461R2	AM376461R2	\$ 451.12	

Case IH®—Combine

Application	Description	OE Part Number	Part Number	Retail Price	Core
815, 1420, 1440, Cotton Pickers: 616, 622	Pinion Shaft	395675R1	AM395675R1	\$ 437.74	
915, 1460, 1470, 1480, 1644, 1660, 1666, 1670, 1680, 1688, 2144, 2166, 2188, 2344, 2366, (2377, 2388 SN HAJ292001- HAJ300000), Cotton Pickers: 420, 620, 625, 635, 2055, 2155, 2555, CPX420, CPX610, CPX620	 Pinion Shaft	401870R1	AM401878R1	\$ 395.00	
915, 1460, 1660 BSN JJC0038346	 Pinion Shaft	401912R1	AM401912R1	\$ 425.16	
1480, 1680	 Pinion Shaft For 66 Tooth Bull Gear	130884C1	AM130884C1	\$ 370.51	
1644 ASN JJC009860, 1660 ASN JJ0103800, 1666, 1680 ASN JJC011760, 1688	 Pinion Shaft For 75 Tooth Bull Gear	1342907C1	AM1342907C1	\$ 450.00	
2144, 2166, 2188, 2344, 2366, 2388, Cotton Pickers: 2055 ASN JJC0155439, 2155, 2555, CPX610	 Pinion Shaft, 12 Tooth Replaces 87354348	135290A1	AM135290A1	\$ 280.00	
7010, 7120, 7230, 7240, 8010, 8120, 8230, 8240, 9010, 9120, 9230, 9240, AFX8010	 Pinion Shaft 18 Tooth Replaces 84074717	84449593	AM84449593	\$ 940.00	
1644 ASN JJC009860, 1660 ASN JJ0103800, 1666, 1680 ASN JJC011760, 1688	 Gear, 75 Tooth	1342906C1	AM1342906C1	\$ 950.00	

Axle Drive Shafts and Couplers



Application	Description	Part Number	Retail Price	Core
915 Left Hand, (1460, 1660, 1670, 1688 - Right Hand)	Axle Drive Shaft	14.08" Long AM402725R2	\$ 184.31	
1460 BSN 32000	Axle Drive Shaft	Right Hand 16.65" Long AM121795C1 Left Hand 29.77" Long AM121794C1	\$ 80.00 \$ 354.05	
1460 BSN 32000 w/ Axle Extensions	Axle Drive Shaft	Right Hand 22.65" Long AM193994C1 Left Hand 35.77" Long AM193993C1	\$ 95.00 \$ 236.76	
1460 ASN 32001, 1660 w/ Axle Extensions	Axle Drive Shaft	Right Hand 20.08" Long AM184224C1	\$ 150.00	
1460 ASN 32001 w/ Axle Extensions, 1480 BSN 34000, 1660 w/ Axle Extensions, 1680, 1688	Axle Drive Shaft	Left Hand 33.04" Long AM184223C1	\$ 153.00	
1460 ASN 32001, 1644 BSN 98060, 1660, 1666, 1670 Hillside BSN 80539, 1688	Axle Drive Shaft	Left Hand 27.04" Long AM1309012C1	\$ 220.29	
1480 ASN 34001	Axle Drive Shaft	35.26" Long AM130841C1	\$ 113.00	
1480, 1660 ASN JJC0038346, 1680, 1688	Axle Drive Shaft	32.79" Long AM184189C1	\$ 139.85	

Case IH®—Combine

Application	Description		Part Number	Retail Price	Core
2144 ASN JJC0173150 w/ Axle Extension, 2166 ASN JJC0182025 w/ Axle Extension, 2344 BSN JJC0174359 w/ Standard Final Drive w/o Axle Extension, (2344, 2366 - w/ HD Final Drive w/o Axle Extension), 2366 BSN JJC0252949 w/ Standard Final Drive w/o Axle Extension	Axle Drive Shaft	Right Hand	16.85" Long AM242841A1	\$ 335.00	
		Left Hand	30.08" Long AM242842A1	\$ 415.00	
(2144 ASN JJC0173150 w/ 144" Front Axle and Dual or Flotation Wheels), (2166 ASN JJC0182025 w/ 144" Front Axle and Dual or Flotation Wheels), (2344* BSN JJC0174359 w/ Standard Final Drive or All w/ Heavy Duty Final Drive), (2366* BSN JJC0252949 w/ Standard Final Drive or All w/ Heavy Duty Final Drive)	Axle Drive Shaft	Right Hand	34.69" Long AM242843A1	\$ 385.00	
		Left Hand	47.91" Long AM242844A1	\$ 425.00	
*Models using 18" Axle Extension					
2166 w/o Axle Extensions	Axle Drive Shaft	Right Hand	10.87" Long AM242837A1	\$ 245.00	
		Left Hand	24.09" Long AM242839A1	\$ 375.00	
2188, 2377, 2388, 2577, 2588	Axle Drive Shaft		29.50" Long AM242846A1	\$ 385.00	
2188 w/ Single Wheel Extension, 2377 SN HAJ292001-HAJ300000, 2388 w/ 6" Axle Extension, 2577, 2588	Axle Drive Shaft	Right or Left Hand	35.69" Long AM242852A1	\$ 600.18	
(2188 w/ Duals and Flotation Wheels and 12" Axle Extensions), (2377, 2388 - w/ 12" Axle Extensions), 2577, 2588	Axle Drive Shaft Replaces 135977A1	Right or Left Hand	41.181" Long AM242859A1	\$ 460.53	
(2188, 2388 - w/ Track Attachment), 2588	Axle Drive Shaft Replaces 87330885	Right or Left Hand	30.31" Long AM242853A1	\$ 480.41	
2344, 2366 - w/ 12" Axle Extensions	Axle Drive Shaft	Right Hand	28.465" Long AM280745A1	\$ 273.67	
	12 Spline	Left Hand	41.69" Long AM280744A1	\$ 518.34	
2377 SN HAJ292001-HAJ300000, (2388 w/ Narrow Dual Wheels and 13" Axle Extensions), 2577	Axle Drive Shaft Replaces 87330891	Right or Left Hand	43" Long AM356460A1	\$ 512.42	
7010, 7230, 7240, 8010, 8120, 8230, 8240, 9010, 9120, 9230, 9240, AFX8010 - w/o Axle Extensions	Axle Drive Shaft 22 Spline	Left Hand	26.12" Long AM84440162	\$ 377.66	
8010, 8120, 9120, AFX8010 - w/ 265 mm Axle Extensions	Axle Drive Shaft 22 Spline Replaces 84440972	Right Hand	46.75" Long AM84440974	\$ 268.78	
8010, 8120, 9120, AFX8010 - w/o Axle Extensions	Axle Drive Shaft 22 Spline	Right Hand	36.38" Long AM84440165	\$ 361.64	
8010, 8120, 9120, AFX8010 - w/ 265 mm Axle Extensions	Axle Drive Shaft 22 Spline	Left Hand	36.50" Long AM84440967	\$ 256.07	
915, 1460, 1480, 1640, 1660, 1680, 1688, 2188	Axle Drive Shaft Coupler		3.00" Long AM184341C1	\$ 35.00	
(2344, 2366 w/ Standard Final Drive or w/ Heavy Duty Final Drive), 2388, 2588	Axle Drive Shaft Coupler		3.67" Long AM248600A1	\$ 55.00	
7010, 7120, 8010, 8120, 9120, AFX8010	Axle Drive Shaft Coupler 22 Spline		4.09" Long AM84438982	\$ 99.66	
2166, 2344, 2366, (2377, 2388 HAJ292001-HAJ300000), 2577, 2588, 5088, 5130, 5140, 6088, 6130, 6140, 7088, 7130, 7140, Cotton Pickers: 620, 625, 635, CPX610, CPX620	Axle Drive Shaft Collar Replaces 250756A1		AM244549A1	\$ 82.10	

Case IH®—Combine



Brakes and Components

Application	Description	Part Number	Retail Price	Core
2144 ASN JJC0173150, (2166, 2188 ASN JJC0193725), 2344, 2366, 2377 SN HAJ0292001-HAJ0300000, 2388 BSN JJC0276540 & ASN HAJ0292001, (2577, 2588 ASN HAJ0300001), 5088, 5130, 5140, 6088, 6130, 6140, 7088, 7130, 7140, Cotton Pickers: 420, 620, 625, 635, 2555, CPX420, CPX610, CPX620	Brake Assembly	AM236388A1	\$ 1500.00	\$ 350.00
2144, 2166, 2188, 2344, 2366, 2388, 2588, 5140, 6130, 6140, 7130, 7140	Wheel Brake Disc (12) Required	AM1997959C1	\$ 35.00	
2144, 2166, 2188, 2344, 2366, 2388, 2588	Transmission Separator Plate (13) Required	AM1285974C1	\$ 9.50	
141, 151, 181, 403, 503, 615, 715, 815, 1420, 1440, 1620, 1640, 1644, Cotton Pickers: 414, 416, 420, 422, 616, 622, 782, Cotton Harvesters: 95, 1400	Brake Disc, Bonded 12 Spline, 3.50" ID, 6.50" OD Replaces 121961C92, 321162R91, 351117R91, 368179R91, 1963810C1	AM1963810C2	\$ 16.00	
151, 403, 503, 915, 1460, 1480	Brake Disc, Bonded 12 Spline, 4" ID, 7.125" OD Replaces 121963C91, 369079R92	AM1975446C2	\$ 16.00	
715, 815, 1420, 1440, 1620, 1640, 1644 BSN JJC0098060	Brake Actuating Assembly	AM366182R93	\$ 262.18	

Feederhouse Chains

Our feederhouse chains for Case IH® and International® rotary combines are assembled from high-quality CA557 heavy-duty chain. Slats are mounted using 3/8" grade 5 hardware and locktite for added durability. Conventional combine chains use CA550 chain and slats are mounted with 3/8" grade 5 plated hardware. All feederhouse chains come with serrated slats unless otherwise noted.



Application	Description	Part Number	Retail Price	Core
715, 815 SN 8001	Feederhouse Chain 87 links - slats every 4th link 2 Chain Assembly	AM175991C92	\$ 615.38	
	Serrated Slat For 27 1/4" Chain Centers	AM118270A1	\$ 20.00	
915	Feederhouse Chain 93 links - slats every 2nd link 3 Chain Assembly, CA550	AM180514C92	\$ 858.91	
	Serrated Slat For 18.1875" Chain Centers	AM175997C1	\$ 15.00	
	Smooth Slat For 18.1875" Chain Centers Replaces 196358A1	AM196357A1	\$ 15.00	
1420, 1440, 1460, 1620, 1640, 1644, 1660, 1666, 2144, 2166	Feederhouse Chain, Serrated	AM117864A1	\$ 425.00	
	Feederhouse Chain, Smooth 60 links - 47" Feederhouse 1/4" slats every 6th link, chrome pins 2 Chain Assembly	AM117869A1	\$ 360.00	
	Serrated Slat For 27 1/4" Chain Centers	AM118270A1	\$ 20.00	
	Smooth Slat For 27 1/4" Chain Centers	AM118268A1	\$ 26.55	
1420, 1440, 1460, 1620, 1640, 1644, 1660, 1666, 2144, 2166	Feederhouse Chain, Serrated 60 links - 47" Feederhouse 1/4" slats every 8th link, chrome pins 2 Chain Assembly - Rice Chain	AM117868A1	\$ 499.00	
	Serrated Slat For 27 1/4" Chain Centers	AM118270A1	\$ 20.00	

Case IH®—Combine

Application	Description	Part Number	Retail Price	Core
1420, 1440, 1460, 1620, 1640, 1644, 1660, 1666, 2144, 2166, 2366	Feederhouse Chain, Serrated 69 links - 54" Feederhouse 1/4" slats every 8th link, chrome pins 2 Chain Assembly - Rice Chain	AM117865A1	\$ 729.01	
	Serrated Slat For 27 1/4" Chain Centers	AM118270A1	\$ 20.00	
1420, 1440, 1460, 1620, 1640, 1644, 1660, 1666, 2144, 2166, 2366	Feederhouse Chain, Serrated	AMX28017	\$ 475.00	
	Feederhouse Chain, Smooth 69 links - 54" Feederhouse 1/4" slats every 6th link, chrome pins 2 Chain Assembly	AM117871A1	\$ 475.00	
	Serrated Slat For 27 1/4" Chain Centers	AM118270A1	\$ 20.00	
	Smooth Slat For 27 1/4" Chain Centers	AM118268A1	\$ 26.55	
1480, 1482, 1680, 1682, 1688, 2188	Feederhouse Chain, Serrated	AMX28015	\$ 525.00	
	Feederhouse Chain, Smooth 69 links - 54" Feederhouse 1/4" slats every 6th link, chrome pins 2 Chain Assembly	AM117872A1	\$ 515.00	
	Serrated Slat For 36 3/8" Chain Centers	AM118271A1	\$ 30.00	
	Smooth Slat For 36 3/8" Chain Centers	AM118269A1	\$ 20.00	
1480, 1482, 1680, 1682, 1688, 2188	Feederhouse Chain, Serrated 69 links - 54" Feederhouse 1/4" slats every 8th link, chrome pins 2 Chain Assembly - Rice Chain	AM117866A1	\$ 520.00	
	Serrated Slat For 36 3/8" Chain Centers	AM118271A1	\$ 30.00	
1480, 1482, 1680, 1682, 1688, 2188	Feederhouse Chain, Serrated	AMX28016	\$ 500.00	
	Feederhouse Chain, Smooth 76 links - 60" Feederhouse 1/4" slats every 6th link, chrome pins 2 Chain Assembly	AM136440A1	\$ 500.00	
	Serrated Slat For 36 3/8" Chain Centers	AM118271A1	\$ 30.00	
	Smooth Slat For 36 3/8" Chain Centers	AM118269A1	\$ 20.00	
1480, 1482, 1680, 1682, 1688, 2188	Feederhouse Chain, Serrated 76 links - 60" Feederhouse 1/4" slats every 8th link, chrome pins 2 Chain Assembly - Rice Chain	AM117867A1	\$ 450.00	
	Serrated Slat For 36 3/8" Chain Centers	AM118271A1	\$ 30.00	
1480, 1482, 1680, 1682, 1688, 2188, 2388, 2588	Feederhouse Chain, Smooth 69 links - 54" Feederhouse 1/4" slats every 2nd & 4th link 3 Chain Assembly	AM195664A1	\$ 760.00	
	Smooth Slat For 18.1875" Chain Centers Replaces 196358A1	AM196357A1	\$ 15.00	

Case IH®—Combine

Application	Description	Part Number	Retail Price	Core
1480, 1482, 1680, 1682, 1688, 2188, 2388, 2588	Feederhouse Chain, Serrated 69 links - 54" Feederhouse 1/4" slats every 4th link, chrome pins 3 Chain Assembly	AMB93533	\$ 720.00	
	Serrated Slat For 18.1875" Chain Centers	AM175997C1	\$ 15.00	
	Smooth Slat For 18.1875" Chain Centers Replaces 196358A1	AM196357A1	\$ 15.00	
1480, 1482, 1680, 1682, 1688, 2188, 2388, 2588	Feederhouse Chain, Smooth 76 links - 60" Feederhouse 1/4" slats every 2nd & 4th link 3 Chain Assembly	AM195668A1	\$ 780.00	
	Smooth Slat For 18.1875" Chain Centers Replaces 196358A1	AM196357A1	\$ 15.00	
1480, 1482, 1680, 1682, 1688, 2188, 2388, 2588	Feederhouse Chain, Serrated	AMB93535	\$ 740.00	
	Feederhouse Chain, Smooth 76 links - 60" Feederhouse 1/4" slats every 4th link, chrome pins 3 Chain Assembly	AMB93534	\$ 740.00	
	Serrated Slat For 18.1875" Chain Centers	AM175997C1	\$ 15.00	
	Smooth Slat For 18.1875" Chain Centers Replaces 196358A1	AM196357A1	\$ 15.00	
(1480, 1482, 1680, 1682, 1688, 2188, 2377, 2388, 2577, 2588, 5088, 6088, 7088 - w/o Rocktrap), (5130, 5140, 6130, 6140, 7130, 7140 - w/ Rock Trap)	Feederhouse Chain, Serrated 76 links - 60" Feederhouse 1/4" slats every 2nd & 4th link, chrome pins 3 Chain Assembly, CA557 Machines w/ Field Tracker Kit must order (6) CA557OL Offset Links Replaces 195670A2	AM84207192	\$ 760.00	
	Serrated Slat For 18.1875" Chain Centers Replaces 196360A3	AM196359A2	\$ 18.00	
1480, 1482, 1680, 1682, 1688, 2188, 2388, (5088, 5130, 6088, 6130, 7088, 7130 - w/ Rock Trap)	Feederhouse Chain, Serrated 69 links - 54" Feederhouse 1/4" slats every 2nd & 4th link, chrome pins 3 Chain Assembly, CA557	AM84207190	\$ 760.00	
	Serrated Slat For 18.1875" Chain Centers Replaces 196360A3	AM196359A2	\$ 18.00	
2144, 2166, 2344, 2366	Feederhouse Chain, Serrated 74 links - 60" Feederhouse 1/4" slats every 6th link, chrome pins 2 Chain Assembly	AMX28038	\$ 515.00	
	Feederhouse Chain, Serrated 76 links - 60" Feederhouse 1/4" slats every 8th link, chrome pins 2 Chain Assembly	AM136438A1	\$ 535.00	
	Serrated Slat For 27 1/4" Chain Centers	AM118270A1	\$ 20.00	
2144, 2166, 2344, 2366	Feederhouse Chain, Smooth 76 links - 60" Feederhouse 1/4" slats every 6th link, chrome pins 2 Chain Assembly	AM136439A1	\$ 535.00	
	Smooth Slat For 27 1/4" Chain Centers	AM118268A1	\$ 26.55	

Prices Subject to Change without Prior Notice. The use of original equipment manufacturer (OEM) part numbers or trademarks, e.g. Case® and John Deere®, are for reference purposes only and for indicating product use and compatibility. Our company and the listed replacement parts contained herein are not sponsored, approved or manufactured by the OEM. All parts are New unless designated Reman in the description.

Case IH®—Combine

Application	Description	Part Number	Retail Price	Core
5130, 5140, 6130, 6140, 7130, 7140 - w/o Rock Trap	Feederhouse Chain, Serrated 87 Links 3 Chain Assembly, CA557 Machines w/ Field Tracker Kit must order (6) CA557OL Offset Links	AM84346485	\$ 825.00	
	Serrated Slat For 18.1875" Chain Centers Replaces 196360A3	AM196359A2	\$ 18.00	
(5140, 6140, 7140 ASN YFG14001), 5150, 6150, 7150	Feederhouse Chain, Serrated 22 Slats 3 Chain Assembly, CA557	AM47596677	\$ 1125.00	
7010, 8010, 9010, AFX8010 - w/ Rock Trap	Feederhouse Chain, Serrated 95 links 1/4" slats every 8th link, chrome pins 2 Chain Assembly, CA557 (2) Required Replaces 87397925	AM87283356	\$ 625.00	
	Serrated Slat For 18 1/8" Chain Centers	AM87617002	\$ 18.00	
7010, 8010, AFX8010 BSN HAJ106756 - w/o Rock Trap	Feederhouse Chain, Serrated 111 Links 1/4" slats every 8th link, chrome pins 18 1/16" center-to-center on sprockets 2 Chain Assembly, CA557 (2) Required per Machine Replaces 86995351, 87397924	AM87283358	\$ 843.78	
	Feederhouse Chain, Smooth 111 Links - U-Slats 1/4" every 8th link, chrome pins 2 Chain Assembly, CA557 Replaces 84084683, 86995123	AM87283359	\$ 840.60	
	Serrated Slat For 18 1/8" Chain Centers	AM87617002	\$ 18.00	
7120, 7230, 7240, 8120, 8230, 8240, 9120, 9230, 9240 - w/ Rock Trap	Feederhouse Chain, Serrated 103 Links, Slats every 2nd and 6th link, chrome pins 4 Chain Assembly	AM84179639	\$ 1150.00	
	Serrated Slat	AM84179662	\$ 15.00	
7120, 7230, 7240, 8120, 8230, 8240, 9120, 9230, 9240 - w/o Rock Trap	Feederhouse Chain, Serrated 114 Links -Slats every 2nd and 6th link, chrome pins 4 Chain Assembly Replaces 87646005	AM84179642	\$ 1250.00	
	Serrated Slat	AM84179662	\$ 15.00	

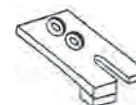

Feederhouse Components

For 2-chain feeder chains. If using split sprockets, material will have to be removed to allow clearance for larger sprocket hub.

Application	Description	Part Number	Retail Price	Core
1420, 1440 ASN 10001, 1480 ASN 14001, 1620, 1640, 1644, 1660, 1666, 1670, 1680, 1688, 2166, 2188	Feederhouse Chain Stripper Plate Feederhouse Chain Stripper Plate	Right Hand Left Hand	AM185819C1 AM185818C1	\$ 12.00 \$ 15.00
2188, 2377, 2388, 2577, 2588	Center Stripper Plate		AM87530580	\$ 20.13
1420, 1440, 1460, 1470, 1480, 1620, 1640, 1644, 1660, 1666, 1670, 1680, 1688, 2144, 2166, 2188, 2344, 2366, (2377, 2388 SN HAJ292001-HAJ300000), 2577, 2588, 5088, 5130, 5140, 6088, 6130, 6140, 7088, 7130, 7140	Bushing, Separator Drive 1" ID, 1.25" OD, 1.125" Wide		AM1302308C1	\$ 6.25
1420, 1440, 1460, 1470, 1620, 1640, 1644, 1660, 1666, 1670, 2144, 2166, 2344, 2366	Front Wear Plate, Rock Trap		AM1320279C1	\$ 63.88

Case IH®—Combine

Application	Description	Part Number	Retail Price	Core
1480, 1482, 1680, 1682, 1688, 2188, 2377 SN HAJ292001-HAJ300000, 2388 BSN JJC0276540, 2577, 2588, 5088, 5130, 5140, 6088, 6130, 6140, 7088, 7130, 7140	Front Wear Plate, Rock Trap Replaces 1320278C1	AM87612310	\$ 50.01	
1480, 1680, 1688, 2377, 2388, 2577, 2588, 5088, 5130, 5140, 6088, 6130, 6140, 7088, 7130, 7140	Upper Feederhouse Seal	AM634248R2	\$ 16.60	
1640, 1660, 1680, 2144, 2166, 2188, 2344, 2366, (2377, 2388 SN HAJ292001-HAJ300000)	Pin, Field Tracker Tilt Cylinder 1" OD, 3.32" Long	AM1266752C1	\$ 16.35	
	Pin, Field Tracker Tilt Cylinder 1" OD, 3.66" Long	AM1266753C1	\$ 15.78	
2188, 2377 SN HAJ292001-HAJ3000000, 2388 BSN JJC0276540, 2588 ASN HAJ300001	Support	Right Hand AM1989593C1	\$ 19.15	
2377, 2388, 2588	Feederhouse Plate, Field Tracker	AM197389A3	\$ 1925.00	
7010, 7120, 7230, 7240, 7250, 8010, 8120, 8230, 8240, 8250, 9120, 9230, 9240, 9250, AFX8010	Feederhouse Door, Access Cover Includes Bolt Kit	AMX29170	\$ 214.00	
2377 SN HAJ292001-HAJ300000, 2388, 2577, 2588	Rock Trap Door	AM241643A2	\$ 343.30	
(5130, 6130, 7130 - w/ Common Cab), (5140, 6140, 7140 - 03/2014-10/15), 7230, 7240, 7250, 8230, 8240, 8250, 9230, 9240, 9250	Solenoid, Feeder Valve Replaces 87775314	AM188105A1	\$ 70.00	
7010, 7120, 7230, 7240, 8010, 8120, 8230, 8240, 9010, 9120, 9230, 9240	Feederhouse Drive Gearbox, Lower Replaces 86999169, 87109541, 87109542	AM87610913	\$ 2075.00	
(2377, 2388 SN HAJ0292001-HAJ0300000), 2577, 2588	Feederhouse Drive Gearbox	AM393577A2	\$ 1500.00	
1440, 1460, 1470, 1480, 1640, 1644, 1660, 1666, 1670, 1680, 1688, 2144, 2166, 2188, 2344, 2366, 2377, 2388, 2577, 2588, 5130, 5140, 5150, 6130, 6140, 6150, 7088, 7130, 7140, 7150	Gear Set Includes 18 & 31 Tooth Gears Replaces 191285C1	AM1315597C1	\$ 500.00	
1640, 1644, 1660, 1666, 2144 BSN JJC0173150, 2166 BSN JJC0182025	Jackshaft, Feeder Cross 70" Long Replaces 1319482C1	AM1319482C2	\$ 355.81	
2344 ASN JJC0174400, 2366 ASN JJC0254000, 2377, 2388 ASN JJC0268800, 2577, 2588	Jackshaft, Feeder Drive	AM388771A1	\$ 490.01	
7010, 7120, 7230, 7240, 8010, 8120, 8230, 8240, 9010, 9120, 9230, 9240, AFX8010	Feederhouse Gearbox Shaft	AM87449556	\$ 600.00	
	Shaft, Rock Trap Friction 22 Tooth, 11 Spline	AM87536812	\$ 341.38	
	Knife Blade, Rock Trap Replaces 86995742	AM87108966	\$ 85.00	
7010, 7120, 7230, 7240, 8010, 8120, 8230, 8240, 9120, 9230, 9240, AFX8010	Feed Conveyor Shaft	AM87282003	\$ 325.00	
7010, 7120, 7230, 7240, 8010, 8230, 8240, 9010, 9120, 9230, 9240, AFX8010	Feederhouse Chain Wear Strip (4) Required	AM86638209	\$ 23.00	
7010, 7120, 8010, 8120, 9120, AFX8010	Clutch Plate For Feederhouse Drive Gearbox	AM87536805	\$ 40.98	
	Transmission Disc 35 Spline, 5.54" OD	AM87536806	\$ 74.97	
1440, 1460, 1470, 1480, 1620, 1640, 1644, 1660, 1666, 1670, 1680, 1688, 2144, 2166, 2188, 2344, 2366, 2377, 2388, 2577, 5088, 6088, 7088	Adjusting Eyebolt Replaces 1321735C1, 1321735C2	AM1321735C3	\$ 30.45	
1420, 1440, 1460, 1480, 1620, (1640, 1644, 1660, 1666, 1680, 1688, 2144, 2166, 2188, 2344 BSN JJC0174399, 2366 BSN JJC0253999, 2388 BSN JJC0268799 - w/ Rock Trap)	Idler Support Replaces 1321933C1, 1321933C2	AM1321933C3	\$ 60.98	

Prices Subject to Change without Prior Notice. The use of original equipment manufacturer (OEM) part numbers or trademarks, e.g. Case® and John Deere®, are for reference purposes only and for indicating product use and compatibility. Our company and the listed replacement parts contained herein are not sponsored, approved or manufactured by the OEM. All parts are New unless designated Reman in the description.

Case IH®—Combine

Application	Description	Part Number	Retail Price	Core
1680, 1688, 2188, 2377, 2388, 2577, 2588	Pulley, Feeder Drive 14 Tooth, 4-Groove, 12" OD Replaces 193999C1, 193999C2	AM193999C3	\$ 447.50	
(2377, 2388 HAJ292001-HAJ300000), 2577, 2588	Pulley, Feeder Jackshaft Drive 4-Groove, 16.71" OD Replaces 87665207	AM388395A1	\$ 350.49	
(2377, 2388 SN HAJ292001-HAJ300000), 2577, 2588, 5088, 5130, 5140, 6088, 6130, 6140, 7088, 7130, 7140	Pulley, Feeder Jackshaft Drive 6 Spline, 4-Groove, 13.23" OD Replaces 87665210	AM388396A1	\$ 253.11	
1420, 1440 ASN 10000, 1460 ASN 12000, 1480 ASN 14000, 1620, 1640, 1644, 1660, 1666, 1680, 1688, 2144, 2166, 2188, 2344 BSN JJC0174399, 2366 BSN JJC0253999, 2388 ASN JJC0268799, 2577, 2588	Pulley Hub, Feederhouse Jackshaft Drive 2 Keyways, 1.508" Hex Bore Diameter Replaces 1305154C2	AM398526A1	\$ 199.00	
7010, 7120, 8010, 8120, 9120, AFX8010	Ball Bearing, Feeder Jackshat Replaces 80609150, 86533335, B92630	AM86575514	\$ 94.90	
1420, 1440, 1460, 1620, 1640, 1644, 1660, 1666, 2144, 2166, 2366	Beater Fins, Rock Trap Set of 3, Serrated, 32.675" Long	AMB95329	\$ 137.22	
	Beater Fins, Rock Trap Set of 3, 32.675" Long	AMB95330	\$ 202.45	
1460, 1620, 1640, 1644, 1660, 1666, 1670, 2144, 2166, 2344, 2366	Beater Fin, Rock Trap Serrated (3) Required Replaces 1324438C1, B95329, LBFH4C0	AM1320921C2	\$ 29.50	
1480, 1680, 1688, 2188, 2377, 2388, 2577, 2588, 5088, 6088, 7088	Beater Fins, Rock Trap Set of 3, 42.313" Long Replaces 1324437C1	AMB95328	\$ 189.92	
5088, 5130, 5140, 6088, 6130, 6140, 7088, 7130, 7140	Sprocket, Rock Trap 30 Tooth, Hex Bore	AM87674273	\$ 78.50	
403, 503, 615, 715, 815, 915, 1440, 1460, 1480, 1482, 1640, 1644, 1660, 1666, 1670, 1680, 1682, 1688, 2144, 2166, 2188, 2344, 2366, 2377 SN HAJ292001-HAJ300000, 2388, 2577, 2588, 5088, 5130, 5140, 6088, 6130, 6140, 7088, 7130, 7140	Idler Pulley 0.625" ID, 8" OD, 3.25" Wide	AM176579C1	\$ 87.81	
5130, 5140, 6130, 6140, 7088, 7130, 7140	Feed Conveyor Shaft Replaces 84126834	AM84174008	\$ 306.39	
5130, 5140, 6088, 6130, 6140, (7010, 8010 BSN HAJ202001), 7088, 7130, 7140, AFX8010	Feeder Drum Idler Bearing 1 1/8" (28.60 mm) Hex Bore, 1.4843" (37.70 mm) Wide, 2.8346" (72 mm) OD	AM121602	\$ 17.00	
(640, 1660, 1680 - w/ Field Tracker), 2144, 2166, 2188, 2344, 2366, 2388 BSN JJC0276540, 2588	Bearing Support	AM100273A2	\$ 50.00	

Feederhouse Chain Sprockets

To extend the life of your chain assemblies, always replace the sprockets when installing a new chain.



Application	Description	Part Number	Retail Price	Core
615 ASN 12000, 715, 815, 915 ASN 8001, 1420, 1440, 1460, 1480, 1482, 1620, 1640, 1644, 1660, 1666, 1680, 1682, 2144, 2166, 2188	Feederhouse Chain Sprocket 9 Tooth, 1.50" Hex	AM1970248C1	\$ 59.00	
	Feederhouse Chain Sprocket Hardened 9 Tooth, 1.50" Hex Split sprocket for easy changeover	AMFM-91	\$ 117.38	

Case IH®—Combine

Upper Sprocket Tubes



Application	Description	Part Number	Retail Price	Core
1480, 1680, 1688, 2188, 2388 BSN HAJ0300000	Sprocket Tube	AM1989587C2	\$ 515.00	
2388 ASN HAJ300001, 2577, 2588	Sprocket Tube Replaces 87384169	AM87642397	\$ 545.00	
5088, 5130, 5140, 5150, 6088, 6130, 6140, 6150, 7088, 7130, 7140, 7150	Sprocket Tube 9 Spline, 40.25" Overall Length, 39.75" Tube Length, 3.001" Spline ID, 5.14" Spline OD	AM84122242	\$ 585.00	
7010, 8010, 9010, AFX8010	Sprocket Tube Replaces 87282647, 87282648, 87283554	AM87284914	\$ 636.83	
7120, 7230, 7240, 8120, 8230, 8240, 9120, 9230, 9240 - w/ Rock Trap	Sprocket Tube No Internal Clutch Replaces 84296465	AM84414915	\$ 800.00	

Feederhouse Chain Roller Kits

These kits will reduce the wear on your feeder chain by keeping the chain off the upper and lower wear plates. This will reduce the noise and increase the life of your chain dramatically.



Application	Description	Part Number	Retail Price	Core
1420, 1440, 1460, 1620, 1640, 1660, 2144, 2166, 2344, 2366	Feederhouse Chain Roller Kit 2 Chain Roller Kit, 37" Wide	AMFCRA-1	\$ 430.00	
(1480, 1680, 2188, 2388 Early)	Feederhouse Chain Roller Kit 2 Chain Roller Kit, 47" Wide	AMFCRA-2	\$ 430.00	
(1480, 1680, 2188, 2388 Late)	Feederhouse Chain Roller Kit 3 Chain Roller Kit, 47" Wide	AMFCRA-3	\$ 570.00	
(2388, 2588, 5088, 6088, 7088, 7130 - 2011 and Later)	Feederhouse Chain Roller Kit 3 Chain Roller Kit	AMFCRA-4	\$ 620.00	
7010, 7120, 7230, 8120, 8230, 9210, 9230	Feederhouse Chain Roller Kit 4 Chain Roller Kit	AMFCRA-5	\$ 825.00	

Feederhouse Lower Shafts and Brackets

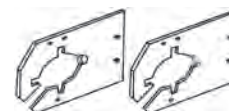

Application	Description	Part Number	Retail Price	Core
(1440, 1460 - w/ Rock Trap), (1470, 1640, 1660, 1670 - w/ Regular Feederhouse)	Upper Feederhouse Shaft, 61.875" Long	AM1320160C3	\$ 155.00	
1480, 1482 - w/o Feeder Reverser or Rock Trap	Upper Feederhouse Shaft, 65.25" Long	AM192728C1	\$ 110.00	
1480, 1482 - w/ Feeder Reverser and w/ or w/o Rock Trap	Upper Feederhouse Shaft, 70.00" Long	AM1320099C2	\$ 299.68	
1680, 1682, 2188, 2388 BSN JJC0268799	Upper Feederhouse Shaft, 67.625" Long	AM1321440C2	\$ 165.00	
2377, 2388 ASN JJC0268800, 2577, 2588	Upper Feederhouse Shaft, 69.125" Long	AM389071A1	\$ 184.00	
1660, 1666, 1680, 1688, 2188 - w/o Field Tracker	Feederhouse Lower Shaft Bracket, Right Hand	AM1321629C2	\$ 25.00	
	Feederhouse Lower Shaft Bracket, Left Hand	AM138178A1	\$ 25.00	
2144 ASN JJC0173150, 2166, 2188 ASN JJC0193725, 2344, 2366, 2388 BSN JJC0268799	Feeder Pulley, Jackshaft Drive, 13.22" OD Replaces 238967A1	AM238967A2	\$ 184.00	
715, 815, 915, 1440, 1460, 1480	Feeder Shaft 70.00" Long, 1.375" Diameter Replaces 195560C2	AM176571C1	\$ 110.00	
1680, 1688, 2166 BSN 182025, 2188	Feeder Shaft 70.062" Long, 1.50" Diameter	AM1319483C2	\$ 185.00	
2144 ASN JJC0173150, 2166, 2188 ASN JJC0193725, 2344 BSN JJC0174399, 2366 BSN JJC0253999, 2388 BSN JJC0268799	Feeder Shaft, 70.06" Long Replaces 253531A1	AM241931A3	\$ 298.00	

Case IH®—Combine

Application	Description	Part Number	Retail Price	Core
5140, 6140, 7140	Pulley	AM84554766	\$ 300.00	
615, 715, 1420, 1440, 1460, 1480	Bearing, Left Hand Feederhouse Jackshaft Replaces 611583R1, 611583R91	AMJD9275	\$ 24.15	
2144 ASN JJC0173149, 2166 ASN JJC0182024, 2188 ASN JJC0193724, 2344, 2366, 2377, 2388, 2577, 2588, 5088, 6088, 7088	Bearing, Feederhouse Jackshaft	AM241929A2	\$ 77.49	
5088, 5130, 5140, 5150, 6088, 6130, 6140, 6150, 7088, 7130, 7140, 7150	Bearing, Feederhouse Upper Shaft 1.75" Hex Bore Diameter	AM87620467	\$ 60.00	

Rock Drums and Components

Our six-bolt, heavier and stronger rock drums are built to exceed OEM specifications. They can be used for conversion to 3-chain feederhouse chain or for replacing your existing-style damaged or worn out rock drum.



Application	Description	Part Number	Retail Price	Core
1420, 1440, 1460, 1470, 1620, 1640, 1660, 1644, 1666, 2144, 2166	Smooth Drum	AM1957437C1	\$ 350.00	
	Two Recess Drum	AM1957439C1	\$ 450.00	
1420, 1440, 1470, 1620, 1640, 1644, 1660, 1666, 2144, 2166, 2344, 2366	Rock Drum Shaft 35.75" Long, 1.25" Diameter	AM187207C2	\$ 55.00	
1480, 1482, 1680, 1682, 1688, 2188	Two Recess Drum	AM1957440C3	\$ 470.00	
1480, 1482, 1680, 1682, 1688, 2188, 2388, 2588	Smooth Drum	AM1957438C1	\$ 285.00	
	Three Recess Drum	AM196409A2	\$ 585.00	
	Rock Drum Shaft 45" Long	AM187208C2	\$ 70.00	
1482, 1680, 1688, 2188, 2377, 2388, 2577, 2588	Rock Drum Shaft 59" Long Replaces 1320129C1, 1320129C2	AM389022A1	\$ 155.00	
1660, 1644, 1680, 1688, 2144, 2166, 2188, 2344, 2366, 2388	Rock Drum Arm	Right Hand AM1338288C3 Left Hand AM1338287C3	\$ 135.00 \$ 135.00	
	Rock Drum Arm Hardware Kit Needed for installation on early machines w/ 1" diameter shaft, recommended for all other models	HW921-003	\$ 35.00	
1644, 1660, 1680, 1688, 2144, 2166, 2188, 2344, 2366, 2388	Rock Drum Arm	Right Hand AM1319876C5 Left Hand AM1319875C5	\$ 200.00 \$ 200.00	
	Rice w/ Trash Shield			
	Rock Drum Arm Hardware Kit Needed for installation on early machines w/ 1" diameter shaft, recommended for all other models	HW921-003	\$ 35.00	
1420, 1440, 1460, 1480, 1620, 1640, 1644, 1660, 1666, 1680, 1688, 2144, 2166, 2188, 2344, 2366	Drum Arm Pivot Spacer 1.81" Long, 0.656" ID, 0.875" OD Replaces 187217R1	AM187217C1	\$ 4.16	
7010, 7120, 7230, 7240, 8010, 8230, 8240, 9010, 9120, 9230, 9240, AFX8010	Drum Arm Spacer 1.07" Long, 0.656" ID, 1" OD Replaces 86621437, 87013282	AM87021332	\$ 9.25	
7010, 8010, AFX8010	Feeder Drum 51.50" Long, 8" Tube Diameter, 9" Ring Diameter Replaces 87283559, 87283558, 87107284, 86995659	AM87660197	\$ 728.34	
7120, 7230, 7240, 8120, 8230, 8240, 9120, 9230, 9240	Feeder Drum Replaces 87640483	AM84294425	\$ 850.50	
	Feeder Drum, Posifeed	AM84294425-PF	\$ 968.57	
7010, 7120, 7230, 7240, 8010, 8120, 8230, 8240, 9010, 9120, 9230, 9240, AFX8010	Feeder Drum Shaft 53.19" Long	AM87646024	\$ 318.23	

Case IH®—Combine

Application	Description	Part Number	Retail Price	Core
7010, 8010, 9010, AFX8010	Feeder Roller Arm Replaces 86995909, 87107279, 87281704	AM87282449	\$ 134.83	
1620, 1640, 1644, 1660, 1666, 1670, 1680, 1688, 2144, 2166, 2188, 2344, 2366, 2377, 2388, 2577, 2588	Bearing Flange 3.562" ID, 2.327" OD Replaces 187195C2, 187196C1, 1319861C2	AM1330461C1	\$ 6.25	
7010, 7120, 8010, 8120, 9120, AFX8010	Front Bracket, Feed Drum Tensioner	AM84075251	\$ 7.66	
	Rear Bracket, Feed Drum Tensioner	AM87644200	\$ 25.99	
7010, 8010, AFX8010	Feeder Drum Tensioner Plate Replaces 935856R2	AM87753060	\$ 98.15	
5088, 5130, 5140, 5150, 6088, 6130, 6140, 6150, 7088, 7130, 7140, 7150	Bearing, Feederhouse Upper Shaft 1.75" Hex Bore Diameter	AM87620467	\$ 60.00	



Feederhouse Bottoms









Application	Description	Part Number	Retail Price	Core
1420, 1440, 1460, 1620, 1640, 1644, 1660, 1666	Feederhouse Bottom 35 9/16" x 43 1/2"	AM1324576C1	\$ 320.00	
1420, 1440, 1460, 1620, 1640, 1644, 1660, 1666, 2144, 2166, 2344, 2366	Feederhouse Bottom 35 9/16" x 51 1/4"	AM1324578C2	\$ 345.00	
1480, 1482, 1680, 1688, 2188, 2388, 2588	Feederhouse Bottom 44 3/4" x 51 1/2"	AM1324572C1	\$ 425.00	
1680, 1688, 2188, 2388, 2588	Feederhouse Bottom 44 3/4" x 56 3/4"	AM1324574C2	\$ 455.00	
2144, 2166, 2344, 2366	Feederhouse Bottom 35 9/16" x 56 3/4"	AM1994217C2	\$ 450.00	
5130, 5140, 5150, 6088, 6130, 6140, 6150, 7088, 7130, 7140, 7150 - w/o Rock Trap	Feederhouse Bottom Replaces 87666921	AM87727365	\$ 1100.00	
7010, 7120, 7230, 7240, 8010, 8120, 8230, 8240, 9120, 9230, 9240, AFX8010	Feederhouse Bottom, Center 53.50" Long, 28.90" Wide Replaces 87282536, 86995577	AM87282537	\$ 593.00	
7010, 7120, 8010, 8120, 9010, 9120, AFX8010 - w/ Rock Trap	Feederhouse Bottom, Rear Replaces 86995578, 87533212	AM87673525	\$ 239.90	
7010, 7120, 8010, 8120, 9120, AFX8010 - w/o Rock Trap	Feederhouse Bottom, Rear	AM87730307	\$ 318.68	
7010, 7230, 7240, 8010, 8120, 8230, 8240, 9230, 9240, AFX8010	Feederhouse Bottom, Front Replaces 87393958	AM84140379	\$ 898.46	
7120, 7230, 7240, 8120, 8230, 8240, 9120, 9230, 9240 - w/ Rock Trap	Feederhouse Bottom, Rear	AM84376397	\$ 264.35	
(7230, 8230, 9230 - w/ Common Cab), 7240, 8240, 9240	Feederhouse Bottom	AM47594973	\$ 486.71	
7010, 7120, 7230, 7240, 7250, 8010, 8120, 8230, 8240, 8250, 9120, 9230, 9240, 9250, AFX8010	Feederhouse Floor Liner Kit Bolt-On or Weld-In	AMX29169	\$ 1367.00	

Feed Reverser Components

Application	Description	Part Number	Retail Price	Core
1440, 1460, 1480, 1620, 1640, 1660, 1680, 1644, 1666, 1688, 2144, 2166, 2188, 2366, 2388	Reverser Motor All IH Rotary Models w/ Electric Reverser	AM245927C91	\$ 259.00	



Case IH®—Combine

	Application	Description	Part Number	Retail Price	Core
	1420, 1440, 1460, 1480, 1620, 1640, 1644, 1660, 1666, 1680 BSN JJC0045689, 2144, 2166, 2188, 2344 BSN JJC0174399, 2366 BSN JJC0253999, 2388 BSN JJC0268799	Flywheel, Feed Reverser Motor 133 Tooth, 1.502" Bore Diameter, w/ Keyway Replaces 1321537C91	AM1321537C92	\$ 315.22	
	1420, 1440, 1460, 1480, 1620, 1640, 1644, 1660, 1666, 1680, 1688, 2144, 2166, 2344, 2366, 2388 BSN HAJ0292001 - w/ or w/o Rock Trap	Feed Reverser Drive Sprocket 20 Tooth	AM1329717C1	\$ 75.00	
	1644, 1666, 1688, 2144, 2166, 2188, 2344, 2366, 2377, 2388, 2577, 2588	Feed Reverser Rock Trap Drive Sprocket 30 Tooth	AM125407A1	\$ 68.00	
	1420, 1440, 1460, 1480, 1620, 1640, 1660, 1666, 1680, 1682, 1688, 2144, 2166, 2188, 2344, 2366, 2388 - w/ Rock Trap	Feed Reverser Idler Sprocket 0.625" Bore	AM541857R92	\$ 17.04	
	1640, 1644, 1660, 1666, 1680, 2144, 2166, 2188, 2344, 2366, 2388 BSN JJC0268799 - w/ Rock Trap	Feed Reverser Idler Sprocket 1.312" Bore	AM1321531C93	\$ 75.00	
	1420, 1440, 1460, 1480, 1620 ASN 0032630, 1640, 1644, 1660, 1670, 1680, 1682, 1688, 2144, 2166, 2188, 2344, 2366, 2377, 2388 BSN JJC0276540 - w/ Rock Trap	Feed Reverser Sprocket 20 Tooth	AM1329719C2	\$ 45.00	
	1420, 1440, 1460, 1480, 1620, 1640, 1644, 1666, 1680, 1682, 1688, 2144, 2166, 2188, 2344, 2366, 2377, 2388, 2577 - w/ or w/o Rock Trap	Feed Reverser Sprocket 40 Tooth	AM1329720C2	\$ 95.00	
	2344 ASN JJC0174400, 2366 ASN JJC0254000, 2377 ASN HAJ0292001, 2388 ASN HAJ0292001 & ASN JJC0268800, 2577, 2588, Cotton Pickers: (420, CPX420 ASN Y6T011117, CPX620 ASN Y6T011706 - Fan Engagement)	Feed Reverser Gearbox Cylinder	AM87449896	\$ 220.00	
	1420, 1440, 1460, 1480, 1620, 1640, 1644, 1660, 1666, 1680, 1682, 1688, 2144, 2166, 2188, 2344, 2366, 2388	Feeder Reverser Shaft 13" Long	AM1321534C1	\$ 65.00	
	2344 ASN JJC0174400, 2366 ASN JJC0254000, 2377, 2388, 2577, 2588	Feeder Reverser Shaft 31 Spline	AM681639	\$ 617.41	
	2344, 2366, (2377, 2388 SN HAJ292001-HAJ300000), 2577, 2588	Feed Reverser Gear 16 Tooth Replaces 80681629	AM681629	\$ 142.02	
	2344, 2366, (2377, 2388 SN HAJ292001-HAJ300000), 2577, 2588	Feed Reverser Gear 32 Tooth, 6 Spline Hub, 8.335" OD Replaces 80681627	AM681627	\$ 517.54	
	1420, 1440, 1460, 1620, 1640, 1644, 1660, 1666, 2144, 2166, 2344, 2366	Feed Plate Door Hinge Replaces 193364C1	AM193364C2	\$ 94.68	

Case IH®—Combine



Cylinder Bars and Kits

All bars are carefully checked and sets are matched for equal weight distribution on the cylinder prior to shipment. Grade 8 fasteners are supplied for most models.

Application	Description	Part Number	Retail Price	Core
1420, 1620	Cylinder Bar Kit (8) Helical and (8) Straight Bars w/ Mounting Fasteners	Standard AMOIHC-1420	\$ 424.32	
1440, 1460, 1470, 1640, 1644, 1660, 1666, 2144, 2166, 2344, 2366	Cylinder Bar Kit, Grain (12) Helical and (9) Straight Bars w/ Mounting Fasteners	Hardened AMB93417	\$ 460.00	
		Chrome AMB93869	\$ 965.00	
	Cylinder Bar Kit, Soybean (12) Helical and (3) Straight Bars w/ Mounting Fasteners	Hardened AMB93419	\$ 275.00	
1480, 1482, 1680, 1682, 1688, 2188, 2388, 2588	Cylinder Bar Kit, Grain (16) Helical and (12) Straight Bars w/ Mounting Fasteners	Hardened AMB93418	\$ 625.00	
		Chrome AMB93870	\$ 1250.00	
1480, 1482, 1680, 1688, 2188, 2377, 2388, 2577, 2588	Helical Cylinder Bar 120° Pitch Corn and Grain	AM1308830C2	\$ 27.84	
1420, 1440, 1480, 1620, 1640, 1644, 1660, 1666, 1680, 1688, 2144, 2166, 2188, 2344, 2366, 2377, 2388, 2577, 2588	Straight Rotor Bar Corn and Grain Replaces 1309123C1 (Hardened)	AM1308668C1	\$ 30.00	
1640, 1644, 1660, 2144, 2166, 2344, 2366	Helical Rotor Bar Corn and Grain	AM1308829C2	\$ 24.00	



Concave Sets

Application	Description	Part Number	Retail Price	Core
1420, 1620	Middle/Rear Wires are 1/8" Lower than OEM Concaves Replaces 193986C4, 1319187C1, 1319187C2	AM193986C5	\$ 585.23	
1440, 1460, 1470, 1640, 1644, 1660, 1666, 1670, 2144, 2166, 2344, 2366 Note: Concaves will accept bolt-on extensions	Concave Set, Set of 3, Small Wire	AMB93571	\$ 1450.00	
	Front, Small Wire	AM1309208C3	\$ 740.00	
	Concave Lip	AMX27518	\$ 60.00	
	Middle/Rear, Small Wire	AM1309210C3	\$ 600.00	
	Concave Set, Set of 3, Large Wire	AMB93572	\$ 1385.00	
1480, 1482, 1680, 1682, 1688, 2188, 2388, 2588 Note: Concaves will accept bolt-on extensions	Front, Large Wire	AM1302606C5	\$ 510.00	
	Concave Lip	AMX27518	\$ 60.00	
	Middle/Rear, Large Wire	AM1302607C4	\$ 695.00	
	Concave Set, Set of 3, Small Wire	AMB93573	\$ 1450.00	
	Front, Small Wire	AM1309204C3	\$ 700.00	
	Concave Lip	AMX27519	\$ 65.00	
	Middle/Rear, Small Wire	AM1309207C3	\$ 695.00	
	Concave Set, Set of 3, Large Wire	AMB93574	\$ 1450.00	
	Front, Large Wire	AM193782C6	\$ 730.00	
	Concave Lip	AMX27519	\$ 65.00	
	Middle/Rear, Large Wire	AM193783C5	\$ 520.00	

Case IH®—Combine

Application	Description	Part Number	Retail Price	Core
1640, 1644, 1660, 1666, 1670, 2144, 2166, 2366 Note: Concaves have built-in extension	Concave Set, Set of 3, Small Wire	AMB96130	\$ 1450.00	
	Front, Small Wire	AM430960A1	\$ 610.00	
	Concave Lip	AMX27516	\$ 70.00	
	Middle/Rear, Small Wire	AM430963A1	\$ 580.00	
	Concave Set, Set of 3, Large Wire	AMB96128	\$ 1300.00	
	Front, Large Wire	AM430964A1	\$ 530.00	
	Concave Lip	AMX27516	\$ 70.00	
	Middle/Rear, Large Wire	AM430965A1	\$ 495.00	
1640, 1644, 1660, 1666, 2144, 2166, 2344 ASN JJC0174451, 2366 ASN JJC0255001	Concave Set, Set of 3 Round Bar Replaces 87495745, 87495763	AM87299958	\$ 1556.31	
1680, 1682, 1688, 2188, 2377, 2388, 2577, 2588, 5088, 5130, 5140, 5150, 6088, 6130, 6140, 6150, 7088, 7130, 7140, 7150 Note: Concaves have built-in extension	Concave Set, Set of 3, Small Wire	AMB96127	\$ 1650.00	
	Front, Small Wire	AM418647A1	\$ 710.00	
	Concave Lip	AMX27515	\$ 80.00	
	Middle/Rear, Small Wire	AM418648A1	\$ 695.00	
	Concave Set, Set of 3, Large Wire	AMB96125	\$ 1450.00	
	Front, Large Wire	AM386188A1	\$ 635.00	
	Concave Lip	AMX27515	\$ 80.00	
	Middle/Rear, Large Wire	AM386189A1	\$ 615.00	
1680, 1682, 1688, 2188, 2377, 2388, 2577, 2588, 5088, 6088, 6130, 6140, 7088, 7130, 7140	Concave Set, Set of 3 Round Bar Replaces 412395A1, 87360523, 87456655	AM87298938	\$ 1745.00	
7010, 7120, 7230, 7240, 8010, 8120, 8130, 8230, 8240, 9120, 9130, 9230, AFX8010	Concave, Hardened	Right Hand AM86976414	\$ 380.00	
	Large Wire, (2) Required	Left Hand AM86976416	\$ 380.00	
7010, 7120, 7230, 7240, 7250, 8010, 8120, 8130, 8230, 8240, 8250, 9010, 9120, 9130, 9230, 9240, 9250, AFX8010	Concave, Hardened	Right Hand AM86976418	\$ 395.00	
	Small Wire, (2) Required	Left Hand AM86976420	\$ 395.00	
7010, 7120, 7230, 7240, 7250, 8010, 8120, 8130, 8240, 8250, 9010, 9120, 9130, 9230, 9240, 9250, AFX8010	Concave, Extended Wear	Right Hand AM87600863	\$ 385.00	
	Round Bar, (2) Required	Left Hand AM87600861	\$ 385.00	

Concaves—Helical

Application	Description	Part Number	Retail Price	Core
1640, 1644, 1660, 1670, 2144, 2166, 2366	Helical Concave, Front Narrow Space w/o Extension	AMCIHCH-1640-F	\$ 988.82	
1680, 1682, 1688, 2188, 2388, 2577, 2588	Helical Concave, Front Narrow Space w/o Extension	AM418647A1H	\$ 995.00	
7010, 7120, 7230, 8010, 8120, 8130, 8230, 9120, 9130, 9230, AFX8010	Helical Concave, Front	Right Hand AM86976414H	\$ 315.02	
	Corn and Bean	Left Hand AM86976416H	\$ 315.02	
7010, 7120, 7230, 7240, 7250, 8010, 8120, 8130, 8230, 8240, 8250, 9010, 9120, 9130, 9230, 9240, 9250, AFX8010	Helical Concave	Right Hand AM86976418H	\$ 650.00	
	Small Grain	Left Hand AM86976420H	\$ 650.00	

Case IH®—Combine

Concave Components

Application	Description	Part Number	Retail Price	Core
1440, 1460, 1470	Concave Cover Plate Will Fit OEM, Loewen and Helical Rotary Concaves	AMFPIHC-1440	\$ 54.04	
1640, 1644, 1660, 1666, 2144, 2166, 2344, 2366	Concave Cover Plate For 1-Piece Concaves w/o bolt-in Extension Will Fit OEM, Loewen and Helical Rotary Concaves	AMFPIHC-1640-1	\$ 55.71	
	Concave Cover Plate For 2-Piece Concaves w/ bolt-on Extensions Will Fit OEM, Loewen and Helical Rotary Concaves	AMFPIHC-1640	\$ 74.08	
1680, 1688, 2188, 2388	Concave Cover Plate For 1-Piece Concaves w/o bolt-in Extension Will Fit OEM, Loewen and Helical Rotary Concaves	AMFPIHC-1680-1	\$ 56.42	
	Concave Cover Plate For 2-Piece Concaves w/ bolt-on Extensions Will Fit OEM, Loewen and Helical Rotary Concaves	AMFPIHC-1680	\$ 70.93	
2577, 2588, 5088, 5130, 5140, 6088, 6130, 6140, 7088, 7130, 7140	Concave Support Plate Replaces 1318433C1, 1318433C2, 1318433C3	AM87627461	\$ 189.19	
7010, 7120, 7230, 7240, 8010, 8120, 8230, 8240, 9010, 9120, 9230, 9240, AFX8010	Concave Cover Plate	AM87748386	\$ 68.00	
7010, 7120, 7230, 8010, 8120, 8230, 9120, 9230	Front Module Curve Plate AR200 Steel Weld-In	AMX29152	\$ 355.00	
1640, 1644, 1666, 2144, 2166, 2366	Concave Extensions, Narrow - Set of 3	AMB94536	\$ 618.92	
	Concave Extensions, Wide - Set of 3	AMB94534	\$ 603.08	
1680, 1682, 1688, 2188, 2388	Concave Shock Kit	AMCSK-700	\$ 304.29	
7010, 7120, 8010, 8120, 9010, 9120, AFX8010	Potentiometer, Concave Position	AM86998035	\$ 61.00	

Rotor Bars—Standard Rotors

These rotor bars are for standard rotors. They are available in standard, hardened and chrome alloy. Sold and priced individually. Hardware is not included.



Application	Description	Part Number	Retail Price	Core
1420, 1440, 1460, 1480, 1620, 1640, 1644, 1660, 1666, 1670, 1680, 1688, 2144, 2166, 2188, 2344, 2366, 2388 (3) Required on 40 & 60 Series (4) Required on 20 & 80 Series	Toothed Rotor Bar	AM1302103C1	\$ 25.00	
1420, 1440, 1460, 1470, 1480, 1482, 1620, 1640, 1644, 1660, 1666, 1670, 1680, 1682, 1688, 2144, 2166, 2188, 2344, 2366, 2388, 2588 (3) Required on 40 & 60 Series (4) Required on 20 & 80 Series	Smooth Rotor Bar, 42" Long	Hardened AM1303038C2	\$ 28.00	
	Smooth Rotor Bar, 42" Long	Chrome AM1324580C1	\$ 126.01	

Rotor Bars—Specialty Rotors

These ductile bars meet or exceed OEM specifications. Most applications and crop conditions require bars with no spikes. Crops with excessive green material might require bars with spikes to prevent roping. Sold and priced individually.



Application	Description	Part Number	Retail Price	Core
1420, 1440, 1460, 1470, 1480, 1620, 1640, 1644, 1660, 1666, 1670, 1680, 1682, 1688, 2144, 2166, 2188, 2344, 2366, 2388, 2588	Specialty Rasp Bar w/ Spike	Hardened AM1309175C1	\$ 12.50	
		Chrome AM1968970C1	\$ 20.00	
5088, 5130, 5140, 5150, 6088, 6130, 6140, 6150, 7010, 7088, 7120, 7140, 7150, 7230, 7240, 7250, 8120, 8230, 8240, 8250, 9120, 9230, 9240, 9250, AFX8010	Specialty Rasp Bar w/o Spike Replaces 1309336C1 (Hardened)	Hardened AM84164540	\$ 12.00	
		Chrome AM278821A2	\$ 18.00	

Case IH®—Combine

Application	Description	Part Number	Retail Price	Core
5088, 5130, 5140, 5150, 6088, 6130, 6140, 6150, 7010, 7088, 7120, 7130, 7140, 7150, 7230, 7240, 7250, 8010, 8120, 8230, 8240, 8250, 9120, 9230, 9240, 9250	Rasp Bar w/ Spike For Small Diameter Rotor Replaces 47603368	Hardened AM87368806	\$ 38.46	
5140, 6140, 7010, 7120, 7140, 7230, 7240, 8010, 8120, 8230, 8240, 9010, 9120, 9230, 9240	Rasp Bar, Grain For Small Diameter Rotor	Hardened AM87368807	\$ 43.08	
1440, 1460, 1470, 1640, 1644, 1660, 1666, 1670, 2144, 2166, 2344, 2366 (3) Required on 40 & 60 Series	Helical Kicker Plate	Standard AM1317690C1 Chrome AM1968967C1	\$ 95.38 \$ 127.50	
1480, 1482, 1680, 1682, 1688, 2188, 2377, 2388, 2588, 5088, 5130, 5140, 6088, 6130, 6140, 7010, 7088, 7120, 7130, 7140, 7230, 7240, 8010, 8120, 8230, 8240, 9120, 9230, 9240 (2) Required on 80 Series	Helical Kicker Plate Replaces 86992048	Hardened AM1327676C1	\$ 49.00	
1480, 1482, 1680, 1682, 1688, 2188, 2377, 2388, 2588, 5088, 5130, 6088, 6130, 7010, 7088, 7120, 7130, 7230, 8010, 8120, 8230, 9120, 9230 (2) Required on 80 Series	Helical Kicker Plate Replaces 86992048	Tungsten Carbide AM1968968C2	\$ 130.27	
1420, 1440, 1460, 1470, 1480, 1620, 1640, 1644, 1660, 1666, 1670, 1680, 1682, 1688, 2144, 2166, 2188, 2344, 2366, 2377, 2388, 2577, 2588, 5088, 6088, 7010, 7088, 7230, 8010, 8120, 8230, 9120, 9230 (2) Required on 1620 (3) Required on 40 & 60 Series (4) or (8) Required on 80 Series	Straight Separator Rotor Bar w/o Hardware Replaces 86992047	Standard AM1318976C1 Chrome AM1968969C2	\$ 45.00 \$ 110.00	
5088, 5130, 5140, 6088, 6130, 6140, 7010, 7088, 7120, 7130, 7140, 8010, 8120, 9010, 9120	Rotor Bar Straight Shoe, Small Grain Small Tube, Abrasion Resistant 22.638" ID	AM87602594	\$ 46.77	
5088, 5130, 5140, 6088, 6130, 6140, 7088, 7130, 7140	Extension, Inlet Flighting	AM84162517	\$ 82.00	
	Extension, Intermediate Replaces 87386468	AM84162516	\$ 56.00	
1420, 1440, 1460, 1470, 1480, 1620, 1640, 1644, 1660 BSN JJC0038346, 1666, 1670, 1680, 1682, 1688, 2144, 2166, 2188, 2344, 2366, 2388 BSN JJC0272999, 5130, 5140, 6130, 6140, 7130, 7140, 7230, 7240, 8230, 8240, 9230, 9240	Rotor Bar Bolt 1/2"-13 x 1 1/4" Flanged Hex Bolt, Grade 8	AM87302717	\$ 1.50	
	Rotor Bar Nut 1/2" NC Flanged Hex Nut, Self-Locking, Grade 8	AM186852C1	\$ 1.00	
2366, 2377, 2388, 2577, 5088, 5130, 5140, 6088, 6130, 6140, 7010, 7088, 7120, 7130, 7140, 7230, 7240, 8010, 8120, 8230, 8240, 9120, 9230, 9240, AFX8010 - w/ Metric Hardware	Rotor Bar Bolt M12x35 mm, 10.9 Grade, Full Thread	AM86981487	\$ 1.70	

Rotor Grates and Components

Slotted grates perform well under grain harvesting conditions, while the keystack grates are better for corn, soybeans, rice and milo. The shredder grate replaces the rear grate and has a unique keystack grate and blade system that will thoroughly shred the stalks. Installation requires less than an hour and is an alternative to purchasing a more expensive straw chopper.



Application	Description	Part Number	Retail Price	Core
1420, 1620	Rotor Grates, Keystack - Set of 3 OEM Style	AM1303002C3	\$ 655.00	
1440, 1460, 1640, 1644, 1660, 1666, 2144, 2166, 2344, 2366	Rotor Grates, Keystack - Set of 3 OEM Style	AM1302562C1	\$ 665.00	
	Rotor Grates, Slotted - Set of 3	AM191538C3	\$ 675.00	

Case IH®—Combine

Application	Description	Part Number	Retail Price	Core
1480, 1482, 1680, 1682, 1688, 2188, 2388, 2588, 5088, 6088, 6130, 7088, 7130	Rotor Grates, Keystock - Set of 3 OEM Style	AMB95337	\$ 730.00	
	Rotor Grates, Slotted - Set of 3	AMB95336	\$ 795.00	
7010, 7120, 8010, 8120, 9120, AFX8010	Rotor Grate, Slotted, Right Hand (2) Required Replaces 84247318	AM87000774	\$ 429.61	
	Rotor Grate, Slotted, Left Hand (2) Required Replaces 84247317	AM87000772	\$ 453.46	
1440, 1460, 1640, 1644, 1660, 1666, 2144, 2166, 2344, 2366	Rotor Grate Cover Plate Replaces 1319750C1	AMCPGIHC-1440	\$ 68.23	
1480, 1680, 1688, 2188, 2388	Rotor Grate Cover Plate Replaces 1319405C1	AMCPGIHC-1480	\$ 70.12	
1440, 1460, 1470, 1480, 1482, 1640, 1644, 1660, 1666, 1680, 1682, 2144, 2166, 2188, 2344, 2366, 2388	Channel for Slotted Grates Individual Channel, Hardware Not Included	AM191536C1	\$ 6.00	

Impeller Blade Kits (Elephant Ears)

Elephant Ears/Blade Kits are manufactured with abrasive-resistant steel for longer wear. High-strength, grade 8 hardware included. Hard chrome available upon request.



Application	Description	Part Number	Retail Price	Core
1420, 1620	Impeller Blade Kit (Elephant Ears) Set of 2 Blades w/ Hardware	AM1957447C2	\$ 295.00	
1440, 1460, 1640, 1644, 1660, 1666, 2144, 2166, 2344, 2366	Impeller Blade Kit (Elephant Ears) Set of 3 Blades w/ Hardware	AM1957446C3E	\$ 520.00	
1480, 1482, 1680, 1682, 1688, 2188, 2388, 2588	Impeller Blade Kit (Elephant Ears) Set of 2 Blades w/ Hardware	AM1957445C3E	\$ 325.00	
1480, 1482, 1680, 1682, 1688, 2188, 2388, 2588	Impeller Blade Kit (Elephant Ears) Set of 2 Chrome Blades w/ Hardware	AM195445C3EC	\$ 621.29	
1480, 1680, 1688, 2188, 2388, 2588, 5088, 6088, 7088 - w/ AFX Rotor	Impeller Blade Kit (Elephant Ears) Set of 2 Blades w/ Hardware	AM434525A3	\$ 470.00	
2366 w/ AFX Rotor	Impeller Blade Kit (Elephant Ears) Set of 2 Blades w/ Hardware	AM87308133	\$ 603.97	
7010, 7120, 7230, 7240, 8010, 8120, 8230, 8240, 9010, 9120, 9230, 9240, AFX8010	Impeller Blade Kit (Elephant Ears) Includes (2) Impeller Blades, (2) Wear Bars and Hardware Replaces 48119581, 84084819, 87315733, 87376706	AM87715003	\$ 695.00	

Wear Bars

Wear bars are made of hardened, abrasive-resistant steel for longer wear. They are easy to install, and high-strength grade 8 hardware is included. Wear bars are available in regular or large size to cover more of the blade (elephant ear) and protect it from excessive wear.

Application	Description	Part Number	Retail Price	Core
60 Series	Wear Bar Kit, KRF	AMX27188	\$ 335.00	
80 Series	Wear Bar Kit, KRF	AMX27189	\$ 310.00	
1420, 1620	Wear Bars, Set of 2	Chrome AM1309185C2	\$ 105.00	
1440, 1460, 1640, 1644, 1660, 1666, 2144, 2166, 2344, 2366	Wear Bars, Set of 3	Hardened AMB94524	\$ 127.00	
		Chrome AMB94525	\$ 205.00	
1480, 1482, 1680, 1682, 1688, 2188, 2388	Wear Bars, Set of 2	Hardened AMB94526	\$ 100.00	
		Chrome AMB94527	\$ 160.00	
6140, 7010, 7120, 7140, 7230, 7240, 8010, 8120, 8230, 8240, 9120, 9230, 9240, AFX8010	Wear Bars, Set of 2 Replaces 87297735, 87297735A	AM87376702	\$ 150.00	

Prices Subject to Change without Prior Notice. The use of original equipment manufacturer (OEM) part numbers or trademarks, e.g. Case® and John Deere®, are for reference purposes only and for indicating product use and compatibility. Our company and the listed replacement parts contained herein are not sponsored, approved or manufactured by the OEM. All parts are New unless designated Reman in the description.

Case IH®—Combine



Rotor Transition Cones and Components

Rotor cones are made of abrasive-resistant steel. The 5/32" cone with one welded seam compares to OEM 3 or 5 seam cones. The 3/16" cone with one welded seam compares to OEM rice cones. The 1/4" cone with one welded seam does not have an OEM comparison.

Application	Description	Part Number	Retail Price	Core
1420, 1620	Rotor Transition Cone Vane Kit - 3/16" Set of 6 Includes Mounting Hardware	AMCPRK-1420	\$ 234.59	
1440, 1460, 1640, 1660, 1644, 1666, 2144, 2166, 2344, 2366	Rotor Transition Cone Vane Kit - 1/8" Complete set of vanes and hardware	AMB93193	\$ 252.31	
	Rotor Transition Cone Vane Kit - 3/16" Complete set of vanes and hardware	AM87328881	\$ 248.38	
1440, 1460, 1640, 1644, 1660, 1666, 2144, 2166, 2344, 2366	Rotor Transition Cone Vane Kit - 3/16", Stainless Steel Complete set of vanes and hardware, Includes wear resistant T-bolts	AM321933A1	\$ 561.54	
1480, 1482, 1680, 1682, 1688, 2188, 2388	Rotor Transition Cone Vane Kit - 3/16" Complete set of vanes and hardware	AM437319A2	\$ 315.38	
1480, 1482, 1680, 1682, 1688, 2188, 2388	Rotor Transition Cone Vane Kit - 3/16", Stainless Steel Complete set of vanes and hardware, Includes wear resistant T-bolts Cones w/ 5/16" holes must be drilled out for 3/8" bolts	AM428875A2	\$ 738.46	
7010, 7120, 7230, 7240, 8010, 8120, 8230, 8240, 9230, 9240	Rotor Transition Cone Vane Kit - 3/16", Stainless Steel Complete set of vanes and hardware	AM87298773	\$ 495.00	
1440, 1460, 1470, 1640, 1644, 1660, 1666, 1670, 2144, 2166, 2344, 2366	Front Cone Vane, Upper	AM186985C3	\$ 40.40	
1440, 1460, 1470, 1620, 1640, 1644, 1660, 1666, 1670, 2144, 2166, 2344, 2366	Cone Vane Extension	AM186984C1	\$ 16.98	
7010, 7120, 7230, 7240, 8010, 8120, 8230, 8240, 9120, 9230, 9240, AFX8010	Rotor Transition Cone Vane, Stainless Steel (5) Required Replaces 87350845	AM87053359	\$ 80.00	
1440, 1460, 1640, 1660, 1644, 1666, 2144, 2166, 2344, 2366	Rotor Transition Cone 1/4" Wall Thickness, Includes 3/16" vanes	AMB92770	\$ 2023.07	
1480, 1482, 1680, 1682, 1688, 2188, 2388, 2588, 5088, 6088, 7088	Rotor Transition Cone 1/4" Wall Thickness, Includes 3/16" vanes	AM443123A1	\$ 1675.00	
7010, 7120, 7230, 7240, 7250, 8010, 8120, 8230, 8240, 8250, 9120, 9230, 9240, 9250, AFX8010	Rotor Transition Cone Extended Wear, Rice Includes 3/16" Stainless Steel Vanes Replaces 47843259, 84598183, 87053359, 87382439	AM87390937E	\$ 2900.00	
	Transition Cone Guard Set of 5 Panels 10-Gauge Abrasion-Resistant Steel Bolt-In w/ Pre-Drilled Holes	AMX29087	\$ 1600.00	
7010, 7120, 7230, 7240, 8010, 8120, 8230, 8240, 9010, 9120, 9230, 9240	Transition Cone Deflector, Right Hand Standard Wear Replaces 86980992, 87281152, 87324947	AM87524461	\$ 435.00	
	Transition Cone Deflector, Left Hand Standard Wear Replaces 86976155, 87281151, 87324946	AM87524460	\$ 410.00	
7010, 7120, 7230, 7240, 8010, 8120, 8230, 8240, 9010, 9120, 9230, 9240, AFX8010	Transition Cone Deflector, Right Hand Extended Wear Replaces 87281152, 87385250	AM87517351	\$ 567.93	
	Transition Cone Deflector, Left Hand Extended Wear Replaces 87354969, 87524460	AM87517350	\$ 526.64	

Case IH®—Combine

Application	Description	Part Number	Retail Price	Core
2366, 2377 SN HAJ292001-HAJ300000, 2388, 2577, 2588, 5088, 5130, 5140, 6088, 6130, 6140, 7088, 7130, 7140	Stiffener Vane - 3/16" Short Extension, Stainless Steel For Transition/Rotor Cone Replaces 411517A2	AM411518A2	\$ 21.96	
	Stiffener Vane - 3/16" Stainless Steel For Cone, Short Replaces 418655A1	AM418655A2	\$ 73.70	
	Stiffener Vane - 3/16" Stainless Steel For Cone, Front Replaces 418654A1	AM418654A2	\$ 95.05	
1680 BSN JJC0045689, 1688, 2188, 2377 SN HAJ292001-HAJ300000, 2388, (2577, 2588 ASN HAJ300001), 5088, 5130, 5140, 6088, 6130, 6140, 7088, 7130, 7140	Rotor Front Door Standard Wear Replaces 182974C93, 193607C1, 193607C2	AM193607C3	\$ 202.11	
7010, 7120, 7230, 7240, 8010, 8120, 8230, 8240, 9120, 9230, 9240	Transition Cone Door Liner Extended Wear, AR200 Steel	AMX29150	\$ 573.00	
7010, 7120, 7230, 7240, 7250, 8010, 8120, 8230, 8240, 8250, 9120, 9230, 9240, 9250	Rotor Access Door Liner Weld-In	AMX29177	\$ 573.00	

Vane Transports and Components

Made from abrasive-resistant steel for longer wear. Consider increasing the capacity of your 1400 Series by installing 1600 Series transition cones, concaves, concave support kits and tubes.



Application	Description	Part Number	Retail Price	Core
1420, 1620	Vane Transport Vane Kit Replaces 183295C1, 194192C2, 1303059C1	1/8" AMCPVK-1420	\$ 183.08	
1440, 1460, 1640, 1644, 1660, 1666, 2144, 2166, 2344, 2366	Vane Transport Vane Kit Complete set of vanes and hardware	1/8" AMB94097	\$ 256.70	
	Vane Transport Vane Kit, Stainless Steel Complete set of vanes and hardware Includes wear resistant T bolts	3/16" AMCPVK-1440-3 3/16" AMB95480	\$ 205.00 \$ 525.00	
1480, 1482, 1680, 1682, 1688, 2188, 2388, 2588	Vane Transport Vane Kit Complete set of vanes and hardware	1/8" AMB94098	\$ 240.00	
	Vane Transport Vane Kit Complete set of vanes and hardware	3/16" AM87297171	\$ 380.00	
1480, 1482, 1680, 1682, 1688, 2188, 2388	Vane Transport Vane Kit, Stainless Steel Complete set of vanes and hardware Includes wear resistant T bolts	3/16" AM348503A1	\$ 450.00	
1640, 1644, 1660, 1666, 2144, 2166, 2344, 2366	Vane Transport Less Vanes	Right Hand AM1318419C2 Left Hand AM1318829C2	\$ 585.00 \$ 650.00	
1680, 1682, 1688, 2188, 2388, 2588, 5088, 5130, 5140, 6088, 6130, 6140, 7088, 7130, 7140	Vane Transport Less Vanes	Right Hand AM1321661C3 Left Hand AM1318729C5	\$ 545.00 \$ 550.00	
7010, 7120, 7230, 7240, 8010, 8120, 8230, 8240, 9120, 9230, 9240, AFX8010	Vane Transport Extended Wear, Includes Vanes Replaces 87341408, 86980999	AM87391297	\$ 2600.00	
7010, 7120, 7230, 7240, 8010, 8120, 8230, 8240, 9120, 9230, 9240, AFX8010	Vane For Vane Transport, (11) Required Replaces 87341038	AM87717924	\$ 31.53	
	Vane For Vane Transport, (1) Required	AM87107892	\$ 36.00	
7010, 7120, (7230, 8230, 9230 BSN YDG220143), 8010, 8120, 9010, 9120	Vane Transport	AM87717923	\$ 30.00	

Case IH®—Combine

Application	Description	Part Number	Retail Price	Core
7230, 7240, 8230, 8240, 9230, 9240	Vane, Rear For Rotor Cage	AM84594130	\$ 230.00	
1480, 1482, 1680, 1688, 2188, (2377, 2388 SN HAJ292001-HAJ300000), 2577, 2588	Vane Transport Support, Stainless Steel Replaces 186075C1, 191272C1	3/16" AM186075C2	\$ 14.39	
7010, 7120, 7230, 7240, 7250, 8010, 8120, 8230, 8240, 8250, 9120, 9230, 9240, 9250	Vane Transport Cover Plate Liner 10-Gauge AR450 Steel	AMX29180	\$ 495.00	
2377 SN HAJ292001-HAJ300000, 2388, 2577, 2588, 5088, 5130, 5140, 6088, 6130, 6140, 7088, 7130, 7140	Stiffener Vane Extended Wear, Stainless Steel	3/16" AM347917A1	\$ 30.55	

Rotor Assemblies and Components

Our AFX Rotors are dynamically balanced at high speed and feature hardened bars to increase capacity.



Application	Description	Part Number	Retail Price	Core
1420, 1620	Rotor Assembly Specialty Rotor Replaces 1317404C93	AM87442191	\$ 3295.00	
1440, 1460, 1640, 1644, 1660, 1666, 2144, 2166, 2344, 2366	Reman Rotor Assembly	Hardened Bars	AMX27272	\$ 4295.00 \$ 500.00
		Hardened Spike Bars	AMX27273	\$ 4295.00 \$ 500.00
1480, 1680, 1688, 2188, (2388, 2588 BSN HAJ303001)	Reman Rotor Assembly, MY2008	Hardened Bars	AMX27282	\$ 4995.00 \$ 500.00
		Hardened Spike Bars	AMX27275	\$ 4995.00 \$ 500.00
1640, 1660, 1670, 1680, 1688, 2144, 2166, 2188, 2344, 2366, 2377, 2388, 2577, 2588	Rotor Drive Coupling Assembly	AM1345307C1	\$ 245.00	
2144, 2166, 2188	Rotor Drive Coupler Kit Heavy Duty Includes Rotor Drive Hub, Plate, (6) Bolts and (12) Washers	AM140500A1	\$ 150.00	
2388 ASN 300001, 2577, 2588, 5088, 5130, 5140, 5150, 6088, 6130, 6140, 6150, 7088, 7130, 7140, 7150	Rotor Drive Coupling, 8-Bolt 23 Spline	AM87619364	\$ 465.00	
7010, 7120, 7230, 7240, 7250, 8010, 8120, 8230, 8240, 8250, 9010, 9120, 9230, 9240, 9250	Rotor Drive Coupling, 8-Bolt 12 Tooth For Small Grain Rotor Assemblies (Standard and Hard Threshing) and Twin Pitch Corn, Grain and Rice (Standard and High Performance) Replaces 7280751	AM84222993	\$ 350.00	
7010, 7120, 7230, 8010, 8120, 8230, 9010, 9230, AFX8010	Rotor Drive Coupling, Splined For Dual Speed Rotor Drive	AM86980985	\$ 75.00	

Rotor Front Kits and Components

Improve the performance of your Case IH® rotary combine with the addition of a KRF Rotor Flight Kit. Both styles offer you improved threshing performance, better distribution and consistent flow of material for smoother operation, while providing reduced horsepower requirements for increased fuel efficiency.



Application	Description	Part Number	Retail Price	Core
1440, 1460, 1640, 1660, 1666, 2144, 2166, 2344, 2366	KRF Front Rotor Kit	AMX27135	\$ 1395.00	
1480, 1680, 1688, 2188, 2388, 2588	KRF Front Rotor Kit	AMX27134	\$ 1225.00	



Case IH®—Combine

	Application	Description	Part Number	Retail Price	Core
	1440, 1460, 1470, 1480, 1482, 1640, 1644, 1660, 1666, 1670, 1680, 1682, 1688, 2144, 2166, 2188, 2344, 2366	Rotor Gearbox Output Shaft	AM194059C1	\$ 803.11	
	1420, 1440, 1460, 1470, 1480, 1620, 1640, 1660, 1666, 1670, 1680, 1688, 2144, 2166, 2188, 2344, 2366, 2377, 2388	Rotary Bearing Housing Includes Bearing Replaces 251439A3, 87474830, 1309076C1	AM253439A3	\$ 270.00	
	1480, 1482, 1680, 1682, 1688, 2188, 2377 SN HAJ292001-HAJ300000, 2388, 2577, 2588, 5088, 5130, 5140, 6088, 6130, 6140, 7088, 7130, 7140	Lower Rotor Cage Seal Support	AM192385C1	\$ 140.34	
	1680, 1682, 1688, 2188, 2388	Rotor Gearbox Cover	AM182550C2	\$ 410.00	
	1680, 1688, 2188, 2377, 2577, 2588, 5088, 5130, 5140, 6088, 6130, 6140, 7088, 7130, 7140 - w/ AFX Rotor	KFX Rotor Flight Set of 2, Replaceable cast chrome wear plates Includes wear plates, mounting hardware and instructions	AMX27311	\$ 895.00	
	(2377, 2388 BSN HAJ0295001)	Rotor Drive Input Shaft	AM235575A2	\$ 1100.00	
	2377, 2388 ASN JJC0273000, 2577, 2588, 5130, 6088, 6130, 7088, 7130	Pulley Assembly 20.50" OD, For Variable Rotor Drive	AM413164A1	\$ 413.00	
	1620 ASN JJC0022108, 1640, 1644, 1660 ASN JJC0026711, 1666, 1680, 1688, 2144, 2166, 2188, 2344, 2366, 2377, 2388, 2577, 2588, 5088, 5130, 5140, 5150	Rotor Drive Pulley Hub 20 Tooth, 13 Spline, 11.73" Long Replaces 1315291C1, 1315291C2	AM184489C1	\$ 527.00	
	2377 SN HAJ292001-HAJ300000, 2388 BSN JJC0276540 & SN HAJ292001-HAJ300000	Output Gear 58 Tooth Replaces 235581A1	AM235581A2	\$ 475.00	
	1420, 1440, 1460, 1470, 1480, 1620, 1640, 1644, 1660, 1666, 1670, 1680, 1688	Motor, Rotor Speed Adjustment Wire Plugs in Back	AM126573C1	\$ 85.00	
	1420, 1440, 1460, 1470, 1480, 1620, 1640, 1644, 1660, 1666, 1670, 1680, 1688, 2144, 2166, 2188, 2344, 2366, 2388, 2577, 2588	Motor, Rotor Speed Adjustment Wire Plugs in Bottom	AM111787A2	\$ 66.00	
	(2577, 2588 ASN HAJ303001), 5088, 5130, 6088, 6130, 7088, 7130	Fan Speed Actuator	AM87693674	\$ 78.00	
	7010, 7120, 7230, 7240, 7250, 8010, 8120, 8230, 8240 09/2015 and Later, 8250, 9010, 9120, 9230, 9240, 9250, AFX8010	Rotor Impeller Shield	AM87315598	\$ 6.00	
	1640, 1644, 1660, 1666, 1670, 1680, 1688, 2144, 2166, 2188, 2344, 2366, 2377, 2388, 2577, 2588	Rubber Insulator For Rotor Drive Hub	AM1345453C1	\$ 9.50	

Case IH®—Combine

Application	Description	Part Number	Retail Price	Core
 1440, 1460, 1480, 1620 ASN JJC0032629, 1640, 1644, 1660, 1666, 1680, 1688, 2144, 2166, 2188, 2344, 2366, 2377, 2388, 2577, 2588, 5088, 5130, 5140, 5150, 6088, 6130, 6140, 6150, 7088, 7130, 7140, 7150	Roller Chain, Rotor Speed Adjustment 34 Links, Size 2040 Chain Replaces B617107R91	AM617107R91	\$ 40.00	
 1620 BSN JJC0032631	Roller Chain, Rotor Speed Adjustment 32 Links, Size 2040 Chain	AMX34133	\$ 20.00	

Rotor Vane Repair Kits

- Decreases material stalling at transition
- Increases ground speed
- Bolt-on style, no modifications required - works with all crops
- Improves crop material feeding with ALL styles of impellers and flights
- Restores vane to original height



Application	Description	Part Number	Retail Price	Core
60 Series	Rotor Vane Kit, Bolt-On - Set of 3	AMX27190	\$ 360.00	
80 Series	Rotor Vane Kit, Bolt-On - Set of 4	AMX27191	\$ 395.00	

Cleaning Fan Shafts and Components



Application	Description	Part Number	Retail Price	Core
1420, 1440, 1460, 1470, 1480, 1482, 1620, 1640, 1660, 1666, 1670, 1680, 1682, 1688, 2144, 2166, 2188, 2344, 2366, 2388, 2588, 5130, 5140, 6130, 6140, 7130, 7140	Cleaning Fan Hub Assembly	AM185286C91	\$ 90.00	
1660, 2344, 2366, 2377, 2388, 2577, 2588, 5130, 6130, 7130	Cleaning Fan Hub Assembly 1.75" ID, 11.91" OD Replaces 84556153	AM1541552C2	\$ 131.50	
1420, 1440, 1460, 1470, 1480, 1482, 1620, 1640, 1644, 1660, 1666, 1670, 1680, 1682, 1688, 2144, 2166, 2188, 2344, 2366, 2377 SN HAJ292001- HAJ300000, 2388, 2577, 2588, 5088, 5130, 5140, 6088, 6130, 6140, 7088, 7130, 7140	Cleaning Fan Shaft 10" Long Replaces 194853C1, 194853C2	AM194853C3	\$ 95.00	
1440 ASN 10001, 1460 ASN 12001, 1470, 1640, 1660, 1670	Cleaning Fan Shaft	AM1309016C1	\$ 321.90	
1440 SN 1501-10000, 1460 SN 1501-12000	Cleaning Fan Shaft	AM183445C2	\$ 84.25	
1480 BSN 14000	Cleaning Fan Shaft	AM191923C2	\$ 108.06	
1480 ASN 24852, 1680	Cleaning Fan Shaft	AM1309015C1	\$ 452.31	
2144, 2166, 2188, 2344, 2366, 2377, 2388	Cleaning Fan Shaft Adjusting Gear	AM142848A1	\$ 68.00	
1420, 1440, 1460, 1470, 1480, 1482, 1620, 1640, 1644, 1660, 1666, 1670, 1680, 1682, 1688, 2144, 2166, 2188, 2344, 2366, 2388	Cleaning Fan Pulley, Variable Speed 2" ID, 11.87" OD	AM183288C1	\$ 37.00	
1420, 1440, 1460, 1480, 1620, 1640, 1644, 1660, 1666, 1680, 1688, 2144, 2166, 2188, 2344, 2366, 2377, 2388, 2588, 5130, 5140, 5150, 6088, 6130, 6140, 6150, 7088, 7130, 7140, 7150	Cleaning Fan Drive Pulley 9.75" OD	AM193948C1	\$ 62.00	

Case IH®—Combine

Application	Description	Part Number	Retail Price	Core
1420, 1440, 1460, 1470, 1480, 1482, 1620, 1640, 1644, 1660, 1666, 1670, 1680, 1682, 1688, 2144, 2166, 2188, 2344, 2366, 2388, 5130, 5140, 6130, 6140, 7130	Cleaning Fan Drive Hub, Fixed	AM183333C1	\$ 100.00	
1480, 1680, 1688, 2188, 2377, 2577, 2588	Idler Arm, Jackshaft Fan Drive	AM194179C92	\$ 104.64	
1420, 1440, 1460, 1480, 1620, 1640, 1660, 1680	Half Sheave, Adjustable 11.24" OD w/o bushings	AM1324948C1	\$ 135.00	
1420, 1440, 1460, 1480, 1620, 1640, 1660, 1680	Half Sheave, Fixed 11.24" OD	AM1324949C1	\$ 87.00	
1640, 1644, 1660 ASN JJC0038346, 1680, 1688, 2144, 2166, 2188, 2344, 2366, 2377 SN HAJ292001-HAJ300000, 2388, 2577, 2588, 5088, 5130, 5140, 6088, 6130, 6140, 7088, 7130, 7140	Half Sheave, Fixed 1.75" ID, 11.90" OD Replaces 1541553C1, 1541553C2	AM87522943	\$ 165.92	
1420, 1440, 1460, 1470, 1480, 1620, 1640, 1644, 1660, 1666, 1670, 1680, 1688, 2144, 2166, 2188, 2344, 2366, 2388, 2577, 2588	Motor, Fan Speed Adjustment Wire Plugs in Bottom	AM111787A2	\$ 66.00	
1420, 1440, 1460, 1470, 1480, 1620, 1640, 1644, 1660, 1666, 1670, 1680, 1688	Motor, Fan Speed Adjustment Wire Plugs in Back	AM126573C1	\$ 85.00	
7010, 7120, 7230, 7240, 8010, 8120, 8230, 8240, 9010, 9120, 9230, 9240, AFX8010	Disc Replaces 86998413	AM86980769	\$ 37.00	
1420, 1440, 1460, 1480, 1620	Bearing, Cleaning Fan Shaft Replaces 610188R91, 70017774, K3315	AM565673R92	\$ 19.90	

Separator Gearbox Components

Application	Description	Part Number	Retail Price	Core
1420, 1440, 1460, 1480, 1620, 1640, 1644, 1660, 1666, 1670, 1680, 1688, 2144, 2166, 2188, 2344, 2366, 2377, 2388	Solid PTO Drive Shaft	AM192816C1	\$ 335.00	
1420, 1440, 1460, 1470, 1620, 1640, 1644, 1660, 1670, 2144, 2166, 2344, 2366	Hydraulic Cylinder For Separator Clutch 2" ID, 12.50" Stroke Replaces 133408C91, 133408C92	AM1346042C1	\$ 275.00	
1420, 1440, 1460, 1480, 1640 BSN 24223, 1660 BSN 26711, 1680 Early - w/o Chopper	Jackshaft	AM1308505C1	\$ 185.00	
1644, 1660 ASN JJC0038345, 1666, 1688, 2144, 2166, 2188, 2344, 2366, 2377, 2388, 2577, 2588	Drive Plate 13 Spline, 13.87" OD Replaces 92590C1, 92590C2, 1251902C1, 1251902C2, 184429C1, 188013C91, 230233A1	AM184429C2	\$ 135.00	
1660 Late, 1666, 2166, 2366	Separator Bevel Gear Set Includes 31 & 41 Tooth Gears	AM184494C1	\$ 675.00	
1688, 2188, 2388 BSN JJC0276540, 2588	Pulley	AM1541713C1	\$ 475.00	
2144, 2166, 2188, 2344, 2366, 2377 SN HAJ292001-HAH300000, 2388, 5088, 5130, 6130, 7130	Bearing, Cam Follower Replaces 418732A1, 1315343C1	AM86582880	\$ 34.50	
2366, 2377 SN HAJ0292001-HAJ030000, 2388 BSN HAJ030000, 2577, 2588, 5088, 6088, 7088	Shaft, PTO Gearbox Replaces 87603645	AM87589086	\$ 895.00	
(2377, 2388 SN HAJ292001-HAJ300000), 2577, 2588	Pulley 11" Diameter	AM364019A2	\$ 395.00	
5088, 5130, 5140, 6088, 6130, 6140, 7088, 7130, 7140	Pulley	AM87624862	\$ 444.00	
7010, 7120, 8010, 9010	Hydraulic Valve Control Pressure Regulator PTO Charge Regulator Replaces 87283362	AM87645689	\$ 420.00	

Prices Subject to Change without Prior Notice. The use of original equipment manufacturer (OEM) part numbers or trademarks, e.g. Case® and John Deere®, are for reference purposes only and for indicating product use and compatibility. Our company and the listed replacement parts contained herein are not sponsored, approved or manufactured by the OEM. All parts are New unless designated Reman in the description.

Case IH®—Combine

Separator Jackshafts, Sheaves and Components

Application	Description	Part Number	Retail Price	Core
1420, 1440, 1460, 1480, 1640 BSN 24223, 1660 BSN 26711, 1680 Early	Half Sheave, 1-Piece Assembly	AM193622C2	\$ 700.00	
1420, 1440, 1460, 1480, 1640 BSN 24223, 1660 BSN 26711, 1680 Early - w/o Chopper	Jackshaft	AM1308505C1	\$ 185.00	
1620 ASN JJC0022115, (1640 BSN JJC0024223 & ASN JJC034704, 1644, 1660 ASN JJC0026711, 1666 - w/o Straw Chopper), 1680 ASN JJC0028497, 1688, 2144, 2166, 2188, 2344, 2366, 2388	Hub Assembly, Rotor Drive Pulley	AM188846C2	\$ 303.00	
2344 ASN JJC0174451, 2366 ASN JJC0255001, 2377 SN HAJ0292001-HAJ0300000, 2388 ASN JJC0270501, 2577, 2588, 5088, 6088, 7088	Hub, Rotor Drive Variator 20 Spline Bore Replaces 47462117	AM87481453	\$ 342.04	
1420, 1440, 1460, 1480, 1620, 1640, 1644, 1660, 1666, 1680, 1688, 2144, 2166, 2188, 2344, 2366, 2377, 2388, 2588	Hub, Separator Drive Shaft	AM189419C1	\$ 92.41	
1420, 1440, 1460, 1480, 1620, 1640 BSN JJC0034705, (1640 ASN JJC0034704, 1644, 1660, 1666 - w/o Straw Chopper), 1680, 1688, 2144, 2166, 2188, 2344, 2366, 2377, 2388, 2577, 2588, 5130 w/ Non-Common Cab	Drive Hub, Separator Variable Speed	AM194394C1	\$ 131.00	
(2377, 2388 SN HAJ292001-HAJ300000), 2577, 2588	Pulley, Separator Driven 5-Groove, 3.507" ID, 14.75" OD	AM364320A2	\$ 260.16	
	Pulley, Separator Idler 1.8495" ID, 8" OD Requires Bearing and Snap Ring	AM87323202	\$ 110.77	
1420, 1440, 1460, 1470, 1480, 1620, 1640, 1644, 1660, 1666, 1670, 1680, 1688, 2144, 2166, 2188, 2344, 2366, 2377, 2388, 2577, 2588, 5130, 6088, 6130, 7088, 7130	Variator Pulley Sprocket 25 Tooth Replaces 194464C2, 194464C1	AM87678413	\$ 189.90	
1660, 2344, 2366, 2377, 2388 BSN JJC0276540, 2577, 2588, 5088, 5130, 5140, 6130, 7130	Jackshaft Thrust Bearing 2.75" ID, 4.481" OD, 0.88" Thick Replaces 194654C91	AM278927A1	\$ 50.00	
1640 ASN JJC0034705, 1666, 1688, 2144, 2166, 2188, 2344, 2366, 2377 SN HAJ292001-HAJ300000, 2388, 2577, 2588	Shaker Shaft Pitman Bearing Heavy Duty Drive	AM84435858	\$ 46.12	

Elevator Chains

Elevator chains include rubber paddles attached with 5/16" plated bolts and nuts (unless noted in the individual description). Chains feature full side plates for added strength.



Application	Description	Part Number	Retail Price	Core
815, 915	Clean Grain Elevator Chain 152 links - 7 5/8" x 2 3/4" paddles every 4th link	AM177453C91	\$ 168.44	
1420, 1620	Clean Grain Elevator Chain 149 links - 6 1/2" x 2 3/4" paddles every 4th link	AM186221C1	\$ 361.57	
	Rubber Paddle 6 1/2" x 2 3/4"	AM185333C1	\$ 3.19	
1440, 1460, 1470	Clean Grain Elevator Chain 149 links - 7 5/8" x 2 3/4" paddles every 4th link	AM1302201C91	\$ 255.00	
1480, 1482	Clean Grain Elevator Chain 160 links - 7 5/8" x 3 1/2" paddles every 4th link	AM1302195C91	\$ 270.00	
	Rubber Paddle 7 5/8" x 3 1/2"	AM1302197C1	\$ 4.36	
1640, 1644, 1660, 1666, 2144, 2166, 2344, 2366	Clean Grain Elevator Chain 152 links - 5 5/8" x 4" paddles every 4th link	AM1321334C92	\$ 265.00	
	Rubber Paddle 5 5/8" x 4"	AM1317480C2	\$ 7.50	

Case IH®—Combine

Application	Description	Part Number	Retail Price	Core
1680, 1682, 1688, 2188, 2377, 2388, 2577, 2588	Clean Grain Elevator Chain 152 links - 7 5/8" x 3 1/2" paddles every 4th link Replaces 87313692	AM1317482C92	\$ 265.00	
	Rubber Paddle 7 5/8" x 3 1/2"	AM1302197C1	\$ 4.36	
5088, 5130, 5140, 5150, 6088, 6130, 6140, 6150, 7088, 7130, 7140, 7150	Clean Grain Elevator Chain 154 Links Replaces 47717096, 87313692	AM87365387	\$ 285.00	
	Rubber Paddle 7 1/2" x 4"	AM1318493C2	\$ 4.45	
7010, 7120, 7230, 8010, 8120, 8230, 9120, 9230, AFX8010	Clean Grain Elevator Chain 145 links - 9 5/8" x 5" paddles every 4th link Last 2 paddles are every 6th link	AM87281911	\$ 375.00	
	Clean Grain Elevator Chain, Rubber Paddles 145 Links - 9 5/8" x 5" Rubber Paddles every 4th Link Last 2 Paddles are every 6th Link Heavy Duty w/ Steel Support Plate on Paddles	AM48089345	\$ 650.00	
	Rubber Paddle 9 5/8" x 5"	AM87282471	\$ 6.35	
1420, 1440, 1460, 1480, 1482, 1640, 1644, 1660, 1666, 1680, 1682, 1688, 2144, 2166, 2188, 2344, 2366, 2388, 2588, 5088, 5130, (5140, 6140, 7140 - Tier 4B 03/2014-10/15), 6088, 6130, 7088, 7130	Return Grain Elevator Chain 115 links - 5 5/8" x 2 3/4" paddles every 4th link	AM1303114C91	\$ 185.00	
	Rubber Paddle 5 5/8" x 2 3/4"	AM1303123C91	\$ 16.11	

Elevator Chain Sprockets

To extend the life of your chain assemblies, always replace the sprockets when installing a new chain.



Application	Description	Part Number	Retail Price	Core
815, 915 ASN 8001, 1420, 1480 ASN 14001	Clean Grain Elevator Chain Sprocket, Upper 7 Tooth, 1" Shaft Replaces 87691619	AM168683C1	\$ 35.00	
1420, 1440 BSN 10000, 1460 BSN 12001	Clean Grain Elevator Chain Sprocket, Upper 6 Tooth, 1" Shaft	AM165292C1	\$ 37.00	
1440, 1460 ASN 12001, 1480	Clean Grain Elevator Chain Sprocket, Upper 7 Tooth, 1.125" Shaft	AM1302200C1	\$ 40.00	
1640, 1644, 1660, 1666, 1680, 1688, 1682, 2144, 2166, 2188, 2344, 2366, 2388, 2588	Clean Grain Elevator Chain Sprocket, Upper 9 Tooth, 1.25" Shaft	AM1317192C2	\$ 48.00	
5088, 5130, 5140, 5150, 6088, 6130, 6140, 6150, 7088, 7130, 7140, 7150	Clean Grain Elevator Chain Sprocket, Upper 9 Tooth, 1.50" Shaft	AM87324981	\$ 60.00	
7010, 7120, 7230, 7240, 8010, 8120, 8230, 8240, 9120, 9230, 9240, AFX8010	Clean Grain Elevator Chain Sprocket, Upper 9 Tooth, 35 mm Round Bore Replaces 86998052	AM87283438	\$ 75.00	
715, 815, 915 ASN 8001, 1420, 1440 BSN 10000, 1460 BSN 12001	Clean Grain Elevator Chain Sprocket, Lower 6 Tooth, 1" Shaft	AM165292C1	\$ 37.00	
1440 ASN 10001, 1460 ASN 12001	Clean Grain Elevator Chain Sprocket, Lower 7 Tooth, 1" Shaft Replaces 87691619	AM168683C1	\$ 35.00	
1480 BSN 14001	Clean Grain Elevator Chain Sprocket, Lower 6 Tooth, 1.125" Shaft	AM186720C1	\$ 55.77	
1640, 1644, 1660, 1666, 1680, 1688, 2144, 2166, 2344, 2366	Clean Grain Elevator Chain Sprocket, Lower 9 Tooth, 1.25" Shaft	AM1317192C2	\$ 48.00	
2188, 2388, 2588	Clean Grain Elevator Chain Sprocket, Lower 9 Tooth, 1.375" Shaft	AM143960A1	\$ 36.00	

Case IH®—Combine

Application	Description	Part Number	Retail Price	Core
5088, 5130, 5140, 5150, 6088, 6130, 6140, 6150, 7088, 7130, 7140, 7150	Clean Grain Elevator Chain Sprocket, Lower 9 Tooth, 1.50" Shaft	AM87324981	\$ 60.00	
7010, 7120, 7230, 7240, 8010, 8120, 8230, 8240, 9120, 9230, 9240, AFX8010	Clean Grain Elevator Chain Sprocket, Lower 9 Tooth, 45 mm Round Bore Replaces 87283182, 86975226	AM87283436	\$ 75.00	
1420, 1440 BSN 10000, 1460 BSN 12001, 1480 BSN 14000	Return Grain Elevator Chain Sprocket, Upper 6 Tooth, 1" Shaft	AM165292C1	\$ 37.00	
1440 ASN 10001, 1460 ASN 12001, 1480 ASN 14001, 1640, 1644, 1660, 1666, 1680, 1688, 2144, 2166, 2188, 2344, 2366, 2388, 2588	Return Grain Elevator Chain Sprocket, Upper 7 Tooth, 1" Shaft Replaces 87691619	AM168683C1	\$ 35.00	
1480 BSN 14001	Return Grain Elevator Chain Sprocket, Upper 6 Tooth, 1.125" Shaft	AM186720C1	\$ 55.77	
715, 815, 915 ASN 8001, 1420, 1440 BSN 10000, 1460 BSN 12001	Return Grain Elevator Chain Sprocket, Lower 6 Tooth, 1" Shaft	AM165292C1	\$ 37.00	
1440 ASN 10000, 1460 ASN 12001	Return Grain Elevator Chain Sprocket, Lower 7 Tooth, 1" Shaft Replaces 87691619	AM168683C1	\$ 35.00	
1480 ASN 14001, 1680, 1688	Return Grain Elevator Chain Sprocket, Lower 7 Tooth, 1.125" Shaft	AM1302200C1	\$ 40.00	
2144, 2166, 2188, 2344, 2366, 2377, 2388, 2588, 5088, 6088, 7088	Return Grain Elevator Chain Sprocket, Lower 7 Tooth, 1.25" Shaft Replaces 87740180	AM144031A1	\$ 40.00	



Elevator Drive Sprockets and Components

Application	Description	Part Number	Retail Price	Core
2366 ASN JJC0184544, 2377 ASN HAJ0292001, 2388	Elevator Drive Sprocket Assembly 27 Tooth, 50 Chain, 1.25" Bore	AM296022A1	\$ 45.00	
1440, 1460, 1470, 1480, 1640, 1660, 1670, 1680, 1688, 2144, 2166, 2188, 2344, 2366, 2388 BSN JJC0276540	Elevator Drive Sprocket 25 Tooth	AM192139C2	\$ 45.00	
1440, 1460, 1480	Elevator Drive Sprocket 33 Tooth, 4 Bolt Holes, 2.25" ID, 6.92" OD	AM188189C1	\$ 18.00	
1460, 1470, 1480, 1482, 1640 BSN JJC0034705, 1660, 1670, 1680, 1682	Elevator Drive Sprocket 27 Tooth, For Size 50 Chain 2.25" ID, 5.723" OD	AM188188C1	\$ 18.00	
1640, 1660, 1670, 1680, 1688, 2144, 2166, 2188, 2366, 2388, 2577, 2588	Elevator Drive Sprocket 32 Tooth	AM1317412C1	\$ 50.00	
1640, 1660, 1670 ASN 80540, 1680 ASN 80540, 2366, 2388	Elevator Drive Sprocket 27 Tooth, For Size 50 Chain Replaces 1979808C1	AM1345472C1	\$ 50.00	
2144, 2166, 2188, 2344, 2366, 2388	Elevator Drive Sprocket 25 & 30 Tooth, 1.25" Bore, 2-Speed	AM182945A1	\$ 65.00	
2144, 2166, 2188, 2344, 2388, 5088, 5130, 5140, 6088, 6130, 6140, 7088, 7130, 7140	Return Grain Elevator Drive Sprocket, Upper 23 Tooth	AM84160043	\$ 58.00	
2366 ASN JJC0194544, 2377 ASN HAJ0292001, 2388, 2588	Elevator Drive Sprocket 27 & 32 Tooth	AM296023A1	\$ 70.00	
5088, 5130, (5140, 6140 - w/ Tier 4B Engine, 03/2014-10/15), 6088, 6130, 7088, 7130	Elevator Drive Sprocket 23 Tooth, Bubbler Driven	AM84167767	\$ 43.00	
5088, 5130, (5140, 6140 - w/ Tier 4B Engine, 03/2014-10/15), 6088, 6130, 7088, 7130, 7140	Elevator Drive Sprocket 23 & 27 Tooth	AM84159778	\$ 140.00	
	Elevator Drive Sprocket 27 Tooth, Driven	AM84163939	\$ 74.00	

Case IH®—Combine

Application	Description	Part Number	Retail Price	Core
5130, 5140, 6130, 6140, 7010, 7120, 7130, 7140, 7230, 7240, 8010, 8120, 8230, 8240, 9120, 9230, 9240, AFX8010 BSN HAJ105101	Elevator Drive Sprocket 15 Tooth	AM87283101	\$ 21.00	
7010, 7120, 7230, 7240, 8010, 8120, 8230, 8240, 9120, 9230, 9240, AFX8010	Elevator Drive Sprocket 22 Tooth Replaces 87108702, 86975916	AM87283695	\$ 32.00	
7010, 7120, 8010, 8120, 8230, 8240, 9120, 9230, 9240, AFX8010	Elevator Drive Sprocket 17 Tooth Replaces 87283677, 86999488	AM87731456	\$ 26.00	
7010, 7120, 7230, 8010, 8120, 8230, 8240, 9120, 9230, 9240, AFX8010	Elevator Driven Sprocket 37 Tooth, 1.182" Bore Replaces 86998172, 87108698, 87586562	AM87748377	\$ 75.00	
1440 ASN 40000, 1460 ASN 42001, 1470, 1480 ASN 44001, 1640, 1644, 1660, 1666, 1670, 1680, 1688, 2144, 2166, 2188, 2344, 2366, 2377, 2388, 2588, 5088, 6088, 7088 BSN Y9G001953	Elevator Jackshaft Clutch Plate Hub 3.53" Long, 1.25" Bore Diameter Replaces 1319232C1	AM198279A1	\$ 135.03	
1440, 1460, 1480, 1620, 1640, 1644, 1660, 1666, 1680, 1688, 2366, 2377, 2388, 2577, 2588	Elevator Jackshaft Drive Pulley 13" OD	AM183325C1	\$ 120.00	
403, 503, 615, 715, 815, 915, 1420, 1440, 1460, 1470, 1480, 1482, 1620, 1640, 1660, 1682, Platforms: 810, 820	Idler Sprocket 50 Chain, 17 Tooth, 0.50" ID	AM565442R91	\$ 15.38	
503, 1420, 1440, 1460, 1470, 1480, 1482, 1620, 1640, 1660, 1670, 1680	Idler Sprocket 60 Chain, 15 Tooth, 0.625" ID	AM629972R91	\$ 19.00	
1640, 1644, 1660, 1666, 2144, 2166, 2344, 2366	Idler Sprocket 17 Tooth, 0.755" Hex Bore	AM1319759C1	\$ 67.69	
2377, 2388, 2577, 2588, 5088, 6088, 7088	Idler Sprocket 17 Tooth Replaces 631905R91	AM103244	\$ 14.25	
503, 615, 715, 815	Idler Pulley, Flanged 1.312" Wide, 7" OD, 0.625" Bore Diameter	AM570265R91	\$ 33.27	
Most Models	Idler Pulley, V-Belt w/ 1/2" ID Sleeve 1.31" Wide, 7.31" OD, 0.635" Bore Diameter Replaces 673214C91, 86996213	IPCVI-117	\$ 25.00	
1440, 1460, 1470, 1480, 1482, 1640, 1644, 1660, 1666, 1670, 1680, 1682, 1688, 2144, 2166, 2188, 2344, 2366, 2377 SN HAJ292001-HAJ300001, 2388, 2577, 2588	Block For Elevator Drive Chain Tightener Replaces B95301, B512091	AM582018R1	\$ 7.96	
1440 BSN 10000, 1460 BSN 12001	Roller Chain, Clean Grain Elevator Drive 230 Links, Size 50 Chain	AMX34126	\$ 65.00	
1440 ASN 09999, 1460 ASN 11999 w/o Raised Level Auger	Roller Chain, Clean Grain Elevator Drive 260 Links, Size 50 Chain	AMX34127	\$ 70.00	
1460 ASN 11999 w/ Raised Level Auger	Roller Chain, Clean Grain Elevator Drive 284 Links, Size 50 Chain	AMX34128	\$ 75.00	
1620	Roller Chain, Clean Grain Elevator Drive 78 Links, Size 40 Chain	AMX34129	\$ 30.00	
1680 BSN JJC0045689	Roller Chain, Clean Grain Elevator Drive 266 Links, Size 50 Chain	AMX34130	\$ 70.00	
1680 ASN JJC0045688	Roller Chain, Clean Grain Elevator Drive 258 Links, Size 50 Chain	AMX34131	\$ 70.00	
(5088, 7088 ASN Y9G001954), 5130, (5140, 6140, 7140 - Prior to 10/2015), 6088 ASN Y9H001954, 6130, 7130	Roller Chain, Clean Grain Elevator Drive 224 Links, Size 60H Chain	AM84163936	\$ 80.00	
(5140, 6140, 7140 - 10/2015 and Later), 5150, 6150, 7150	Roller Chain, Clean Grain Elevator Drive 144 Links, Size 60H Chain	AM47709870	\$ 90.00	
7010, 7120, 7230, 7240, 7250, 8010, 8120, 8230, 8240, 8250, 9010, 9120, 9230, 9240, 9250, AFX8010 ASN HAJ105101	Roller Chain, Clean Grain Elevator Drive 104 Links, Size 60 Chain Replaces 87108801, 87584827	AM87470737	\$ 80.00	

Prices Subject to Change without Prior Notice. The use of original equipment manufacturer (OEM) part numbers or trademarks, e.g. Case® and John Deere®, are for reference purposes only and for indicating product use and compatibility. Our company and the listed replacement parts contained herein are not sponsored, approved or manufactured by the OEM. All parts are New unless designated Reman in the description.











Case IH®—Combine



Elevator Housings

Application	Description	Part Number	Retail Price	Core
1640, 1644, 1660, 1666, 2144, 2166, 2344, 2366	Clean Grain Elevator Housing	AM1317376C9	\$ 875.00	
1680, 1682, 1688, 2188, 2388, 2588 - w/o AFS	Clean Grain Elevator Housing	AM1317456C3	\$ 850.00	
	Clean Grain Elevator Housing Stainless Steel	AM1317456C3E	\$ 1600.00	
2366 w/ Advanced Farming System	Clean Grain Elevator Housing Replaces 367708A1, 367708A2, 367708A3	AM367708A4	\$ 1093.30	
2377 SN HAJ292001-HAJ300000, 2388 SN HAJ292001-HAJ300001, 2577, 2588 - w/ AFS	Clean Grain Elevator Housing Replaces 367308A1, 367308A2, 367308A4	AM367308A5	\$ 1110.09	
7010, 7120, 8010, 8120, 9120	Clean Grain Elevator Housing Extended Wear Replaces 87586570 (Standard Wear)	AM87586569	\$ 1700.00	
1440, 1460, 1470, 1660, 1666, 1670, 2144, 2166, 2344, 2366	Tailings Elevator Housing Replaces 191778C1	AM191778C2	\$ 763.93	
1480, 1482, 1680, 1682, 1688, 2188, 2377, 2388, 2577, 2588	Tailings Elevator Housing	AM87470913	\$ 715.00	



Elevator Housing Sheet Metal

Application	Description	Part Number	Retail Price	Core
 1640, 1644, 1660, 1666, 1670, 1682, 2144, 2166, 2344 BSN JJC0174359, 2366 BSN JJC0252949	Elevator Head Side Cover, Right Hand For Inclined Elevators	AM1321126C1	\$ 150.49	
 1660, 1666, 1680, 1688, 2144, 2166, 2188, 2344, 2366, 2577, 2588	Clean Grain Elevator Head Side Cover, Right Hand Standard Duty For Inclined Elevators	AM1319908C1	\$ 104.04	
 7010, 7120, 7230, 7240, 8010, 8120, 8230, 8240, 9120, 9230, 9240, AFX8010	Clean Grain Elevator Head Cover	AM87109213	\$ 256.70	
 2188, 2377, 2388, 2577, 2588	Elevator Head Cover, Front w/ Yield Monitor, w/ Advanced Farming System	AM238646A1	\$ 150.59	
 2188, 2377, 2388, 2577, 2588	Elevator Head Cover, Front w/o Yield Monitor, w/o Advanced Farming System	AM198602A1	\$ 235.00	
 1680, 1682, 1688, 2188	Sealing Plate	AM1321230C1	\$ 40.00	
 1680, 1688, 2188	Front Head Cover	AM1319941C1	\$ 95.00	
 1640, 1644, 1660, 1666, 1670, 2144, 2166, 2344, 2366	Rear Cover	AM1319942C1	\$ 45.00	
 1680, 1682, 1688, 2188, 2377, 2388, 2577, 2588	Inclined Elevator Head Rear Cover	AM1319940C1	\$ 46.00	
 1660, 1666, 1680, 1688, 2144, 2166, 2188, 2344, 2366, 2377, 2388, 2588	Rear Support Panel	AM1321551C2	\$ 52.00	
 1680, 1688, 2188, 2377, 2388, 2588	Rear Support Panel	AM1321550C2	\$ 45.00	

Case IH®—Combine





	Application	Description	Part Number	Retail Price	Core
	1680, 1688, 2188, 2377, 2388, 2577, 2588	Clean Grain Elevator Head Side Panel, Right Hand For Inclined Elevator	AM1321095C1	\$ 40.00	
	2144, 2166, 2188, 2344, 2377, 2388, 2588	Corn and Grain Cover	AM229609A2	\$ 45.00	
	1660, 1666, 1680, 1688, 2144, 2166, 2188, 2344, 2366, 2377, 2388, 2588	Auger Cover	AM1321097C2	\$ 32.00	
	1630, 1660, 1666, 1688, 2144, 2166, 2188, 2344, 2366, 2377, 2388, 2588	Auger U-Joint Cover	AM1321556C1	\$ 19.00	
	1660, 1666, 1680, 1688, 2144, 2166, 2188, 2344, 2366, 2377, 2388, 2588	Auger Bearing Support Plate	AM1979134C1	\$ 70.00	
	1660, 1666, 1680, 1688, 2144, 2166, 2188, 2344, 2366, 2377, 2388, 2588	Panel, Side Front	AM1321552C2	\$ 30.00	
	1680 Late, 2144, 2166, 2188, 2366, 2388	Clean Grain Elevator Front Side Panel, Left Hand Replaces 1321069C1	AM189456A1	\$ 43.00	
	(1644, 1666, 2144, 2166 Prior to 1996), (2344, 2366 1996 and Later)	Corn and Grain Cover, Narrow Replaces 84163887	AM224602A1	\$ 105.00	
	1688, 2188, 2388 - w/ AFS	Corn and Grain Cover, Wide	AM224603A1	\$ 55.00	
	2144, 2166, 2344, 2366	Corn and Grain Cover	AM198603A2	\$ 90.00	
	1680, 1682, 1688, 2188, 2377, 2388, 2588	Panel, Left Side	AM1321497C1	\$ 46.00	
	1660, 1666, 1680, 1688, 2144, 2166, 2188, 2344, 2366, 2377, 2388, 2577, 2588	Elevator Head Auger Mounting Support	AM1321060C1	\$ 64.00	
	1640, 1644, 1660, 1666, 1670, 1680, 1682, 1688, 2144, 2166, 2188, 2388, 2588	Head Shaft Support	AM1317251C2	\$ 41.43	
	1640, 1644, 1660, 1666, 1670, 1680, 1682, 1688, 2144, 2166, 2188, 2344, 2366, 2377, 2388, 2577, 2588	Clean Grain Elevator Head Side Panel, Left Hand For Horizontal or Inclined Elevator	AM1319901C1	\$ 65.66	
	1640, 1644, 1660, 1666, 1670, 2144, 2166, 2344, 2366	Clean Grain Elevator Door Perforated	AM1317841C1	\$ 80.00	
	1640, 1644, 1660, 1666, 1670, 2144, 2166, 2344, 2366	Grain Elevator Head Panel, Left Hand	AM1321496C1	\$ 50.00	
	1640, 1644, 1660, 1666, 2144, 2166, 2344 BSN JJC0174359, 2366 BSN JJC0252949	Grain Elevator Trough	AM1321130C1	\$ 148.97	
	1660, 1666, 1680, 1688, 2144, 2166, 2188, 2344, 2366, 2377, 2388, 2588	Upper Trough Panel	AM1321560C3	\$ 120.00	
	2144, 2166, 2188, 2344, 2366, 2377, 2388, 2588	Lower Trough Panel w/ Sensor Hole	AM199006A2	\$ 140.00	

Case IH®—Combine











Application	Description	Part Number	Retail Price	Core
 1660, 1666, 1680, 1688, 2144, 2166, 2188	Lower Tube Trough w/o Sensor Hole	AM1321557C2	\$ 160.00	
1420, 1440, 1460, 1620, 1640, 1644, 1660, 1666, 1680, 1688, 2144, 2166, 2188, 2344, 2366, 2377, 2388, 2577, 2588	Return Elevator Head Trough	AM188119C1	\$ 135.30	
1420, 1440, 1460, 1470, 1480, 1482, 1620, 1640, 1644, 1660, 1666, 1670, 1680, 1682, 1688, 2144, 2166, 2188, 2344, 2366, (2377, 2388 SN HAJ292001-HAJ300000), 2577, 2588	Return Elevator False Bottom Hinge Replaces 191790C1	AM191790C2	\$ 37.19	
 403, 503, 715, 815, 915, 1420, 1440, 1460, 1470, 1480, 1620, 1640, 1644, 1660, 1666, 1670, 1680, 1688, 2144, 2166, 2188, 2344, 2366, 2388, 2577, 2588	Tailings Elevator Door, Solid Replaces 184560C91	AM156910C1	\$ 45.66	
403, 503, 715, 815, 915, 1420, 1440, 1460, 1470, 1480, 1620, 1640, 1644, 1660, 1666, 1670, 1680, 1688, 2144, 2166, 2188, 2344, 2366, 2388, 2577, 2588	Tailings Elevator Door, Perforated Replaces 239997A1	AM174193C1	\$ 57.00	
 7010, 7120, 7230, 7240, 7250, 8010, 8120, 8230, 8240, 8250, 9010, 9120, 9230, 9240, 9250	Upper Impeller Blower, Tailings Processor Extended Wear Replaces 87341817	AM87549450	\$ 395.00	
 7010, 7120, 7230, 7240, 7250, 8010, 8120, 8230, 8240, 8250, 9010, 9120, 9230, 9240, 9250	Lower Impeller Blower, Tailings Processor Replaces 87282758, 87335467	AM87541978	\$ 250.00	
 7010, 7120, 7230, 7240, 7250, 8010, 8120, 8230, 8240, 8250, 9010, 9120, 9230, 9240, 9250, AFX8010	Upper Impeller Blower, Tailings Processor Replaces 87108642, 87335466, 87622761	AM87542137	\$ 243.00	
 7010, 7120, 7230, 7240, 7250, 8010, 8120, 8230, 8240, 8250, 9120, 9230, 9240, 9250, AFX8010	Tailings Processor Liner Kit Weld-In	AMX29174	\$ 857.00	

Clean Grain Elevator Boot Kits and Parts







Boot kits include outer and inner side boots, front and rear covers, deflector and non-perforated boot door. Kits also include nuts, bolts and washers to assemble the boot.

Application	Description	Part Number	Retail Price	Core
 1680, 1688	Clean Grain Elevator Boot Kit	AMX27123	\$ 350.00	
2188, 2388	Clean Grain Elevator Boot Kit w/ Yield Monitor	AMX27125	\$ 380.00	
2188, 2388	Clean Grain Elevator Boot Kit w/o Yield Monitor	AMX27124	\$ 350.00	
 (7010, 7120, 7230, 7240, 8010, 8120, 8230, 9120, 9230 BSN YDG222000)	Clean Grain Elevator Boot Liner Kit Weld-In	AMX29173	\$ 557.00	
 7010, 7120, 7230, 7240, 7250, 8010, 8120, 8230, 8240, 8250, 9120, 9230, 9240, 9250, AFX8010	Clean Grain Elevator Head Liner Kit Weld-In	AMX29172	\$ 771.00	
 1660, 1666, 1680, 1688, 2144, 2166, 2188, 2344, 2366, 2577, 2588	Clean Grain Elevator Head Side Cover, Right Hand Standard Duty For Inclined Elevators	AM1319908C1	\$ 104.04	

Case IH®—Combine

Application	Description	Part Number	Retail Price	Core
 2366, 2388, 2588	Clean Grain Elevator Head Side Plate, Right Hand Extended Wear, Stainless Steel	AM251458A1	\$ 276.92	
 1680, 1682, 1688, 2188, 2388, 2577, 2588	Clean Grain Elevator Boot Door Non-Perforated	AM1317430C1	\$ 73.85	
 1640, 1644, 1660, 1666, 1670, 2144, 2166, 2344, 2366	Clean Grain Elevator Door Solid	AM1317276C1	\$ 79.24	
 5088, 5130, 5140, 6088, 6130, 6140, 7088, 7130, 7140	Clean Grain Elevator Door	AM84149722	\$ 345.00	
 7010, 7120, 7230, 7240, 7250, 8010, 8120, 8230, 8240, 8250, 9120, 9230, 9240, 9250, AFX8010 ASN HAJ106401	Clean Grain Elevator Door	AM87282183	\$ 323.08	
1640, 1644, 1660, 1666, 1670, 2144, 2166, 2344, 2366	Clean Grain Elevator Boot Rear Cover	AM1317271C1	\$ 29.00	
 1680, 1682, 1688, 2188, 2377, 2388, 2577, 2588	Clean Grain Elevator Boot Rear Cover	AM1317437C1	\$ 55.00	
 5088, 5130, 5140, 6088, 6130, 6140, 7088, 7130, 7140	Clean Grain Elevator Boot Rear Cover	AM84149716	\$ 129.00	
 1680, 1682, 1688, 2188, 2388, 2577, 2588	Clean Grain Elevator Boot Front Cover	AM1317439C1	\$ 51.00	
 5088, 5130, 5140, 6088, 6130, 6140, 7088, 7130, 7140	Clean Grain Elevator Boot Front Cover	AM84171634	\$ 98.00	
 (5088, 6088, 7088, BSN Y9G002404)	Clean Grain Elevator Boot Front Cover Replaces 87329127	AM87329806	\$ 305.00	
 (7230, 8230, 9230 - w/ Common Cab ASN YDG222090), 7240, 7250, 8240, 8250, 9240, 9250	Clean Grain Elevator Boot End Cover Assembly	AM47557349	\$ 126.00	
 1680, 1682, 1688, 2188, 2388, 2577, 2588	Clean Grain Elevator Boot Bottom Deflector	AM1318590C3	\$ 24.00	
 7010, 7120, 8010, 8120, 9120, AFX8010 ASN HAJ106401	Clean Grain Elevator Boot Bottom Replaces 8728146, 84194821	AM87510515	\$ 400.00	
 1640, 1644, 1666, 1670, 2144, 2166, 2366	Clean Grain Elevator Boot Side, Inner	AM1317673C2	\$ 76.92	
 1680, 1682, 1688, 2188, 2377, 2388, 2577, 2588	Clean Grain Elevator Boot Side, Inner	AM1318584C2	\$ 75.00	

Case IH®—Combine

Application	Description	Part Number	Retail Price	Core
 5088, 5130, 5140, 6088, 6130, 6140, 7088, 7130, 7140	Clean Grain Elevator Boot Side, Inner	AM84171638	\$ 144.00	
 1640, 1644, 1660, 1666, 1670, 1680, 1682, 1688, 2144, 2166, 2344, 2366	Clean Grain Elevator Boot Side, Outer w/o Yield Monitor	AM1318585C3	\$ 63.38	
 2144, 2166, 2188, 2344, 2366, 2388, 2588	Clean Grain Elevator Boot Side, Outer w/ Yield Monitor Replaces 87634786	AM223237A1	\$ 75.00	
 2188, 2388, 2588	Clean Grain Elevator Boot Side, Outer w/o Yield Monitor	AM176175A2	\$ 50.77	
 5088, 5130, 5140, 6088, 6130, 6140, 7088, 7130, 7140	Clean Grain Elevator Boot Side, Outer	AM84171636	\$ 144.00	
 7130 (2013), (7230, 8230 - 2013-09/14), 7240, 7250, 8250, 9230, 9240, 9250	Clean Grain Elevator Boot Replaces 47513518	AM48189965	\$ 1260.00	

Return Elevator Boots

Application	Description	Part Number	Retail Price	Core
1420, 1440, 1460, 1470, 1620, 1640, 1644, 1660, 1666, 1670	Tailings Elevator Boot	AM191771C1	\$ 262.24	
1480, 1482, 1680, 1682, 1688, 2144, 2166, 2188	Tailings Elevator Boot	AM183160C1	\$ 300.45	
2344, 2366, 2377 SN HAJ292001-HAJ300000, 2388, 2577, 2588	Tailings Elevator Boot Replaces 222814A2	AM87636252	\$ 223.02	
7010, 7120, 8010, 8120, (8230, 9230 - w/ Non-Common Cab), 9010 04/2008 and Later, 9120, AFX8010	Tailings Clean Out Door Extended Wear Replaces 87484453, 87484454, 87753013	AM87736624	\$ 388.00	
(7010, 8010 ASN HAJ202928), 7120, 7230, 7240, 7250, 8120, 8230, 8240, 8250, 9120, 9230, 9240, 9250	Tailings Clean Out Door	AM87728882	\$ 185.00	

Elevator Gearboxes

Application	Description	Part Number	Retail Price	Core
(5140, 6140, 7140 ASN YFG014001, 10/2015), 5150, 6150, 7120, 7150, 7230, 7240, 7250, 8120, 8230, 8240, 8250, 9120, 9230, 9240, 9250	Bin Loading Auger Gearbox Tandem Assembly	AM87721343	\$ 630.00	
(5140, 6140, 7140 ASN YFG014001), 5150, 6150, 7010, 7120, 7150, 7230, 7240, 7250, 8010, 8120, 8230, 8240, 8250, 9010, 9120, 9230, 9240, 9250	Auger Gearbox Intermediate Shaft 11.267" Long	AM87441209	\$ 95.00	
	Gearbox Input Shaft 10.04" Long	AM87441212	\$ 90.00	
	Auger Gearbox Bevel Gear 18 Tooth	AM87441215	\$ 83.00	

Case IH®—Combine

Elevator Head Shafts

Application	Description	Part Number	Retail Price	Core
1420, 1620	Clean Grain Elevator Head Shaft 13.75" Long	AM186164C1	\$ 52.97	
1440 BSN 10000, 1460 BSN 12000, 1470 BSN 1180	Clean Grain Elevator Head Shaft 13" Long, 1" Diameter	AM191694C1	\$ 25.00	
1440 ASN 10000, 1460 ASN 12000, 1470 ASN 1180, 1480, 1482	Clean Grain Elevator Head Shaft 13.31" Long, 1.125" Diameter	AM186723C1	\$ 27.00	
1640, 1660, 1666, 2144, 2166, 2344, 2366	Clean Grain Elevator Head Shaft 10.97" Long, 1.25" Diameter	AM1317429C1	\$ 28.00	
1680, 1682, 1688, 2188, 2377, 2388, 2577, 2588	Clean Grain Elevator Head Shaft 12.94" Long, 1.25" Diameter	AM1317470C1	\$ 35.00	
7010, 7120, 7230, 7240, 8010, 8120, 8230, 8240, 9120, 9230, 9240, AFX8010 ASN HAJ105771	Clean Grain Elevator Head Shaft, Upper 24.62" Long	AM87283680	\$ 185.52	
7010, 7120, 8010, 8120, 9120, AFX8010	Clean Grain Elevator Head Shaft 15.81" Long	AM86998178	\$ 58.00	
1420, 1620	Tailings Elevator Head Shaft 12.75" Long	AM181312C1	\$ 66.40	
1440, 1460, 1470, 1480, 1482, 1640, 1644, 1660, 1666, 1670, 1680, 1682, 2144, 2166, 2188, 2344, 2366, 2388	Tailings Elevator Head Shaft 11" Long, 1" Diameter	AM191785C1	\$ 23.00	
1640, 1644, 1660, 1670, 1680, 1682, 1688, 2144, 2166, 2188, 2344, 2366, (2377, 2388 HAJ292001-HAJ300000), 2577, 2588	Flanged Bearing w/ Lock Collar	AM1317250C91	\$ 37.00	

Elevator Drive Shafts

Application	Description	Part Number	Retail Price	Core
1420, (1440, 1460, 1480 ASN 05501), 1620, 1640, 1644, 1660, 1666, 1680, 1688, 2144, 2166, 2188, 2344, 2366, 2377, 2388, 2577, 2588, 5088, 7088	Elevator Jackshaft Hub	AM183210C91	\$ 99.50	
1440, 1460, 1470	Elevator Drive Shaft 28.27" Long Threaded on one end	AM1319246C1	\$ 162.31	
1480, 1680, 1682, 1688, 2188, 2377, 2388, 2577, 2588	Elevator Drive Shaft	AM1319247C1	\$ 78.50	
(5088, 6088, 7088 ASN Y9G001953), 5130, 5140, 6130, 6140, 7130, 7140	Elevator Jackshaft Retainer	AM87470287	\$ 110.00	
1420, 1440, 1460, 1480, 1620, 1640, 1644, 1660, 1666, 1680, 1688, 2144, 2166, 2188, 2344, 2366, 2377, 2388, 2577, 2588, (5088, 6088, 7088 BSN Y9G001953)	Bearing, Elevator Jackshaft 1.25" Round Bore Replaces 473096R91, 473097R91, 473097R92	AM387284A1	\$ 23.84	

Beater Components

Application	Description	Part Number	Retail Price	Core
1440, 1460, 1640, 1644, 1660, 1666, 2144, 2166, 2344, 2366	Beater Blade (3) Required	AM1319269C1	\$ 106.00	
1480, 1482, 1660, 1680, 1682, 1688, 2188, 2377, 2388, 2577, 2588, 5088, 5130, 5140, 6088, 6130, 7088, 7130, 7140	Beater Blade (3) Required	AM1319270C1	\$ 76.00	
1440, 1460, 1470, 1640, 1644, 1660, 1666, 1670, 2144, 2166, 2344, 2366 - w/ Rock Trap	Beater Shaft 51" Long Replaces 1320138C1, 1320161C1, 1327502C1	AM389021A1	\$ 225.54	
1440, 1460, 1640, 1644, 1660, 1666, 2144, 2166, 2344, 2366	Beater Shaft	AM1302175C1	\$ 115.00	

Prices Subject to Change without Prior Notice. The use of original equipment manufacturer (OEM) part numbers or trademarks, e.g. Case® and John Deere®, are for reference purposes only and for indicating product use and compatibility. Our company and the listed replacement parts contained herein are not sponsored, approved or manufactured by the OEM. All parts are New unless designated Reman in the description.

Case IH®—Combine

Application	Description	Part Number	Retail Price	Core
1480, 1680, 1688, 2188, 2377, 2388, 2577, 2588	Beater Shaft	AM1302176C1	\$ 145.00	
8010, 8120, 9120, AFX8010	Beater Shaft Replaces 87107720	AM87282886	\$ 807.69	
1480, 1680, 1688, 2377, 2388, 2577, 2588	Serrated Fins, Rock Trap Beater Set of 3 41.938" Long, Serrated Fins bolt onto the outer edge of the Beater Blades Includes Hardware	AMB95678	\$ 148.64	
1420, 1440, 1460, 1470, 1480, 1620, 1640, 1644, 1660, 1666, 1670, 1680, 1688, 2144, 2166, 2188, 2344, 2366, 2377, 2388, 2577, 2588, 5088, 5130, 5140, (5150, 6150, 7150 - Tier 4B), 6088, 6130, 6140, 7088, 7130, 7140	Hub Assembly, Discharge Beater 14" OD Replaces 183129C2	AM1316266C1	\$ 151.21	
1420, 1440, 1460, 1470, 1480, 1482, 1620, 1640, 1644, 1660, 1666, 1670, 1680, 1682, 1688, 2144, 2166, 2188, 2344, 2366, 2377 SN HAJ292001-HAJ300000, 2388, 2577, 2588, 5088, 5130, 5140, 6088, 6130, 6140, 7088, 7130, 7140	Hub Assembly, Discharge Beater 14" OD Replaces 183129C2	AM1319266C1	\$ 89.00	
1420, 1440, 1460, 1470, 1480, 1482, 1620, 1640, 1644, 1660, 1666, 1670, 1680, 1682, 1688, 2144, 2166, 2188, 2344, 2366, 2377, 2388, 2577, 2588, 5088, 5130, 5140, 6088, 6130, 6140, 7088, 7130, 7140	Hub, Beater Drive 1.13" Hex Bore Replaces 176579C1	AM1319402C1	\$ 68.00	
7010, 7120, 7230, 8010, 8120, 8230, 9010, 9120, 9230, AFX8010	Bearing Assembly For Beater/Chopper Drive Replaces 47421133, 47663490, 87323956	AM87109088	\$ 196.00	
7120, 7230, 8120, 8230, 9120, 9230	Slotted Grate Insert Use w/ Discharge Beater Grates	AM87587528	\$ 310.00	

Fan Components

Application	Description	Part Number	Retail Price	Core
1440, 1460, 1470, 1480, 1640, 1644, 1660, 1666, 1670, 1680, 1688, 2144, 2166, 2188, 2344, 2366, 2377, 2388, 2577, 2588, 5130, 5140, 5150, 6130, 6140, 6150, 7088, 7130, 7140, 7150	Gear Set Includes 18 & 31 Tooth Gears Replaces 191285C1	AM1315597C1	\$ 500.00	
1688, 2188, 2377, 2388, 2588, 5088, 5130, 5140, 5150, 6088, 6130, 6140, 6150, 7088, 7130, 7140, 7150, 9230 Tier 4 Common Cab 2013-09/14	Cleaning Fan Shaft	AM1989543C3	\$ 350.00	
(2577, 2588 ASN HAJ303001), 5088, 5130, 6088, 6130, 7088, 7130	Fan Speed Actuator	AM87693674	\$ 78.00	



Unloading Auger Housings and Components Grain Drains

Application	Description	Part Number	Retail Price	Core
1 1420, 1440, 1460, 1480, 1620, 1640 BSN 97103, 1660 BSN 102897, 1680 BSN 115352	Lower Unloading Housing	AM1327976C91	\$ 455.38	
2 1420, 1440, 1460, 1470, 1480, 1482, 1620, 1640, 1644, 1660, 1666, 1670, 1680, 1682, 1688, 2144, 2166, 2188, 2344, 2366, 2388, 2588	Elevator Sump Elevator Sump, Stainless Steel Elevator Sump Rebuild Kit Stainless Steel Liners Includes Hardware	AM192475C3 AM192475C3S AMX29149	\$ 860.00 \$ 980.00 \$ 383.00	
3 1420, 1440, 1460, 1470, 1480, 1482, 1620, 1640, 1644, 1660, 1666, 1670, 1680, 1682, 1688, 2144, 2166, 2188, 2344, 2366, 2388	Grain Drain	AMX27136	\$ 215.00	

Case IH®—Combine

Application	Description	Part Number	Retail Price	Core
4 1440, 1640 ASN 35422, 1644, 1660 ASN 40895, 1666, 1670 ASN 80540, 1680 ASN 48053, 1688, 2144, 2166, 2188, 2344, 2366, 2377, 2388	Vertical Grain Tank Unloading Tube Includes AM237009A1 Upper Ring	AM248307A2	\$ 490.00	
5 1660, 2144, 2166, 2188, 2344, 2366, 2377, 2388	Grain Tank Unloading Housing Upper Ring	AM237009A1	\$ 175.00	
NI 2144, 2166, 2188, 2344, 2366, 2377, 2388, 2577, 2588	Sump Housing Door Use w/ AM192475C3 Elevator Sump	AM189284A1	\$ 114.00	
NI 5088, 5130, 5140, 6088, 6130, 6140, 7010, 7088, 7120, 7130, 7140, 8010, 8120, 9010, 9120	Sump Liner Kit 4-Piece	AMX29160	\$ 257.00	

Unloading Auger Bevel Gears



Application	Description	Part Number	Retail Price	Core
1420, 1440, 1460, 1480, 1620, 1640 BSN 97103, 1660 BSN 102897, 1680 BSN 115352	Unloading Auger Bevel Gears Includes 21 Tooth Gear & 28 Tooth Gear Sold as Set Only	AM186517C1	\$ 232.31	

Unloading Gearbox Shafts



Application	Description	Part Number	Retail Price	Core
(815, 915 ASN 8001)	Unloading Gearbox Shaft, Horizontal	AM178115C1	\$ 41.79	
	Unloading Gearbox Shaft, Vertical	AM178116C1	\$ 26.81	
1420, 1440, 1460, 1480, 1620, 1640 BSN 97103, 1660 BSN 102897, 1680 BSN 115352	Unloading Gearbox Shaft, Vertical	AM1327739C2	\$ 142.33	
1420, 1440, 1460, 1470, 1480, 1482, 1620, 1640 BSN JJC0097103, 1660 BSN JJC0102897, 1670, 1680 BSN JJC0115352, 1682	Elevator Drive Shaft Horizontal Auger Gear Shaft	AM1327738C2	\$ 98.89	

Unloading Auger Swing Cylinders



Application	Description	Part Number	Retail Price	Core
1420, 1440, 1460, 1480	Unloading Auger Swing Cylinder	AM113960C92	\$ 458.53	
1620, 1640, 1644, 1660, 1666, 1670, 1680, 1682, 1688	Unloading Auger Swing Cylinder Replaces 1282488C92	AM1282488C91	\$ 525.00	
5130, 5140, 6130, 6140, 7010, 7120, 7130, 7140, 7230, 8010, 8120, 8230, 9010, 9210, 9230	Unloading Auger Swing Cylinder Replaces 84552262, 87592126, 87645216	AM84126280	\$ 860.00	
2144, 2166, 2188, 2344, 2366, 2377, 2388	Unloading Tube Swing Cylinder Replaces 175679A2, 87597336	AM87337241	\$ 385.00	

Augers & Components—Lower Clean Grain

All augers are made with continuous roll-formed flighting for accuracy and durability.



Application	Description	Part Number	Retail Price	Core
1440 ASN 30484, 1460 ASN 33285 AM144031A1 Sprocket is required when replacing 191737C1 Auger on early model 1440 (BSN 30484) and (1460 BSN 33285)	Lower Clean Grain Auger Extended Wear, 70 3/8" Overall Length, Right Hand Flighting, 6" Flighting Diameter, Shaft Diameter - 1" and 1 1/4", 6" Pitch	AM1319169C1	\$ 184.00	
	Bearing	AM160796C91	\$ 11.84	

Case IH®—Combine

Application	Description	Part Number	Retail Price	Core
1440 ASN 30484, 1460 ASN 33285, 1480, 1620, 5088, 6088, 7088	Clean Grain Elevator Chain Sprocket, Lower 7 Tooth, 1.25" Shaft Replaces 1319176C1	AM144031A1	\$ 40.00	
1480	Lower Clean Grain Auger Extended Wear, 76" Overall Length, Right Hand Flighting, 7" Flighting Diameter, 1 1/4" Shaft Diameter, 7" Pitch	AM1319173C1	\$ 247.00	
	Bearing	AM160796C91	\$ 11.84	
1640, 1644, 1660, 1666, 1670, 2144, 2166, 2344, 2366	Clean Grain Auger Trough Clamp	AM1317452C1	\$ 65.54	
1640, 1644, 1660, 1666, 2144, 2166	Lower Clean Grain Auger Extended Wear, 68 1/2" Overall Length, Right Hand Flighting, 7" Flighting Diameter, 1 1/4" Shaft Diameter, 7" Pitch	AM1317484C1	\$ 189.00	
	Bearing	AM1317250C91	\$ 37.00	
1644, 1666, 2144, 2166, 2344, 2366	Clean Grain Auger Trough	AM1541638C1	\$ 296.92	
1680, 1682, 1688, 2188, 2377, 2388, 2577, 2588	Clean Grain Auger Trough Tube Support Clamp, Solid For Clean Grain Auger Trough	AM1317398C1 AM1317442C1	\$ 157.17 \$ 33.16	
1680, 1688	Lower Clean Grain Auger Extended Wear, 76" Overall Length, Right Hand Flighting, 8" Flighting Diameter, 1 1/4" Shaft Diameter, 7 1/2" Pitch	AM1317409C1	\$ 215.00	
	Bearing	AM160796C91	\$ 11.84	
1688, 2188, 2388, 2588	Clean Grain Auger Trough	AM1989374C1	\$ 190.00	
2188, 2388, 2588	Lower Clean Grain Auger Extended Wear, 76 3/8" Overall Length, Right Hand Flighting, 8" Flighting Diameter, 1 3/8" Shaft Diameter, 7 1/2" Pitch	AM143959A2	\$ 268.00	
	Bearing, (2) Required	SA207-22	\$ 14.40	
5088, 5130, 5140, 5150, 6088, 6130, 6140, 6150, 7088, 7130, 7140, 7150	Mid Range Clean Grain and Return Grain Auger Liner Kit Set of 2 Liners w/ Rivets	AMX29171	\$ 390.00	
5088, 5130, 5140, 6088, 6130, 6140, 7010, 7088, 7120, 7130, 7140, 7150, 7240, 7250, 8010, 8120, 8230, 8240, 8250, 9010, 9230, 9240, 9250	Clean Grain Auger Trough Liner 101.459" Long, 13.13" Wide Stainless Steel, Includes Mounting Hardware	AMX27265	\$ 325.00	
5088, 5130, 5140, 6088, 6130, 6140, 7088, 7130, 7140	Lower Clean Grain Auger Extended Wear, 76 5/8" Overall Length, Right Hand Flighting, 8 1/2" Flighting Diameter, 1 1/2" Shaft Diameter, 9" Pitch	AM87510720	\$ 551.00	
	Bearing	AMJD9202	\$ 18.00	
	Clean Grain Auger Trough Liner Kit Stainless Steel, Includes Rivets	AMX29157	\$ 393.00	
(5140, 6140, 7140 ASN YFG014001), 5150, 6150, 7150	Lower Clean Grain Auger 86.375" Overall Length, Right Hand Flighting, 8.50" Flighting Diameter, 69.50" Flighting Length, 1.50" Tube Diameter	AM47595610	\$ 527.79	
	Bearing	AMJD9202	\$ 18.00	

Case IH®—Combine

Application	Description	Part Number	Retail Price	Core
7010, 7120	Lower Clean Grain Auger Extended Wear Replaces 87380417, 87380423	AM87380422	\$ 677.00	
	Bearing	AMJD10384	\$ 22.00	
	Clean Grain and Return Grain Auger Trough Liner Patch Kit Set of 2 Stainless Steel Weld-In Liners (Narrow Frame)	AMX29120	\$ 868.00	
(7230, 8230, 9230 BSN YDG222000), 8010, 8120, 9120	Clean Grain and Return Grain Auger Trough Liner Kit Set of 2 Stainless Steel Weld-In Full Troughs 78" Overall Length Includes Stainless Steel for Door Covers	AMX29146	\$ 1061.00	
	Clean Grain and Return Grain Auger Trough Full Liner Kit Set of 2 Stainless Steel Weld-In Full Troughs, Narrow Frame 68" Overall Length Includes Stainless Steel for Door Covers	AMX29159	\$ 1061.00	
7010, 7120, 8010, 8120, 9120	Lower Clean Grain Auger Trough Replaces 86975161	AM87380544	\$ 2000.00	
7230, 8010, 8120, 8230, 9010, 9120, 9230 BSN TDG222000	Clean Grain and Return Grain Auger Trough Liner Patch Kit Set of 2 Stainless Steel Weld-In Repair Panels, 24" Long	AMX29119	\$ 383.00	
(7230, 8230, 9230 ASN YDG222004), 7250, 8230, 8250, 9230, 9250	Lower Clean Grain Auger Extended Wear, 84 1/2" Overall Length, Right Hand Flighting, 10 1/2" Flighting Diameter, Shaft Diameter - 1.772" and 1.18", 10 1/2" Pitch Replaces 84577868	AM84583816	\$ 956.00	
	Bearing	AMJD10384	\$ 22.00	
(7230, 8230, 9230 BSN YDG222004), 8010, 8120, 9010, 9120, AFX8010	Lower Clean Grain Auger Extended Wear, 100 1/2" Overall Length, Right Hand Flighting, 8 7/8" Flighting Diameter, Shaft Diameter - 1.772" and 1.18", Reinforced 2.50" Tube, 9 7/8" Pitch Replaces 86975024, 87283266	AM87283130	\$ 698.00	
	Bearing	AMJD10384	\$ 22.00	
(7230, 8230, 9230 ASN YDG222000), 7240, 7250, 8240, 8250, 9240, 9250	Clean Grain and Return Grain Auger Trough Liner Patch Kit Set of 3 Stainless Steel Weld-In Repair Panels, 24" Long Includes Elevator Door Liners	AMX29147	\$ 480.00	
	Clean Grain and Return Grain Auger Trough Full Liner Kit Set of 3 Stainless Steel Weld-In Full Troughs Includes Stainless Steel for Door Covers	AMX29148	\$ 1092.00	

Augers & Components—Lower Tailing Return

All augers are made with continuous roll-formed flighting for accuracy and durability.

Application	Description	Part Number	Retail Price	Core
1440, 1460, 1640, 1644, 1660, 1666	Lower Return Auger Extended Wear, 62 1/2" Overall Length, Right Hand Flighting, 5" Flighting Diameter, 1" Shaft Diameter, 5" Pitch	AM191734C1	\$ 163.00	
	Bearing	NPS100RPC	\$ 6.50	

Case IH®—Combine

Application	Description	Part Number	Retail Price	Core
1480, 1482, 1680, 1682, 1688	Lower Return Auger Extended Wear, 85 3/8" Overall Length, Right Hand Flighting, 5" Flighting Diameter, 1 1/8" Shaft Diameter, 5 1/2" Pitch	AM192549C2	\$ 268.00	
	Bearing, (2) Required	SA206-18	\$ 14.25	
1480, 1680, 1688, 2188, 2377, 2388, 2577, 2588	Tailings Delivery Tube	AM191854C1	\$ 169.23	
1644, 1660 ASN JJC0038346, 1666, 2144, 2166, 2344, 2366 - w/ Straw Spreader	Rubber Seal For Tailing Auger Panel	AM1347000C2	\$ 72.28	
1680, 1688, 2188, 2388, 2588	Tailing Trough Replaces 1346938C1, 1346938C2	AM87392135	\$ 195.00	
2144, 2166, 2344, 2366	Lower Return Auger 62.81" Long	AM144021A2	\$ 306.97	
	Bearing - (2) Required	AM160796C91	\$ 11.84	
2188, 2388, 2588, 5088, 5130, 6088, 6130, 7088, 7130, 7140	Lower Return Auger Extended Wear, 85 3/4" Overall Length, Right Hand Flighting, 5 1/4" Flighting Diameter, 1 1/4" Shaft Diameter, 5 1/4" Pitch	AM144028A2	\$ 263.00	
	Bearing	AM160796C91	\$ 11.84	
2377, 2388, 2577, 2588	Seal, Tailings Auger Trough	AM1979194C2	\$ 77.88	
5088, 5130, 5140, 5150, 6088, 6130, 6140, 6150, 7088, 7130, 7140, 7150	Mid Range Clean Grain and Return Grain Auger Liner Kit Set of 2 Liners w/ Rivets	AMX29171	\$ 390.00	
5088, 5130, 5140, 6088, 6130, 6140, 7088, 7130, 7140	Return Grain Auger Trough Liner Stainless Steel Includes Stainless Steel Rivets and Mounting Hardware	AMX29158	\$ 219.00	
5140, 6140, 7140	Lower Return Auger 76.69" Long, 1.25" Shaft Diameter, 5" Flighting Diameter, Right Hand Rotation	AM47561763	\$ 287.82	
	Bearing	AM160796C91	\$ 11.84	
7010, 7120	Clean Grain and Return Grain Auger Trough Full Liner Kit Set of 2 Stainless Steel Weld-In Full Troughs, Narrow Frame 68" Overall Length Includes Stainless Steel for Door Covers	AMX29159	\$ 1061.00	
	Clean Grain and Return Grain Auger Trough Liner Patch Kit Set of 2 Stainless Steel Weld-In Liners (Narrow Frame)	AMX29120	\$ 868.00	
7010, 7120, 7230, 7240, 7250, 8010, 8120, 8230, 8240, 8250, 9010, 9120, 9230, 9240, 9250, AFX8010	Lower Return Auger Trough Cover Standard, w/o Holes, 62.55" Long	AM84078027	\$ 57.47	
(7230, 8230, 9230 BSN YDG222000), 8010, 8120, 9120	Clean Grain and Return Grain Auger Trough Liner Kit Set of 2 Stainless Steel Weld-In Full Troughs 78" Overall Length Includes Stainless Steel for Door Covers	AMX29146	\$ 1061.00	
7010, 7120, 8010, 8120, 9120	Lower Return Auger Trough Replaces 86975161	AM87380544	\$ 2000.00	
	Lower Return Auger, Extended Wear Replaces 87573646, 87730185	AM87730183	\$ 625.00	
	Bearing	AMJD9202	\$ 18.00	

Case IH®—Combine

Application	Description	Part Number	Retail Price	Core
7230, 8010, 8120, 8230, 9010, 9120, 9230 BSN TDG222000	Clean Grain and Return Grain Auger Trough Liner Patch Kit Set of 2 Stainless Steel Weld-In Repair Panels, 24" Long	AMX29119	\$ 383.00	
7230, 7240, 7250, 8010, 8120, 8230, 8240, 8250, 9120, 9230, 9240, 9250, AFX8010	Lower Return Auger, Extended Wear Replaces 84402650, 87573645, 86997058, 87730185, 87107475, 87282086, 87283631	AM84402652	\$ 677.00	
(7230, 8230, 9230 ASN YDG222000), 7240, 7250, 8240, 8250, 9240, 9250	Clean Grain and Return Grain Auger Trough Full Liner Kit Set of 3 Stainless Steel Weld-In Full Troughs Includes Stainless Steel for Door Covers	AMX29148	\$ 1092.00	
1440, 1460, 1480, 1680, 1688, 2188	Roller Chain, Return Elevator Drive 154 Links, Size 50 Chain	AM1302671C91	\$ 35.00	
1620	Roller Chain, Return Elevator Drive 66 Links, Size 40 Chain	AMX34132	\$ 30.00	
1640, 1644, 1660, 1666, 2144, 2166, 2344	Roller Chain, Return Elevator Drive 159 Links, Size 50 Chain	AM1327724C92	\$ 40.00	
2366	Roller Chain, Return Elevator Drive 162 Links, Size 50 Chain	AM301226A1	\$ 36.00	
2377, 2388, 2577, 2588	Roller Chain, Return Elevator Drive 156 Links, Size 50 Chain	AM84395718P	\$ 35.00	
5088, 6088, 7088 BSN Y9G001953	Roller Chain, Return Elevator Drive 134 Links, Size 60H Chain	AM1302671C92	\$ 45.00	
(5088, 6088, 7088 ASN Y9G001954), 5130, 5140, 6140 Prior to 10/2015, 6130, 7130	Roller Chain, Return Elevator Drive 134 Links, Size 60H Chain	AM84164207	\$ 60.00	
(5140, 6140 - 10/2015 and Later), 5150, 6150	Roller Chain, Return Elevator Drive 100 Links, Size 60H Chain	AM47707460	\$ 75.00	

Augers—Top Tailing Return

All augers are made with continuous roll-formed flighting for accuracy and durability.



Application	Description	Part Number	Retail Price	Core
1440, 1460, 1640, 1660, 1666, 2144, 2166, 2344, 2366	Top Return Auger 25 1/2" Overall Length, 5" Flighting Diameter, 1" Shaft Diameter, 5" Pitch	AM193225C1	\$ 152.00	
1480, 1482, 1680, 1682, 1688, 2188, 2377 SN HAJ292001-HAJ300000, 2388, 2577, 2588, 5088, 5130, 6088, 6130, 6140, 7088, 7130, 7140	Top Return Auger 37 1/2" Long, Left Hand Flighting, 5" Flighting Diameter, 1" Shaft Diameter, 5" Pitch Replaces 192563C1	AM87379140	\$ 174.00	
(5140, 6140, 7140 ASN YFG014001 and 10/2015), 5150, 6150, 7150	Top Return Auger 30 3/8" Overall Length, Left Hand Flighting, 4 3/4" Flighting Diameter, Shaft Diameter - 7/8" Hex Shaft and 0.997", 5" Pitch Bearing, Metal	AM47755502 AM195293C91	\$ 336.00 \$ 6.40	
7010, 7120, 7230, 8010, 8120, 8230, 9010, 9120, 9230, AFX8010	Shaft, Tailings Processor Replaces 84405034	AM86997062	\$ 62.00	
1420, 1440, 1460, 1470, 1480, 1620, 1640, 1644, 1660, 1670, 1680, 1688, 2144, 2166, 2188, 2344, 2366, 2377 SN HAJ292001- HAJ300000, 2388, 2577, 2588	Bearing Hub, Return Auger 6.29" Long, 8.04" OD Replaces 192783C1	AM1324840C1	\$ 68.00	

Case IH®—Combine

Augers & Components—Grain Delivery Leveling

All augers are made with continuous roll-formed fighting for accuracy and durability.



Application	Description	Part Number	Retail Price	Core
1440 ASN 50001, 1460 ASN 52001	Grain Delivery Leveling Auger Extended Wear, 81 1/4" Overall Length, Left Hand Fighting, 7 1/2" Fighting Diameter, Shaft Diameter - 1 1/8" and 1", 7 1/2" Pitch	AM1319710C1	\$ 252.00	
	Slide-On Short Auxiliary Flight 11 1/2" Overall Length, Left Hand Fighting, 5" Fighting Diameter, Shaft Diameter - 1 3/4" Bore and 1 3/4" Bore, 5 1/4" Pitch For Grain Delivery Leveling Auger	AM162103C91	\$ 110.00	
	Bearing	NPS100RPC	\$ 6.50	
	Bearing, Fighting End	SA206-18	\$ 14.25	
1640 ASN 62001, 1620 Late, 1640 Early, 1644, 1660 Early, 1666	Grain Delivery Leveling Auger 79.06" Long, 1.25" Shaft - Horizontal	AM1318912C3	\$ 414.51	
	Slide-On Short Auxiliary Flight 11 1/2" Overall Length, Left Hand Fighting, 5" Fighting Diameter, Shaft Diameter - 1 3/4" Bore and 1 3/4" Bore, 5 1/4" Pitch For Grain Delivery Leveling Auger	AM162103C91	\$ 110.00	
	Bearing	NPS100RPC	\$ 6.50	
	Bearing, Fighting End	NPS104RPC	\$ 40.00	
1480, 1482 ASN 54001	Grain Delivery Leveling Auger Extended Wear, 79 3/8" Overall Length, Left Hand Fighting, 7 1/2" Fighting Diameter, Shaft Diameter - 1 1/8" and 1", 7 1/2" Pitch	AM1319709C1	\$ 291.00	
	Slide-On Short Auxiliary Flight 11 1/2" Overall Length, Left Hand Fighting, 5" Fighting Diameter, Shaft Diameter - 1 3/4" Bore and 1 3/4" Bore, 5 1/4" Pitch For Grain Delivery Leveling Auger	AM162103C91	\$ 110.00	
	Bearing	NPS100RPC	\$ 6.50	
	Bearing, Fighting End	SA206-18	\$ 14.25	
1660, 1666, 1680, 1688, 2144, 2166, 2188, 2344, 2366, 2388, 2588	Inclined Grain Delivery Leveling Auger Extended Wear-Sectional, 47 3/8" Overall Length, Left Hand Fighting, 7" Fighting Diameter, Shaft Diameter - 1" and 1 3/8"-16 Internal Spline, 8" Pitch Replaces 249275A2, 1968853C2	AM1968853C1	\$ 520.00	
	Bearing	SA207-22	\$ 14.40	
1660, 1666, 1680, 1688, 2144, 2166, 2188, 2344, 2366, 2388, 2588	Inclined Grain Delivery Leveling Auger Extended Wear-Sectional, 47 3/8" Overall Length, Hard Chrome Left Hand Fighting, 7" Fighting Diameter, Shaft Diameter - 1" and 1 3/8"-16 Internal Spline, 8" Pitch Replaces 320724A3, 87347842	AM222801A4	\$ 709.00	
	Bearing	NPS100RPC	\$ 6.50	
	Bearing	SA207-22	\$ 14.40	
1660, 1666, 1680, 1688, 2144, 2166, 2188, 2344, 2366, 2388 - w/ AFS	Inclined Grain Delivery Leveling Auger Extended Wear-Sectional, Notched for Sensor, 47 3/8" Overall Length, Hardened Chrome Left Hand Fighting, Split, 10" Fighting Diameter, Shaft Diameter - 1" and 1 3/8"-16 Internal Spline, 8" Pitch	AM320724A3	\$ 714.00	
5088, 5130, 6088, 6130, 7088, 7130, 7140	Inclined Delivery Auger Extended Wear, 76 1/2" Overall Length, Left Hand Fighting, 11 1/2" Fighting Diameter, Shaft Diameter - 1 3/8" Hex Shaft and 0.813" Bore, 8 1/2" Pitch Replaces 84577410	AM87563930	\$ 609.00	
5130, 6130, 7130	Bearing 2.838" OD, 1.378" Bore Replaces 80212606, 80212607, 84814912, 87605590	HC207-22	\$ 23.06	

Case IH®—Combine

Application	Description	Part Number	Retail Price	Core
(5140, 6140, 7140 ASN YFG014001), 6150, 7150	Incline Delivery Auger 81.50" Long, 1.377" Shaft Diameter Left Hand Flighting Ball Bearing	AM47740022 AMAN102010	\$ 974.23 \$ 15.00	
(7230, 8230, 9230 - 2013-09/14 w/ Common Cab)	Incline Auger Liner Repair Sleeve	AMX29163	\$ 868.00	
7010, 7120, 8010, 8120, 9120, (7230, 8230, 9230 BSN 222000 w/ Non-Common Cab)	Incline Auger Liner Repair Sleeve 12-Gauge Steel Includes Bolt Kit	AMX29113	\$ 868.00	
(5140, 6140, 7140 ASN YFG014001), 5150, 6150, 7010, 7120, 7150, 7230, 7240, 7250, 8010, 8120, 8230, 8240, 8250, 9120, 9230, 9240, 9250, AFX8010	Inclined Delivery Auger Extended Wear, 81 5/8" Overall Length, Left Hand Flighting, 12" Flighting Diameter, Shaft Diameter - 1 3/8" and 1 1/4"-19 Internal Spline, 10" Pitch Replaces 47740022, 51620445, 87106615 Bearing	AM87733275 HC207-22	\$ 719.00 \$ 23.06	
7010, 7120, 8010, 8120, 9120	Inclined Delivery Auger Extended Wear, 72.562" Long Replaces 87106625 Bearing	AM87733272 HC207-22	\$ 745.11 \$ 23.06	
7010, 7120, 7130, 7230, 8010, 8120, 8230, 9120, 9230	Inclined Delivery Auger Tube Extended Wear Replaces 87510503, 87600219	AM84403642	\$ 2500.00	
1660, 1680, 1688, 2144, 2166, 2188, 2344, 2366, 2388, 2588	Inclined Delivery Drive Sprocket 29 Tooth	AM1321039C1	\$ 25.00	
1660, 1680, 1688, 2144, 2166, 2188, 2366, 2377 SN 292001-300000, 2388, 2577	Bearing, Incline Delivery Auger Replaces 611583R1, 611583R91	AMJD9275	\$ 24.15	
5088, 5130, (5140, 6140, 7140 - Prior to 2016), 6088, 6130, 7088, 7130	Incline Auger Liner Repair Sleeve 12-Gauge Steel Includes Bolt Kit	AMX29112	\$ 868.00	
(5140, 6140, 7140 - 2016 and Later), 5150, 6150, 7150	Incline Auger Liner Repair Sleeve 12-Gauge Steel	AMX29156	\$ 868.00	
7240, 7250, 8240, 8250, 9240, 9250	Incline Auger Liner Repair Sleeve 12-Gauge Steel Includes Bolt Kit	AMX29124	\$ 868.00	
7010, 7120, 7230, 7240, 8010, 8120, 8240, 9120, 9230, 9240, AFX8010	Driven Sprocket 26 Tooth, 1.182" Bore For Incline Delivery Auger	AM86999492	\$ 25.00	
1420, 1440, 1460, 1470, 1480, 1482, 1620, 1640, 1644, 1660, 1666, 1670, 1680, 1682, 1688, 2144, 2166, 2188, 2344, 2366, 2377, 2388, 2577	Flanged Bearing, 2-Bolt Replaces 211283C91	AM214490C91	\$ 14.50	
1660	Roller Chain, Horizontal Delivery Auger Drive 262 Links, Size 50 Chain	AMX34123	\$ 70.00	
1640, 1644, 1666, 2144, 2166, 2388 BSN JJC0276540	Roller Chain, Horizontal Delivery Auger Drive 264 Links, Size 50 Chain	AM1321308C91	\$ 70.00	
2344, 2366	Roller Chain, Horizontal Delivery Auger Drive 266 Links, Size 50 Chain	AM301228A1	\$ 70.00	
1660	Roller Chain, Incline Delivery Auger Drive Single Row, 246 Links, Size 50 Chain	AMX34124	\$ 65.00	
1666	Roller Chain, Incline Delivery Auger Drive Double Row, 246 Links, Size 50 Chain	AMX34125	\$ 65.00	
1688	Roller Chain, Incline Delivery Auger Drive 258 Links, Size 50 Chain	AM1327534C91	\$ 55.00	
2144, 2166	Roller Chain, Incline Delivery Auger Drive 246 Links, Size 50 Chain	AM1321307C91	\$ 65.00	
2344, 2366	Roller Chain, Incline Delivery Auger Drive 248 Links, Size 50 Chain	AM301227A1	\$ 65.00	

Prices Subject to Change without Prior Notice. The use of original equipment manufacturer (OEM) part numbers or trademarks, e.g. Case® and John Deere®, are for reference purposes only and for indicating product use and compatibility. Our company and the listed replacement parts contained herein are not sponsored, approved or manufactured by the OEM. All parts are New unless designated Reman in the description.

Case IH®—Combine

Application	Description	Part Number	Retail Price	Core
2377, 2388 BSN JJC0276540 & SN HAJ292001-HAJ300000, 2577, 2588	Roller Chain, Incline Delivery Auger Drive 260 Links, Size 50 Chain	AM1327534C92	\$ 76.00	
(5088, 6088 BSN Y9G001953), 7088 BSN Y9G001954	Roller Chain, Incline Delivery Auger Drive 266 Links, Size 50 Chain	AM87362139	\$ 75.00	
7010, 7120, 7230, 7240, 7250, 8010, 8120, 8230, 8240, 8250, 9010, 9120, 9230, 9240, 9250	Roller Chain, Incline Delivery Auger Drive 65 Links, Size 60 Chain Replaces 87105134, 87584814	AM87470736	\$ 50.00	
(5088, 7088 ASN Y9G001954), 5130, (5140, 6140, 7140 - Prior to 10/2015), 6088 ASN Y9H001954, 6130, 7130	Roller Chain, Incline Auger Drive 224 Links, Size 60H Chain	AM84163936	\$ 80.00	
(5140, 6140, 7140 - 10/2015 and Later), 5150, 6150, 7150	Roller Chain, Incline Auger Drive 144 Links, Size 60H Chain	AM47709870	\$ 90.00	

Augers & Components—Distribution

All augers are made with continuous roll-formed flighting for accuracy and durability.



Application	Description	Part Number	Retail Price	Core
1420 BSN 5500, 1440 BSN 30000, 1460 BSN 32000, (1470, 1482 BSN 10000), 1480 BSN 34000	Distribution Auger Extended Wear, 78 1/4" Overall Length, Right Hand Flighting, 5" Flighting Diameter, 1 1/8" Hex Shaft Diameter, 5" Pitch	AM193398C1	\$ 142.00	
	Bearing, Metal	AM195293C91	\$ 6.40	
1420 ASN 5501, 1440 ASN 30001, 1460 ASN 32001, (1470, 1482 ASN 10001), 1480 ASN 34001, 1620, 1640, 1644, 1660, 1666, 1670, 1680, 1682, 1688, 2144, 2166, 2188, 2344, 2366, 2388, 2588	Distribution Auger 78.25" Long, Right Hand Flighting, 0.875" Hex Shaft Replaces 1309229C1	AM1308541C1	\$ 142.00	
	Bearing, Metal	AM195293C91	\$ 6.40	
2577, 2588, 5088, 5130, 5140, 5150, 6088, 6130, 6140, 6150, 7088, 7130, 7140, 7150	Distribution Auger, Right Hand 79 1/4" Overall Length, Right Hand Flighting, 5" Flighting Diameter, Shaft Diameter - 7/8" Hex Shaft and 0.874" Hex Shaft, 5" Pitch	AM87649711	\$ 275.00	
	Distribution Auger, Left Hand 79 1/4" Overall Length, Left Hand Flighting, 5" Flighting Diameter, Shaft Diameter - 7/8" Hex Shaft and 0.874" Hex Shaft, 5" Pitch	AM87649712	\$ 275.00	
	Bearing, Metal	AM195293C91	\$ 6.40	
1440, 1460, 1470, 1640, 1644, 1666, 1670, 2144, 2166, 2344, 2366	Support, Auger Drive	AM1309225C1	\$ 65.40	
1420, 1440, 1460, 1470, 1480, 1482, 1620, 1640, 1644, 1660, 1666, 1670, 1680, 1682, 1688, 2144, 2166, 2188, 2344, 2366, 2388, 2588	Shoe Auger Board (1) Required per Auger Replaces B94626	AM193414C2	\$ 10.00	
1680, 1688, 2188, 2377 ASN HAJ0292001, 2388, 5130, 6088, 6130, 6140, 7088, 7130, 7140	Shaker Shoe Supply Auger Shaft 74.12" Long	AM1322616C2	\$ 365.00	
1420, (1440, 1460, 1482 ASN 5501), 1470 ASN 10001, 1480, 1620 ASN JJC0032630, 1640, 1644, 1660 ASN JJC0039550, 1666, 1670 ASN JJC0080540, 1680, 1682, 1688, 2144, 2166, 2188, 2344, 2366, 2377 ASN HAJ0292001, 2388 BSN JJC0276540 & ASN HAJ0292001, 2577, 2588, 5088, 5130, 6088, 7088	Slip Clutch Drive Hub	AM1303136C2	\$ 95.00	

Case IH®—Combine



Distribution Auger Pans and Components

Application	Description	Part Number	Retail Price	Core
1440, 1460, 1640, 1644, 1660 1666, 1670, 2144, 2166, 2344, 2366	Distribution Pan	AM185038C7	\$ 1315.38	
1480, 1680, 1688, 2188, 2388, 2588	Distribution Pan	AM191645C6	\$ 925.00	
1420, 1440, 1460, 1470, 1480, 1482, 1620, 1640, 1644, 1660, 1666, 1670, 1680, 1682, 1688, 2144, 2166, 2188, 2344, 2366, 2377, 2388, 2577, 2588	Grain Bed Auger Liner 16-Gauge Stainless Steel For Outside Augers Includes Rivets	AMX29153	\$ 219.00	
	Grain Bed Auger Liner 16-Gauge Stainless Steel For Inside Augers Includes Rivets	AMX29154	\$ 219.00	
1420, 1620	Grain Bed Auger Liner Set 16-Gauge Stainless Steel Includes (2) Outside Auger Bed Liners, Inside Auger Bed Liner and Rivets	AMX29164	\$ 650.00	
1440, 1460, 1470, 1640, 1644, 1660, 1666, 1670, 2144, 2166, 2344, 2366	Grain Bed Auger Liner Set Set of 4 16-Gauge Stainless Steel Includes (2) Outside Auger Bed Liners, (2) Inside Auger Bed Liners and Rivets	AMX29165	\$ 875.00	
1480, 1482, 1680, 1682, 1688, 2188, 2388, 2588	Front Panel Replaces 87378752	AM1345014C3	\$ 70.00	
1480, 1680, 1688, 2188, 2388, 2588	Clean Out Door (5) Required	AM185068C1	\$ 13.00	
1420, 1440, 1444, 1460, 1620, 1640, 1660, 1666, 2144, 2166, 2344, 2366	Grain Diverter	AMX29053	\$ 77.50	
1480, 1680, 1688, 2188, 2388	Grain Diverter	AMX29054	\$ 77.50	
1480 ASN 34002, 1680, 1688, 2188, 2377, 2388, 2577, 2588, 5088, 6088, 7088	Auger Drive Support Replaces 1309226C1	AM87379131	\$ 51.50	
1420, 1440, 1460, 1470, 1480, 1482, 1620, 1640, 1644, 1660, 1666, 1670, 1680, 1682, 1688, 2144, 2166, 2188, 2344, 2366, 2388	Bevel Gear 14 Tooth, 1.13" Hex ID Replaces 87375654	AM191677C1	\$ 25.00	
1420, 1440, 1460, 1470, 1480, 1482, 1620, 1640, 1644, 1660, 1666, 1670, 1680, 1682, 1688, 2144, 2166, 2188, 2344, 2366, 2388, 5088, 6088, 7088	Bevel Gear 14 Tooth, 0.875" Hex ID Replaces 87375653	AM194194C1	\$ 20.00	
1480, 1482, 1680, 1682, 1688, 2188, 2377, 2388, 2577, 2588	Grain Bed Auger Liner Set Set of 5 16-Gauge Stainless Steel Includes (2) Outside Auger Bed Liners, (3) Inside Auger Bed Liners and Rivets	AMX29166	\$ 1095.00	

Case IH®—Combine

Augers & Components—Vertical Unloading

All augers are made with continuous roll-formed fighting for accuracy and durability.

Application	Description	Part Number	Retail Price	Core
1440, 1460, 1480, 1640 BSN 97102, 1660 BSN 102896, 1680 BSN 115351	Vertical Unloading Auger Extended Wear, Single Fighting 50 1/4" Overall Length, Right Hand Fighting, 11.60" Fighting Diameter, Shaft Diameter - 1.385" Bore and 1.50" Square Bore, 8" Pitch For Older Open Gearbox	AM192835C1	\$ 399.00	
	Vertical Unloading Auger Extended Wear, Double Flight Auger 50 1/4" Overall Length, Right Hand Fighting, 11.60" Fighting Diameter, Shaft Diameter - 1.385" Bore and 1.50" Square Bore, 8" Pitch, Square Bottom Drive, Round Top Drive For Older Open Gearbox	AM132434C1	\$ 520.00	
1440, 1460, 1480, 1640, 1660, 1680 - Early models that have been retrofitted to or updated w/ new enclosed gearbox	Vertical Unloading Auger Extended Wear, 50 1/2" Overall Length, Right Hand Fighting, 11.60" Fighting Diameter, Shaft Diameter - 1 3/8" Bore and 1 3/8"-6 Internal Spline, 8" Pitch	AM1347341C1	\$ 546.00	
1640 ASN 97103, 1644, 1660 ASN 102897, 1666, 1680 ASN 115352, 1688, 2144, 2166, 2188, 2344, 2366, 2388, 2588	Vertical Unloading Auger Extended Wear, Single Fighting 49 1/8" Overall Length, Right Hand Fighting, 11.60" Fighting Diameter, Shaft Diameter - 1 1/4"-19 Internal Spline and 1 3/8"-6 Internal Spline, 8" Pitch Replaces 87325666	AM1347389C1	\$ 399.00	
5088, 5130, 5140, 5150, 6088, 6130, 6140, 6150, 7010, 7088, 7120, 7130, 7140, 7150, 7230, 7250, 8010, 8120, 8250, 9120, 9250, AFX8010	Vertical Unloading Auger, Extended Wear Extended Wear, 47" Overall Length, Left Hand Fighting, 14 1/2" Fighting Diameter, Shaft Diameter - 8 Internal Spline Both Ends, 11 1/2" Pitch Replaces 84447940, 87733266	AM87756536	\$ 950.00	
	Unloading Auger Drive Hub (2) Required per Auger	AM87011705	\$ 21.00	
(7230, 8230 - w/ High Capacity and Non-Common Cab or All w/ Common Cab), (7240, 8240, 9240 BSN YGG231218), 9230	Vertical Unloading Auger, Extended Wear Extended Wear, 41 1/4" Overall Length, Left Hand Fighting, 15 1/2" Fighting Diameter, Shaft Diameter - 24 Internal Spline Both Ends, 10 1/2" Pitch	AM84522663	\$ 1100.00	
(7230, 8230, 9230 - w/ Common Cab), (7240, 8240, 9240 ASN YGG231219 Excluding MY18), (7250, 8250, 9250 - MY19)	Vertical Unloading Auger, Extended Wear Extended Wear, High Capacity, 41 1/4" Overall Length, Left Hand Fighting, 15 1/2" Fighting Diameter, Shaft Diameter - 8 Internal Spline and 8 Internal Spline, 10 1/2" Pitch Replaces 47886358	AM47886360	\$ 825.00	
5088, 5130, 5140, 6088, 6130, 6140, 7010, 7088, 7120, 7130, 7140, 7230, 8010, 8120, 9010, 9120 Will not fit models w/ cast Unloading Auger Elbow	Vertical Unloading Auger Liner Kit Includes Repair Ring and Full Sump Liner Kit All Weld-In Only	AMX29088	\$ 1125.00	
7230, 7240, 7250, 8230, 8240, 8250, 9230, 9240, 9250 For Models w/ Cast Iron Unloading Auger Elbow	Vertical Unloading Auger Liner	AMX29145	\$ 1125.00	
5088, 5130, 5140, 6088, 6130, 6140, 7088, 7130, 7140	Cone	AM87695821	\$ 30.00	
	Unloading Auger Drive Coupling	AM87470291	\$ 150.00	
1640, 1644, 1660, 1666, 1680, 1688, 2144, 2166, 2188, 2344, 2366, 2377, 2388	Unloading Auger Output Shaft	AM1989463C1	\$ 123.00	
1640 ASN JJC0034705, 1644, 1660 ASN JJC0037346, 1666, 1680 ASN JJC0045689, 1688, 2144, 2166, 2188, 2344, 2388, 2588	Unloading Auger Gearbox, Lower	AM1347336C2	\$ 825.00	
5088, 5130, 5140, 5150, 6088, 6130, 6140, 6150, 7010, 7088, 7120, 7130, 7140, 7150, 7230, 7240, 7250, 8010, 8120, 8230, 8240, 8250, 9010, 9120, 9230, 9240, 9250, AFX8010	Unloading Auger Gearbox, Lower	AM84320052	\$ 955.00	

Case IH®—Combine

Application	Description	Part Number	Retail Price	Core
1640, 1644, 1660, 1666, 1688, 2144, 2166, 2188, 2344, 2366, 2377, 2388	Gearbox Input Shaft	AM1989462C1	\$ 75.00	
5088, 5130, (5140, 6140, 7140 - 03/2014-10/15), (5150, 6150, 7150 - Tier 3), 6088, 6130 w/ Common Cab, 7088, 7130 w/ Common Cab 2013	Vertical Gearbox Input Shaft	AM87491122	\$ 325.00	
(5140, 6140, 7140 - 10/2015-08/18), 5150 10/2018-07/19, 6150, 7010, 7120, 7150 Tier 4B, 7230, 7240, 7250, 8010, 8120, 8230, 8240, 8250, 9010, 9120, 9230, 9240, 9250, AFX8010	Vertical Gearbox Output Shaft	AM87441208	\$ 215.00	
5088, (5130, 6130 - w/ Common Cab 2013-03/14), (7130 w/Common Cab 2013), (5140, 6140, 7140 - 03/2014-10/15), 6088, 7088, (5150, 6150, 7150 - Tier 3)	Unloading Auger Bevel Gear	AM84437278	\$ 125.00	
5088, 5130, 5140, 6088, 6130, 6140, 7010, 7088, 7120, 7130, 7140, 8010, 8120, 9010, 9120	Repair Ring For Repair of Top of Vertical Unload Tube	AMX29111	\$ 62.00	
1440, 1460, 1480, 1620, 1640 BSN JJC0035422, 1660 BSN JJC040895, 1680 BSN JJC0047801	Roller Chain, Grain Tank Unloading Auger Drive 158 Links, Size 40 Chain	AM192927C91	\$ 30.00	
1620 BSN JJC0032630	Roller Chain, Grain Tank Unloading Auger Drive 158 Links, Size 50 Chain	AMX34116	\$ 40.00	
1620 ASN JJC0032629, 1644, 1666, 1688, 2144, 2166, 2188, 2344, 2366, 2377, 2388	Roller Chain, Grain Tank Unloading Auger Drive 150 Links, Size 40 Chain	AMX34118	\$ 30.00	
1640 ASN JJC0097102, 1660 ASN JJC0102896, 1680 ASN JJC0115351	Roller Chain, Grain Tank Unloading Auger Drive 154 Links, Size 40 Chain	AMX34117	\$ 30.00	
1640 SN JJC0035422-JJC0097103, 1660 SN JJC0040895-JJC0102897, 1680 SN JJC0047801-JJC0115352	Roller Chain, Grain Tank Unloading Auger Drive 162 Links, Size 40 Chain	AMX34119	\$ 30.00	
1680 ASN JJC0115351, 2577, 2588	Roller Chain, Grain Tank Unloading Auger Drive 124 Links, Size 50 Chain	AM87529598	\$ 35.00	
5088, 5130, 5140 Prior to MY18, 6130 - w/ Common Cab	Roller Chain, Grain Tank Unloading Auger Drive 266 Links, Size 60H Chain	AM87707588	\$ 90.00	
5140 (MY18), 5150, 6130 w/ Non-Common Cab, 6140, 6150, 7130, 7140	Roller Chain, Grain Tank Unloading Auger Drive 246 Links, Size 60H Chain Replaces 84250965	AM47694331	\$ 90.00	
6088, 7088	Roller Chain, Grain Tank Unloading Auger Drive 248 Links, Size 60H Chain Replaces 87524544	AM87713148	\$ 90.00	
7010, 7120, (7250, 8250, 9250 - Single Drive), 8010, 8120, 9010, 9120, 9240 (MY18), AFX8010	Roller Chain, Grain Tank Unloading Auger Drive 284 Links, Size 60H Chain	AM86998066	\$ 90.00	
7010, 7120, 8010, 8120, 9010, 9120, AFX8010	Roller Chain, Grain Tank Unloading Auger Drive 288 Links, Size 60H Chain	AM87680581	\$ 90.00	
7230, 7240, 8230, 8240, 9230, 9240 MY18 w/o Redekop™ Option	Roller Chain, Grain Tank Unloading Auger Drive 220 Links, Size 80 Chain Replaces 84375704	AM84566255	\$ 115.00	
7230, (7240, 8240 Prior to MY18), 7250, 8230, 8250, 9230 - w/ Non-Common Cab, 9240 09/2015 and Later w/o Redekop™ Option	Roller Chain, Grain Tank Unloading Auger Drive Dual Drive, 199 Links, Size 60H Chain	AM84345681	\$ 65.00	
7240 (MY18 w/o Redekop™ Option), 7250, 8230, 8240 (MY18), 8250, 9230 w/ Common Cab, 9240 w/o Redekop™ Option	Roller Chain, Grain Tank Unloading Auger Drive Dual Drive, 192 Links, Size 60H Chain	AM84351953	\$ 65.00	
5088, 5130, 5140 Prior to MY18, 6130 - w/ Common Cab	Roller Chain, Vertical Auger Drive 266 Links, Size 60H Chain	AM87707588	\$ 90.00	
5140 (MY18), 5150, 6130 w/ Non-Common Cab, 6140, 6150, 7130, 7140	Roller Chain, Vertical Auger Drive 246 Links, Size 60H Chain Replaces 84250965	AM47694331	\$ 90.00	
6088, 7088	Roller Chain, Vertical Auger Drive 248 Links, Size 60H Chain Replaces 87524544	AM87713148	\$ 90.00	

Prices Subject to Change without Prior Notice. The use of original equipment manufacturer (OEM) part numbers or trademarks, e.g. Case® and John Deere®, are for reference purposes only and for indicating product use and compatibility. Our company and the listed replacement parts contained herein are not sponsored, approved or manufactured by the OEM. All parts are New unless designated Reman in the description.

Case IH®—Combine

Application	Description	Part Number	Retail Price	Core
7010, 7120, 8010, 8120, 9010, 9120, AFX8010	Roller Chain, Vertical Auger Drive 288 Links, Size 60H Chain	AM87680581	\$ 90.00	
7230, 7240, 8230, 8240, 9230, 9240 MY18 w/o Redekop™ Option	Roller Chain, Vertical Auger Drive 220 Links, Size 80 Chain Replaces 84375704	AM84566255	\$ 115.00	
1440, 1460, 1480, 1620 ASN JJC032629, 1640 BSN JJC097103, 1660 BSN JJC0102897, 1680 BSN JJC0115352	Roller Chain, Vertical Unloading Auger Drive 134 Links, Size 50 Chain	AMX34120	\$ 40.00	
1620 BSN JJC032630, 1640 ASN JJC097103, 1660 ASN JJC0102896, 1666, 1688, 2144, 2166, 2188, 2344, 2366, 2377, 2388	Roller Chain, Vertical Unloading Auger Drive 131 Links, Size 50 Chain	AM1303207C91	\$ 53.00	
1644	Roller Chain, Vertical Unloading Auger Drive 130 Links, Size 50 Chain	AMX34121	\$ 40.00	
2577, 2588	Roller Chain, Vertical Unloading Auger Drive 107 Links, Size 60 Chain	AMX34122	\$ 60.00	
7230, 7240, 7250, 8230, 8240, 8250, 9230, 9240 w/o Redekop™ Option	Roller Chain, Vertical Unloading Auger Drive Dual Drive, 167 Links, Size 60H Chain Replaces 84525580	AM51436188	\$ 65.00	

Augers & Components—Horizontal Unloading

All augers are made with continuous roll-formed flighting for accuracy and durability.



Application	Description	Part Number	Retail Price	Core
1420, 1440, 1460, 1470, 1480, 1482	Horizontal Unloading Auger Tube - Rear	87" AM195342C1	\$ 494.00	
	Horizontal Unloading Auger Extended Wear, Right Hand Flighting, 11 1/2" Flighting Diameter, Shaft Diameter - 1" and 1.385" Bore, 11 1/2" Pitch 1-Piece Setup	143 3/8" AM192845C2	\$ 625.00	
	Bearing	AM160796C91	\$ 11.84	
1460, 1470, 1480, 1482	Horizontal Unloading Auger Tube - Front	85.50" AM192089C1	\$ 509.00	
	Horizontal Unloading Auger Tube - Rear	87" AM195342C1	\$ 494.00	
	Horizontal Unloading Auger Extended Wear, Early Style Smooth Hole, Right Hand Flighting, 11 1/2" Flighting Diameter, Shaft Diameter - 1" and 1 3/8" Bore, 13" Pitch 1-Piece Setup, 172"	182 1/8" AM1317935C1	\$ 677.00	
	Bearing	AM160796C91	\$ 11.84	
1600 Series Early, Smooth Hole	Horizontal Unloading Auger Tube - Front	90" AM1317738C1	\$ 567.00	
	Horizontal Unloading Auger Tube - Rear	82.50" AM1317783C2	\$ 425.00	
	Horizontal Unloading Auger Extended Wear, 1-Piece Setup, 172"	182 1/8" AM1317935C1	\$ 677.00	
	Bearing - 2 Required	AM160796C91	\$ 11.84	
1600 Series Late, Splined Hole	Horizontal Unloading Auger Tube - Front	90" AM1317738C1	\$ 567.00	
	Horizontal Unloading Auger Tube - Rear	82.50" AM1317783C2	\$ 425.00	
	Horizontal Unloading Auger Extended Wear, Right Hand Flighting, 11 1/2" Flighting Diameter, Shaft Diameter - 1" and 1 1/4"-19 Internal Spline, 11 3/4" Pitch	180 1/2" AM1347499C1	\$ 830.00	
	Bearing For 172" 1-Piece Setup	AM160796C91	\$ 11.84	
1620, 1640, 1644, 1660, 1666, 1680, 1688, 2144, 2166, 2188, 2344, 2366, 2377, 2388 BSN 300000	Horizontal Unloading Auger Tube - Front Perforated 1-Piece or 2-Piece Setup, 168" or 204"	90" AM1317873C1	\$ 673.00	

Case IH®—Combine

Application	Description	Part Number	Retail Price	Core
1620, 1640, 1644, 1660, 1666, 2144, 2166	Horizontal Unloading Auger Tube - Rear Replaces 1317734C1, 1317734C2, 1317734C3	136" AM1317734C4	\$ 381.00	
1640, 1644, 1660, 1666, 1670, 1680, 1688, 2144, 2166, 2188, 2344, 2366, 2388	End Cap, Horizontal Unloading Auger Tube Replaces 182837C1	AM182837C2	\$ 131.00	
(1640, 1660, 1680 Early)	Horizontal Unloading Auger Tube - Front	90" AM1317738C1	\$ 567.00	
	Horizontal Unloading Auger Tube - Rear	82.50" AM1317783C2	\$ 425.00	
	Horizontal Unloading Auger - Front Extended Wear, Right Hand Flighting, 11 1/2" Flighting Diameter, Shaft Diameter - 1" Hex Bore and 1.378" Bore, 11 3/4" Pitch	91 1/8" AM1317891C1	\$ 441.00	
	Horizontal Unloading Auger - Rear Extended Wear, Right Hand Flighting, 11 1/2" Flighting Diameter, Shaft Diameter - 1" and 1" Hex Bore, 11 3/4" Pitch Replaces 183925A1, 199018A1, 199018A2, 1317680C1	88 3/4" AM1317680C2	\$ 368.00	
	Bearing Support Use w/ Split Unloading Auger	AM1317859C1	\$ 54.00	
	Bearing	AMJD9313	\$ 11.00	
	Hex Shaft 2-Piece Setup	172" AM220040A2	\$ 20.00	
(1640, 1660, 1666, 1680, 1688, 2144, 2166, 2188, 2344, 2366, 2388 Late)	Horizontal Unloading Auger Tube - Front	90" AM1317738C1	\$ 567.00	
	Horizontal Unloading Auger Tube - Rear	82.50" AM1317783C2	\$ 425.00	
	Horizontal Unloading Auger - Front Extended Wear, Right Hand Flighting, 11 1/2" Flighting Diameter, Shaft Diameter - 1/4"-19 Internal Spline and 1" Hex Bore, 13" Pitch Replaces 198987A1, 1989388C1, 1989388C2	90 1/2" AM198987A2	\$ 614.00	
	Horizontal Unloading Auger - Rear Extended Wear, Right Hand Flighting, 11 1/2" Flighting Diameter, Shaft Diameter - 1" and 1" Hex Bore, 11 3/4" Pitch Replaces 183925A1, 199018A1, 199018A2, 1317680C1	88 3/4" AM1317680C2	\$ 368.00	
	Bearing Support Use w/ Split Unloading Auger	AM1317859C1	\$ 54.00	
	Bearing	AMJD9313	\$ 11.00	
	Hex Shaft 2-Piece Setup	172" AM220040A2	\$ 20.00	

Case IH®—Combine

Application	Description	Part Number	Retail Price	Core	
(1644, 1660, 1666, 1680, 1688, 2144, 2166, 2188, 2344, 2366, 2388 Late)	Horizontal Unloading Auger Tube - Front	90" AM1317738C1	\$ 567.00		
	Horizontal Unloading Auger Tube - Rear	118" AM1317899C3	\$ 457.00		
	Horizontal Unloading Auger - Front Extended Wear, Right Hand Flighting, 11 1/2" Flighting Diameter, Shaft Diameter - 1/4"-19 Internal Spline and 1" Hex Bore, 13" Pitch Replaces 198987A1, 1989388C1, 1989388C2	90 1/2" AM198987A2	\$ 614.00		
	Horizontal Unloading Auger - Rear Extended Wear, Right Hand Flighting, 11 1/2" Flighting Diameter, Shaft Diameter - 1" and 1" Hex Bore, 11 3/4" Pitch Replaces 199023A1, 1321147C1, 1321147C2, 87379141	125" AM199023A2	\$ 635.00		
	Bearing	AM160796C91	\$ 11.84		
	Bearing Support Use w/ Split Unloading Auger	AM1317859C1	\$ 54.00		
	Bearing	AMJD9313	\$ 11.00		
	Hex Shaft 2-Piece Setup, 208" Overall	172" AM220040A2	\$ 20.00		
	1644, 1660, 1666, 1680, 1688, 2144, 2166, 2188, 2344, 2366, 2388, 2588	Horizontal Unloading Auger Outer Tube	142" AM1317899C3-3	\$ 560.00	
		Horizontal Unloading Auger - Rear Extended Wear, Right Hand Flighting, 11 1/2" Flighting Diameter, Shaft Diameter - 1" and 1" Hex Bore, 11 3/4" Pitch Note: 1-Piece Extender Setup extends Unloading Auger to 236", Tube and Auger must be used together	147 1/2" AM199023A2-3	\$ 683.00	
2577, 2588	Horizontal Unloading Auger Tube - Front Solid Tube Replaces 87556840	126" AM87557135	\$ 1067.00		
	Horizontal Unloading Auger Tube - Front Perforated Tube Replaces 87517336, 87556844	126" AM87557138	\$ 1075.00		
	Horizontal Unloading Auger Tube - Rear 18' Setup Replaces 87398374, 87557244	82.50" AM87581650	\$ 931.00		
	Horizontal Unloading Auger Tube - Rear 21' Setup Replaces 87389564, 87398396, 87542332	118.50" AM87581654	\$ 1019.00		
	Horizontal Unloading Auger - Rear 18' Setup Replaces 183925A1, 199018A1, 199018A2	89.25" AM87557246	\$ 686.00		
	Bearing	AM160796C91	\$ 11.84		
	Horizontal Unloading Auger For 18' and 21' Systems	AM87556898	\$ 950.24		
	5088, 5130, 5140, 5150, 6088, 6130, 6140, 6150, 7010, 7088, 7120, 7130, 7140, 7150, (7230, 8230, 9230 - Tier 4 03/2012-13), (7240, 8240, 9240 - MY18), 7250, 8010, 8120, 8250, 9010, 9120, 9250, AFX8010	Horizontal Unloading Auger Extended Wear, Left Hand Flighting, 12 1/2" Flighting Diameter, Shaft Diameter - 1.18" and 8 Internal Spline, 16" Pitch Replaces 84073843, 87280339, 87560311, 87575221	214 15/16" AM84447941	\$ 1339.00	
Bearing		AMJD10384	\$ 22.00		
5088, 5130, (5140, 6140, 7140 - Tier 4B 03/2014-10/15), 6088, 6130, 7088, 7120, 7130, (7230, 8230, 9230 - Tier 4 03/2012-13), 8120, 9120	Horizontal Unloading Auger Tube Standard Rate, Red Tube Machines, 19-Hole Mounting Flange For 21' System Replaces 87738223	198.25" AM87743673	\$ 1470.00		





Case IH®—Combine

Application	Description	Part Number	Retail Price	Core
5088, 5130, 5140, 5150, 6088, 6130, 6140, 6150, 7010, 7088, 7120, 7130, 7140, 7150, 7230, 7250, 8010, 8120, 8230, 8250, 9010, 9120, 9230, 9250, AFX8010	Horizontal Unloading Auger Replaces 84331632, 87280340, 87280341, 87575225, 87657822	38" AM87575223	\$ 832.41	
	Horizontal Unloading Auger Extension Extended Wear, 3' Extension, 21 Spline, 4.50" Tube Diameter Replaces 87280340, 87280341, 87575225	38" AM87657822	\$ 846.40	
	Horizontal Unloading Auger Tube 3' Extension Replaces 87552536	AM87470153	\$ 890.00	
	Bearing	HC207-22	\$ 23.06	
5088, 6088, 7010, 7088, 7120, 8010, 8120, 9120	Bearing Support Use w/ 3" Unloading Auger Extension	AM84072623	\$ 32.97	
7010, 8010, AFX8010	Horizontal Unloading Auger Tube Extended Wear Replaces 87280552, 87284775	216" AM87470158	\$ 2283.57	
7010, 8010, 9010	Horizontal Unloading Auger Extended Wear, 4.50" Tube Diameter Replaces 87280358, 87318083, 87575221	212.50" AM87729509	\$ 1500.75	
	Bearing	AMJD10384	\$ 22.00	
(7230, 8230, 9230 - w/ Common Cab 2013-09/14), (7240, 8240, 9240 - Prior to MY18)	Horizontal Unloading Auger Extension Extended Wear, 5' Extension, Left Hand Flighting, 14" Flighting Diameter, Shaft Diameter - 1 3/4" and 24 Internal Spline, 4.50" Tube Diameter, 14" Pitch Replaces 47395184, 84362490, 84384607	64 1/4" AM47395186	\$ 1040.00	
	Bearing w/ Lock Collar	AM84416910	\$ 52.13	
(7230, 8230, 9230 - w/ Common Cab 2013-09/14), 7240, 7250, 8240, 8250, 9240, 9250	Horizontal Unloading Auger - Rear Outer Fold Extended Wear Replaces 47395202, 47425443, 84365603, 84416898, 84529926	95.25" AM47445370	\$ 1401.77	
	Bearing w/ Lock Collar	AM84489731	\$ 37.17	
7230, 7240, 8230, 8240, 9230, 9240	Unloading Auger Tube Solid Tube Outer Section for 21' High Unload Auger	194 5/8" AM47405760	\$ 1828.00	
7230, (7240, 8240 BSN YGG231218), 8230, 9230, 9240	Horizontal Unloading Auger Extended Wear, High Capacity, Left Hand Flighting, 14" Flighting Diameter, Shaft Diameter - 1 3/16" and 24 Internal Spline 14 1/2" Pitch	228 3/8" AM47373691	\$ 2025.00	
(7230, 8230, 9230 - w/ Common Cab 2013-09/14), (7240, 8240, 9240 - Prior to MY18), (7250, 8250, 9250 - Perforated)	Horizontal Unloading Auger Extended Wear, High Capacity, Left Hand Flighting, 14" Flighting Diameter, Shaft Diameter - 1 3/16" and 8 Internal Spline, 14 1/2" Pitch	227 5/8" AM47897750	\$ 1943.00	
	Bearing	AMJD10384	\$ 22.00	
(7230, 8230, 9230 - w/ Common Cab 2013-09/14), (7240, 8240, 9240 - Prior to MY18)	Horizontal Unloading Auger - Front Inner Fold Extended Wear, Left Hand Flighting, 14" Flighting Diameter, Shaft Diameter - 1.62" and 24 Internal Spline, 14" Pitch Replaces 84512841	90 1/2" AM47395188	\$ 1050.00	
	Bearing w/ Lock Collar	AM84416910	\$ 52.13	
	Horizontal Unloading Auger - Middle Inner Fold Extended Wear Replaces 47389784, 47395199, 84364992, 84416893	114.75" AM47476066	\$ 1570.27	
	Bearing w/ Lock Collar	AM84416910	\$ 52.13	





Case IH®—Combine

Application	Description	Part Number	Retail Price	Core
(7230, 8230, 9230 - w/ Common Cab ASN YGG231219), (7240, 8240, 9240 ASN YGG231219), 7250, 8250, 9250	Horizontal Unloading Auger Extension High Capacity Extension Extended Wear, Left Hand Flighting, 14" Flighting Diameter, Shaft Diameter - 1 5/8" and 8 Internal Spline, 14" Pitch Bearing w/ Lock Collar	72 1/4" AM47826369 AM84416910	\$ 1003.00 \$ 52.13	
(7230, 8230, 9230 - w/ Common Cab 2013-09/14), 7240, 7250, 8240, 8250, 9240, 9250	Horizontal Unloading Auger Extension Tube High Capacity, Cast Flange	60" AM84536432	\$ 2220.00	
7240, 8240, 9240 - Prior to MY18	Horizontal Unloading Auger - Front Inner Fold Extended Wear, Left Hand Flighting, 14" Flighting Diameter, Shaft Diameter - 1.62" and 24 Internal Spline, 14" Pitch Bearing w/ Lock Collar	116 5/8" AM47523765 AM84489731	\$ 1229.00 \$ 37.17	
	Horizontal Unloading Auger - Middle Inner Fold Extended Wear, Left Hand Flighting, 14" Flighting Diameter, Shaft Diameter - 1.382" and 24 Internal Spline, 14" Pitch Bearing w/ Lock Collar	91 3/4" AM47523269 AM84416910	\$ 998.00 \$ 52.13	
(1620, 1640, 1644, 1660, 1666, 1680, 1682, 1688 - w/ Spill Saver Attachment), 2144, 2166, 2188, 2344, 2366, 2377, 2388, 2577, 2588	Rubber Spout	AM113488A1	\$ 54.00	

Unloading Auger Elbows and Components

Application	Description	Part Number	Retail Price	Core
 1420, 1440, 1460, 1480, 1640, 1644, 1660, 1666, 1670, 1680, 1682, 1688, 2144, 2166, 2188, 2344, 2366, 2377, 2388, 2577, 2588	Unloading Auger Elbow 19-Bolt Tube Mount Replaces 248308A1, 248308A2, 1989472C1, 87398012	AM87598258	\$ 535.00	
 5088, 5130, 5140, 5150, 6088, 6130, 6140, 6150, 7010, 7088, 7120, 7130, 7140, 7150, (7230, 8230, 9230 - w/ Non-Common Cab, 03/2012-01/13), (7240, 8240, 9240 - MY18), 7250, 8010, 8120, 8250, 9010, 9120, 9250	Unloading Auger Elbow Standard Capacity 19-Bolt Tube Mount Replaces 87474233, 87552529, 87754415	AM84126361	\$ 1725.00	
 5088, 5130, 5140, 5150, 6088, 6130, 6140, 6150, 7010, 7088, 7120, 7130, 7140, 7150, (7230, 8230, 9230 - w/ Non-Common Cab), (7240, 8240, 9240 - MY18), 7250, 8010, 8120, 8250, 9010, 9120, 9250, AFX8010	Unloading Auger Elbow Bushing 1.57" Tall, 16.06" ID, 17.32" OD	AM86558526	\$ 68.00	
 (7230, 7240, 7250, 8230, 8240 (MY18), 8250, 9230, 9240 (MY18), 9250 - w/ High Capacity Unloading System), (7230, 7240, 8240 (Prior to MY18), 9240 - w/ 21' High Speed, High Capacity Unloading System), (7230, 8230, 9230 - w/ High Speed, Folding Unloading System and w/ Common Cab 03/2012-09/14), (7240, 8240 (Prior to MY18), 9240 - w/ High Capacity Unloading System w/ Folding Top), (8230, 9230 - w/ 21' High Speed, High Capacity Unloading System and w/ Common Cab 03/2012-09/14)	Unloading Auger Elbow High Capacity, 10-Bolt Tube Mount Replaces 47463149	AM84345590	\$ 3650.00	

Case IH®—Combine

Application	Description	Part Number	Retail Price	Core
AFX8010	Unloading Auger Elbow Black Replaces 87044522, 87280557, 87281407, 87354631, 87757649	AM84126362	\$ 1825.00	
 1640, 1644, 1660, 1666, 1670, 1680, 1682, 1688, 2144, 2166, 2188, 2344, 2366, 2388	Unloading Auger Gearbox	AM1347351C2	\$ 775.00	
 5088, 5130, 5140, 6088, 6130, 6140, 7010, 7088, 7120, 7130, 7140, 7230, (7240, 8240, 9240 - MY18), 7250, 8010, 8120, 8230, 8250, 9010, 9120, 9230, 9250, AFX8010	Unloading Auger Gearbox Standard Unload Rate w/ 24 Spline Output Shaft w/ 16 Tooth Inner Bevel Gear Replaces 84320130, 86523576	AM87331084	\$ 940.00	
7130, 7230, 7240, 7250, 8250, 8230, 8240, 9230, 9240, 9250	Upper Unloading Auger Gearbox High Capacity Gearbox w/ 24 Spline Output Shaft w/ 16 Tooth Inner Bevel Gear Replaces 47919991, 84262051	AM47941493	\$ 1320.00	
5088, 5130, 5140, 6088, 6130, 6140, 7010, 7088, 7120, 7130, 7140, 7230, 7240, 8010, 8120, 8230, 8240, 9010, 9120, 9230, 9240, AFX8010	Upper Unloading Auger Gearbox Shaft 15 Tooth, 21 Spline, 6.34" Long	AM87331114	\$ 275.00	
 5088, 5130, 5140, 6088, 6130, 6140, 7010, 7088, 7120, 7130, 7140, 7230, 7240, 8010, 8120, 8230, 8240, 9010, 9120, 9230, 9240, AFX8010	Lower Unloading Auger Gearbox Shaft 8 & 21 Spline, 7.81" Long	AM86623219	\$ 131.81	
7230, 7240, 7250, 8230, 8240, 8250, 9230, 9240, 9250	Vertical Unloading Auger Gearbox Top Plate High Capacity	AM84344564	\$ 120.00	
1420, 1440, 1460, 1480, 1620, 1640 BSN JJC0097103, 1660 BSN JJC0102897, 1680 BSN JJC0115352	Upper Unloading Auger Gearbox Gear 18 Tooth, (2) Required Replaces 1300283C1, 1309380C1	AM1324929C1	\$ 104.00	
 1640, 1644, 1660, 1666, 1670, 1680, 1682, 1688, 2144, 2166, 2188, 2344, 2366, 2377, 2388	Gear	AM1347260C1	\$ 120.00	
 815, 915	Unloading Vertical Auger Gear Set	AM166063C91	\$ 89.27	

Unloading Drive Components

Application	Description	Part Number	Retail Price	Core
5088, 5130, 5140, 6088, 6130, 6140, 7010, 7088, 7120, 7130, 7140, 7230, 8010, 8120, 8230, 9010, 9120, 9230, AFX8010	Unloading Auger Drive Hub 21 Tooth Replaces 84073608, 84073843, 86563106	AM87011705	\$ 21.00	
1420, 1440, 1460, 1470, 1480, 1620, 1640, 1660, 1670, 1680	Grain Tank Unloader Drive Sprocket 43 Tooth, 1" ID, 7.13" OD For Size 40 Chain	AM192922C1	\$ 35.00	
1440, 1460, 1470, 1480	Grain Tank Unloader Drive Sprocket 33 Tooth, 1.127" ID, 6.92" OD For Size 50 Chain Replaces 192199C1	AM192199C2	\$ 29.50	
1440, 1470, 1480, 1620, 1640 BSN 97103, 1660 BSN 80540, 1670 BSN 102896	Grain Tank Unloader Drive Sprocket 37 Tooth, 1" ID, 6.21" OD For Size 40 Chain	AM192925C1	\$ 30.00	

Case IH®—Combine

Application	Description	Part Number	Retail Price	Core
1460, 1480, 1482, 1620 ASN JJC0032630, 1640 ASN JJC0034705, 1644, 1660 ASN JJC0038346, 1666, 1670 ASN JJC0080540, 1680 ASN JJC0045689, 2188, 2388 SN HAJ292001-HAJ300000, 2588	Grain Tank Unloader Drive Sprocket 49 Tooth, 1" ID, 8.09" OD For Size 40 Chain	AM187331C1	\$ 39.00	
1620, 1640, 1660, 1670	Grain Tank Unloader Drive Sprocket 33 Tooth, 1.132" & 1.25" ID, 6.92" OD	AM1321167C92	\$ 29.00	
1640 ASN 97103, 1644, 1660 ASN 102897, 1666, 1680 ASN 115352, 1688, 2144, 2166, 2188, 2344, 2366, 2377, 2388	Grain Tank Unloader Drive Sprocket 33 Tooth	AM1347360C1	\$ 60.00	
	Bushing 1.254" ID, 1.408" OD, 0.75" Wide Replaces A58376	AM1347384C1	\$ 10.67	
2388 ASN HAJ300001, 2577, 2588	Chain Drive Double Sprocket 43 & 25 Tooth	AM87525821	\$ 190.00	
2144, 2166, 2188, 2344, 2366, 2377 ASN HAJ0292001, 2388 SN JJC0268800-JJC0270499 & ASN HAJ0292001	Hydraulic Cylinder 1.25" ID, 2.75" Stroke For Unloader Clutch Replaces 112397A2	AM87337242	\$ 200.00	
1640 ASN JJC0097103, 1644, 1660 ASN JJC0038345, 1666, 1680 ASN JJC0115351, 1688, 2144, 2166, 2188, 2344, 2366, 2377, 2388	Grain Tank Unloader Jackshaft Driven Pulley Replaces 1994762C1	AM1994762C2	\$ 78.50	
1640 ASN JJC0097103, 1644, 1660 ASN JJC0102897, 1666, 1680 ASN JJC0115352, 1688, 2144, 2166, 2188, 2344, 2366, 2377, 2388, 2577, 2588	Bearing, Unloader Belt or Chain Drive Replaces 610188R91, 70017774, K3315	AM565673R92	\$ 19.90	
1440, 1470, 1480, 1482, 1620, 1640, 1644, 1660, 1666, 1680, 1682, 1688, 2144, 2166, 2188, 2344, 2366, 2388, 2577, 2588	Unloading Auger Speed Up Sprocket Replaces 1347360C1	AMX29175	\$ 325.00	
5088, 5130, 5140, 5150, 6088, 6130, 6150, 7010, 7088, 7120, 7130, 7140, 7150, 8010, 8120, 9120	Flagship High Speed Sprocket Replaces 84069795	AMX29176	\$ 350.00	
1640 ASN JJC0034705, 1644, 1660 ASN JJC0038346, 1666, 1680 ASN JJC0115352, 1688, 2144, 2166, 2188, 2344, 2366, 2388	Unloader Drive Sprocket, Lower 33 & 57 Tooth, 1.38" Bore	AM1347402C1	\$ 135.00	
7010, 7120, 8010, 8120, 9120, AFX8010	Unloader Drive Sprocket 38 Tooth	AM84069777	\$ 80.69	
5088, 5130, 5140, 6088, 6130, 6140, 7010, 7088, 7120, 7230, 7240, 8010, 8120, 8230, 8240, 9120, 9130, 9240, AFX8010	Unloader Idler Sprocket 15 Tooth	AM86627639	\$ 20.00	
7010, 7120, 8010, 8120, 9120, AFX8010	Unloading Auger Drive Pulley 2-Groove, 6.50" OD	AM86999121	\$ 87.59	
7010, 7120, 7240, 8010, 8120, 8240, 9010, 9120, 9240	Unloader Drive Shaft 20.31" Long	AM87602267	\$ 145.63	
7230, 8230, 9230	Unloading Auger Tensioner Cylinder	AM84300068	\$ 375.00	

Augers—Grain Tank Bottom

All augers are made with continuous roll-formed flighting for accuracy and durability.

Application	Description	Part Number	Retail Price	Core
1440, 1460, 1470, 1480, 1482, 1640, 1644, 1660, 1666, 1670, 1680, 1682, 1688, 2144, 2166, 2188, 2344, 2366, 2388	Grain Tank Bottom Auger 110 1/8" Overall Length, Left Hand Flighting, 7" Flighting Diameter, 1" Shaft Diameter, 7" Pitch Replaces Both Front and Rear Augers	AM192784C3	\$ 410.00	
	Grain Tank Bottom Auger Extended Wear-Sectional, 110 1/8" Overall Length, Right Hand and Left Hand Flighting, 7" Flighting Diameter, Shaft Diameter - 0.859" and 1", 7" Pitch	AM390556A1	\$ 551.00	
	Bearing	NPS100RPC	\$ 6.50	

Case IH®—Combine

Application	Description	Part Number	Retail Price	Core
5088, 5130, 5140, 5150, 6088, 6130, 6140, 6150, 7088, 7130, 7140, 7150	Grain Tank Bottom Auger, Front Replaces 87280349	AM84075321	\$ 450.00	
	Grain Tank Bottom Auger, Rear Replaces 87280347	AM84075322	\$ 450.00	
	Bearing - Cover End	AMJD10384	\$ 22.00	
7010, 7120, 7230, 7240, 7250, 8010, 8120, 8230, 8240, 8250, 9010, 9120, 9230, 9240, 9250 - Extended Wear	Grain Tank Bottom Auger, Front Extended Wear, 120 3/4" Overall Length, Right Hand Flighting, 8 1/4" Flighting Diameter, Shaft Diameter - 2" and 1.18", 9 3/8" Pitch Replaces 84075319	AM87280345	\$ 387.00	
	Bearing - Cover End	AMJD10384	\$ 22.00	
(7010, 7120, 8010, 8120, 9010, 9120, AFX8010 - Extended Wear), (7230, 8230, 9230 - Extended Wear and Extended Wear High Capacity both w/ Non-Common Cab 03/2012-01/13), (7240, 7250, 8240, 8250, 9240, 9250 - Extended Wear High Capacity)	Grain Tank Bottom Auger, Rear Extended Wear, 120 3/4" Overall Length, Right Hand Flighting, 8 1/4" Flighting Diameter, Shaft Diameter - 2" and 1.18", 9 3/8" Pitch Replaces 84075320	AM87280343	\$ 504.00	
	Bearing - Cover End	AMJD10384	\$ 22.00	
7230, 7240, 7250, 8230, 8240, 8250, 9230, 9240, 9250	Grain Tank Bottom Auger, Front Extended Wear, High Capacity, 122 3/8" Overall Length, Left Hand Flighting, 9 1/2" Flighting Diameter, Shaft Diameter - 1 3/8" and 1 1/2", 10" Pitch Replaces 84348185	AM84368833	\$ 872.00	
	Grain Tank Bottom Auger, Rear Extended Wear, High Capacity, 122 3/8" Overall Length, Right Hand Flighting, 9 1/2" Flighting Diameter, Shaft Diameter - 1 3/8" and 1 1/2", 10" Pitch Replaces 84348188	AM84368835	\$ 966.00	
	Bearing - Cover End	HC207-22	\$ 23.06	

Straw Spreader Shafts and Components

Application	Description	Part Number	Retail Price	Core
1420, 1440, 1460, 1470, 1480, 1482, 1640, 1644, 1660, 1666, 1670, 1680, 1688	Straw Spreader Shaft, Vertical 10.625" Long, 0.875" Hex	AM192240C1	\$ 33.74	
	Bearing, Metal	AM195293C91	\$ 6.40	
1440, 1460, 1470, 1640, 1644, 1660, 1666, 1670, 2144, 2166, 2344, 2366	Straw Spreader Shaft, Horizontal 47.50" Long, 0.875" Hex	AM192242C4	\$ 90.00	
1480, 1482, 1680, 1682, 1688, 2188, 2388	Straw Spreader Shaft, Horizontal 58" Long, 0.875" Hex	AM192241C4	\$ 128.85	
1644, 1666, 1688, 2144, 2166, 2188, 2344, 2366, 2377, 2388, 2577, 2588	Straw Spreader Shaft 12" Long	AM128440A1	\$ 45.00	
1688, 2144, 2166, 2188, 2344, 2366, 2388, 2577, 2588	Straw Spreader Shaft 12" Long Replaces 109485A1	AM84224477	\$ 38.00	
2377, 2388 ASN JJC0270500, 2577, 2588	Straw Spreader Shaft 0.875" Diameter, 57.50" Long	AM427270A1	\$ 70.00	
5088, 6088, 7088	Straw Spreader Shaft	AM84163923	\$ 48.00	
5088, 5130, 5140, 6088, 6130, 6140, 7088, 7130, 7140	Bevel Gear For Straw Spreader Drive, Powershift	AM84467465	\$ 40.00	
(2577, 2588 - w/ Straw and Chaff Spreaders)	Cleaning Shoe Door Shield	AM87381635	\$ 152.00	
5088, 5130, 5140, 6088, 6130, 6140, 7088, 7130, 7140 - w/ Straw Spreader	Side Curtain	AM87478159	\$ 94.00	
5088, 5130, 5140, 6088, 6130, 6140, 7088, 7130, 7140 - w/ Straw and Chaff Spreader	Cleaning Shoe Door Shield	AM87684740	\$ 158.00	
7010, 7120, 7130, 7230, 7240, 8010, 8120, 8230, 8240, 9120, 9230, 9240	Rubber Curtain Replaces 84384419	AM87752499	\$ 105.76	

Case IH®—Combine

Application	Description	Part Number	Retail Price	Core
1688, 2188, 2377, 2388, 2577, 2588, 5088, 5130, (5140, 6140, 7140 - Prior to 11/2015), 6088, 6130, 7088, 7130, 7230, 8230, 9230	Straw Spreader Blade, Right Hand Curved Replaces 371055A1, 87324976	AM87726624	\$ 35.00	
1688, 2188, 2377, 2388, 2577, 2588, 5088, 5130, (5140, 6140, 7140 - Prior to 11/2015), 6088, 6130, 7088, 7130	Straw Spreader Blade, Left Hand Curved Replaces 371056A1, 87324975	AM87726623	\$ 34.00	
7230, 7240, 7250, 8230, 8240, 8250, 9230, 9240, 9250	Straw Spreader Spider, Right Hand 2.49" ID	AM84132360	\$ 120.00	
	Straw Spreader Spider, Left Hand 2.49" ID	AM84132358	\$ 120.00	
7230, 7240, 7250, 8230, 8240, 8250, 9230, 9240, 9250	Straw Spreader Paddle, Right Hand 12.30" Long, 9.72" Wide	AM87541487	\$ 66.00	
	Straw Spreader Paddle, Left Hand 12.30" Long, 9.72" Wide	AM87541485	\$ 66.00	
2377, 2388, 2577, 2588	Straw Spreader Rubber Guard Hardware Not Included	AM140277A1	\$ 45.90	
1440, 1460, 1480, 1640, 1644, 1660, 1666, 1680, 1688, 2144, 2166, 2188, 2344, 2366, 2377, 2388, 2577 - w/ Straw Spreader	Spreader Side Shield	AM1308916C2	\$ 37.00	
2144, 2166, 2188, 2344, 2366, 2377, 2388 - w/ Straw and Chaff Spreader	Spreader Side Shield Replaces 103211A1	AM103211A2	\$ 46.50	
1420, 1440 ASN 20976, 1460 ASN 24300, 1480 ASN 24000, 1620, 1640, 1644, 1660, 1666, 1680, 1688, 2144, 2166, 2188, 2344 BSN JJC0174399, 2366 BSN JJC0252399, 2388 BSN JJC0270499	Driven Pulley, Straw Spreader 10" OD Replaces 108533A1, 181196C1	AM181196C2	\$ 146.10	
1644, 1660, 1666, 1680, 1688, 2144, 2166, 2188, 2344, 2366, 2377, 2388, 2577, 2588	Drive Pulley For Straw Spreader and Shaker Shaft	AM566516R92	\$ 74.00	
1420, 1440, 1460, 1470, 1480, 1482, 1620, 1640, 1644, 1660, 1666, 1670, 1680, 1682, 1688, 2144, 2166, 2188, 2366, 2388	Idler Pulley 1" Wide, 4.375" OD, 0.50" Hole Diameter Replaces 428848A1, 1315269C1	AM1315269C2	\$ 32.88	
1420, 1440, 1460, 1480, 1620, 1640, 1644, 1660, 1666, 1680, 1688, 2144, 2166, 2188, 2344, 2366, 2377, 2388, 2588, 5088, 5130, (5140, 6140, 7140 - Prior to 10/2015), 6088, 6130, 7088, 7130, (7230, 8230, 9230 - w/ Common Cab), 7240, 7250, 8240, 8250, 9240, 9250	Straw Spreader Cone Replaces 1882218C1, 188218C5, 188218C6	AM47442301	\$ 99.50	
1666, 1688, 2166, 2188, 2366, 2377, 2388, 2577, 2588, 5088, 5130, (5140, 6140, 7140 Prior to 10/2015), 6088, 6130, 7088, 7130, 7230, 7240, 7250, 8230, 8240, 8250, 9230, 9240, 9250	Straw Spreader Disc 35.50" OD, Aluminum For Straw or Chaff Spreader	AM140189A1	\$ 204.00	
7010, 7120, 8010, 8120, 9010, 9120, AFX8010	Finger Bar, Long	AM87282590	\$ 95.00	
	Finger Bar, Short	AM87282592	\$ 85.00	

Case IH®—Combine



Auger Extension Kits

These kits extend the length of your unloading auger approximately three feet and increase your clearance for larger platforms and grain carts. Includes spring-loaded grain saver.

Application	Description	Part Number	Retail Price	Core
1420, 1440, 1460, 1480, 1620, 1640, 1644, 1660, 1666, 1680, 1688, 2144, 2166, 2188, 2344, 2366, 2388	Unloading Auger Extension Kit, 3' For Combines using AMI's Unloading Auger w/ 3 1/2" Tube	AMCIH3EXT	\$ 845.00	
	Replacement Parts:			
	Auger Flighting, 3 1/2" Tubing	AMX27501	\$ 84.00	
	Auger Flighting, 3" Tubing	AMX27502	\$ 79.00	
	Support Sleeve	AMX27184	\$ 175.00	
	Poly Snout, For CIH Extenders	AMCIHEXT-PS	\$ 106.00	
	Grain Saver Door	AMX27235	\$ 330.00	
5130, 5140, 5150, 6130, 6140, 6150, 7010, 7120, 7130, 7140, 7150, 7230, 8010, 8120, 8230, 9010, 9120, 9230, AFX8010	Unloading Auger Extension Kit, 3' 3' Extender Extended Wear Auger Tube and Auger Extension Includes Hardware	AM87471943	\$ 1600.00	
	Replacement Parts:			
	Horizontal Unloading Auger Tube	AM87470153	\$ 890.00	
	Horizontal Unloading Auger Extension	AM87657822	\$ 846.40	
5088, 6088, 7010, 7088, 7120, 8010, 8120, 9120, AFX8010	Unloading Auger Extension Kit	AMNH3EXT	\$ 1800.00	
5088, 6088, 7088, 7120, 8120, 9120 - w/ Red Unloading Tube	Unloading Auger Extension Kit 3' Extender w/ Spout	AMNH3EXT-R	\$ 1689.00	
1644, 1660, 1666, 1680, 1688, 2144, 2166, 2188, 2344, 2366, 2388, 2588	Horizontal Unloading Auger - Rear Extended Wear, 147 1/2" Overall Length, Right Hand Flighting, 11 1/2" Flighting Diameter, Shaft Diameter - 1" and 1" Hex Bore, 11 3/4" Pitch Note: 1-Piece Extender Setup extends Unloading Auger to 236", Tube and Auger must be used together	AM199023A2-3	\$ 683.00	
	Horizontal Unloading Auger Outer Tube	AM1317899C3-3	\$ 560.00	
5088, 6088, 7088, 7120, 8120, 9120	Grain Saver Door	AM84131732	\$ 109.74	
1420, 1440, 1460, 1480, 1620, 1640, 1644, 1660, 1666, 1680, 1688, 2144, 2166, 2188, 2344, 2366, 2388	Spring Kit, Grain Saver Door	AMX29019	\$ 42.00	

Auger Tube Donuts

Application	Description	Part Number	Retail Price	Core
2366, (2377, 2388 SN HAJ292001-HAJ300000), 2577, 2588	Splined Coupling (Donut)	AM198994A1	\$ 34.45	

Grain Tank Components

Application	Description	Part Number	Retail Price	Core
5088, 5130, 5140, 5150, 6088, 6130, 6140, 6150, 7088, 7130, 7140, 7150	Grain Bin Power Fold Actuator	AM84181862	\$ 886.00	

Case IH®—Combine

Grain Tank Auger Floor Liners

Application	Description	Part Number	Retail Price	Core
1420, 1440, 1460, 1480, 1640, 1660, 1666, 1680, 1688, 2144, 2166, 2188, 2344, 2366, 2388, 2588 BSN JJC0270499	Grain Tank Auger Floor Liner Kit	AMX27138	\$ 395.00	
1440, 1460, 1480, 1640, 1644, 1660, 1666, 1680, 1688, 2144, 2166, 2188, 2344, 2366, 2377, 2388, 2577, 2588	Grain Tank Auger Floor Liner Kit Stainless Steel, Includes Hardware	AM87561634	\$ 610.00	
5088, 6088, 7088, 5130, 6130, 7130	Grain Tank Auger Floor Liner Kit	AMX27428	\$ 414.75	
7010, 8010, 7120, 8120, 9120	Grain Tank Auger Floor Liner Kit	AMX27427	\$ 448.00	
	Grain Tank Auger Floor Liner Kit Oversized Liners Includes Stainless Steel Panels for both Grain Tank Auger Troughs, Rivets and Installation Instructions	AMX29168	\$ 1895.00	
7130, 7230, 7240, 7250, 8230, 8240, 8250, 9230, 9240, 9250	Grain Tank Auger Floor Liner Kit High Capacity Unload System Includes Stainless Steel Panels for both Grain Tank Auger Troughs, Rivets and Installation Instructions Replaces 84478565	AM84529552	\$ 525.00	
7230, 9230	Grain Tank Auger Floor Liner Kit	AMX27429	\$ 403.25	
7010, 7120, 7230, 7240, 8010, 8120, 8230, 8240, 9010, 9120, 9230, 9240, AFX8010	Grain Tank Auger Floor Liner Includes Stainless Steel Panels for both Grain Tank Auger Troughs, Rivets and Installation Instructions Replaces 87315123, 87662994	AM87662984	\$ 750.00	

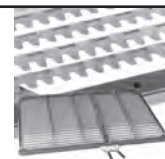

Chaffers—Short Finger Top

Adjustable short finger chaffers with 1 1/8" wire spacing. For use in cereal and fine seed crops. Our presieves feature 1 1/8" wire spacing.

Application	Description	Part Number	Retail Price	Core
915 ASN 3180, 1440, 1460, 1470, 1640, 1660	Short Finger Top Chaffer	45.00" x 61.88" AM1330684C2	\$ 625.00	
915 ASN 3180, 1440, 1460, 1640, 1660	Short Finger Top Chaffer Wide Spaced - 1.625"	45.00" x 61.88" AM1330685C1	\$ 1057.95	
1480, 1482, 1680, 1682	Short Finger Top Chaffer, Short Shoe	60.00" x 61.88" AM1330687C3	\$ 775.00	
1480, 1680	Short Finger Top Chaffer, Short Shoe Wide Spaced - 1.625"	60.00" x 61.88" AM1330688C3	\$ 1186.14	
1644, 1666, 2144, 2166, 2344, 2366	Short Finger Top Chaffer, Long Shoe	45.00" x 74.88" AM1957316C6	\$ 860.00	
	Short Finger Top Chaffer, Long Shoe Wide Spaced - 1.625"	45.00" x 74.88" AM1957315C8	\$ 1318.26	
1680, 1682, 1688, 2188, 2388, 2588, 5088, 6088, 7088 Replaces 1322467C1, 1322467C6, 87710708	Short Finger Top Chaffer, Long Shoe	60.00" x 74.88" AM1322467C5	\$ 995.00	
1680, 1688, 2188, 2388, 2588	Short Finger Top Chaffer, Long Shoe Wide Spaced - 1.625"	60.00" x 74.88" AM1322673C5	\$ 1125.00	
7010, 7120	Short Finger Top Chaffer Closed Slat (1) Required	59.125" x 51.75" AM87109836	\$ 642.00	
7240 (Prior to MY18), 8010, 8120, 8230, 8240, 9010, 9120, 9230 w/ Common Cab, 9240, AFX8010	Short Finger Top Chaffer Closed Slat, 1 1/8" Spacing (2) Required	56.813" x 30.938" AM87109830	\$ 485.00	

Case IH®—Combine

Application	Description	Part Number	Retail Price	Core
7230, (7240, 8240, 9240 - Prior to MY18), 8010, 8120, 8230, 9010, 9120, 9230, AFX8010	Short Finger Top Chaffer Closed Slat, 1 5/8" Spacing Double Handle, Manual Adjust (2) Required	56.813" x 30.938" AM87109838	\$ 392.00	
7230, (7240, 8240, 9240 - Prior to MY18), 8010, 8120, 8230, 9010, 9120, 9230, AFX8010	Short Finger Chaffer Precleaner 1 1/8" Spacing Replaces 84084942	29.878" x 61.938" AM87109817	\$ 420.00	
(2377, 2388 SN HAJ292001-HAJ300000), 2577, 2588	Lever Assembly Includes Bar Assembly, Shaft and Bushing Replaces 87671725	AM87313325	\$ 78.50	
7120, 7230, 7240, 8120, 8230, 8240, 9120, 9230, 9240	Chaffer Actuator Replaces 47421232	AM84208481	\$ 525.00	

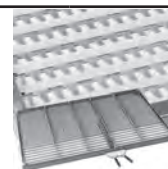

Chaffers—Long Finger Top

Adjustable long finger chaffers with 1 5/8" wire spacing. For use in large seed crops such as corn and beans. Our Presieves feature 1 1/8" or 1 5/8" wire spacing.

Application	Description	Part Number	Retail Price	Core
815 ASN 4689, 1420, 1620	Long Finger Top Chaffer	35.80" x 61.88" AM1330681C2	\$ 814.46	
915 ASN 3180, 1440, 1460, 1470, 1640, 1660	Long Finger Top Chaffer	45.00" x 61.88" AM1330686C1	\$ 550.00	
1480, 1482, 1680, 1682	Long Finger Top Chaffer, Short Shoe	60.00" x 61.88" AM1330689C3	\$ 775.00	
1644, 1666, 2144, 2166, 2344, 2366	Long Finger Top Chaffer, Long Shoe	45.00" x 74.88" AM1957314C7	\$ 715.00	
1680, 1682, 1688, 2188, 2388, 2588, 5088, 6088, 7088	Long Finger Top Chaffer, Long Shoe	60.00" x 74.88" AM1322659C5	\$ 1100.00	
7230, (7240, 8240, 9240 - Prior to MY18), 8010, 8120, 8230, 9010, 9120, 9230, AFX8010	Long Finger Top Chaffer 1 5/8" Spacing (2) Required	56.813" x 30.938" AM87109834	\$ 450.00	
7120, 7230, 7240, 7250, 8010, 8120, 8230, 8240, 8250, 9010, 9120, 9230, 9240, 9250, AFX8010	Long Finger Chaffer Precleaner 1 5/8" Spacing (2) Required Replaces 84083981, 87042470, 87105820	29.878" x 61.938" AM87109826	\$ 395.00	
(7230, 8230, 9230 - w/ Common Cab), 8010, 8120, 9010, 9120, AFX8010	Presieve Corn, Galvanized 1 5/8" Spacing (1) Required Replaces 84083263	29.88" x 61.93" AM87109821	\$ 801.28	
7120, 7230, 7240, 8120, 8230, 8240, 9120, 9230, 9240	Chaffer Actuator Replaces 47421232	AM84208481	\$ 525.00	



Chaffers—Adjustable Air Foil Top

Application	Description	Part Number	Retail Price	Core
1440, 1460, 1470, 1640, 1660	Adjustable Air Foil Top Chaffer	45.00" x 61.88" AM1319092C4	\$ 1427.79	
1644, 1666, 2144, 2166, 2344, 2366	Adjustable Air Foil Top Chaffer, Long Shoe	45.00" x 74.88" AM1970516C8	\$ 1656.50	
1680, 1682, 1688, 2188, 2388, 2588, 5130, 6130, 7130	Adjustable Air Foil Top Chaffer, Long Shoe Replaces 87710707	60.00" x 74.88" AM1347372C7	\$ 1887.68	
7230, 8010, 8120, 8230, 9010, 9120, 9230, AFX8010	Adjustable Air Foil Top Chaffer Galvanized Double Handle, Manual Adjust (2) Required	56.813" x 30.94" AM87109842	\$ 1207.88	

Case IH®—Combine

Application	Description	Part Number	Retail Price	Core
7120, 7230, 7240, 8120, 8230, 8240, 9120, 9230, 9240	Chaffer Actuator Replaces 47421232	AM84208481	\$ 525.00	

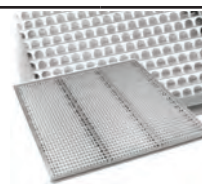

Chaffers—Rigid Air Foil

Rigid air foil chaffers are made of galvanized material. Dividers are included for even distribution and extra strength. These chaffers are preset for maximum performance at normal conditions.

Application	Description	Part Number	Retail Price	Core
915 ASN 3180, 1440, 1460, 1470, 1640, 1660	Rigid Air Foil Chaffer	45.00" x 61.88" AMB91515	\$ 807.69	
1480, 1482, 1680, 1682	Rigid Air Foil Chaffer, Short Shoe	60.00" x 61.88" AMB91516	\$ 1087.32	
1644, 1666, 2144, 2166	Rigid Air Foil Chaffer, Long Shoe	60.00" x 61.88" AMB92278	\$ 798.53	
1680, 1682, 1688, 2188, 2388	Rigid Air Foil Chaffer, Long Shoe	60.00" x 74.88" AMB91517	\$ 1461.54	



Sieves—Lower

Adjustable, blunt finger sieves with 1 1/8" wire spacing. For use in cereal and fine seed grains.

Application	Description	Part Number	Retail Price	Core
815 ASN 4689, 1420, 1620	Blunt Finger Bottom Sieve	36.00" x 51.50" AM1346913C2	\$ 550.00	
915 ASN 3180, 1440, 1460, 1470, 1640, 1660	Blunt Finger Bottom Sieve	45.75" x 51.50" AM1346914C2	\$ 490.00	
1480, 1482, 1680, 1682	Blunt Finger Bottom Sieve, Short Shoe	60.75" x 51.50" AM1346915C3	\$ 710.00	
1644, 1666, 2144, 2166, 2344, 2366	Blunt Finger Bottom Sieve, Long Shoe	45.75" x 65.00" AM1325323C5	\$ 625.00	
1680, 1682, 1688, 2188, 2388, 2588, 5088, 6088, 7088	Blunt Finger Bottom Sieve, Long Shoe	60.75" x 65.00" AM1322464C6	\$ 775.00	
7010, 7120	Short Finger Bottom Sieve Galvanized, Closed Slat, 1 5/8" Spacing (1) Required Replaces 86999992	59.125" x 51.75" AM87109848	\$ 510.00	
7010, 7120 BSN YAG209977	Short Finger Bottom Sieve Galvanized, 1 1/8" Spacing (1) Required Replaces 84319322	59.125" x 51.75" AM87109844	\$ 550.00	
(7230, 8230, 9230 - w/ Common Cab), 8010, 8120, 9010, 9120, AFX8010	Short Finger Bottom Sieve 1 1/8" Spacing (2) Required	56.813" x 30.938" AM87109846	\$ 485.00	
7120, 7230, (7240, 8240, 9240 - Prior to MY18), 8010, 8120, 8230, 9010, 9120, 9230, AFX8010	Long Finger Bottom Sieve Galvanized, 1 5/8" Spacing (2) Required Replaces 84400473	56.813" x 30.938" AM87109850	\$ 470.00	
5088, 5130, 5140, 6088, 6130, 6140, 7010, 7088, 7120, 7130, 7140, 7230, 8010, 8120, 8230, 9010, 9120, 9230, AFX8010	Sieve Adjuster Replaces 87011813, 87378807, 87387458	AM84335407	\$ 525.00	

Chaffer and Sieve Frames and Components



Application	Description	Part Number	Retail Price	Core
1420, 1440, 1460, 1470, 1620, 1640, 1660, 1670	Chaffer Shoe Frame Rail, Short Shoe	Right Hand	AM1979203C1	\$ 350.74
		Left Hand	AM1979202C1	\$ 390.68
1480, 1680, 1682	Chaffer Shoe Frame Rail, Short Shoe	Right Hand	AM1979199C1	\$ 315.00
		Left Hand	AM1979198C1	\$ 315.00

Case IH®—Combine

Application	Description	Part Number	Retail Price	Core
1640, 1644, 1660 ASN JJC0038346, 1666, 2144, 2166, 2344, 2366	Chaffer Shoe Frame Rail, Long Shoe	Right Hand	AM1979207C1	\$ 392.88
		Left Hand	AM1979206C1	\$ 393.44
1680 ASN JJC0047412, 1688, 2188, 2388, 2588	Chaffer Shoe Frame Rail, Long Shoe	Right Hand	AM1322453C2	\$ 365.00
		Left Hand	AM1322452C2	\$ 365.00
8010, 8120, 9120, AFX8010	Chaffer Shoe Frame, Upper, Wide Replaces 84462369	AM87491650	\$ 2507.69	
1440, 1460, 1470, 1480, 1482, 1640, 1644, 1660, 1666, 1670, 1680, 1682, 1688, 2144, 2166, 2188, 2344, 2366, 2377, 2388, 2577, 2588, 5088, 5130, 5140, SN HAJ292001-HAJ300000, 2388, 2577, 2588	Chaffer Front Hanger Support Replaces 87602594, 186651C91, 347907A1	AM87741795	\$ 204.00	
1640, 1644, 1660 ASN JJC0038346, 1666, 1670, ASN JJC0080540, 1680 ASN JJC0045689, 1682, 1688, 2144, 2166, 2188, 2344, 2366, 2377, 2388, 2577, 2588, 5088, 5130, 5140, 6088, 6130, 6140, 7088, 7130, 7140	Chaffer Shoe Arm	AM87672100	\$ 122.73	
1420, 1440, 1460, 1470, 1480, 1620, 1640, 1660, 1670, 1680, 1682	Sieve Shoe Frame Rail, Short Shoe	Right Hand	AM1302071C4	\$ 135.00
		Left Hand	AM1302070C4	\$ 169.23
1640, 1644, 1660 ASN JJC0038346, 1666, 1680, ASN JJC0047412, 1688, 2144, 2166, 2188, 2344, 2366, 2388	Sieve Shoe Frame Rail, Long Shoe	Right Hand	AM1979901C5	\$ 360.00
		Left Hand	AM1979900C5	\$ 360.00
2144, 2166, 2188, 2344, 2366, 2377, 2388, 2577, 2588, 7088	Seal, Sieve Frame 70 1/2" Long Replaces 47924947	AM198925A1	\$ 22.00	
1480, 1482, 1680, 1682	Shoe Return Pan, Short Shoe Replaces 191941C1	AM1319209C1	\$ 648.01	
1680 ASN JJC0045689, 1688, 2188, 2377, SN HAJ292001-HAJ300000, 2388, 2577, 2588	Shoe Return Pan, Long Shoe Replaces 87376644	AM1322461C1	\$ 491.50	
7010	Shaker Shoe	AM87557502	\$ 1131.21	
7010, 8010, 9010	Shaker Shoe Replaces 82034883, 84393491	AM87557503	\$ 1644.13	
1640, 1644, 1660 ASN JJC0038346, 1666, 1670, ASN JJC0080540, 1680 ASN JJC0045689, 1682, 1688, 2144, 2166, 2188, 2344, 2366, 2377, 2388, 2577, 2588, 5088, 5130, 5140, 6088, 6130, 6140, 7088, 7130, 7140	Hanger Arm Assembly, Front Chaffer Replaces 1957450C1	AM87671723	\$ 108.92	
2388, 2577, 2588, 5088, 5130, 5140, 6088, 6130, 6140, 7088, 7130, 7140	Hanger Arm Assembly, Rear Chaffer Replaces 1957451C1, 1957455A1	AM87671724	\$ 115.00	
1640, 1644, 1660, 1666, 1670, 1680, 1682, 1688, 2166, 2188, 2344, 2366, 2388	Hanger Arm Shaft	AM1979251C1	\$ 45.00	
1644, 1660 ASN JJC0038346, 1666, 2144, 2166, 2344, 2366 - w/ Straw Spreader	Rubber Seal	AM1346999C1	\$ 35.50	
1688, 2188, 2377, 2388, 2577, 2588 - w/ Straw and Chaff Spreader	Rubber Seal	AM124004A2	\$ 62.00	
2144, 2166, 2344, 2366 - w/ Straw and Chaff Spreader	Rubber Seal	AM124558A2	\$ 66.00	
2188, 2377, 2388, 2577, 2588 - w/ Straw Chopper	Rubber Seal	AM1979332C4	\$ 39.00	
1640, 1644, 1660 ASN JJC0038346, 1666, 1680, ASN JJC0045689, 2144, 2166, 2188, 2344, 2366, 2388, 2577, 2588, 5088, 5130, 5140, 5150, 6088, 6130, 6140, 6150, 7088, 7130, 7140, 7150	Sealing Strip 2 Required	AM1325331C1	\$ 25.00	
7010, 7120, 7230, 7240, 8010, 8120, 8230, 8240, 9010, 9120, 9230, 9240, AFX8010	Shaker Shoe Arm, Upper	AM87314041	\$ 158.20	
7010, 7120, 7230, 7240, 8010, 8120, 8230, 8240, 9010, 9120, 9230, 9240	Shaker Shoe Arm, Lower	AM87562561	\$ 93.92	

Prices Subject to Change without Prior Notice. The use of original equipment manufacturer (OEM) part numbers or trademarks, e.g. Case® and John Deere®, are for reference purposes only and for indicating product use and compatibility. Our company and the listed replacement parts contained herein are not sponsored, approved or manufactured by the OEM. All parts are New unless designated Reman in the description.

Case IH®—Combine

Application	Description	Part Number	Retail Price	Core
7120, 7230, 7240, 8010, 8120, 8230, 8240, 9010, 9120, 9230, 9240, AFX8010	Shaker Shoe Drive Arm	AM87317702	\$ 232.41	
7010, 7120, 7230, 7240, 8010, 8120, 8230, 8240, 9010, 9120, 9230, 9240, AFX8010	Shaker Shoe Drive Arm, Upper	Right Hand	AM87314573	\$ 116.89
		Left Hand	AM87314571	\$ 126.10
7010, 7120, 8010, 8120, 9120, AFX8010	Shaker Shoe Drive Shaft 80.31" Long	AM86980613	\$ 567.49	
1640 ASN JJC0097189, 1644, 1660 ASN JJC0039549, 1666, 2144, 2166, 2344, 2366	Shaker Shaft 59.19" Long Replaces 1970192C1	AM1970192C2	\$ 235.00	
1640 ASN JJC0097189 w/ Heavy Duty Drive, 1644, 1660 ASN JJC0039549 w/ Heavy Duty Drive, 1666, 1670 ASN JJC0080539, 1680 ASN JJC0045688, 1688, 2144, 2166, 2188, 2344, 2366, 2377, 2388, 2577, 2588	Shaker Shaft Cam	Left Hand	AM1322573C1	\$ 146.37
7010, 7120, 7230, 7240, 8010, 8120, 8230, 8240, 9010, 9120, 9230, 9240, AFX8010	Bearing Housing, Upper Shoe Drive Replaces 80442901, 84032313, 84097461	AM84446877	\$ 10.80	
7010, 7120, 8010, 8120, 9120, AFX8010	Bearing Housing Half, Shaker Shoe Replaces 80320033	AM320033	\$ 11.33	
1440, 1460, 1470, 1480, 1482, 1640, 1644, 1660, 1670, 1680, 1682	Bushing, Hanger Arm Drive 0.63" ID Replaces B94623, B512078	AM186597C1	\$ 22.68	
1420, 1480, 1620, 1640, 1660 BSN JJC0039550, 1680 Standard Shoe	Hanger Arm Bushing, Shoe Hanger Arm	AM627555R91	\$ 8.21	
1640, 1644, 1660 ASN JJC003834), 1670, 1680 ASN JJC0045689, 1682, 1688, 2144, 2166, 2188, 2344, 2366, (2377, 2388 SN HAJ292001- HAJ300000), 2577, 2588, 5088, 5130, 5140, 6088, 6130, 6140, 7088, 7130, 7140	Bushing, Chaffer 2.87" Long, 0.633" ID, 1.50" OD Replaces 87538599	AM1330323C2	\$ 17.50	
2577, 2588, 5088, 6088, 7088	Sieve Bushing Kit Includes (2) Shaker Shaft/Chaffer Drive Arm Bushings, (8) Sieve/Drive Hanger Bushings and (10) Rubber Bushings	AM87299946	\$ 457.51	
7230, 8230, 9230	Roller, Cleaning Shoe Pivot Frame Self-Leveling Replaces 89504221	AM434817	\$ 25.92	
5140, 6140, 7140, 7230, 7240, 8230, 8240, 9230, 9240	Rubber Bushing, Upper Shaker Shoe Drive Replaces 442446, 80442446	AM84459072	\$ 39.19	
7010, 7120, 8010, 8120, 9120, AFX8010	Rubber Bushing, Shaker Shoe Replaces 190068, 398810	AM84000052	\$ 4.76	
	Bushing, Upper Shaker Shoe 0.64" ID, 2.05" Long	AM84052651	\$ 6.01	
	Bushing, Upper Shaker Shoe Replaces 80338222	AM338222	\$ 4.03	
7010, 7120, 7230, 7240, 8010, 8120, 8230, 8240, 9010, 9120, 9230, 9240, AFX8010	Bushing, Upper Shoe Arm Replaces 84097509, 84320630, 89811082	AM9811082	\$ 76.26	
1640, 1644, 1660, 1666, 1680, 1688, 2144, 2166, 2188, 2344, 2366, 2377 ASN HAJ292001- HAJ300000, 2388, 2577, 2588, 5088, 5130, 5140, 6088, 6130, 6140, 7088, 7130, 7140	Bushing, Shaker Shaft Drive Arm 0.633" ID Replaces 1979383C1	AM87376924	\$ 29.25	
815, 915, 1420, 1440, 1460, 1470, 1480, 1620, 1640, 1644, 1660, 1666, 1670, 1680, 1682, 1688, 2144, 2166, 2188, 2344, 2366, 2377, 2388, 2577, 2588, 5088, 6088, 7088	Finger, Auger Bed	AM175114C1	\$ 3.50	

Case IH®—Combine

Application	Description	Part Number	Retail Price	Core
1420, 1440, 1460, 1470, 1480, 1482, 1620, 1640, 1644, 1660, 1666, 1670, 1680, 1682, 1688, 2144, 2166, 2188, 2344, 2366, 2377, 2388, 2577, 2588, 5088, 5130, 6088, 6130, 7088, 7130	Ratchet/Clutch	AMB12170	\$ 9.50	
1480, 1680, 1688, 2188, (2377, 2388 SN HAJ292001-HAJ300000), 2577, 2588	Front Seal Support Plate Replaces 192065C1	AM87378753	\$ 77.88	
1480, 1680, 1688, 2188, 2377, 2388	Chaffer Pan Support Replaces 192045C1	AM87379129	\$ 61.00	
1640, 1644, 1660, 1666, 2144, 2166, 2344, 2366	Chaffer Pan Support	AM1312156C1	\$ 139.02	
1680 ASN JJC0045689, 1688, 2188, 2377 SN HAJ292001-HAJ300000, 2388, 2577, 2588	Chaffer Pan Support, Long Shoe Replaces 1312969C1	AM87379150	\$ 78.50	
7010, 7120, 7230, 7240, 8010, 8120, 8230, 8240, 9010, 9120, 9230, 9240, AFX8010	Upper Shoe Drive Support Middle Pivot Plate	Right Hand	AM84320472	\$ 159.79
		Left Hand	AM84320470	\$ 132.78
	Upper Shoe Drive Support Lower Bushing Mount	Right Hand	AM84334453	\$ 36.21
		Left Hand	AM84334452	\$ 47.91
5088, 5130, 5140, 6088, 6130, 6140, 7088, 7130, 7140	Curtain, Upper Sieve 1565 mm Long	AM87732448	\$ 79.00	
1644, 1660 ASN JJC0039549 w/o Extended Length Cleaning System or ASN JJC0038346 w/ Extended Length Cleaning System, 1666, 1670 ASN JJC0080539, 1680 ASN JJC047024 w/ Heavy Duty Drive or ASN JJC0047411 w/ Long Chaffer Cleaning System, 2144, 2166, 2188, 2344, 2366, 2377, 2388 BSN JJC0276540, (2577, 2588 BSN HAJ303741)	Rubber Bushing, Lower Sieve Front Hanger Replaces 564103R91	AM1330324C1	\$ 15.84	
2144, 2166	Rubber Bushing, Top Chaffer Rear Hanger Replaces 564103R91	AM1330324C1	\$ 15.84	
1644, 1660 ASN JJC0039549 w/ Extended Length Cleaning System, 1666, 1680 ASN JJC047024 w/ Heavy Duty Chaffer Drive or ASN JJC0047411 w/ Long Chaffer Cleaning System, 1688, 2188, 2344, 2366, 2377, 2388, (2577, 2588 BSN HAJ303741)	Rubber Bushing, Top Chaffer Front Hanger Replaces 564103R91	AM1330324C1	\$ 15.84	
1640 BSN JJC0034705 & ASN JJC0035369, 1660 BSN JJC0038346 & ASN JJC0040382, 1680 ASN JJC0047877	Rubber Bushing, Steering Axle Shield Support Replaces 564103R91	AM1330324C1	\$ 15.84	
1420, (1440, 1460 BSN 001501), 1480, 1620, 1640, 1660 BSN JJC0039550, 1680 Standard Shoe	Hanger Arm Bushing, Chaffer Hanger Arm	AM627555R91	\$ 8.21	

Grain Pans and Components

Our grain pans are built heavier than OEM and have galvanized pans to prevent rusting. Ripple pans may be ordered separately. Replaceable front sections are available.



Application	Description	Part Number	Retail Price	Core
1440, 1460, 1640, 1644, 1660, 1666, 2144, 2166, 2344, 2366	Grain Pan	AM192056C1	\$ 135.00	
1480, 1680, 1688, 2188, 2388	Grain Pan	AM192057C1	\$ 165.00	
1680 ASN JJC0045689, 1688, 2188, 2377, 2388, 2577, 2588, 5088, 5130, 5140, 6088, 6130, 6140, 7088, 7130, 7140, 9230	Sieve Finger Cover	AM1994858C1	\$ 30.77	
7010, 7120, 7240, 7250, 8010, 8120, 8240, 8250, 9120, 9240, 9250	Grain Pan Canvas Seal Replaces 87376933	AM87376934	\$ 26.00	
7010, 7120, 8010, 8120, 9010, 9120, AFX8010	Grain Pan Canvas Seal	AM87391543	\$ 28.00	

Case IH®—Combine



Straw Walkers and Parts

Application	Description	Part Number	Retail Price	Core
915	Straw Walker Wood Bearing Block Set Complete set includes upper bearing half, lower bearing half and bolts	AM166067C91	\$ 55.46	

Straw Choppers

Assembly includes rotor, side sheets, knife bank, flanges, hardware and 3-groove pulley unless otherwise noted. Original pulley must be returned to receive core credit.



Application	Description	Part Number	Retail Price	Core
1440 ASN 20977, 1460 ASN 23401, 1640, 1644, 1660, 1666, 2144, 2166, 2344, 2366 - w/o existing Straw Choppers	Straw Chopper Assembly w/ Drive	AMCIHD60	\$ 5300.00	\$ 150.00
1480 ASN 24001, 1680 - w/o existing Straw Choppers	Straw Chopper Assembly w/ Drive	AMCIHD80	\$ 5450.00	\$ 150.00
1688, 2188, 2388 BSN JJC0270499 - w/o existing Straw Choppers	Straw Chopper Assembly w/ Drive	AMCIHD88	\$ 5450.00	\$ 150.00
2377, 2388 ASN 292001, 2577 ASN 292001, 2588 - w/o existing Straw Choppers	Straw Chopper Assembly w/ Drive Includes 2 Speed Drive Kit 5-groove pulley	AMCIHD2588	\$ 5815.00	\$ 150.00
2388 ASN JJC0270499-292001, 2577 ASN 292001 - w/o existing Straw Choppers	Straw Chopper Assembly w/ Drive 5-groove pulley	AMCIHD88N	\$ 5625.00	\$ 150.00
5088, 6088, 7088 - w/o existing Straw Choppers	Straw Chopper Assembly w/ Drive Includes 2 Speed Drive Kit	AMCIHD7088	\$ 6285.00	\$ 150.00
All Case IH® Straw Choppers	Dual Drive Kit	AMX27127	\$ 490.00	
1480, 1482, 1680, 1688, 2188, 2377, 2388	Bottom Knife Sheet	AM181147C4	\$ 688.41	
1440, 1460, 1640, 1666, 1660, 1666, 2144, 2166, 2344, 2366	Bottom Knife Sheet	AM185141C4	\$ 515.00	
(2377, 2388 SN HAJ292001-HAJ300000), 2577, 2588, 5088, 6088, 7088	Straw Chopper Side Sheet, Right Hand Replaces 181058C1	AM87649889	\$ 159.05	
7120, 7230, 7240, 8120, 8230, 8240, 9120, 9230, 9240	Straw Chopper Pan Replaces 87108192, 87282893, 87563854	AM84187500	\$ 700.00	
7230, 7240, 7250, 8230, (8240, 9240 - Except Redekop™), 8250, 9230, 9250	Slotted Grate Insert Use w/ Straw Chopper w/o Stationary Knives	AM87587528	\$ 310.00	

Straw Chopper Drive Components

Application	Description	Part Number	Retail Price	Core
1420, 1440, 1460, 1480, 1620, 1640 BSN JJC0034705, (1640 ASN JJC0034704, 1644, 1660, 1666 - w/o Straw Chopper), 1680, 1688, 2144, 2166, 2188, 2344, 2366, 2377, 2388, 2577, 2588, 5130 w/ Non-Common Cab	Drive Hub, Separator Variable Speed	AM194394C1	\$ 131.00	
1440 BSN 20976, 1460 BSN 23401, 1480 BSN 24001	Driven Pulley, Straw Chopper 10" OD Replaces 108533A1, 181196C1	AM181196C2	\$ 146.10	
1440, 1460, 1480	Pulley Hub, Straw Chopper Jackshaft Driven Pulley	AM181211C1	\$ 68.00	
1640, 1644, 1660, 1666, 1670 HillSide, 1680, 1688, 2144, 2166, 2188, 2344, 2366, 2388, 2577, 2588, 5088, 6088	Drive Pulley, Straw Chopper 12 Spline, 2-Groove, 7" & 14" OD	AM1315264C1	\$ 215.00	
2377 SN HAJ0292001-HAJ0300000, 2388 ASN JJC0273000, 2577, 2588, 5088, 6088, 7088	Drive Pulley, Straw Chopper 4.009" ID, 20.50" OD	AM87529708	\$ 411.19	

Case IH®—Combine

Application	Description	Part Number	Retail Price	Core
1440, 1460, 1470, 1480, 1640, 1644, 1660, 1666, 1670, 1680, 1688, 2144, 2166, 2188, 2344, 2366, 2377, 2388, 2577, 2588, 7088	Drive Shaft, Straw Chopper 11.48" Long	AM181195C1	\$ 195.00	
5088, 5130, 5140, 6088, 6130, 6140, 7088, 7130, 7140	Drive Shaft, Straw Chopper	AM87386758	\$ 287.00	
7010, 8010, 8120, 9010, 9120, AFX8010	Drive Shaft, Straw Chopper 104.31" Long Replaces 86975806, 87107192	AM87282228	\$ 996.89	
2344 ASN JJC0174449, 2366 ASN JJC0254999, 2377, 2388 ASN JJC0270500, 2577, 2588	Gear Housing Shaft, Straw Chopper	AM411043A1	\$ 473.20	

Straw Chopper Blades and Components

Hardened-steel chopper blades.

Application	Description	Part Number	Retail Price	Core
715 ASN 23001, 815, 915 ASN 8000, 1420, 1440, 1460, 1620, 1640, 1644, 1666, 1680, 1682, 1688, 2144, 2166, 2188, 2344, 2366, 2388, 5088, 6088, 7088	Straw Chopper Blade Set Set of 2 Hardened and Hard surfaced Blades w/ mounting hardware	AMB96349	\$ 24.00	
	Straw Chopper Blade Kit Set of 2 sharpened bevel edge blades w/ hardware	AM442832A1	\$ 20.00	
7240, 8240, 9240	Straw Chopper Blade Kit Set of 4 Standard/Fine Cut Blades	AM47677377	\$ 72.00	
	Straw Chopper Blade Kit Set of 6 Magnacut Blades Replaces 84141246, 84232968, 87666976	AM47796266	\$ 148.00	
1688, 2188, 2344, 2366, 2388 BSN JJC0276540	Straw Chopper Blade, Single	AM1302764C1	\$ 10.40	
1440, 1460, 1470, 1480, 1482, 1640, 1644, 1660, 1666, 1670, 1680, 1682, 1688, 2144, 2166, 2188, 2344 BSN 174399, 2366 BSN 253999, 2388 BSN 268800	Straw Chopper Stationary Blade, Double	AM1302763C1	\$ 8.23	
(1440, 1460, 1640, 1644, 1660, 1666, 2144, 2166, 2344, 2366 ASN 4325), (1480, 1680 ASN 5138), (1688, 2188, 2388 ASN 6181) - All w/ TSR Choppers Only Will not work on OEM Straw Choppers	Straw Chopper Blade	AMX27319	\$ 14.00	
1688, 2188, 2344, 2366, 2388 BSN JJC0276540	Straw Chopper Blade, Double	AM396960A1	\$ 15.69	
2377, 2388, 2577, 2588, 5088, 5130, 5140, 6088, 6130, 6140, 7088, 7130, 7140	Straw Chopper Blade, Double	AM87315088	\$ 11.20	
2388 BSN JJC0276540, 5088, 5130, 5140, 5150, 6088, 6130, 6140, 6150, 7088, 7130, 7140, 7150	Straw Chopper Blade Sold Individually Hardware Not Included	AM409731A1	\$ 10.00	
7010, 7120, 8010, 8120, 9120	Straw Chopper Blade, Offset Replaces 86999627	AM87280494	\$ 19.50	
7230, 7240, 8230, 8240, 9230, 9240	Straw Chopper Stationary Knife Kit Replaces 84424430	AM47952760	\$ 32.00	
7010, 7120, 7230, 7240, 8010, 8120, 8230, 8240, 9120, 9230, 9240, AFX8010	Straw Chopper Stationary Knife	AM87106692	\$ 4.00	
1440, 1460, 1470, 1480, 1482, 1640, 1644, 1660, 1666, 1670, 1680, 1682, 1688, 2144, 2166, 2188, 2344, 2366, 2388 BSN JJC0276540	Knife Mount Bar Assembly Includes Knives Replaces 185135C91, 87315091, 87328045	AM87315495	\$ 342.15	
	Knife Mount Bar Replaces 185135C91, 87315091, 87328045	AM396962A1	\$ 15.12	
7010, 7120, 7230, 8010, 8120, 8230, 9010, 9120, 9230, AFX8010	Bearing Assembly For Beater/Chopper Drive Replaces 47421133, 47663490, 87323956	AM87109088	\$ 196.00	

Case IH®—Combine

Application	Description	Part Number	Retail Price	Core
All Models w/ TSR Choppers	Bushing	AMX27321	\$ 4.00	
Will not work on OEM Straw Choppers	Bushing	AMX27318	\$ 3.00	
	Bushing, Trunnion	AMX27320	\$ 4.00	
	Bolt Kit	AMX27317	\$ 4.00	



Sickle Knife Heads

Application	Description	Part Number	Retail Price	Core
Platforms: 820 Series	Sickle Knife Head	AM197230C91	\$ 150.00	
Platforms: 1010, 1020 - w/ 3" Cut	Sickle Knife Head Replaces 1316161C95	AM1316161C93	\$ 100.00	
Platforms: 2010, 2020	Sickle Knife Head Single Drive	AM848094	\$ 90.00	
Platforms: 2052, 2062	Sickle Knife Head Replaces 87408818	AM153812	\$ 93.00	
Platforms: 1010, 1020	Sickle Drive Block Replaces 1313797C1	AM1313797C2	\$ 50.00	

Sickle Assemblies Without Heads

Easy-to-assemble interlocking/overlapping bar bolts together for greater field convenience. ThunderBOLT Sickles can ship via UPS and are easy to carry and store. The Gold'N Cut section utilizes a coarse serration that sharpens itself as wearing occurs, giving you the longest wear for your money. All sickle sections feature bolt-on convenience and are heat-treated for superior cutting life.



Application	Description	Part Number	Retail Price	Core
Platforms: 962, 963	Sickle Assembly w/o Head, Coarse Includes: (1) 87458220 Left Hand Head Segment, (2) 87458222 Mid Segments, (1) 87458225 Tail Segment, (3) 129043 Splice Kits	30' AMX29051	\$ 448.00	
	Sickle Assembly w/o Head, Coarse Includes: (1) 87458220 Left Hand Head Segment, (3) 87458222 Mid Segments, (1) 87458226 Tail Segment, (4) 129043 Splice Kits	36' AMX29052	\$ 545.00	
Platforms: 2042, 2052, 2062	Sickle Assembly w/o Head, Coarse Includes: (1) 87458220 Left Hand Head Segment, (1) 87458222 Mid Segment, (1) 87470116 Tail Segment, (2) 129043 Splice Kits	21' AMX29037	\$ 319.00	
	Sickle Assembly w/o Head, Coarse Includes: (1) 87458220 Left Hand Head Segment, (1) 87458222 Mid Segment, (1) 87458227 Tail Segment, (2) 129043 Splice Kits	25' AMX29038	\$ 365.00	
	Sickle Assembly w/o Head, Coarse Includes: (1) 87458220 Left Hand Head Segment, (2) 87458222 Mid Segments, (1) 87458225 Tail Segment, (3) 129043 Splice Kits	30' AMX29039	\$ 448.00	
	Sickle Assembly w/o Head, Coarse Includes: (1) 87458220 Left Hand Head Segment, (3) 87458222 Mid Segments, (1) 87458226 Tail Segment, (4) 129043 Splice Kits	36' AMX29040	\$ 545.00	

Case IH®—Combine

Application	Description	Part Number	Retail Price	Core
Platforms: 2142, 2152, 2162	Sickle Assembly w/o Head, Coarse Includes: (1) 87458220 Left Hand Head Segment, (1) 87458222 Mid Segment, (1) 87470116 Tail Segment, (2) 129043 Splice Kits	20' AMX29020	\$ 319.00	
	Sickle Assembly w/o Head, Coarse Includes: (1) 87458220 Left Hand Head Segment, (1) 87458222 Mid Segment, (1) 87458227 Tail Segment, (2) 129043 Splice Kits	25' AMX29021	\$ 365.00	
	Sickle Assembly w/o Head, Coarse Includes: (1) 87458220 Left Hand Head Segment, (2) 87458222 Mid Segment, (1) 87458225 Tail Segment, (3) 129043 Splice Kits	30' AMX29022	\$ 448.00	
	Sickle Assembly w/o Head, Coarse Includes: (1) 87458220 Left Hand Head Segment, (2) 87458222 Mid Segments, (1) 87685333 Tail Segment, (3) 129043 Splice Kits	35' AMX29023	\$ 532.00	
	Sickle Assembly w/o Head, Coarse Includes: (1) 87458220 Left Hand Head Segment, (3) 87458222 Mid Segments, (1) 87699654 Tail Segment, (4) 129043 Splice Kits	40' AMX29024	\$ 606.00	
Platforms: 2142, 2152, 2162 Note: Right and Left Hand Assemblies Must be Purchased Separately to Create Full Double Sickle	Double Sickle Right Hand Assembly w/o Head, Coarse Includes: (1) 87752689 Right Hand Head Segment	20' AMX29026	\$ 177.00	
	Double Sickle Left Hand Assembly w/o Head, Coarse Includes: (1) 87458220 Left Hand Head Segment, (1) 87585387 Left Hand Overlap Tail Segment, (1) 129043 Splice Kit	20' AMX29025	\$ 177.00	
	Double Sickle Right Hand Assembly w/o Head, Coarse Includes: (1) 87725592 Right Hand Head Segment, (1) 87752680 Right Hand Overlap Tail Segment, (1) 129043 Splice Kit	25' AMX29028	\$ 187.00	
	Double Sickle Left Hand Assembly w/o Head, Coarse Includes: (1) 87458220 Left Hand Head Segment, (1) 87585389 Left Hand Overlap Tail Segment, (1) 129043 Splice Kit	25' AMX29027	\$ 188.00	
	Double Sickle Right Hand Assembly w/o Head, Coarse Includes: (1) 87725592 Right Hand Head Segment, (1) 87752681 Right Hand Overlap Tail Segment, (1) 129043 Splice Kit	30' AMX29030	\$ 212.00	
	Double Sickle Left Hand Assembly w/o Head, Coarse Includes: (1) 87458220 Left Hand Head Segment, (1) 87585391 Left Hand Overlap Tail Segment, (1) 129043 Splice Kit	30' AMX29029	\$ 229.00	
	Double Sickle Right Hand Assembly w/o Head, Coarse Includes: (1) 87725592 Right Hand Head Segment, (1) 87752682 Right Hand Overlap Tail Segment, (1) 129043 Splice Kit	35' AMX29032	\$ 242.00	
	Double Sickle Left Hand Assembly w/o Head, Coarse Includes: (1) 87458220 Left Hand Head Segment, (1) 87752686 Left Hand Overlap Tail Segment, (1) 129043 Splice Kit	35' AMX29031	\$ 254.00	
	Double Sickle Right Hand Assembly w/o Head, Coarse Includes: (1) 87725592 Right Hand Head Segment, (2) 87458222 Mid Segments, (1) 87725593 Right Hand Overlap Tail Segments, (3) 129043 Splice Kits	40' AMX29034	\$ 380.00	
	Double Sickle Left Hand Assembly w/o Head, Coarse Includes: (1) 87458220 Left Hand Head Segment, (2) 87458222 Mid Segments, (1) 87725591 Left Hand Overlap Tail Segment, (3) 129043 Splice Kits	40' AMX29033	\$ 418.00	

Case IH®—Combine

Application	Description	Part Number	Retail Price	Core
Platforms: 2142, 2152, 2162 Note: Right and Left Hand Assemblies Must be Purchased Separately to Create Full Double Sickle	Double Sickle Right Hand Assembly w/o Head, Coarse Includes: (1) 87725592 Right Hand Head Segment, (2) 87458222 Mid Segments, (1) 87726850 Right Hand Overlap Tail Segment, (3) 129043 Splice Kits	45' AMX29036	\$ 420.00	
	Double Sickle Left Hand Assembly w/o Head, Coarse Includes: (1) 87458220 Left Hand Head Segment, (2) 87458222 Mid Segments, (1) 87726849 Left Hand Overlap Tail Segments, (3) 129043 Splice Kits	45' AMX29035	\$ 439.00	
Platform: 3020	Sickle Assembly w/o Head, Coarse Top Serrated	20' AM84585670	\$ 450.00	
	Features bolt-together, bolt-on coarse sections Convenient to transport and store, Will ship UPS and FedEx	25' AM84585668	\$ 480.00	
		30' AM84585666	\$ 570.00	
		35' AM84585664	\$ 589.00	
Platform: 3020 Double Drive	Sickle Assembly w/o Head, Coarse Top Serrated	30' Right Hand AM84585676	\$ 260.00	
	Features bolt-together, bolt-on coarse sections Convenient to transport and store, Will ship UPS and FedEx	30' Left Hand AM84585677	\$ 255.00	
		35' Right Hand AM84585678	\$ 425.00	
		35' Left Hand AM84585679	\$ 425.00	
Platform: 3020 ASN 222000	Splice Kit	AMX29063	\$ 27.00	

Sickle Assemblies With Heads

These assemblies feature bolt-together, coarse sections and include the drive head. Bolt-together sickles are convenient to transport and store. They will ship via UPS and FedEx.



Application	Description	Part Number	Retail Price	Core
Platforms: 1010, 1020	Sickle Assembly w/ Head, Coarse	15' AM371613A2	\$ 325.00	
	Sickle Assembly w/ Head, Coarse	16.50' AM371617A2	\$ 375.00	
	Sickle Assembly w/ Head, Coarse	17.50' AM371618A2	\$ 405.00	
	Sickle Assembly w/ Head, Coarse	20' AM371619A2	\$ 512.00	
	Sickle Assembly w/ Head, Coarse	22.50' AM371620A2	\$ 450.00	
	Sickle Assembly w/ Head, Coarse	25' AM371621A3	\$ 455.00	
	Sickle Assembly w/ Head, Fine Cut	25' AM451834A3	\$ 520.00	
	Sickle Assembly w/ Head, Coarse	30' AM371622A3	\$ 635.00	

Guards and Cutter Bar Parts



Application	Description	Part Number	Retail Price	Core
Used on most Case IH® Platforms, Including 810 Grain and 810 Draper Platforms	Knife Guard	AM633098R1	\$ 11.00	
Platforms: 820, 1010 BSN JJC0200000, 1020 BSN JJC0215001	Knife Guard, Double Pronged w/ Trashbar Use w/ 3" Cutter Bar Knife Replaces 613838R2, 613838R3	AM613838R1	\$ 11.00	
Platforms: 820, 1010, 1020, (2010, 2020 - w/ Single Drive or ASN CBJ021300 w/ Double Drive)	Knife Guard, Double Pronged w/o Trashbar Use w/ 3" Cutter Bar Knife For Drive Head End Replaces 483500R3, 1326787C1, 1326787C2, 1326787C3	AM87442329	\$ 12.25	
Platforms: 1010 BSN JJC020000, 1020 BSN JJC215001	Knife Guard, 4-Pronged For 1.50" Cutting System Replaces 1989552C1	AM1305195C1	\$ 12.00	

Case IH®—Combine

Application	Description	Part Number	Retail Price	Core
Platforms: 1010, 1020	Knife Guard, Single Prong End Use w/ 3" Cutter Bar Knife For 15', 20', 25' and 30' Platforms	AM1338269C1	\$ 10.95	
	Knife Guard, Double Pronged Drive Head Guard (3) Required per Head	AM1326787C3	\$ 12.00	
Platforms: 1010, 1020, 2010*, 2020** *20' and 25' Single Drive, 20' and 25' Double Drive SN CBJ020001-CBJ021301, or 30' Double Drive ASN CBJ020001 **20' and 25' Single Drive, 20' and 25' Double Drive SN CBJ020001-CBJ021301, 30' Double Drive ASN CBJ020001, or 35' Double Drive ASN CBJ021300	Knife Guard, Double Pronged w/o Trashbar Use w/ 3" Cutter Bar Knife Replaces 334305A1, 87442324	AM1307299C2	\$ 12.00	
Platforms: 2010 (20' Single Drive BSN CBJ020001 or 20', 25' and 30' Double Drive BSN CBJ020001), 2020 (20', 25' and 30' Double Drive BSN CBJ020001)	Knife Guard, Double Pronged w/ Trashbar Use w/ 3" Cutter Bar Knife For Drive Head End Replaces 9801347, 86521590, 86553346, 86615983, 87042358, 87042360	AM86615984	\$ 17.00	
Platforms: 2010 (20' Single Drive BSN PNL020001 or 20', 25' and 30' Double Drive BSN PNL020001) 2020 (20', 25' and 30' Double Drive BSN PNL020001), Draper Platforms: 8830 SN CFH0030001-CFH0030158, (DH213, DH253, DH303 - 25' and 40' Double Drive w/ Honey Bee®), DH363 (40' Double Drive w/ Honey Bee®), (DH182, DH212, DH252, DH302, DH362, DHX182, DHX212, DHX252, DHX302, DHX362 - w/ Double Knife Drive) Replaces 86521587, 86553340, 87042356	Knife Guard, Double Pronged w/ Trash Bar Use w/ 3" Cutter Bar Knife	AM86615982	\$ 11.75	
Platform: 2042	Knife Guard, Double Pronged Replaces 49312	AM118346	\$ 10.00	
Platform: 3020	Knife Guard, Double Pronged w/o Trashbar Use w/ 3" Cutter Bar Knife	AM87702974	\$ 15.00	
Platforms: 3020 (25', 30' and 35' Single Drive or 30' and 35' Double Drive), Draper Platforms: 3152, 3162	Knife Guard, Double Pronged w/o Trashbar Use w/ 3" Cutter Bar Knife	AM87702973	\$ 16.00	
Draper Platforms: 1052, 2042, 2052, 2062, 2152, 2162 Replaces 87421451	Knife Guard, Double Pronged	AM118344	\$ 11.00	
Draper Platforms: 1052, 2042, 2052, 2062, 2162	Knife Guard, Double Pronged Drive Head Guard (3) Required per Single Knife (6) Required per Double Knife	AM118345	\$ 12.00	
	Knife Guard First Guard, Left Hand w/ Cross Bar Double Heat Treated (1) Required per Head Replaces 47709129, 87422039	AM118301	\$ 13.00	
	Knife Guard Last Guard, Right Hand w/ Cross Bar Double Heat Treated (1) Required per Head Replaces 47709128, 87422040	AM118302	\$ 13.00	
Draper Platforms: DH182, DH212, DH252, DH302, DH362, DHX182, DHX212, DHX252, DHX302, DHX362	Knife Guard, Double Pronged Special, Center w/ Cross Bar	AM86615983	\$ 13.50	
Rigid Platforms: 2010, 2020	Knife Guard 4-Prong Bottom Guard	AM87015708	\$ 10.00	
Platform: 820	Guard Stub, Single Prong Forged Replaces 257635, H472717R2	AM472717R2	\$ 10.50	





Prices Subject to Change without Prior Notice. The use of original equipment manufacturer (OEM) part numbers or trademarks, e.g. Case® and John Deere®, are for reference purposes only and for indicating product use and compatibility. Our company and the listed replacement parts contained herein are not sponsored, approved or manufactured by the OEM. All parts are New unless designated Reman in the description.

Case IH®—Combine



Application	Description	Part Number	Retail Price	Core
Platforms: 820, 1010, 1020	Sickle Section Sold in Multiples of 25, Priced Individually	AM112074A1	\$ 1.35	
Platforms: 1042, 1052, 2015, 2042, 2062, 2142, 2152, 2162	Sickle Section, Coarse 3.25" Long, 3" Wide, 2.125" Hole Spacing Sold in Multiples of 25, Priced Individually	AM158516	\$ 1.50	
Platform: 3020	Sickle Section, Coarse Sold in Multiples of 25, Priced Individually	AM87728905	\$ 2.00	
Platform: 1020	Sickle Section End Replaces 148200C1	AM86617760	\$ 7.25	
Platforms: 1010, 1020, 2010, 2020, DHX182, DHX212, DHX252, DHX302, DHX362, HDX121, HDX122, HDX141, HDX142, HDX161, HDX162, HDX181, HDX182, SMX91	Knife Clip, Low Profile Adjustable Replaces 1307280C3, 71346158, 86630786, H84412	AMX29115	\$ 14.75	
	Knife Clip, Low Profile Replaces 1307280C3, 71346158, 86630786, H84412	AMX27554	\$ 3.95	
Platforms: 1010, 1020	Hold Down Clip For 1.50" Knife	AM101001A2	\$ 33.05	
	Hold Down Clip Hi-Arch, For 3" Knife	AM375900A1	\$ 14.00	
Platforms: 1042, 1052, 2042, 2052, 2062, 2142, 2152, 2162 Replaces 338591A1, 84399893	Hold Down Clip Hi-Arch Includes Nut and Bolt	AM118499	\$ 6.85	
Cutting Platforms: 1010, 1020, 2010, 2020, Draper Platforms: DHX182, DHX212, DHX252, DHX302, DHX362	Section Bolt and Nut Kit 7/32" x 5/8" Grade 8 Rib Neck, Package of 50 For Standard Straight Hole Sections Replaces 850716, 700705296	AM86507777	\$ 15.63	
Platform: 3020	Section Bolt and Nut Kit 22 mm, Package of 25	AMX26092	\$ 8.65	
	Section Bolt and Nut Kit 18 mm, Package of 50	AMX29061	\$ 13.00	

Chaff Spreaders and Components

Standard, patented single-wing arm design; spreader position is infinitely adjustable. Stainless steel front and rear shields. 39" chaff distribution area is the largest in the field. Complete with motor, hose kit and shaker pans.

Application	Description	Part Number	Retail Price	Core
 1420, 1440, 1460, 1480, 1620, 1640 BSN 97190, 1660 BSN 103800, 1680 BSN 117060	Chaff Spreader	AMEF1691IH	\$ 1695.00	
1640 ASN 97190, 1660 ASN 103800, 1680 ASN 117060	Chaff Spreader	AMEF1692CIHE	\$ 1695.00	
2144, 2166, 2188, 2344, 2366, 2388	Chaff Spreader	AMEF2100CIH	\$ 1695.00	
 1666, 1688, 2166, 2188, 2366, 2377, 2388, 2577, 2588, 5088, 5130, (5140, 6140, 7140 Prior to 10/2015), 6088, 6130, 7088, 7130, 7230, 7240, 7250, 8230, 8240, 8250, 9230, 9240, 9250	Chaff Spreader Disc 35.50" OD, Aluminum For Straw or Chaff Spreader	AM140189A1	\$ 204.00	
 1688, 2188, 2377, 2388 - w/ Straw and Chaff Spreader	Cleaning Shoe Door Shield Hardware Not Included	AM87301089	\$ 186.00	
 1644, 1666, 2144, 2166, 2344, 2366	Cleaning Shoe Door Shield, Narrow	AM122639A4	\$ 150.00	
 5088, 5130, 5140, 6088, 6130, 6140, 7088, 7130, 7140 - w/ Straw and Chaff Spreader	Cleaning Shoe Door Shield	AM87684740	\$ 158.00	

Case IH®—Combine

Application	Description	Part Number	Retail Price	Core
 7230, 7240, 7250, 8240, 8250, 9240, 9250	Spreader Divider Liner Kit Whale Tail Style, Stainless Steel Includes Right and Left Hand Weld-In Panels Replaces 47911828	AMX29151	\$ 375.00	
 2577, 2588 - w/ Straw and Chaff Spreader	Spreader Curtain Hardware Not Included	AM87739170	\$ 66.00	
 7010, 7120, 7130, 7230, 7240, 7250, 8010, 8120, 8230, 8240, 8250, 9010, 9120, 9230, 9240, 9250, AFX8010	Rubber Damper 310 mm x 178 mm (2) Required	AM84154916	\$ 22.00	

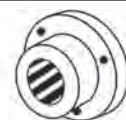

Hydraulic Pump Drive Hubs and Components

Application	Description	Part Number	Retail Price	Core
2144, 2166, 2188, 2344, 2366, 2377 SN HAJ292001-HAJ 300000, 2388 BSN JJC02766540 & ASN HAJ292001, (2577, 2588 ASN HAJ0300001)	Hydraulic Pump	AM87338787	\$ 1000.00	
2366 ASN JJC0255700, 2377, 2388 ASN JJC0270500, 2577, 2588	Hydraulic Pump	AM375147A1	\$ 675.00	
7010, 7120, 7230, 7240, 7250, 8010, 8120, 8230, 8240, 8250, 9010, 9120, 9230, 9240, 9250, AFX8010	Hydraulic Pump 63 cc	AM87105987	\$ 1824.95	
1420, 1440, 1460, 1470, 1480, 1620, 1640, 1644, 1660, 1666, 1670, 1680, 1688, 2144, 2166, 2188, 2344, 2366, 2377 SN HAJ292001-HAJ300000, 2388, (2577, 2588 ASN HAJ300001)	Auxiliary Hydraulic Pump Drive Hub Grease Zerk Not Included	AM196482C2	\$ 160.00	
5130, 5140, 5150, 6130, 6140, 6150, 7120, 7130, 7140, 7150, (7230, 9230 - w/ Common Cab), 7240 09/2014-09/16, 8120, 8230, 8240 Prior to 09/2017, 9120, 9240	Solenoid, Main Distributor Valve Replaces 87775314	AM188105A1	\$ 70.00	
5130, 5140, 5150, 6130, 6140, 6150, 7010, 7120, 7130, 7140, 7150, 7230, 7240, 7250, 8010, 8120, 8230, 8240, 8250, 9010, 9120, 9230, 9240, 9250, AFX8010	Solenoid 12 Volt	AM86995302	\$ 50.00	



Hydraulic Oil Coolers

Application	Description	Part Number	Retail Price	Core
2144 ASN JJC0173150, 2166 ASN JJC0180000, 2188 ASN JJC0191483, 2344, 2366	Hydraulic Oil Cooler w/ Fuel Cooler Core: 15" x 25" x 3 7/8" Replaces 195441A2	AM195441A3	\$ 980.00	
2366	Hydraulic Oil Cooler w/ Fuel Cooler Core: 33" x 35" x 3.10"	AM416766A2	\$ 1825.00	
2377, 2388, 2577, 2588	Hydraulic Oil Cooler Core: 36 1/2" x 24" x 3 7/8" Replaces 446343A1, 446343A2	AM446343A3	\$ 1575.00	
2388 BSN JJC0276540	Hydraulic Oil Cooler Core: 29.50" x 22" x 4.60" Replaces 242304A1, 275098A1	AM275098A2	\$ 1750.00	
	Hydraulic Oil Cooler Core: 35" x 24" x 3 7/8" Replaces 444921A3	AM444921A2	\$ 1530.00	
2388	Hydraulic Oil Cooler Core: 29 1/2" x 22" x 3 1/16" Replaces 275096A1	AM275096A2	\$ 1508.00	
5088, 6088, 7088	Hydraulic Oil Cooler Core: 36 3/8" x 24" x 3.80"	AM87614591	\$ 1600.00	

Case IH®—Combine

Application	Description	Part Number	Retail Price	Core
7010, 8010, 9010, AFX8010	Hydraulic Oil Cooler w/ Fuel Cooler Core: 36" x 41" x 3.50" Replaces 86976449	AM87106640	\$ 2026.00	
Patriot Sprayers: 2250, 3240, 3340, 4430, 4440	Hydraulic Oil Cooler Core: 19" x 36" x 3.40" Replaces 84223602	AM84427916	\$ 878.00	
Patriot Sprayers: 3230, 3330, SPX3320	Hydraulic Oil Cooler Core: 40.50" x 29" x 1.50"	AM86986928	\$ 724.00	
Patriot Sprayer: 4420	Hydraulic Oil Cooler Core: 36" x 36" x 1"	AM87271989	\$ 903.00	
8120, 8230, 9120, 9230	Condenser w/ Oil Cooler Replaces 84576582	AM47475783	\$ 1145.00	
Swathers: WD1903, WD2303	Condenser w/ Oil Cooler Core: 30 7/8" x 31" x 3.80" Replaces 87340522	AM87490300	\$ 1070.00	



Sickle Drives and Components

Application	Description	Part Number	Retail Price	Core
Grain Platforms: 1010 ASN JJC0300001, 1020 ASN JJC0315001	Wobble Box Assembly Replaces 87502685	AM133157A3	\$ 1625.00	
Platforms: 1042, 1052, 2042, 2052, 2062, 2142, 2152, 2162	Wobble Box	AM338670A1	\$ 1575.00	
Platforms: 2010, 2020, 2030, 2040, 2050	Wobble Box	AM85000175	\$ 1147.00	
Platforms: 3020, 3050 BSN C003	Wobble Box	AM87724927	\$ 1075.00	
Platforms: 810 ASN 501, 820	Wobble Box Pulley	AM182029C1	\$ 320.00	
Grain Platforms: 1010 ASN JJC0200001, 1020 SN JJC0215001-JJC0227000 & ASN JJC0315001	Wobble Box Pulley	AM138775A1	\$ 191.06	
Platforms: 1010	Wobble Box Lower Tray Replaces 87450181	AM129719A2	\$ 70.00	
	Wobble Box Support Plate	AM126316A1	\$ 75.00	
Platforms: 1052, 2042, 2052, 2062, 2142, 2152, 2162	Pulley, Knife Drive Gearbox	AM338585A1	\$ 265.00	
Platforms: 1010, 1020	Knife Drive Arm Replaces 126314A1	AM126314A2	\$ 121.96	
Platforms: 1052, 2042, 2052, 2062, 2142, 2152, 2162	Arm	AM369994A1	\$ 195.00	
Platform: 1020 SN JJC03150010-JJC0350294 & ASN JJC0215001	Idler Arm Replaces 87450150	AM138439A1	\$ 175.00	

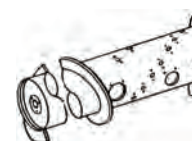

Auger Components—Bare Header / Platform

Application	Description	Part Number	Retail Price	Core
Platforms: 1010, 1020	Poly Finger Use w/ AMX29116 Finger Guide	AMX27276	\$ 9.00	
Platforms: (810, 820 ASN 25001), 1010, 1020 Replaces 434295A2	Auger Finger Use w/ AM87620690 Finger Guide	AM1320699C1	\$ 8.25	
Platforms: 2010, 2020	Auger Finger, Steel	AM87670642	\$ 16.00	
Platforms: 3020, 3050, 3152, 3162	Auger Finger	AM84194057	\$ 15.00	
Draper Platforms: 2142, 2152, 2162	Auger Finger Sold in Multiples of 5, Priced Individually Replaces 87561023	AM47548630	\$ 9.00	
Platforms: 1010, 1015, 1020	Auger Finger Shaft	AM1316383C1	\$ 111.84	

Case IH®—Combine

Application	Description	Part Number	Retail Price	Core
Platforms: 3016, 3020, 3050, 3152, 3162	Finger Holder	AM84362468	\$ 14.00	
Cutting Platforms: 1010, 1020, 2142, 2152, 2162	Finger Guide 9 1/8" Long Use w/ AMX27276 Poly Finger	AMX29116	\$ 3.45	
Grain Platforms: 810, 820, 1010, 1015, 1020, (2010, 2020 BSN CBJ20701), Draper Platforms: 1042 BSN CCC0010467, 1052 BSN CCC0012343, 2042, 2052, 2062, 2142, 2152, 2162 Replaces 410718A1, 1307259C1, 1307259C2, 87051323, 87666079, 87685315	Finger Guide Use w/ AM1302699C1 Finger	AM87620690	\$ 3.75	
Draper Platforms: 1042 ASN CCC0010467, 1052 ASN CCC0012343, 2042, 2052, 2062, 2142, 2152, 2162	Retracting Finger Guide Nut	AM410726A1	\$ 0.75	
Platforms: 810, 820, 1010, 1015, 1020, Draper Platforms: 1042, 1052, 2042, 2052, 2062	Hub Replaces 410719A1	AM1308425C1	\$ 3.95	
Platforms: 1010 ASN JJC0200001, 1020 SN JJC0215001-JJC0227000 & ASN JJC0315001	Auger Drive Sprocket	AM125990A1	\$ 32.00	
Platforms: (1010, 1020 ASN CBJ023001)	Auger Driven Sprocket 56 Tooth, 14 Spline	AM87450164	\$ 145.00	
Platforms: 1010, 1020, 2010, 2020	Idler Sprocket Replaces 179013A1	AM86627870	\$ 36.00	
Platforms: 810, 820	Slip Clutch Plate 6.50" Bolt Circle, 0.343" Hole Diameter	AM177963C1	\$ 125.17	
Platforms: 810 ASN 501, 820	Slip Clutch Facing 2.97" ID, 6" OD, 0.192" Thick	AM177964C2	\$ 16.07	
Cutting Platforms: 810, 820, 1010, 1015, 1020, Draper Platforms: 810	Bearing, Auger Shaft	AM664073R92	\$ 22.00	

Reel Components

Application	Description	Part Number	Retail Price	Core
Platforms: 820, 1020 - w/ Love Teardrop Reel	Reel Tine	AM1979845C1	\$ 4.16	
Platforms: 1010, 1020 Replaces 1989438C1, 9842263, B93868, B94710	Reel Tine Nylon, 3-Piece Double Wing Unit 4.50" Spacing Includes Hardware Sold in Multiples of 25, Priced Individually Replaces center tine, some modification required for right and left hand sides	AMTINE	\$ 2.00	
Platforms: 2010, 2020, 3020 Replaces 410856A1, 86608282, 86620758, B95856, B95857, B95872	Reel Tine Nylon, Double Wing Unit, 6" Spacing Includes Hardware Sold in Multiples of 25, Priced Individually	AMX27222	\$ 2.25	
Platforms: 2010, 2020, 3020 Replaces 410858A1, 86608284, 86620757	Reel Tine, Right Hand Wing 6" Spacing, Includes Hardware	AMX29057	\$ 3.76	
Platforms: 2010, 2020, 3020 Replaces 410857A1, 86608283, 86620755	Reel Tine, Left Hand Wing Nylon, 6" Spacing Includes Hardware	AMX29056	\$ 3.76	
Platform: 1020 ASN CBJ023001 Replaces 1970586C1, B93866, B1970586C1	Reel Tine For Platforms w/ Tear Drop Bats and Tines Mounted to Rear of the Steel Bat	AM1970586C1	\$ 1.58	
Platforms: 1052, 2052, 2062	Reel Tine Sold in Multiples of 25, Priced Individually Replaces 105212, 105351, 105352	AM381139A1	\$ 2.50	
Platforms: 2142, 2152, 2162	Reel Tine, HD Sold in Multiples of 25, Priced Individually	AM87561020	\$ 3.00	
Draper Platforms: 3152, 3162, DH213, DH253, DH303, DH363, DH403	Reel Tine Sold in Multiples of 25, Priced Individually Replaces 48056250, 48151645, 84566589	AM47392794	\$ 3.60	

Prices Subject to Change without Prior Notice. The use of original equipment manufacturer (OEM) part numbers or trademarks, e.g. Case® and John Deere®, are for reference purposes only and for indicating product use and compatibility. Our company and the listed replacement parts contained herein are not sponsored, approved or manufactured by the OEM. All parts are New unless designated Reman in the description.

Case IH®—Combine

Application	Description	Part Number	Retail Price	Core
Draper Platforms: DHX181, DHX182, DHX211, DHX212, DHX251, DHX252, DHX301, DHX302, DHX361, DHX362	Reel Tine, Flexible Tear Drop Style Replaces 276306M1, 700708862, 800714195	AM86562205	\$ 2.26	
Platforms: 1010, 1020, 2020	Quick Fingers, 10 Pack	AMX27550	\$ 22.00	
Draper Platforms: 2142, 2152, 2162	Quick Finger Repair Tine	AMX41116	\$ 2.95	
Platforms: 1010, 1020, 2010 Rigid, Draper Platforms: DHX181, DHX182, DHX211, DHX212, DHX251, DHX252, DHX301, DHX302, DHX361, DHX362	Reel Bearing Replaces 84469382, 89842300, 9842300	AM1347084C1	\$ 1.95	
Draper Platforms: 2142, 2152, 2162	Reel Pipe Bushing Replaces 47731149, 87566335	AM47548631	\$ 18.00	
Platforms: 1010, 1020, 2010, 2020, Draper Platforms: DHX181, DHX182, DHX211, DHX212, DHX251, DHX252, DHX301, DHX302, DHX361, DHX362	Eccentric Bushing, Pickup Reel - Female Replaces 86518392	AM114951A1	\$ 2.50	
	Eccentric Bushing, Pickup Reel - Male Replaces 86518393	AM114952A1	\$ 2.50	
Platforms: 1010, 1020, 2010, 2020	Reel Drive Sprocket 17 Tooth, 1.125" Bore w/ Keyway	AM87035837	\$ 35.00	
Platforms: 1010, 1020, 2010, 2020	Reel Drive Sprocket 51 Tooth, 1.57" ID Replaces 87036543	AM129973A1	\$ 85.00	
Platform: 1020	Reel Repair Kit, No Pin Style For reel pipes w/ 4 1/2" reel finger spacing and no visible holes on either side of the plastic bearing until the reel fingers on each side are removed	AMBN-KITNPS	\$ 29.50	
	Reel Repair Kit, Roll Pin Style For reel pipes w/ 4 1/2" reel finger spacing and roll pins or plastic washers on each side of the plastic bearing	AMBN-KITRP	\$ 29.50	
Platforms: 1020, 2042, 2052, 2062, 2142, 2152, 2162	Reel Repair Kit, Hex Hole Style For Reel pipes w/ hex holes on the bottom of the pipes and 6" reel finger spacing	AMBN-KITHXH	\$ 35.00	
7010, 7120, (7230, 8230, 9230 - w/ Non-Common Cab), 8010, 8120, 9010, 9120, AFX8010	Solenoid, Reel Drive Valve Replaces 87775314	AM188105A1	\$ 70.00	

Platform Floor Sheets

Application	Description	Part Number	Retail Price	Core
1020 BSN JJC0227000 & ASN JJC0315001	Bottom Floor Sheet 109" Long	Center AM1313156C2	\$ 395.00	
	Bottom Floor Sheet 38.625" Long For 15' Platform	Right Hand AM1313138C2	\$ 135.00	
		Left Hand AM1313132C2	\$ 135.00	
	Bottom Floor Sheet 65.625" Long For 20' Platform	Right Hand AM1313140C2	\$ 210.00	
		Left Hand AM1313134C2	\$ 220.00	
	Bottom Floor Sheet 95.625" Long For 25' Platform	Right Hand AM1313142C2	\$ 352.00	
Left Hand AM1313136C2		\$ 280.00		
Bottom Floor Sheet 125.625" Long For 30' Platform	Right Hand AM1313143C2	\$ 350.00		
	Left Hand AM1313137C2	\$ 350.00		

Case IH®—Combine

Platform Components

Application	Description	Part Number	Retail Price	Core
Platforms: 1010, 1020	Jackshaft, Knife Drive 45.12" Long, 1.125" Hex Shaft Diameter	AM125971A2	\$ 129.71	
Platforms: 1010 BSN JJC0200000, 1015, 1020 BSN JJC0215001	Shaft Collar, Main Drive	AM1327106C1	\$ 26.24	
2144, 2166, 2188, 2344, 2366, 2377, 2388, 2577, 2588, 5088, 5130, 5140, 6088, 6130, 6140, 7088, 7130, 7140, 7230, 7240, 8230, 8240, 9230, 9240, Cotton Pickers: 420, 620, 625, 635, 2155, 2555, CPX420, CPX610	Potentiometer, Header Adjustment	AM114551A1	\$ 57.00	
Platform: 3020	Support Bracket, Left Hand	AM84296810	\$ 160.00	
Platforms: 3020, 3050, Draper Platform: 3162	Sprocket 47 Tooth For Slow RPM Auger Drive Replaces 47579289	AM84209468	\$ 265.00	
Platforms: 3020, 3152, 3162	Sprocket Assembly 43 Tooth, 80 Pitch	AM84176718	\$ 210.00	
Platform: 3152, 3162 - 11/2011 and Later	Turret Flap	AM47553645	\$ 75.00	
Platforms: 1020, 3020	Spring Nut, Upper	AM124366A1	\$ 50.00	
	Spring Plug, Lower	AM1313104C1	\$ 40.00	
5130, 5140, 6130, 6140, 7130, 7140, 7230, 7240, 8230, 8240, 9230, 9240	Quick Male Coupling, Header Coupler Replaces 47472035, 84435502	AM47360258	\$ 32.00	
	Quick Male Coupling, Header Coupler Replaces 47870683, 87691267	AM84580534	\$ 21.00	

Row Crop Dividers

Eliminate costly grain loss from knocked down plants. Change from short to long dividers in minutes. Safer transportation and easy storage. Sectional design allows you to replace only the damaged piece which saves you money.



Application	Description	Part Number	Retail Price	Core
Flex Platforms: 800 Series	Complete Set of Dividers, Short	AMSCD500IH	\$ 1175.00	
	Components:			
	Rear Divider	1 AMSCD100IH-RH	\$ 400.00	
	Rear Divider	1 AMSCD100IH-LH	\$ 400.00	
	Short Divider Tip	2 AMSCD250	\$ 75.00	
	Divider Nose Bar	2 AMSCD300	\$ 50.00	
Flex Platforms: 800 Series	Complete Set of Dividers, Long	AMSCD400IH	\$ 1350.00	
	Components:			
	Rear Divider	1 AMSCD100IH-RH	\$ 400.00	
	Rear Divider	1 AMSCD100IH-LH	\$ 400.00	
	Divider Front Wing Section, Long	2 AMSCD200	\$ 550.00	
	Divider Nose Bar	2 AMSCD300	\$ 50.00	
Flex Platforms: 800 Series	Short Divider Tip	AMSCD250	\$ 55.00	
Fits All 1020 Platforms	OEM Style Divider	Right Hand	AM1316061C1	\$ 525.00
		Left Hand	AM1316060C3	\$ 585.00
	Outer Wing Assembly	AM1316062-N	\$ 585.00	

Case IH®—Combine



Header Lift Cylinders and Components

Application	Description	Part Number	Retail Price	Core
2144, 2166, 2188, 2344, 2366, 2388, 2577, 2588, 5088, 6088	Third Cylinder Kit For 54" Feederhouse w/ Rock Trap	AM137857A2	\$ 975.00	
	Third Cylinder Kit For 60" Feederhouse	AM137856A2	\$ 975.00	
2144, 2166, 2188, 2344, 2366, 2377, 2388, 2588	Header Lift Cylinder 2 7/8" Diameter, 22 15/16" Stroke	AM251807A2	\$ 510.00	
2144, 2166, 2188, 2344, 2366, 2377, 2388, 2577, 2588	Extension Tube, Feederhouse Lift Cylinder For 54.50" Feederhouse w/ Rock Trap	AM124059A2	\$ 99.50	
(7010, 8010, 9010, AFX8010 - Heavy Duty), 7230, 7240, 8230, 8240, 9230, 9240	Header Lift Cylinder 90 mm Replaces 84193227, 87728497	AM84263630	\$ 1350.00	
7010, 7120, 7230, 8010, 8120, 8230, 9010, 9120, 9230, AFX8010	Lateral Tilt Cylinder, HD 5.51" (140 mm) Stroke Length	AM87753846	\$ 368.00	
2144, 2166, 2188, 2344, 2366, 2377 SN AJ292001-HAJ300000, 2388 BSN JJC0276540 and SN HAJ292001-HAJ300000, 2577, 2588	Hydraulic Lift Valve	AM124566A3	\$ 4350.00	
2144, 2166, 2188, 2344, 2366, 2377, 2388, 2577, 2588, 5130, 5140, 5150, 6130, 6140, 6150, 7010, 7120, 7130, 7140, 7150, 7230, (7240, 8240, 9240 - Prior to 09/2017), 8010, 8120, 8230, 9010, 9120, 9230, AFX8010	Solenoid, Header Height Valve Replaces 87775314	AM188105A1	\$ 70.00	
2144, 2188, 2377, 2388, 2577, 2588	Seal Kit For Feederhouse Lift Cylinder Replaces 87385882	AM87552535	\$ 68.00	
5088, 5130, 5140, 6088, 6130, 6140, 7010, 7088, 7120, 7130, 7140, 7230, 7240, 8010, 8120, 8230, 8240, 9010, 9120, 9230, 9240, AFX8010	Seal Kit For Lateral Tilt Cylinders Replaces 84142087, 87352396	AM87105744	\$ 175.00	
5088, 6088, 7010, 7088, 7120, 7240, 8010, 8120, 8240, 9010, 9120, AFX8010	Seal Kit For Header Lift Cylinder, 75 mm	AM87031097	\$ 224.00	



Draper Belts and Components

Application	Description	Part Number	Retail Price	Core
Platforms: 1042, 1052, 2042, 2052, 2062	Draper Center Feeder Belt 38.40" x 97.00" Single V-Guide For 38.00" Feed Deck	AM338361A1	\$ 338.00	
Platforms: 1042, 2042 - w/ Double Delivery	Draper Belt, HD 30' Right Hand, 41.60" x 345.00" Single V-Guide	AM338630A1	\$ 750.00	
	Draper Belt, HD 30' Left Hand, 41.60" x 297.80" Single V-Guide	AM338629A1	\$ 685.00	
	Draper Belt, HD 36' Right Hand, 41.60" x 417.00" Single V-Guide	AM338635A1	\$ 962.00	
	Draper Belt, HD 36' Left Hand, 41.60" x 369.70" Single V-Guide	AM338633A1	\$ 847.00	
Platforms: (1042, 1052 ASN CCC0010467), 2042, 2052, 2062 - w/ Center Delivery Replace 430272A1	Draper Center Feeder Belt 45.00" x 97.00" Single V-Guide For 45.00" Feed Deck	AM114267	\$ 319.00	

Case IH®—Combine

Application	Description	Part Number	Retail Price	Core
Platforms: 1052, 2052 - w/ Double Delivery	Draper Belt, HD 21' Right and Left Hand, 71.60" x 201.00" Single V-Guide	AM346016A1	\$ 459.00	
Platforms: 1052, 2052, 2062 - w/ Double Delivery	Draper Belt, HD 25' Right and Left Hand, 41.60" x 249.00" Single V-Guide	AM346018A1	\$ 578.00	
	Draper Belt, HD 30' Right and Left Hand, 41.60" x 309.00" Single V-Guide	AM346022A1	\$ 674.00	
Platforms: 1052, 2052, 2062 - w/ Center Delivery	Draper Belt, HD 36' Right Hand, 41.60" x 405.00" Single V-Guide	AM372312A1	\$ 934.00	
Platforms: 1052, 2052, 2062 - w/ Double Delivery	Draper Belt, HD 36' Left Hand, 41.60" x 357.00" Single V-Guide	AM372311A1	\$ 783.00	
Platforms: 2042, 2052, 2062 Replaces 87407808	Draper Center Feeder Belt 55.90" x 97.00" Single V-Guide	AM101672	\$ 432.00	
Platforms: 1052, 2052, 2062 - w/ Center Delivery	Draper Belt, HD 39' Right Hand, 41.60" x 433.00" Single V-Guide	AM87446870	\$ 940.00	
	Draper Belt, HD 39' Left Hand, 41.60" x 389.00" Single V-Guide	AM87446868	\$ 891.00	
Platforms: 1052, 2052, 2062 - w/ End Delivery	Draper Belt, HD 36' Right Hand - Outboard Deck, 41.60" x 154.00" Single V-Guide	AM372321A1	\$ 485.00	
	Draper Belt, HD 39' Right Hand - Outboard Deck, 41.60" x 182.00" Single V-Guide	AM87446869	\$ 448.00	
Platforms: 2142, 2152, 2162 - w/ Center Delivery	Draper Center Feeder Belt 78.50" x 63.46" Single V-Guide	AM87560973	\$ 415.00	
Platforms: 2152, 2162	Draper Belt, HD 20' Right and Left Hand, 41.60" x 158.24" Single V-Guide	AM47611890	\$ 450.00	
Platforms: 2142, 2152, 2162 Replaces 47563846, 87560977, 87605706	Draper Belt, HD 25' Right and Left Hand, 41.60" x 217.24" Single V-Guide	AM47767475	\$ 575.00	
Platforms: 2142, 2152, 2162 - w/ Double or Triple Delivery Replaces 87560978	Draper Belt, HD 30' Right and Left Hand, 41.60" x 277.24" Single V-Guide	AM47489938	\$ 645.00	
Platforms: 2142, 2152, 2162 - w/ Double Delivery Replaces 47610128, 47679354	Draper Belt, HD 35' Right and Left Hand, 41.60" x 337.24" Single V-Guide	AM87560979	\$ 750.00	
Platforms: 2152, 2162 - w/ Double Delivery Replaces 47610129, 47679353	Draper Belt, HD 40' Right and Left Hand, 41.60" x 397.24" Single V-Guide	AM87560980	\$ 1004.00	
Platforms: 2152, 2162 Replaces 47767476, 51471583, 84122227	Draper Belt, HD 45' Right and Left Hand, 41.60" x 457.24" Single V-Guide	AM84399888	\$ 1019.00	
Platform: 3162 Replaces 47932768, 84289411	Draper Center Feeder Belt 42.00" x 60.24" Single V-Guide	AM47435658	\$ 264.00	
Platforms: 8210, 8220, 8230, 8240 ASN CFH0064005 Pull-Type	Draper Belt 21' Left Hand, 42.00" x 140.63" Long Bar	AM700712955	\$ 304.00	

Prices Subject to Change without Prior Notice. The use of original equipment manufacturer (OEM) part numbers or trademarks, e.g. Case® and John Deere®, are for reference purposes only and for indicating product use and compatibility. Our company and the listed replacement parts contained herein are not sponsored, approved or manufactured by the OEM. All parts are New unless designated Reman in the description.

Case IH®—Combine

Application	Description	Part Number	Retail Price	Core
Platforms: (8210, 8220, 8230, 8240 - 21' Models ASN CFH0064005 or 25' Models ASN CFH0065015 Pull-Type)	Draper Belt 21' or 25' Right Hand, 42.00" x 275.38" Long Bar	AM700712956	\$ 480.00	
Platform: 3152	Draper Center Feeder Belt 42.00" x 50.24" Single V-Guide Replaces 47377069, 47435660	AM47932836	\$ 264.00	
	Side Draper Belt 25' Right and Left Hand, 41.60" x 207.40" Single V-Guide	AM47371562	\$ 576.00	
Platforms: 3152, 3162 Replaces 84307562	Side Draper Belt 30' Right and Left Hand, 41.60" x 267.40" Single V-Guide	AM47371565	\$ 638.00	
Platforms: 3152, 3162 Replaces 87743629	Side Draper Belt 35' Right and Left Hand, 41.60" x 327.40" Single V-Guide	AM47371567	\$ 750.00	
Platforms: 3152, 3162 Replaces 87478999	Side Draper Belt 40' Right and Left Hand, 41.60" x 387.40" Single V-Guide	AM84487818	\$ 873.00	
Platforms: 3152, 3162 Replaces 87753630	Side Draper Belt 45' Right and Left Hand, 41.60" x 447.40" Single V-Guide	AM47371571	\$ 983.00	
Platforms: 1042, 2042, 1052, 2052, 2062	Draper Belt Repair Kit For 41.60" Belt Includes 34" Repair Section of RAPTOR Material, Pre-Punched for Connector, (2) Steel Tube Connectors and Hardware	AM1014725	\$ 190.00	
Platforms: 2142, 2152, 2162	Draper Belt Repair Kit For 41.60" Belt Includes 34" Repair Section of RAPTOR Material Pre-Punched for Connector, (2) Steel Tube Connectors and Hardware	AMX27266	\$ 160.50	
Platforms: 3152, 3162	Draper Belt Repair Kit For 41.60" Belt Includes 34" Repair Section of RAPTOR Material, Pre-Punched for Connector, (2) Steel Tube Connectors and Hardware	AM1014727	\$ 190.00	
Platforms: 2142, 2152, 2162	Steel Tube Connector Set For 41.60" Belts 39.80" Long Includes (2) Steel Tube Connectors and Hardware	AM1002377	\$ 40.00	
Platforms: Most Models	Steel Tube Connector 10 Holes, 38.78" Long	AM1005840	\$ 33.00	







Poly Skid Plate Kits and Components

Application	Description	Part Number	Retail Price	Core
Platform: 820	Poly Skid Plate Kit	13' CS13IH	\$ 470.00	
		15' CS15IH	\$ 530.00	
		16.50' CS16.5IH	\$ 540.00	
		17.50' CS17.5IH	\$ 565.00	
		20' CS20IH	\$ 605.00	
		22.50' CS22.5IH	\$ 770.00	









Case IH®—Combine

Application	Description	Part Number	Retail Price	Core
Platform: 1020	Poly Skid Plate Kit	15' CS15IHNA	\$ 590.00	
		17.50' CS175IHNA	\$ 640.00	
		20' CS20IHNA	\$ 700.00	
		22.50' CS225IHNA	\$ 855.00	
		25' CS25IHNA	\$ 850.00	
		30' CS30IHNA	\$ 950.00	
Platforms: 2142, 2152, 2162	Poly Skid Plate, Right End Replaces 87561542	AM165386	\$ 50.00	
	Poly Skid Plate, Left End Replaces 87561540	AM165188	\$ 50.00	
	Poly Skid Plate, Center Replaces 47414657, 87561539	AM165208	\$ 60.00	
	Poly Skid Plate Transition Pan (4) Required Replaces 87597512	AM151551	\$ 45.00	
Draper Platforms: 2062, 2142, 2152, 2162	Poly Skid Plate, Cutterbar	AM87532221	\$ 9.50	
Platforms: 1020 JJC031500-JJC0350294, 2020, 3020, 3152, 3162	Skid Shoe Narrow	AM251206A2	\$ 17.00	
Platforms: 1020, 2020, 3020, 3152, 3162	Skid Shoe	AM377580A1	\$ 8.00	
Platform: 1020 ASN CBJ023001	Inner Runner Support	AM392423A3	\$ 250.00	





Lighting

Application	Description	Part Number	Retail Price	Core
 5088, 6088, 7088, 7120, 7130, 7230, 8010, 8120, 8230, 9120, 9130, 9230 - Early Models w/ 6 Lights on Top of the Cab	LED Floodlight Kit (4) Outer Cab Lights*, (2) Center Cab Lights*, (2) Stubble Lights** Includes Connectors and Mounting Hardware Uses Original Mount and Wiring *6000 Lumens, 65 Watts, 5.40 Amps **2900 Lumens, 35 Watts, 2.90 Amps	AMX34187	\$ 920.00	
 2144, 2166, 2188, 2344, 2366, 2377, 2388, 2577, 2588	LED Floodlight/Spotlight Combo Kit Includes (2) Center Hi/Lo Beams, (4) Outer High Beams and Mounting Hardware 4" x 6" Rectangle Combo Lights Each Light is 3500 Lumens, 60 Watts, 5 Amps For 12 to 24 Volt Systems Direct Replacement, Plug-and-Play	AMX34188	\$ 570.00	
 5088, 6088, 7010, 7088, 7120, 7130, 7230, 8010, 8120, 8230, 9120, 9130, 9230	LED Light Kit Includes (2) LED Center Headlights, Hi/Lo Beam*, (4) LED Outer Headlights*, (6) LED Work Lights**, Connectors and Mounting Hardware For 12 Volt to 24 Volt Systems Plug-and-Play Installation *6000 Lumens, 65 Watts, 5.40 Amps **2900 Lumens, 35 Watts, 2.90 Amps	AMX34174	\$ 1280.00	
 2144, 2166, 2188, 2344, 2366, 2377, 2388, 2577, 2588	LED Light Kit Includes (2) LED Center Headlights*, (4) LED Outer Headlights* and (8) LED Work Lights** For 12 Volt to 24 Volt Systems Plug-and-Play Installation *3500 Lumens, 60 Watts, 5 Amps **3600 Lumens, 40 Watts, 3.30 Amps	AMX34155	\$ 1200.00	







Case IH®—Combine

Application	Description	Part Number	Retail Price	Core
 Titan Floaters: 3020, 3040, 3540, 4020, 4030, 4040, 4520, 4530, 4540, Sprayers: 3320, 4420, SPX4260, SPX4410	LED Headlight, Right Hand 5300 Lumens, 70 Watts, 5.80 Amps For 12 Volt to 24 Volt Systems Includes Stainless Steel Hardware Replaces 232450A2, 365841A1, 87429390	AM232448A2	\$ 180.00	
	LED Headlight, Left Hand 5300 Lumens, 70 Watts, 5.80 Amps For 12 Volt to 24 Volt Systems Includes Stainless Steel Hardware Replaces 232451A2, 365842A1, 87429389	AM232449A1	\$ 180.00	
 Sprayers: 3320, 4420, SPX4260, SPX4410	LED Headlight, Center 4.25" x 10.50" Rectangle Light 7200 Lumens, 108 Watts, 9 Amps For 12 Volt to 24 Volt Systems Replaces 232454A2, 232455A2	AMTL6010	\$ 175.00	
 Universal Equipment	LED Floodlight All-Position Light 4.25" x 4.25" Square Light 2650 Lumens, 48 Watts, 4 Amps For 12 Volt to 24 Volt Systems Includes Mounting Bracket and Stainless Steel Hardware	AMTL105F	\$ 95.00	
 Universal Equipment	LED Floodlight All-Position Light 6.25" x 1.75" Rectangle Light 1300 Lumens, 18 Watts, 1.50 Amps For 12 Volt to 24 Volt Systems Includes Mounting Bracket and Stainless Steel Hardware	AMTL118F	\$ 50.00	
 Universal Equipment	LED Floodlight All-Position Light 5" Round Light 3200 Lumens, 40 Watts, 3.30 Amps For 12 Volt to 24 Volt Systems Includes Mounting Bracket and Stainless Steel Hardware	AMTL180	\$ 89.00	
 Universal Equipment	LED Floodlight All-Position Light Round Light 6900 Lumens, 50 Watts, 4.10 Amps For 9 Volt to 32 Volt Systems Includes Mounting Bracket and Stainless Steel Hardware	AMTL500F	\$ 120.00	
	LED Floodlight All-Position Light 4.30" Round Light 5040 Lumens, 50 Watts, 4.10 Amps For 12 Volt to 24 Volt Systems Includes Stainless Steel Adjustable Mounting Bracket	AMAT305931	\$ 96.00	
 Universal Equipment	LED Floodlight All-Position Light 4.25" Round Light 2650 Lumens, 42 Watts, 3.50 Amps For 12 Volt to 24 Volt Systems Includes Mounting Bracket and Stainless Steel Hardware	AMTL115F	\$ 59.00	
 Universal Equipment	LED Wide Floodlight All-Position Light 5" x 7" Rectangle Light 3800 Lumens, 35 Watts For 12 Volt to 24 Volt Systems Replaces 47682629, 47682620, 84236850, 87555142, 87584890	AMX34171	\$ 60.00	







Case IH®—Combine

Application	Description	Part Number	Retail Price	Core
 Universal Equipment	LED Floodlight, Sealed Beam Fender Mount 4.50" Diameter Round Light 1250 Lumens, 18 Watts, 1.50 Amps Trapezoid Pattern For 12 Volt to 24 Volt Systems Replaces 131203C1, 373662R1, 373662R91	AMTL3010	\$ 40.00	
	LED Floodlight Fender Mount 4.50" Diameter Sealed Beam Round Light 1250 Lumens, 18 Watts, 1.20 Amps Trapezoid Pattern For 12 Volt to 24 Volt Systems Lasts 50 times longer than halogen lighting, vibration resistant w/ no filament failures, uses original mount and wiring, Operating temperature of -40°F to 140°F / -40°C to 60°C Replaces 131203C1, 373662R1, 373662R91	AMRE336111	\$ 35.00	
 Universal Equipment	LED Floodlight Fender Mount 4.50" Diameter Sealed Beam Round Light 1440 Lumens, 18 Watts, 1.60 Amps Lasts 50 times longer than halogen lighting, vibration resistant w/ no filament failures, 2-terminal connection, Operating temperature of -40°F to 140°F / -40°C to 60°C Replaces 131203C1	AMRE336112	\$ 67.75	
 Floaters: 3520, 4020, 4520, FLX3010, FLX3510, FLX4010, FLX4510, Patriot Sprayer: 4420, Sprayer: SPX4410 Replaces 92263C1, 178345A1, 180097A1, 275335A1, 305256A1, 1983210C1, 87435762, 87773385	LED Floodlight Lower Front, Cab, Fender and ROPS 6" x 3.50" x 6" Rectangle Light 3600 Lumens, 40 Watts, 3.30 Amps For 12 Volt to 24 Volt Systems Includes Connector, Plug-and-Play	AMTL3030	\$ 90.00	
	LED Floodlight Lower Front, Cab, Fender and ROPS 6" x 3.50" x 6" Rectangle Light 3600 Lumens, 40 Watts, 3.30 Amps For 12 Volt to 24 Volt Systems Includes Connector, Plug-and-Play	AM92269C1	\$ 72.00	
 5088, 6088, 7088, 7120, 7130, 7230, 8010, 8120, 8230, 9120, 9130, 9230 Replaces 87106352, 87106354	LED Floodlight Hood Mount 6.50" x 4.50" x 4" Oval Light Dual Hi/Lo Beam 6000 Lumens, 65 Watts, 5.40 Amps For 12 Volt to 24 Volt Systems Uses Original Mount and Wiring, Plug-and-Play	AMTL8520S	\$ 125.00	
	LED Floodlight Hood Mount 6.50" x 4.50" x 4" Oval Light Dual Hi/Lo Beam 6000 Lumens, 65 Watts, 5.40 Amps For 12 Volt to 24 Volt Systems Uses Original Mount and Wiring, Plug-and-Play	AMRE173600	\$ 112.50	

Case IH®—Combine

Application	Description	Part Number	Retail Price	Core
 <p>2166, 2188, 2366, 2377, 2388, 2577, 2588 Replaces 138225A1, 183162A1, 353656A1, 353657A1, 87368623</p>	<p>LED Floodlight Cab Mount 4" x 6.50" Rectangle Light High Beam 3500 Lumens, 60 Watts, 5 Amps For 12 Volt to 24 Volt Systems Includes Connector, Plug-and-Play</p>	AMTL6080	\$ 99.00	
	<p>LED Floodlight Grille Mount 4" x 6.50" Rectangle Light High Beam 3500 Lumens, 60 Watts, 5 Amps For 12 Volt to 24 Volt Systems Includes Connector, Plug-and-Play</p>	AM353656A1	\$ 95.00	
 <p>5088, 6088, 7088, 7120, 7130, 7230, 8010, 8120, 8230, 9120, 9230, Cotton Picker: 625 Module Express</p>	<p>LED Floodlight Cab Mount 6.50" x 4.50" x 4" Oval Light 6000 Lumens, 65 Watts, 5.40 Amps For 12 Volt to 24 Volt Systems Uses Original Mount and Wiring, Plug-and-Play Replaces 87106353</p>	AMTL8420	\$ 125.00	
	<p>LED Floodlight Cab Mount 6.50" x 4.50" x 4" Oval Light 6000 Lumens, 65 Watts, 5.40 Amps For 12 Volt to 24 Volt Systems Uses Original Mount and Wiring, Plug-and-Play</p>	AM87106353	\$ 112.50	
 <p>Universal Equipment</p>	<p>LED Floodlight Cab and Fender Mount 3.50" x 6" Rectangle Light 3600 Lumens, 40 Watts, 3 Amps</p>	AMX34146	\$ 65.00	
 <p>2388, 5130, 5140, 6130, 6140, 7010, 7130, 7140, 7230, 7240, 7250, 8010, 8120, 8230, 8240, 8250, 9010, 9120, 9230, 9240, 9250, AFX8010 Replaces 870001315, 87284332, 87584890</p>	<p>LED Floodlight 5.75" x 3.75" x 3" Oval Light 2900 Lumens, 35 Watts, 2.90 Amps For 12 Volt to 24 Volt Systems Includes Stainless Steel Mounting Hardware and Mounting Bracket</p>	AMTL5655	\$ 95.00	
 <p>2144, 2166, 2188, 2344, 2366, 2377, 2388, 2577, 2588, Cotton Pickers: 420, 625, CPX420, CPX610, CPX620</p>	<p>LED Floodlight/Spotlight Cab Mount 4" x 6.50" Rectangle Light Dual Hi/Lo Beam 3500 Lumens, 60 Watts, 5 Amps For 12 Volt to 24 Volt Systems Replaces 138225A1, 183162A1, 353657A1, 87367623</p>	AMTL6090	\$ 99.00	
	<p>LED Floodlight/Spotlight Cab Mount 4" x 6.50" Rectangle Light Dual Hi/Lo Beam 3500 Lumens, 60 Watts, 5 Amps For 12 Volt to 24 Volt Systems Replaces 138225A1, 183162A1, 353657A1</p>	AM87367623	\$ 79.20	
 <p>5140, 6140, 7140, 7230, 8230, 8240, 9230, 9240 Replaces 47430977, 47430979</p>	<p>LED Floodlight/Spotlight Combo Upper Cab Mount 6" x 3" x 3.25" Oval Light 3200 Lumens, 40 Watts, 3.30 Amps For 12 Volt to 24 Volt Systems Uses Original Hardware, Plug-and-play Plastic Bezel Not Included</p>	AMTL8050	\$ 95.00	

Case IH®—Combine



Application	Description	Part Number	Retail Price	Core
 Universal Equipment	LED Spotlight All-Position Light 4.25" x 4.25" Square Light 1400 Lumens, 27 Watts, 2.20 Amps For 12 Volt to 24 Volt Systems	AMTL100S	\$ 45.00	
 Universal Equipment	LED Spotlight All-Position Light 6.25" x 1.75" Rectangle Light 1300 Lumens, 18 Watts, 1.50 Amps For 12 Volt to 24 Volt Systems Includes Mounting Bracket and Stainless Steel Hardware	AMTL118S	\$ 50.00	
 Universal Equipment	LED Spotlight All-Position Light Round Light 6900 Lumens, 50 Watts, 4.10 Amps For 9 Volt to 32 Volt Systems Includes Mounting Bracket and Stainless Steel Hardware	AMTL500S	\$ 120.00	
 5088, 5140, 6088, 6140, 7088, 7120, 7130, 7140, 7230, 8010, 8120, 8230, 8240, 9120, 9130, 9230, 9240 Replaces 87584890	LED Conversion Light Stubble Light 5.75" x 3.75" Oval Light 2900 Lumens, 35 Watts, 2.90 Amps For 12 Volt to 24 Volt Systems Includes Bracket and Connectors	AMTL5650	\$ 95.00	
	LED Conversion Light Stubble Light 5.75" x 3.75" Oval Light 2900 Lumens, 35 Watts, 2.90 Amps For 12 Volt to 24 Volt Systems Includes Bracket and Connectors	AMAH207788	\$ 76.00	
 Universal Equipment	LED Trapezoid Light Cab and Fender Mount 4.50" Diameter Round Light 2800 Lumens, 40 Watts, 3.30 Amps Trapezoid Pattern For 12 Volt to 24 Volt Systems Bottom Mount w/ Built-In Heat Sink Includes Mounting Bracket, Long and Short Rubber Bezels and Stainless Steel Hardware Replaces 131368C92	AMTL2080	\$ 95.00	
	LED Trapezoid Light Cab and Rear Fender Mount 4.50" Diameter Round Light 2800 Lumens, 40 Watts, 3.30 Amps Trapezoid Pattern For 12 Volt to 24 Volt Systems Bottom Mount w/ Built-In Heat Sink Includes Mounting Bracket, Long and Short Rubber Bezels and Stainless Steel Hardware Replaces 131368C92	AMX33121	\$ 76.00	
 Universal Equipment	LED Warning Light Cab, Header or Swather Mount Can be used for Turn Signal, Brake or Running Lights 4.125" Diameter Round Light Double Sided, Amber Lenses 25 Bulbs per Side For 12 Volt to 24 Volt Systems	AMTLFL2	\$ 55.00	
	LED Warning Light Cab, Header or Swather Mount Can be used for Turn Signal, Brake or Running Lights 4.125" Diameter Round Light Double Sided, Amber Lenses 25 Bulbs per Side For 12 Volt to 24 Volt Systems	AMX1910149	\$ 44.00	

Prices Subject to Change without Prior Notice. The use of original equipment manufacturer (OEM) part numbers or trademarks, e.g. Case® and John Deere®, are for reference purposes only and for indicating product use and compatibility. Our company and the listed replacement parts contained herein are not sponsored, approved or manufactured by the OEM. All parts are New unless designated Reman in the description.









Case IH®—Combine

Application	Description	Part Number	Retail Price	Core
 Universal Equipment	LED Warning Light Cab, Header or Swather Mount Can be used for Turn Signal, Brake or Running Lights 4.125" Diameter Round Light Double Sided, Red and Amber Lenses 25 Bulbs per Side For 12 Volt to 24 Volt Systems	AMTLFL3	\$ 55.00	
	LED Warning Light Cab, Header or Swather Mount Can be used for Turn Signal, Brake or Running Lights 4.125" Diameter Round Light Double Sided, Red and Amber Lenses 25 Bulbs per Side For 12 Volt to 24 Volt Systems	AMX33126	\$ 44.00	
 Universal Equipment	LED Magnetic Warning Light All-Position Light 360° Flashing Light, Multiple Patterns 9.50" x 6.75" Rectangle Light Magnetic Base or Solid Mount For 12 Volt to 24 Volt Systems Includes Cigarette Lighter Adapter, Wiring and Switch	AMTL1100	\$ 170.00	
 Universal Equipment	LED Magnetic Warning Light All-Position Light 360° Flashing Light, Multiple Patterns 14" x 6.75" Rectangle Light Magnetic Base or Solid Mount For 12 Volt to 24 Volt Systems Includes Cigarette Lighter Adapter, Wiring and Switch	AMTL1200	\$ 190.00	
Universal Equipment	Warning Beacon 360° Flashing Beacon, Amber Lens For 0.9435" Diameter Pipe Replaces 84337818, AZ44705, AZ101891	AM82018390	\$ 45.64	
 Universal Equipment	LED Warning Beacon 360° Flashing Beacon 2.75" x 5.25" Light Polycarbonate Amber Lens and Housing For 12 Volt to 24 Volt Systems Includes Solid Mounting Pad and Stainless Steel Hardware	AMTL2100	\$ 30.00	
 Universal Equipment	LED Warning Beacon 360° Flashing Beacon, 3 Different Patterns 5" x 10" Light Amber Lens, 48 Watts, 4 Amps For 12 Volt to 24 Volt Systems Brackets Sold Separately	AMX33131	\$ 75.00	
 Universal Equipment	Warning Beacon Bracket	AMX33132	\$ 15.00	
 Universal Equipment	Warning Beacon Bracket	AMX33133	\$ 15.00	
 Universal Equipment	Warning Beacon Bracket	AMX33137	\$ 15.00	

Case IH®—Combine

Application	Description	Part Number	Retail Price	Core	
	Universal Equipment	Warning Beacon Bracket	AMX33135	\$ 15.00	
	Universal Equipment	LED Light Bar 4" Long, 1260 Lumens, Cree Bulbs	AMLED4	\$ 45.00	
	LED Light Bar Flood/Spotlight Combo 10" Long, 5700 Lumens, 50 Watts, 4.20 Amps For 12 Volt to 24 Volt Systems Includes Mounting Bracket and Stainless Steel Hardware	AMTL10SRC	\$ 129.00		
	LED Light Bar Floodlight/Spotlight Combo 14" Long, 5400 Lumens, 72 Watts, 6 Amps Die Cast Aluminum Housing, Polycarbonate Lens For 12 Volt to 24 Volt Systems Includes Mounting Bracket and Heavy Duty Stainless Steel Hardware	AMTLB410C	\$ 150.00		
	LED Light Bar Floodlight/Spotlight Combo 30" Long, 13600 Lumens, 150 Watts, 12.50 Amps For 12 Volt to 24 Volt Systems Includes Mounting Bracket and Stainless Steel Hardware	AMTL30SRC	\$ 230.00		
	LED Light Bar 30" Long, 13860 Lumens, Cree Bulbs	AMLED30	\$ 130.00		
	LED Light Bar Floodlight/Spotlight Combo 40" Long, 17300 Lumens, 200 Watts, 16.70 Amps For 12 Volt to 24 Volt Systems Includes Mounting Brackets and Stainless Steel Hardware	AMTL40SRC	\$ 300.00		
	LED Light Bar 40" Long, 18200 Lumens, Cree Bulbs	AMLED40	\$ 160.00		
	LED Light Bar Floodlight/Spotlight Combo 42" Long, 14500 Lumens, 240 Watts, 19 Amps For 12 Volt to 24 Volt Systems Includes Mounting Bracket and Stainless Steel Hardware Replaces 1163691	AMTLB440C	\$ 250.00		
	LED Light Bar, Curved 50" Long, 21500 Lumens, Cree Bulbs	AMLED50C	\$ 190.00		
		Patriot Sprayers: 3230, 3240, 3330, 3340, SPX3320	LED Front Corner Light w/ Work Light, Right Hand Corner Light: Amber Lens, 17 Watts, 2.40 Amps, Built-in Resistor (12 Watts) Work Light: Floodlight, 3300 Lumens, 30 Watts, 3.30 Amps For 12 Volt to 24 Volt Systems Plug-and-Play for Direct Replacement Replaces 279220A1	AMTL6120R	\$ 120.00
			LED Front Corner Light w/ Work Light, Left Hand Corner Light: Amber Lens, 17 Watts, 2.40 Amps, Built-in Resistor (12 Watts) Work Light: Floodlight, 3300 Lumens, 30 Watts, 3.30 Amps For 12 Volt to 24 Volt Systems Plug-and-Play for Direct Replacement Replaces 279219A1	AMTL6120L	\$ 120.00

Case IH®—Combine

Application	Description	Part Number	Retail Price	Core
 Patriot Sprayers: 3230, 3240, 3330, 3340, SPX3320	LED Rear Corner Light, Left Hand Amber Lens, 17 Watts, 2.40 Amps Built-In Resistor, 12 Watts For 12 Volt to 24 Volt Systems Plug-and-Play for Direct Replacement	AM279224A1	\$ 60.00	
	LED Rear Corner Light, Right Hand Amber Lens, 17 Watts, 2.40 Amps Built-In Resistor, 12 Watts For 12 Volt to 24 Volt Systems Plug-and-Play for Direct Replacement	AM279223A1	\$ 60.00	
 2144, 2166, 2188, 2344, 2366, 2377, 2388, 2577, 2588, Cotton Pickers: 420, 2155, 2555, CPX420	LED Work Light 6" x 3.50" x 3" Rectangle Floodlight 3600 Lumens, 40 Watts, 3.30 Amps For 12 Volt to 24 Volt Systems Uses Original Mount and Wiring	AMTL3035	\$ 90.00	
 Universal Equipment	LED Magnetic Work Light All-Position Light 3.25" Square Floodlight 900 Lumens Magnetic Base Includes Lithium Ion Battery, Cigarette Lighter and DC Charger	AMTL2460	\$ 79.00	
 Universal Sprayers	LED Blue Work Light 4.25" x 4.50" x 3.00" Rectangle Light 2650 Lumens, 42 Watts, 3.50 Amps For 12 Volt to 24 Volt Systems Includes Stainless Steel Hardware and Mounting Bracket	AMTLFL5	\$ 59.00	
 7120, 7230, 7240, 8120, 8230, 8240, 9120, 9230, 9240	Light Switch, Work Light	AM87603462	\$ 39.00	
 5130, 5140, 6130, 6140, 7130, 7140, 7230, 7240, 8230, 8240, 9230, 9240	Hazard Switch	AM84370689	\$ 35.00	
 5130, 5140, 6130, 6140, 7130, 7140, 7230, 7240, 8230, 8240, 9230, 9240	Rotary Switch, 4-Position	AM177249A1	\$ 60.00	
 5130, 5140, 6130, 6140, 7130, 7140, 7230, 7240, 8230, 8240, 9230, 9240	Switch, Road Mode	AM84380254	\$ 40.00	

Cab Components—Miscellaneous



Application	Description	Part Number	Retail Price	Core
2366, 2377, 2388, 7010, 7120, 8010, 8120, 9010, 9120	Reman AFS Display Monitor Universal Display Plus Monitor (2) Data Card Ports located on Left Hand Side of Monitor and (2) Electrical Ports located on Bottom of Monitor	AM295133A3	\$ 1650.00	\$ 500.00
(2377, 2388 SN HAJ292001-HAJ300000)	Reman Monitor Replaces 293255A3, 295133A5, 87668610	AM84604338R	\$ 1650.00	\$ 500.00

Case IH®—Combine

Steering Arms



Application	Description	Part Number	Retail Price	Core
1420, 1440, 1460, 1620, 1640, 1644, 1660, 1666, 2144, 2166, 2344 BSN JJC0174359, 2366 BSN JJC0252949	Steering Arm Right Hand	AM193912C3	\$ 184.28	
	Steering Arm Left Hand	AM193911C4	\$ 227.69	
Cotton Harvester: 1800, Cotton Pickers: 420, 1822, 1844, 2022, 2055, 2155, 2555, CPX420	Steering Arm Right Hand 36 Tooth	AM1259527C2	\$ 102.11	
	Steering Arm Left Hand 36 Tooth	AM1259526C2	\$ 120.13	
Cotton Pickers: 1822, 2022	Steering Arm Right Hand 24 Tooth	AM148419C1	\$ 144.53	
	Steering Arm Left Hand 24 Tooth	AM148418C1	\$ 103.21	

Tie Rods and Components

Application	Description	Part Number	Retail Price	Core
815, 915, 1420, 1440, 1460, 1620, 1640, 1660	Tie Rod 3.75" Long 1.00"x16 UN Right Hand External Thread	AM379551R92	\$ 62.86	
 1440, 1460, 1640, 1644, 1660, 1666, 2144, 2166, 2344, 2366	Tie Rod 3.87" Long, 1" Diameter 16 Right Hand Thread	AM1302687C1	\$ 26.00	
 1440, 1460, 1640, 1644, 1660, 1666, 2144, 2166, 2344, 2366	Tie Rod, Left Hand 9 Holes 40" Long, 1.187" Diameter	AM1302686C1	\$ 104.00	
 1460 Rice, 1480, 1660, 1666, 1680, 1688, 2166, 2188, 2344, 2366, 2388	Tie Rod, Left Hand 9 Holes in Side 45.50" Long, 1.50" Diameter	AM359774A1	\$ 125.00	
 1620, 1640, 1644, 1660, 1666, 1680, 1688, 2144, 2166, 2188, 2344, 2366, 2388, 2588 - w/ Power Guide Axle	Tie Rod 4.87" Long, 1.125" Diameter 12 UNF Right Hand Thread	AM1968998C1	\$ 45.00	
 1640, 1644, 1660, 1666, 1680, 1688, 2144, 2166, 2188, 2344, 2366, 2377 SN HAJ292001-HAJ300000, 2388, 2577 ASN HAJ300001, 2588 ASN HAJ300001	Outer Tie Rod Tube	AM1970102C1	\$ 408.51	
 1680, 1688, 2188, 2366 BSN JJC025949, 2388 BSN JJC0276540 - 2WD	Tie Rod 4" Long, 1" Diameter Right Hand Thread	AMA43376	\$ 22.00	
 2344, 2366, 2377, 2388	Tie Rod 5.50" Long, 1.125" Diameter 12 Right Hand Thread	AM86984112	\$ 55.00	
 2344, 2366, 2377, 2388	Ball Joint	AM437222A1	\$ 90.00	
 2366, 2377 SN HAJ292001-HAJ300000, 2388 ASN JJC076540, 2577, 2588	Tie Rod 33.75" Long, 1.50" Diameter	AM86984111	\$ 181.77	
2377 SN HAJ292001-HAJ300000, 2388	Inner Tie Rod Tube 15 Holes 33.00" Long, 1 1/8" Diameter 12 Right Hand Thread Replaces 361408A1	AM87012417	\$ 218.05	
 7010, 7120, 7230, 7240, 8010, 8120, 8230, 8240, 9120, 9230, 9240, AFX8010	Tie Rod 4.75" Long M30x1.50" Right Hand Thread Replaces 84073399	AM84442906	\$ 47.00	

Prices Subject to Change without Prior Notice. The use of original equipment manufacturer (OEM) part numbers or trademarks, e.g. Case® and John Deere®, are for reference purposes only and for indicating product use and compatibility. Our company and the listed replacement parts contained herein are not sponsored, approved or manufactured by the OEM. All parts are New unless designated Reman in the description.

Case IH®—Combine

Application	Description	Part Number	Retail Price	Core
7010, 7120, 7230, 7240, 8010, 8120, 8230, 8240, 9010, 9120, 9230, 9240, AFX8010	Tie Rod Tube, Right Hand	AM84074074	\$ 310.00	
 Cotton Pickers: 420 09/2006-10, 420 03/2008 and Later Tier 3, 1844 ASN JJC0002461 07/1989-93, 1844 1988-93 w/ Navistar® Engine, (2022, 2044 - 1991-94), 2055 1997-2005, 2155 02/1995-96, CPX420 05/2005-08/06	Tie Rod Tube 17.06" Long	AM1280657C1	\$ 30.00	
 Cotton Pickers: 1844 ASN JJC0002461, 1844 w/ Navistar® Engine, 2022, 2044, 2055, 2155, 2555	Tie Rod 4.10" Long, 1.125" Diameter 12 Right Hand Thread	AM1280658C1	\$ 26.00	
 Cotton Pickers: 1844 ASN JJC0002461, 1844 w/ Navistar® Engine, 2022, 2044, 2055, 2155, 2555	Tie Rod 7 Holes, 15.275" Long, 1.185" Diameter	AM1280662C1	\$ 35.00	



Power Steering Cylinders and Components



Application	Description	Part Number	Retail Price	Core
815, 915, 1420, 1440, 1460, 1480, 1620, 1640, 1644, 1660, 1666, 1670, 2144, 2166, 2344, 2366, Cotton Picker: 95 - All w/o Power Guide Axle	Power Steering Cylinder 2" ID, 9 Stroke Replaces 157422C91	AM548247R91	\$ 495.00	
1420, 1460, 1480, 1620 ASN JJC0032630, 1640, 1644, 1660, 1666, 1680 BSN JJC0045689, 2144, 2166, 2344, 2366, 2377 ASN HAJ292001, 2388, 2588 ASN HAJ30001 - w/ Power Guide Axle	Power Steering Cylinder 2.25" ID, 9 Stroke Replaces 127913C91	AM87337229	\$ 265.00	
5088, 5130, 5140, 6088, 6130, 6140, 7088, 7130, 7140 - w/ Standard Steering	Power Steering Cylinder Replaces 87519431	AM87674051	\$ 697.00	
6130, 6140 - w/ Auto-Guide Steering	Power Steering Cylinder	AM84385653	\$ 2300.00	
7230, 7240, 8230, 8240, 9230, 9240	Power Steering Cylinder 36 mm Rod Diameter, 330 mm Stroke Replaces 84448270, 87387458, 717582006	AM84370626	\$ 1400.00	
1420, 1440, 1460, 1620, 1640, 1660, 2144, 2166, 2344, 2366	Power Steering Cylinder End 2.75" Long M22x1.50" Right Hand Thread	AM186796C1	\$ 50.00	
(1420, 1460, 1480, 1620, 1640, 1644, 1660, 1666, 1680, 1688, 2144, 2166, 2188, 2344, 2366, 2388 BSN JJC00272999 - w/ Power Guide Axle), (1680, 1688, 2188, 2344 SN JJC0174400-JJC017449, 2366 SN JJC0254000-JJC02549999, 2388 BSN JJC0270499 - w/ Adjustable Axle)	Power Steering Cylinder End	AM186140C91	\$ 41.00	
7010, 7120, 7230, 7240, 8010, 8120, 8230, 8240, 9120, 9230, 9240, AFX8010	Power Steering Cylinder End 3.75" Long M16x1.50" Right Hand Thread Replaces 84073454	AM84814042	\$ 55.00	
1460, 1480, 1660, 1666, 1680, 1688, 2166, 2188, 2344 ASN JJC0174360 w/o Power Guide Axle, 2366 ASN JJC0252949, 2377 ASN HAJ0292001, 2388 BSN JJC0270500 & ASN HAJ0292001, 2577	Power Steering Cylinder Support Replaces 133319A1	AM316945A1	\$ 210.81	
2377 SN HAJ292001-HAJ300000, 2388 BSN JJC0276540	Power Steering Cylinder Mount, Right Hand	AM412304A1	\$ 115.31	
7010, 7120, 7230, 7240, 8010, 8120, 8230, 8240, 9010, 9120, 9230, 9240, AFX8010	Power Steering Cylinder Seal Kit For Auto-Guidance Enabled Steering Cylinder	AM84455606	\$ 110.00	

Case IH®—Combine

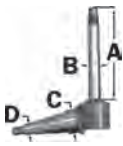
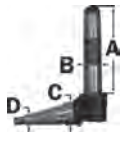
Spindles

Application	Description	Part Number	Retail Price	Core
 1420, 1440, 1460, 1620*, 1640, 1644, 1660, 1666, 2144, 2166, 2344 BSN JJC0174360, 2366 BSN JJC00252949 - w/o Power Guide Axle *w/ 11x16, 12.40x16 or 11.20x24 Tires	Spindle, Right or Left Hand Replaces 1315374C1, 1315374C91 A - 12.50 B - 1.671 C - 2.6245 D - 1.6875	AM1315374C2	\$ 595.57	
 Cotton Pickers: 420, CPX420	Spindle Replaces 1259519C2, 1259519C92, 86503132, 87773201 A - 12.00 B - 2.499 C - 2.624 D - 1.687	AM1259519C3	\$ 478.17	
1420, 1480, 1660, 1666, 1680, 1688, 2166, 2188, 2344 ASN JJC0174360, 2366 ASN JJC0252950, 2377 ASN HAJ0292001, 2388	Steering Knuckle King Pin 20" Long	AM186052C1	\$ 100.00	
 1460, 1480, 1660, 1666, 1680, 2166, 2188, 2344, 2366, (2377, 2388 SN HAJ292001-HAJ300000), 2577, 2588	Spindle Bushing	AM186680C1	\$ 20.00	
 Cotton Pickers: 1800, 1844, 2022, 2044, 2055, 2155, 2555, CPX420 - w/ Adjustable Axle w/o Guide Power	Spindle Bushing	AM1259518C1	\$ 36.23	



Wheel Hubs

Application	Description	Part Number	Retail Price	Core
(2377, 2388 SN HAJ292001-HAJ300000), 2577, 2588	Rear Axle Hub Assembly, HD Replaces 427351A1	AM87307670	\$ 265.13	
815, 915, Cotton Pickers: 782, 1822, 1844, 2022, 2044	Wheel Hub, 8-Bolt	AM391824R11	\$ 90.00	
1620, 1640, 1644, 1660, 1666, 2144, 2166, 2344, 2366, Cotton Harvester: 1800, Cotton Pickers: 420, 1844, 2022, 2044, 2055, 2155, CPX420	Wheel Hub, 8-Bolt	AM1259528C1	\$ 332.50	
(2377, 2388 SN HAJ292001-HAJ300000), 2577, 2588 - w/ 92"-120" Adjustable Axle	Wheel Hub, 8-Bolt	AM87307671	\$ 190.65	



Axle Center Tubes

Application	Description	Part Number	Retail Price	Core
Rotary Combines w/ Heavy Duty Axle	Axle Center Tube 56" Long, 4.50" Between Holes For 92"-122" Rear Axle	AMIHCCT45	\$ 1650.00	
	Axle Center Tube 56" Long, 5" Between Holes For 92"-122" Rear Axle	AMIHCCT50	\$ 1650.00	
1640, 1644, 1660, 1666, 1680, 1688, 2144, 2166, 2188, 2344, 2366, 2388 w/ Single Steering Cylinder	Axle Center Tube 63.50" Long, 3.25" Space Back For 108"-144" Rear Axle	AM1968991C1	\$ 1550.00	

Case IH®—Combine

Application	Description	Part Number	Retail Price	Core
1440, 1460, 1480, 1640, 1644, 1660, 1666, 1680, 1688, 2144, 2166, 2188, 2344, 2366, 2377, 2388	Axle Pivot w/ Bushings	AM186599C94	\$ 375.00	
815 ASN 8001, 915 ASN 8001, 1420, 1440, 1460, 1470, 1480, 1620, 1640, 1644, 1660, 1666, 1670, 1680, 1688, 2144, 2166, 2188, 2344, 2366, 2377 SN HAJ292001-HAJ300000, 2388 BSN JJC0276540, 2577, 2588, Cotton Pickers: 782, 1822, 1844, 2022, 2044, 2055	Bushing, Axle Pivot 1.47" Wide, 4.01" ID, 4.195" OD	AM177751C1	\$ 19.00	
1440, 1460, 1480, 1640, 1644, 1660, 1666, 1680, 1688, 2144, 2166, 2188, 2344, 2366, 2377, 2388, 2577, 2588	Bushing, Rear Axle Pivot 0.736" Wide, 4" ID, 4.178" OD	AM182794C1	\$ 26.25	
(1420, 1440, 1460, 1480, 1640 BSN JJC0034001, 1660 BSN JJC0036301, 1680 BSN JJC0044001 - w/ Power Guide Rear Axle)	Thrust Washer	AM890477C1	\$ 12.00	
Cotton Pickers: 1822, 2022	Pivot Pin Bushing, Rear 1.06" Long, 1.256" ID, 1.377" OD	AM482669R1	\$ 22.10	

Weight Brackets



Application	Description	Part Number	Retail Price	Core
1640, 1644, 1660, 1680, 2144, 2166, 2188, 2344 BSN JJC0174398, 2388 BSN JJC0290499	Weight Bracket Replaces 185365C1, 185365C3	AM193440A3	\$ 445.00	
2377, 2388, 2577, 2588	Weight Bracket	AM431785A1	\$ 365.00	





Steps

Application	Description	Part Number	Retail Price	Core
2144, 2166, 2188, 2344, 2366 BSN 0256605, 2388 BSN 0275338	Steel Step Replaces all steps on combine applications	AM97050C3	\$ 60.00	
Cotton Pickers: 2555 ASN JJC0249500, CPX420, CPX610	Step	AM257375A1	\$ 40.00	
2344, 2366, 2377, 2388, 2577, 2588	Bottom Step Support, Rubber Hardware not included	AM87301176	\$ 27.50	

Glass

Application	Description	Part Number	Retail Price	Core
 2144, 2166, 2188, 2344, 2366, 2377, 2388, 2577, 2588, 5088, 6088, 7088, Cotton Pickers: 420, 620, 625, 2555, CPX420, CPX610	Windshield Replaces 116809A3, 116809A4	AM116809A2	\$ 774.40	
Patriot Sprayers: 3230, 3240, 3330, 3340, SPX3320	Cab Glass, Right Hand Replaces 242536A5, 87773671	AM87417671	\$ 595.00	
 Patriot® Sprayers: 3230, 3240, 3330, SPX3320	Rear Glass Tinted Replaces 242667A4	AM87309738	\$ 315.00	
 Swathers: 8860, 8860HP, 8870, 8880, 8880HP	Weatherstrip 176" Long For Front Cab Windshield	AM1990761C2	\$ 29.63	

Case IH®—Combine

	Application	Description	Part Number	Retail Price	Core
	2144, 2166, 2188, Cotton Pickers: 2155, 2555	Weatherstrip 176" Long For Cab Door, Right and Left Hand	AM1990761C2	\$ 29.63	
	Sprayer: 3320 11/2006-12/08	Weatherstrip For Cab Door	AM87534532	\$ 23.10	
	Sprayers: 3320 2009 and Later, 3330	Weatherstrip For Cab Door	AM84160023	\$ 23.10	
	Sprayer: 3320 11/2006-12/08	Weatherstrip For Rear Cab Window	AM87534532	\$ 23.10	









Gas Struts



Application	Description	Part Number	Retail Price	Core
2366, 2377, 2388, 2577, 2588, 5088, 6088, 7088	Gas Strut, Engine Cover	AM446346A1	\$ 35.00	
7010, 7120, 7230, 8010, 8120, 8230, 9120, 9230	Gas Strut, Bumper	AM84334242	\$ 20.00	
2144, 2166, 2188, 2344, 2366, 2377, 2388, 2577, 2588, 5088, 5130, 6088, 6130, 7088, 7130, Cotton Pickers: 420, 620, 625, 2555, CPX420, CPX610, CPX620	Gas Strut, Steering Column	AM224357A1	\$ 35.00	
1620, 1640, 1644, 1660, 1666, 1670, 1688, Cotton Pickers: 1800, 1822, 1844, 2055	Gas Strut, Door	AM1280157C1	\$ 20.00	
2144, 2166, 2188, 2344, 2366, 2377, 2388, 2577, 2588, 5088, 5130, 6088, 6130, 7088, 7130, Cotton Pickers: 420, 620, 625, 2555, CPX420, CPX610, CPX620	Gas Strut, Door Right and Left Hand	AM144006A1	\$ 35.00	
5130, 5140, 6130, 6140, 7010, 7120, 7130, 7140, 7230, 7240, 8010, 8120, 8230, 8240, 9120, 9230, 9240, AFX8010, Swathers: WD1203, WD1903, WD2303, WDX1202, WDX1902, WDX2302	Gas Strut, Door Right and Left Hand	AM84320293	\$ 19.00	
2144, 2166, 2188, 2344, 2366, 2377, 2388, 2577, 2588	Gas Strut, Rear Panel	AM140311A3	\$ 19.00	
7010, 8010, AFX8010	Gas Strut, Upper Panel	AM87108531	\$ 32.00	
2344, 2366, 2388 BSN JJCO276540	Gas Strut, Rotary Air Screen Chute Replaces 229626A1	AM87025781	\$ 30.00	
Cornheads: Models w/ Tall Corn Attachment	Gas Strut, Tall Corn Kit Replaces 229626A1	AM87025781	\$ 30.00	
2388, 2588	Door Cylinder Kit, Right Hand	AMSS3319	\$ 86.00	
	Door Cylinder Kit, Left Hand	AMSS3320	\$ 86.00	
Cotton Pickers: 420 Express, 2555, CPX420, Titan Floaters: 3020, 3520, 4020, 4520, Floaters: FLX3010, FLX3510, FLX4010, FLX4510, Patriot Sprayers: 3320, 4420, Sprayers: SPX4260, SPX4410	Stud, Door Gas Strut Replaces 142597A1	AM3234063R1	\$ 7.00	

Case IH®—Combine

Air Conditioning and Components

Application	Description	Part Number	Retail Price
 615, 715, 815, 915, 1440, 1480, 1640, 1660 BSN JJC0038345, 1680	Compressor Conversion Kit York Style to Sanden Style Includes Compressor, Mounting Bracket, Compressor Manifold, O-Rings and Mounting Hardware Requires AMX10202 Service Valve Kit to Replace Original Service Valves Requires Pag Oil 100V, 6.76 oz (200 cc)	AMX10165	\$ 395.00
	Service Valve Kit R134a Tube O-Ring to O-Ring or Flare Fitting Insert Flare Adapters for Flare Applications	AMX10202	\$ 35.00
	Ultra Pag Double End Capped, 100V, 8 oz	AMX10267	\$ 12.00
	Universal Pag Oil, 8 oz	AMX10274	\$ 8.25
 615, 715, 815, 915, Swathers: 4000, 5000, 5500 Replaces 417888C92	Compressor, York Style Left Hand Suction, Rotolock Clutch Not Included Requires Synthetic Ester Oil 100V, See Manufacturer for Oil Quantity	AMX10225	\$ 260.00
	Double Groove Clutch for York Compressor, 7"	AM470	\$ 101.00
	Premium Synthetic Ester Oil, 100V, 12 oz	AMX10273	\$ 11.00
 1440, 1460, 1480	Compressor, York Style Right Hand Suction, Rotolock Clutch Not Included Requires Synthetic Ester Oil 100V, 9.50 oz (281 cc)	AM54-032	\$ 225.00
	Double Groove Clutch for York Compressor, 7"	AM470	\$ 101.00
	Premium Synthetic Ester Oil, 100V, 12 oz	AMX10273	\$ 11.00
 1620 BSN JJC0032630, 1640 BSN JJC0038345, 1670 BSN JJC0080539, Cotton Pickers: (1822 BSN JJC0012691, 1844 BSN JJC0002462 - w/ Navistar® Engine) Replaces 1255750C91, 1924008C1, 1924008C2	Compressor, York Style Right Hand Suction, O-Ring Fitting, Clutch Not Included Requires Synthetic Ester Oil 100V, 9.50 oz (281 cc)	AMX10177	\$ 225.00
	Double Groove Clutch for York Compressor, 7"	AM470	\$ 101.00
	Premium Synthetic Ester Oil, 100V, 12 oz	AMX10273	\$ 11.00
 1620* ASN JJC0032630, 1640* ASN JJC0034705, 1644*, 1660*, 1666*, 1680* ASN JJC0045689, 1688*, 2144, 2166, 2188, 2344, 2366, 2388, 2588, Cotton Pickers: 2022, 2044, 2155, 2555, Swathers: 8820* ASN CFH0049253, 8825, 8825HP, 8830 ASN CFH0028999, 8840 ASN CFH0086315, 8850, 8860, 8860HP *Optional R134a Compressor Replaces 1999755C2, 1999755C3, 86993462, 1977959C1	Compressor, Sanden SD7H15 12 Volt, w/ 2-Groove Clutch, 6" Clutch Diameter, Horizontal Tube O-Ring Requires Synthetic Ester Oil 100V, 9.60 oz (285 cc)	AMX10125	\$ 240.00
	Premium Synthetic Ester Oil, 100V, 12 oz	AMX10273	\$ 11.00
 7010, 7120, 8010, 8120, 9120, AFX8010 Replaces 504078610, 317008A3, 86992688, 317008A2, 87775469	Compressor, Sanden SD7H15HD 12 Volt, w/ 8-Groove Clutch, 5.98" (152 mm) Clutch Diameter, Horizontal Tube O-Ring, Direct Mount Requires Pag Oil 100V, 9.64 oz (285 cc)	AM86993463	\$ 275.00
	Ultra Pag Double End Capped, 100V, 8 oz	AMX10267	\$ 12.00
	Universal Pag Oil, 8 oz	AMX10274	\$ 8.25
 6140, 7140, 7240, 8240, 9240	Compressor w/ Clutch Replaces 5801558535	AM84279787	\$ 395.00
 Swathers: 6000, 6500 Replaces 1336431C1, 60-2921T94	Compressor, Sanden SD508 Style 12 Volt, w/ 2-Groove Clutch, 5.19" (132 mm) Clutch Diameter, Vertical #8 and #10 Flare Fittings, w/ R12 Charge Ports Requires R12 Mineral Oil, 5.91 oz (175 cc)	AMX10178	\$ 255.00

Case IH®—Combine













Application	Description	Part Number	Retail Price
 Swathers: 6000, 6500, 8820 SN CFH0049001-49252, 8830 SN CFH0028001-28804, 8840 SN CFH0031001-86000	Compressor, Sanden Style 12 Volt, w/ 2-Groove Clutch, 6" (152 mm) Clutch Diameter, Vertical #8 and #10 Flare Connections, w/ R12 Charge Ports Requires R12 Mineral Oil, 5.91 oz (175 cc)	AMX10134	\$ 265.00
 2144, 2166, 2188, 2344, 2366, 2377, 2388, 5130, 5140, 6130, Cotton Pickers: 2022, 2044, 2155, 2555, CPX420, CPX610, CPX620 Replaces 135324A1, 47108807, 47110444, 700713455	Compressor Clutch SD7H15 Clutch w/ 12 Volt Coil, 2-Groove, 5.98" Clutch Diameter, 0.47" Groove Width Use w/ AMX10125 Compressor	AM135324A2	\$ 120.00
 6130, 7010, 7120, 7130, 8010, 8120, 9010, 9120, AFX8010	Compressor Clutch SD7H15 Clutch w/ 12 Volt Coil, 8-Groove, 5.98" (152 mm) Clutch Diameter, Key-Type Hub Replaces 8775538	AM403585A1	\$ 132.00
 Patriot Sprayer: SPX2130 Replaces BN67727	High Pressure Switch Normally Closed, Opens at 375 PSI, Closes at 225 PSI 7/16"x20 Thread	AM539069R2	\$ 34.00
 5088, 5130, 5140, 6088, 6130, 6140, 7088, 7130, 7140, 7230, 7240, 8230, 8240, 9230, 9240	Low Pressure Switch Normally Open, Opens at 20 PSI, Closes at 7 PSI, 10 mm Metric Thread	AM84419250	\$ 65.20
 Universal Equipment	High Pressure Switch Normally Open, Opens at 305 PSI, Closes at 395 PSI, 7/16"x20 Thread	AMX10276	\$ 35.00
 Universal Equipment	Low Pressure Switch Normally Open, Opens at 6 PSI, Closes at 45 PSI, Standard 7/16"x20 Thread	AMX10277	\$ 55.00
 Universal Equipment	Low Pressure Switch Normally Open, Opens at 35 PSI, Closes at 46 PSI, Standard 7/16"x20 Thread	AMX10278	\$ 42.00
 525, 527 Replaces 060506138	Receiver Drier 3" x 10 1/2" Male O-Ring, R12 and R134a Compatible	AMX10218	\$ 26.00
 1420, (1440, 1460 ASN 12001), 1470 ASN 1180, 1480 ASN 1400, Cotton Picker: 782, 1400	Receiver Drier 4" x 6 3/4", Inlet - #6, 3/8" Female O-Ring, Outlet - #6, 3/8" Male O-Ring, R12 and R134a Compatible Replaces 118304C2	AMX10162	\$ 32.00
 1440, 1460, 1470, 1480, Swathers: 6450, 6455, 6550, 6555, 6650, 6655	Receiver Drier Replaces 111218C1	AMX10172	\$ 30.00
 1620, 1640, 1644, 1660, 1666, 1670, 1680, 1688, 2144, 2166, 2188, 2344, 2366, 2377, 2388, 2577, 2588, 5088, 6088, 7088, Cotton Harvester: 1800, Cotton Pickers: 1822, 1844, 2022, 2044, 2055, 2155, 2555, CPX420, CPX610, CPX620 Replaces 143469C2, 1990758C2	Receiver Drier 4" x 7 3/4", Inlet - #6, 3/8" Male O-Ring, Outlet - #6, 3/8" Female O-Ring, Front Mount, R12 and R134a Compatible	AMX10161	\$ 30.00
 7010, 7120, 7230, 8010, 8120, 8230, 9120, 9230, AFX8010 Replaces 295006A1	Receiver Drier Receiver Drier, Import 4" x 7 1/2", Inlet - #6 Female O-Ring, Outlet - #6 Male O-Ring, R12 and R134a Compatible	AMX10154 AMX10208	\$ 25.00 \$ 22.00

Prices Subject to Change without Prior Notice. The use of original equipment manufacturer (OEM) part numbers or trademarks, e.g. Case® and John Deere®, are for reference purposes only and for indicating product use and compatibility. Our company and the listed replacement parts contained herein are not sponsored, approved or manufactured by the OEM. All parts are New unless designated Reman in the description.



Case IH®—Combine

	Application	Description	Part Number	Retail Price
	615, 715, 815, 915 Replaces 244562R91, 168903C1	Expansion Valve Internally Regulated w/ 12" Capacity Tube w/ Flare Connection, R12 and R134a Compatible	AMX10215	\$ 30.00
	715 ASN 23001, 815, 915, 1440 BSN 10000, 1460 BSN 12000, 1470 BSN 1179, 1480 BSN 14000, Swathers: 6000, 6500, 8820 SN CFH0049001-CFH0049252, 8830 SN CFH0028001-CFH0028805, 8840 SN CFH0031001-CFH0086000	Expansion Valve Bulb Type, R12 and R134a Compatible, 19" Tube Length, Flare Connection	AMX10146	\$ 20.00
	782, 1400, 1420, 1440 ASN 10001, 1460 ASN 12001, 1470 ASN 1180, 1480 ASN 14001, Swathers: 4000 ASN 1983, 5000 ASN 10001, 5500 ASN 601, 8820 ASN CFH0049253, 8825, 8830 ASN CFH0028031, 8840 ASN CFH0086001, 8850 Replaces 128033C1	Expansion Valve Bulb Type, Externally Equalized, R12 and R134a Compatible, 14" Tube Length, O-Ring Connection	AMX10145	\$ 20.00
	(1620, 1640, 1660, 1670, 1680 BSN JJC0032629) Replaces 118321C1, 4322165	Expansion Valve Block Type, R12 and R134a Compatible, O-Ring Connection	AMX10151	\$ 24.00
	(1620, 1640, 1660, 1670, 1680 ASN JJC0032630), 1644, 1666, 1688, 1800, 1822, 1844, 2022, 2055, 2144, 2155, 2166, 2188, 2344, 2366, 2377, 2388, 2577, 2588, 5088, 5130, 6088, 6130, 7010, 7088, 7130, 8010, AFX8010, Cotton Pickers: 420, 620, 625, 1800, 1822, 1844, 2022, 2044, 2055, 2144, 2155, 2555, CPX420, CPX610, CPX620, Sprayers: 3320, 4420, Swathers: WD1203, WD1903, WD2303, WDX1202, WDX1902, WDX2302, WPX1202, WPX1902, WPX2302 Replaces 386535A1, 1990756C2	Expansion Valve Block Type, R12 and R134a Compatible, O-Ring Connection	AMX10150	\$ 26.00
	5130, 5140, 6130, 6140, 7120, 7130, 7140, 7230, 7240, 8120, 8230, 8240, 9120, 9230, 9240	Expansion Valve Flange Type, O-Ring Connection	AM82023542	\$ 45.00
	615, 715, 815, 915, 1420, 1440, 1460, 1470, 1480, 1620, 1640, 1660, 1670, 1680	Adapter Kit Rotolock to O-Ring or Flare Service Valve	AMX10204	\$ 32.00
	1440	Service Valve Kit R134a Tube O-Ring to O-Ring or Flare Fitting Insert Flare Adapters for Flare Applications	AMX10202	\$ 35.00
	2144, 2166, 2188, 2344, 2366, 2388, Cotton Pickers: 2155, 2555, CPX420, CPX610 Replaces 1977564C2, 355190A1	Blower Motor Assembly w/o Resistor 12 Volt, Includes Wiring Harness	AMX10121	\$ 180.00
	2344, 2366 ASN JJC025950, 2377, 2388 ASN JJC0267150, 2577, 2588, 5088, 6088, 7088, Cotton Pickers: 420, 620, CPX420, CPX620	Blower Motor Assembly 12 Volt, Resistor Not Included Replaces 323610A1	AM84222524	\$ 150.00
	2388, 7010, 7120, 7230, 8010, 8120, 8230, 9010, 9120, 9130, 9230, AFX8010, Patriot Sprayers: 3240, 3340, 4430	Blower Motor Assembly 12 Volt Replaces 87663947, 87663956	AM87663955	\$ 155.00
	7010, 7120, 8010, 8120, 9120, AFX8010, Swathers: WPX1202, WPX1902, WPX2302	Blower Motor Assembly Replaces 330137A1	AM87107380	\$ 125.00

Case IH®—Combine

Application	Description	Part Number	Retail Price
 1400, 1420, 1440, 1460, 1480, 1620, 1640, 1660, 1666, 1680, 1688, Cotton Harvester: 1800, Cotton Pickers: 1822, 1844, 2022, 2055 Replaces 190333A1	Blower Motor, Vented Single Speed, Double Shaft, 2-Wire, Reversible, 3/8" Shaft Diameter, 4 3/8" Long	AMX10118	\$ 108.00
 1400, 1420, 1440, 1460, 1470, 1480, 1620, 1640, 1644, 1660, 1666, 1670, 1680, 1688, Cotton Pickers: 1822, 1844, 2022, 2044, 2055	Blower Motor Kit, HD 12 Volt Dual Motor Assembly, 3-Speed 22 7/16" x 5 5/8" Mounting Base	AM1255878C92	\$ 245.00
 715, 815, 915, 1400, 1420, 1440, 1460, 1480, 1620, 1640, 1660, 1670, 1680	Blower Motor Switch 3-Speed Replaces 168822C1, 168822C2, AH84588	AMX10261	\$ 16.00
 615, 715, 815, 915, 1420, 1440, 1460, 1470, 1480, 1620, 1640, 1660, 1670, 1680 BSN JJ0045689, Cotton Harvester: 1400, 1800, Cotton Pickers: 782, 1822 ASN 12691, 1844 ASN 2462, 2022, 2044, Swathers: 1270, 1370, 1570, 2470, 2670 Prior to Cab SN 7864002, 4000, 5000, 5500	Condenser Core: 19 7/8" x 14" x 2" Replaces 165130C91	AM183901C2	\$ 350.00
 1660 ASN JJC0038346, 2144, 2166, 2188, 2344, 2366, Cotton Pickers: 2155, 2555	Condenser Overall: 29" x 10" Core: 26" x 10" x 2 3/8"	AM84581C2	\$ 455.00
 2377 SN 292001-295000, 2388 BSN 273000 - w/ Fuel Cooler	Condenser Core: 29 1/2" x 15 3/4" x 3"	AM275094A4	\$ 664.00
 2377 ASN 295001, 2388 ASN 273000, 2577, 2588	Condenser w/ Fuel Cooler Core: 35" x 17" x 3" Replaces 444922A1, 444922A2	AM444922A3	\$ 1265.00
 5088, 5130, 5140, 6130, 6140, 7130, 7140	Condenser	AM87559914	\$ 715.00
8120, 8230, 9120, 9230	Condenser w/ Oil Cooler Replaces 84576582	AM47475783	\$ 1145.00
 AFX8010	Condenser Core: 42" x 24" x 1 3/4" Replaces 86976448	AM87106641	\$ 240.00
 Swathers: WD1903, WD2303	Condenser w/ Oil Cooler Core: 30 7/8" x 31" x 3.80" Replaces 87340522	AM87490300	\$ 1070.00
 5130, 5140, 6130, 6140, 7130, 7140	Dual Oil Cooler	AM84349665	\$ 1589.00
 5088, 6088, 7088	Oil Cooler	AM87559913	\$ 1900.00
Swathers: WD1203, WD1903, WD2303	Charge Air Cooler	AM87340510	\$ 1325.00
Swathers: WD1203, WD1903, WD2303	Charge Air Cooler Core: 33.00" x 14.30" x 3" Replaces 87039232	AM87340512	\$ 950.00
 1420, 1440, 1460, 1470, 1480, Cotton Harvester: 1400, Cotton Picker: 782	Evaporator, Early Bulb Type Valve Overall: 32 1/2" x 5" x 6" Core: 25" x 3 1/2" x 6" Replaces 111468C2	AM118315C1	\$ 250.00

Case IH®—Combine

Application	Description	Part Number	Retail Price
 1644, 1660, 1666, 1680 BSN 45689, 1688, Cotton Harvester: 1800, Cotton Picker: 1822, 1844, 2022, 2044, 2055	Evaporator w/ Heater Core, Late Block Type Valve, O-Ring Fitting Includes Expansion Valve Core: 25" x 5" x 6"	AM1974632C3	\$ 345.00
 2144, 2166, 2188, 2344, 2366, 2388 BSN JJC0267149, Cotton Pickers: 2155, 2555, CPX610	Evaporator Block Type, O-Ring Connection Overall: 22 1/2" x 10" x 8" Core: 17 1/2" x 3 3/4" x 8" Replaces 121590A2, 121591A2	AM121590A3	\$ 365.00
 2344, 2366, 2377, 2388 ASN JJC02267150, 2577, 5130, 6088, 6130, 7088, 7130, Cotton Pickers: CPX420, CPX620	Evaporator Block Type, O-Ring Connection Overall: 23" x 10" x 8" Core: 17 1/2" x 3 3/4" x 8"	AM377560A1	\$ 365.00





Cornhead—Complete Polytin Heads

Mounting hardware is included with kits. Individual replacement parts available.













Applications	Description	Part Number	Retail Price	Core
900, 1000 Series	4 Row - 30" Complete Assembly	AMPTIH430	\$ 2720.00	
	6 Row - 30" Complete Assembly	AMPTIH630	\$ 3875.00	
	8 Row - 30" Complete Assembly	AMPTIH830	\$ 5030.00	
	12 Row - 30" Complete Assembly	AMPTIH1230	\$ 7333.00	
900, 1000 Series	4 Row - 36" Complete Assembly	AMPTIH436	\$ 2980.00	
	6 Row - 36" Complete Assembly	AMPTIH636	\$ 4110.00	
	8 Row - 36" Complete Assembly	AMPTIH836	\$ 5335.00	
	12 Row - 36" Complete Assembly	AMPTIH1236	\$ 7795.00	

Cornhead—Fenders and Snouts











Application	Description	Part Number	Retail Price	Core
 823, 824, 833, 834, 843, 844, 853, 854, 863, 864, 873, 883, 943, 944, 954, 963, 964, 983, 984, 1043, 1044, 1054, 1063, 1064, 1083, 1084	Outer Fender, Poly	Right Hand Left Hand	AM176192C3P AM176191C3P	\$ 370.00 \$ 370.00
	 823, 824, 833, 834, 843, 844, 853, 854, 863, 864, 873, 883	Outer Fender, Steel	Right Hand Left Hand	AM176192C3 AM176191C3
 943, 944, 954, 963, 964, 983, 984, 1043, 1044, 1054, 1063, 1064, 1083, 1084		Outer Fender, Steel	Right Hand Left Hand	AM199504C2 AM199503C2
	 2206, 2208, 2212, 3206, 3208, 3212	Outer Fender	Right Hand	AM87571725
 2406, 2408, 2412, 3406, 3408, 3412, 3416, 3418		Outer Fender	Left Hand	AM87571755
		Replaces 86635993		

Case IH®—Combine



	Application	Description		Part Number	Retail Price	Core
	823, 824, 833, 834, 843, 844, 853, 854, 863, 864, 873, 883, 943, 944, 954, 963, 964, 983, 984, 1043, 1044, 1054, 1063, 1064, 1083, 1084	Outer Snout w/ Point, Poly	Right Hand	AM320085A1P	\$ 210.00	
			Left Hand	AM320084A1P	\$ 200.00	
	823, 824, 833, 834, 843, 844, 853, 854, 863, 864, 873, 883, 943, 944, 954, 963, 964, 983, 984, 1043, 1044, 1054, 1063, 1064, 1083, 1084	Outer Snout w/ Point, Steel	Right Hand	AM176234C93	\$ 280.00	
			Left Hand	AM176233C93	\$ 280.00	
	2406, 2408, 2412, 3206, 3208, 3212, 3406, 3408, 3412, 3416, 3418	Outer Snout w/o Point - 30" Replaces 86620222		AM86980205	\$ 305.00	
	823, 824, 833, 834, 843, 844, 853, 854, 863, 864, 873, 883	Center Divider, Poly - 28" or 30"	Right and Left Hand	AMX27106	\$ 390.00	
		Center Divider, Poly - 36"	Right and Left Hand	AMX27108	\$ 425.00	
		Center Divider, Steel - 28" or 30" Replaces 176181C2	Right Hand	AM1345371C1	\$ 260.00	
		Center Divider, Steel - 28" or 30" Replaces 176180C2	Left Hand	AM1345370C1	\$ 260.00	
		Center Divider, Steel - 36", 38", 40"	Right Hand	AM176164C2	\$ 260.00	
			Left Hand	AM176163C2	\$ 260.00	
	943, 944, 954, 963, 964, 983, 984, 1043, 1044, 1054, 1063, 1064, 1083, 1084	Center Divider, Poly - 30"		AM1345363C1P	\$ 360.00	
	943, 944, 954, 963, 964, 983, 984, 1043, 1044, 1054, 1063, 1064, 1083, 1084	Center Divider, Steel - 30"		AM1345363C1	\$ 595.00	
		Center Divider, Poly - 36"	Right and Left Hand	AMX27107	\$ 380.00	
	943, 944, 954, 963, 964, 983, 984, 1043, 1044, 1054, 1063, 1064, 1083, 1084	Center Divider, Steel - 36", 38", 40"	Right Hand	AM1345362C1	\$ 260.00	
			Left Hand	AM1345361C1	\$ 260.00	
	2206, 2208, 2212, 2406, 2408, 2412, 3206, 3208, 3212, 3406, 3408, 3412, 3416	Center Divider - 30"		AM86978697	\$ 685.00	
	2206, 2208, 2212, 2406, 2408, 2412, 3206, 3208, 3212, 3406, 3408, 3412, 3416, 3418	Center Snout - 30" w/o Metal Frame		AM86980207	\$ 375.00	
	2206, 2208, 2406, 2408, 3206, 3208, 3406, 3408	Center Snout - 36"		AM86980209	\$ 375.00	
	2206*, 2208*, 2212**, 2406, 2408, 2412, 3206, 3208, 3212, 3406, 3408, 3412, 3416, 3418 *30", 36" or 38" Row Spacing **20", 22" or 30" Row Spacing	Outer Snout		AM86980203	\$ 325.00	

Prices Subject to Change without Prior Notice. The use of original equipment manufacturer (OEM) part numbers or trademarks, e.g. Case® and John Deere®, are for reference purposes only and for indicating product use and compatibility. Our company and the listed replacement parts contained herein are not sponsored, approved or manufactured by the OEM. All parts are New unless designated Reman in the description.

Case IH®—Combine

	Application	Description		Part Number	Retail Price	Core
	823, 824, 833, 834,	Row Center Snout w/ Point, Poly - 28", 30"	Narrow	AM176228C95P	\$ 220.00	
	843, 844, 853, 854,	Row Center Snout w/ Point, Steel - 28",	Narrow	AM176228C94	\$ 288.00	
	863, 864, 873, 883,	30"				
	943, 944, 954, 963,	Row Center Snout w/ Point, Poly - 36"	Wide	AM176221C94P	\$ 220.00	
	1044, 1054, 1063,	Row Center Snout w/ Point, Steel - 36"	Wide	AM176221C94	\$ 317.00	
	1064, 1083, 1084					
	Models w/ Polytin Snouts	Wear Plate, Stainless Steel	Right Hand	AMX27289	\$ 23.00	
			Left Hand	AMX27288	\$ 23.00	
	2206, 2208, 2212, 2406, 2408, 2412, 3206, 3208, 3212, 3406, 3408, 3412, 3416, 3418	Wear Strip 30" Long For Inner Dividers	Right Hand	AM86553710	\$ 43.00	
			Left Hand	AM86553709	\$ 43.00	
	Models w/ Polytin Kits	Wear Strip, Stainless Steel For Fender Snout	Right Hand	AMX27314	\$ 23.00	
			Left Hand	AMX27313	\$ 23.00	
	823, 824, 833, 834, 843, 844, 853, 854, 863, 864, 873, 883, 943, 944, 954, 963, 964, 983, 984, 1043, 1044, 1054, 1063, 1064, 1083, 1084	Wear Tip For Polytin	Poly	AM71364963NP	\$ 27.00	
			Cast	AM71364963A	\$ 19.00	
		Wear Tip For Steel Divider Point	Cast	AM71364963	\$ 40.00	
	2206, 2208, 2212, 2406, 2408, 2412, 3206, 3208, 3212, 3406, 3408, 3412, 3416, 3418	Wear Tip - 20", 22" or 30"		AM87015179	\$ 41.00	
	2206, 2208, 2212, 2406, 2408, 2412, 3206, 3208, 3212, 3406, 3408, 3412, 3416, 3418	Wear Tip - 20" or 22"		AM87015178	\$ 41.00	
	824, 833, 834, 843, 844, 853, 854, 863, 864, 873, 874, 914, 943, 944, 954, 963, 964, 983, 984, 1043, 1044, 1054, 1063, 1064, 1083	Ear Saver Sold Individually (2) Required per Row Replaces 199097C1, 199097C2		AM199097C3	\$ 3.90	
	2200, 2400, 3200 & 3400 Series	Ear Savers Sold Individually (2) Required per Row Replaces 86526475		AMX27177	\$ 15.00	
	2200, 2400, 3200 & 3400 Series	Ear Saver Sold Individually (2) Required per Row		AM86526475	\$ 8.00	
	3406, 3408, 3412, 3416, 3418, 4206, 4208, 4406, 4408, 4412	Ear Saver 30" Row Spacing	Inside Snout	AM47483715	\$ 7.95	
	4206, 4208, 4406, 4408, 4412	Ear Saver 30" Row Spacing	Outside Snout	AM47515996	\$ 7.95	
	Models w/ Metal Heads	Poly Skid Bubble Tip	Outside Snout	AMX27146	\$ 18.50	
	Models w/ Metal Heads	Poly Skid Bubble Tip	Inside Snout	AMX27147	\$ 18.50	

Case IH®—Combine

Application	Description	Part Number	Retail Price	Core
 Models w/ Poly Snout	Poly Skid Bubble Tip	Outside Snout AMX27150	\$ 18.50	
 Models w/ Poly Snout	Poly Skid Bubble Tip	Inside Snout AMX27151	\$ 18.50	
Most Models	Poly Gathering Chain Guard 8.90" x 23" - Red, Includes Hardware	AMX27153	\$ 21.00	

Cornhead—Augers and Auger Liners

Application	Description	Part Number	Retail Price	Core
30" Row	4 Row Poly Auger Liner	AMX27129	\$ 260.00	
30" Row	6 Row Poly Auger Liner	AMX27130	\$ 299.00	
30" Row	8 Row Poly Auger Liner	AMX27131	\$ 367.00	
30" Row	12 Row Poly Auger Liner	AMX27132	\$ 578.00	
963, 1063	6 Row Cornhead Auger - 30" Extended Wear, 173.25" Long	AM199694C4	\$ 1339.00	
983, 1083	8 Row Cornhead Auger - 30" Extended Wear, Overall Length - 225 1/4", Right and Left Hand Flighting, 13 3/4" Flighting Diameter, 1 1/8" Hex Shaft Diameter, 15" Pitch	AM199696C3	\$ 1550.00	
1064	6 Row Cornhead Auger, Wide	AM338927A1	\$ 1571.00	
2206, 2208, 2212, 2406, 2408, 2412, 3206, 3208, 3212, 3406, 3408, 3412	Cornhead Auger For 8 Row 30" or 12 Row 20"	AM86615202	\$ 2150.00	
943, 944, 954, 963, 964, 983, 984, 1043, 1044, 1054, 1063, 1064, 1083, 1084	Sprocket Assembly 64 Tooth, 1.139" Hex Hub, 13.073" OD	AM199729C1	\$ 125.00	
2206, 2208, 2212, 2406, 2408, 2412, 3206, 3208, 3212, 3406, 3408, 3412	Auger Drive Sprocket Assembly 20 & 24 Tooth, 5.20" & 6.135" OD	AM87283922	\$ 133.83	
943, 944, 954, 963, 964, 983, 984, 1043, 1044, 1054, 1063, 1064, 1083, 1084	Drive Sprocket 15 Tooth, 29 mm Hex Hub, 3.294" OD	AM199727C1	\$ 43.00	
2206, 2208, 2212, 2406, 2408, 2412	Idler Sprocket Replaces 179013A1	AM86627870	\$ 36.00	
2206, 2208, 2212, 2406, 2408, 2412, 3206, 3208, 3212, 3406, 3408, 3412	Auger Drive Sprocket 58 Tooth, 14.267" OD, 1.13" Hex Bore	AM87280073	\$ 135.44	
2406, 2408, 2412	Auger Drive Sprocket 21 & 27 Tooth, 5.408" & 6.135" OD	AM87501858	\$ 58.00	
943, 944, 954, 963, 964, 983, 984, 1043, 1044, 1054, 1063, 1064, 1083, 1084	Slip Clutch Plate 6.50" Bolt Circle, 0.343" Hole Diameter	AM177963C1	\$ 125.17	
943, 944, 954, 963, 964, 983, 984, 1043, 1044, 1054, 1063, 1064, 1083	Slip Clutch Facing 2.97" ID, 6" OD, 0.192" Thick	AM177964C2	\$ 16.07	
2606, 2608, 2612, (4206, 4208, 4416 - w/ Chopping Row Units), 4406, 4408, (4408, 4412, 4416, 4418 - w/o Chopping Row Units), 4408F, 4412, 4412F	Idler Sprocket Replaces 47906258, 84977538	AM87473652	\$ 62.00	
2206, 2208, 2212, 2406, 2408, 2412, 3206, 3208, 3212, 3406, 3408, 3412	Auger Drive Bearing 1 1/8" (28.60 mm) Hex Bore, 1.4843" (37.70 mm) Wide, 2.8346" (72 mm) OD	AM121602	\$ 17.00	

Case IH®—Combine

Cornhead—Stalk Stompers and Components

Kits include header mounting brackets, 12" stalk stomper shoes, stalk stomper torsion mounts, u-bolts and mounting hardware. Kits require 2" x 2" square tool bar.

Application	Description	Part Number	Retail Price	Core
2206, 2208, 2212, 2406, 2408, 2412, 3206, 3208, 3212, 3406, 3408, 3412	Stalk Stomper Kit, 2 Row For 8 Row and 12 Row Covers 1 Row on Each Side of Feederhouse No Coverage Below Feederhouse Replaces 73343983	AMX31000	\$ 1000.00	
	Stalk Stomper Kit, 4 Row For 8 Row and 12 Row Cornheads Covers 2 Rows on Each Side of Feederhouse No Coverage Below Feederhouse Replaces 73343984	AMX31003	\$ 1550.00	
	Stalk Stomper Kit, 4 Row For 8 Row and 12 Row Cornheads Covers 2 Rows Below Feederhouse and 2 Outer Rows (1 per side) Replaces 73343985	AMX31004	\$ 1600.00	
	Stalk Stomper Kit, 6 Row For 8 Row and 12 Row Cornheads Covers 2 Rows Below Feederhouse and 4 Outer Rows (2 per side) Replaces 73343986	AMX31006	\$ 2500.00	
	Stalk Stomper Kit, 6 Row For 8 Row and 12 Row Cornheads Covers 3 Rows on Each Side of Feederhouse No Coverage Below Feederhouse Replaces 73343987	AMX31007	\$ 2450.00	
2206, 2208, 2212, 2406, 2408, 2412, 3206, 3208, 3212, 3406, 3408, 3412	Stalk Stomper Kit, 8 Row For 8 Row and 12 Row Cornheads Covers 2 Rows Below Feederhouse and 6 Outer Rows (3 per side) Replaces 73343988	AMX31008	\$ 2950.00	
	Stalk Stomper Kit, 12 Row For 8 Row and 12 Row Cornheads Covers 2 Rows Below Feederhouse and 10 Outer Rows (5 per side) Replaces 73343989	AMX31009	\$ 3825.00	
	Stalk Stomper Kit, 4 Row For 6 Row Cornheads Covers 2 Rows on Each side of Feederhouse No Coverage Below Feederhouse Replaces 73343973	AMX31001	\$ 1550.00	
	Stalk Stomper Kit, 4 Row For 6 Row Cornheads Covers 2 Rows Below Feederhouse and 2 Outer Rows (1 per side) Replaces 73343974	AMX31002	\$ 1600.00	
	Stalk Stomper Kit, 6 Row For 6 Row Cornheads Covers 2 Rows Below Feederhouse and 4 Outer Rows (2 per side) Replaces 73343975	AMX31005	\$ 2450.00	

Case IH®—Combine

Application	Description	Part Number	Retail Price	Core
2608, 2612, 4206, 4406, 4408, 4412, 4416, 4418	Stalk Stomper Kit, 2 Row Kit Covers 1 Row on Each Side of Cornhead Replaces 73343950	AMX31010	\$ 1000.00	
	Stalk Stomper Kit, 4 Row Kit Covers 2 Rows on Each Side of Cornhead Replaces 73343951	AMX31011	\$ 1500.00	
	Stalk Stomper Kit, 6 Row Kit Covers 3 Rows on Each Side of Cornhead Replaces 73343952	AMX31012	\$ 2000.00	
	Stalk Stomper Kit, 8 Row Kit Covers 6 Rows on Each Side of Cornhead Replaces 73343953	AMX31013	\$ 2650.00	
	Stalk Stomper Kit, 12 Row Kit Covers 6 Rows on Each Side of Cornhead Replaces 73343954	AMX31014	\$ 3600.00	
	Stalk Stomper Kit, 12 Row Folding Head Kit Covers 6 Rows on Each Side of Cornhead Replaces 73343967	AMX31015	\$ 3900.00	
	Stalk Stomper Kit, 16 Row Covers 8 Rows on Each Side of Cornhead Replaces 73343955	AMX31016	\$ 4225.00	
	Stalk Stomper Kit, 18 Row Kit Covers 9 Rows on Each Side of Cornhead Replaces 73343956	AMX31017	\$ 4700.00	
	2206, 2208, 2212, 2406, 2408, 2412, 3206, 3208, 3212, 3406, 3408, 3412	Header Mounting Bracket	AMX30007	\$ 180.00
2206, 2406, 3206, 3406	Header Bracket, Right End For 6 Row Header Kits	AMX30009	\$ 165.00	
	Header Bracket, Left End For 6 Row Header Kits	AMX30008	\$ 165.00	
2206, 2208, 2212, 2406, 2408, 2412, 3206, 3208, 3212, 3406, 3408, 3412	Header Bracket, Center	AMX30012	\$ 55.00	
2206, 2208, 2212, 2406, 2408, 2412, 2608, 2612, 3206, 3208, 3212, 3406, 3408, 3412, 4206, 4406, 4408, 4412, 4416, 4418	Single Row Shoe, 12" Includes Torsion Mounting Bracket	AMX30000	\$ 320.00	
	Replacement Shoe, 12" Torsion Mounting Bracket Not Included	AMX30002	\$ 125.00	
2206, 2208, 2212, 2406, 2408, 2412, 3206, 3208, 3212, 3406, 3408, 3412	Single Center Shoe, 12"	AMX30001	\$ 320.00	
2206, 2208, 2212, 2406, 2408, 2412, 2608, 2612, 3206, 3208, 3212, 3406, 3408, 3412, 4206, 4406, 4408, 4412, 4416, 4418	Stalk Stomper Torsion Unit	AMX30005	\$ 160.00	
	Tool Bar 2" x 2" Square, 72" Long, 3/16" Sidewall Thickness	AMX30003	\$ 75.00	
	Tool Bar 2" x 2" Square, 102" Long, 3/16" Sidewall Thickness	AMX30004	\$ 105.00	
2206, 2208, 2212, 2406, 2408, 2412, 3206, 3208, 3212, 3406, 3408, 3412	Tool Bar Mounting Bracket	AMX30010	\$ 80.00	
	Offset Tool Bar Mounting Bracket	AMX30011	\$ 90.00	
2412, 2612, 3212, 3412, 4412, 4416, 4418	Tool Bar Splice Bracket Use to splice 2 Tool Bars together to add extended length for various row spacing and additional rows	AMX30006	\$ 42.00	

Case IH®—Combine











Cornhead—Hydraulic Deck Plate Kits

Kits include components to connect your cornhead to adjustable hydraulic deck plates.

Application	Description	Part Number	Retail Price	Core
943, 1043	Hydraulic Deck Plate Kit 900 & 1000 Series, 4 Row 30"	AMX27508	\$ 2050.00	
963, 1063	Hydraulic Deck Plate Kit 900 & 1000 Series, 6 Row 30"	AMX27509	\$ 2850.00	
983, 1083	Hydraulic Deck Plate Kit 900 & 1000 Series, 8 Row 30"	AMX27510	\$ 3725.00	
	Hydraulic Deck Plate Kit 900 & 1000 Series, 12 Row 30"	AMX27507	\$ 5400.00	

Cornhead—Row Unit Components

Application	Description	Part Number	Retail Price	Core
 823, 824, 833, 834, 843, 844, 853, 854, 863, 864, 873, 883	Cain and Sprocket Kit Includes Chain, Drive Gear and Non-Greaseable Idler	AMX27387	\$ 50.00	
	Chain and Sprocket Kit Includes Chain, Drive Gear and Greaseable Idler	AMX27388	\$ 50.00	
 900 & 1000 Series	Chain and Sprocket Kit Includes Chain, Drive Gear and Non-Greaseable Idler	AMX27155	\$ 50.00	
	Chain and Sprocket Kit Includes Chain, Drive Gear and Greaseable Idler	AMX27156	\$ 50.00	
 227, 228, 229, 327WN, 328N, 329N, 428, 429, 429N, 430, 430N, 620N, 630N, 724, 733, 734, 744, 762, 763, 764, 782	Gathering Chain	AM654164R91	\$ 75.00	
 823, 824, 833, 834, 843, 844, 853, 854, 863, 864, 873, 883, 943, 944, 954, 963, 964, 983, 984, 1043, 1044, 1054, 1063, 1083, 1084, 2206, 2208, 2212, 2406, 2408, 2412, (3206*, 3208* - 2011 and Later), 3212, 3406, 3408, 3412, 3416 *On These Models 8 Lug Chain Replaces 6 Lug Replaces 176279C91	Gathering Chain, Black 48 Links, 8 Lug 2.63" Wide Attachment Links	AMCHG-100	\$ 30.00	
 2606, 2608, 2612	Gathering Chain, Black 76 Links, 8 Lug Replaces 84977231	AM84251979	\$ 70.00	
 (2206, 2208, 2212 ASN HAJ0003469), 2406, 2408, 2412, 3206, 3208, 3212, 3406, 3408, 3412 - 2011 and Later	Gathering Chain 6 Lug	AM84284709	\$ 55.00	
 843, 844, 863, 883	Gathering Chain Drive Sprocket 10 Tooth w/o Keyway	AM176278C2	\$ 20.00	
 943, 944, 954, 963, 964, 983, 984, 1043, 1044, 1054, 1063, 1064, 1083, 1084	Gathering Chain Drive Sprocket, 10 Tooth w/ Keyway	AM199497C1	\$ 15.00	

Case IH®—Combine

	Application	Description	Part Number	Retail Price	Core
	2206, 2208, 2212, 2406, 2408, 2412, 3206, 3208, 3212, 3406, 3408, 3412, 3416, 3418	Gathering Chain Drive Sprocket 7 Tooth	AM86837081	\$ 16.00	
	2206, 2208, 2212, 2406, 2408, 2412, 3206, 3208, 3212, 3406, 3408, 3412, 3416, 3418	Gathering Chain Drive Sprocket 8 Tooth	AM86611371	\$ 27.00	
	2606XR, 2608XF, 2608XR, 2612XR	Gathering Chain Drive Sprocket 11 Tooth	AM84977235	\$ 62.00	
	823, 824, 833, 834, 843, 844, 853, 854, 863, 864, 873, 883	Topshaft Conversion Kit Changes 800 Drive to 900/1000 Keyed Style Includes Sprocket, Shaft, Snap Ring, Woodruff Key, Nut and Oil Seal	AM176371KIT	\$ 58.00	
	843, 844, 863, 883, 943, 944, 954, 963, 983, 984, 1043, 1044, 1054, 1063, 1083, 2206, 2208, 2212, 2406, 2408, 2412	Idler Sprocket, Greaseable 8 Tooth, 0.65" ID	AMAH101219	\$ 12.50	
	843, 844, 863, 883, 943, 944, 954, 963, 983, 984, 1043, 1044, 1054, 1063, 1083, 2206, 2208, 2212, 2406, 2408, 2412, 3206, 3208, 3212, 3406, 3408, 3412 Replaces 176283C91, 87034967	Idler Sprocket, Non-Greaseable 8 Tooth, 0.65" ID	AMAN102448	\$ 12.50	
	824, 833, 834, 844, 853, 854, 863, 864, 873, 874, 883, 943, 944, 954, 963, 964, 983, 984, 1043, 1044, 1054, 1063, 1064, 1083, 1084	Idler Sprocket 60 Chain, 15 Tooth, 0.625" ID	AM629972R91	\$ 19.00	
	2606XR, 2608XF, 2608XR, 2612XR, 4206, 4208, 4406, 4408, 4408F, 4412, 4412F, 4416	Idler Sprocket Replaces 84977538, 87473652	AM47906258	\$ 90.00	
	2206, 2208, 2212, 2406, 2408, 2412, 3206, 3208, 3212, 3406, 3408, 3412	Idler Sprocket Assembly 15 Tooth, 0.654" ID, 3.852" OD	AM86619126	\$ 26.46	
	823, 824, 833, 834, 843, 844, 853, 854, 863, 864, 873, 883	Gathering Chain Guide	AM176280C1	\$ 17.00	
	900 & 1000 Series	Gathering Chain Guide	AM1347176C1	\$ 17.00	
	2206, 2208, 2212, 2406, 2408, 2412	Chain Guide	AM86611426	\$ 35.00	
	3206, 3208, 3212, 3406, 3408, 3412, 3416, 3418	Chain Guide, Right Hand	AM87593362	\$ 73.00	
		Chain Guide, Left Hand	AM84316263	\$ 87.00	
	2606XR, 2608XF, 2608XR, 2612XR, 4206, 4208, 4406, 4408, 4412, 4412F30, (4408, 4412, 4416, 4418 - w/o Stalk Chopper)	Chain Guide Wear Strip	AM84977612	\$ 20.00	
	823, 824, 833, 834, 843, 844, 853, 854, 863, 864, 873, 883	Deck Plate, Right Hand	AM176292C91	\$ 20.00	
	823, 824, 833, 834, 843, 844, 853, 854, 863, 864, 873, 883	Deck Plate, Left Hand	AM176291C91	\$ 20.00	
	900 & 1000 Series	Deck Plate, Right Hand	AM199382C1	\$ 19.00	
	943, 944, 954, 963, 964, 983, 984, 1043, 1044, 1054, 1063, 1064, 1083, 1084	Deck Plate, Left Hand	AM199381C1	\$ 19.00	

Prices Subject to Change without Prior Notice. The use of original equipment manufacturer (OEM) part numbers or trademarks, e.g. Case® and John Deere®, are for reference purposes only and for indicating product use and compatibility. Our company and the listed replacement parts contained herein are not sponsored, approved or manufactured by the OEM. All parts are New unless designated Reman in the description.

Case IH®—Combine

	Application	Description	Part Number	Retail Price	Core
	2206, 2208, 2212, 2406, 2408, 2412	Deck Plate, Right Hand Replaces 86611537, 86978031	AM86978032	\$ 33.00	
	2206, 2208, 2212, 2406, 2408, 2412	Deck Plate, Left Hand Manual Adjust Replaces 86611536	AM87047540	\$ 33.00	
	2206, 2208, 2212, 2406, 2408, 2412	Deck Plate, Left Hand Hydraulic Adjust Replaces 86611535, 86980000	AM87047608	\$ 70.00	
	2606X, 2608XR, 2612XR, 4206, 4208, 4412F BSN 697	Deck Plate, Right Hand For Non-Chopping Heads	AM84972758	\$ 55.00	
	(2606X, 2608XR, 2612XR ASN 636), 4206, 4208, 4412F BSN 697	Deck Plate, Left Hand For Non-Chopping Heads	AM47474090	\$ 41.00	
	2606XR, 2608XF, 2608XR, 2612XR, 4206, 4208, 4406, 4408, 4408F, 4412, 4412F, 4416, 4418	Shield, Right Hand Replaces 87662218	AM47640768	\$ 135.00	
	1043, 1044, 1054, 1063, 1064, 1083, 1084, 3206, 3208, 3212, 3406, 3408, 3412	Bearing and Shield Kit Includes (2) AM1989222C2 Bearings and (2) AM327913A2 Shields	AMB95612	\$ 96.70	
	1043, 1044, 1054, 1063, 1064, 1083, 1084	Weed Knife, Right Hand Front	AM1306824C1	\$ 19.49	
		Weed Knife, Left Hand Front	AM1306823C1	\$ 18.71	
	2206, 2208, 2212, 2406, 2408, 2412	Weed Knife, Right Hand Front	AM86611411	\$ 28.03	
		Weed Knife, Left Hand Front	AM86611414	\$ 29.99	
	2206, 2208, 2212, 2406, 2408, 2412	Weed Knife, Right or Left Hand Rear	AM86611418	\$ 19.25	
	1043, 1044, 1054, 1063, 1064, 1083, 1084	Weed Knife, Right or Left Hand Rear 9.62" Long, 3.19" Width, 8.31" Hole Diameter	AM1306079C1	\$ 31.09	
	(1043, 1044, 1054, 1063, 1064, 1083, 1084 ASN JJC0146000), 3206, 3208, 3212, 3406	Stalk Roll Bearing 3.25" Long	AM1989222C2	\$ 22.00	
	(1043, 1044, 1054, 1063, 1064, 1083, 1084 ASN JJC0146000), 3206, 3208	Stalk Roll Bearing Shield	AM327913A2	\$ 4.50	
	(1043, 1044, 1054, 1063, 1064, 1083 ASN JJC0146000)	Stalk Roll Auger, Right Hand	AM352551A1	\$ 80.00	
		Stalk Roll Auger, Left Hand	AM352552A1	\$ 80.00	
	1043, 1044, 1054, 1063, 1064, 1083, 1084	Stalk Roll Cone, Right Hand Replaces 1306729C1, 1989232C1	AM1306729C2	\$ 127.57	
		Stalk Roll Cone, Left Hand Replaces 1989231C1, 1306728C1	AM1306728C2	\$ 130.67	
	2206, 2208, 2212, 2406, 2408, 2412	Stalk Roll Auger, Right Hand Replaces 86618147, 87021346	AM87737779	\$ 60.00	
		Stalk Roll Auger, Left Hand Replaces 86618146, 87021344	AM87737776	\$ 60.00	
	800, 900 & 1000 Series, 3206, 3208, 3212, 3406, 3408, 3412	Snapping Roll Drive Coupler (1) Required per Roll	AM176301C1	\$ 20.00	

Case IH®—Combine

	Application	Description	Part Number	Retail Price	Core
	1000 Series, 3206, 3208, 3212, 3406, 3408, 3412	Stalk Roll Shaft	AM199293C5	\$ 82.00	
	823, 824, 833, 834, 843, 844, 853, 854, 863, 864, 873, 883	Stalk Roll Knife (4) Required per Roll	AM176304C2	\$ 12.75	
	943, 944, 954, 963, 964, 983, 984, 1043, 1044, 1054, 1063, 1064, 1083, 1084	Stalk Roll Knife (4) Required per Roll	AM1327126C1	\$ 12.75	
	2206, 2208, 2212, 2406, 2408, 2412	Stalk Roll Knife Extended Wear, 5.40 mm Thick (2) Required per Roll	AM86977538	\$ 44.00	
	2606, 2608, 2612, 4206, 4208, 4212, 4406, 4408, 4412	Stalk Roll Knife Extended Wear, 5.40 mm Thick (4) Required per Roll	AM84499693	\$ 42.00	
	3206, 3208, 3212, 3406, 3408, 3412, 3416, 3418	Stalk Roll Knife	AM87598741	\$ 18.95	
	2606, 2608, 2612	Stalk Chopping Knife	AM84340041	\$ 20.65	
	2206, 2208, 2212, 2406, 2408, 2412	Stalk Roll Barrel, Binocular Replaces 86626793, 87107017, 87107018	AM87663360	\$ 360.00	
	823, 824, 833, 834, 843, 844, 853, 854, 863, 864, 873, 883, 943, 944, 954, 963, 964, 983, 984, 1043, 1044, 1054, 1063, 1064, 1083, 1084	Bracket, Right Hand For Gathering Chain Idler Sprocket	AM176287C2	\$ 39.00	
	823, 824, 833, 834, 843, 844, 853, 854, 863, 864, 873, 883, 943, 944, 954, 963, 964, 983, 984, 1043, 1044, 1054, 1063, 1064, 1083, 1084	Bracket, Left Hand For Gathering Chain Idler Sprocket	AM176286C2	\$ 39.00	
	2206, 2208, 2212, 2406, 2408, 2412, 3206, 3208, 3212, 3406, 3408, 3412	Idler Bracket	AM87029139	\$ 29.00	
	943, 944, 954, 963, 964, 983, 984, 1043, 1044, 1054, 1063, 1064, 1083, 1084	Support Assembly, Right Hand Replaces 199372C4, 199372C3	AM199372C5	\$ 186.00	
	943, 944, 954, 963, 964, 983, 984, 1043, 1044, 1054, 1063, 1064, 1083, 1084	Support Assembly, Left Hand Replaces 199371C4, 199371C3	AM199371C5	\$ 186.00	
	2203, 2205, 2212, 2406, 2408, 2412	Wear Plate Replaces 86583946	AM87027837	\$ 19.00	
	(1043, 1044, 1054, 1063, 1064, 1083, 1084 ASN JJC0146000), 3206, 3208, 3212, 3406, 3408, 3412	Support, Right Hand	AM1327205C1	\$ 41.00	
	(1043, 1044, 1054, 1063, 1064, 1083, 1084 ASN JJC0146000), 3206, 3208, 3212, 3406, 3408, 3412	Support, Left Hand May also be used to replace early needle bearing style supports (1306172C1 for Right Hand, 1306172C1 for Left Hand) for models BSN JJC0146000 if the Auger is replaced with AM352551A1 which has the water pump style bearing	AM1327204C1	\$ 41.00	
	2206, 2208, 2212, 2406, 2408, 2412, 3206, 3208, 3212, 3406, 3408, 3412, 3416, 3418	Auger Support, Front	AM86729260	\$ 34.00	
	823, 824, 833, 834, 843, 844, 853, 854, 863, 864, 873, 883	Stalk Roll Drive Gear Set	AM199308C1	\$ 330.77	

Prices Subject to Change without Prior Notice. The use of original equipment manufacturer (OEM) part numbers or trademarks, e.g. Case® and John Deere®, are for reference purposes only and for indicating product use and compatibility. Our company and the listed replacement parts contained herein are not sponsored, approved or manufactured by the OEM. All parts are New unless designated Reman in the description.

Case IH®—Combine





	Application	Description	Part Number	Retail Price	Core
	2206, 2208, 2212, 2406, 2408, 2412, 3206, 3208, 3212, 3406, 3408, 3412	Bevel Drive Gear and Shaft	AM86530072	\$ 152.00	
	1043, 1044, 1054, 1063, 1064, 1083, 1084	Drive Sprocket Shaft	AM199490C2	\$ 79.12	
	823, 824, 833, 834, 843, 844, 853, 854, 863, 864, 873, 883, 943, 944, 954, 963, 964, 983, 984, 1043, 1044, 1054, 1063, 1064, 1083, 1084	Drive Sprocket Shaft Woodruff Key	AM124553	\$ 0.88	
	943, 944, 954, 963, 983, 984, 1054, 1063	Sprocket Assembly, Main Drive 24 Tooth Double Sprocket, 6.153" OD	AM1306352C1	\$ 180.00	
	943, 963, 983, 1043, 1044, 1054, 1063, 1064, 1083, 1084	Sprocket Assembly 64 Tooth, 8.666" ID, 13.097" OD, 9.452" Bolt Hole Centers For Auger Slip Clutch Drive	AM1306333C1	\$ 130.00	
	2406, 2408, 2412	Sprocket Assembly 20 & 21 Tooth, 5.20" & 5.408" OD For Auger Drive	AM87283939	\$ 80.00	
	943, 944, 954, 963, 964, 983, 984, 1043, 1044, 1054, 1063, 1064, 1083, 1084	Sprocket, Main Drive 35 Tooth, 8.772" OD, 1.139" Hex Hub	AM199647C1	\$ 75.00	
	943, 944, 954, 963, 964, 983, 984, 1043, 1044, 1064, 1083, 1084	Sprocket, Main Drive 30 Tooth, 7.585" OD, 1.139" Hex Hub	AM199643C1	\$ 85.00	
	964, 983, 984, 1064, 1083, 1084	Sprocket, Main Drive 5-Bolt, 24 Tooth 3.255" ID, 6.136" OD	AM1306156C1	\$ 47.11	
	2208, 2212, 2406, 2408, 2412, 3208, 3212	Sprocket, Main Drive 30 Tooth, 7.57" OD, 1.257" Hex Bore	AM87024802	\$ 171.30	
	2206, 2208, 2212, 2406, 2408, 2412, 3206, 3208, 3212, 3406, 3408, 3412	Drive Sprocket 28 Tooth, 9.448" OD, 1.26" Hex Bore	AM86524051	\$ 76.31	
	2206, 2208, 2212, 2406, 2408, 2412, 3206, 3208, 3212, 3406, 3408, 3412	Drive Sprocket 34 Tooth, 8.54" OD, 1.257" Hex Bore	AM86524052	\$ 64.64	
	2208, 2212, 2406, 2408, 2412, 3208, 3212	Drive Sprocket 25 Tooth, 8.48" OD, 1.257" Hex Hub	AM87024803	\$ 95.00	
	1043, 1044, 1054, 1063, 1064, 1083, 1084	Shaft Collar, Main Drive	AM1327106C1	\$ 26.24	
	2206, 2208, 2212, 2406, 2408, 2412, 3206, 3208, 3212, 3406, 3408, 3412	Bracket	AM86611369	\$ 49.65	

Case IH®—Combine

	Application	Description	Part Number	Retail Price	Core
	2206, 2208, 2212, 2406, 2408, 2412, 3206	Pickup Bearing 1.25" Hex Bore	AM86523785	\$ 42.95	
	2206, 2208, 2212, 2406, 2408, 2412, 3206, 3208, 3212, 3406, 3408, 3412	Spring	AM86583948	\$ 8.22	
	2206, 2208, 2212, 2406, 2408, 2412, 3206, 3208, 3212, 3406, 3408, 3412	Sprocket Assembly 15 Tooth, 0.641" ID, 5.28" OD	AM86619245	\$ 70.27	
	2206, 2208, 2212, 2406, 2408, 2412, 3206, 3208, 3408, 3412	Sprocket 7 Tooth For Row Unit	AM84347361	\$ 40.00	
	2206, 2208, 2212, 2406, 2408, 2412, 3206, 3208, 3212, 3406, 3408, 3412	Tube	AM86583945	\$ 15.12	
	843, 844, 863, 883, 943, 944, 954, 963, 983, 984, 1043, 1044, 1054, 1063, 1064, 1083, 1084, 3206, 3208, 3212, 3406, 3408, 3412	Stalk Roll Rivet 3" Long, 0.375" Diameter	AM176307C1	\$ 4.47	
	2206, 2208, 2212, 3206, 3208, 3212	Bearing Cup For Rear Axle Hub	AM625743C1	\$ 12.54	
	2206, 2208, 2212, 2406, 2408, 2412, 3206, 3208, 3212, 3406, 3408, 3412	Ball Bearing	AM45396	\$ 14.08	
	2206, 2208, 2212, 2406, 2408, 2412, 3206, 3208, 3212, 3406, 3408, 3412	Bearing Flange	AM86620027	\$ 9.10	
	943, 944, 954, 963, 964, 983, 984, 1043, 1044, 1054, 1063, 1064, 1083, 1084	Auger Slip Clutch Hub 5.98" OD, 1.13" Hex Hub	AM1306334C1	\$ 197.73	
	943, 944, 954, 963, 964, 983, 984, 1043, 1044, 1054, 1063, 1064, 1083, 1084	Auger Slip Clutch Hub	AM1306335C91	\$ 178.70	
	824, 833, 834, 843, 844, 853, 854, 863, 864, 873, 874, 883	Coupling, Main Drive 4.63" Long, 1.147" Hex Bore	AM178647C2	\$ 66.33	
	(2206, 2208, 2212 BSN 0018272)	Coupler Connects Row Unit Gearbox	AM86583943	\$ 63.69	
	943, 944, 954, 963, 964, 983, 984, 1054, 1063	Hub, Main Drive and Driven 4.57" OD, 1.134" Hex Hub, 3.625" Bolt Hole Centers	AM1306358C1	\$ 158.68	
	1043, 1044, 1054, 1063, 1064, 1083, 1084	Slip Clutch Holder	AM1327150C1	\$ 90.59	
	824 ASN 12209, 833 ASN 12072, 834 ASN 12086, 843 ASN 12304, 844 ASN 13238, (853, 873 ASN 12025), 854 ASN 12077, 863 ASN 12322, 864 ASN 12081, 874 ASN 12020, 883 ASN 12093, 884 ASN 30001, 943, 944, 963, 964, 983, 984, 1043, 1063, 1083	Slip Clutch Holder	AM180032C1	\$ 88.81	
	943, 944, 1043, 1044	Sprocket, Main Drive 24 Tooth, 6.145" OD, 1.139" Hex Hub	AM199645C1	\$ 83.82	
	2206, 2208, 2212, 2406, 2408, 2412	Sprocket, Main Drive 26 Tooth, 6.612" OD, 1.256" Hex Hub	AM86614271	\$ 72.79	

Prices Subject to Change without Prior Notice. The use of original equipment manufacturer (OEM) part numbers or trademarks, e.g. Case® and John Deere®, are for reference purposes only and for indicating product use and compatibility. Our company and the listed replacement parts contained herein are not sponsored, approved or manufactured by the OEM. All parts are New unless designated Reman in the description.

Case IH®—Combine

	Application	Description	Part Number	Retail Price	Core
	943, 944, 954, 963, 964, 983, 984, 1043, 1044, 1054, 1063, 1064, 1083, 1084	Slip Clutch Hub	AM176499C1	\$ 98.15	
	1043, 1044, 1054, 1063, 1064, 1083, 1084	Slip Clutch Housing Replaces 199689C1, 199689C2, 199689C4	AM199689C5	\$ 143.52	
	(2206, 2208, 2212 BSN 0018272)	Slip Clutch Hub	AM86611420	\$ 72.82	
	1043, 1044, 1054, 1063, 1064, 1083, 1084	Stalk Roll Drive Retainer Replaces 1327111C1, 1327111C2, 1327111C3	AM1327111C4	\$ 60.76	
	1043, 1044, 1054, 1063, 1064, 1083, 1084	Stalk Roll Drive Spring Set Set of 6 Replaces 1327112C1	AM1327164C1	\$ 30.48	
	943, 944, 954, 963, 964, 983, 984, 1043, 1044, 1054, 1063	Spacer, Drive Shaft 5.90" Long, 1.138" Hex Diameter	AM1306158C1	\$ 67.02	
	1043, 1044, 1054, 1063, 1064, 1083, 1084	Thrust Washer 2.01" ID, 3.55" OD, 0.70" Thick	AM1327069C1	\$ 2.61	
	824, 833, 834, 844, 853, 854, 863, 864, 873, 874, 883	Bushing, Lower 1.25" Long, 1" ID	AM176374C1	\$ 19.46	
	843, 844, 853, 854, 863, 864, 873, 874, 883, 884, 943, 944, 954, 963, 964, 983, 984, 1043, 1044, 1054, 1063, 1064, 1083, 1084	Slip Clutch Hub	AM176387C1	\$ 63.36	
	943, 944, 954, 963, 964, 983, 984, 1043, 1044, 1054, 1063, 1064, 1083, 1084	Spring	AM176468C1	\$ 5.86	
	943, 944, 954, 963, 964, 983, 984, 1054, 1063	Sprocket Assembly, Main Drive 26 Tooth Double Sprocket 2.887" ID, 6.625" OD, 3.625" Bolt Hole Centers	AM1306146C1	\$ 240.25	
	1043, 1044, 1054, 1063, 1064, 1083, 1084	Bushing 1.43" Long, 1" ID Replaces 199479C1, 199479C2	AM199479C3	\$ 5.30	
	4412, 4418	Rubber Curtain	AM48113581	\$ 14.00	
	4206, 4208, 4406, 4408, 4412, 5505, 5506	Rubber Curtain	AM84977584	\$ 18.00	

Case IH®—Combine

Belts—615, 715

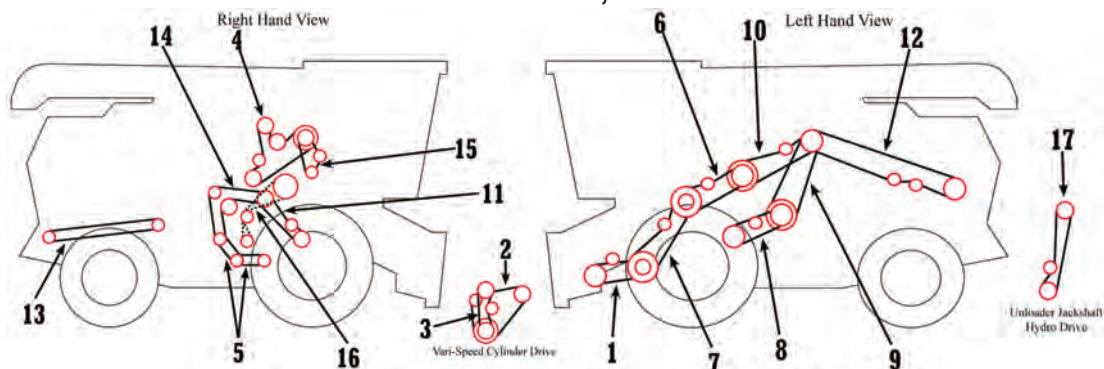

Application	Description	Part Number	Retail Price
1 715	Auger & Knife Drive (102")	AM178019C1	\$ 40.00
1 715	Auger & Knife Drive (150")	AM559064R1	\$ 74.10
1 715	Auger & Knife Drive (112")	AM191305C1	\$ 61.00
2 615, 715	Cylinder Drive, Variable Speed	AM171130C1	\$ 212.79
3 615, 715	Variable Speed Cylinder Drive (Primary)	AM171101C2	\$ 132.00
4 615, 715	Elevator Drive, w/o Raised Leveling Auger	AM937928R1	\$ 143.00
4 715	Elevator Drive, w/ Raised Leveling Auger	AM937929R1	\$ 87.63
4 715	Grain Tank Ext w/ Raised Leveling Auger	AM150433C1	\$ 89.00
6 615, 715	Feeder Drive, Regular	AM937932R1	\$ 78.00
7 615, 715	Feeder Jackshaft Drive Set of 2	AM176566C1	\$ 86.70
7 615 ASN 8001 w/o 34" Wheels, 715	Feeder Jackshaft Drive (Except Rice)	AM176565C1	\$ 85.00
7 715	Feeder Jackshaft Drive Double Belt Rice Only Set of 2	AM176577C1	\$ 160.18
7 (615, 715 ASN 8001 w/ 34" Wheels)	Feeder Jackshaft Drive, Rice	AM176576C1	\$ 80.09
8 715	Propulsion Drive (Belt Drive)	AM173110C1	\$ 121.38
8 615	Propulsion Drive	AM173109C1	\$ 102.75
9 615	Propulsion Jackshaft Drive, Diesel	AM172230C1	\$ 104.84
9 615	Propulsion Jackshaft Drive, Gas	AM937931R1	\$ 209.00
9 715	Propulsion Jackshaft Drive	AM150436C2	\$ 132.00
10 715	Separator Drive	AM171226C1	\$ 187.67
11 615	Shaker Shaft Drive, 265 RPM	AM564494R2	\$ 31.00
11 715	Shaker Shaft Drive	AM188716C1	\$ 45.00
12 715	Straw Chopper Drive	AM174614C2	\$ 106.14
13 615	Spreader Drive	AM171994C1	\$ 64.50
13 715	Straw Spreader	AM589622R1	\$ 51.75
14 615, 715	Straw Walker & Fan Jackshaft	AM170948C1	\$ 71.99
15 615, 715	Tailings Auger Drive	AM627297R1	\$ 8.89
16 615, 715	Unloader Drive, Belt Drive	AM559064R1	\$ 74.10
16 615, 715	Unloader Hydrostatic Drive	AM165676C1	\$ 61.00
17 615, 715	Unloader Jackshaft Drive, Hydrostat	AM175545C1	\$ 52.00
17 715	Unloader Jackshaft Drive	AM179317C2	\$ 69.67
NI 715	Compressor, A/C	AM936331R1	\$ 14.25
NI 715	Fan, Water Pump and Alternator (IH D310)	AM395539R1	\$ 17.92

Prices Subject to Change without Prior Notice. The use of original equipment manufacturer (OEM) part numbers or trademarks, e.g. Case® and John Deere®, are for reference purposes only and for indicating product use and compatibility. Our company and the listed replacement parts contained herein are not sponsored, approved or manufactured by the OEM. All parts are New unless designated Reman in the description.

Case IH®—Combine

Belts—815, 915

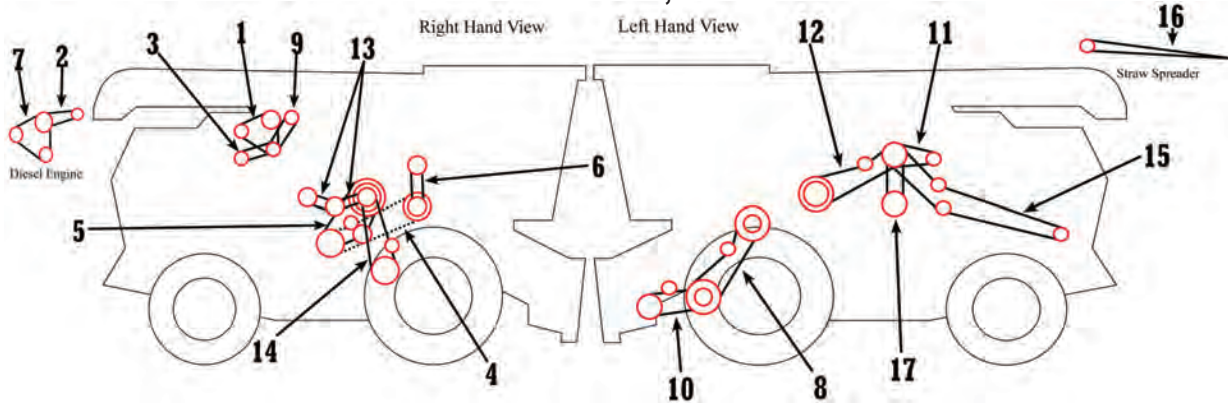

Application	Description	Part Number	Retail Price
1 815 ASN 8000, 915 w/ AC	Fan, Alternator, Water Pump	AM402253R91	\$ 44.50
2 815 ASN 8001	Compressor Drive, Diesel	AM65337C2	\$ 14.00
3 815 ASN 8001	Compressor Drive (Gas)	AM167031C2	\$ 5.60
4 815 ASN 8001, 915 ASN 2350	Cylinder Drive	AM174509C1	\$ 135.38
5 815, 915 - A/C w/ Cab	Cylinder Drive, Variable	AM164006C1	\$ 197.58
6 (815, 915 - ASN 8001)	Cylinder Speed Drive	AM167099C1	\$ 22.25
7 815 (D407), 915	Fan, Water Pump, Generator (Diesel Only)	AM528419R91	\$ 39.00
7 815 (D414), 915 BSN 8001	Fan, Water Pump, Generator w/ 414 Engine	AM537072R92	\$ 20.00
8 815 ASN 8001, 915 (w/o 23.1x34 or 24.5x32 Tires)	Feeder Jackshaft Drive	AM176565C1	\$ 85.00
8 (815, 915 - ASN 8001)	Feeder Drive (Belt Type) Bolt Att. Feeder	AM165053C2	\$ 134.00
8 815, 915	Feeder Jackshaft Drive Set of 3	AM176567C1	\$ 150.00
8 915 (w/ 23.1x34 or 24.5x32 Tires)	Feeder Jackshaft Drive	AM176576C1	\$ 80.09
8 915 BSN 19001 (w/ 23.1x34 or 24.5x32 Tires)	Feeder Jackshaft Drive Set of 2	AM176577C1	\$ 160.18
8 815 ASN 8001, 915 BSN 19001 (w/o 23.1x34 or 24.5x32 Tires)	Feeder Jackshaft Drive Set of 2	AM176566C1	\$ 86.70
9 (815, 915 - ASN 8001)	Governor Belt	AM532031R2	\$ 11.84
10 (815, 915 - ASN 8001)	Knife Drive	AM178019C1	\$ 40.00
10 (815, 915 - ASN 8001)	Hyd. Reel Pump Drive, Gas	AM178763C1	\$ 14.50
11 (815, 915 - ASN 8001)	Hyd. Reel Pump Drive, Gas	AM178763C1	\$ 14.50
11 915 ASN 8001	Hyd. Reel Pump Drive, Diesel	AM179007C1	\$ 10.30
12 815, 915	Separator Drive, Diesel	AM168665C2	\$ 202.49
12 815, 915	Separator Drive, Gas	AM166598C2	\$ 218.00
13 815, 915	Separator Fan Drive Set of 2	AM164999C92	\$ 60.00
14 815, 915	Shaker Shaft Drive 280 RPM	AM632702R1	\$ 50.60
14 815, 915	Shaker Shaft Drive 265 RPM	AM564494R2	\$ 31.00
15 815 ASN 3784, 915 ASN 2350	Straw Chopper Drive	AM174642C1	\$ 83.50
15 815 BSN 3784, 915 BSN 2350	Straw Chopper Drive	AM160870C1	\$ 72.88
16 815 ASN 8001	Straw Spreader Drive	AM196370C1	\$ 39.00
16 815 BSN 3784	Straw Spreader Drive	AM161820C1	\$ 39.00
16 815 ASN 3784, 915 ASN 2350	Straw Spreader Drive	AM161821C1	\$ 39.00
16 915 ASN 8001	Straw Spreader Drive	AM196371C1	\$ 65.00
17 815, 915	Unloader Jackshaft Drive	AM160173C1	\$ 67.69
NI 815 BSN 3783, 915 BSN 2349	Rotary Air Screen Drive	AM168725C1	\$ 9.00

Case IH®—Combine

Application	Description	Part Number	Retail Price
NI 815 ASN 3784, 915 ASN 2350	Rotary Air Screen Drive	AM172360C1	\$ 8.00
NI 815 BSN 8001	Platform Jackshaft Drive Bolt Att. Feeder	AM150816C1	\$ 67.00
NI 815, 915 BSN 8001	Feeder, Fast Speed for Bolt Att. Feeder	AM633728R2	\$ 64.50
NI 815 ASN 3784, 915 ASN 2350	Rotary Air Screen Drive	AM38331K	\$ 6.77
NI 815 ASN 3784, 915 ASN 2350	Straw Chopper Jackshaft Drive	AM160871C1	\$ 37.00

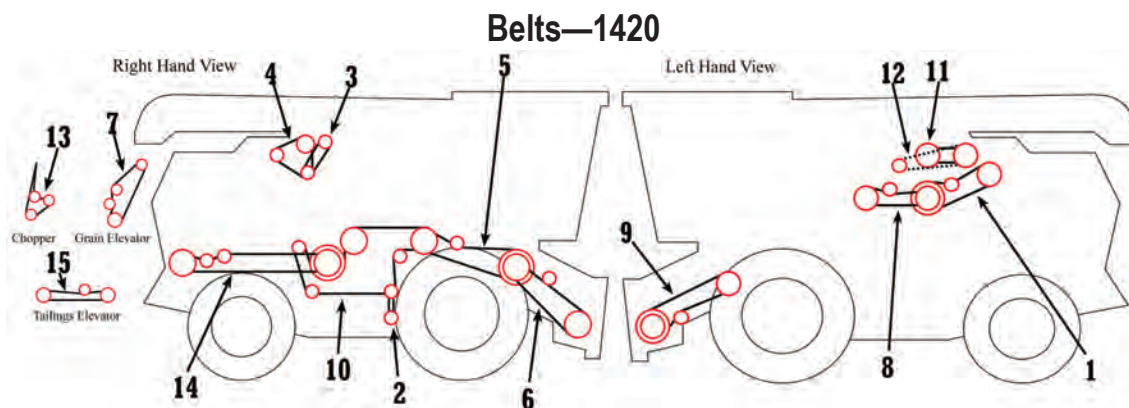

Application	Description	Part Number	Retail Price
1 1420	Auxiliary Pump Drive	AM191288C2	\$ 47.00
2 1420	Cleaning Fan Drive	AM599060R1	\$ 56.29
3 1420	Compressor Drive	AM280210C2	\$ 11.20
4 1420	Fan Belt (D358 Engine)	AM130724C91	\$ 23.28
5 1420	Feeder Drive	AM186377C1	\$ 118.00
6 1420	Feeder Jackshaft Drive Set of 2	AM197412C1	\$ 88.00
7 1420	Grain Elevator, Rice	AM181433C1	\$ 86.00
7 1420	Grain Elevator, Grain / Corn	AM182619C1	\$ 82.00
8 1420	Grain Tank Unloader Drive	AM195143C1	\$ 55.00
9 1420	Hydraulic Reel Drive	AM197414C2	\$ 89.00
10 1420	Right Side Drive, w/ Straw Chopper	AM186509C2	\$ 195.00
10 1420	Right Side Drive, w/ Discharge Beater	AM183049C1	\$ 154.00
11 1420	Rotor Variable Drive	AM1302174C1	\$ 238.38
12 1420	Separator Drive	AM191241C3	\$ 295.00
13 1420	Straw Chopper Drive	AM182945C1	\$ 75.00
14 1420 ASN 8000	Straw Spreader	AM589622R1	\$ 51.75
15 1420	Tailings Elevator Drive	AM674965R1	\$ 55.75

Case IH®—Combine

Belts—1440, 1460, 1480

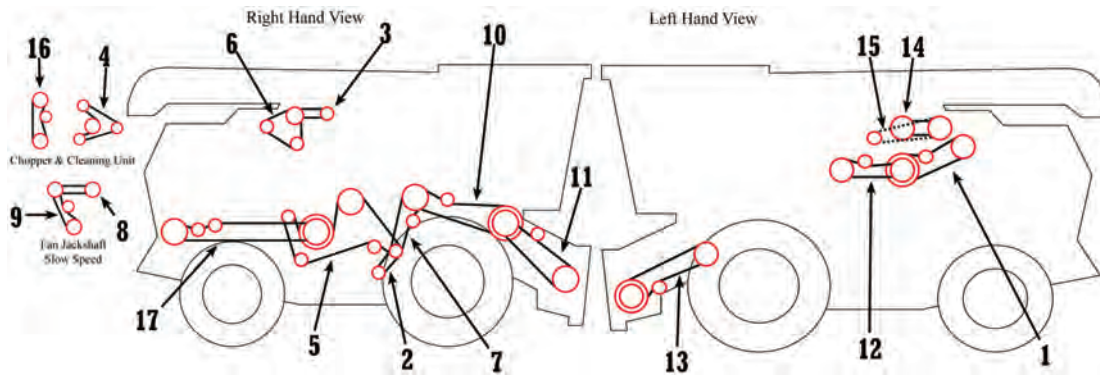

Application	Description	Part Number	Retail Price
1 1440, 1460, 1480	Auxiliary Pump Drive	AM191288C2	\$ 47.00
2 1440, 1460, 1480	Cleaning Fan Drive	AM195396C2	\$ 61.00
3 1440, 1460, 1480	Compressor Drive	AM874097C1	\$ 11.25
4 1440, 1460, 1480	Cleaning Unit Drive, w/ Straw Chopper	AM181055C1	\$ 170.00
5 (1440, 1460 BSN 1501)	Elevator Drive	AM192360C1	\$ 90.00
5 (1440, 1460 ASN 1501), 1480	Elevator Drive	AM186509C2	\$ 195.00
6 1440, 1460, 1480	Engine Fan (D436 Engine)	AM537072R92	\$ 20.00
7 1440, 1460	Fan Jackshaft Drive	AM191305C1	\$ 61.00
7 1480	Fan Jackshaft Drive	AM317904A1	\$ 77.00
8 1440, 1460, 1480	Slow Speed Fan Jackshaft Drive, 67"	AM181359C1	\$ 47.35
9 1440, 1460, 1480	Slow Speed Fan Jackshaft, 76"	AM610521R1	\$ 12.00
10 1480	Feeder Drive	AM194528C1	\$ 285.00
10 1440, 1460	Feeder Drive	AM192738C1	\$ 200.00
11 1480	Feeder Jackshaft Drive, 60" Feeder	AM393750A1	\$ 307.00
11 1440, 1460	Feeder Jackshaft Drive, 47" Feeder	AM1313095C2	\$ 170.00
11 1440, 1460, 1480	Feeder Jackshaft Drive, 54.50" Feeder	AM87629602	\$ 230.00
12 1440, 1460	Grain Tank Unloader Drive	AM191290C1	\$ 75.00
12 1480	Grain Tank Unloader Drive	AM191291C1	\$ 92.00
13 1440, 1460	Hyd Reel Drive, 47" Feeder w/o Trap	AM197411C1	\$ 67.00
13 1440, 1460 - w/ Rock Trap, 1480	Hydraulic Reel Drive	AM1315315C1	\$ 39.00
13 1440, 1460, 1480	Hyd Reel Drive, 54.50" Feeder w/o Trap	AM197414C2	\$ 89.00
13 1480	Hyd Reel Drive, 60" Feeder w/o Trap	AM197480C2	\$ 85.00
13 1480	Feeder Drive, w/ Rock Trap	AM1315074C1	\$ 258.00
14 1480	Rotor Drive, Variable	AM244422A1	\$ 315.00
14 1440, 1460	Rotor Drive, Variable	AM244420A1	\$ 305.00
15 1440, 1460	Separator Drive	AM191241C3	\$ 295.00
15 1480	Separator Drive	AM191244C1	\$ 203.00
16 1440 ASN 20715, 1460 ASN 23250	Straw Chopper Drive	AM181012C1	\$ 90.00
16 1480 ASN 24001	Straw Chopper Drive	AM181013C1	\$ 69.58
17 1440 BSN 20715, 1460 BSN 23250, 1480 BSN 24001	Straw Spreader Drive	AM153359C1	\$ 49.00
17 1440 ASN 20715, 1460 ASN 23250, 1480 ASN 24001	Straw Spreader Drive	AM196371C1	\$ 65.00

Case IH®—Combine

Belts—1620

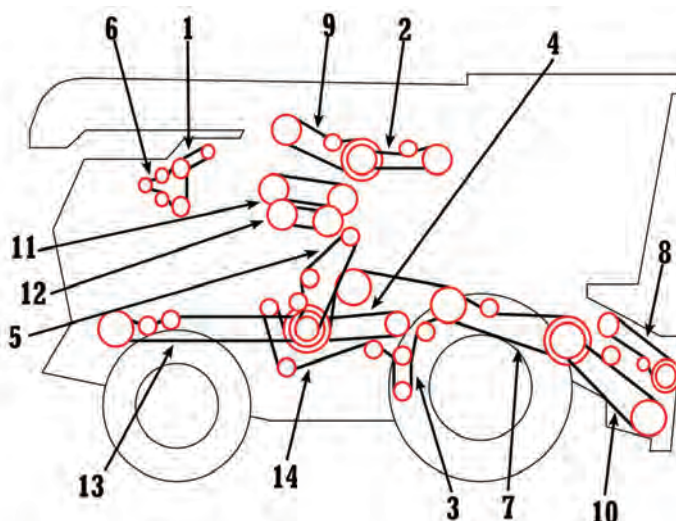

Application	Description	Part Number	Retail Price
1 1620	A/C Compressor	AM396829R1	\$ 6.84
2 1620	Auxiliary Pump Drive	AM1970115C1	\$ 46.70
3 1620	Cleaning Fan Drive	AM599060R1	\$ 56.29
4 1620	Cleaning Fan Jackshaft	AM191305C1	\$ 61.00
5 1620	Elevator Drive, w/ Straw Chopper	AM186509C2	\$ 195.00
6 1620	Engine Fan & Alternator	AMJ911574	\$ 31.81
7 1620	Feeder Drive, w/o Rock Trap	AM192738C1	\$ 200.00
7 1620	Feeder Drive, w/ Rock Trap	AM1315169C1	\$ 201.00
8 1620	Feeder Jackshaft Drive, 47" Feederhouse	AM1313095C2	\$ 170.00
8 1620	Feeder Jackshaft Drive, 54.50" Feederhouse	AM1313094C3	\$ 148.00
9 1620	Grain Tank Unloader Drive	AM191290C1	\$ 75.00
10 1620	Reel Pump Drive, 47"	AM1979606C1	\$ 35.00
10 1620	Reel Pump Drive, 54.50"	AM1330311C1	\$ 24.50
11 1620	Rotor Variable Drive	AM1302174C1	\$ 238.38
12 1620	Separator Drive	AM191241C3	\$ 295.00
13 1620	Straw Chopper Drive	AM1315265C1	\$ 67.00
14 1620	Straw Spreader Drive	AM196371C1	\$ 65.00

Case IH®—Combine

Belts—1640, 1660, 1680

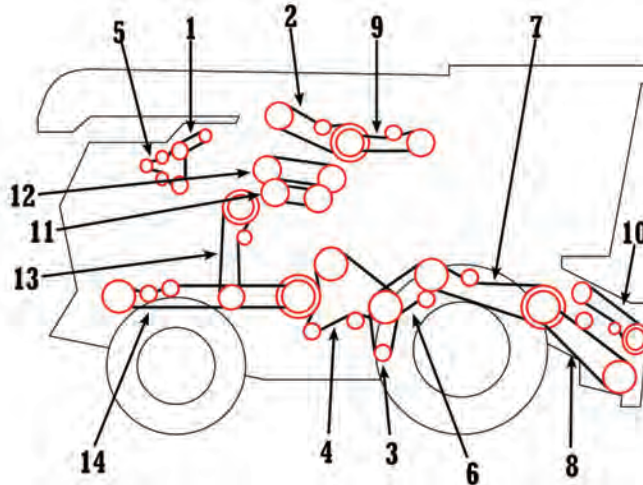

Application	Description	Part Number	Retail Price
1 1640, 1660, 1680	A/C Compressor	AM396829R1	\$ 6.84
2 1640, 1660	Auxiliary Pump Drive	AM1970115C1	\$ 46.70
2 1680 BSN JJC0045689	Auxiliary Pump Drive	AM191288C2	\$ 47.00
2 1680 SN JJC0045689-JJC0115352	Auxiliary Pump Drive	AM1970116C1	\$ 61.00
2 1680 ASN JJC0115352	Auxiliary Pump Drive	AM440498A3	\$ 98.00
3 1640, 1660, 1680	Cleaning Fan Drive	AM195396C2	\$ 61.00
4 1640, 1660, 1680	Elevator Drive, w/ Straw Chopper	AM181055C1	\$ 170.00
4 1640, 1660, 1680	Elevator Drive, w/ Discharge Beater	AM186509C2	\$ 195.00
5 1640 w/ IHC 400 Series Engine	Engine Fan and Alternator	AM537072R92	\$ 20.00
5 1640 w/ Cummins® Engines	Engine Fan and Alternator	AMJ911562	\$ 33.25
5 1660, 1680	Engine Fan and Alternator	AMJ911574	\$ 31.81
6 1640, 1660	Fan Jackshaft Drive	AM191305C1	\$ 61.00
6 1680	Fan Jackshaft Drive	AM317904A1	\$ 77.00
7 1640, 1660	Feeder Drive, w/o Rock Trap	AM192738C1	\$ 200.00
7 1640, 1660	Feeder Drive, w/ Rock Trap	AM1315168C1	\$ 215.00
7 1680	Feeder Drive, w/o Rock Trap	AM194528C1	\$ 285.00
7 1680	Feeder Drive, w/ Rock Trap	AM1315074C1	\$ 258.00
8 1660	Feeder Jackshaft Drive, 47" Feeder	AM1313095C2	\$ 170.00
8 1660, 1680	Feeder Jackshaft Drive, 54.50" Feeder	AM87629602	\$ 230.00
8 1680	Feeder Jackshaft Drive, 60" Feeder	AM393750A1	\$ 307.00
9 1640, 1660 BSN 102897	Grain Tank Unloader Drive	AM191290C1	\$ 75.00
9 1680 BSN JJC0115352	Grain Tank Unloader Drive	AM191291C1	\$ 92.00
9 1680 ASN JJC0115352	Grain Tank Unloader Drive	AM1989217C1	\$ 94.00
10 (1640, 1660 SN 34860-97170)	Reel Pump Drive, 47"	AM1979606C1	\$ 35.00
10 (1640, 1660 SN 34860-97170), 1680	Reel Pump Drive, 54.50"	AM1330311C1	\$ 24.50
10 (1640, 1660 BSN 34860 & ASN 97171)	Reel Pump Drive, 47"	AM1321564C1	\$ 39.00
10 (1640, 1660 BSN 34860 & ASN 97171), 1680 BSN 46598 & ASN 115001	Reel Pump Drive, 54.50"	AM1321565C1	\$ 52.00
10 1680 BSN 46598 & ASN 115001	Reel Pump Drive, 60"	AM1315226C1	\$ 33.19
10 1680	Reel Pump Drive, 54.50"	AM1979607C1	\$ 25.25
11 1640, 1660	Rotor Drive	AM244420A1	\$ 305.00
11 1680	Rotor Drive	AM244422A1	\$ 315.00
12 1640, 1660	Separator Drive	AM191241C3	\$ 295.00

Case IH®—Combine

Application	Description	Part Number	Retail Price
12 1680	Separator Drive	AM1330499C1	\$ 160.00
13 1640, 1660	Straw Chopper Drive	AM1315265C1	\$ 67.00
13 1640, 1660, 1680	Straw Chopper Drive	AM1315266C1	\$ 87.00
14 1640, 1660, 1680	Straw Spreader Drive	AM196371C1	\$ 65.00

Belts—1644, 1666, 1688, 2144, 2166, 2188

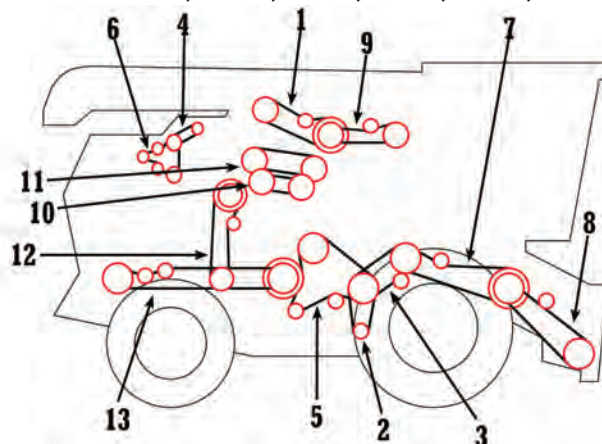

Application	Description	Part Number	Retail Price
1 2188	Auxiliary Pump Drive	AM124573A1	\$ 74.00
1 1644	Auxiliary Pump Drive	AM1347387C1	\$ 71.00
1 1666	Auxiliary Pump Drive	AM1541699C1	\$ 65.00
1 1688, 2144	Auxiliary Pump Drive	AM1541700C1	\$ 76.00
2 1644, 1666, 1688, 2144, 2166, 2188	Cleaning Fan Drive	AM1541569C1	\$ 62.00
3 1688, 2188	Cleaning Fan Jackshaft Drive	AM317904A1	\$ 77.00
3 1644, 1666, 2166	Cleaning Fan Jackshaft Drive	AM191305C1	\$ 61.00
4 1644, 2144	Compressor, AC	AM1250587C1	\$ 11.40
4 1666, 1688, 2166, 2188	A/C Compressor	AM396829R1	\$ 6.84
5 1644, 1666, 1688, 2144, 2166, 2188	Elevator Drive, w/ Chopper	AM181055C1	\$ 170.00
5 1644, 1666, 1688, 2144, 2166, 2188	Elevator Drive, w/ Discharge Beater	AM186509C2	\$ 195.00
6 1644, 2144	Fan, Alternator, Water Pump	AMJ911565	\$ 34.00
6 1666, 1688, 2166, 2188	Fan, Alternator, Water Pump	AMJ911572	\$ 49.00
7 1688, 2188	Feeder Drive, w/ Rock Trap	AM1315074C1	\$ 258.00
7 1644, 1666, 2144, 2166	Feeder Drive, w/ Rock Trap	AM1315168C1	\$ 215.00
7 1644, 1666, 2144, 2166	Feeder Drive, w/o Rock Trap	AM192738C1	\$ 200.00
7 1688, 2188	Feeder Drive, w/o Rock Trap	AM194528C1	\$ 285.00
8 1644, 1666	Feeder Jackshaft Drive, 47" Feeder	AM1313095C2	\$ 170.00
8 1644, 1666, 1688, 2144, 2166, 2188	Feeder Jackshaft Drive, 54.50" Feeder	AM87629602	\$ 230.00
8 1688, 2144, 2166, 2188	Feeder Jackshaft Drive, 60" Feeder	AM393750A1	\$ 307.00
9 1644, 1666	Grain Tank Unloader Drive	AM1989216C1	\$ 81.00
9 1688, 2188	Grain Tank Unloader Drive	AM1989217C1	\$ 94.00
10 1644, 1666, 2144, 2166	Rotor Drive, Variable	AM244420A1	\$ 305.00
10 1688, 2188	Rotor Drive	AM244422A1	\$ 315.00
11 1644, 1666, 2144, 2166	Separator Drive	AM191241C3	\$ 295.00
11 1688, 2188	Separator Drive	AM1541702C1	\$ 215.00
12 1644, 1666, 2144, 2166	Straw Chopper Drive	AM1315265C1	\$ 67.00

Prices Subject to Change without Prior Notice. The use of original equipment manufacturer (OEM) part numbers or trademarks, e.g. Case® and John Deere®, are for reference purposes only and for indicating product use and compatibility. Our company and the listed replacement parts contained herein are not sponsored, approved or manufactured by the OEM. All parts are New unless designated Reman in the description.

Case IH®—Combine

Application	Description	Part Number	Retail Price
12 1688, 1688, 2144, 2166, 2188	Straw Chopper Drive	AM1315266C1	\$ 87.00
13 1644, 1666, 1688, 2144, 2166, 2188	Straw Spreader Drive	AM196371C1	\$ 65.00

Belts—2344, 2366, 2377, 2388, 2577, 2588

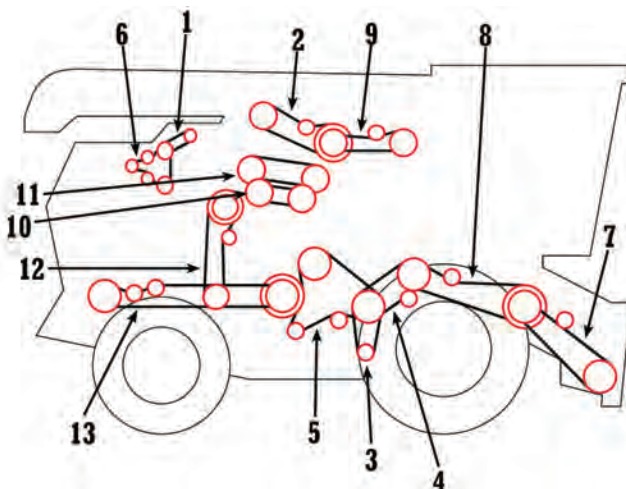

Application	Description	Part Number	Retail Price
1 2344	A/C Compressor	AM164550R2	\$ 13.25
1 2366 BSN JJC0255699, 2388 BSN JJC272999	A/C Compressor	AM396829R1	\$ 6.84
1 2366 ASN JJC0255700, 2377, 2388 ASN JJC0273000, 2388 SN HAJ292001-HAJ300000	A/C Compressor	AM235414A1	\$ 12.64
1 2388 ASN HAJ300001, 2577, 2588	A/C Compressor	AM87311867	\$ 14.30
2 2344	Auxiliary Pump Drive	AM1541700C1	\$ 76.00
2 2366	Auxiliary Pump Drive	AM124572A1	\$ 85.00
2 2377, 2388 ASN JJC0273000, 2388 ASN HAJ292001, 2577, 2588	Auxiliary Pump Drive	AM440498A3	\$ 98.00
3 2344, 2366 BSN JJC0184544, 2388 BSN JJC0198068	Cleaning Fan Drive	AM1541569C1	\$ 62.00
3 2366 ASN JJC0184544, 2377, 2388 ASN HAJ292001 & ASN JJC0198068, 2577, 2588	Cleaning Fan Drive	AM301146A1	\$ 43.00
4 2344, 2366 BSN JJC0184544	Cleaning Fan Jackshaft Drive	AM191305C1	\$ 61.00
4 2366 ASN JJC0184544	Cleaning Fan Jackshaft Drive	AM301111A1	\$ 51.00
4 2377, 2388, 2577, 2588	Cleaning Fan Jackshaft Drive	AM317904A1	\$ 77.00
5 2344, 2366, 2377, 2388, 2577, 2588	Elevator Drive, w/o Straw Chopper	AM186509C2	\$ 195.00
5 2344, 2366, 2377, 2388, 2577, 2588	Elevator Drive, w/ Straw Chopper	AM181055C1	\$ 170.00
6 2344	Engine Fan and Alternator	AMJ911565	\$ 34.00
6 2366 BSN JJC0255700, 2388 BSN JJC0273000	Engine Fan and Alternator	AMA77938	\$ 25.24
6 2366 ASN JJC0255700, 2377, 2388 ASN JJC0273000 & ASN HAJ292001, 2577, 2588	Engine Fan and Alternator Replaces A78022	AM87755884	\$ 27.79
7 2344, 2366, 2388 BSN JJC0268800	Feeder Jackshaft Drive, 54.50" Feeder	AM87629602	\$ 230.00
7 2344, 2366, 2388 BSN JJC0268800	Feeder Jackshaft Drive, 60" Feeder	AM393750A1	\$ 307.00
7 2377, 2388 ASN JJC026880, 2388 ASN HAJ292001, 2577, 2588	Feeder Jackshaft Drive, 54.50" Feeder	AM402370A1	\$ 245.00
7 2377, 2388 ASN JJC026880, 2388 ASN HAJ292001, 2577, 2588	Feeder Jackshaft Drive, 60" Feeder	AM402368A1	\$ 235.00
8 2344, 2366	Feeder Drive w/o Rock Trap	AM192738C1	\$ 200.00
8 2344, 2366	Feeder Drive, w/ Rock Trap	AM1315168C1	\$ 215.00

Case IH®—Combine

Application	Description	Part Number	Retail Price
8 2377, 2388, 2577, 2588	Feeder Drive w/o Rock Trap	AM194528C1	\$ 285.00
8 2377, 2388, 2577, 2588	Feeder Drive, w/ Rock Trap	AM1315074C1	\$ 258.00
9 2344, 2366	Grain Tank Unloader Drive	AM191290C1	\$ 75.00
9 2377, 2388, 2577, 2588	Grain Tank Unloader Drive	AM1989217C1	\$ 94.00
10 2344, 2366	Rotor Drive	AM244420A1	\$ 305.00
10 2377 BSN HAJ0295001, 2388 SN JJC0273001-HAJ02955001	Rotor Drive	AM413159A1	\$ 317.28
10 2388 BSN JJC0273000	Rotor Drive	AM244423A1	\$ 375.00
10 2377 ASN HAJ0295001, 2388 ASN JJC0295001, 2577, 2588	Rotor Drive Replaces 87301455	AM84194650	\$ 307.00
11 2344, 2366	Separator Drive	AM191241C3	\$ 295.00
11 2377, 2388 ASN JJC0270500, 2388 ASN HAJ292001, 2577, 2588	Separator Drive	AM400427A1	\$ 295.00
11 2388 BSN JJC0270500	Separator Drive	AM1541702C1	\$ 215.00
12 2344, 2366	Straw Chopper Drive	AM1315265C1	\$ 67.00
12 2344, 2377, 2388, 2577, 2588	Straw Chopper Drive	AM1315266C1	\$ 87.00
13 2344, 2366, 2377, 2388, 2577, 2588	Straw Spreader	AM196371C1	\$ 65.00

Belts—5088, 6088, 7088

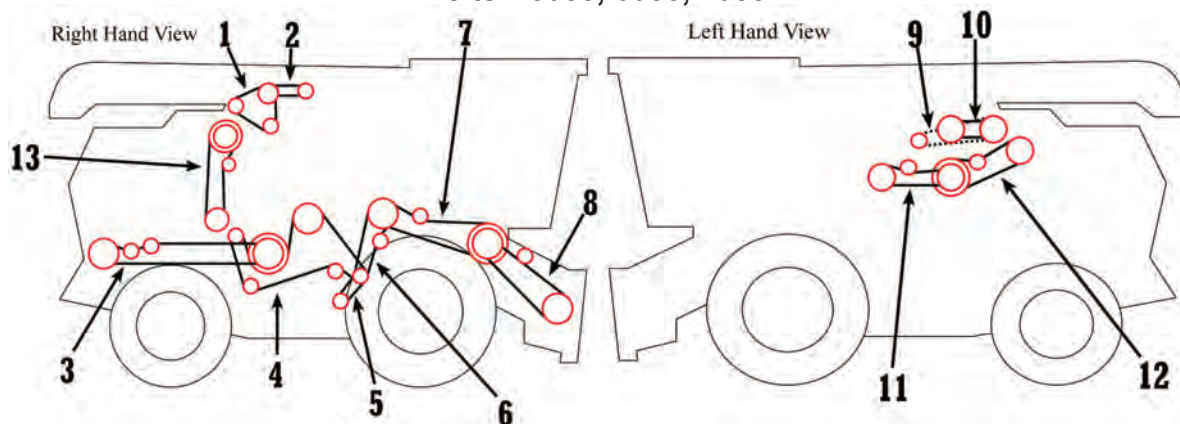

Application	Description	Part Number	Retail Price
1 5088, 6088, 7088	Fan Drive Replaces A78022	AM87755884	\$ 27.79
2 5088, 6088, 7088	A/C Compressor	AM87311867	\$ 14.30
3 5088, 6088, 7088	Straw Spreader Drive Replaces 87608414	AM84163222	\$ 67.00
4 5088, 6088, 7088	Cleaning System Drive, w/ Beater	AM186509C2	\$ 195.00
4 5088, 6088, 7088	Cleaning System Drive, w/ Straw Chopper	AM181055C1	\$ 170.00
5 5088, 6088, 7088	Cleaning Fan Drive	AM301146A1	\$ 43.00
6 5088, 6088, 7088	Fan Jackshaft Drive	AM87642957	\$ 49.00
7 5088, 6088, 7088 - w/ Rock Trap	Feederhouse Drive	AM87629601	\$ 240.00
7 5088, 6088, 7088 - w/o Rock Trap	Feederhouse Drive	AM87629602	\$ 230.00
8 5088, 6088, 7088 - w/ Rock Trap	Header Drive	AM87332159	\$ 195.00
8 5088, 6088, 7088 - w/o Rock Trap	Header Drive	AM87332161	\$ 195.00
9 5088, 6088, 7088	Separator Drive	AM84137716	\$ 236.00
10 5088	Rotor Drive	AM413159A1	\$ 317.28

Prices Subject to Change without Prior Notice. The use of original equipment manufacturer (OEM) part numbers or trademarks, e.g. Case® and John Deere®, are for reference purposes only and for indicating product use and compatibility. Our company and the listed replacement parts contained herein are not sponsored, approved or manufactured by the OEM. All parts are New unless designated Reman in the description.

Case IH®—Combine

Application	Description	Part Number	Retail Price
10 5088, 6088, 7088	Rotor Drive Replaces 87301455	AM84194650	\$ 307.00
10 6088, 7088	Rotor Drive	AM87615553	\$ 363.50
11 5088	Unloader Drive	AM87566055	\$ 64.00
11 6088, 7088	Unloader Drive	AM87549557	\$ 130.00
12 5088, 6088, 7088	Auxiliary Pump Drive	AM87330894	\$ 90.00
12 5088, 6088, 7088	Auxiliary Pump Drive Replaces 87549556	AM87283315	\$ 118.00
13 5088, 6088, 7088	Straw Chopper Drive	AM87330903	\$ 80.00
13 6088	Straw Chopper Drive	AM1315266C1	\$ 87.00

Belts—5130, 6130, 7130

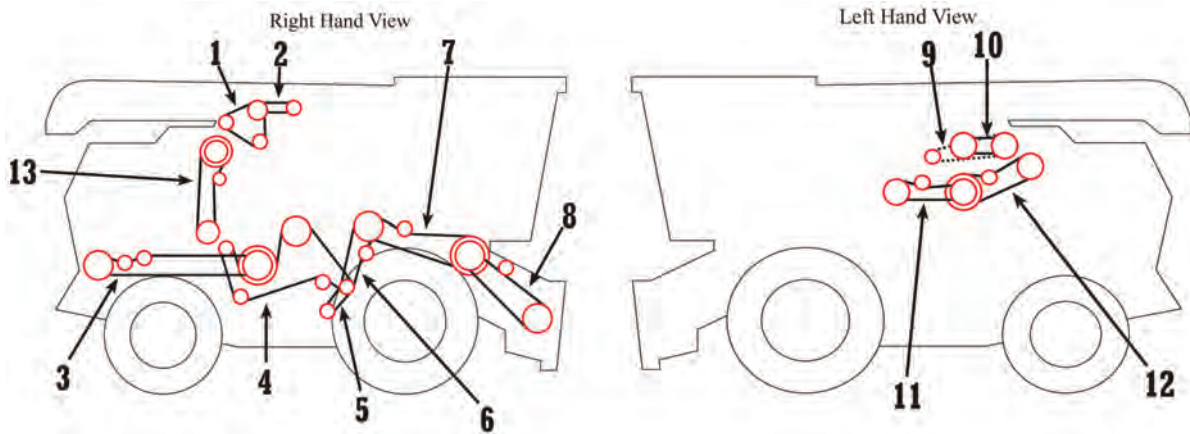

Application	Description	Part Number	Retail Price
1 5130, 6130, 7130	Engine Fan Drive	AM84150266	\$ 31.65
2 5130, 6130, 7130	A/C Compressor	AM84292913	\$ 39.50
2 5130	A/C Compressor	AM87489502	\$ 17.76
3 5130, 6130, 7130	Straw Spreader Drive Replaces 87608414	AM84163222	\$ 67.00
4 5130, 6130, 7130	Cleaning System Drive, w/ Beater	AM186509C2	\$ 195.00
4 5130, 6130, 7130	Cleaning System Drive, w/ Straw Chopper	AM181055C1	\$ 170.00
5 5130, 6130, 7130	Fan Jackshaft Drive, Lower	AM301146A1	\$ 43.00
6 5130, 6130, 7130	Fan Jackshaft Drive, Upper	AM87642957	\$ 49.00
7 5130, 6130, 7130 - w/ Rock Trap	Feederhouse Drive	AM87629601	\$ 240.00
7 5130, 6130, 7130 - w/o Rock Trap	Feederhouse Drive	AM87629602	\$ 230.00
8 5130, 6130, 7130 - w/ Rock Trap	Header Drive, Single Speed	AM87332161	\$ 195.00
8 5130, 6130, 7130 - w/ Rock Trap	Header Drive, 2-Speed	AM87332159	\$ 195.00
8 5130, 6130, 7130 - w/o Rock Trap	Header Drive	AM84365262	\$ 308.00
9 5130, 6130, 7130	Separator Drive 4 Banded Belt Replaces 84406044	AM84586129	\$ 293.00
10 5130	Rotor Drive	AM413159A1	\$ 317.28
10 5130, 6130, 7130 - w/ Common Cab	Rotor Drive	AM87615553	\$ 363.50
11 5130, 6130, 7130	Unloader Drive	AM87566055	\$ 64.00
11 6130, 7130	Unloader Drive	AM87549557	\$ 130.00

Case IH®—Combine

Application	Description	Part Number	Retail Price
12 5130, 6130, 7130 - w/ Common Cab	Unloader Drive Mid Jackshaft, Left Hand Replaces 84149661	AM84548651	\$ 108.50
13 5130, 6130, 7130	Straw Chopper Drive	AM87330903	\$ 80.00
NI 5130	Alternator	AM84312027	\$ 28.55
NI 5130, 6130, 7130	Air Screen Drive	AM87583785	\$ 14.64

Belts—5140, 6140, 7140

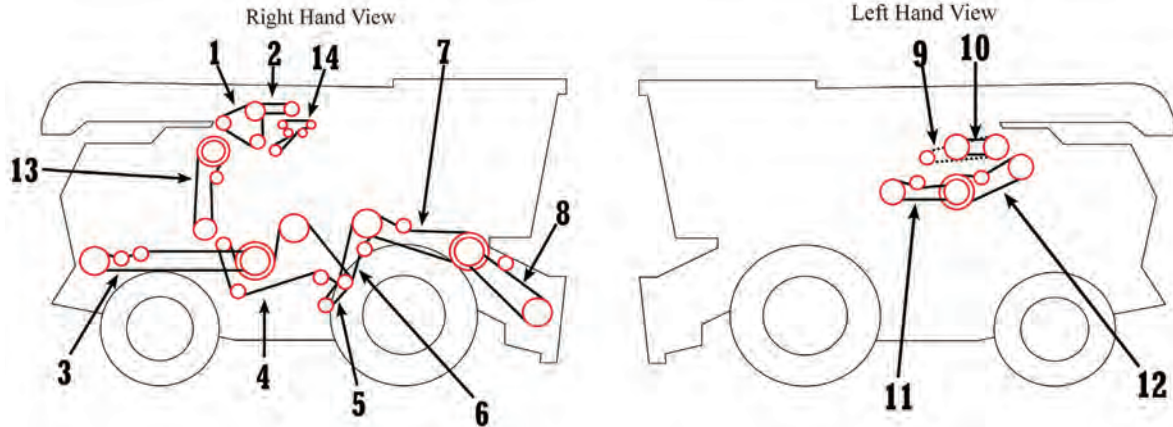

Application	Description	Part Number	Retail Price
1 5140, 6140, 7140 - 03/2014-10/15	Engine Fan Drive Set of 2	AM84150266	\$ 31.65
2 5140, 6140, 7140	A/C Compressor	AM87489502	\$ 17.76
2 5140, 6140, 7140	A/C Compressor	AM84292913	\$ 39.50
3 (5140, 6140, 7140 - 03/2014-10/15)	Straw Spreader Drive Replaces 87608414	AM84163222	\$ 67.00
4 5140, 6140, 7140 (03/2014-10/15)	Cleaning System Drive, w/ Beater	AM186509C2	\$ 195.00
4 5140, 6140, 7140 (03/2014-10/2015)	Cleaning System Drive, w/ Straw Chopper	AM181055C1	\$ 170.00
4 (5140, 6140, 7140 10/2015 ASN YFG014001), (5150, 6150, 7150 - Prior to 2021)	Cleaning System Drive	AM84230076	\$ 135.55
5 5140, 6140, 7140 (03/2014-10/15)	Cleaning Fan Drive	AM301146A1	\$ 43.00
6 5140, 6140, 7140	Cleaning Fan, Jackshaft	AM84230075	\$ 197.11
6 5140, 6140, 7140 (03/2014-10/15)	Cleaning Fan, Jackshaft	AM87642957	\$ 49.00
7 5140, 6140, 7140 - w/ Rock Trap	Feederhouse Drive	AM87629601	\$ 240.00
7 5140, 6140, 7140 - w/o Rock Trap	Feederhouse Drive	AM87629602	\$ 230.00
8 5140, 6140, 7140 BSN YEG012701 - w/ Rock Trap	Header Drive	AM87332161	\$ 195.00
9 5140, 6140, 7140	Separator Drive 4 Banded Belt Replaces 84406044	AM84586129	\$ 293.00
10 5140	Rotor Drive	AM413159A1	\$ 317.28
10 5140, 6140, 7140	Rotor Drive Replaces 87301455	AM84194650	\$ 307.00
10 5140 (Tier 4B), 6140, 7140	Rotor Drive	AM87615553	\$ 363.50
11 5140, 6140, 7140	Unloader Drive	AM87566055	\$ 64.00
11 5140, 6140, 7140	Unloader Drive	AM87549557	\$ 130.00
12 5140, 6140, 7140 - 03/2014-10/15 w/ Tier 4B Engine	Unloader Drive Mid Jackshaft, Left Hand Replaces 84149661	AM84548651	\$ 108.50

Case IH®—Combine

Application	Description	Part Number	Retail Price
13 5140, 6140, 7140	Straw Chopper Drive	AM87330903	\$ 80.00
14 5140, 6140, 7140	Alternator	AM84312027	\$ 28.55
NI 5140, 7140	Beater Drive	AM47655498	\$ 51.94
NI 5140, 6140, 7140	Air Screen Drive, Stationary	AM87583785	\$ 14.64

Belts—5150, 6150, 7150

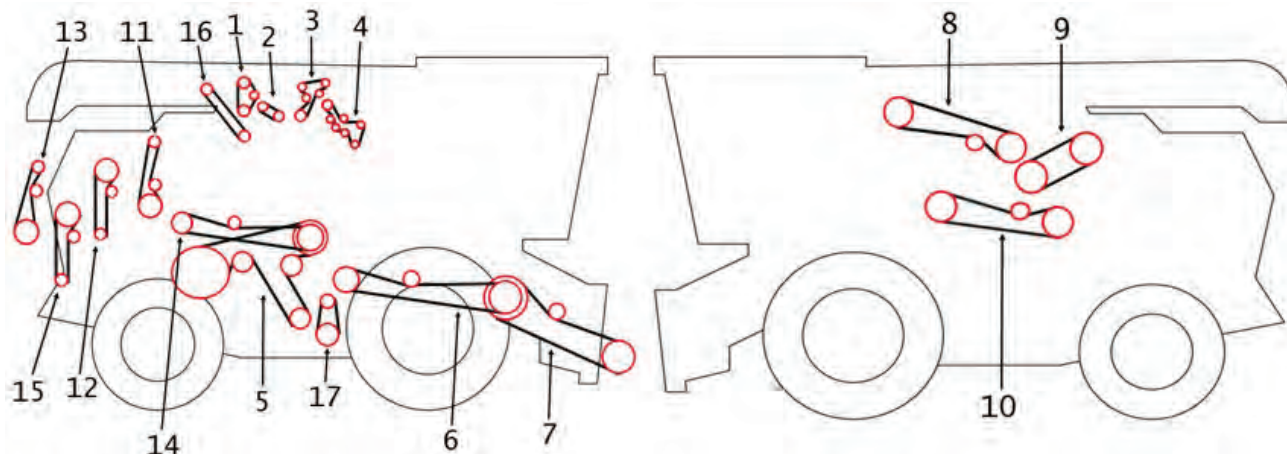

Application	Description	Part Number	Retail Price
1 5150, 6150, 7150	Engine Fan Drive	AM47708569	\$ 42.00
2 5150	A/C Compressor	AM87489502	\$ 17.76
3 5150	Alternator	AM84312027	\$ 28.55
4 6150, 7150	A/C Compressor	AM84292913	\$ 39.50
5 5150, 6150, 7150 - Prior to 2021	Cleaning System Drive	AM84230076	\$ 135.55
6 5150, 6150, 7150 - w/ Rock Trap	Feederhouse Drive	AM87629601	\$ 240.00
6 5150, 6150, 7150 - w/o Rock Trap	Feederhouse Drive	AM87629602	\$ 230.00
7 5150, 6150, 7150 - w/ Rock Trap	Header Drive	AM47455617	\$ 233.00
7 5150, 6150, 7150 - w/o Rock Trap	Header Drive	AM47616842	\$ 401.00
8 5150, 6150, 7150	Separator Drive 4 Banded Belt Replaces 84406044	AM84586129	\$ 293.00
9 5150	Rotor Drive	AM413159A1	\$ 317.28
9 5150 (Tier 3), 6150, 7150	Rotor Drive	AM87615553	\$ 363.50
10 5150, 6150, 7150	Unloader Drive	AM47360559	\$ 200.00
11 5150, 6150, 7150	Straw Chopper Flail Drive, Low Speed	AM47920775	\$ 119.48
12 5150, 6150, 7150	Straw Chopper Flail Drive, High Speed	AM47597575	\$ 129.00
13 5150, 6150, 7150	Beater Drive	AM47655498	\$ 51.94
14 5150, 6150, 7150	Elevator Jackshaft Drive	AM84230075	\$ 197.11
15 5150, 6150, 7150	Straw Chopper Drive	AM87330903	\$ 80.00
16 5150, 6150, 7150	Air Screen	AM87583785	\$ 14.64
17 5150, 6150, 7150	Variable Cleaning Fan	AM84238446	\$ 44.50

Case IH®—Combine

Belts—7010, 7120, 8010, 8120, 9120

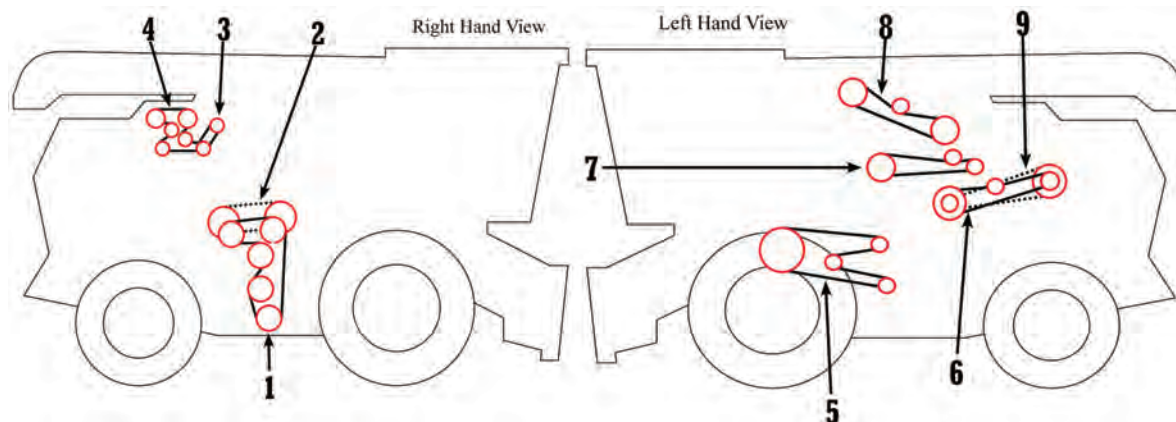

Application	Description	Part Number	Retail Price
1 7010, 7120, 8010 ASN HAJ105207, 8120, 9120	Tailings Drive	AM87283139	\$ 73.00
1 8010 BSN HAJ105207	Tailings Drive	AM87109130	\$ 98.00
2 7010, 7120, 8010, 8120, 9120	Bubble Up Drive, Right Hand	AM86975809	\$ 63.00
3 7010, 7120	Fan Drive	AM87526140	\$ 19.75
3 7010, 7120, 8010, 8120, 9120	Fan Drive	AM500371653	\$ 38.00
3 8010, 8120	Fan Drive	AM87282305	\$ 39.50
3 9120	Fan Drive	AM504049425	\$ 63.52
4 7010, 7120, 8010, 8120, 9120	A/C, Alternator and Water Pump	AM504212528	\$ 18.53
4 8010, 8120	A/C, Alternator and Water Pump	AM87282333	\$ 20.00
5 7010, 7120, 8010, 8120, 9120	Shoe Drive	AM87317063	\$ 47.00
6 7010, 7120, 8010, 8120, 9120	Beater Drive 3 Banded Belt Replaces 48114650	AM86517680	\$ 107.00
7 7010, 7120, 8010, 8120, 9120	Unloader Drive 2 Banded Belt	AM87011585	\$ 92.00
8 7010, 7120, 8010, 8120, 9120	Bubble Up Drive, Left Hand	AM86975809	\$ 63.00
9 7010, 7120, 8010 BSN JAH202001, 8120, 9120 - w/ 2800 RPM	Straw Chopper Drive, Inner Replaces 87549556	AM87283315	\$ 118.00
9 (7010, 8010 ASN HAJ202001), 7120, 8120, 9120 - w/ 3000 RPM	Straw Chopper Drive, Inner	AM86976208	\$ 110.00
NI 7120	A/C Drive Replaces 87592007, 504368979	AM84238514	\$ 11.50
NI 7010, 8010, 8120	Alternator	AM504049425	\$ 63.52
NI 7010, 7120, 8010, 8120	Rotary Screen (Lower)	AM87607871	\$ 16.00
NI 7010, 8010, 9120	Rotary Screen (Lower)	AM87733431	\$ 15.84
NI 7120, 8010, 8120	Rotary Screen (Upper)	AM86514512	\$ 30.00
NI 9120	Rotary Screen (Upper)	AM9842161	\$ 54.00

Case IH®—Combine

Belts—7230, 8230, 9230

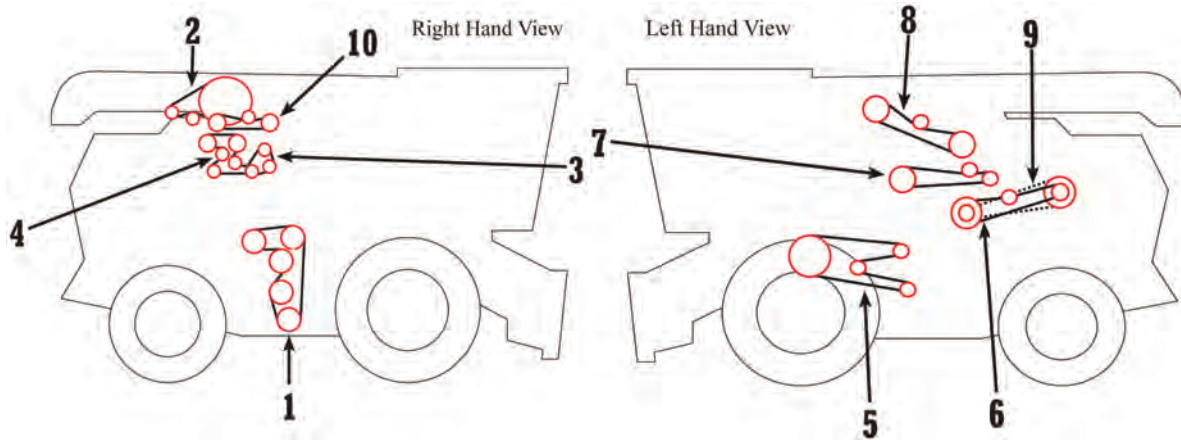

Application	Description	Part Number	Retail Price
1 7230, 8230, 9230	Tailings Drive	AM87283139	\$ 73.00
2 7230, 9230	Rotary Screen (Upper)	AM86514512	\$ 30.00
2 7230, 8230, 9230	Rotary Screen (Upper)	AM9842161	\$ 54.00
3 7230, 8230, 9230	Fan Drive	AM87526140	\$ 19.75
3 8230, 9230	Fan Drive	AM47490848	\$ 29.96
4 7230, 8230, 9230	Engine Belt Replaces 47452304	AM84292639	\$ 20.00
4 8230, 9230	A/C Drive Replaces 87592007, 504368979	AM84238514	\$ 11.50
4 8230, 9230	Alternator	AM504049425	\$ 63.52
5 7230, 8230, 9230	Shoe Drive	AM87317063	\$ 47.00
6 7230, 8230, 9230	Beater Drive 3 Banded Belt Replaces 48114650	AM86517680	\$ 107.00
7 7230, 8230, 9230	Unloader Drive, Standard 3 Banded Belt	AM84376860	\$ 95.00
7 7230, 8230, 9230	Unloader Drive, Dual Drive	AM84345673	\$ 50.00
7 7230, 8230, 9230	Unloader Drive, Dual Drive 2 Banded Belt	AM84345674	\$ 74.00
8 7230, 8230, 9230	Bubble Up Auger Drive	AM86975809	\$ 63.00
9 7230, 8230, 9230	Straw Chopper Drive, Inner	AM86976208	\$ 110.00
10 7230, 8230, 9230	Rotary Screen (Lower)	AM87607871	\$ 16.00
10 7230, 8230, 9230	Rotary Screen (Lower)	AM87733431	\$ 15.84
NI 7230, 8230, 9230	Cleaning Fan Drive	AM87683178	\$ 30.00
NI 8230, 9230	Transmission Belt	AM504049425	\$ 63.52
NI 9230 w/ Common Cab 01/2013-09/14 w/o Rock Trap	Header Drive	AM84365262	\$ 308.00

Case IH®—Combine

Belts—7240, 8240, 9240

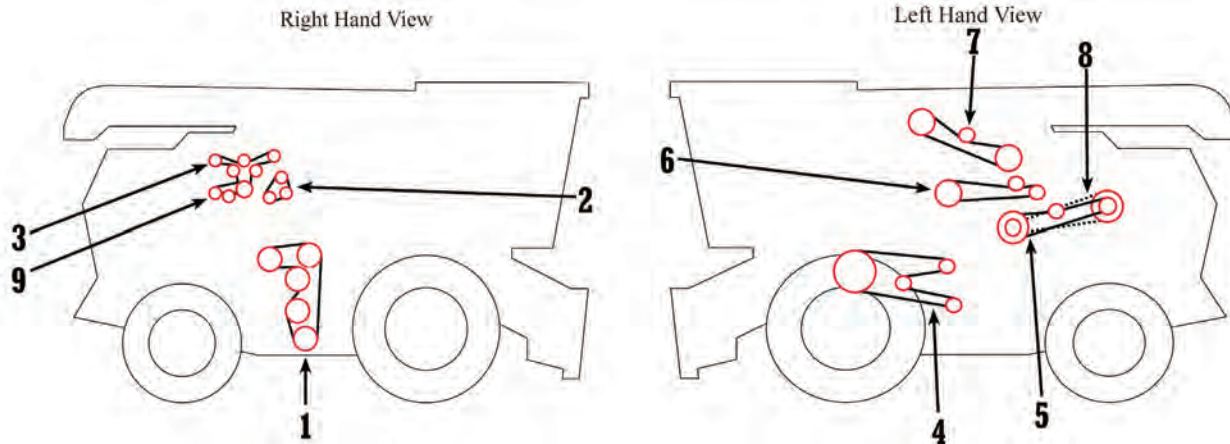

Application	Description	Part Number	Retail Price
1 7240, 8240, 9240	Tailings Drive	AM87283139	\$ 73.00
3 7240	Alternator	AM47506727	\$ 28.00
3 8240	Alternator	AM47513876	\$ 41.00
3 9240	Alternator	AM47569912	\$ 29.29
4 7240, 8240, 9240	Cleaning System	AM87317063	\$ 47.00
5 7240, 8240, 9240	Straw Chopper Drive, Outer 3 Banded Belt Replaces 48114650	AM86517680	\$ 107.00
8 7240, 8240, 9240 - MY18 w/ Redekop™ Straw Chopper	Straw Chopper Drive, Inner 135" Long	AM51407097	\$ 225.00
6 7240, 8240	Unloader Drive, Single Drive 3 Banded Belt	AM84376860	\$ 95.00
6 7240, 8240, 9240	Unloader Drive, Dual Drive	AM84345673	\$ 50.00
6 7240, 8240, 9240	Unloader Drive, Dual Drive 2 Banded Belt	AM84345674	\$ 74.00
7 7240, 8240, 9240	Clean Grain Elevator	AM86975809	\$ 63.00
8 7240, 8240, 9240	Straw Chopper Drive, Inner	AM86976208	\$ 110.00
8 7240, 8240, 9240 - w/ 3000 RPM	Straw Chopper Drive, Inner 3 Banded Belt	AM47705826	\$ 103.00
9 7240, 8240	A/C Compressor Replaces 87592007, 504368979	AM84238514	\$ 11.50

Case IH®—Combine

Belts—7250, 8250, 9250

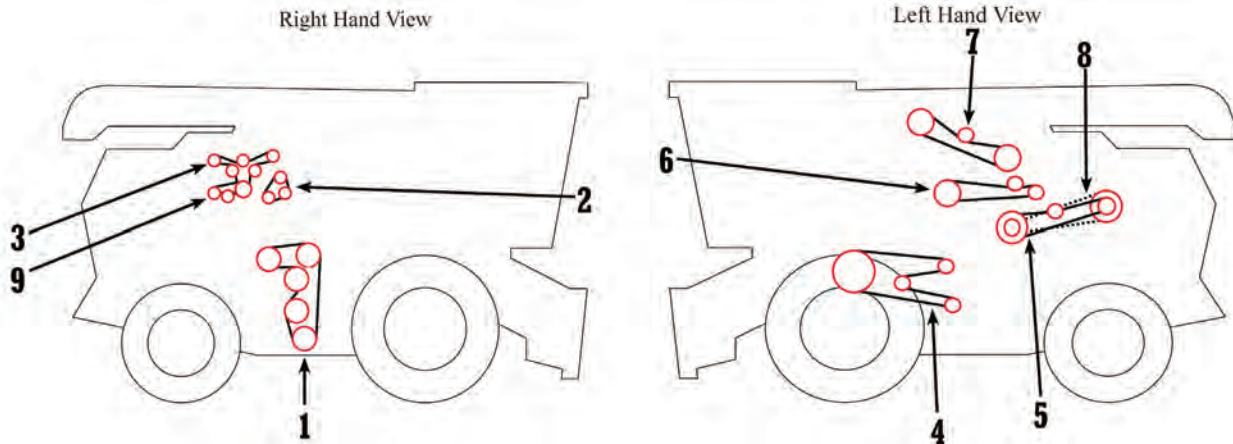

Application	Description	Part Number	Retail Price
1 7250, 8250, 9250	Tailings Processor	AM87283139	\$ 73.00
2 7250, 8250	Engine Fan Drive	AM47411931	\$ 44.69
3 7250	Alternator	AM47506727	\$ 28.00
3 8250	Alternator	AM47513876	\$ 41.00
3 9250	Alternator	AM47569912	\$ 29.29
4 7250, 8250, 9250	Cleaning System	AM87317063	\$ 47.00
5 7250, 8250, 9250	Straw Chopper Drive, Outer 3 Banded Belt Replaces 48114650	AM86517680	\$ 107.00
5 7250, 8250, 9250 - w/ Redekop™ Straw Chopper	Straw Chopper Drive, Outer 2 Banded Belt	AM48035443	\$ 176.00
6 7250, 8250, 9250	Unloader Drive 2 Banded Belt	AM87011585	\$ 92.00
6 7250, 8250, 9250	Unloader Drive, Single Drive 3 Banded Belt	AM84376860	\$ 95.00
6 7250, 8250, 9250	Unloader Drive, Dual Drive	AM84345673	\$ 50.00
6 7250, 8250, 9250	Unloader Drive, Dual Drive 2 Banded Belt	AM84345674	\$ 74.00
7 7250, 8250, 9250	Clean Grain Elevator	AM86975809	\$ 63.00
8 7250, 8250, 9250 - w/ 3000 RPM	Straw Chopper Drive, Inner 3 Banded Belt	AM47705826	\$ 103.00
8 7250, 8250, 9250 - w/ Redekop™ Straw Chopper	Straw Chopper Drive, Inner 135" Long	AM51407097	\$ 225.00
9 7250, 8250, 9250	A/C Compressor Replaces 87592007, 504368979	AM84238514	\$ 11.50
NI 7250, 8250, 9250	Fan Drive	AM87683178	\$ 30.00
NI 9250	Vacuum Fan	AM47623161	\$ 21.04

Case IH®—Combine

Belts—Cotton Pickers & Swathers

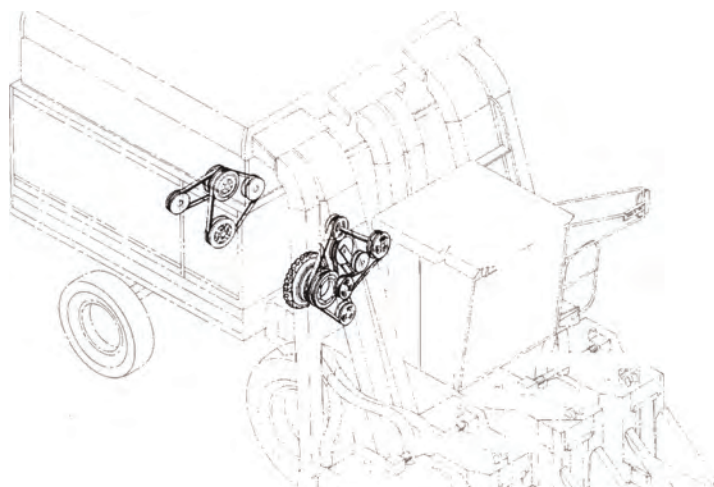

Application	Description	Part Number	Retail Price
782	Aux. Drum Drive	AM210185C1	\$ 61.50
782	Fan	AM214522C1	\$ 72.58
1822, 1844, 2022, 2044	Fan	AM1288899C5	\$ 112.00
2055, 2155	Fan Drive	AM1546117C2	\$ 117.00
420, 620, 625, 1844 ASN JJC002462, 2044, 2055, 2155, 2555, CPX420, CPX610, CPX620	Fan Drive, Front	AM1338328C1	\$ 78.00
420, 2555, CPX420, CPX610, CPX620 BSN Y6T0117	Fan Drive, Rear	AM1546117C2	\$ 117.00
782	Hyd. Pump	AM656349R1	\$ 8.90
1822, 1844, 2022, 2044	Hyd. Pump	AM1285320C1	\$ 65.18
420, 620, 625, 2055, 2155, 2555, CPX420, CPX610, CPX620	Auxiliary Pump Drive	AM1546118C1	\$ 77.00
1822, 1844, 2022, 2044	Middle Fan	AM1260258C2	\$ 44.50

Belts—Platforms

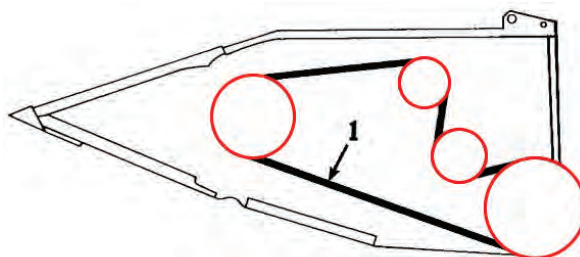

Application	Description	Part Number	Retail Price
1 1020	Platform Belt Replaces 1319245C1, 1319245C2, 1502461C1, 1866324R1	AM247428A1	\$ 76.50

Caterpillar® / Challenger®

Table of Contents

Air Conditioning and Components.....	614	Hydraulic Oil Cooler.....	608
Belts.....	608	Lighting.....	609
Cab Components—Miscellaneous.....	614	Rasp Bars.....	616
Cab Roof.....	614	Reel Components.....	617
Clear View Cap.....	616	Starters.....	608
Concaves and Components.....	616	Track Parts.....	615
Draper Belts.....	617	Tracks.....	615
Glass.....	614	Water Pumps.....	608
Guards.....	617		

Water Pumps

Application	Description	Part Number	Retail Price	Core
Challenger®: Utility: MT265, MT265B, MT275, MT275B, MT285	Water Pump Includes Mounting Gasket Replaces 3757045M92, 3757045M93	AM3757045M91	\$ 100.00	

Belts

Application	Description	Part Number	Retail Price	Core
Challenger® Tractor: PH13, PH15	Rear Pickup Belt, 18.75" x 57.75" w/ 1/4" Cleats, Bolt-On	AM31-100100-20	\$ 85.78	
Challenger® Combines: 660 ASN HR87101, 660B, 670, 670B, 680B	Rotary Screen	AM71396754	\$ 16.25	
Challenger® Combine: 670B (ASN BHC07101)	Alternator and Fan	AM71444986	\$ 36.00	

Starters

Application	Description	Part Number	Retail Price	Core
Challenger® Tractors: MT635B, MT645B, MT645C, MT645D, MT645E, MT655C, MT655D, MT655E, MT665C, MT665D, MT665E, MT675C, MT675D, MT675E, MT685C, MT685D, MT685E	Starter, 12 Volt HD Planetary Gear Reduction, 10 Tooth, 4.20 kW, CW Rotation Replaces 4288993M91, 4288993M92, 4288993M93	AM4288991M4	\$ 425.00	
Challenger® Tractors: MT745D, MT755D, MT765D, Combines: 520C, 540C, 670B	Starter, 12 Volt 11 Tooth, CW Rotation Replaces 84284540	AMV836873457	\$ 345.00	







Hydraulic Oil Cooler

Application	Description	Part Number	Retail Price	Core
Challenger® Tractors: MT735, MT745, MT755, MT765	Hydraulic Oil Cooler	AM203-5421	\$ 3375.00	









Caterpillar® / Challenger®

Lighting





	Application	Description	Part Number	Retail Price	Core
	Challenger®: MT425B, MT445B, MT455B, MT445D, MT465B, MT465D, MT475B, MT475D, MT485D, MT495D, MT515D, MT515E, MT525B, MT525D, MT535B, MT535D, MT545B, MT545D, MT545E, MT555B, MT555D, MT555E, MT565B, MT565D, MT565E, MT575B, MT575D, MT575E, MT585B, MT585D, MT585E, MT595B, MT595D, MT635B, MT645B, MT655B, MT665B	LED Conversion Light Rear Fender Mount 5.75" x 3.75" Oval Light 2900 Lumens, 35 Watts, 2.90 Amps For 12 Volt to 24 Volt Systems Includes Bracket and Connectors	AMTL5650	\$ 95.00	
		LED Conversion Light Rear Fender Mount 5.75" x 3.75" Oval Light 2900 Lumens, 35 Watts, 2.90 Amps For 12 Volt to 24 Volt Systems Includes Bracket and Connectors	AMAH207788	\$ 76.00	
		LED Conversion Light Front Handrail Mount 5.75" x 3.75" Oval Light 2900 Lumens, 35 Watts, 2.90 Amps For 12 Volt to 24 Volt Systems Includes Bracket and Connectors	AMTL5650	\$ 95.00	
		LED Conversion Light Front Handrail Mount 5.75" x 3.75" Oval Light 2900 Lumens, 35 Watts, 2.90 Amps For 12 Volt to 24 Volt Systems Includes Bracket and Connectors	AMAH207788	\$ 76.00	
	Caterpillar® Ind/Const: Most Models	Compact LED Wide Floodlight 4.25" x 4.50" x 3" Round Light 6900 Lumens, 50 Watts, 4.10 Amps 90° Flood Pattern For 9 Volt to 32 Volt Systems Includes Mounting Bracket and Stainless Steel Hardware	AMTL500WF	\$ 120.00	
	Universal Equipment	LED Wide Floodlight All-Position Light 5" x 7" Rectangle Light 3800 Lumens, 35 Watts For 12 Volt to 24 Volt Systems	AMX34171	\$ 60.00	
	Universal Equipment	LED Floodlight All-Position Light 4.25" x 4.25" Square Light 2650 Lumens, 48 Watts, 4 Amps For 12 Volt to 24 Volt Systems Includes Mounting Bracket and Stainless Steel Hardware	AMTL105F	\$ 95.00	
	Universal Equipment	LED Floodlight All-Position Light 6.25" x 1.75" Rectangle Light 1300 Lumens, 18 Watts, 1.50 Amps For 12 Volt to 24 Volt Systems Includes Mounting Bracket and Stainless Steel Hardware	AMTL118F	\$ 50.00	
	Universal Equipment	LED Floodlight All-Position Light 5" Round Light 3200 Lumens, 40 Watts, 3.30 Amps For 12 Volt to 24 Volt Systems Includes Mounting Bracket and Stainless Steel Hardware	AMTL180	\$ 89.00	

Caterpillar® / Challenger®

Caterpillar® / Challenger®

Application	Description	Part Number	Retail Price	Core
 Universal Equipment	LED Floodlight All-Position Light Round Light 6900 Lumens, 50 Watts, 4.10 Amps For 9 Volt to 32 Volt Systems Includes Mounting Bracket and Stainless Steel Hardware	AMTL500F	\$ 120.00	
	LED Floodlight All-Position Light 4.30" Round Light 5040 Lumens, 50 Watts, 4.10 Amps For 12 Volt to 24 Volt Systems Includes Stainless Steel Adjustable Mounting Bracket	AMAT305931	\$ 96.00	
 Universal Equipment	LED Floodlight All-Position Light 4.25" Round Light 2650 Lumens, 42 Watts, 3.50 Amps For 12 Volt to 24 Volt Systems Includes Mounting Bracket and Stainless Steel Hardware	AMTL115F	\$ 59.00	
 Universal Equipment	LED Floodlight, Sealed Beam Fender Mount 4.50" Diameter Round Light 1250 Lumens, 18 Watts, 1.50 Amps Trapezoid Pattern For 12 Volt to 24 Volt Systems	AMTL3010	\$ 40.00	
	LED Floodlight Fender Mount 4.50" Diameter Sealed Beam Round Light 1250 Lumens, 18 Watts, 1.20 Amps Trapezoid Pattern For 12 Volt to 24 Volt Systems Lasts 50 times longer than halogen lighting, vibration resistant w/ no filament failures, uses original mount and wiring, Operating temperature of -40°F to 140°F / -40°C to 60°C	AMRE336111	\$ 35.00	
 Universal Equipment	LED Floodlight Fender Mount 4.50" Diameter Sealed Beam Round Light 1440 Lumens, 18 Watts, 1.60 Amps Lasts 50 times longer than halogen lighting, vibration resistant w/ no filament failures, 2-terminal connection, Operating temperature of -40°F to 140°F / -40°C to 60°C	AMRE336112	\$ 67.75	
 Universal Equipment	LED Floodlight Cab and Fender Mount 3.50" x 6" Rectangle Light 3600 Lumens, 40 Watts, 3 Amps	AMX34146	\$ 65.00	
 Challenger® Tractors: MT635, MT645, MT655, MT665	LED Floodlight/Spotlight Combo Hood Mount 6" x 4" Rectangle Light Dual Hi/Lo Beam 3500 Lumens, 60 Watts, 5 Amps For 12 Volt to 24 Volt Systems Uses Original Mount and Wiring Includes Connector and Stainless Steel Hardware	AMTL6040	\$ 110.00	
 Universal Equipment	LED Spotlight All-Position Light 4.25" x 4.25" Square Light 1400 Lumens, 27 Watts, 2.20 Amps For 12 Volt to 24 Volt Systems	AMTL100S	\$ 45.00	

Caterpillar® / Challenger®

Application	Description	Part Number	Retail Price	Core
 Universal Equipment	LED Spotlight All-Position Light 6.25" x 1.75" Rectangle Light 1300 Lumens, 18 Watts, 1.50 Amps For 12 Volt to 24 Volt Systems Includes Mounting Bracket and Stainless Steel Hardware	AMTL118S	\$ 50.00	
 Universal Equipment	LED Spotlight All-Position Light Round Light 6900 Lumens, 50 Watts, 4.10 Amps For 9 Volt to 32 Volt Systems Includes Mounting Bracket and Stainless Steel Hardware	AMTL500S	\$ 120.00	
 Universal Equipment	LED Trapezoid Light Cab and Fender Mount 4.50" Diameter Round Light 2800 Lumens, 40 Watts, 3.30 Amps Trapezoid Pattern For 12 Volt to 24 Volt Systems Bottom Mount w/ Built-In Heat Sink Includes Mounting Bracket, Long and Short Rubber Bezels and Stainless Steel Hardware	AMTL2080	\$ 95.00	
	LED Trapezoid Light Cab and Rear Fender Mount 4.50" Diameter Round Light 2800 Lumens, 40 Watts, 3.30 Amps Trapezoid Pattern For 12 Volt to 24 Volt Systems Bottom Mount w/ Built-In Heat Sink Includes Mounting Bracket, Long and Short Rubber Bezels and Stainless Steel Hardware	AMX33121	\$ 76.00	
 Universal Equipment	LED Warning Light Cab, Header or Swather Mount Can be used for Turn Signal, Brake or Running Lights 4.125" Diameter Round Light Double Sided, Amber Lenses 25 Bulbs per Side For 12 Volt to 24 Volt Systems	AMTLFL2	\$ 55.00	
	LED Warning Light Cab, Header or Swather Mount Can be used for Turn Signal, Brake or Running Lights 4.125" Diameter Round Light Double Sided, Amber Lenses 25 Bulbs per Side For 12 Volt to 24 Volt Systems	AMX1910149	\$ 44.00	

Caterpillar® / Challenger®

	Application	Description	Part Number	Retail Price	Core
	Universal Equipment	LED Warning Light Cab, Header or Swather Mount Can be used for Turn Signal, Brake or Running Lights 4.125" Diameter Round Light Double Sided, Red and Amber Lenses 25 Bulbs per Side For 12 Volt to 24 Volt Systems	AMTLFL3	\$ 55.00	
		LED Warning Light Cab, Header or Swather Mount Can be used for Turn Signal, Brake or Running Lights 4.125" Diameter Round Light Double Sided, Red and Amber Lenses 25 Bulbs per Side For 12 Volt to 24 Volt Systems	AMX33126	\$ 44.00	
	Universal Equipment	LED Magnetic Warning Light All-Position Light 360° Flashing Light, Multiple Patterns 9.50" x 6.75" Rectangle Light Magnetic Base or Solid Mount For 12 Volt to 24 Volt Systems Includes Cigarette Lighter Adapter, Wiring and Switch	AMTL1100	\$ 170.00	
	Universal Equipment	LED Magnetic Warning Light All-Position Light 360° Flashing Light, Multiple Patterns 14" x 6.75" Rectangle Light Magnetic Base or Solid Mount For 12 Volt to 24 Volt Systems Includes Cigarette Lighter Adapter, Wiring and Switch	AMTL1200	\$ 190.00	
	Universal Equipment	Warning Beacon 360° Flashing Beacon, Amber Lens For 0.9435" Diameter Pipe Replaces 84337818, AZ44705, AZ101891	AM82018390	\$ 45.64	
	Universal Equipment	LED Warning Beacon 360° Flashing Beacon 2.75" x 5.25" Light Polycarbonate Amber Lens and Housing For 12 Volt to 24 Volt Systems Includes Solid Mounting Pad and Stainless Steel Hardware	AMTL2100	\$ 30.00	
	Universal Equipment	LED Warning Beacon 360° Flashing Beacon, 3 Different Patterns 5" x 10" Light Amber Lens, 48 Watts, 4 Amps For 12 Volt to 24 Volt Systems Brackets Sold Separately	AMX33131	\$ 75.00	
	Universal Equipment	Warning Beacon Bracket	AMX33132	\$ 15.00	
	Universal Equipment	Warning Beacon Bracket	AMX33133	\$ 15.00	

Caterpillar® / Challenger®

Application	Description	Part Number	Retail Price	Core
 Universal Equipment	Warning Beacon Bracket	AMX33137	\$ 15.00	
 Universal Equipment	Warning Beacon Bracket	AMX33135	\$ 15.00	
 Universal Equipment	LED Light Bar 4" Long, 1260 Lumens, Cree Bulbs	AMLED4	\$ 45.00	
	LED Light Bar Flood/Spotlight Combo 10" Long, 5700 Lumens, 50 Watts, 4.20 Amps For 12 Volt to 24 Volt Systems Includes Mounting Bracket and Stainless Steel Hardware	AMTL10SRC	\$ 129.00	
	LED Light Bar Floodlight/Spotlight Combo 14" Long, 5400 Lumens, 72 Watts, 6 Amps Die Cast Aluminum Housing, Polycarbonate Lens For 12 Volt to 24 Volt Systems Includes Mounting Bracket and Heavy Duty Stainless Steel Hardware	AMTLB410C	\$ 150.00	
	LED Light Bar Floodlight/Spotlight Combo 30" Long, 13600 Lumens, 150 Watts, 12.50 Amps For 12 Volt to 24 Volt Systems Includes Mounting Bracket and Stainless Steel Hardware	AMTL30SRC	\$ 230.00	
	LED Light Bar 30" Long, 13860 Lumens, Cree Bulbs	AMLED30	\$ 130.00	
	LED Light Bar Floodlight/Spotlight Combo 40" Long, 17300 Lumens, 200 Watts, 16.70 Amps For 12 Volt to 24 Volt Systems Includes Mounting Brackets and Stainless Steel Hardware	AMTL40SRC	\$ 300.00	
	LED Light Bar 40" Long, 18200 Lumens, Cree Bulbs	AMLED40	\$ 160.00	
	LED Light Bar Floodlight/Spotlight Combo 42" Long, 14500 Lumens, 240 Watts, 19 Amps For 12 Volt to 24 Volt Systems Includes Mounting Bracket and Stainless Steel Hardware Replaces 1163691	AMTLB440C	\$ 250.00	
 Universal Equipment	LED Magnetic Work Light All-Position Light 3.25" Square Floodlight 900 Lumens Magnetic Base Includes Lithium Ion Battery, Cigarette Lighter and DC Charger	AMTL2460	\$ 79.00	

Caterpillar® / Challenger®

Cab Components—Miscellaneous

Application	Description	Part Number	Retail Price	Core
Challenger®: 65C, 65D, 65E, 75C, 75D, 75E, 85C, 85D, 85E, 95E	Air Spring	AM1416046	\$ 195.00	

Cab Roof

Application	Description	Part Number	Retail Price	Core
Challenger® Tractors: MT735-MT875 2002 and Later	Cab Roof	AM162-6655	\$ 1460.00	

Glass

Application	Description	Part Number	Retail Price	Core
Challenger® Tractors: (MT525B, MT535B, MT545B - w/ Auto Power VI BSN N195047, Non Tier 3), MT535, MT545, MT565, MT635, MT645, MT655, MT665	Door Glass, Right Hand Replaces 3902124M1	AM3907222M1	\$ 466.87	
	Door Glass, Left Hand Replaces 3902123M1	AM3907221M1	\$ 366.00	

Air Conditioning and Components

Application	Description	Part Number	Retail Price
Caterpillar® Tractors: 65B, 65C, 65D, 65E, 75, 75C, 75D, 75E, 85C, 85D, 95E	Compressor w/ Dust Cover, Sanden SD7H15SHD Style 12 Volt, w/ Single Groove Clutch, 5.43" (138 mm) Clutch Diameter, 1/2" Belt Width, GM Pad Mount Requires Synthetic Ester Oil 100V, 10.14 oz (300 cc)	AM3E-1908	\$ 259.00
	Premium Synthetic Ester Oil, 100V, 12 oz	AMX10273	\$ 11.00
Universal Equipment	High Pressure Switch Normally Open, Opens at 305 PSI, Closes at 395 PSI, 7/16"x20 Thread	AMX10276	\$ 35.00
Universal Equipment	Low Pressure Switch Normally Open, Opens at 6 PSI, Closes at 45 PSI, Standard 7/16"x20 Thread	AMX10277	\$ 55.00
Universal Equipment	Low Pressure Switch Normally Open, Opens at 35 PSI, Closes at 46 PSI, Standard 7/16"x20 Thread	AMX10278	\$ 42.00
Caterpillar® Tractors: 35, 45, 55 (Replaces 118-0730), Challenger® Tractors: 35, 45, 55 (Replaces 362.761.0)	Receiver Drier 3" X 10", Inlet - #6 Male O-Ring, Outlet - #6 Female O-Ring R12 and R134a Compatible	AM86026354	\$ 45.00
Caterpillar® Tractors: MT735, MT745, MT755, MT765	Condenser Core: 16" x 24 1/2" x 3"	AM203-5422	\$ 1175.00

Caterpillar® / Challenger®

Tracks

Application	Description	Part Number	Retail Price	Core
Caterpillar® Tractors: MT735, MT745, MT755, MT765	Rubber Track 635WX44LX204P, 25" Track Size 88 Tread Lugs, 8.03" Tread Lug Pitch, 2.76" Height 44 Guide Lugs, 8.03" Pitch, 4.52" Width, 4.25" Height	AMR545861	\$ 7830.00	
	Rubber Track 762WX44LX204P, 30" Track Size 88 Tread Lugs, 8.03" Tread Lug Pitch, 2.76" Height 44 Guide Lugs, 8.03" Pitch, 4.52" Width, 4.25" Height	AMR545863	\$ 8910.00	

Track Parts

Application	Description	Part Number	Retail Price	Core
Caterpillar® Tractors: 35, 45, 55	Reman Front Idler Wheel, Poly 10-Bolt, 31" Diameter, 5.75" Wide, 8.75" Pilot Hole Diameter Replaces 1R-1204	AM1R-1229-R	\$ 800.00	\$ 350.00
Caterpillar® Tractors: MT735, MT745, MT745B, MT755, MT755B, MT755C, MT765, MT765C	Reman Front Idler Wheel, Poly 12-Bolt, 37.50" Diameter, 5.50" Wide, 11" Pilot Hole Diameter Replaces 504782D1	AM1R-1237-R	\$ 700.00	\$ 250.00
Caterpillar® Tractors: MT735, MT745, MT745B, MT755, MT755B, MT755C, MT765, MT765C, MT835, MT845, MT855, MT865	Reman Front Idler Wheel, Poly Narrow, 8-Bolt, 14" Diameter, 5.50" Wide, 5.25" Pilot Hole Diameter Replaces 50930D1	AM1R-1239-R	\$ 250.00	\$ 150.00
	Front Idler Wheel, Poly 12-Bolt, 37.50" Diameter, 8.50" Wide, 13" Pilot Hole Diameter Replaces 504784D1	AM1R-1238	\$ 3250.00	\$ 500.00
	Reman Front Idler Wheel, Poly 12-Bolt, 37.50" Diameter, 8.50" Wide, 13" Pilot Hole Diameter Replaces 504784D1	AM1R-1238-R	\$ 800.00	\$ 250.00
Caterpillar® Tractors: 35, 45, 55	Reman Mid-Roller, Poly 12-Bolt, 13.875" Diameter, 5.50" Wide, 5.25" Pilot Hole Diameter	AM1R-1365-R	\$ 200.00	\$ 100.00
Caterpillar® Tractors: 65, 65C, 75, 95E	Reman Mid-Roller, Poly Stamped Steel, 6-Bolt, 14" Diameter, 10" Wide, 4.75" Pilot Hole Diameter	AM1R-0641-R	\$ 295.00	\$ 100.00
Caterpillar® Tractors: 65, 65C, 75, 85, 95E	Reman Mid-Roller, Poly Stamped Steel, 8-Bolt, 14" Diameter, 8.50" Wide, 4.75" Pilot Hole Diameter	AM9U3384-R	\$ 295.00	\$ 100.00
Caterpillar® Tractors: MT735, MT745, MT745B, MT755, MT755B, MT755C, MT765, MT765C, MT835, MT845, MT855, MT865	Mid-Roller, Poly 8-Bolt, 14" Diameter, 5.50" Wide, 5.25" Pilot Hole Diameter Replaces 5029131D1	AM1R-1638	\$ 345.00	\$ 100.00
	Reman Mid-Roller, Poly 8-Bolt, 14" Diameter, 5.50" Wide, 5.25" Pilot Hole Diameter Replaces 5029131D1	AM1R-1638-R	\$ 210.00	\$ 100.00
	Mid-Roller, Poly 8-Bolt, 14" Diameter, 8.50" Wide, 5.25" Pilot Hole Diameter Replaces 502932D1, 548350D1PA	AM1R-1241	\$ 420.00	\$ 100.00
	Reman Mid-Roller, Poly 8-Bolt, 14" Diameter, 8.50" Wide, 5.25" Pilot Hole Diameter Replaces 502932D1, 548350D1PA	AM1R-1241-R	\$ 355.00	\$ 100.00

Caterpillar® / Challenger®

Application	Description	Part Number	Retail Price	Core
Caterpillar® Tractors: 35, 45, 55	Reman Rear Drive Wheel, Poly 15-Bolt, 60" Diameter, 5.75" Wide, 11" Pilot Hole Diameter	AM1R-1115-R	\$ 3700.00	\$ 500.00
Caterpillar® Tractors: 65, 65C, 75, 85, 95E	Reman Rear Drive Wheel, Poly Right Hand Half of 2-Piece Wheel 18-Bolt, 41.25" Diameter, 9.50" Wide, 19.125" Pilot Hole Diameter	AM1R-1184-R	\$ 1225.00	\$ 250.00
	Reman Rear Drive Wheel, Poly Left Hand Half of 2-Piece Wheel 18-Bolt, 41.25" Diameter, 9.50" Wide, 19.125" Pilot Hole Diameter	AM1R-1185-R	\$ 1225.00	\$ 250.00
Caterpillar® Tractors: MT735, MT745, MT745B, MT755, MT755B, MT755C, MT765, MT765B, MT765C	Reman Rear Drive Wheel, Poly Outer Right Hand or Inner Left Hand 15-Bolt, 61" Diameter, 5.50" Wide, 13" Pilot Hole Diameter Replaces 504787D1	AM1R-1234-R	\$ 1750.00	\$ 500.00
	Reman Rear Drive Wheel, Poly Outer Right Hand or Inner Left Hand 15-Bolt, 61" Diameter, 8.50" Wide, 13" Pilot Hole Diameter Replaces 504790D1	AM1R-1235-R	\$ 2195.00	\$ 500.00
Caterpillar® Tractors: MT735, MT745, MT745B, MT755, MT755B, MT755C, MT765, MT765C, MT835, MT845, MT855, MT865	Reman Rear Drive Wheel, Poly Right Hand 15-Bolt, 61" Diameter, 5.50" Wide, 13" Pilot Hole Diameter Replaces 504788D1	AM1R-1249-R	\$ 1650.00	\$ 350.00
	Reman Rear Drive Wheel, Poly Left Hand 15-Bolt, 61" Diameter, 8.50" Wide, 13" Pilot Hole Diameter Replaces 504789D1	AM1R-1250-R	\$ 2195.00	\$ 500.00



Clear View Cap

Application	Description	Part Number	Retail Price	Core
Challenger® Tractors: MT Series	Cap Kit, Clear View Includes 4 Idler & 16 Roller Caps and O-Rings	AMX92002	\$ 635.00	

Rasp Bars

Application	Description	Part Number	Retail Price	Core
Challenger® Combines: 660, 660B, 670, 670B, 680B	Rasp Bar, Reverse Bar Set of 2 - Wide spaced teeth, 3/4"	AM71371526	\$ 139.19	
	Rasp Bar, Forward Bar Set of 2 - Wide spaced teeth, 3/4"	AM71371520	\$ 100.00	



Concaves and Components

Application	Description	Part Number	Retail Price	Core
Challenger® Combines: 660, 660B, 670, 670B	Concave High Wire (7) Required	Large Wire Corn AM2464751W91	\$ 477.14	
	Concave High Wire (7) Required	Small Wire AM71390005	\$ 526.74	

Caterpillar® / Challenger®

Application	Description	Part Number	Retail Price	Core
Caterpillar® Combines: 660, 660B, 670, 670B, 680B	Concave, Set of 7 Large Wire Corn and Soybean	AM104904W91	\$ 2850.00	



Reel Components

Application	Description	Part Number	Retail Price	Core
Caterpillar® Platforms: 1998 Models and Later	Quick Fingers, 10 Pack	AMX27550	\$ 22.00	



Guards

Application	Description	Part Number	Retail Price	Core
Challenger® Combines: 660, 670	Knife Guard Double Point Replaces 676235N	AM676235	\$ 12.00	
Challenger® Platform: DMV	Knife Guard, Double Pronged Replaces 113400M1	AM66603	\$ 17.08	
Challenger® Draper Platform: 5300 Replaces 700707147, 700716292	Knife Guard, Double Pronged w/ Trash Bar Use w/ 3" Cutter Bar Knife	AM86615982	\$ 11.75	



Draper Belts

Application	Description	Part Number	Retail Price	Core
Challenger® Draper Platform: DH	Side Draper Belt 36', Right and Left Hand, 41" x 396"	AM700726007	\$ 847.00	
Challenger® Draper Platform: FDH	Draper Center Feeder Belt 25', 30', 35' or 40', 51.50" x 62.99"	AM71413887	\$ 395.00	
	Side Draper Belt 25', Right and Left Hand, 41" x 243.70" Single V-Guide	AM71483146	\$ 599.00	
	Side Draper Belt 30', Right and Left Hand, 41" x 303.70" Single V-Guide	AM71483144	\$ 724.00	
	Side Draper Belt 35', Right and Left Hand, 41" x 363.70" Single V-Guide	AM71483142	\$ 843.00	
	Side Draper Belt 40', Right and Left Hand, 41" x 423.70" Single V-Guide	AM71483140	\$ 962.00	
Challenger® Draper Platform: DHC	Side Draper Belt 36', Right and Left Hand, 41" x 348"	AM700726008	\$ 731.00	

Fuel Lift Pumps.....	618	Power Steering Cylinders.....	619
Hydraulic Pumps.....	619	Radiator Hoses.....	618
Instrument Clusters.....	618	Tie Rods and Components.....	619
Lighting.....	620		

Radiator Hoses

Application	Description	Part Number	Retail Price	Core
55-46, 65-46, 70-56, 80-66	Radiator Hose, Upper	AM5104825	\$ 25.89	
(450, 450DT - w/ 8035.01 or 8035.02 Engine), (480, 480DT, 500, 500DT, 540, 540DT - w/ 8035.02 Engine), 550 w/ 8045.01 Engine, (600, 600DT, 640, 640DT - w/ 8045.02 Engine), Crawler/Dozer: 605C Super w/ 8045.02 Engine	Radiator Hose, Upper 1.75" ID Replaces 677214A, 4950088	AM72089692	\$ 16.28	
580, 680, 780, 880, 980, 100-90, 110-90	Radiator Hose, Upper 1.75" ID	AM4997263	\$ 19.38	
1000	Radiator Hose, Upper 1.25" ID	AMSBA310160050	\$ 18.62	
35-66, 35-66DT, 45-66, 45-66DT, 45-76V, 50-66, 50-66DT, 50-86VDT, 55-46, 55-46DT, 55-56, 55-56DT, 55-66, 55-66DT, 55-66LP, 55-76F, 55-76FDT, 55-76V, 55-76VDT, 60-56, 60-56DT, 60-66, 60-66DT, 60-66LPDT, 60-76F, 60-76FDT, 60-86F, 60-86FDT, 60-86V, 60-86VDT, 60-86SV, 60-86SVDT, 60-93, 60-93DT, 60-94, 60-94DT, 65-46, 65-46DT, 65-56, 65-56DT, 65-88DT, 65-93, 65-93DT, 65-94, 65-94DT, 70-56, 70-56DT, 70-66, 70-66DT, 70-66F, 70-66FDT, 70-66LP, 70-66LPDT, 70-66V, 70-66S, 70-66SDT, 70-76F, 70-76FDT, 70-76LP, 70-76LPDT, 70-76V, 70-86VDT, 70-86SVDT, 70-88, 70-88DT, 72-86FDT, 72-86LPDT, 72-93, 72-93DT, 72-94, 72-94DT, 80-66, 80-66DT, 80-66F, 80-66FDT, 80-76F, 80-76FDT, 80-88, 80-88DT, 82-93, 82-93DT, 82-94, 82-94DT, 88-93, 88-93DT, 88-94, 88-94DT, 115-90, 115-90DT, 130-90, 130-90DT, 140-90, 140-90DT, 160-90, 160-90DT, 180-90, 180-90DT, F100, F100DT, F110, F110DT, F115, F115DT, F120, F120DT, F130, F130DT, F140, F140DT	Rubber Mount	AM5108225	\$ 8.00	

Fuel Lift Pumps

Application	Description	Part Number	Retail Price	Core
90-90, 100-90, 110-90	Fuel Lift Pump Replaces 4765158	AM4757884	\$ 30.00	
F100, F100DT, F110, F110DT, F115, F115DT, F120, F120DT, F130, F130DT, F140, F140DT, Wheel Loaders: FW110, FW130, LW110, LW130, LW130TC	Fuel Pump	AM98419724	\$ 85.00	

Instrument Clusters

Application	Description	Part Number	Retail Price	Core
45-66, 45-76, 50-66, 55-46, 55-66, 60-56, 60-66, 65-46, 65-56, 65-93, 65-94, 70-56, 70-66, 70-88, 72-93, 72-94, 80-66, 80-88, 82-93, 82-94, 88-93, 88-94	Instrument Cluster Replaces 5125046, 5133783	AM5145186	\$ 239.00	

Tie Rods and Components

Application	Description	Part Number	Retail Price	Core
(3010S, 4010S, 5010S ASN 400001M), TD60D, TD70D, TT55, TT60A, TT65, TT75, TT75A	Tie Rod Assembly 49.88" Long	AM5135076	\$ 200.00	
(55-46DT, 55-66DT, 60-66DT, 60-90DT ASN D2936), 55-56DT, 60-56DT, 60-93DT, 60-94DT, 65-46DT, 65-56DT, 65-90DT, 65-93DT, 65-94DT, 70-56DT	Tie Rod 51.94" Long 1 1/8" Internal Threads	AM5135075	\$ 200.00	

Power Steering Cylinders





Application	Description	Part Number	Retail Price	Core
55-46, 55-66, 60-90, 65-46, 65-90, 70-66, 70-88, 70-90, 80-66, 80-88, 80-90, 90-90	Power Steering Cylinder Replaces 5140638, 5143022, 5189897	AM5113130	\$ 232.00	









Hydraulic Pumps

Application	Description	Part Number	Retail Price	Core
50-86VDT, (60-86F, 60-86FDT, 60-86V, 60-86VDT, 60-86SV, 60-86SVDT ASN D3600), 70-86VDT, 70-86SVDT, 140-90DT, 180-90DT	Hydraulic Pump, Engine Mount 19.33 cc, 10.80 GPM Replaces 2040333, 5093658, 5094394, 5169770, 5179414, 5179711, 5179714, 9967782, 47562399, 82987745, 87716629, 87737605	AM84530154	\$ 125.00	
72-93DT, 82-93T, 88-93DT	Hydraulic Pump Replaces 5129486, 5169039	AM5179728	\$ 110.00	
45-66, 45-66DT, 45-76V, 50-66, 50-66DT, 50-86VDT, 55-56, 55-56DT, 55-66, 55-66DT, 55-66LP, 55-76F, 55-76FDT, 55-76V, 55-76VDT, 60-56, 60-56DT, 60-66, 60-66DT, 60-66LPDT, 60-76F, 60-76FDT, 60-86F, 60-86FDT, 60-86SV, 60-86SVDT, 60-86V, 60-86VDT, 60-90, 60-90DT, 60-93, 60-93DT, 60-94, 60-97DT, 65-56, 65-56DT, 65-88, 65-88DT, 65-90, 65-90DT, 65-93, 65-93DT, 65-94, 65-94DT, 70-56, 70-56DT, 70-66, 70-66DT, 70-66DTHC, 70-66F, 70-66FDT, 70-66HC, 70-66LP, 70-66LPDT, 70-66S, 70-66SDT, 70-66SDTHC, 70-66V, 70-76F, 70-76FDT, 70-76LP, 70-76LPDT, 70-76V, 70-86SVDT, 70-86VDT, 70-88, 70-88DT, 70-90, 70-90DT, 72-86FDT, 72-86LPDT, 72-93, 72-93DT, 72-94, 72-94DT, 80-66, 80-66DT, 80-66DTHC, 80-66F, 80-66FDT, 80-66HC, 80-76F, 80-76FDT, 80-88, 80-88DT, 80-90, 80-90DT, 82-93, 82-93DT, 82-94DT, 85-90, 85-90DT, 88-93, 88-93DT, 88-94, 88-94DT, 90-90, 90-90DT, 92-94, 100-60DT, 100-90, 110-90, 110-90DT, 115-90, 115-90DT, 130-90, 130-90DT, 140-90, 140-90DT	Hydraulic Pump 14.35 cc, 10.80 GPM Replaces 1909915, 1909919, 1930068, 5086286, 5094391, 5113284, 5120849, 5129483, 5169772, 5179719, 8280127, 9967928, 84467651, 85086286, 87325370, 87721169, 87737603, 153634445, 320446000	AM84530156	\$ 195.00	
45-67V, 55-46, 55-46DT, 55-66, 55-66DT, 55-66LP, 55-76F, 55-76FDT, 55-76V, 55-76VDT, 60-66, 60-66DT, 60-66LPDT, 60-76F, 60-76FDT, 60-90, 60-90DT, 65-46, 65-46DT, 65-88DT, 65-90, 65-90DT, 70-66, 70-66DT, 70-66F, 70-66FDT, 70-66LP, 70-66LPDT, 70-66V, 70-76F, 70-76FDT, 70-76LP, 70-76LPDT, 70-76V, 70-88, 70-88DT, 70-90, 70-90DT, 80-66, 80-66DT, 80-66F, 80-66FDT, 80-76F, 80-76FDT, 80-88, 80-88DT, 80-90, 80-90DT, 115-90, 115-90DT, 130-90, 130-90DT, F100, F100DT, F110, F110DT, F115, F115DT, F120, F120DT, F130, F130DT, F140, F140DT	Hydraulic Steering Pump 19.33 cc Replaces 5129493, 5143768, 5169041, 5179726	AM84530167	\$ 220.00	
55-46, 55-46DT, 65-46, 65-46DT, 72-86FDT	Hydraulic Steering Pump Replaces 569306, 1901323, 1930058, 5088381, 5120406, 5129478, 5179730, 44900783, 87326060, 98420895, 153630659, 153634396, 153634432	AM5179729	\$ 125.00	





Application	Description	Part Number	Retail Price	Core
50-86VDT, 55-76, 55-76F, 55-76FDT, 55-76V, 55-76VDT, 60-56, 60-56DT, 60-66, 60-66DT, 60-66LPDT, 60-76F, 60-76FDT, 60-86F, 60-86FDT, 60-86SV, 60-86SVD, 60-86V, 60-93, 60-93DT, 65-46, 65-46DT, 65-56, 65-56DT, 65-88DT, 65-93, 65-93DT, 70-56, 70-56DT, 70-66, 70-66DT, 70-66FDT, 70-66LP, 70-66LPDT, 70-66S, 70-66SDT, 70-66V, 70-76F, 70-76FDT, 70-76LP, 70-76LPDT, 70-76V, 70-86SVD, 70-86VDT, 72-86FDT, 72-86LPDT, 72-93, 80-66, 80-66DT, 80-66F, 80-66FDT, 80-76F, 80-76FDT, 82-93, 88-93	Hydraulic Steering Pump 11.26 cc Replaces 1901322, 1930061, 5085685, 5088382, 5094395, 5094396, 5129481, 5143767, 5179722, 8273385, 8273973, 9967929, 84467650, 87325369, 87725756, 153633457	AM84530166	\$ 195.00	

Lighting

Application	Description	Part Number	Retail Price	Core
Universal Equipment	LED Wide Floodlight All-Position Light 5" x 7" Rectangle Light 3800 Lumens, 35 Watts For 12 Volt to 24 Volt Systems	AMX34171	\$ 60.00	
 Universal Equipment	LED Floodlight All-Position Light 4.25" x 4.25" Square Light 2650 Lumens, 48 Watts, 4 Amps For 12 Volt to 24 Volt Systems Includes Mounting Bracket and Stainless Steel Hardware	AMTL105F	\$ 95.00	
 Universal Equipment	LED Floodlight All-Position Light 6.25" x 1.75" Rectangle Light 1300 Lumens, 18 Watts, 1.50 Amps For 12 Volt to 24 Volt Systems Includes Mounting Bracket and Stainless Steel Hardware	AMTL118F	\$ 50.00	
 Universal Equipment	LED Floodlight All-Position Light 5" Round Light 3200 Lumens, 40 Watts, 3.30 Amps For 12 Volt to 24 Volt Systems Includes Mounting Bracket and Stainless Steel Hardware	AMTL180	\$ 89.00	
 Universal Equipment	LED Floodlight All-Position Light Round Light 6900 Lumens, 50 Watts, 4.10 Amps For 9 Volt to 32 Volt Systems Includes Mounting Bracket and Stainless Steel Hardware	AMTL500F	\$ 120.00	
	LED Floodlight All-Position Light 4.30" Round Light 5040 Lumens, 50 Watts, 4.10 Amps For 12 Volt to 24 Volt Systems Includes Stainless Steel Adjustable Mounting Bracket	AMAT305931	\$ 96.00	
 Universal Equipment	LED Floodlight All-Position Light 4.25" Round Light 2650 Lumens, 42 Watts, 3.50 Amps For 12 Volt to 24 Volt Systems Includes Mounting Bracket and Stainless Steel Hardware	AMTL115F	\$ 59.00	

	Application	Description	Part Number	Retail Price	Core
	Universal Equipment	LED Floodlight, Sealed Beam Fender Mount 4.50" Diameter Round Light 1250 Lumens, 18 Watts, 1.50 Amps Trapezoid Pattern For 12 Volt to 24 Volt Systems	AMTL3010	\$ 40.00	
		LED Floodlight Fender Mount 4.50" Diameter Sealed Beam Round Light 1250 Lumens, 18 Watts, 1.20 Amps Trapezoid Pattern For 12 Volt to 24 Volt Systems Lasts 50 times longer than halogen lighting, vibration resistant w/ no filament failures, uses original mount and wiring, Operating temperature of -40°F to 140°F / -40°C to 60°C	AMRE336111	\$ 35.00	
	Universal Equipment	LED Floodlight Fender Mount 4.50" Diameter Sealed Beam Round Light 1440 Lumens, 18 Watts, 1.60 Amps Lasts 50 times longer than halogen lighting, vibration resistant w/ no filament failures, 2-terminal connection, Operating temperature of -40°F to 140°F / -40°C to 60°C	AMRE336112	\$ 67.75	
	Universal Equipment	LED Floodlight Cab and Fender Mount 3.50" x 6" Rectangle Light 3600 Lumens, 40 Watts, 3 Amps	AMX34146	\$ 65.00	
	Universal Equipment	LED Spotlight All-Position Light 4.25" x 4.25" Square Light 1400 Lumens, 27 Watts, 2.20 Amps For 12 Volt to 24 Volt Systems	AMTL100S	\$ 45.00	
	Universal Equipment	LED Spotlight All-Position Light 6.25" x 1.75" Rectangle Light 1300 Lumens, 18 Watts, 1.50 Amps For 12 Volt to 24 Volt Systems Includes Mounting Bracket and Stainless Steel Hardware	AMTL118S	\$ 50.00	
	Universal Equipment	LED Spotlight All-Position Light Round Light 6900 Lumens, 50 Watts, 4.10 Amps For 9 Volt to 32 Volt Systems Includes Mounting Bracket and Stainless Steel Hardware	AMTL500S	\$ 120.00	
	Universal Equipment	LED Trapezoid Light Cab and Fender Mount 4.50" Diameter Round Light 2800 Lumens, 40 Watts, 3.30 Amps Trapezoid Pattern For 12 Volt to 24 Volt Systems Bottom Mount w/ Built-In Heat Sink Includes Mounting Bracket, Long and Short Rubber Bezels and Stainless Steel Hardware	AMTL2080	\$ 95.00	
	Universal Equipment	LED Trapezoid Light Cab and Rear Fender Mount 4.50" Diameter Round Light 2800 Lumens, 40 Watts, 3.30 Amps Trapezoid Pattern For 12 Volt to 24 Volt Systems Bottom Mount w/ Built-In Heat Sink Includes Mounting Bracket, Long and Short Rubber Bezels and Stainless Steel Hardware	AMX33121	\$ 76.00	

Application	Description	Part Number	Retail Price	Core
 Universal Equipment	LED Warning Light Cab, Header or Swather Mount Can be used for Turn Signal, Brake or Running Lights 4.125" Diameter Round Light Double Sided, Amber Lenses 25 Bulbs per Side For 12 Volt to 24 Volt Systems	AMTLFL2	\$ 55.00	
 Universal Equipment	LED Warning Light Cab, Header or Swather Mount Can be used for Turn Signal, Brake or Running Lights 4.125" Diameter Round Light Double Sided, Amber Lenses 25 Bulbs per Side For 12 Volt to 24 Volt Systems	AMX1910149	\$ 44.00	
 Universal Equipment	LED Warning Light Cab, Header or Swather Mount Can be used for Turn Signal, Brake or Running Lights 4.125" Diameter Round Light Double Sided, Red and Amber Lenses 25 Bulbs per Side For 12 Volt to 24 Volt Systems	AMTLFL3	\$ 55.00	
 Universal Equipment	LED Warning Light Cab, Header or Swather Mount Can be used for Turn Signal, Brake or Running Lights 4.125" Diameter Round Light Double Sided, Red and Amber Lenses 25 Bulbs per Side For 12 Volt to 24 Volt Systems	AMX33126	\$ 44.00	
 Universal Equipment	LED Magnetic Warning Light All-Position Light 360° Flashing Light, Multiple Patterns 9.50" x 6.75" Rectangle Light Magnetic Base or Solid Mount For 12 Volt to 24 Volt Systems Includes Cigarette Lighter Adapter, Wiring and Switch	AMTL1100	\$ 170.00	
 Universal Equipment	LED Magnetic Warning Light All-Position Light 360° Flashing Light, Multiple Patterns 14" x 6.75" Rectangle Light Magnetic Base or Solid Mount For 12 Volt to 24 Volt Systems Includes Cigarette Lighter Adapter, Wiring and Switch	AMTL1200	\$ 190.00	
Universal Equipment	Warning Beacon 360° Flashing Beacon, Amber Lens For 0.9435" Diameter Pipe Replaces 84337818, AZ44705, AZ101891	AM82018390	\$ 45.64	
 Universal Equipment	LED Warning Beacon 360° Flashing Beacon 2.75" x 5.25" Light Polycarbonate Amber Lens and Housing For 12 Volt to 24 Volt Systems Includes Solid Mounting Pad and Stainless Steel Hardware	AMTL2100	\$ 30.00	
 Universal Equipment	LED Warning Beacon 360° Flashing Beacon, 3 Different Patterns 5" x 10" Light Amber Lens, 48 Watts, 4 Amps For 12 Volt to 24 Volt Systems Brackets Sold Separately	AMX33131	\$ 75.00	
 Universal Equipment	Warning Beacon Bracket	AMX33132	\$ 15.00	

	Application	Description	Part Number	Retail Price	Core
	Universal Equipment	Warning Beacon Bracket	AMX33133	\$ 15.00	
	Universal Equipment	Warning Beacon Bracket	AMX33137	\$ 15.00	
	Universal Equipment	Warning Beacon Bracket	AMX33135	\$ 15.00	
	Universal Equipment	LED Light Bar 4" Long, 1260 Lumens, Cree Bulbs	AMLED4	\$ 45.00	
		LED Light Bar Flood/Spotlight Combo 10" Long, 5700 Lumens, 50 Watts, 4.20 Amps For 12 Volt to 24 Volt Systems Includes Mounting Bracket and Stainless Steel Hardware	AMTL10SRC	\$ 129.00	
		LED Light Bar Floodlight/Spotlight Combo 14" Long, 5400 Lumens, 72 Watts, 6 Amps Die Cast Aluminum Housing, Polycarbonate Lens For 12 Volt to 24 Volt Systems Includes Mounting Bracket and Heavy Duty Stainless Steel Hardware	AMTLB410C	\$ 150.00	
		LED Light Bar Floodlight/Spotlight Combo 30" Long, 13600 Lumens, 150 Watts, 12.50 Amps For 12 Volt to 24 Volt Systems Includes Mounting Bracket and Stainless Steel Hardware	AMTL30SRC	\$ 230.00	
		LED Light Bar 30" Long, 13860 Lumens, Cree Bulbs	AMLED30	\$ 130.00	
		LED Light Bar Floodlight/Spotlight Combo 40" Long, 17300 Lumens, 200 Watts, 16.70 Amps For 12 Volt to 24 Volt Systems Includes Mounting Brackets and Stainless Steel Hardware	AMTL40SRC	\$ 300.00	
		LED Light Bar 40" Long, 18200 Lumens, Cree Bulbs	AMLED40	\$ 160.00	
		LED Light Bar Floodlight/Spotlight Combo 42" Long, 14500 Lumens, 240 Watts, 19 Amps For 12 Volt to 24 Volt Systems Includes Mounting Bracket and Stainless Steel Hardware Replaces 1163691	AMTLB440C	\$ 250.00	
		LED Light Bar, Curved 50" Long, 21500 Lumens, Cree Bulbs	AMLED50C	\$ 190.00	
	Universal Equipment	LED Magnetic Work Light All-Position Light 3.25" Square Floodlight 900 Lumens Magnetic Base Includes Lithium Ion Battery, Cigarette Lighter and DC Charger	AMTL2460	\$ 79.00	

Radiator Components..... 624

Radiator Components

Application	Description	Part Number	Retail Price	Core
Crawlers/Dozers: 72-85, 72-85M, 95-55	Rubber Mount	AM5108225	\$ 8.00	

Ford® / New Holland®—Tractor

Table of Contents

Air Cleaner Components	653	MFWD Driveshafts	666
Air Conditioning and Components	712	MFWD Hub Components	660
Alternators	653	MFWD Hubs and Housings	656
Axle Center Tubes and Beams	676	Mufflers and Exhaust	649
Axle Knee Extensions	676	Oil Coolers, Engine	632
Battery Box Components	698	Oil Pumps, Engine	631
Belts	643	Overhaul Kits	627
Brake Components	690	Power Steering Cylinders and Components	676
Brake Shoes	689	Power Steering Gearbox Assembly and Components	691
Cab Components—Miscellaneous	708	Power Steering Orbit Motors	682
Cab Doors	708	Power Steering Pumps and Conversion Kits	681
Camshafts and Lifters	630	PTO Adapters	687
Carburetors	644	PTO Assembly Components	685
Connecting Rods	629	PTO Clutch Parts	688
Crankshaft Pulleys and Dampers	630	PTO Gears	688
Crankshafts	628	PTO Output Shafts	687
Cylinder Heads, Bare	630	PTO Shafts and Hubs	686
Differentials and Components	689	Quick Hitches	695
Distributors	652	Radiator Hoses	634
Drawbars and Components	692	Radiators and Components	632
Engine Fans and Components	640	Rear Axles and Components	689
Fan Clutches	643	Remote Valves	678
Fenders and Components	699	Rockshaft Components	693
Flywheels and Components	640	Sensors	655
Front Grilles, Nose Cones and Components	698	Shop Manuals and Collections	720
Fuel Components	645	Shortblock Assemblies	626
Fuel Lift Pumps	644	Side Panels and Hoods	698
Fuel Tanks	711	Spindles	671
Gas Struts	710	Starters	651
Glass	708	Steering Arms	675
Hammer Straps	693	Steering Shafts	691
Hydraulic Lift Components	696	Steering Wheels and Caps	711
Hydraulic Oil Coolers	678	Tachometers and Instrument Clusters	656
Hydraulic Pumps	678	Three Point Hitch Components	695
Hydrostats and Components	682	Tie Rods and Components	666
Injection Pumps	645	Toplink Assemblies	697
Injectors	646	Transmission Components	682
Lift Link Assemblies and Components	693	Transmission Discs	685
Lighting	699	Turbochargers	647
Longblock Assemblies	625	Water Pumps and Components	641
Lower Lift Links	694	Wheel Bearing Kits	674
Manifolds and Components	648	Wheel Hubs and Components	673
Manual Steering Gearbox Assemblies	691		
Mechanical Front Wheel Drive Parts	656		
MFWD Differentials and Components	662		

Longblock Assemblies

Our remanufactured longblocks meet the highest standards in quality. All remanufactured components are inspected for structural integrity, cracks and dimensional specifications and then remanufactured back to OEM specifications. The components are then assembled using the highest quality new parts. We back this with one of the best warranties in the industry.



Application	Description	Part Number	Retail Price	Core
TG215, TG275, TG305, T8010, T8020, T8030, T8040, Versatile® Tractors: 250, 305	Reman Longblock Assembly	LBCUM8304HPCR24V	\$ 11000.00	\$ 2000.00

Ford® / New Holland®—Tractor

Application	Description	Part Number	Retail Price	Core
Ind: (345C, 445C, 545C - 12/1988-08/92 w/ 3 Cylinder Engine), (345D, 445D - 09/1992-10/2000 w/ 3 Cylinder Engine), 545D 11/1988-2001 w/ 3 Cylinder Engine	Longblock Assembly	AM87801544	\$ 3750.00	\$ 1000.00
Combines: CR9040, CR9060	Reman Longblock Assembly Replaces 87603080, 87603080R	LBCUM8.9	\$ 12500.00	\$ 5000.00
T6010, TS100A	Reman Engine, Complete 4.5 Liter NF 45	AM87318785ER	\$ 8500.00	\$ 2500.00
T6030	New Engine, Complete 6.7 Liter NEF 67 Replaces 50427568ER	AM87318901ER	\$ 11000.00	\$ 5000.00
T6030, T6050, T6070, T6080	New Engine, Complete 6.7 Liter NEF 67 Replaces 87312077ER, 87516256ER	AM87312078ER	\$ 12500.00	\$ 5000.00
7840, 8240, 8340, TS115	New Engine, Complete Emission Engine Replaces 87800805, 87801845, 87840842	AM87802221	\$ 12500.00	\$ 5000.00
Combines: (CR9040, CR9060, CR9065, CR9070 BSN Y8G112001)	New Engine, Complete 10.3 Liter Iveco Replaces 87283632	AM504099224	\$ 17500.00	\$ 7500.00

Shortblock Assemblies

Our remanufactured shortblocks meet the highest standards in quality. All remanufactured components are inspected for structural integrity, cracks and dimensional specifications and then remanufactured back to OEM specifications. The components are then assembled using the highest quality new parts. We back this with one of the best warranties in the industry. Camshafts and lifters are not included with these shortblocks and must be purchased separately.



Application	Description	Part Number	Retail Price	Core
3000 w/ 158 3 Cylinder Diesel Engine	Reman Shortblock Assembly	SBFD1583000	\$ 3500.00	\$ 500.00
3000, 4000 - w/ 201 3 Cylinder Diesel Engine	Reman Shortblock Assembly	SBFD2014000	\$ 3500.00	\$ 500.00
3230, 3430, 3930, 4130, 4630 - w/ 201 Ford Engine	Shortblock Assembly Includes cam gear, timing gears and steel timing plate	AM87800041	\$ 4100.00	\$ 500.00
5000 w/ 233 4 Cylinder Diesel Engine	Reman Shortblock Assembly	SBFD233D5000	\$ 4750.00	\$ 500.00
5000, 5100, 5110, 5200, 5340, 5600, 5610, 5700, 6410, 6600, 6600C, 6600O, 6610, 6610O, 6700, 6710, 6810, 7000, 7100, 7200, 7410, 7600, 7600C, 7610, 7610O, 7700, 7710, Backhoe-Loaders: 555C, 555D, 575D, 655C, 655D, 675D, Swather: 1118 - All w/ 268 4 Cylinder Diesel Engine	Shortblock Assembly Replaces 83904003, 83918888, 83944995	AM84227839	\$ 5000.00	
5000, 5610, 6600, 6700, Ind: 5500, 5550, 6500 - All w/ 256 4 Cylinder Diesel Non-Turbo Engine	Reman Shortblock Assembly	SBFD256D5600	\$ 4750.00	\$ 500.00
7000 w/ 256 4 Cylinder Diesel Turbo Engine	Reman Shortblock Assembly	SBFD256DT7000	\$ 4750.00	\$ 750.00
7600 w/ 268 4 Cylinder Diesel Non-Turbo Engine	Reman Shortblock Assembly	SBFD268D7600	\$ 4750.00	\$ 750.00
7610 w/ 268 4 Cylinder Diesel Turbo Engine	Reman Shortblock Assembly	SBFD268DT7610	\$ 5500.00	\$ 750.00
8000, 8600 - w/ 401 6 Cylinder Diesel Non-Turbo Engine	Reman Shortblock Assembly 1/2" or 9/16" head bolt	SBFD401D8000	\$ 5500.00	\$ 750.00
8670, 8770, 8870, 8970, Combine: TR88	Reman Shortblock Assembly Big Snout 8-Bolt Flywheel Mounting	SBFD456T	\$ 6500.00	\$ 1000.00
9000, 9600 - w/ 401 6 Cylinder Diesel Turbo Engine	Reman Shortblock Assembly 1/2" or 9/16" head bolt	SBFD401T9600	\$ 5500.00	\$ 750.00
9700 w/ 401 6 Cylinder Diesel Turbo Engine	Reman Shortblock Assembly	SBFD4019700	\$ 5500.00	\$ 750.00
TW10 w/ 401 6 Cylinder Diesel Non-Turbo Engine	Reman Shortblock Assembly	SBFD401TW10	\$ 5500.00	\$ 750.00

Ford® / New Holland®—Tractor

Application	Description	Part Number	Retail Price	Core
TW20, TW30 - w/ 401 6 Cylinder Diesel Turbo Engine	Reman Shortblock Assembly	SBFD401TW30	\$ 5500.00	\$ 750.00
TW35 Late w/ 401 6 Cylinder Diesel Turbo Engine	Reman Shortblock Assembly w/ Auxiliary Drive Hole in Left Hand Rear Corner of Block	SBFD401TW35	\$ 5500.00	\$ 750.00



Overhaul Kits

Application	Description		Retail Price	Core
2N, 8N, 9N	120 Engine - Gas 0.04" Wall Thickness	Inframe Kit	\$ 236.00	
		Overhaul Kit	\$ 251.00	
	120 Engine - Gas 0.09" Wall Thickness	Inframe Kit	\$ 236.00	
		Overhaul Kit	\$ 251.00	
600 & 700 Series, NAA	134 Engine - Gas	Inframe Kit	\$ 418.00	
		Overhaul Kit	\$ 383.00	
2000, 2100, 2110, 2120, 2300, 2310, 3000, 3055, 3100, 3120, 3190, 3330, 3400, 3500, 3550	158 Engine - Gas	Inframe Kit	\$ 573.00	
		Overhaul Kit	\$ 584.00	
2000, 2100, 2110, 2120, 2300, 2310	158 Engine - Diesel	Inframe Kit	\$ 395.00	
		Overhaul Kit	\$ 440.00	
800, 900, 1800 & 4000 Series	172 Engine - Gas Non-Sleeved	Inframe Kit	\$ 373.00	
		Overhaul Kit	\$ 389.00	
800 Series, 900 Series, 1800 Series, 4000 Series	172 Engine - Gas Sleeved	Inframe Kit	\$ 407.00	
		Overhaul Kit	\$ 435.00	
800, 900, 1800 & 4000 Series - 1958-81	172 Engine - Diesel Non-Sleeved	Inframe Kit	\$ 666.00	
		Overhaul Kit	\$ 729.00	
	172 Engine - Diesel Sleeved	Inframe Kit	\$ 584.00	
		Overhaul Kit	\$ 621.00	
3000, 3100, 3110, 3120, 3150, 3190, 3300, 3310, 3330, 3400, 3500	175 Engine - Diesel	Inframe Kit	\$ 394.00	
		Overhaul Kit	\$ 403.00	
4000, 4100, 4110, 4140, 4190, 4200, 4330, 4340, 4400, 4500 - 1965-68	192 Engine - Gas	Inframe Kit	\$ 570.00	
		Overhaul Kit	\$ 548.00	
3610, 3910	192 Engine - Diesel	Overhaul Kit	\$ 438.00	
4000, 4100, 4110, 4140, 4190, 4200, 4330, 4340, 4400, 4410, 4500	201 Engine - Diesel 01/1965-05/69	Inframe Kit	\$ 419.00	
		Overhaul Kit	\$ 445.00	
4000, 4100, 4110, 4140, 4190, 4200, 4330, 4340, 4400, 4410, 4500, 4600, 4610, Ind: 515, 530A, 531, 532, 535, 540A, 540B, 545, 545A, Backhoe-Loaders: 550, 555, 555A, 555B	201 Engine - Diesel 06/1969-12/74	Inframe Kit	\$ 401.00	
		Overhaul Kit	\$ 390.00	
5000, 5100, 5190, 5200, 5500, 5600, 5700	233 Engine - Diesel	Inframe Kit	\$ 517.00	
		Overhaul Kit	\$ 577.00	
5000, 5100, 5190, 5200, 5340, 5600, 5610, 5900, 6600, 6700, Ind/Const: 5500, 5550, 6500, Swathers: 907, 909, 910, 912, 1100, 1112, 1114, Mower Conditioner: 1495	256 Engine - Diesel	Inframe Kit	\$ 477.00	
		Overhaul Kit	\$ 491.00	

Prices Subject to Change without Prior Notice. The use of original equipment manufacturer (OEM) part numbers or trademarks, e.g. Case® and John Deere®, are for reference purposes only and for indicating product use and compatibility. Our company and the listed replacement parts contained herein are not sponsored, approved or manufactured by the OEM. All parts are New unless designated Reman in the description.

Ford® / New Holland®—Tractor

Application	Description		Retail Price	Core
7000, 7100, 7200, 7500, 7600, 7700	256T Engine - Diesel	Inframe Kit	\$ 493.00	
		Overhaul Kit	\$ 570.00	
5610S, 5640	268 Engine - Diesel 09/1990-07/96	Inframe Kit	\$ 523.00	
		Overhaul Kit	\$ 573.00	
6600, 6610, Backhoe-Loader: 755	268 Engine - Diesel	Inframe Kit	\$ 521.00	
6610, Ind: 655C, 655D	268 Engine - Diesel	Major Overhaul Kit	\$ 741.00	
6810, 7610, 7710, Ind: 755B	268T Engine - Diesel	Major Overhaul Kit	\$ 729.00	
7710	268T Engine - Diesel	Inframe Kit	\$ 490.00	
7840	401 Engine - Diesel	Inframe Kit	\$ 998.00	
		Overhaul Kit	\$ 1209.00	
(7910, 8210, TW5 - Prior to 3/86), 8000, 8600, 8700, TW10	401 Engine - Diesel	Inframe Kit	\$ 777.00	
		Overhaul Kit	\$ 878.00	
9000, 9600, 9700, TW15, TW20, TW25, TW30, TW35	401T Engine - Diesel	Inframe Kit	\$ 799.00	
		Overhaul Kit	\$ 898.00	
6640	304 Engine - Diesel	Inframe Kit	\$ 516.00	
		Overhaul Kit	\$ 566.00	
7740	304T Engine - Diesel, Non Emission	Inframe Kit	\$ 699.00	
		Overhaul Kit	\$ 607.00	
8240 Non-Turbo, 8340 Turbo and Non-Turbo	456 Engine - Diesel	Inframe Kit	\$ 1084.00	
		Overhaul Kit	\$ 1185.00	
3610, 3910	192 Engine - Diesel	Inframe Kit	\$ 361.00	

Crankshafts



Application	Description	Part Number	Retail Price	Core
2N, 8N, 9N	Crankshaft	AM9N6303A	\$ 414.00	
650, 5000 Major, 5000 Super Major, 5000, 5100, 5190, 5200, 5500, 5600, 5610, 5700, 6000, 6500, 6600, 6610, 6700, 6710, 7000, 7100, 7200, 7500, 7600, 7610, 7700, 7710, Combines: 620, 622 Replaces 1595N, 6110A	Crankshaft w/ Gear BSD442 4.2 Stroke 256 CID 4.2 Liter 4 Cylinder Engine 4.203" Stroke, 4.4007" - 4.4032" Bore, 2.7496" - 2.7504" Rod, 3.3713" - 3.3723" Main Flange - Centering Ring, 6 Bolt Holes, 1 Dowel Hole Snout - 1 Bolt Hole, 1 Keyway, w/ 78 Tooth Balance Drive Gear 12.50 mm Wide, Right Hand Helix	AMC5NE6303K	\$ 550.00	
		801, 901, 1801, 4000 Series Replaces B9NN6302B	AMEZJL6300BA-2	\$ 610.00
2000, 2100, 2110, 2120, 2300, 2310, 2610, 2910, 3000, 3000 Super Dexta, 3055, 3100, 3110, 3120, 3150, 3190, 3230, 3300, 3310, 3330, 3500, 3600, 3610, 3900, 3910, (4100, 4110, 4130, 4140, 4200, 4330, 4400, 4410, 4500, 4600, 4610, 4630 - w/ Gas Engine), Ind: 230A, 234, 333, 335, 336, 340, 340A, 445, 450, 3400, 3550	Crankshaft BSD329, D175, D183, D192 - 3 Cylinder Engines 4.200" Stroke, 4.200" Bore, 2.7496" - 2.750" Rod, 3.3713" - 3.3723" Main Flange - Centering Ring, 6 Bolt Holes, 1 Dowel Hole Snout - Keyed, 1 Bolt Hole	AME0NN6303AA	\$ 475.00	
		3930, 3930H, 3930N, 3930NO, 4000, 4000 Major, 4100, 4110, 4130, 4130N, 4130NO, 4140, 4190, 4200, 4330, 4340, 4410, 4600, 4600SU, 4610, 4610SU, 4630, Ind: 260C, 455C, 455D, 530A, 531, 532, 535, 540, 540A, 540B, 545, 545A, 545C, 555, 555A, 555B Replaces C5NE6303N, E5NN6306N	AMF0NN6303MA	\$ 415.00

Ford® / New Holland®—Tractor

Application	Description	Part Number	Retail Price	Core
5610S, 6610S, 7610S, T4040, T4050, T4050F, T4050V, T5040, T5050, T5060, T5070, T6010, T6020, T6040, T6060, T4.95, TD5050, TL80A, TL90A, TL100A, TN85DA, TN95DA, TS100A, TS110A, TS6000, TS6020, TS6030 Replaces 2830396, 2831069, 2831335, 2831336, 2856774, 2859419, 4891107, 504240990	Crankshaft 4.5 Liter Engine Rear Gear Train, 6 Front Bolt Holes, 1 Dowel Hole, 8 Rear Bolt Holes	AM504359387	\$ 875.00	
6000, 6600, 6610, 6700, 7000, 7100, 7200, 7600, 7610, 7700, 7710 Replaces D5NN6303FA, D9NN6110AA, D9NN6303A, D9NN6303AA, E5NN6303CA	Crankshaft w/ Gear BSD444 268 CID 4.4 Liter 4 Cylinder Engine 4.400" Stroke, 4.4007" - 4.403" Bore, 2.7496" - 2.7504" Rod, 3.3713" - 3.3723" Main Flange - Centering Ring, 6 Bolt Holes, 1 Dowel Hole Snout - 1 Bolt Hole, 1 Keyway, w/ 76 Tooth Balance Drive Gear 15.00 mm Wide, Right Hand Helix	AME5NN6303DA-76-2	\$ 495.00	
6000, 6600, 6610, 6700, 7000, 7100, 7200, 7600, 7610, 7700, 7710 Replaces 1598N, D5NN6303FA, D9NN6110AA, D9NN6303A, D9NN6303AA, E5NN6303CA	Crankshaft w/ Gear BSD444 268 CID 4.4 Liter 4 Cylinder Engine 4.400" Stroke, 4.4007" - 4.403" Bore, 2.7496" - 2.7504" Rod, 3.3713" - 3.3723" Main Flange - Centering Ring, 6 Bolt Holes, 1 Dowel Hole Snout - 1 Bolt Hole, 1 Keyway, w/ 78 Tooth Balance Drive Gear 12.50 mm Wide, Right Hand Helix	AME5NN6303DA-2	\$ 495.00	
T6030, T6050, T6070, T6080, T6090, T7030, T7040, T7050, T7060, T7.170, T7.185, T7.200, T7.210, T7.220, T7.235, T7.250, T7.260, T7.270, TS125A, TS130A, TS135A Replaces 2830398, 2831071, 2831402, 2856281, 2856282, 2859446, 504347348	Crankshaft 6.7 Liter Mechanical Injection Engine	AM504203869	\$ 1565.00	
(T9030, T9040, T9050 ASN Z7F204001), TJ380, TJ430	Crankshaft Cursor 13	AM99438979	\$ 2750.00	

Connecting Rods

All connecting rods are cleaned and inspected for defects prior to remanufacturing. Rods are then shot-peened for stress relief and the size is checked against OEM specifications. New piston pin bushings are installed in each rod and bored to the correct center-to-center dimensions. The center-to-center dimension greatly affects the performance of your engine and is a step that many remanufacturers ignore. Final assembly of our connecting rods include installation of new rod bolts and verifying product dimensions, including bend and twist, one final time.



Application	Description	Part Number	Retail Price	Core
455, 550, 555, 655, 3230, 3930, 4130, 4630, 5030, 5110, 5610, 5640, 5900, 6410, 6610, 6640, 6710, 6810, 7000, 7410, 7600, 7610, 7810, 7910, 8210, 8240, 8260, 8340, 8530, TS115	Connecting Rod Replaces 81875622, 83958631, 83972114	AM87801218	\$ 95.97	
3230, 3430, 3610, 3910, 3930, 4000, 4110, 4120, 4130, 4140, 4330, 4340, 4600, 4610, 4630, 4830, 5000, 5030, 5100, 5600, 5900, 6600, 6700, 6710, 7910, 8000, 8210, 8530, 8600, 8700, TW5, TW10 - w/ 192, 201, 233, 256, 268 and 401 Engines	Connecting Rod 1.50 Pin Diameter	AMC7NN6205	\$ 76.21	
7000, 7100, 7200, 7400, 7600, 7700, 7710, 8630, 8730, 8830, 9000, 9600, 9700, TW15, TW20, TW25, TW30, TW35 - w/ 256T, 268T or 401T Engines	Connecting Rod w/ Flat Wrist Pin, 1.625" Pin Diameter	AM87801220	\$ 78.75	
7000, 8000, TW10	Reman Connecting Rod 1.50" Pin Diameter	AMCR6205S-R	\$ 185.00	\$ 30.00
9000, 9600, TW20, TW30, TW35	Reman Connecting Rod 1.625" Pin Diameter	AMCR6205L-R	\$ 185.00	\$ 40.00
Genesis Engine	Reman Connecting Rod w/ Tapered Wrist Pin, 1.625" Pin Diameter	AMCR6205LGEN-R	\$ 185.00	\$ 40.00
T8050, T9020, TJ325 w/ 6TAA-9004 Engine, TJ330, Combines: (CR9040, CR9060 BSN Y8G112001)	Connecting Rod Bolt Replaces J944679	AM3944679	\$ 2.70	

Ford® / New Holland®—Tractor

Crankshaft Pulleys and Dampers

Application	Description	Part Number	Retail Price	Core
7910, 8210, 8530, 8630, 8730, 8830, 9700, TW5, TW10, TW20, TW25, TW30, TW35	Crankshaft Damper Pulley 3-Groove	AMD8NN6316AC	\$ 256.00	
T8010, T8020, T8030, T8040, T8050, TG215, TG245, TG275, TG305 - w/ 6CT, 6CTA, 6CTAA or QSC 8.3 Liter Cummins® Engine	Crankshaft Damper Pulley Replaces 87773050, J910907, J914456	AMJ925570	\$ 95.00	
TG210, TG230, TG255, TG285	Crankshaft Damper Pulley 2.24" Thick, 0.95" ID, 9.67" OD Replaces 39255568, J910907, J914456	AMJ925568	\$ 125.00	
TM115, TM120, TM125, TM130, TM135, TM140, TM150, TM155, TM165	Crankshaft Damper Pulley 10 Spline, 13.701" OD, 1.575" Spline Diameter Replaces 5187845	AM87304267	\$ 392.00	

Camshafts and Lifters



Application	Description	Part Number	Retail Price	Core
401 Engine	Camshaft 6 Cylinder	AM87802904	\$ 205.00	
8N w/ Side Mount Distributor	Camshaft	AM8N6250	\$ 179.00	
600, 700, 800, 900, 1800, 2000, 4000 Series, NAA - w/ 134/172 4 Cylinder Gas Engine	Camshaft and Reman Lifters Kit Lifter 4 Cylinder 134/172 Gas	AMCONN6251A-K AMF3JL6500AA	\$ 297.17 \$ 8.00	
2000, 2600, 2610, 3000, 3055, 3100, 3400, 3500, 3550, 3600, 3610, 3900, 3910, 4000, 4100, 4110, 4140, 4200, 4400, 4410, 4500, 4600, 4610, Ind: 335, 340, 420, 515, 532, 535, 545, 550, 555	Camshaft 3 Cylinder	AM87800323	\$ 125.00	
4230, 4430, 4835, 5635	Camshaft Includes Gear, Key and Thrust Plate	AM98425868	\$ 1389.00	
5000, 5100, 5200, 5590, 5600, 5610, 6600, 6610, 6700, 6710, 7200, 7600, 7610, 7700, 7710, Ind: 650, 655, 750, 755, 5500, 6500, 7500	Camshaft 4 Cylinder Ref# 84157722	AM87800353	\$ 130.00	
Versatile®: 276V	Camshaft 3.9 Cummins® Engine	AMJ929039	\$ 95.00	
Most 3 Cylinder, 4 Cylinder and 6 Cylinder Engines	Lifter	AMC7NN6500B	\$ 8.00	
TG210, TG230	Push Rod	AMJ905194	\$ 10.25	

Cylinder Heads, Bare

Our remanufactured cylinder heads are cleaned, pressure-tested and resurfaced. New seats and guides are installed using OEM specifications. These heads are ready for final assembly.



Application	Description	Part Number	Retail Price	Core
2N, 8N, 9N	Cylinder Head, Bare Replaces 8N6050	AM9N6050	\$ 221.00	
800, 900, 4000 - w/ 172 Gas Engine	Reman Cylinder Head, Bare	AMCHFD172GB	\$ 600.00	\$ 100.00
2000, 3000, 4000 - w/ 201 Gas Engine	Reman Cylinder Head, Bare	AMCHFD201GB	\$ 522.50	\$ 100.00
2N, 8N, 9N	Valve Train Kit Free Rotating Valves For Engines w/ Adjustable Lifters Includes (4) Rotating Exhaust Valves, (4) Intake Valves, (8) 1-Piece Solid Guides with Guide Seals, (8) Springs, (4) Intake Spring Retainers, (4) Exhaust Spring Retainers, (4) Lash Caps, (8) Guide Locking Clips and (16) Valve Lock Keepers	AMVK1000	\$ 133.02	

Ford® / New Holland®—Tractor

Application	Description	Part Number	Retail Price	Core
2000, 2100, 2110, 2120, 2300, 2310, 2600, 2610, 2810, 2910, 3000, 3055, 3100, 3110, 3120, 3190, 3230, 3300, 3310, 3430, 3550, 3600, 3610, 3900, 3910, 3930, 4000, 4100, 4110, 4130, 4140, 4190, 4200, 4330, 4340, 4400, 4410, 4500, 4600, 4610, Indl/Const: 230A, 231, 233, 234, 250C, 333, 334, 335, 340, 340A, 340B, 345C, 345D, 420, 445, 445A, 445C, 445D, 455, 515, 530A, 531, 532, 535, 540, 540A, 545, 545A, 550, 555, 555A	Valve Train Kit Includes (3) Exhaust Valves, 5.766" Long, 45°, (3) Intake Valves, 5.746" Long, 45°, (6) Valve Springs, (6) Valve Spring Retainers, (6) Valve Spring Retainer Sleeves, (12) Valve Keepers, and (6) Valve Seals	AMVK1045	\$ 107.00	

Oil Pumps, Engine

All of our remanufactured engine oil pumps are disassembled, thoroughly cleaned and inspected. All worn parts are replaced and tolerances are checked to guarantee our oil pumps will perform to OEM specifications. The pump is reassembled and - as a safety measure - each pump is lubricated with Clevite Bearing Guard to ensure there is no damage during initial start up. Replacing the engine oil pump during an overhaul is a step many people overlook.



Application	Description	Part Number	Retail Price	Core
600, 700, 800, 900 Series - w/ 4 Cylinder Engine	Engine Oil Pump Hex Drive, Gear Type Output Mounting Flange has Square Opening	AMEAE6621AB	\$ 60.00	
501, 601, 701, 801, 901, (2000, 4000 - w/ 4 Cylinder Engine)	Engine Oil Pump Hex Drive, Roto Type Output Mounting Flange has Slotted Opening	AMD1NL6600A	\$ 69.92	
(2000, 3000, 4000, 5000 1965-75), (2600, 3600, 3900, 4600, 5600, 6600 1975-81), (2310, 2610, 2810, 2910, 3910, 4110, 4610 1981-10/91), (3230, 3430, 3930, 4130, 4930, 4830, 5030 3/90-5/94)	Engine Oil Pump Replaces E1NN6600DA, E1NN6600DB, E1NN6600DC	AME1NN6600DD	\$ 65.00	
4630, 5030, 7000 Series 10/71 and Later, (7600, 7700 1975-81), Swather: 1118	Engine Oil Pump Replaces E1NN6600CB	AME1NN6600CC	\$ 70.00	
6640, 7740 - w/ 340 or 304T Engine	Engine Oil Pump	AM81868537	\$ 105.00	
7840, 8240, 8340 - w/ 401 or 456 Engine	Engine Oil Pump	AME9NN6600BB	\$ 110.00	
8700	Engine Oil Pump	AME1NN6600BC	\$ 126.00	
Dexta, Super Dexta - w/ Perkins® 144 CID or 152 CID Engine	Engine Oil Pump	AM41314187	\$ 78.70	
T8010, T8020, T8030, T8040	Engine Oil Pump	AM3991123	\$ 146.28	
TG210, TG230, TG255, TG285, TJ275, TJ325, TJ450, Wheel Loader: LW230.B	Engine Oil Pump Replaces 3948072, 87775216, J942723	AMJ948072	\$ 235.00	
TW20, TW30, TW15, TW25, TW35, 8630, 8730, 8830 - w/ Turbo Engines Only	Engine Oil Pump Replaces D8NN6600AJ	AM87840275	\$ 357.03	
Swathers: HW305, HW305S, HW325 - w/ N45 Fiat® Diesel Engine	Engine Oil Pump	AM4897480	\$ 129.60	
2000, 2100, 3000, 3100, 3400, 3500, 4000, 4110, 4400, 4500, 5000, Ind: 3550, 5500, 5550	Oil Filter Adapter Kit Spin-On, Pre-Assembled O-Ring Not Included Replaces 309825F, 1821119, DBPN309825	AM309825	\$ 25.00	
T8010, T8020, T8030, T8040, T8050, T9010, T9020, TG215, TG245, TG275, TG305, (TJ275, TJ325 - w/ 6TAA-8304 or 6TAA-9004 Engine), TJ280, Combines: CR9040, CR9060 BSN Y8G112001)	Gasket, Oil Pump Pickup Tube Replaces 3914302, 87775049, A77583, J908540, J914302	AM87447959	\$ 3.00	

Ford® / New Holland®—Tractor

Oil Coolers, Engine

Application	Description	Part Number	Retail Price	Core
5610S, 6610S, 7610S, TS6020, TS6030	Engine Oil Cooler N45 Fiat Diesel, 5 Fins	AM2853722	\$ 139.54	
T8010, T8020, T8030, T8040, T8050, T9010, T9020, TJ280, TJ330	Engine Oil Cooler 8.9 Cummins®, 14 Fins	AM87452245	\$ 195.00	



Radiators and Components

Application	Description	Part Number	Retail Price	Core
2N, 8N, 9N	Radiator Overall: 16 1/2" x 23 1/2" Core: 15 3/8" x 17" x 2" Replaces 86551430	AM8N8005	\$ 170.00	
250C, 260C, 532 w/ Torque Conversion 1975-07/81, (2000, 4000 - w/ 3 Cylinder Engine w/ Oil Cooler), (2100, 2110, 2120, 2300, 2310, 3000, 3055, 3100, 3110, 3120, 3150, 3190, 3300, 3310, 3330, 3400, 4100 - 1965 and Later), Ind/Const: (340A, 340B, 540A, 540B - 08/1981 and Later), 420 w/ Torque Conversion 1975-07/81, 445 Prior to 09/1978, 540 Prior to 07/1981, (3500, 3550, 4400 - 1965 and Later)	Radiator Overall: 19" x 22 1/2"* Core: 17 1/4" x 16" x 2" 3 Rows, 8 Fins per Inch *Overall Height Does Not Include Filler Neck Oil Cooler Ports are on the Grille Side Replaces 82847505, C5NN8005J, C5NN8005T, E1NN8005AB15M	AMD8NN8005PA	\$ 275.00	
5000, 5100, 5600, 6600 - w/o Oil Cooler	Radiator Overall: 18 3/4" x 24" Core: 18" x 17 3/4" x 1 3/4" 3 Rows, 9 Fins per Inch Replaces C5NN8005N, D6NN8005A, D6NN8005B	AMC7NN8005E	\$ 219.00	
600, 700, 800, 900, 2000, 4000, NAA - w/ 4 Cylinder Engine	Radiator Overall: 17 5/8" x 24" Core: 17 1/4" x 17 1/2" x 2" 3 Rows, 8 Fins per Inch	AMC5NN8005AB	\$ 200.00	
2000, 2100, 2120, 2300, 2600, 2610, 3000, 3100, 3400, 3550, 3600, 3610, 3900, 3910, 4000, 4110, 4140, 4400, 4410, 4600, 4610	Radiator Overall: 19" x 22 1/2" x 17 3/8" Core: 16" x 2" 3 Rows, 9 Fins per Inch	AMC7NN8005H	\$ 175.00	
2600, 2600N, 2600R, 2600V, 3600, 3600N, 3600NO, 3600R, 3600V, 4100, 4600, 4600NO, 4600O, 4600SU, 5110, 5600, 5610, 5610S, 5700, 6600, 6610, 6610O, 6610S, 6700, 6710, 6810, 7010, 7410, 7600, 7600C, 7610, 7610O, 7700, 7710, TB80, TB85, TB90, TB100, TB110, TB120	Fan Shroud, Fiberglass Replaces D3NN8146A, E2NN8146BB, E6NN8146AA	AM81869055	\$ 110.00	
2600, 3600, 4100, 4600, 5600, 6600, 6700, 7600, 7700 - w/ Oil Cooler	Radiator Overall: 18 3/4" x 24 1/4"* Core: 18" x 17 3/4" x 2 3/4" 4 Rows, 9 Fins per Inch *Height Does Not Include Filler Neck Oil Cooler Ports are on the Engine Side	AMD5NN8005A	\$ 360.00	
3230, 3430, 3930, 3930H, 3930N, 4130, 4130N, 4630, 4630N, 4630NO, 4630O - 1990 and Later	Radiator Overall: 19" x 21 1/2"* Core: 18" x 16" 3 Rows, 8 Fins per Inch *Height Does Not Include Filler Neck	AME9NN8005AB15M	\$ 235.00	
5640, 6640 - w/ or w/o A/C	Radiator Core: 19 1/8" x 20 1/8" x 3" 5 Rows, 8 Fins per Inch	AM82015101	\$ 525.00	

Ford® / New Holland®—Tractor

Application	Description	Part Number	Retail Price	Core
5700, 6700 - 1976 and Later w/ Cab	Radiator Overall: 21 11/16" x 25 7/8" Core: 19 3/4" x 19 15/16" 3 Rows, 7 Fins per Inch *Height Does Not Include Filler Neck	AMD6NN8005D	\$ 570.00	
6710, 7700, 7710	Radiator Replaces E1NN8005EA15M, D8NN8005LA15M, D6NN8005SF	AME1NN8005EB15M	\$ 525.00	
(5110, 6410, 7410 - w/o A/C), 5610, 6610, (6810, 7610 - w/o A/C and w/o Viscous Fan)	Radiator Oil Cooler Ports are on the Engine Side	AME7NN8005BA	\$ 350.00	
7000, 7100, 7200	Radiator Core: 18" x 17 3/4" x 2 3/4" Oil Cooler Ports are on the Engine Side	AMD3NN8005B	\$ 310.00	
7910, 8210 - 1982 and Later	Radiator w/o Cooler	AME1NN8005BD15M	\$ 835.00	
8530, 8630, TW5, TW10, TW15, TW20	Radiator Replaces E3NN8005BD15M, E3NN8005AD15M	AM82847503	\$ 745.00	
8730, 8830, TW25, TW35 - w/ Oil Cooler	Radiator Core: 22 1/8" x 25" x 2 3/4" 4 Rows, 11 Fins per Inch	AME3NN8005DE15M	\$ 810.00	
8830, TW30, TW35	Radiator w/o Hydraulic Oil Cooler Overall: 24 9/16" x 31" Core: 22" x 25" 4 Rows, 10 Fins per Inch *Height Does Not Include Filler Neck	AME3NN8005CE15M	\$ 625.00	
T2310	Radiator Core: 17 5/8" x 16 3/4" x 1 7/8"	AM87305450	\$ 400.00	
T6030, T6050, T6070, T6080	Radiator Aluminum Core: 20.72" x 23.44" x 4.80" 4 Rows, 4.80 Fins per Inch Replaces 84160716, 87575998, 87737096	AM87575996	\$ 978.50	
(T6030, T6050, T6070, T6080 BSN Z*BK40000)	Radiator 6 Rows Replaces 87575996, 87575998, 87737096	AM87737098	\$ 890.97	
T6070	Radiator	AM87574213	\$ 871.18	
T8030, T8040, T8050, TG275, TG305	Radiator Core: 20" x 31.50" x 4" 6 Rows, 7 Fins per Inch	AM87448824	\$ 993.00	
TM120, TM130	Radiator Overall: 31" x 22 1/4" Core: 22 1/8" x 21" x 4"	AM87352188	\$ 1110.00	
TM140, TM155, TS115A, TS125A, TS135A	Radiator There is a 5/8" heater bypass connection to the right of the outlet connection Overall: 31" x 22 1/4" Core: 23 1/2" x 20 1/2" x 5"	AM87352191	\$ 1110.00	
TM175, TM190	Radiator Core: 21 1/4" x 27 3/4" x 5" 7 Rows, 7 Fins per Inch Outlet is left of center Replaces 82033525, 82033792, 82038688, 87306754	AM87352193	\$ 810.00	
TS115A, TS125A, TS135A	Radiator Outlet is right of center, 3/8" vent tube on top of tank, 5/8" vent tube on bottom of tank Replaces 82033774	AM87306756	\$ 1190.00	
Workmaster 55, Workmaster 65, Workmaster 75	Fan Shroud	AM87757220	\$ 16.00	
T9.615, T9.670	Charge Air Cooler	AM84286668	\$ 2250.00	

Prices Subject to Change without Prior Notice. The use of original equipment manufacturer (OEM) part numbers or trademarks, e.g. Case® and John Deere®, are for reference purposes only and for indicating product use and compatibility. Our company and the listed replacement parts contained herein are not sponsored, approved or manufactured by the OEM. All parts are New unless designated Reman in the description.

Ford® / New Holland®—Tractor

Application	Description	Part Number	Retail Price	Core
Utility: 1530, 1630, 1725, 1925, TC25, TC25D, TC29, TC29D, TC29DA, TC33, TC33D, TC33DA	Radiator Core: 15.50" x 15.75" x 1.75" Includes Bracket for Shield Screen w/ Remote Drain	AM86402723	\$ 578.00	
Utility: T2210, T2220, TC31DA, TC34DA	Radiator Core: 17.625" x 14.875" x 1.75" 2 Rows, 10 Fins per Inch	AM87305451	\$ 369.00	
Utility: T2320, T2330, TC45A, TC45DA	Radiator Core: 17.625" x 16.75" x 2.25" 2 Rows, 10 Fins per Inch	AM87305449	\$ 532.00	
Utility: TC35, TC35A, TC35D, TC35DA, TC40, TC40A, TC40D, TC40DA	Radiator Core: 17 3/8" x 14 3/4" 3 Rows Includes Cap Replaces 86400443, 86401465, 86402465	AM86402724	\$ 385.00	
(3010S, 3230, 3830 Orchard, 4010S, 4030 Orchard, TT55, TT60A, TT65 - w/ 3 Cylinder Engine), (4230 Orchard, 4330V, 4430 Orchard, 5010S, 5530, 6530, TT45A, TT50A, TT75, TT75A, Workmaster 55, Workmaster 65, Workmaster 75 - w/ 4 Cylinder Engine), 4835, 5635, 6635, 7635, 8160, 8260, 8360, 8560, (8830, TV140, Workmaster 45 - w/ 6 Cylinder Engine), L65, PowerStar™ 65, PowerStar™ 75, T4020, T4020V, T4030, T4030F, T4030N, T4030V, T4040, T4040F, T4040N, T4040V, T4050, T4050F, T4050N, T4050V, T4060F, T4060N, T4060V, T4.55, T4.65, T4.65V, T4.75, T4.75F, T4.75V, T4.85F, T4.85V, T4.95F, T4.95V, T4.105F, T4.105V, T5040, T5050, T5060, T5070, TD60D, TD70D, TD75D, TD80D, TD85F, TD90D, TD95D, TD4020F, TD4030F, TD4040F, TD5010, TD5020, TD5030, TD5050, TD4.90F, TL70, TL80, TL80A, TL90, TL90A, TL100, TL100A, TM115, TM125, TM135, TM150, TM165, TN55, TN55D, TN55S, TN60A, TN60DA, TN60SA, TN60VA, TN65, TN65D, TN65F Orchard, TN65S, TN65V, TN70, TN70A, TN70D, TN70DA, TN70F Orchard, TN70NA, TN70S, TN70SA, TN70VA, TN75, TN75A, TN75D, TN75DA, TN75F Orchard, TN75FA, TN75S, TN75SA, TN75V, TN75VA, TN80F Orchard, TN85A, TN85DA, TN85FA Orchard, TN85SA, TN90F Orchard, TN95A, TN95DA, TN95F Orchard, TN95FA Orchard, TN95NA, TN95VA, Workmaster 75	Rubber Mount	AM5108225	\$ 8.00	

Radiator Hoses



Application	Description	Part Number	Retail Price	Core
2N, 8N, 9N	Radiator Hose, Upper 1.50" ID	AM2N8260	\$ 4.50	
60 1959-63, (501, 601 - 1957-62), (541, 611 - 1959-64), 600 (1957), 620 1954-64, (621, 631, 641, 651 - 1958-64), (630, 640 - 1955-57), 650 1956-57, 700, 800, 900, (2000, 4000 - 1962-64), (2031, 4031 - 1960-62), (2111, 2120, 2130, 2131, 4110TR, 4120, 4121, 4130, 4131, 4140 - 1963-64), (4030, 4040 - 1961-62), Jubilee, NAA - All w/ 4 Cylinder Engine	Radiator Hose, Upper 1.25" ID Replaces 310048	AMNAA8260B	\$ 4.00	

Ford® / New Holland®—Tractor

Application	Description	Part Number	Retail Price	Core
(230A, 334, 3610V 1981-04/83 w/ 3 Cylinder Engine), (231, 233, 333, 531, 2600N, 2600R, 3600, 3600N, 3600V, 3900, 4600O 1975-81 w/ 3 Cylinder Engine), (234 1975-04/83, 2000, 2100 03/1965-74, 2310 03/1982-83, 2600V 10/1975-09/76, 2610V 1970-02/90, 3600R 1975-77, 3610NO 08/1981-04/83, 3910 05/1983-02/90, 3910R (981-84, 3910V 12/1983-02/90, 4000 Diesel, 4110N 12/1981-02/90, 4410 1969-74, 4600NO 10/1975-81, 4600SU 1975-07/81 - w/ 3 Cylinder Engine), (335, 340, 2610, 2810, 3000, 3055, 3100, 3400, 3610, 4000SU, 4100, 4110, 4600, 4610, 5600 w/ Transmission Oil Cooler - Diesel), (2110, 2120, 2300, 4190, 4200, 4330, 4340 1965-74 w/ 3 Cylinder Engine), 2600, 5000, 5100, 6600, 6700, 7000, 7100, 7600, (2910, 3910H, 3910N 1983-02/90 w/ 3 Cylinder Engine), (4110NO, 4110O, 4110V, 4610NO 1981-02/90 w/ 3 Cylinder Engine), (5110 05/1984-10/91, 6710 1981-09/85, 7610O 10/1981-91, 7700 1976-80, 7710 1981-10/91 w/ 4 Cylinder Engine), (6810, 7410 04/1989-10/91 w/ 4 Cylinder Engine), (5610, 5900, 6610, 7610 Prior to 07/31/1987), Ind: (420, 445, 445A, 515, 535, 540, 540A, 540B, 545, 545A, 3500, 3550, 4500 - Diesel)	Radiator Hose, Upper 1.50" ID Replaces 81805628, 83907414, C5NN8260A, C5NN8260B, D5NN8260DV	AMD5NN8260D	\$ 5.95	
(231, 233, 333, 531, 2600, 2600N, 2600R, 3600, 3600N, 3600V, 3900, 4100, 4600, 5700, 6700 - 1975-81 w/ 3 Cylinder Engine), (2600V 10/1975-09/76, 3600R 1975-77, 4600NO 10/1975-81, 4600O, 4600SU 1975-07/81 - w/ 3 Cylinder Engine), (5110 05/1984-10/91, 5900 05/1985-93, 7610 1981-10/91, 7610O 10/1981-91, 7710 Prior to 07/1987 w/o A/C - w/ 4 Cylinder Engine), (5610, 6610 - 1981-93 w/ 4 Cylinder Engine), (6710, 7700 - w/o A/C w/ 4 Cylinder Engine), (6810, 7410 - 04/1989-10/91 w/ 4 Cylinder Engine)	Radiator Hose, Upper 1.50" ID Replaces 83905554, D5NN8260CV, K916316	AMD5NN8260C	\$ 12.66	
(231, 233, 333, 531, 2600, 2600N, 2600R, 3600, 3600N, 3600V, 3900, 4100, 4600, 4600O 1975-81 w/ 3 Cylinder Engine), (2600V 10/1975-09/76, 3600R 1975-77, 4600NO 10/1975-81, 4600SU 1975-07/81 - w/ 3 Cylinder Engine), (5110 05/1984-10/91, 5900 05/1985-93, 6710, 7610 1981-10/91, 7610O 10/1981-91, 7700, 7710 - w/ 4 Cylinder Engine), (5610, 6610 1981-93 w/ 4 Cylinder Engine), (6810, 7410 04/1989-10/91 w/ 4 Cylinder Engine)	Radiator Hose, Upper 1.50" ID	AMD4NN8260C	\$ 13.76	
(231, 233, 333, 531, 2600, 2600N, 2600R, 3600, 3600N, 3600V, 3900, 4100, 4600O - 1975-81 w/ 3 Cylinder Engine), (2600V 10/1975-09/76, 3600R 1975-77, 4600NO 10/1975-81, 4600SU 1975-07/81 - w/ 3 Cylinder Engine), (4610, 7700 1976-80 - w/ 4 Cylinder Engine)	Radiator Hose, Upper 1.50" ID	AMD6NN8260A	\$ 16.29	
2000, 2100, 2110, 2120, 2300, 2310, 2600, 2610, 2810, 2910, 3000, 3055, 3100, 3110, 3120, 3190, 3300, 3310, 3330, 3400, 3600, 3610, 3910, 4000, 4100, 4110, 4330, 4340, 4400, 4410, 4600, 4610, 5600, 6600, 7600, Ind: 230A, 234, 334, 340, 340A, 445, 445A, 450, 530A, 540, 540A, 540B, 545, 545A, 3500, 3550, 4500	Radiator Hose, Upper 1.50" ID	AMC5NN8260D	\$ 7.02	
3230 03/1990-09/94, 3430, 3930 05/1990-07/99, 3930N 03/1990-06/95, (3930NO, 4130NO, 4630N, 4630NO, 4630O - 03/1990-08/99), 4130 03/1990-07/99, 4630 - All w/ 3 Cylinder Engine	Radiator Hose, Upper 1.50" ID	AME9NN8260AA	\$ 16.18	
(3230, 3430, 4630 - w/ 3 Cylinder Engine w/o Spigot), (3930, 3930N 03/1990-06/95, 4130 03/1990-07/99 - w/ 3 Cylinder Engine), (3930NO, 4130NO, 4630N, 4630NO, 4630O - 03/1990-08/99 w/ 3 Cylinder Engine)	Radiator Hose, Upper 1.50" ID Replaces 82015118	AMF0NN8260AA	\$ 12.42	
(4000, 4110, 4190, 4330, 4340 1965-74 with 3 Cylinder Engine), 4100 w/ 3 Cylinder Engine, 4200 Gas or Diesel, 5200, 4410 1969-74 w/ 3 Cylinder Engine, Ind: 4500 1965-74 w/ 3 Cylinder Engine	Radiator Hose, Upper 1.50" ID	AMC5NN8260E	\$ 12.92	
4010S 1996 and Later w/ 3 Cylinder Engine, (5530, 6530 03/1992-97 w/ 4 Cylinder Engine)	Radiator Hose, Upper	AM5104825	\$ 25.89	
4830, 4830N 07/1990-05/94 w/ 4 Cylinder Engine, 5030, 5030O 06/1994-04/98 w/ 4 Cylinder Engine	Radiator Hose, Upper 1.50" ID	AMF0NN8260BB	\$ 23.60	
5110 05/1984-10/91, (5610, 6610 - 1981-93), 5900 05/1985-93, 6710 1981-09/85, (6810, 7410 - 04/1989-10/91), 7610 1981-10/91, 7610O 10/1981-91, 7710 08/1987 and Later w/ A/C - All w/ 4 Cylinder Engine	Radiator Hose, Upper 1.50" ID	AME6NN8260AA	\$ 20.60	

Ford® / New Holland®—Tractor

Application	Description	Part Number	Retail Price	Core
(5110 05/1984-10/91, 5610S 1993 and Later, 6710 1981-09/85, 76100 10/1981-91, 7710 1981-10/91 - w/ 4 Cylinder Engine), (6610S, 7610S - 1994 and Later w/ 4 Cylinder Engine), (6810, 7410 - 04/1989-10/91 w/ 4 Cylinder Engine), (5610, 5900, 6610, 7610 - 08/1987 and Later), Backhoe-Loaders: 655, 655A 08/1987 and Later, 655C Prior to 08/1993	Radiator Hose, Upper 1.625" ID Replaces E7NN8260BA	AME6NN8260CA	\$ 7.82	
5640, 6640, 7740	Radiator Hose, Upper 1.50" ID Replaces 81862934, 87745807, DONN8260CA	AMF0NN8260CA	\$ 7.71	
7810 w/ BSD666 Engine, (78100 02/1988-10/91, 8010 04/1996 and Later - w/ 6 Cylinder Engine), 7810S	Radiator Hose, Upper 1.75" ID Replaces 83961073, 87745813	AME7NN8260AA	\$ 11.30	
7840, 78400 02/1993-01/98 w/ 6 Cylinder Engine, 8240, 8340	Radiator Hose, Upper 1.50" ID Replaces 81862935	AMF0NN8260DA	\$ 13.51	
(7910, 8210 - w/ BSD666 Engine)	Radiator Hose, Upper 1.75" ID Replaces 83929875	AME0NN8260AA	\$ 33.95	
(8000 1968-78, 8200 1968-09/72, 8600 10/1972-07/76, 8700 08/1976-78, 9200 1969-09/72, 9600 10/1973-07/76, 9700 08/1976-78 - w/ 6 Cylinder Engine), 9000 Prior to 09/1972, Ind: 8400 1971-09/72 w/ 6 Cylinder Engine	Radiator Hose, Upper 1.75" ID	AMC9NN8260A	\$ 29.71	
8000 Prior to 07/1976, (8200 1968-09/72, 8600 10/1972-07/76, 8700 08/1976-78, 9000 1969-78, 9200 1969-09/72, 9600 1973-07/76, 9700 1976-78 - w/ 6 Cylinder Engine), Ind: 8400 1971-09/72 w/ 6 Cylinder Engine	Radiator Hose, Upper 1.50" ID	AMD2NN8260B	\$ 18.80	
(8000 1968-78, 8200 1968-09/72, 8600 10/1972-07/76, 8700 08/1976-78, 9200 1969-09/72, 9600 10/1973-07/76, 9700 08/1976-78 - w/ 6 Cylinder Engine), 9000 (Prior to 07/1976), Ind: 8400 1971-09/72 w/ 6 Cylinder Engine	Radiator Hose, Upper 1.75" ID	AMD2NN8260C	\$ 16.06	
(8000 1968-78, 8200 1968-09/72, 8600 10/1972-07/76, (8700, 9700 - 08/1976-78), 9000 1969-78, 9200 1969-09/72, 9600 10/1973-07/76 - w/ 6 Cylinder Engine), TW10, TW20, TW30, Ind: 8400 1971-09/72 w/ 6 Cylinder Engine	Radiator Hose, Upper 1.75" ID	AMD8NN8260BB	\$ 24.84	
(8000, 9000 - 08/1976 and Later), 8700, 9700, 8200 1968-09/72, 8600 10/1972-07/76, 9200 1969-09/72, 9600 10/1973-07/76, Ind: 8400 1971-09/72 w/ 6 Cylinder Engine	Radiator Hose, Upper 1.75" ID Replaces 83914013	AMD8NN8260CA	\$ 16.98	
(8530, 8630, 8730 - 03/1990-93 w/ 6 Cylinder Engine), 8830, TW5, TW15, TW25, TW35	Radiator Hose, Upper 1.75" ID Replaces 83918850, 83933451, 83934898	AME3NN8333AA	\$ 15.38	
8670, 8670A, 8770, 8770A, 8870, 8870A, 8970, 8970A	Radiator Hose, Upper 2" ID Replaces 86013975	AM9821598	\$ 21.49	
Dexta	Radiator Hose, Upper 1.625" ID Replaces 81718085, 87295814	AM957E8260A	\$ 20.19	
Major, Super Major	Radiator Hose, Upper 1.75" ID Replaces 87295271, E1ADKN8260	AM81718084	\$ 11.27	
Super Dexta	Radiator Hose, Upper 1.75" ID Replaces 81805632	AM957E8260B	\$ 21.48	
Utility: 1100	Radiator Hose, Upper 1.25" ID	AMSBA310160320	\$ 17.23	
Utility: 1110 w/ Manual Transmission	Radiator Hose, Upper 1.312" ID	AMSBA310160780	\$ 9.39	

Ford® / New Holland®—Tractor

Application	Description	Part Number	Retail Price	Core
Utility: 1120, 1210, 1215, 1220, 1310	Radiator Hose, Upper 1" ID	AMSBA310160730	\$ 15.97	
Utility: 1200	Radiator Hose, Upper 1.25" ID	AMSBA310160460	\$ 35.41	
Utility: 1320, 1520, 1620, 1715, 1720, 1920, T1520, TC30	Radiator Hose, Upper 1.312" ID	AMSBA310160932	\$ 15.43	
Utility: 1300	Radiator Hose, Upper 1" & 1.25" ID	AMSBA310160290	\$ 24.78	
Utility: 1500	Radiator Hose, Upper 1.25" ID	AMSBA310160380	\$ 22.56	
Utility: 1510	Radiator Hose, Upper 1.25" ID	AMSBA310160750	\$ 16.95	
Utility: 1530, 1630, 1725, 1925, TC25, TC25D, TC29, TC29D, TC33, TC33D	Radiator Hose, Upper 1.312" ID	AM86519847	\$ 9.47	
Utility: 1600	Radiator Hose, Upper 1.25" ID	AMSBA310160050	\$ 18.62	
Utility: 1700 10/1979 and Later, 1710	Radiator Hose, Upper 1.312" ID	AMSBA310160450	\$ 19.96	
Utility: 1700, 1900 1979-09/79	Radiator Hose, Upper 1.25" ID	AMSBA310160170	\$ 18.86	
Utility: 1900 ASN U902326 10/1979 and Later	Radiator Hose, Upper 1.25" ID	AMSBA310160430	\$ 27.14	
Utility: 1910	Radiator Hose, Upper 1.25" ID	AMSBA310160840	\$ 19.24	
Backhoe-Loaders: (550, 555, 555A, 555B - Gas)	Radiator Hose, Upper 1.50" ID	AMD4NN8260A	\$ 12.23	
Backhoe-Loaders: 750, 755, 755A, 755B, 7500	Radiator Hose, Upper 1.50" ID	AMD1NN8260B	\$ 15.96	
2N, 8N, 9N	Radiator Hose, Lower 1.562" ID	AM8N8286	\$ 7.50	
2N, 8N, 9N, 501 Series, 600, 601 Series, 650, 701 Series, 800, 801 Series, 1800 Series, (2000, 4000 - 1962-64 w/ 4 Cylinder Engine), 2030, 2120, 2130, 4030, 4040, 4120, 4130, 4140, Ind: 660	Radiator Hose, Lower 1.50" ID	AM312588	\$ 5.00	
(230A, 334, 3610V - 1981-04/83 w/ 3 Cylinder Engine), (231, 233, 333, 531, 2600N, 2600R, 3600N, 3600V, 3900, 4600O - 1975-81 w/ 3 Cylinder Engine), (234 1975-04/83, 2310 03/1982-83, 2600V 10/1975- 09/76, 2610V 1970-02/1990, 3600R 1975-77, 3610NO 08/1981-04/83, 3910 05/1983-02/90, 3910R 1981-84, 3910V 12/1983-02/90, 3930N 03/1990-06/95, 4110N 12/1981-02/90, 4410 1969-12/74, 4600NO 10/1975-81, 4600SU 1975-07/81 - w/ 3 Cylinder Engine), (2000, 3230, 3930, 4000, 4630 - w/ 3 Cylinder Engine), 340, 2600, 2610, 2810, 3000, 3055, 3100, 3400, 3430, 3600, 3610, 4100, 4110, 4600, 4610, 4830, 5030, 6600, (2100, 2110, 2120, 2300, 2310, 3110, 3120, 3190, 3300, 3310, 3330, 4190, 4200, 4330, 4340 - 1965-74 with 3 Cylinder Engine), (2910, 3910H, 3910N - 1983-02/90 w/ 3 Cylinder Engine), (3930NO, 4130NO, 4630N, 4630NO, 4630O - 03/1990-08/99 w/ 3 Cylinder Engine), (4110NO, 4110O, 4110V, 4610NO - 1981-02/90 w/ 3 Cylinder Engine), (4830N 07/1990-05/94, 5030O 06/1994-04/98, 7700 1976-80 - w/ 4 Cylinder Engine), Ind: 420, 445, 515, 540, 3500, 3550, 4130 1963-64, 4500 1965-74 w/ 3 Cylinder Engine	Radiator Hose, Lower	AMC5NN8286B	\$ 7.84	

Ford® / New Holland®—Tractor

Application	Description	Part Number	Retail Price	Core
(231, 233, 333, 531, 2600, 2600N, 2600R, 3600, 3600N, 3600V, 3900, 4100, 4600, 4600NO, 4600O - 1975-81 w/ 3 Cylinder Engine), 335, 2100 03/1965-74, 2600V 10/1975-09/76, 3600R 1975-77, 4600SU 1975-07/81, 5000, 5100, 5600, 5900, 7000, 7100, 7600, (2000, 2110, 2120, 2300, 3055, 4000, 4100, 4110, 4190, 4200, 4330, 4340, 4410 - 1965-74 w/ 3 Cylinder Engine), (5110 05/1984-10/91, 5610 1981-93, 5610S 12/1993 and Later, 6600 - w/o Oil Cooler, 6610 1981-93, 6610S 1994 and Later, 6710 1981-09/85, 7010 04/1996 and Later, 7610O 10/1981-91, 7610S 1994 and Later, 7700 1976-80 - w/ 4 Cylinder Engine), (6810, 7410 - 04/1989-10/91 w/ 4 Cylinder Engine), (7610, 7710 - 1981-10/91 w/ 4 Cylinder Engine), Ind: 445 Gas or Diesel, 535, 540A Diesel, 540B Diesel, 545, 545A Diesel, (3500, 3550 1965-74 w/ 3 Cylinder Engine), 4500	Radiator Hose, Lower 1.645" & 1.757" ID Replaces 81805638, 83907879, 87745803, C5NN8286CV	AMC5NN8286C	\$ 10.95	
(231, 233, 333, 531, 2600, 2600N, 2600R, 3600, 3600N, 3600V, 3900, 4100, 4600, 4600O - 1975-81 w/ 3 Cylinder Engine), (4600NO 10/1975-81, 2600V 10/1975-09/76, 3600R 1975-77, 4600SU 1975-07/81 w/ 3 Cylinder Engine), (5110 05/1984-10/91, 5610S 12/1993 and Later, 5900 05/1985-12/93, 6710 1981-09/85, 7010 04/1996 and Later, 7610O 10/1981-91, 7700 1976-80, 7710 1981-10/91 - w/ 4 Cylinder Engine), (5600, 6600 - w/ 4 Cylinder Engine w/ Transmission Oil Cooler), 5610, 6610, (6610S, 7610S 1994 and Later w/ 4 Cylinder Engine), (6810, 7410 04/1989-10/91 w/ 4 Cylinder Engine), 7610	Radiator Hose, Lower 1.812" ID Replaces 83907879, 87745809	AMD5NN8286F	\$ 16.40	
231, 233, 333, 531, 2600, 2600N, 2600R, 3600, 3600N, 3600V, 3900, 4100, 4600, 4600O - 1975-81 w/ 3 Cylinder Engine, (2600V 10/1975-9/76, 3600R 1975-77, 4600NO 10/1975-81, 4600SU 1975-07/81 - w/ 3 Cylinder Engine), (4000, 4110, 4190, 4200, 4330, 4340 - 1965-74 w/ 3 Cylinder Engine), 4410 1969-74 w/ 3 Cylinder Engine, 5200, 6600C, 7200, 7600C, 7700 1976-80 w/ 4 Cylinder Engine, Ind: 4500 1965-74 w/ 3 Cylinder Engine	Radiator Hose, Lower 1.75" ID	AMD0NN8286A	\$ 26.78	
(231, 233, 333, 531, 2600, 2600N, 2600R, 3600, 3600N, 3600V, 3900, 4100, 4600, 4600O - 1975-81 w/ 3 Cylinder Engine), (4600NO 10/1975-81, 4600SU 1975-07/81, 2600V 10/1975-09/76, 3600R 1975-77 - w/ 3 Cylinder Engine), (5110 05/1984-10/91, 5610 1981-93, 6610 1981-93, 6710 w/o A/C, 6810 04/1989-10/91, 7410 04/1989-10/91, 7610 1981-10/91, 7610O 10/1981-91, 7700 1976-80, 7710 w/o A/C - w/ 4 Cylinder Engine), 5700, 6700	Radiator Hose, Lower 1.75" ID Replaces 83909073	AMD6NN8286B	\$ 23.41	
(231, 233, 333, 531, 2600, 2600N, 2600R, 3600, 3600N, 3600V, 3900, 4100, 4600, 4600NO, 4600O - 1975-81 w/ 3 Cylinder Engine), (2600V 10/1975-09/76, 3600R 1975-77, 4600SU 1975-07/81 - w/ 3 Cylinder Engine), (5110 05/1984-10/91, 5610 1981-93, 6610 1981-93), 5900 1985-93), 6710 w/ A/C, 6810 04/1989-10/91, 7410 04/1989-10/91, 7610 1981-10/91, 7610O 10/1981-91, 7710 w/ A/C - w/ 4 Cylinder Engine), 7700	Radiator Hose, Lower 1.75" ID	AME8NN8286BA	\$ 19.77	
1000, Utility: 1600	Radiator Hose, Lower 2.75" & 2.875" ID	AMSBA310160060	\$ 26.68	
2000, 2120, 2150, 2300, 2310, 2600, 2600V, 2610, 2810, 2910, 3000, 3055, 3110, 3120, 3150, 3190, 3230, 3300, 3310, 3330, 3400, 3430, 3500, 3600, 3600V, 3610, 3900, 3910, 3930, 4110, 4130, 4140, 4190, 4330, 4340, 4400, 4410, 4600, 4600SU, 4610, 4630, 4830, 5000, 5030, 5190, 5340, 5600, 5700, 6600, 6700, 7000, 7600, 7700, Ind: 230A, 231, 233, 234, 250C, 260C, 333, 334, 335, 340, 340A, 340B, 420, 445, 445A, 450, 515, 530A, 531, 532, 535, 540, 540A, 540B, 545, 545A, 3550	Radiator Hose, Lower 1.725" ID Replaces C5NN8286B	AM81805637	\$ 7.00	
(4000, 4110, 4190, 4330, 4340 - 1965-74 w/ 3 Cylinder Engine), 4100 w/ 3 Cylinder Engine, 4200 Gas or Diesel, 4410 1969-74 w/ 3 Cylinder Engine, Ind: 4500 1965-74 w/ 3 Cylinder Engine	Radiator Hose, Lower 1.75" ID	AMC5NN8286D	\$ 20.41	
(5610S 12/1993 and Later, 6610S 1994 and Later, 7610O 10/1981-91 - w/ 4 Cylinder Engine), (6810, 7610 - 06/1989 and Later w/ A/C), 7610S 10/1997 and Later, 7810 w/ BSD666 Engine, 7810S, (7810O 02/1988-10/91, 8010 04/1996 and Later - w/ 6 Cylinder Engine)	Radiator Hose, Lower 1.97" ID Replaces 83961071, 83976368, 87745812	AME7NN8286AA	\$ 27.30	
5640, 6640, 7740, 7840, 7840O 02/1993-01/98 w/ 6 Cylinder Engine, 8240, 8340	Radiator Hose, Lower 1.75" ID Replaces 81868754	AMF0NN8286AB	\$ 18.01	
6000	Radiator Hose, Lower 1.875" ID	AMCONN8286A	\$ 7.47	

Ford® / New Holland®—Tractor

Application	Description	Part Number	Retail Price	Core
(7910, 8210 - w/ BSD666 Engine), (8000 1968-78, 8200 1968-09/72, 8600 10/1972-07/76, 8700 08/1976-78, 9000 1969-78, 9200 1969-09/72, 9600 10/1973-07/76, 9700 08/1976-78 - w/ 6 Cylinder Engine), TW10, TW20, TW30, Ind: 8400 1971-09/72 w/ 6 Cylinder Engine	Radiator Hose w/ Clamps, Lower 1.75" ID	AMD8NN8B274AB	\$ 11.44	
8000 Prior to 07/31/76, 9600 Radiator to Cooler, (8200 1968-09/72, 8600 10/1972-07/76, 8700 08/1976-78, 9000 10/1972-07/76, 9200 1969-09/72, 9700 08/1976-78 - w/ 6 Cylinder Engine), Ind: 8400 1971-09/72 w/ 6 Cylinder Engine	Radiator Hose, Lower 2" & 2.375" ID	AMC7NN8286A	\$ 13.93	
(8000 1968-78, 8200 1968-09/72, 8600 10/1972-07/76, 8700 08/1976-78, 9200 1969-09/72, 9600 10/1973-07/76, 9700 1976-78 - w/ 6 Cylinder Engine), 9000 Prior to 07/1976, Ind: 8400 1971-09/72 - w/ 6 Cylinder Engine	Radiator Hose, Lower 2" ID	AMC9NN8286A	\$ 16.15	
(8000, 8700, 9000 - 08/1976 and Later), 9700, (8200 1968-09/72, 8600 10/1972-07/76, 9200 1969-09/72, 9600 10/1973-07/76 - w/ 6 Cylinder Engine), Ind: 8400 1971-09/72 w/ 6 Cylinder Engine	Radiator Hose, Lower 1.75" & 2" ID Replaces 86620261	AMD6NN8286C	\$ 31.28	
8670, 8670A, 8770, 8770A, 8870, 8870A, 8970, 8970A	Radiator Hose, Lower 2" & 2.06" ID	AM9821599	\$ 18.96	
Dexta, Super Dexta	Radiator Hose, Lower 1.28" & 1.40" ID	AM957E8286	\$ 29.70	
Major, Super Major, Power Major	Radiator Hose, Lower 1.75" ID Replaces E1ADDN8286	AM81718086	\$ 15.46	
(Workmaster 65, Workmaster 75 - Prior to 09/2018)	Radiator Hose, Lower	AM87473908	\$ 12.00	
Ind: 7500	Radiator Hose, Lower 1.75" ID	AMD1NN8286B	\$ 36.09	
Utility: 1110 w/ Hydrostatic Transmission	Radiator Hose, Lower	AMSBA310160770	\$ 8.44	
Utility: 1110 w/ Manual Transmission	Radiator Hose, Lower 1.312" ID	AMSBA310160790	\$ 7.93	
Utility: 1120, 1210, 1215, 1220, 1310	Radiator Hose, Lower 1" ID	AMSBA310160740	\$ 18.37	
Utility: 1320, 1520, 1620, 1715	Radiator Hose, Lower 1.25" ID	AMSBA310161091	\$ 9.13	
Utility: 1500	Radiator Hose, Lower 1.25" ID	AMSBA310160310	\$ 27.63	
Utility: 1510, 1710	Radiator Hose, Lower 1.312" ID	AMSBA310160441	\$ 18.84	
Utility: 1530, 1630, 1725, TC25, TC25D, TC29, TC29D	Radiator Hose, Lower 1.312" ID	AM86519855	\$ 11.93	
Utility: (1700, 1900 - 1979-09/79)	Radiator Hose, Lower 1.312" ID	AMSBA310160150	\$ 27.18	
Utility: (1700, 1900 - 10/1979 and Later)	Radiator Hose, Lower 1.25" ID	AMSBA310160350	\$ 27.84	
Utility: 1720, 1920	Radiator Hose, Lower 1.312" ID	AMSBA310161031	\$ 11.99	
Utility: 1910	Radiator Hose, Lower 1.25" & 1.532" ID	AMSBA310160850	\$ 23.34	
Utility: 1925, TC33, TC33D	Radiator Hose, Lower 1.312" ID	AM86526943	\$ 11.78	
Utility: T1520, TC30	Radiator Hose, Lower 1.312" ID	AMSBA310161630	\$ 15.93	
Backhoe-Loaders: 550, 555, 555A Gas, 555B, 650, 655, 655A, 655C Prior to 08/1993, 6500	Radiator Hose, Lower 1.75" ID Replaces 83902995	AMD3NN8286G	\$ 14.80	
Backhoe-Loaders: 750, 755, 755A, 755B	Radiator Hose, Lower 1.75" ID	AMD8NN8286AA	\$ 36.38	
Wheel Loaders: A64, A66	Radiator Hose, Lower 2" ID	AMD3NN8286E	\$ 6.34	
(Dexta, Super Dexta - Prior to 09/30/1989)	Radiator Hose 1.625" ID Replaces 957E8333B	AM81718101	\$ 21.51	

Prices Subject to Change without Prior Notice. The use of original equipment manufacturer (OEM) part numbers or trademarks, e.g. Case® and John Deere®, are for reference purposes only and for indicating product use and compatibility. Our company and the listed replacement parts contained herein are not sponsored, approved or manufactured by the OEM. All parts are New unless designated Reman in the description.

Ford® / New Holland®—Tractor

Application	Description	Part Number	Retail Price	Core
Fordson Major, Fordson Super Major, Fordson Power Major	Radiator Hose 1.75" ID	AM81718097	\$ 8.19	
1320, 1520, 1530, 1620, 1630, 1710, 1710O, 1715, 1720, 1725, 1920, 1925, 2030, 2120, 3415, Boomer 1020, Boomer 1025, Boomer 1030, Boomer 2035, Boomer 3040, Boomer 3045, Boomer 3050, Boomer 4055, Boomer 4060, T1010, T1030, T1110, T1510, T1520, T2210, T2220, T2310, T2320, T2330, T2410, T2420, TC23DA, TC24D, TC24DA, TC25, TC25D, TC26DA, TC29, TC29D, TC29DA, TC30, TC31DA, TC33, TC33D, TC33DA, TC34DA, TC35, TC35A, TC35D, TC35DA, TC40, TC40A, TC40D, TC40DA, TC45, TC45A, TC45D, TC45DA, TC48DA, TC55DA, TT45A, TT50A, TZ18DA, TZ22DA, TZ25DA	Bypass Hose 0.54" ID Replaces 83938274, 83966732, 87772767, 87780789, SBA145536050, SBA145536380, SBA145537020	AMSBA145536051	\$ 6.39	
Dexta, Super Dexta	Bypass Hose 1.125" ID Replaces 747936M91, 81716947, 86513585, E6CJ9, E15CJ9	AM731256M1	\$ 5.76	
Dexta, Super Dexta	Water Pump Inlet Hose 1.375" ID Replaces 8176946	AM732443M1	\$ 8.10	



Engine Fans and Components

Application	Description	Part Number	Retail Price	Core
500 Series, 600 Series, 800 Series, 900 Series, 2000, 4000 - Gas	Engine Fan 3 Blade Fan 16" Diameter, 3.12" Bolt Circle Diameter, 0.625" Pilot Hole Diameter	AMNCA8600S	\$ 52.00	
5610S ASN 308716M, 6610S ASN 359818M, 6810S, 7600, 7610, 7610S, 7810, 7810S, 8010, TB80, TB85, TB90, TB100, TB110, TB120	Engine Fan 7 Blade, 17.50" Diameter, 5/8" Pilot Hole	AME8NN8600DB	\$ 75.00	
TG210, TG230, TG255, TG285	Engine Fan 8 Blade, 6-Bolt Hub Replaces 87778091	AM278432A1	\$ 350.00	
501, 541, 600, 601, 611, 620, 621, 630, 631, 640, 641, 650, 651, 660, 661, 671, 681, 700, 701, 740, 741, 771, 800, 801, 811, 820, 821, 840, 841, 850, 851, 860, 861, 871, 881, 900, 901, 941, 946, 950, 951, 960, 961, 971, 981, 2000, 2031, 2111, 2130, 2131, 4000, 4030, 4031, 4110, 4120, 4121, 4130, 4140	Fan Shroud Replaces NCA8146A	AM86551380	\$ 74.00	



Flywheels and Components

Application	Description	Part Number	Retail Price	Core
2N, 8N, 9N, 600, 700, 800, 900, (2000, 4000 - Prior to 1964), NAA, NAB	Flywheel Ring Gear 134 Tooth, 11.994" ID, 13.552" OD	AM9N6384	\$ 24.50	
2000, 2100, 2110, 2120, 2300, 2310, 2600, 2610, 2810, 2910, 3000, 3055, 3100, 3120, 3190, 3300, 3310, 3330, 3400, 3600, 3610, 3900, 3910, 4000, 4100, 4110, 4190, 4200, 4330, 4340, 4410, 4600, 4610, 5000, 5100, 5190, 5200, Ind/Const: 230A, 231, 233, 234, 333, 334, 335, 340, 340A, 340B, 420, 445, 445A, 450, 515, 530A, 531, 532, 535, 540, 540A, 540B, 545, 545A, 550, 555, 555A, 555B, 655, 655A, 3500, 3550, 4400, 4500, 5500, 5550	Flywheel Ring Gear 162 Tooth, 14.634" ID, 16.245" OD	AMC5NE6384B	\$ 192.63	
2000, 2600, 2610, 3000, 3230, 3430, 3600, 3610, 3930, 4000, 4110, 4200, 4430, 4600, 4610, 4630, 5000, 5600, 5700, 6600, 6700, 7000, 7600, 7700, 8000, 9000, TW5, TW10, TW15, TW20, TW25, TW30, TW35	Flywheel Ring Gear 128 Tooth, 16.115" OD, 14.52" ID, 0.625" Wide	AME2NN6384AA	\$ 40.00	

Ford® / New Holland®—Tractor

Application	Description	Part Number	Retail Price	Core
Dexta, Super Dexta	Flywheel Ring Gear Replaces 957E6384, 81804209	AM957E6384B	\$ 80.00	
8670, 8670A, 8770, 8770A, 8870, 8870A, 8970, 8970A	Drive Plate 36 Spline, 13" OD	AM9825201	\$ 580.00	

Water Pumps and Components

The remanufactured water pumps we supply have an extra step added to the remanufacturing process to ensure quality. Since the bearing and seal assembly are critical in performance, we ensure air-tight seals by vacuum testing our water pumps prior to packaging. This guarantees no leakage will occur after your water pump has been installed.



Application	Description	Part Number	Retail Price	Core
3 Cylinder and 4 Cylinder Tractors, 1965-88	Water Pump w/ Single Groove Pulley, 5/16" and 3/8" Bolts	AM82845215	\$ 53.00	
3 Cylinder and 4 Cylinder Tractors, 1965-11/86	Water Pump w/ Double Groove Pulley, 5/16" and 7/16" Bolts	AM87800109	\$ 60.00	
	Reman Water Pump w/ Double Groove Pulley, 5/16" and 3/8" Bolts	AMEAPN8A513E-R	\$ 90.00	\$ 25.00
2N, 8N, 9N	Water Pump w/ Single Groove Pulley	AMCDPN8501A	\$ 42.00	
600, 700, 800, 900, 2000, 4000 Series - 1955-64 Models w/ 172 Gas or Diesel Engine	Water Pump w/ Hub For Bolt-On Pulley	AM3971351	\$ 45.00	
600, 800, 900, 2000 & 4000 Series - 1955-64 Models w/ Gas or Diesel Engine	Water Pump w/ Single Groove Pulley	AMCDPN8501C	\$ 60.00	
1120, 1210, 1215, 1220, 1310	Water Pump	AMSBA145017300	\$ 104.00	
1164 1972-7/76, (8000, 8200 1968-7/76), 8600 1972 and Later, Ind: 8400 1972 and Later	Reman Water Pump w/ Single Groove Pulley, 5/16" and 3/8" Bolts 5 5/8" Diameter Pulley, 2 5/8" Tall, 4" Diameter Impeller	AMDHPN8A513B-R	\$ 89.00	\$ 25.00
(1720, 1920, 3415 - 1987 and Later), 2120 03/1999 and Later, Boomer 4055, Boomer 4060, T1510, T1520, T2210, T2220, T2310, T2320, T2330, T2410, T2420, TC33, TC33D, TC34DA, TC35, TC35A, TC35D, TC35DA, TC40, TC40A, TC40D, TC40DA, TC45, TC45A, TC45D, TC45DA, TC48DA, TC55DA, TT45A, TT50A	Water Pump	AMSBA145017790	\$ 151.52	
3010S, 3830, 4230, 4330V, 4430, 4835, 5530, 5635, 6530, 6635, 7635, TL100, TL70, TL80, TL90, TN55, TN55D, TN55S, TN60VA, TN65, TN65D, TN65F, TN65S, TN65V, TN70, TN70D, TN70F, TN70S, TN75, TN75D, TN75F, TN75S, TN74V, TN80F, TN90F, TN95F, TT55, TT75	Water Pump	AM99454833	\$ 128.00	
4830, 4830N, 4830O, 5030, 5030O, 5110, 5610, 6410, 6610, 6610O, 6710, 6810, 7410, 7610O, 7710	Water Pump Replaces 81872278, 83960873, E6NN8501HA	AM87800119	\$ 142.00	
5110, 5610, 5910, 6410, 6810, 7610, 7710 - 11/88-10/91 Models w/ 4 Cylinder Diesel Engine	Water Pump w/ Single Groove Pulley, Threaded for Fan	AMFAPN8A513HH	\$ 94.50	
	Water Pump w/ Fan Clutch	AMFAPN8A513AA	\$ 124.50	
	Water Pump w/ Double Groove Pulley	AMEAPN8A513D	\$ 79.83	
5640, 6640, 7740, 7840	Water Pump w/ Serpentine Pulley, 147 mm Diameter Will not fit models equipped w/ Mando A/C	AM87800714	\$ 188.50	
	Water Pump w/ Serpentine Pulley, 140 mm Diameter Will not fit models w/ Mando A/C	AM87800712	\$ 125.00	
7740, 7840, 8240, 8340 - w/ Mando A/C	Water Pump Includes Mounting Gasket	AM87840257	\$ 218.00	

Prices Subject to Change without Prior Notice. The use of original equipment manufacturer (OEM) part numbers or trademarks, e.g. Case® and John Deere®, are for reference purposes only and for indicating product use and compatibility. Our company and the listed replacement parts contained herein are not sponsored, approved or manufactured by the OEM. All parts are New unless designated Reman in the description.

Ford® / New Holland®—Tractor

Application	Description	Part Number	Retail Price	Core
7810, 7810S, 8010, TB120	Water Pump Includes Mounting Gasket Replaces 81863835, 83926130, 83961310, EJPN8A513BA, SW06499, VPE1038	AMFAPN8A513CC	\$ 145.00	
(7910, 8210 - 02/1982-10/91), (8530, 8630, 8730, 8830 - 03/1990 and Later), (8700, 9700 - 08/1976-78), (TW5, TW15, TW25, TW35 - 1983-02/90), (TW10, TW20, TW30 - 1979-82)	Water Pump w/ Single Groove Pulley, Mounts with 5/16" and 7/16" Bolts	AMFAPN8A513LL	\$ 82.00	
7910 82-11/86 Year 76 & Up Year Model, 8700 All Year Model, 9700 8/76-11/87 Year Model, TW5, TW10, TW15, TW20, TW25, TW30, TW35 2/82-12/86	Reman Water Pump w/ Single Groove Pulley, 5/16" and 3/8" Bolts	AMEAPN8A513G-R	\$ 95.00	\$ 25.00
8000, 8200, 8400, 8600	Water Pump Includes Mounting Gasket Pulley and Hub Not Included Replaces 8508AB, 83912464	AMDHPN8A513B	\$ 93.00	
8160, 8260, 8360, 8560, TM115, TM125, TM135, TM150, TM165, TV140	Water Pump Replaces 82847714, 87840689, 87840823	AM82847712	\$ 220.00	
8670, 8670A, 8770, 8770A, 8870, 8870A, 8970, 8970A	Water Pump w/ O-Ring Seal Replaces 87800490, 87800491, 87840704, 87840705	AM87801873	\$ 173.00	
9000, 9200, 9600 - 1969-7/76	Reman Water Pump w/ Single Groove Pulley, 5/16" and 3/8" Bolts 4 1/2" Diameter Pulley, 2 5/8" Tall, 4" Diameter Impeller	AMDHPN8A513A-R	\$ 95.00	\$ 25.00
(9000, 9600 - 1968-07/76)	Water Pump w/ Single Groove Pulley, 4.50" Diameter Pulley Includes Mounting Gasket Replaces 83912463	AMDHPN8A513A	\$ 100.00	
Dexta, Super Dexta	Water Pump w/ Hub	AM957E8501B	\$ 90.00	
Fordson Major Diesel, Fordson Super Major	Water Pump w/ Hub	AME1ADKN8501B	\$ 50.50	
NAA (Golden Jubilee) 1953-54	Water Pump w/ Single Groove Pulley	AMCDPN8501B	\$ 57.00	
TG210, TG230, TG255, TG285	Water Pump Replaces 86993431	AM87453208	\$ 142.00	
TL70A, TL80A, TL90A, TL100A, TS100A, TS110A, TS115A, TS125A, TS130A, TS135A	Water Pump w/o O-Ring Seal	AM2852114	\$ 60.00	
TJ275, TJ325	Water Pump Replaces 87308650, 87774990, J940052	AMJ804927	\$ 80.00	
TJ380, TJ430, T9030, T9040, T9050, Combine: CR9070	Water Pump Replaces 504079715	AM504102491	\$ 110.00	
TM120, TM130	Water Pump Replaces 87384587	AM87802491	\$ 275.00	
TM120, TM130, TM140, TM155, TM175, TM190	Water Pump w/o O-Ring Seal w/ Dual Serpentine Pulley, Threaded Hub for Fan Clutch	AM87384588	\$ 100.00	
TM140, TM155, TM175, TM190	Water Pump Replaces 87384586	AM87802490	\$ 245.00	
Ind: 550, 555, 555A - 1975-12/86 Models	Reman Water Pump w/ Double Groove Pulley, 5/16" and 3/8" Bolts 5 5/8" Diameter Pulley, 3 3/4" Tall, 4" Diameter Impeller	AMEAPN8A513H-R	\$ 85.00	\$ 5.00
Backhoe-Loaders: 550, 555, 555B, 655, 655A - w/ Ford® Engine	Water Pump w/ Single Groove Pulley Replaces 81872280, 83956731, E6NN8501FA	AM87800116	\$ 194.27	
Combines w/ 3208 Caterpillar® Engine	Water Pump w/ 3-Groove Pulley	AM9N5023	\$ 220.00	

Ford® / New Holland®—Tractor

Application	Description	Part Number	Retail Price	Core
Utility: 1530, 1630, 1725, TC25, TC25D, TC29, TC29D, TC29DA	Water Pump Includes Mounting Gasket Replaces 87761849, SBA145016891, SBA145017660	AMSBA145017661	\$ 120.00	
Utility: 1720, 1920, 2120 ASN UV32235, 3415	Water Pump	AMSBA145017730	\$ 70.00	
5640, 6640, 7740, 8240, 8340, TS90, TS100, TS110, TS115	Belt Tensioner Replaces 83998237, F0NN6B209AA, F1NN6B209AA	AM87801689	\$ 57.50	
T6010, T6020, T6030 (SN Z*BK40001-Z*BK50000 Excluding Power Command), T6040, (T6050, T6070, T6080 SN Z*BK40001-Z*BK50000 Excluding Power Command and Range Command), T6060, (TS100A, TS115A Excluding Plus and Deluxe), TS125A, TS130A, TS135A, TS6020, TS6030, TV6070 Bi-Directional	Belt Tensioner Replaces 2852161, 2853680, 2854611, 2855622, 2856687, 87415847, 87415848, 87803067	AM504028028	\$ 78.50	
8160, 8260, 8360, 8560, TC140, TM115, TM120, TM125, TM130, TM135, TM140, TM150, TM155, TM165, TM175, TM190, WDX2302	Belt Tensioner	AM87801838	\$ 108.45	
TG210, TG230, TG255, TG285, TJ280, TJ330, T9020 Replaces 87409564, 87775209	Belt Tensioner	AM87436755	\$ 78.00	

Fan Clutches

Application	Description	Part Number	Retail Price	Core
8530, 8630, 8730, TW5, TW15, TW25	Fan Clutch Assembly 4-Bolt Mount Replaces 83932779, E4NN8A616BC	AM81865533	\$ 265.00	
(Workmaster 65, Workmaster 75 - Prior to 09/2018)	Fan 6 Blade	AM87479461	\$ 66.00	
2N, 8N, 9N, NAA, NAB	Fan, 4 Blade w/ Spacer	AM8N8600A	\$ 35.00	
(Workmaster 65, Workmaster 75 - Prior to 09/2018)	Fan Drive Spacer	AM87479460	\$ 17.00	

Belts

Application	Description	Part Number	Retail Price	Core
5640, 6640, 7740, 7840, 8240, 8340 - Models Prior to 11/91 w/ AC	Fan Belt, Alt / Gen Belt	AMF3NN8620AA	\$ 31.64	
8000 1960-1/73	Fan Belt	AM86518907	\$ 9.90	
(Alt Belt - 1968-7/76)	Alt / Gen Belt	AM9604339	\$ 10.00	
8000 2/73-7/76	Fan Belt, Alt / Gen Belt	AMD2NN8620A	\$ 13.46	
8670, 8770, 8870, 8970 - 09/93	Fan Belt, Water Pump Belt	AM86013678	\$ 38.25	
8700, 9700 - 8/76-78	Fan Belt, Alt / Gen Belt	AM9625879	\$ 12.55	
TW5, TW15, TW25, TW35	Fan Belt	AMAD6NN8620B	\$ 12.55	
	Alt / Gen Belt	AM9842660	\$ 13.00	
8160, 8260, 8360, 8560, TM115, TM120, TM125, TM130, TM135, TM140, TM150, TM155, TM165, TM175, TM190, TV140	Belt Tensioner	AMAH155348	\$ 75.00	

Ford® / New Holland®—Tractor



Carburetors

Application	Description	Part Number	Retail Price	Core
2N, 8N, 9N	Carburetor	AMTSX241C	\$ 160.00	
501, 601, 701, 1958-1962, 2000 Early	Reman Carburetor	AMTSX765-R	\$ 195.00	\$ 100.00
600, 700, 800, 900, 2000, 4000	Carburetor, Zenith	AMX82003	\$ 456.00	
600, 700, 2000	Carburetor, Zenith	AMX82002	\$ 508.00	
600, 700, 2000	Carburetor, Zenith	AMTSX765	\$ 402.00	
800 w/ 172 CID Engine	Reman Carburetor	AMEAF9510G	\$ 195.00	\$ 100.00
800 w/ 134 CID Engine	Reman Carburetor	AMEAE9510C	\$ 195.00	\$ 100.00
800, 900, 4000	Carburetor	AMX82007	\$ 550.00	
800, 4000	Carburetor, Zenith	AMTSX813	\$ 457.00	
800, 4000	Carburetor, Zenith	AMTSX769	\$ 489.00	
800, 900, 4000	Carburetor, Zenith	AMTSX706	\$ 524.00	
2000, 2100, 2110, 2120, 2300, 2310, 2600, 2610, Ind: 230A, 231	Carburetor, Zenith	AMR8552	\$ 646.00	
2000, 2100, 2120, 2300, 2310, 2600, 2610 - w/ 3 Cylinder Engine	Carburetor, Zenith Replaces C5NN-L	AMR3656	\$ 669.00	
2000, 3000, 4000 - w/ 3 Cylinder Engine	Reman Holley Carburetor	AME1NN9510A	\$ 225.00	\$ 100.00
3055, 3100, 3120, 3190, 3330, 3400, 3500, 3600, Ind: 335, 340, 420, 445	Carburetor, Zenith	AMR7893	\$ 634.00	
4000, 4100, 4110, 4140, 4190, 4200, 4330, 4340, 4400, 4500, 4600, 4610, Ind: 515, 531, 535, 545, 550, 555	Carburetor, Zenith	AMR8554	\$ 588.00	
4000, 4110, 4140, 4190, 4200, 4330, 4340, 4400, 4410, 4500, 4600, 4610 - w/ 3 Cylinder Engine	Carburetor Replaces C5NN-N	AMR3657	\$ 825.00	
NAA, Jubilee	Reman Carburetor	AMTSX428-R	\$ 195.00	\$ 100.00



Fuel Lift Pumps

Application	Description	Part Number	Retail Price	Core
Models 1965 and Later Used on Most 3, 4 and 6 Cylinder Diesel Engines	Fuel Lift Pump	AMD8NN9350AB	\$ 20.00	
5610S, 6610S, 6810S, 7010 ASN 850179M, 7610S, 8010, 8160, 8260, 8360, 8560, TB80, TB85, TB90, TB100, TB110, TB120, TM115, TM120, TM125, TM130, TM135, TM140, TM150, TM155, TM165, TM175, TM190, TS90, TS100, TS110, TS115 ASN 170078, TV145	Fuel Lift Pump	AM87802238	\$ 77.00	
5610S, 6610S, 7610S, T4020, T4020V, T4030, T4030F, T4030N, T4030V, T4040, T4040F, T4040N, T4040V, T4050, T4050F, T4050N, T4050V, T4060F, T4060N, T4060V, T5040, T5050, T5060, T5070, T6010, T6020, T6030, T6050, T6070, T4.65, T4.65V, T4.75, T4.75F, T4.75V, T4.85F, T4.85V, T4.95F, T4.95V, T4.105F, T4.105V, TD4040F, TD5010, TD5020, TD5030, TD5050, TL80A, TL90A, TL100A, TN85A, TN85DA, TN85SA, TN95A, TN95DA, TS100A, TS110A, TS115A, TS125A, TS130A, TS6000, TS6020, TS6030, TV6070, (Workmaster 45, Workmaster 55, Workmaster 65, Workmaster 75), Ind/Const: B90B, B95, B95LR, B95TC, B110, B115, E175B, E215B, LB75.B, LB90.B, LB110.B, LB115.B, LM415A, LM435A, LM445A, LM1340, LM1440, LM1740, LM5040, LM5060, LM5080, LW110.B, LW130.B, M357, M427, M428, M459, M551, T13, T14, T17, VL5080, VL5090, VL6040, VL6050, VL6060, VL6090, VM370, VM460, VN2090, VM3080, VM3090, VM4090, VX7090, W110, W110TC, W130, W130TC	Fuel Lift Pump Replaces 84268475, 84269570, 504146090	AM2830266	\$ 36.00	
7010, 8010, TB80, TB85, TB90, TB100, TB110, TB120	Fuel Lift Pump	AM82980167	\$ 78.50	
5640, 6640, 7740, 7840, 8240, 8340	Fuel Primer Pump All Primer Assembly	AM81866602	\$ 68.00	
Ind: LV80, U80	Fuel Transfer Pump Replaces 87473337, J917998	AM87648717	\$ 80.00	

Ford® / New Holland®—Tractor

Fuel Components

Application	Description	Part Number	Retail Price	Core
2000, 2110, 2120, 2150, 2300, 2310, 2600, 2610, 2810, 2910, 3000, 3055, 3110, 3120, 3150, 3300, 3310, 3330, 3400, 3500, 3600, 3610, 3900, 3910, 4110, 4330, 4340, 4400, 4410, 4500, 4600, 4600SU, 4610, 5000, 5340, 5600, 6600, 7000, 7600	Fuel Sending Unit Replaces 87712903, D8NN9A316EA, D8NN9A316EB	AMC5NN9A316B	\$ 50.00	
5000, 5100, 5110, 5600, 5610, 5900, 6410, 6600, 6610, 7000, 7100, 7600, 7610	Fuel Sending Unit Replaces 83917697, D8NN9A316DA, D8NN9A316DB	AMC5NN9A316A	\$ 40.00	
T9.480, T9.530, T9.565, T9.600, T9.645, T9.700	Sensor, Fuel Pressure	AM5801567640	\$ 200.00	

Injection Pumps

All of our injection pumps are disassembled, thoroughly cleaned and inspected. All worn out parts are replaced and the pumps are reassembled with new gaskets. Pumps are tested for leaks and fuel delivery at low idle, high idle, full load, part load and at start up. Any pumps with an automatic advance system has the advance set. As an additional quality check, all pumps are tested with a special oil that will not varnish inside the pump.

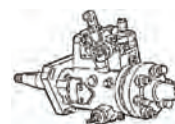

Application	Description	Part Number	Retail Price	Core
2000	Reman Injection Pump CAV, Mfg # - 3233F151	AMP2000-DPA	\$ 1075.00	\$ 200.00
2310, 2600	Reman Injection Pump CAV, Mfg # - 3233F661	AMP2310-DPA	\$ 1075.00	\$ 200.00
2610	Reman Injection Pump CAV, Mfg # - 3233F900	AMP2610-DPA	\$ 1075.00	\$ 200.00
3000	Reman Injection Pump CAV, Mfg # - 3233F380	AMP3000-DPA	\$ 1075.00	\$ 200.00
3000	Reman Injection Pump Simms, Mfg # - P4665/6	AMP4665-6	\$ 1725.00	\$ 200.00
3600	Reman Injection Pump CAV, Mfg # - 3233F631	AMP3600-DPA	\$ 1075.00	\$ 200.00
3610	Reman Injection Pump CAV, Mfg # -3233F880	AMP3610-DPA	\$ 1075.00	\$ 200.00
4000	Reman Injection Pump Roosa Master, Mfg # - DBGVCC4298AJ24A	AMP192-DBGVCC	\$ 975.00	\$ 300.00
4000	Reman Injection Pump CAV, Mfg # - 3233F171, F390	AMP4000-DPA	\$ 1075.00	\$ 200.00
4100	Reman Injection Pump CAV, Mfg # - 3233F641	AMP4100-DPA	\$ 1075.00	\$ 200.00
4110	Reman Injection Pump CAV, Mfg # - 3233F890	AMP4110-DPA	\$ 1075.00	\$ 200.00
4600, 4610, Ind: 550, 555	Reman Injection Pump CAV, Mfg # - 3233F651, F770	AMP4600-DPA	\$ 1075.00	\$ 200.00
4610	Reman Injection Pump CAV, Mfg # - 3238F060	AMP4600-DPAF060	\$ 1075.00	\$ 200.00
4610	Reman Injection Pump CAV, Mfg # - 3233F860	AMP4610-DPA	\$ 1075.00	\$ 200.00
5000, Ind: 5500	Reman Injection Pump CAV, Mfg # - 3249F771	AMP5000-DPA	\$ 1075.00	\$ 200.00
5000, Ind: 5500	Reman Injection Pump Simms, Mfg # - P4666/1	AMP46661	\$ 1725.00	\$ 200.00
5000, Ind: 5500	Reman Injection Pump Simms, Mfg # - P5024/8A	AMP5024	\$ 1725.00	\$ 300.00
5600	Reman Injection Pump CAV, Mfg # - 3249F921, F951	AMP5600-DPA	\$ 1075.00	\$ 200.00
5610	Reman Injection Pump CAV, Mfg # - 3242F771	AMP5610-DPA	\$ 1075.00	\$ 200.00
6000	Reman Injection Pump Simms, Mfg # - P4573/2A	AMP4573-2A	\$ 1875.00	\$ 300.00

Prices Subject to Change without Prior Notice. The use of original equipment manufacturer (OEM) part numbers or trademarks, e.g. Case® and John Deere®, are for reference purposes only and for indicating product use and compatibility. Our company and the listed replacement parts contained herein are not sponsored, approved or manufactured by the OEM. All parts are New unless designated Reman in the description.

Ford® / New Holland®—Tractor

Application	Description	Part Number	Retail Price	Core
6600, 6700	Reman Injection Pump CAV, Mfg # - 3249F951	AMP6600-DPA	\$ 1075.00	\$ 200.00
6600, 6700	Reman Injection Pump Simms, Mfg # - P4862/9B, P4862/9D, P5438/3A	AMP4862	\$ 1725.00	\$ 300.00
6610, 6710	Reman Injection Pump Simms, Mfg # - P5498/A, P5598/1D	AMP5498-A	\$ 1850.00	\$ 300.00
7000	Reman Injection Pump Simms, Mfg # - P5144/4, P5147/4	AMP5144-4	\$ 1725.00	\$ 300.00
7000	Reman Injection Pump Simms, Mfg # - P5147	AMP5147-4	\$ 1725.00	\$ 300.00
7600, 7700	Reman Injection Pump Simms, Mfg # - P5319/1A, P5319/5H, P5319/5J	AMP5319	\$ 1725.00	\$ 300.00
7610, 7710	Reman Injection Pump Simms, Mfg # - P5494A, P5597/1D	AMP5597	\$ 1850.00	\$ 300.00
8000, 8600 Early	Reman Injection Pump Simms, Mfg # - P4784/6	AMP4784-6	\$ 1875.00	\$ 300.00
8600, 8700	Reman Injection Pump Simms, Mfg # - P5376, P5376/2R	AMP5376-2R	\$ 1850.00	\$ 300.00
9000, 9600	Reman Injection Pump Simms, Mfg # - P4784/6A	AMP4784-6A	\$ 1875.00	\$ 300.00
9700	Reman Injection Pump Simms, Mfg # - P5376/H, P5376/2H	AMP5376-2H	\$ 1850.00	\$ 300.00
TW5, TW10	Reman Injection Pump Simms, Mfg # - P5419/A, P5579/1A	AMP5419	\$ 1850.00	\$ 300.00
TW15	Reman Injection Pump Simms, Mfg # - P5636	AMP5636	\$ 1850.00	\$ 300.00
TW20	Reman Injection Pump Simms, Mfg # - P5450, P5580/1	AMP5450	\$ 1850.00	\$ 300.00
TW25	Reman Injection Pump Simms, Mfg # - P5637	AMP5637	\$ 1850.00	\$ 300.00
TW30	Reman Injection Pump Simms, Mfg # - P5451, P5581/1	AMP5451	\$ 1850.00	\$ 300.00
TW30	Reman Injection Pump Simms, Mfg # - P5351	AMP5351-TW30	\$ 1850.00	\$ 300.00
TW35	Reman Injection Pump Simms, Mfg # - P5638	AMP5638	\$ 1850.00	\$ 300.00
TG255, TG285, TJ275, TJ325	CAPS Pump Replacement Kit Includes In-Line "P" 7100 Fuel Injection Pump HD, Fuel Injection Lines, Installation Components and Hardware	AMX36274	\$ 10480.00	

Injectors

Our remanufactured injectors are disassembled and thoroughly cleaned. The internal components are lapped to ensure there is no leakage. All tips are inspected for hole erosion and opening pressure; and the spray pattern is tested using OEM specifications.



Application	Description	Part Number	Retail Price	Core
231, 232, 234, 250C, 260C, 333, 334, 335, 340, 340A, 340B, 530A, 531, (2000, 3000 - w/ 3 Cylinder Engine), 2300, 2310, 2600, 2610, 2810, 2910, 3055, 3120, 3150, 3190, 3300, 3310, 3330, 3400, 3550, 4110, 4140, 4200, 4330, 4400, 4410, 4600, 4610, 5000, 5110, 5600, 5610, 5700, 5900, 6000, 6410, 6600, 6610, 6700, 6710, 6810, 7000, 7410, 7610, 7700, 7710, 7810, 7910, 8000, 8200, 8210, 8400, 8530, 8600, 8630, 8700, 8730, 8830, 9000, 9200, 9600, 9700, TW5, TW10, TW15, TW20, TW25, TW30, TW35, Ind/Const: 420, 445, 445A, 450, 455, 455C, 515, 535, 540, 540A, 540B, 545, 545A, 550, 555, 555A, 555B, 655, 655A, 755, 755A, 755B, 3500, 4500, 5550, 6500, 7500	Fuel Injector Washers and Seals Not Included Replaces C9NN9F593B	AMC5NE9F593A	\$ 58.00	

Ford® / New Holland®—Tractor

Application	Description	Part Number	Retail Price	Core
231, 233, 333, 335, 340, 450, 445, 450, 515, 532, 535, 540, 545, 2600, 3600, 3900, 4100, 4600, 5600, 5700, 6600, 6700, 7600, 7700, D175, D256	Injector	AMD4NN9F593A	\$ 55.09	
4130, 4630	Injector For 201 Diesel Engine	AME9NN9F593CA	\$ 85.00	
8000, 8600	Reman Injector Holder # - BKBL 80S 5204 Valve # - BDLL-150S6476	NBKBL80-6476	\$ 45.00	\$ 20.00
9000, 9600, 9700, TW20, TW30	Reman Injector Holder # - BKBL 80S 5389 Valve # - BDLL-150S6552	NBKBL80-6552	\$ 45.00	\$ 20.00
TW10	Reman Injector Holder # - BKBL 80S 5388 Valve # - BDLL-150S6764	NBKBL80-6764	\$ 40.00	\$ 35.00



Turbochargers

Application	Description	Part Number	Retail Price	Core
Boomer 4055, Boomer 4060, T2410, T2420, TC55DA	Turbocharger Replaces 87780726, SBA135756170, SBA135756171	AMSBA135756172	\$ 450.00	
4630, 4630N, 4630NO, 4630O, Ind/Const: 345C, 345D, 445C, 445D, 545C, 545D - All w/ Emissionized Engine	Turbocharger Replaces 465209-0004, 87801364	AM87801413	\$ 620.00	
6600, 6610, 6810, 7410, 7600, 7610, 7700, 7710, Ind/Const: A62, A64, A66, 750, 753, 755A, 755B, 6500, 7500, Swather: 1118	Turbocharger Replaces 83959416, E6NN6K682AA	AM466746-9003	\$ 380.00	
6610S, 7010, 7610S, 7740, TB100, TB110, TS100, TS110, Backhoe-Loaders: (575E, 675E ASN 31009910), LB90, (LB110, LB115 - 4WS), Swather: 2550 ASN 60631 - All w/ Emissionized Engine	Turbocharger T250 Replaces 87800859, 87800959	AM465153-5004	\$ 1150.00	
(7010 ASN 850001M, TB100, TB110 - w/ Non-Emissionized Engine), 7610S, 7740, TB85, Swather: 2550 BSN 606630	Turbocharger Replaces 83991489, F0NN6K682AA, F0NN6K682BA	AM83999247	\$ 725.00	
7700	Turbocharger 3LDA168, Schwitzer Replaces 182990R, 83910864, 87764591, D3NN6K682A	AM182990	\$ 795.00	
8630, 8730, TW15, TW20, TW25	Turbocharger Replaces E2NN6K682BC Reman Turbocharger TO4B09, AiResearch Replaces 81868484, E2NN6K682BC	AM81868484 AM465218-4	\$ 652.00 \$ 700.00	 \$ 200.00
8670, 8670A, 8770	Turbocharger Replaces 87840269, 87840269T	AM87840269	\$ 514.00	
8670, 8670A, 8770, 8770A, 8870, 8870A, 8970, 8970	Turbocharger Replaces 452173-0001	AM87800544	\$ 425.00	
8830, TW30, TW35	Reman Turbocharger TO4B09, AiResearch Replaces D8NN6K682FB	AM465218-2	\$ 695.00	\$ 200.00
8870, 8870A	Turbocharger Replaces 81876979, 87840270T, F2NN6K682CB	AM87840270	\$ 300.00	
8970, 8970A	Turbocharger Replaces 81876813, 81876980, F2NN6K682CA	AM87840271	\$ 413.00	

Ford® / New Holland®—Tractor

Application	Description	Part Number	Retail Price	Core
9000, 9200, 9600	Reman Turbocharger 3LD229, Schwitzer Replaces C9NN6K682B	AM150627R	\$ 695.00	\$ 200.00
9700	Reman Turbocharger Replaces D6NN6K382C, D8NN6K682DA	AM180316	\$ 830.00	\$ 200.00
T2410, T2420, TC55DA	Turbocharger Replaces 4T507, 87772751, 87780726, 135756172	AMSBA135756171	\$ 517.00	
T8010, T8020, T8030, T8040, T8050, TG215, TG245, TG275, TG305	Turbocharger Replaces 84186718, 87355507, 87357062R	AM87357062	\$ 2575.00	\$ 200.00
TD70D, TD90D, TD95D, TN70, TN70A, TN70D, TN70NA, TN70S, TN70SA, TN70VA, TN75, TN75A, TN75D, TN75S, TN75SA, TN75V, TN75VA	Turbocharger Replaces 454163-5002S	AM99462782	\$ 425.00	
TR70, TR75	Reman Turbocharger H54375(3LD), Holset	AM54375	\$ 840.00	\$ 400.00
Combines: TR86, TR87, TR96, TR97	Reman Turbocharger TO4E14, Garrett Replaces E6NN6K682CA	AM466290-9	\$ 1195.00	\$ 200.00
Versatile®: 835, 875, 895	Turbocharger	AM167050	\$ 665.00	
Versatile®: 836, 846	Turbocharger	AM178022	\$ 775.00	
Versatile®: 850	Turbocharger	AM193903	\$ 795.00	
Versatile®: 876	Turbocharger	AM168823	\$ 710.00	
Versatile®: 935, 950, 956	Turbocharger	AM196390	\$ 845.00	
Versatile®: 936, 945, 946, 955	Turbocharger	AM167713	\$ 715.00	
S215, SE190, SE215, SE240	Cooler, Air-to-Air Core Dimensions: 23 7/16" x 2 5/8" x 25 1/2" 3" Inlet and Outlet	AM437249A1	\$ 1245.00	
TM120, TM130, TM140, TM155	Cooler, Air-to-Air Core Dimensions: 17 7/8" x 2 3/4" x 14 3/4" 2 1/2" Inlet and Outlet	AM82028450	\$ 715.00	



Manifolds and Components

Application	Description	Part Number	Retail Price	Core
2N, 8N, 9N	Intake and Exhaust Manifold	AM9N9425	\$ 60.00	
	Manifold Gasket Set Replaces 9N9448	AMX36206	\$ 6.00	
600, 700, 800, 900, 2000, 4000, NAA - w/ 172 CID Gas Engine	Intake and Exhaust Manifold	AMB9NN9425A	\$ 100.00	
	Manifold Gasket Set Replaces C0NN9448C	AMX36237	\$ 14.00	
2000, 2600, 3000, 3600, 4000, 4600 - w/ 3 Cylinder Gas or Diesel Engine w/ Horizontal Exhaust	Exhaust Manifold	AMC5NE9430A	\$ 35.00	
	Manifold Gasket Replaces E8NN9448AA	AMX36238	\$ 11.00	
2000, 3000, 4000 Series - w/ 3 Cylinder Gas or Diesel Engine w/ Vertical Exhaust	Exhaust Manifold	AMC5NE9430E	\$ 45.00	
	Manifold Gasket Replaces E8NN9448AA	AMX36238	\$ 11.00	
2310, 2600, 2610, 2810, 2910, 3600, 3610, 3910, 3930, 4110, 4600, 4610, 4630 - w/ 3 Cylinder Diesel Engine w/ Vertical Exhaust	Exhaust Manifold	AMD3NN9430A	\$ 38.00	
	Manifold Gasket Replaces E8NN9448AA	AMX36238	\$ 11.00	
5000, 5100, 5200, 5340, 5900, Ind: 5190, 5500, 6500 - All w/ 4 Cylinder Diesel Engine w/ Vertical Exhaust	Exhaust Manifold	AMC5NE9430D	\$ 45.00	
	Manifold Gasket Replaces C5NE9448B, E8NN9448BA, 83983680	AMX36239	\$ 11.00	
5600, 5610, 6600 - w/ 4 Cylinder Engine	Exhaust Manifold	AMD3NN9430B	\$ 65.00	
7000, 7100, 7200	Exhaust Manifold	AMD1NN9430A	\$ 255.66	

Ford® / New Holland®—Tractor

Application	Description	Part Number	Retail Price	Core
7910, 8210, 8700, 9700, TW10, TW20, TW30, TW35	Exhaust Manifold - Front Section	AMD8NN9430AB	\$ 155.00	
	Manifold Gasket Ref# E2NN5C250BA, C5NE9448A, E8NN9448AA	AMX36240	\$ 14.00	
	Exhaust Manifold - Rear Section	AMD5NN9431A	\$ 80.00	
8000, 8200, 8400, 8600, 9000, 9200, 9600	Exhaust Manifold - Front Section	AMC9NN9430B	\$ 120.00	
	Manifold Gasket Ref# E2NN5C250BA, C5NE9448A, E8NN9448AA	AMX36240	\$ 14.00	
	Exhaust Manifold - Rear Section Has 4-bolt pattern on top side of manifold	AMC9NN9431B	\$ 145.00	
T8010, T8020, T8030, T8040, T8050, T9010, T9020, TG215, TG245, TG275, TG305, TJ280, TJ330, Combines: (CR9040, CR9060 BSN Y8G112001)	Exhaust Manifold - Front Section	AM87344861	\$ 175.00	
T8010, T8020, T8030, T8040, T8050, T9010, T9020, TG215, TG245, TG275, TG285, TG305, TJ275, TJ280, TJ325, TJ330	Manifold Gasket	AM84368103AM	\$ 8.00	

Mufflers and Exhaust

Our mufflers are manufactured by experienced craftsmen here in the United States. All mufflers have welded seams. Aluminized steel is used for critical components. These features ensure that our products resist the corrosive effects of air, heat and the by-products of combustion that work to shorten muffler life. Additionally, they are painted either silver or black to cosmetically match its OEM counterpart, as well as provide further protection from the elements.

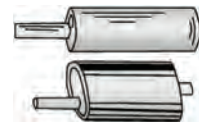

Application	Description	Part Number	Retail Price	Core
Universal Tractors	Exhaust Pipe Black Finish, Straight Pipe 4" ID, Overall Length 47.50"	AM400SP	\$ 59.00	
	Exhaust Pipe Diameter 3.50", Length 48"	AMS312X48	\$ 57.00	
2N, 8N, 9N	Exhaust System Welded 1-Piece Muffler & Pipe Assembly w/ Flared Pipe Inlet Uses Clamp for Flared Inlet	AM8N5230	\$ 26.25	
230A, 231, 233, 250C, 260C, 333, 334, 335, 340, 340A, 340B, 345C, 345D, 420, 445A, 445C, 445D, 450, 455, 455D, 515, 530A, 531, 532, 535, 540, 540A, 540B, 545, 545A, 545C, 545D, 550, 555, 555A, 555B, 655, 655A, 2310, 2600, 2600N, 2610, 2610V, 2910, 3230, 3430, 3600, 3600N, 3600NO, 3600V, 3610, 3610NO, 3910, 3910H, 3910N, 3910R, 3910V, 3930, 3930H, 3930N, 3930NO, 4100, 4110, 4110N, 4110O, 4110NO, 4110V, 4130, 4130N, 4130NO, 4600, 4600O, 4600NO, 4600SU, 4610LCG, 4610N, 4610O, 4610NO, 4610SU, 4610V, 4630, 4630N, 4630NO, 4630O, 5110, 5600, 5610, 5700, 5900, 6410, 6600, 6600C, 6600O, 6700, 6710, 6810, 7610, 7610O - w/ 3 or 4 Cylinder Gas or Diesel Engine w/ Vertical Exhaust w/ 3-Bolt Flange	Exhaust Pipe Elbow Replaces D3NN5246G, D4NN5246E, D6NN5246U	AMD6NN5246N	\$ 75.00	
(501, 601, 701, 2000 - w/ 172 CID Gas or Diesel Engine), (801, 901, 1801, 4000 - w/ 3 Cylinder Diesel Engine), (3600, 4000, 4600 - w/ 144 CID Diesel Engine)	Muffler Round, Inlet 2", Length 17 1/2"	AM310079	\$ 23.00	
	Inlet Clamp	CL-200	\$ 4.00	
	Outlet Clamp	CL-200	\$ 4.00	
(600, 601, 700, 701, 2000, NAA - w/ 172 CID Gas Engine), (800, 900 w/ 134 CID Gas Engine)	Muffler Round, Inlet 1 5/8", Length 17 1/2"	AMNAA5230E	\$ 20.00	
	Inlet Clamp	CL-158	\$ 4.00	
	Outlet Clamp	CL-158	\$ 4.00	
2000 Series, 2100, 2110, 2600, 3000 Series, 3100, 3600, 4110 - w/ 3 Cylinder Diesel Engine	Muffler w/ Hanger Bracket Oval, Inlet 1 3/4", Length 20 1/2"	AMC7NN5230G	\$ 43.00	
	Inlet Clamp	CL-134	\$ 4.00	

Ford® / New Holland®—Tractor

Application	Description	Part Number	Retail Price	Core
2000, 2100, 2110, 2600, 3000, 3100, 3600, 4110	Horizontal Tailpipe	AMC7NN5245B	\$ 30.75	
	Inlet Clamp	CL-200	\$ 4.00	
2000, 2600, 2610, 2810, 2910, 3000, 3910	Muffler Horizontal, Inlet 1 7/8", Length 49" Replaces 83958580, D9NN5230DA17M, E4NN5230FA17M	AMD6NN5230B	\$ 65.00	
	Muffler Vertical Oval Body, Inlet 6", Length 49"	AME4NN5230FA	\$ 72.00	
2000, 3000, 4000, 4400, 5000, 5100 - w/ 3 or 4 Cylinder Gas or Diesel Engine, 1968 and Later	Muffler Round, Inlet 1 7/8", Length 29"	AMC7NN5230Z	\$ 27.50	
	Inlet Clamp	CL-178	\$ 4.00	
	Rain Cap	RC-2	\$ 13.00	
2000, 3000, 4000, 4200, 5000, 5100 Series - w/ 3 or 4 Cylinder Gas, LPG or Diesel Engine, 1975 and Later	Muffler Oval, Inlet 1 7/8", Length 39"	AMD5NN5230D	\$ 67.00	
	Inlet Clamp	CL-178	\$ 4.00	
	Rain Cap	RC-2	\$ 13.00	
2000, 3000 Series - w/ 3 Cylinder Gas or Diesel Engine, 1964-69	Muffler w/ Hanger Bracket Horizontal Oval, Inlet 1 3/4", Length 29"	AMC5NN5230AH	\$ 43.00	
	Outlet Clamp	CL-134	\$ 4.00	
2910, (3910, 4110 - 1981-85), 4000, (4600, 4610 - 1965-82), (6600, 6700 - 1965-80), 5000, 5600, 5700 (5000, 5600, 6600, 6700, 7600, 7700 Series - w/ 3 Cylinder Diesel Engine), (231 1975-81, 232 1975-81, 4600 Series - w/ 4 Cylinder Diesel 1965-75)	Muffler Vertical Oval, Inlet 1 7/8", Length 41"	AME4NN5230GB	\$ 92.50	
	Muffler Oval, Inlet 1 7/8", Length 49"	AMD6NN5230T	\$ 67.50	
	Inlet Clamp	CL-178	\$ 4.00	
5030, 5610, 6610, 6710, 7600, 7610, 7700, 7710, Backhoe-Loaders: 755, 755A, 755B, 7500	Muffler Vertical Oval, Inlet 2 1/2", 33 1/4"	AME5NN5230HA	\$ 75.00	
	Exhaust Pipe Elbow Replaces E0NN5246AA	AME0NN5246AA12B	\$ 93.00	
5110, 5610, 5900, 6410, 6610, 6710, 6810, 7610 - w/ Vertical Exhaust w/ 4-Bolt Rectangular Flange 5110, 5610, 6610, 6710, 7000, 7100, 7200, 7600, 7610, 7700, 7710	Muffler Vertical Oval, Inlet 4", Length 38" Replaces 83908348, 83910404, 83919567, 83919568, 83932274, 83949814, 87295250, 87704570, D5NN5230R, D9NN5230FA, D9NN5230GA, E4NN5230DA, E4NN5230DA17M	AMD5NN5230V	\$ 72.00	
	Muffler Replaces 82010856	AM87704566	\$ 261.00	
	Muffler Replaces 82001308, 82003116, 82003737	AM82009296	\$ 245.00	
(8200, 8600 - 1968-76), (9200, 9600 - 1969-76) - All w/ 6 Cylinder Diesel Engines	Muffler Round, Inlet 2 7/8", Length 41"	AMC9NN5230C	\$ 61.00	
	Muffler Replaces 82008337, 82010811	AM87344289	\$ 325.00	
8700 1976-78, TW10 1979-82	Muffler Oval, Inlet 2 3/4", Length 44"	AMD5NN5230S	\$ 114.00	
	Inlet Clamp	CL-234	\$ 11.00	
	Rain Cap	RC-4	\$ 16.00	
9600, 9700, TW10, TW20	Muffler Oval, Inlet 3 1/2", Length 44 1/2"	AMD6NN5230AJ	\$ 140.00	
	Inlet Clamp	CL-312	\$ 6.50	
	Rain Cap	RC-8	\$ 16.50	

Ford® / New Holland®—Tractor

Application	Description	Part Number	Retail Price	Core
TD55D, TD60D, TD65D, TD70D, TD75D, TD80D, TD85D, TD90D, TD95D, TD5040, TD5050, TN55, TN55D, TN55S, TN55V, TN60A, TN60DA, TN60SA, TN60VA, TN65, TN65D, TN65F, TN65N, TN65S, TN65V, TN70, TN70A, TN70F, TN70NA, TN70VA, TN75, TN75A, TN75F, TN75FA, TN80F	Muffler Vertical Oval Body, Inlet 2", Length 14"	AM5172649	\$ 144.00	
TM120, TM130, TM140, TM155	Muffler, Underhood	AM82022922	\$ 381.00	
TW30	Muffler	AME4NN5230AA17M	\$ 223.00	
Versatile®: 256, 276	Muffler Vertical Oval, Inlet 3", Length 33 1/2"	AM9700143	\$ 127.00	
	Inlet Clamp	CL-212	\$ 7.00	
Versatile®: 750, 800, 825, 835, 850, 855, 875, 895	Muffler Vertical Oval, Inlet 5", Length 46"	AMV108431	\$ 425.00	
	Rain Cap	RC-11	\$ 23.50	
Versatile®: 836, 846, 856, 876	Muffler Inlet 4", Length 36 1/2"	AMV108093	\$ 650.00	
	Clamp	CL-400	\$ 6.50	
Versatile®: 936, 946, 956, 976	Muffler Inlet 5", Length 45 1/2"	AMV108094	\$ 563.00	
Versatile®: 9030E, 9030V	Muffler Vertical Oval, Inlet 3", Length 43"	AM9702857	\$ 106.00	
	Inlet Clamp	CL-234	\$ 11.00	

Starters

All of our remanufactured starters are disassembled, cleaned and inspected. Almost all units receive new field coils. If it meets OEM specifications the armature is test turned and under cut, otherwise it is replaced with a quality factory remanufactured or new part. Starters with factory solenoids have the solenoids replaced with new parts. The drive is carefully inspected and if it does not meet specifications it is replaced with new or quality factory remanufactured drives.



Application	Description	Part Number	Retail Price	Core
2N, 8N, 9N	Starter, 6 Volt Delco 10MT	AM8N11001	\$ 110.00	
501, 600, 601, 700, 701, 800, 801, 900, 901, 4000, NAA, Jubilee	Starter, 6 Volt 9 Tooth, CW Rotation Replaces C3NF11001A, FAC11000, FAC11001	AMFAC11001P	\$ 198.00	
600, 650, 660, 800, (2000, 4000 - w/ 4 Cylinder Engines, 1962-64), 2030, 2120, 2130, 4030, 4040, 4120, 4130, 4140	Starter w/ Drive Direct Drive, CW Rotation	AMC3NF11002D	\$ 136.00	
	Starter w/o Drive Direct Drive, CW Rotation	AMC3NF11002	\$ 119.00	
2000, 3000, 5000, 6600, 6610, 6700, 6710, 6810, 7000, 7100, 7200, 7410, 7500, 7600, 7610, 7700, 7710, 7810, 7910, 8000, 8200, 8210, 8530, 8600, 8630, 8700, 8730, 8830, 9000, 9030, 9600, 9700, TW5, TW10, TW15, TW20, TW25, TW30, TW35 - w/ Diesel	Starter, 12 Volt Lucas M50G	AM26395	\$ 160.00	
3230, 3430, 3930, 4130, 4830, 5030, 5610S, 5640, 6810S, 7010, 7610S, 7630, 7740, 7810S, 7840, 8240, 8340, LB115, TM115, TM125, TM135, TM150, TM165, TS90, TS100, Backhoe-Loaders: 555C, 555D, 555E, 575D, 575E, 775	Starter, 12 Volt Lucas M50G, 10 Tooth, 3.20kW Replaces Bosch	AM86513093	\$ 194.50	
3430, 3930, 4130, 4630, 4830, 4835, 5030, 5610S, 5640, 6610S, 6640, 7010, 7610S, 7740, 7840, 8010, 8010HC, 8160, 8240, 8260, 8340, 8360, TB80, TB85, TB90, TB100, TB110, TB120, TM115, TM125, TM135, TM150, TM165, TS100, TS115, TS125, TV140, Swathers: HW300, HW320, HW340, HW345, HW365	Starter, 12 Volt Planetary Gear Reduction, 10 Tooth, 3.00kW, CW Rotation Note: Special Order Item	AM82021372	\$ 255.00	

Ford® / New Holland®—Tractor

Application	Description	Part Number	Retail Price	Core
8670, 8670A, 8770, 8770A, 8870, 8870A, 8970, 8970A - Diesel	Starter, 12 Volt HD Planetary Gear Reduction, 10 Tooth Steel Pinions, Steel Ring Gear, 4kW, CW Rotation For Diesel Engines Replaces 1113391, 1113672	AMX34112	\$ 285.00	
	Solenoid Use w/ AMX34112 Starter	AMX34113	\$ 60.00	
8670, 8770, 8870, 8970, TV140, TV145	Starter, 12 Volt Delco 37MT, 10 Tooth, Direct Drive, CW Rotation Replaces 9842667	AM1903109M91	\$ 315.00	
Fordson, Fordson Hi-Drive, Fordson Super Major	Starter, 12 Volt 11 Tooth, CW Rotation Replaces 81712422, E1ADDN11000D	AM26072	\$ 457.00	
T8010, T8020, T8030, T8040, T8050, T9020, TG215, TG245, TG275	Starter, 12 Volt Gear Reduction, 10 Tooth, 4.20kW Note: Special Order Item Replaces 84213446	AM87425232	\$ 375.00	
T6.120, T6.140, T6.150, T6.160, T6.175, T6020, T6030, T6040, T6050, T6060, T6070, T6080, T6090, T7.170, T7.185, T7.200, T7.210, T7.220, T7.230, T7.235, T7.240, T7.245, T7.250, T7.255, T7.260, T7.270, T7030, T7040, T7050, T7060, T7070, TC5070, TD5.105, TD5.95, TK4050, TM7010, TM7020, TM7030, TM7040, TS90, TS100, TS110, TS6.100, TS6.120, TS6.125, TS6.140, TS7020, TT60A	Starter Bosch, 10 Tooth, 4kW, CW Rotation Bosch Mfg # - 504357110 Iskra Mfg # - IS1109	AM84151331	\$ 275.00	
TD75D, TD80D, TD90D, TD95D, TL70, TL80, TL90, TL100, TN65F, TN70F, TN75F, TN75FA, TN80F, TN85FA, TN90F, TN95F, TN95FA, TN95NA, TN95VA, TT55, TT60A, TT65, TT75, TT75A	Starter, 12 Volt Replaces 82980757, 87538219, 500338952	AM5801441814	\$ 190.00	
Swathers: H8040, H8060, H8080, Speedrower Swathers: 130, 200, 240	Starter, 12 Volt Gear Redution, 10 Tooth, 4.20kW Replaces 87054526	AM87577368	\$ 300.00	
Utility: 1320, 1520, 1530, 1620, 1630, 1710, 1715, 1720, 1725, 1925, T1510, T1520, T2210, TC25, TC25D, TC29, TC29D, TC29DA, TC30, TC31DA, TC33, TC33D, TC33DA	Starter, 12 Volt 9 Tooth	AMSBA185086551	\$ 89.00	
Utility: 1920, 2120 ASN UV32235, 3415, T1520, T2220, T2310, T2320, T2330, T2410, T2420, TC34DA, TC35, TC35A, TC35D, TC35DA, TC40, TC40A, TC40D, TC40DA, TC45, TC45A, TC45D, TC45DA, TC48DA, TC55DA, TT45A, TT50A	Starter, 12 Volt 11 Tooth	AMSBA185086530	\$ 128.00	
TR75, TR85, TR86, TR87, TR88, TR89, TR95, TR96, TR97, TR98, TR99, Swathers: 1100 ASN 425318, 1112 ASN 325611, 1114, 1116, 1118, 2450, 2550, HW300, HW305, HW305S, HW320, HW340	Ignition Switch Replaces 529713, 8641833, 80641833	AM641833	\$ 20.31	
Utility: 1000, 1100, 1110, 1200, 1210, 1300, 1310, 1500, 1510, 1600, 1700, 1710, 1900, 1910, 2110	Ignition Switch	AMSBA385200331	\$ 41.88	



Distributors

Application	Description	Part Number	Retail Price	Core
2N, 8N BSN 263844, 9N	Distributor, Front Mount	AM9N12100	\$ 157.00	
8N ASN 263843	Distributor, Side Mount	AM8N12127B	\$ 179.00	
600, 700, 800, 2000, 4000 - w/ 4 Cylinder Engines	Distributor	AMFDN12127A	\$ 155.50	
2000, 2100, 2110, 2120, 2150, 2300, 2310, 2600, 2610, 2810, 2910, 3000, 3055, 3100, 3110, 3120, 3150, 3330, 3400, 3500, 3600, 3610, 3910, 4000, 4100, 4110, 4140, 4200, 4330, 4340, 4400, 4500, 4600, 4600SU, 4610, 4610SU, Ind/Const: 230A, 234, 334, 335, 340, 340A, 340B, 420, 445, 450, 3550	Distributor For 3 Cylinder Engines Replaces 47821367, C7NF12127D, F0NN12100AA, F1NN12100AA, FDS3329	AM47573265	\$ 115.00	

Ford® / New Holland®—Tractor

Application	Description	Part Number	Retail Price	Core
Jubilee, NAA	Distributor w/ Slotted Shaft Replaces FAC12127D	AM86643560	\$ 115.00	

Air Cleaner Components

Application	Description	Part Number	Retail Price	Core
8N	Air Cleaner Assembly	AM8N9600B	\$ 98.50	
(600, 601, 700, 701, 800, 801, 900, 901, 2000, 4000, NAA - w/ 4 Cylinder Engine)	Air Funnel Air Cleaner Vent Tunnel	AMNAA9684A	\$ 32.00	
2000, 2100, 2110, 2120, 2300, 2310, 2600, 2610, 2810, 2910, 3000, 3055, 3100, 3120, 3190, 3230, 3300, 3310, 3330, 3400, 3430, 3600, 3610, 3900, 3910, 3930, 4000, 4110, 4130, 4140, 4190, 4200, 4330, 4340, 4400, 4410, 4600, 4610, 4630, 4830, 5000, 5030, 5200, 5340, 5600, 5610, 5700, 5900, 6000, 6410, 6600, 6610, 6700, 6710, 6810, 7410, 7600, 7610, 7700, 7710, Ind/Const: 230A, 231, 233, 234, 334, 335, 530A, 531, 532 Replaces CONN9A633A	Small Precleaner Bowl 7" Diameter	AMP02-0227	\$ 10.00	
2N, 8N, 9N, 600, 620, 630, 640, 650, 660, 700, 740, 800, 820, 840, 850, 860, 900, 950, 960, NAA, NAB	Air Cleaner Hose 1.50" ID, 1.875" OD, 2.562" Long	AM9N9652	\$ 3.22	
(500 Series, 600 Series, 700 Series, 800 Series, 900 Series, 2031, 2111, 2120, 2131, 4030, 4031, 4040, 4120, 4121, 4130, 4131 - w/ 134" Gas Engine), (501, 601 - w/ 4 Cylinder Engine, 1957-62), (541, 611 - w/ 4 Cylinder Engine, 1959-64), 620 w/ 4 Cylinder Engine, 1954-64, (621, 631, 641, 651 - w/ 4 Cylinder Engine, 1958-64), (2000, 4000 - Prior to 1964 w/ 134" Gas Engine), (4110TR, 4140 - w/ 4 Cylinder Engine, 1963-64), Ind: (1801, 1811, 1821, 1841, 1871, 1881, 2030, 2130 - w 134" Gas Engine)	Air Cleaner Hose 1.50" ID	AM311112	\$ 40.19	
(2000, 3000, 4000 - Diesel), 2100 03/1965-74 w/ 3 Cylinder Engine, (2110, 2300, 3055, 4100, 4110, 4190, 4200, 4330, 4340, 4410 - 1965-74 w/ 3 Cylinder Engine), Ind: 3500, 3550, 4500 1965-74 w/ 3 Cylinder Engine	Air Cleaner Hose, Lower 2" & 2.25" ID	AMC5NN9B640B	\$ 14.17	
2600, 2610, 2810, 2910, 3230, 3430, 3600, 3610, 3900, 3910, 3930, 4100, 4110, 4130, 4600, 4610, 4630, 4830, 5030, 5110, 5600, 5610, 5640, 5700, 5900, 6410, 6600, 6610, 6640, 6700, 6710, 6810, 7000, 7100, 7200, 7410, 7600, 7610, 7700, 7740, 7810, 7910, 8000, 8200, 8210, 8400, 8530, 8600, 8630, 8700, 9000, 9030E, 9030V, 9200, 9600, 9700, TS90, TW5, TW10, TW15, TW20, Ind/Const: 230A, 231, 233, 234, 333, 334, 335, 515, 530A, 531, 532 Replaces 594075	Large Precleaner Bowl 10.50" Diameter	AMP01-6330	\$ 12.00	
T6.125, T6.145, T6.155, T6.165, T6.175, T6.180, T7.165S, T7.175, T7.190, T7.210, T7.225, T7.230, T7.245, T7.260, T7.270, T8.320, T8.350, T8.380, T8.410, T8.435, T9.435, T9.480, T9.530, T9.565, T9.600, T9.645, T9.700	Sensor, Nox Replaces 47688088	AM84422747	\$ 420.00	



Alternators

Application	Description	Part Number	Retail Price	Core
2N, (8N w/ Front Mount Distributor), 9N	Alternator Conversion Kit Includes 12 Volt Alternator, Brackets, Coil, Wiring Harness and Resistor	AMX19007	\$ 183.00	
8N w/ Side Mount Distributor	Alternator Conversion Kit Includes 12 Volt Alternator, Brackets, Wiring Harness and Resistor	AMX34152	\$ 159.00	
501, 600, 700, 800, 900, (2000, 4000 - w/ 4 Cylinder Engine)	Alternator Conversion Kit Includes 12 Volt Alternator, Brackets, Wiring Harness and Resistor	AMX34153	\$ 168.00	

Ford® / New Holland®—Tractor

Application	Description	Part Number	Retail Price	Core
230A, 231, 233, 234, 333, 334, 335, 530A, 531, 2310, 2600, 2600N, 2600R, 2600V, 2610, 2810, 2910, 3600, 3600NO, 3600R, 3600V, 3610, 3610NO, 3900, 3910, 3910H, 3910N, 3910R, 4110, 4110N, 4600, 4600NO, 4600O, 4600SU, 4610, 4610O, 4610SU, 5600, 5700, 6600, 6600C, 6600O, 6700, 7600, 7700, Backhoe-Loaders: 420, 535, 550, 555, 555B, 655, 655A	Alternator w/ 6-Groove Pulley Lucas, Mfg # - 23814, 24211, 12 Volt, 43 Amps, IR/IF, CW Rotation Replaces D6NN10B376A	AM23814	\$ 91.00	
2310, 2600, 2610, 2810, 2910, 3600, 3610, 3900, 3910, 4100, 4110, 4600, 4610, 5600, 5610, 5900, 6600, 6610, 6700, 6710, 7600, 7610, 7700, 7710, 8600, 8700, 9600, 9700, Ind: 231, 233, 234, 250C, 260C, 333, 334, 335, 340, 345C, 420, 445, 445A, 445C, 450, 515, 530A, 531, 532, 535, 540, 545, 545A, 545C, 550, 555, 555A, 555B, 655A, 750, 755, 755A	Alternator 12 Volt, 51 Amps Replaces Motorola 8AL2055FA, 8AL2056K, 8AL2056KA	AMD5NN10300E	\$ 162.00	
2600, 2610, 2810, 2910, 3230, 3430, 3600, 3610, 3900, 3910, 3930, 4100, 4110, 4130, 4600, 4610, 4630, 4830, 5030, 5110, 5610, 5610S, 5640, 6610, 6640, 7610, 7710, 7740, 7810, 7840, 8240, 8340, Ind: 231, 233, 234, 250C, 260C, 333, 334, 335, 345C, 345D, 420, 445C, 445D, 455, 455C, 455D, 515, 531, 532, 535, 530A, 545C, 545D, 555C, 555D, 575D, 655C, 655D, 675D	Alternator Lucas, 12 Volt, 45 Amps, IR/EF, CW Rotation 1-Groove Pulley Replaces 81863039, 81868798, 83961474	AM82857207	\$ 111.00	
7910, 8210, 8530, 8630, 8730, 8830, TW5, TW15, TW25, TW35	Alternator 12 Volt, 95 Amps, I/R, Bosch Style w/ B+ through D+ Terminals, w/ Spade Terminal and w/o Pulley	AMF0NN10B377AB	\$ 143.00	
T6020, T6030, T6040, T6050, T6060, T6070, T6080, T6090, T5.95, T5.105, T5.115, T6.120, T6.140, T6.150, T6.160, T6.175, T7.170, T7.185, T7.200, TD5.85, TD5.95, TD5.105, TD5.115	Alternator, 14 Volt 120 Amps Note: Special Order Item Replaces 84141452	AM87361082	\$ 215.00	
T7030, T7040, T7050, T7060	Alternator w/o Pulley 12 Volt, 150 Amps, IR/IF, CW Rotation	AM87452821	\$ 190.00	
T8010, T8020, T8030, T8040, T8050, T9010, T9020, T9030, T9040, T9050, T9060, T9.450, T9.480, T9.505, T9.530, T9.560, T9.565, T9.615, T9.670, TG215, TG245, TG275, TG305, TJ280, TJ330, TJ380, TJ430, TJ480, TJ530	Alternator 12 Volt, 200 Amps, IR/IF	AM87715398	\$ 345.00	
T8010, T8020, T8030, T8040, T8050, TG215, TG245, TG275, TG305, Sprayers: Patriot 250, SP2500	Alternator, 14 Volt 175 Amps Note: Special Order Item Replaces 87645567	AM87418226	\$ 335.00	
(TG210, TG230, TG255, TG285 BSN JAW135316), TJ275, TJ325, TJ375, TJ425, TJ450, TJ500	Alternator 12 Volt, 135 Amps, IR, CW Rotation, w/o Pulley Replaces 91448C1, 86994128	AM125849A1	\$ 217.00	
TL70, TL80, TL90, TL100 - w/ Cab	Alternator 14 Volt, 65 Amps Replaces 84402418, 84402419, 84522025	AM84402417	\$ 160.00	
TM120, TM130, TM140, TM155, TM175, TM190	Alternator, 14 Volt 120 Amps Note: Special Order Item Replaces 47744887	AM87361085	\$ 225.00	
Ind/Const: B95, B95LR, B95TC, B110, B115	Alternator 14 Volt, 60 Amps Replaces 84254289, 84416587, Denso 1022119090	AM87422777	\$ 161.00	
Backhoe-Loaders: 555E, 575E, 655E, 675E, 775, LB115	Alternator 70 Amp unit w/o battery sensor	AM87800219	\$ 95.00	
Utility: 1320, 1520, (1530, 1630, 1725, 1925, T2210, T2220, TC31DA, TC34DA - w/o Cab), 1620, 1715, 1720, 1920, 2120, 3415, T1510, T1520, T2310, T2320, T2330, TC25, TC25D, TC29, TC29D, TC29DA, TC30, TC33, TC33D, TC33DA, TC35, TC35A, TC35D, TC35DA, TC40, TC40A, TC40D, TC40DA, TC45, TC45A, TC45D, TC45DA, TT45A, TT50A	Alternator 12 Volt, 40 Amps	AMSBA185046320	\$ 127.00	

Ford® / New Holland®—Tractor

Application	Description	Part Number	Retail Price	Core
1100, 1120, 1200, 1210, 1220, 1300 Ref# SBA185516010	Voltage Regulator 12 Volt - 14.30 volt setting, B-circuit, Single multi-spade (6) connector w/ pins: I - N - F - E - L - B, +IG female bullet pigtail Solid State unit to replace original mechanical unit	AM70000-65398	\$ 27.50	

Sensors

Application	Description	Part Number	Retail Price	Core
T6020, T6030, T6040, T6050, T6060, T6070, T6080, T6090, T7030, T7040, T7050, T7060, (T9030, T9040 ASN Z6F200013), T9050 ASN Z7F204001, T7.165S, T7.175, T7.190, T7.210, T7.225, T7.230, T7.245, T7.260, T7.270, T7.315, TJ380, TJ430, Backhoe-Loaders: B95B, B95BLR, B95BTC, B100B, B100BLR, B100BTC, B110, B110B, B110BTC, B115, B115B, Wheel Loaders: LW170.B, LW190.B, W110B, W130B, W170B, W170C, W190B, W190C	Sensor, Oil Pressure and Temperature Replaces 4890193	AM504358206	\$ 78.00	
T6020, T6030, T6040, T6050, T6070, T6080, T6090, T7030, T7040, T7050, T7060, T7070, T7.170, T7.185, T7.200, T7.210, T7.220, T7.225, T7.235, T7.250, T7.260, T7.270, T7.290, T7.315, Backhoe-Loaders: B90B, B95B, B95BLR, B95BTC, B100B, B100BLR, B100BTC, B110, B110B, B110BTC, B115, B115B, Wheel Loaders: LW170.B, W110B, W130B, W170B, W190B	Sensor, MAP Temperature/Pressure Replaces 2852821, 4896794, 504073323	AM504372225	\$ 49.00	
T6030, T6050, T6070, T6080, T6090, T7030, T7040, T7050, T7060, T7070, T6.125, T6.145, T6.155, T6.165, T6.175, T6.180, T7.165, T7.170, T7.175, T7.185, T7.190, T7.200, T7.210, T7.220, T7.225, T7.235, T7.250, T7.260	Sensor, Fuel Pressure Replaces 2859145, 504123163, 504222094	AM2854542	\$ 170.00	
T9030, T9040, T9050, TJ380, TJ430	Sensor, Clogged Fuel Filter Indicator	AM500346371	\$ 40.00	
T4.80F, T4.80V, T4.90, T4.90F, T4.90V, T4.100, T4.100F, T4.100V, T4.110, T4.110F, T4.110V, T4.120, T5.110, T5.120, Backhoe-Loaders: B95C, B95CLR, B95CTC, B110C	Sensor, Exhaust Pressure	AM5801382522	\$ 104.00	
T4.90, T4.100, T4.110, T4.120, T5.110, T5.120, T6.125, T6.145, T6.155, T6.165, T6.175, T6.180, T7.165, T7.165S, T7.175, T7.190, T7.210, T7.225, T7.230, T7.245, T7.260, T7.270, T7.290, T7.315, T8.320, T8.350, T8.380, T8.410, T8.435, T9.390, T9.435, T9.450, T9.480, T9.505, T9.530, T9.560, T9.565, T9.600, T9.645, T9.670, TK4.100, TK4.100M, TS6.110, TS6.120, TS6.130, TS6.140, Wheel Loader: W130C	Temperature Sender, Exhaust Temperature Replaces 47367178, 87482353, LB52S00001P1	AM47478880	\$ 60.00	
T6.125, T6.145, T6.155, T6.165, T6.175, T6.180, T7.165, T7.165S, T7.175, T7.190, T7.210, T7.225, T7.230, T7.245, T7.260, T7.270, T7.290, T7.315, T8.320, T8.350, T8.380, T8.410, T8.435, T9.480, T9.530, T9.565, T9.600, T9.70, TS6.110, TS6.120, TS6.130, TS6.140	Sensor, Def/AdBlue Quality Replaces 84553250	AM47520143	\$ 320.00	
T6.125, T6.145, T6.155, T6.165, T6.175, T6.180, T8.320, T8.350, T8.380, T8.410, T8.435, T9.480, T9.530, T9.565, T9.600, T9.645, T9.700	Sensor, 8-Pin/NH3/Ammonia Replaces 47368956, 84382712	AM47520140	\$ 425.00	
T7.290, T7.315, Wheel Loaders: W270C, W300C	Switch, Engine Exhaust Pressure Replaces 2859674, 4890193, 6901334	AM504358206	\$ 78.00	
T8.320, T8.350, T8.380, T8.410, T8.435	Sensor, Def/AdBlue Tank Level Replaces 47682727, 84161271, LB50P01001P1	AM47512674	\$ 260.00	

Ford® / New Holland®—Tractor





Tachometers and Instrument Clusters

Application	Description	Part Number	Retail Price	Core
NAA-4000 - w/ 4 Cylinder USA Engines w/ 4 Speed Transmission, 1953-64	Tachometer	AMC3NN17360N	\$ 35.00	
(600 Series, 800 Series, 900 Series, 2000 Series, 4000 Series - 1955-64 w/ 4 Cylinder Engine, w/ 5-Speed Transmission)	Tachometer	AMC3NN17360K	\$ 35.00	
(2000, 3000, 4000, 5000, 7000 Series), 7100, 7200, Ind: 3500, 3550	Instrument Cluster Fits 3 and 4 Cylinder Tractors Equipped w/ Generators, Clockwise Sweep	AMEHPN10849A	\$ 150.00	
2310, 2600, 2610, 2810, 2910, 3600, 3610, 3910, 4610, 5600, 5610 Prior to 1987, 6600, 6610 Prior to 10/1985, 7600, Ind: 231, 335, 340, 445, 531, 540	Instrument Cluster CCW Sweep Replaces E5NN10849BA, E7NN10849BA	AMD8NN10849TB	\$ 152.00	
2600, 2610, 3600, 3610, 4100, 4110, 4600, 4610, 5600, 5610, 6600, 6610, 7600, 7610	Instrument Cluster Fits 3 and 4 Cylinder Tractors Equipped w/ Alternators, Counter Clockwise Sweep	AME5NN10849BA	\$ 134.00	
3830, 4030, 4230, 4330, 4430, 7530	Instrument Cluster Replaces 5125046, 5133783	AM5145186	\$ 239.00	
2600, 2610, 2810, 3230, 3430, 3600, 3610, 3930, 4100, 4110, 4130, 4600, 4610, 4630, 4830, 5030, 5110, 5600, 5610, 5700, 5900, 6500, 6600, 6610, 6700, 6710, 7600, 7610, 7700, 7710, Ind/Const: 230A, 231, 233, 234, 250C, 260C, 333, 335, 340, 345C, 345D, 420, 445, 445A, 445C, 445D, 450, 515, 530A, 531, 532, 535, 540, 545, 545D, 550, 555, 655, 750, 755	Tachometer Drive Assembly Replaces 87800006	AMD3NN17N264B	\$ 30.00	
(2000, 2110, 2120, 4000, 4130 w/o Cab, 4140 - w/ 3 Cylinder Engine), 2100, 2300, 2310, 2600, 2610, 2810, 2910, 3000, 3055, 3100, 3110, 3120, (3230, 3430, 3930, 4630, 4830 - w/o Cab), 3300, 3310, 3330, 3400, 3500, 3550, 3600, 3610, 3900, 3910, 4100, 4110, 4200, 4330, 4340, 4400, 4410, 4500, 4600, 4610, 4610SU, 5000, 5030, 5100, 5110, 5200, 5340, 5600, 5610, 5900, 6410, 6600, 6610, 6810, 7000, 7100, 7200, 7600, 7610, Ind/Const: 30A, 231, 233, 234, 250C, 260C, 333, 334, 335, 340, 340A, 340B, 345C, 345D, 420, 445, 445A, 445C, 445D, 450, 515, 530A, 531, 532, 535, 540, 540A, 540B, 545, 545A, 545C, 545D, 750, 755, 755A, 755B	Tachometer Cable 47 7/16" Long Replaces 82847520, E1ADDN17365C, E9NN17365AA	AMD9NN17365AB	\$ 13.32	
(5110, 5610, 6410, 6610, 6810, 7610 - w/ Q-Cab and Mechanical Instrument Cluster), 5700, 6700, 6710, 7700, 7710	Tachometer Cable Replaces 83904959	AMD5NN17365D	\$ 20.00	

Mechanical Front Wheel Drive Parts





MFWD Hubs and Housings

Application	Description	Part Number	Retail Price	Core
 5600, 5700, 6600, 6700 - w/ APL1351 Front Axle	Front Axle Replaces ZP1927860	AMAL33349	\$ 200.00	
T8010, T8020, T8030, T8040, T8050, TG210, TG215, TG230, TG245, TG255, TG275, TG285, TG305	Front Axle Housing, Super Steer	AM87404286	\$ 6500.00	
 (T8010, T8020, T8030, T8040, T8050, T8.275*, T8.330*, T8.360*, T8.390*, TG210, TG215, TG230, TG245, TG255, TG275, TG285, TG305 - w/ 12-Bolt Hubs), (TG210, TG230 BSN MY00182861 w/ 10-Bolt Hubs) *Prior to 06/14/2013 w/o CVT w/ DANA® Axle w/ Differential Lock	Axle Housing For Suspended Axles w/ Differential Lock	AM87404290	\$ 4400.00	













Mechanical Front Wheel Drive Parts

Ford® / New Holland®—Tractor

Mechanical Front Wheel Drive Parts





Application	Description	Part Number	Retail Price	Core
 T8010, T8020, T8030, T8040, T8050, T8.275*, T8.330*, T8.360*, T8.390 w/o CVT, TG210**, TG215, TG230**, TG245, TG255, TG275, TG285, TG305 *w/o CVT w/ DANA® Axle or w/ CVT w/ DANA® Axle w/o Differential Lock **BSN MY00184591 w/o Differential Lock or All w/ Differential Lock	Axle Housing For Standard Axles w/ 12-Bolt Hubs w/ or w/o Differential Lock	AM87404249	\$ 3300.00	
 T8010, T8020, T8030, T8040, T8050, TG210, TG215, TG230, TG245, TG255, TG275, TG285, TG305	Axle Housing For Standard Axles w/ 10-Bolt Hubs w/ or w/o Differential Lock For Specialty Axles w/ 10-Bolt Hubs w/o Differential Lock	AM87404246	\$ 3750.00	
T8010, T8020, T8030, T8040, T8050, TG210, TG215, TG230, TG245, TG255, TG285	Axle Housing Suspended Axles w/ 10-Bolt Hubs w/ Differential Lock	AM87404289	\$ 4500.00	
5640, 6640, 7740, 7840, 8240, 8340, Ind/Const: 345C, 345D, 445C, 445D, 455C, 455D, 545C, 545D, 555C, 555D, 555E, 575E, 655, 655A, 655C, 655D, 655E, 675D, 675E	Upper Bearing, King Pin 1.378" ID, 2.047" OD, 0.65" Thick Replaces N14372	AM9967999	\$ 33.67	
 (T8010, T8020, T8030, T8040, T8050, TG210, TG215, TG230, TG245, TG255, TG275, TG285, TG305 - w/ DANA® Axle), (T8.275, T8.330, T8.360, T8.390 - w/ DANA® Axle w/o CVT)	Cradle For Suspended Axles	AM87406430	\$ 1500.00	
 T8010, T8020, T8030, T8040, T8050, T8.275, T8.300, T8.320, T8.330, T8.350, T8.360, T8.380, T8.390, T8.410, T8.420, T8.435, TG215, TG230, TG245, TG255, TG275, TG285, TG305	Pivot Pin	AM87400196	\$ 350.00	
((T8010, T8020, T8030, T8040, T8050, TG210, TG215, TG230, TG245, (TG255, TG285 ASN MY00183034) - w/ Suspended Axle w/ 10-Bolt Hubs w/ Differential Lock), (T8010, T8020, T8030, T8040, T8050, TG210, TG215, TG230, TG245, TG255, TG275, TG285, TG305, T8.275*, T8.330*, T8.360*, T8.390* - w/ Suspended Axle w/ 12-Bolt Hubs) *Prior to 06/14/2013 w/o CVT w/ DANA® Axle w/ Differential Lock	Front Axle Pin	AM87406480	\$ 135.00	
T8010, T8020, T8030, T8040, T8050, T8.275, T8.330, T8.360, TG210, TG215, TG230, TG245, TG255, TG275, TG285, TG305 - w/ Suspended Axle	Suspension Cylinder Pin For Upper and Lower Ends of Cylinder	AM87406468	\$ 145.00	
(T8010, T8020, T8030, T8040, T8050, TG210, TG215, TG230, TG245, TG255, TG275, TG285, TG305 - w/ Suspended Axle), (T8.275, T8.330, T8.360 - w/ Suspended Axle w/ DANA® Axle)	Swing Arm Pin	AM87406453	\$ 245.00	
T8010, T8020, T8030, T8040, T8050, T8.275, T8.300, T8.330, T8.360, TG210, TG215, TG230, TG245, TG255, TG275, TG285, TG305	Pivot Pin For Suspended Suspension	AM87406467	\$ 300.00	
(T8010, T8020, T8030, T8040, T8050, TG210, TG215, TG230, TG245, TG255, TG275, TG285, TG305 - w/ Suspended Axles), (T8.275, T8.330, T8.360 - w/ Suspended Axles w/o CVT w/ DANA® Axle)	Pin, Upper Swing Arm Pin, Lower Swing Arm	AM87406452 AM87406451	\$ 200.00 \$ 265.00	

Ford® / New Holland®—Tractor

	Application	Description	Part Number	Retail Price	Core
	T8010, T8020, T8030, T8040, T8050, (T8.275, T8.330, T8.360, T8.390 - w/ DANA® Axle), TG210, TG215, TG245, TG255, TG275, TG285, TG305	Suspension Cylinder, Right Hand	AM87406484	\$ 980.00	
		Suspension Cylinder, Left Hand For Suspended Axles	AM87406483	\$ 985.00	
	T8010, T8020, T8030, T8040, T8050, (T8.275, T8.330, T8.360 - w/ DANA® Axle), TG210, TG215, TG245, TG255, TG275, TG285, TG305	Lower Swing Arm For Suspended Axles	AM87406431	\$ 2050.00	
	8530, 8630, 8670, 8730, 8770, 8830, 8870, 8970 - w/ Standard Steer Axle	Hub Assembly w/ Knuckle, Right Hand	AMX4110102	\$ 4750.00	
		Hub Assembly w/ Knuckle, Left Hand	AMX4110103	\$ 4750.00	
	T8010, T8020, T8030, T8040, T8050, TG210, TG215, TG230, TG245, TG255, TG275, TG285, TG305	Hub Assembly w/ Knuckle, Right Hand Replaces 302174A1, 87404300	AMX41136	\$ 4750.00	
		Hub Assembly w/ Knuckle, Left Hand 12-Bolt For Super Steer Replaces 302174A1, 87404298	AMX41135	\$ 4750.00	
	8530, 8630, 8670, 8730, 8770, 8830, 8870, 8970	Hub Assembly	AMX411116	\$ 3500.00	
	8670, 8770, 8870, 8970	Hub Assembly 10-Bolt Hub 4-Gear Assembly	AM86025945	\$ 3950.00	
	5600, 5700, 6600, 6700 - w/ APL1351 Front Axle	Steering Knuckle, Right Hand	AMZP4468358032	\$ 390.00	
		Steering Knuckle, Left Hand	AMZP4468358031	\$ 390.00	
	8670, 8770, 8870, 8970	Steering Knuckle, Right Hand	AM86015342	\$ 900.00	
		Steering Knuckle, Left Hand 1 1/4" Tie Rod Hole Diameter For Super Steer	AM86015341	\$ 900.00	
		Steering Knuckle, Right Hand	AM86015340	\$ 900.00	
		Steering Knuckle, Left Hand 10-Bolt, 1 1/8" Tie Rod Hole Diameter For Standard Steer	AM86015339	\$ 900.00	
	T4020, T4030, T4030F, T4030N, T4040, T4040F, T4040N, T4050, T4050F, T4050N, T4060F, T4060N, T4.75F, T4.80F, T4.85F, T4.90F, T4.95F, T4.100F, TN55S, TN60SA, TN70NA, TN70S, TN70SA, TN75DA, TN75FA, TN75SA, TN85FA, TN85SA, TN90F, TN95FA, TN95NA	Steering Knuckle, Right Hand	AM5184889	\$ 225.00	
		Steering Knuckle, Left Hand	AM5184894	\$ 225.00	
	T8010, T8020, T8030, T8040, T8050, TG210, TG215, TG230, TG245, TG255, TG285	Steering Knuckle, Right Hand	AM87404296	\$ 1400.00	
		Steering Knuckle, Left Hand For Super Steer	AM87404291	\$ 1400.00	
	T8010, T8020, T8030, T8040, T8050, TG210, TG215, TG230, TG245, TG255, TG285	Steering Knuckle, Right Hand	AM87404300	\$ 1400.00	
		Steering Knuckle, Left Hand 12-Bolt For Super Steer	AM87404298	\$ 1400.00	
	T8010, T8020, T8030, T8040, T8050, TG210, TG215, TG230, TG245, TG255, TG285	Shim Kit Replaces 1277247C1, B94587, B94585	AM1981236C1	\$ 20.00	
	T8010, T8020, T8040, T8050, TG210, TG230, TG245, TG255, TG275, TG285, TG305	Shim Kit	AM310960A1	\$ 100.00	

Ford® / New Holland®—Tractor

Mechanical Front Wheel Drive Parts

Application	Description	Part Number	Retail Price	Core
 5640, 6640, 6640O, 7740, 7740O, 7840, 7840O, 8240, 8340	Trunnion, Upper Replaces 1995414C1, B503049, CAR125149	AM81863173	\$ 96.50	
 5640, 6640, 6640O, 7740, 7740O, 7840, 7840O, 8240, 8340, Ind/Utility: 250C, 340B, 345C, 345D, 445, 445A, 445C, 445D, 450, 455, 455C, 455D, 540, 540B, 545, 545A, 545C, 545D, Backhoe-Loaders: 555, 555A, 555B, 555C, 575D, 655, 655A, 655C, 655D	Trunnion, Lower Replaces 3475348M1, 83952503, 153326212	AMN13504	\$ 73.50	
 5600, 5700, 6600, 6700	Trunnion	AML35606	\$ 30.00	
 5610S, 6610S, 6810S, 7610S, TB80, TB85, TB90, TB100, TB110B, TB120, TS6000, TS6020, TS6030, Backhoe-Loaders: 555E, 575E, 655E, 675E, B90B, B95B, B95BLR, B95BTC, B95LR, B100B, B110, B110B, LB75, LB75.B, LB90, LB90.B, LB95, LB110, LB110.B, NH85TLB	Trunnion Replaces 122259A1, 3311329M91, 3311331M91, 3523550M1, 6190566M1, 47108554, 81863002, 82850292, 137700410855, CAR12881	AM9968025	\$ 120.00	
 (T8010, T8020, T8030, T8040, T8050, T8.275 w/o CVT, TG255, TG275, TG285, TG305 - w/ Standard Axle w/ 12-Bolt Hubs w/ and w/o Differential Lock), (T8010, T8020, T8030, T8040, T8050, TG210, TG215, TG230, TG245, TG255, TG275, TG285, TG305 - w/ Suspended Axle w/ 12-Bolt Hubs w/ Differential Lock), (T8010, T8020, T8030, T8040, T8050, TG210, TG215, TG230, TG245, TG255, TG275, TG285, TG305 - w/ SuperSteer™ Axle w/ 12-Bolt Hubs w/ and w/o Differential Lock), T8.275* w/ Suspended Axle w/ 12-Bolt Hubs w/ Differential Lock, (TG210, TG215, TG230 ASN MY00184591, TG245 - w/ Standard Axle w/ 12-Bolt Hubs w/ Differential Lock), (TG210 ASN MY00184591, TG230 - w/ Standard Axle w/ 12-Bolt Hubs w/o Differential Lock), (T8.275 w/o CVT w/ DANA® Axle w/ 12-Bolt Hubs w/o Differential Lock) *Prior to 06/14/13 w/o CVT	Shim Kit For Upper and Lower Trunnion Caps	AM313557A1	\$ 100.00	
T8010, T8020, T8030, T8040, T8050, T8.275, T8.300, T8.330, T8.360, TG210, TG215, TG230, TG245, TG255, TG275, TG285, TG305	Trunnion Bearing, Pivot Housing Replaces 070HC103	AM368728A1	\$ 132.00	
(T8010, T8020, T8030, T8040, T8050, TG210, TG215, TG230, TG245, TG255, TG275, TG285, TG305 - w/ Suspended Axles), (T8.275, T8.330, T8.360 - w/ Suspended Axles w/o CVT w/ DANA® Axle)	Plate	AM87406476	\$ 375.00	
(5640, 6640, 7740 - 10/1994 and Later), (7840, 8240, 8340 - 1995 and Later), 8160, 8260, TD75D, TD80D, TD90D, TD95D, TD5030 (Tier 3), TD5050, TL80, TL80A, TL90, TL90A, TL100, TL100A, TM115, TM120, TM125, TM130, TM135, TM140, TS90, TS100, TS100A, TS110, TS110A, TS115, TS115A, TS125A, TS130A, TS135A	Trunnion	AM5137239	\$ 68.22	

Ford® / New Holland®—Tractor





MFWD Hub Components

Application	Description	Part Number	Retail Price	Core
8670, 8770, 8870, 8910, 8920, 8970	Carrier Flange Assembly 3-Pin Hub 86017447, 87780417, B94587	AM86020261	\$ 1800.00	
 T8010, T8020, T8030, T8040, T8050, TG210, TG215, TG230, TG245, TG255, TG275, TG285	Carrier Flange Assembly 4-Pin Hub, 10-Bolt Flange Includes Flange, Gears, Needle Bearings and Thrust Washers	AM302251A2	\$ 1500.00	
8670, 8770, 8870, 8970	Flange Assembly 10-Bolt Hub Replaces 86002342, 86505121	AM86025944	\$ 700.00	
 T8010, T8020, T8030, T8040, T8050, TG210, TG215, TG230, TG245, TG255, TG285	Flange Assembly 10-Bolt Hub Replaces 295165A1, 87588833	AM302173A1	\$ 595.00	
T8010, T8020, T8030, T8040, T8050, TG210, TG215, TG230, TG245, TG255, TG285	Flange 10-Bolt Hub Bolts and Bearings Not Included	AM87588833	\$ 625.00	
 T8010, T8020, T8040, T8050, TG210, TG230, TG245, TG255, TG275, TG285, TG305	Planetary Gear Kit For 10-Bolt Hub	AM316330A2	\$ 650.00	
 T8010, T8020, T8040, T8050, TG210, TG230, TG245, TG255, TG275, TG285, TG305	Planetary Gear Kit For 12-Bolt Hub	AM316328A1	\$ 1060.00	
 3230, 3430, 3930, 4130, 4630, 4830, 5030	Planetary Pinion Carrier Replaces 81879351	AMRE45942	\$ 531.62	
 5610, 6610, 6710, 7610, 7710, 7910, 8210 - w/ APL325 Front Axle	Planetary Pinion Carrier	AME1NN1N045AA	\$ 1778.52	
(3600, 4100, 4600, 5600, 5700 - 1977 and Later), 6600, 6700	Planetary Pinion Gear 26 Tooth Replaces 3230261R1, L35588	AMZP1927562	\$ 157.70	
(5110, 5610, 6410, 6610, 7610 Prior to 02/1987)	Planetary Pinion Gear Replaces 83946053, 4472352014, ZP4472352014	AM81325C1	\$ 59.00	
 5610, 6610, 6710, 7610, 7710, 7910, 8210 - w/ APL325 Front Axle	Planetary Pinion Gear	AME1NN4044AB	\$ 200.00	
 (6710, 7610, 7710 - w/ APL345 Front Axle), (6710, 7710, 7910, 8210 - w/ APL350 Front Axle), (7910, 8210, TW5, TW12, TW25 - w/ APL355 Front Axle)	Planetary Pinion Gear	AMZP4472353463	\$ 180.00	
 5610, 6610, 6710, 7610, 7710, 7910, 8210 - w/ APL325 Front Axle	Planetary Pinion Shaft	AME1NN3A328AB	\$ 235.00	
 (6710, 7610, 7710, TW5, TW25 - w/ APL345 Front Axle), (6710, 7710, 7910, 8250 - w/ APL350 Front Axle)	Planetary Pinion Shaft	AMZP4472353158	\$ 180.00	
4WD: 5110, 5610, 6610, 7610 - Prior to 02/1987 w/ APL335 Front Axle	Planetary Pinion Shaft Replaces 83946032, 83949049, ZP4472352075	AM81320C1	\$ 66.00	

Mechanical Front Wheel Drive Parts

Ford® / New Holland®—Tractor



Mechanical Front Wheel Drive Parts

Application	Description	Part Number	Retail Price	Core
5110, 5610, 5610S, 5640, 6410, 6610, 6610O, 6610S, 6640, 6640O, 6710, 6810, 6810S, 7010, 7410, 7610, 7610O, 7610S, 7710, 7740, 7740O, 7810S, 7840, 7840O, 8010, TB80, TB85, TB90, TB100, TB110, TB120, TS6000, TS6020, TS6030, Ind/Utility: 250C, 260C, 345C, 345D, 445C, 445D, 455, 455C, 455D, 545C, 545D, Backhoe-Loaders: 555C, 555D, 555E, 575D, 575E, 655C, 655D, 655E, 675D, 675E, NH85TLB	Ring Gear Replaces 83952533, H437677, K395126	AM9968069	\$ 315.53	
 5610, 6610, 6710, 7610, 7710, 7910, 8210 - w/ APL325 Front Axle	Ring Gear	AME1NN1N043AA	\$ 575.00	
5610S, 5640, 6610S, 6640, 6640O, 6810, 6810S, 7610, 7610O, 7610S, 7710, 7740, 7740O, 7810, 7810O, 7840, 7840O, 7910, 8010 ASN 800001M, TB80, TB85, TB90, TB100, TB110, TB120, TS6000, TS6020, TS6030, Ind/Const: 345C, 345D, 445, 445A, 445C, 445D, 450, 545, 545A, 545C, 545D, 555C, 555D, 575D, 655C, 655D, 675D	Ring Gear Replaces 3475610M1, 83954696, 137700420856	AMN13513	\$ 99.50	
 8670, 8770, 8870, 8970	Ring Gear Replaces 86505064	AM1277250C1	\$ 545.00	
4WD: 5110, 5610, 6610, 7610 - Prior to 02/1987 w/ APL335 Front Axle	Ring Gear Replaces 83946031, 83954879, ZP4472352168	AM81319C1	\$ 355.00	
5640, 6640, 6640O, 6810, 7010, 7610, 7610O, 7710, 7740, 7740O, 7810O, 7810S, 7840, 8010, Ind: 250C, 260C, 345C, 345D, 445C, 445D, 455C, 455D, 545C, 545D, 555C, 555D, 555E, 575D, 575E, 655C, 655D, 655E, 675D, 675E	Inner Plate, Planetary Ring Gear Replaces 44079R1, 9968065, 83952534	AMH437678	\$ 131.00	
 8530, 8630, 8670, 8730, 8770, 8830, 8870, 8970	Sun Shaft Replaces 1961770C1, 86016137	AM250728A1	\$ 175.00	
 T8010, T8020, T8040, T8050, TG210, TG230, TG245, TG255, TG275, TG285, TG305	Sun Shaft	AM281982A3	\$ 315.00	

Ford® / New Holland®—Tractor





Application	Description	Part Number	Retail Price	Core
 <p>(8670, 8770, 8870, 8970 - 09/1993 and Later), T8010, T8020, T8030, T8040, T8050, TG210, TG215, TG230, TG245, TG255, TG275, TG285, TG305, (T8.275*, T8.300**, T8.330***, T8.360**** - w/ DANA® MFWD Axle) *Prior to 06/14/2013 w/o CVT w/ Suspended Axle w/ Differential Lock and 12-Bolt Hubs or All w/o CVT w/ Standard Axle **Prior to 06/14/2013 w/o CVT and Suspended Axle w/o Differential Lock and 12-Bolt Hubs or All w/o CVT w/ Standard Axle, or All w/o CVT and DANA® Suspended Axle ***Prior to 06/14/2013 w/o CVT and Suspended Axle w/o Differential Lock and 12-Bolt Hubs, or All w/o CVT w/ Standard Axle, or All w/o CVT and Suspended Axle w/o Differential Lock and 12-Bolt Hubs, or All w/o CVT and Standard Axle w/o Differential Lock and 12-Bolt Hubs ****Prior to 06/14/2013 w/ CVT and Suspended Axle w/ Differential Lock and 12-Bolt Hubs, or All w/ CVT and Suspended Axle w/ Differential Lock and 12-Bolt Hubs, or All w/ CVT and Standard Axle w/ 12-Bolt Hubs, or All w/o CVT w/ Standard Axle</p>	Oil Seal, Sunshaft 0.499" Wide, 1.563" ID, 2.129" OD Replaces 86508079, 87759992	AM128647A1	\$ 45.00	
T8010, T8020, T8030, T8040, T8050, (T8.275, T8.330, T8.360, T8.390 - w/o CVT), TG210, TG215, TG230, TG245, TG255, TG275, TG285, TG305 - All w/ 12-Bolt Hubs	Bearing Cup, Inner Planetary Hub 1.9375" Wide, 7.1875" OD	AML31698	\$ 72.00	

MFWD Differentials and Components

Application	Description	Part Number	Retail Price	Core
8670, 8770, 8870, 8970	Differential Carrier Assembly, MFWD Replaces 86002329	AM86017482	\$ 4675.00	
T8010, T8020, T8030, T8040, T8050, T8.275, T8.300, T8.330, T8.360, TG210, TG215, TG230, TG245, TG255, TG275, TG285, TG305	Differential Carrier Assembly, MFWD For Axles w/ 10-Bolt Hubs w/ Differential Lock Replaces 87404543	AM87324474	\$ 7000.00	
T8010, T8020, T8030, T8040, T8050, TG210, TG215, TG230, TG245, TG255, TG285	Differential Carrier Assembly, MFWD For Axles w/ 10-Bolt Hubs w/o Differential Lock Replaces 87404055	AM87324562	\$ 4750.00	
 <p>T8010, T8020, T8030, T8040, T8050, TG210, TG215, TG230, TG245, TG255, TG275, TG285, TG305 - w/ 12-Bolt Hubs</p>	Differential Carrier Assembly, MFWD For Axles w/o Differential Lock Replaces 87404092	AM87324564	\$ 7300.00	
8670, 8770, 8870, 8970	Ring Gear and Pinion Set, MFWD Replaces 86002330	AM86017483	\$ 975.00	
T8010, T8020, T8030, T8040, T8050, T8.275, T8.300, T8.330, T8.360, TG210, TG215, TG230, TG245, TG255, TG275, TG285, TG305	Ring Gear and Pinion Set, MFWD 12-Bolt	AM87324538	\$ 950.00	
 <p>T8010, T8020, T8030, T8040, T8050, TG210, TG215, TG230, TG245, TG255, TG285</p>	Ring Gear and Pinion Set, MFWD Replaces 84427940	AM1968293C1	\$ 320.00	

Ford® / New Holland®—Tractor

Mechanical Front Wheel Drive Parts

Application	Description	Part Number	Retail Price	Core
 TG210, TG230, TG255, TG285	Ring Gear and Pinion Set, MFWD 30 km/hr	AM321516A1	\$ 655.00	
8670, 8770, 8870, 8970	Axle Shaft Assembly, Right Hand Axle Shaft Assembly, Left Hand	AM86505032 AM86505031	\$ 865.00 \$ 1185.00	
 5600, 5700, 6600, 6700 - w/ APL1351 Front Axle	Axle Shaft, Short Fits 35.50" Axles Only	AMZP1927571	\$ 140.00	
 5600, 5700, 6600, 6700 - w/ APL1351 Front Axle	Axle Shaft, Long Fits 35.50" Axles Only	AMZP1927573	\$ 295.00	
T8010, T8020, T8030, T8050, TG210, TG215, TG230, TG245, TG255, TG275, TG285, TG305	Differential Clutch Disc and Gear Kit, MFWD Includes Bevel Gears, Pinion Gears, Cross Shaft, Clutch Discs, Clutch Plates and Thrust Washers For Axles w/o Differential Lock Replaces 377176A1, 87775804	AM377176A3	\$ 1350.00	
 T8010, T8020, T8030, T8040, T8050, TG210, TG230, TG245, TG255, TG275, TG285, TG305	Differential Carrier Assembly, MFWD For Axles w/ 10-Bolt or 12-Bolt Hubs w/o Differential Lock Replaces 345688A1, 345688A2	AM345688A4	\$ 1750.00	
(T8010, T8020, T8030, T8040, T8050 - w/ 10-Bolt or 12-Bolt Hubs), (T8.275, T8.330, T8.360 - Prior to 06/14/2013 w/ 12-Bolt Hubs w/ DANA® Axle w/o CVT), ((TG210, TG230, TG255, TG285 ASN MY00184591), TG215, TG245, TG275, TG305 - All w/ 12-Bolt Hubs), (TG210, TG230, TG255, TG285 ASN MY00195879), TG215, TG245 - All w/ 10-Bolt Hubs)	Differential Clutch Piston, MFWD For Axles w/ Differential Lock	AM87324486	\$ 220.00	
(T8010, T8020, T8030, T8040, T8050 - w/ 10-Bolt or 12-Bolt Hubs w/ Differential Lock), (TG210, TG215, TG230, TG245, TG255, TG275, TG285, TG305 - w/ 12-Bolt Hubs w/ Differential Lock), ((TG210, TG230, TG255, TG285 ASN MY00195879), TG215, TG245 - All w/ 10-Bolt Hubs w/ Differential Lock)	Differential Housing Assembly, MFWD w/ Bare Carrier Differential, Ring Gear and Pinion Not Included Replaces 87310140, 87404545	AM87324492	\$ 5250.00	
(T8010, T8020, T8030, T8040, T8050 - w/ 10-Bolt and 12-Bolt Hubs w/ Differential Lock), (T8.275, T8.330, T8.360 - Prior to 06/14/2013 w/ 12-Bolt Hubs w/ Differential Lock w/ DANA® Axle w/o CVT), ((TG210, TG230, TG255, TG285 ASN MY 00184591), TG275, TG305 - All w/ 12-Bolt Hubs w/ Differential Lock), (TG210, TG230, TG255, TG285 ASN MY 00195879 - w/ 10-Bolt Hubs w/ Differential Lock), (TG215, TG245 - w/ 10- Bolt and 12-Bolt Hubs w/ Differential Lock)	Differential Clutch Disc Kit, MFWD Includes (9) Clutch Discs and (10) Clutch Plates	AM87324488	\$ 515.00	
(T8010, T8020, T8030, T8040, T8050 - w/ 10-Bolt and 12-Bolt Hubs w/ Differential Lock), (T8.275, T8.330, T8.360 - Prior to 06/14/2013 w/ 12-Bolt Hubs w/ Differential Lock w/ DANA® Axle w/o CVT), (TG210, TG230, TG255, TG285 ASN MY00184591 - w/ 12-Bolt Hubs w/ Differential Lock), (TG210, TG230, TG255, TG285 ASN MY 00195879 - w/ 10-Bolt Hubs w/ Differential Lock), (TG215, TG245 - w/ 10-Bolt and 12-Bolt Hubs w/ Differential Lock), (TG275, TG305 - w/ 12-Bolt Hubs w/ Differential Lock)	Differential Gear Kit, MFWD Includes Bevel Gears, Pinion Gears, Cross Shaft, Thrust Washers	AM87324491	\$ 1250.00	

Ford® / New Holland®—Tractor

Application	Description	Part Number	Retail Price	Core
T8010, T8020, T8030, T8040, T8050, (TG210, TG230, TG255, TG285 ASN MY00184591), TG215, TG245, TG275, TG305 - All w/ 12-Bolt Hubs	Differential Carrier Bearing Cone, MFWD	AM87324516	\$ 365.00	
	Differential Carrier Yoke, MFWD	AM87324528	\$ 300.00	
(TG210, TG230 BSN MY00164725 w/ 10-Bolt Hubs), (TG210, TG230, TG255, TG285 BSN MY00182905 w/ 12-Bolt Hubs)	Differential Clutch Driver, MFWD For Axles w/ Differential Lock	AM87404485	\$ 360.00	
(TG210, TG230 BSN MY00164725 w/ 10-Bolt Hubs), (TG210, TG230, TG255, TG285 BSN MY00182905 w/ 12-Bolt Hubs)	Differential Clutch Piston, MFWD For Axles w/ Differential Lock	AM87404477	\$ 275.00	
(TG210, TG230 BSN MY00164725 w/ 10-Bolt Hubs), (TG210, TG230, TG255, TG285 BSN MY00182905 w/ 12-Bolt Hubs)	Differential Clutch Disc Kit, MFWD Includes (13) Clutch Discs and (14) Clutch Plates For Axles w/ Differential Lock	AM87405209	\$ 725.00	
T8010, T8020, T8030, T8040, T8050, (TG210, TG230, TG255, TG285 ASN MY00184591), TG215, TG245, TG275, TG305 - All w/ 12-Bolt Hubs w/ Differential Lock	Differential Carrier, MFWD Bare Carrier Ring Gear and Pinion Not Included	AM87324513	\$ 1650.00	
((T8010, T8020, T8030, T8040, T8050, (T8.275, T8.330 - Prior to 06/14/2013 w/o CVT w/ DANA@ Axle), T8.360, TG210, TG215, TG230, TG245, TG255, TG275, TG285, TG305 - w/ 12-Bolt Hubs w/ Differential Lock), (T8010, T8020, T8030, T8040, T8050, TG210, TG215, TG230, TG245, TG255*, TG285* - w/ 10-Bolt Hubs w/ Differential Lock) *ASN MY00195879 w/ Standard Axle, ASN MY00183034 w/ Suspended Axle or ASN MY00193740 w/ SuperSteer™ Axle	Seal Retainer	AM87404997	\$ 350.00	
(T8010, T8020, T8030, T8040, T8050, T8.275*, T8.330*, T8.360*, TG210, TG215, TG230, TG245, TG255, TG275, TG285, TG305 - w/ 12-Bolt Hubs w/ Differential Lock), (T8010, T8020, T8030, T8040, T8050, TG210, TG215, TG230, TG245, TG255 ASN MY0019587, TG285 ASN MY00195879 - w/ Standard Axle w/ 10-Bolt Hubs/ Differential Lock), (TG255 ASN MY00183034, TG285 ASN MY00184588 - w/ Suspended Axle w/ 10-Bolt Hubs w/ Differential Lock) *Prior to 06/14/2013 w/out CVT w/ DANA@ Axle	Seal	AM87404471	\$ 85.00	







Ford® / New Holland®—Tractor

Mechanical Front Wheel Drive Parts



Application	Description	Part Number	Retail Price	Core
Ford®/New Holland® Tractors: (T8010, T8020, T8030, T8040, T8050, (TG210, TG230, TG255, TG285 ASN MY00184591), TG275, TG305 - w/ Standard Axle w/ 12-Bolt Hubs w/ and w/o Differential Lock), (T8010, T8020, T8030, T8040, T8050, TG215, TG245, TG275, TG305 - w/ Suspended Axle w/ 12-Bolt Hubs w/ and w/o Differential Lock or w/ SuperSteer™ Axle w/ 12-Bolt Hubs w/ and w/o Differential Lock), (T8.275**, T8.330**, T8.360** - w/ Standard Axle w/ 12-Bolt Hubs w/ Differential Lock), (TG210***, TG230***, TG255***, TG285*** - w/ Suspended Axle w/ 12-Bolt Hubs w/ and w/o Differential Lock), (TG210****, TG230****, TG255****, TG285**** - w/ SuperSteer™ Axle w/ 12-Bolt Hubs w/ and w/o Differential Lock), (TG215, TG245 - w/ Standard Axle w/ 12-Bolt Hubs w/ Differential Lock) **Prior to 06/14/2013 w/o CVT w/ DANA® Axle ***ASN MY00184588 w/ Differential Lock or ASN MY00195684 w/o Differential Lock ****ASN MY00195701 w/ Differential Lock or ASN MY00190632 w/o Differential Lock	Shim Kit, Differential Pinion Shaft	AM87324518	\$ 200.00	
((T8010, T8020, T8030, T8040, T8050, (TG210, TG230, TG255, TG285 ASN MY00184591), TG275, TG305 - w/ Standard Axle w/ 12-Bolt Hubs w/ and w/o Differential Lock), (T8010, T8020, T8030, T8040, T8050, TG210**, TG215, TG230**, TG245, TG255**, TG275, TG285**, TG305 - w/ Suspended Axle w/ 12-Bolt Hubs w/ and w/o Differential Lock), (T8010, T8020, T8030, T8040, T8050, TG210***, TG215, TG230***, TG245, TG255***, TG275, TG285***, TG305 - w/ SuperSteer™ Axle w/ 12-Bolt Hubs w/ and w/o Differential Lock), (T8.275*, T8.330*, T8.360*, TG215, TG245 - w/ Standard Axle w/ 12-Bolt Hubs w/ Differential Lock) *Prior to 06/14/2013 w/o CVT w/ DANA® Axle **ASN MY00184588 w/ Differential Lock or ASN MY00195684 w/o Differential Lock ***ASN MY00195701 w/ Differential Lock or ASN MY00190632 w/o Differential Lock	Shim Kit, Differential Carrier Yoke	AM87324536	\$ 180.00	
(T8010, T8020, T8030, T8040, T8050, TG210, TG215, TG230, TG245 - w/ 10-Bolt or 12-Bolt Hubs), (TG255, TG285 - w/ 10-Bolt Hubs w/o Differential Lock or ASN MY00195879 w/ Differential Lock), (T8.275*, T8.330, T8.360*, TG255, TG275, TG305 - w/ 12-Bolt Hubs) *Prior to 06/14/2013 w/o CVT w/ DANA® Axle w/ Differential Lock	Adjusting Ring, MFWD Differential Bearing	AM1277233C1	\$ 180.00	
(T8010, T8020, T8030, T8040, T8050, TG210, TG215, TG230, TG245 - w/ 10-Bolt or 12-Bolt Hubs w/ Differential Lock), (T8.275*, T8.330*, T8.360*, TG275, TG305 - w/ 12-Bolt Hubs w/ Differential Lock), (TG255**, TG285** - w/ 10-Bolt Hubs w/ Differential Lock) *Prior to 06/14/2013 w/o CVT w/ DANA® Axle **ASN MY00195879 w/ Standard Axle, ASN MY0183034 w/ Suspended Axle, ASN MY0193740 w/ SuperSteer™	Nipple Coupling, MFWD	AM87404480	\$ 95.00	

Ford® / New Holland®—Tractor









MFWD Driveshafts

Application	Description	Part Number	Retail Price	Core
 (TG210, TG230*** - w/ Standard, Suspended or Super Steer Axle w/ 10-Bolt Hubs), (TG210, TG230, TG255, TG285**** - w/ Standard, Suspended or Super Steer Axle w/ 12-Bolt Hubs)	Drive Shaft Assembly, Right Hand For Axles w/ Differential Lock	AM87404999	\$ 700.00	
***BSN MY00164725 w/ Standard Axle, BSN MY00182861 w/ Suspended Axle or BSN MY00184573 w/ Super Steer Axle	Drive Shaft Assembly, Left Hand For Axles w/ Differential Lock	AM87405000	\$ 675.00	
****BSN MY00182905 w/ Standard Axle, BSN MY00178966 w/ Suspended Axle or BSN MY00164720 w/ Super Steer Axle				
 T8010, T8020, T8030, T8040, T8050, T8.275, T8.300, T8.330, T8.360, TG210, TG215, TG230, TG245, TG255, TG275, TG285, TG305	Axle Shaft Assembly, Right Hand w/ Differential Lock	AM87324476	\$ 780.00	
 T8010, T8020, T8040, T8050, TG210, TG230, TG245, TG255, TG275, TG285, TG305	Inner Yoke, Right Hand w/ Differential Lock	AM87325892	\$ 815.00	
	Inner Yoke, Left Hand w/ Differential Lock	AM87307641	\$ 875.00	
 T8010, T8020, T8040, T8050, TG210, TG230, TG245, TG255, TG275, TG285, TG305	Inner Yoke, Right Hand w/o Differential Lock	AM395741A1	\$ 715.00	
	Inner Yoke, Left Hand w/o Differential Lock	AM395743A1	\$ 800.00	
 T8010, T8020, T8040, T8050, TG210, TG230, TG245, TG255, TG275, TG285, TG305	Outer Yoke	AM395737A1	\$ 300.00	
 T8010, T8020, T8040, T8050, TG210, TG230, TG245, TG255, TG275, TG285, TG305	Center Yoke	AM395740A1	\$ 245.00	
T7030, T7040, T7050, T7060, T7070, T6.120, T6.125, (T6.140, T6.150, T6.160 - Electro Command), T6.145, T6.155, T6.165, T6.175, T6.180, T7.220, T7.230, T7.235, T7.245, T7.250, T7.260, T7.270, T7.290, T7.315, TM175, TM190	Friction Disc, MFWD Engagement Clutch	AM5163844	\$ 9.63	
T8010, T8020, T8030, T8040, T8050, T8.275, T8.300, T8.330, T8.360, TG210, TG215, TG230, TG245, TG255, TG275, TG285, TG305	Seal	AM302957A1	\$ 24.00	











Tie Rods and Components

Application	Description	Part Number	Retail Price	Core
 2N, 9N	Tie Rod 3.187" Long, 0.687" Diameter 18 Right Hand Thread	AM9N3270	\$ 10.00	
 2N, 8N, 9N, 600, 800, 2000, 4000 Series, NAA - w/ 4 Cylinder Engines	Tie Rod, Rear Drag Link End 4.25" Long, 0.687" Diameter 18 Right Hand Thread	AMNAA33271A	\$ 13.00	
 (2N, 8N, 9N, 600 Series, 700 Series, 800 Series, 900 Series, 2000 Series, 4000 Series, NAA - w/ 4 Cylinder Engines Prior to 1964), (2000 Series, 3000 Series, 4000 Series - w/ 3 Cylinder Engines 1965-74), (2310, 2600, 2610, 2810, 2910, 3600, 3610, 3910, 4600SU, 4610SU - w/ 3 Cylinder Engines)	Radius Rod Ball Cap	AME0NN3N406BA	\$ 10.00	











Ford® / New Holland®—Tractor

	Application	Description	Part Number	Retail Price	Core
	(2N, 8N, 9N, 600 Series, 700 Series, 800 Series, 900 Series, 2000 Series, 4000 Series, NAA - w/ 4 Cylinder Engine, Prior to 1964), (2000 Series, 3000 Series, 4000 Series - w/ 3 Cylinder Engines, 1965-75), (2310, 2600, 2610, 2810, 2910, 3600, 3610, 3910, 4600SU, 4610SU - w/ 3 Cylinder Engine)	Radius Rod Ball Socket	AME0NN3N442BA	\$ 16.00	
	8N	Tie Rod, Front Drag Link End 3.375" Long, 0.687" Diameter 18 Left Hand Thread	AM8N3270	\$ 11.00	
	8N	Tie Rod Tube 32.75" Long, 0.875" OD	AM8N3314D	\$ 57.25	
	230A, 231, 234, 334, 335, 530A, 531, 532, 2000, 2100, 2110, 2120, 2150, 2310, 2600, 2600N, 2600R, 2600V, 2610, 2810, 2910, 3000, 3055, 3100, 3150, 3330, 3600, 3600N, 3600NO, 3600R, 3600V, 3610, 3610NO, 3610V, 3900, 3910, 3910H, 3910N, 3910R, 3910V, 4000, 4100, 4110, 4110N, 4110NO, 4110O, 4140, 4330, 4340, 4600, 4600SU, 4610, 4610NO, 4610SU, 4610V	Tie Rod, Rear Drag Link End, Left Hand 28.125" Long Replaces 81802895	AMC5NN3308E	\$ 122.11	
	234, 334, 335, 2000, 2310, 2600, 2610, 2810, 2910, 3000, 3600, 3610, 3900, 3910, 4000, 4100, 4110, 4140, 4330, 4340, 4600SU, 4610, Ind: 530A - w/ Power Steering	Tie Rod 3.312" Long, 0.75" Diameter 16 Left Hand Thread	AMC5NN3A300B	\$ 15.00	
	250C, 260C, 345C, 345D, 445A, 445C, 445D, 450, 455, 455C, 455D, 545, 545A, 545C, 545D, 550, 555, 555A, 555B, 555C, 555D, 575D, 655 - w/ MFWD	Inner Tie Rod, Right Hand M24x1.50 mm Thread Replaces 8390617	AMCAR87031	\$ 73.25	
	600, 800, 2000, 4000 Series, NAA - w/ 4 Cylinder Engines	Tie Rod, Front Drag Link End 3.875" Long, 0.687" Diameter 18 Left Hand Thread	AMNAA3270A	\$ 11.00	
	2000 w/ 3 Cylinder Engine w/ Power Steering, 2100, (2120, 4140 - w/ 3 Cylinder Engine), (2600, 2610, 3600, 3610, 3910, 4100 - w/o Cab w/ Power Steering), 2810, 2910, 3000, 3330, 3900, 4000, 4110, 4330, 4340, 4600, Ind: 230A, 231, 234, 334, 335, 531	Rear Drag Link End, Right Hand 29.625" from Grease Zerk to End of Shaft	AMC5NN3307G	\$ 113.07	
	2000, 2600, 2610, 2910, 3000, 3600, 3610, 3910, 4000, 4100, 4110, 4600SU, 4610SU, Super Dexta - w/ Manual Steering	Tie Rod, Front Drag Link End 4.00" Long, 0.687" Diameter 18 Left Hand Thread	AM957E3290B	\$ 11.00	
	2000, 2600, 2610, 2910, 3000, 3600, 3610, 3910, 4000, 4100, 4110, 4600SU, 4610SU, Super Dexta - w/ Manual Steering	Tie Rod, Rear Drag Link End 4.50" Long, 0.687" Diameter 18 Right Hand Thread	AM957E3307B	\$ 12.00	
	(3000, 3400, 3600, 4000, 4100, 4410, 4600 - European), Ind: 335, 532	Tie Rod 4" Long 13/16"-16 Left Hand Thread	AMC5NN3A300C	\$ 32.48	













Ford® / New Holland®—Tractor

	Application	Description	Part Number	Retail Price	Core
	(3010S, 4010S, 5010S ASN 702415M), 5610S ASN 310660M, 6610S ASN 362005M, 7610S ASN 258571M, TB80, TB85, TB90, TB100M, TB110, TB120, TT55, TT65, TT75	Outer Tie Rod End, Right Hand 30" Long, 1" Diameter	AM82981599	\$ 120.00	
	(3010S, 4010S, 5010S ASN 400001M), TD60D, TD70D, TT55, TT60A, TT65, TT75, TT75A	Tie Rod Assembly 49.88" Long	AM5135076	\$ 200.00	
	(3010S, 4010S, 5010S ASN 400001M), TT55, (TT60A, TT75A - w/ MFWD), TT65, TT75	Tie Rod 51.94" Long 1 1/8" Internal Threads	AM5135075	\$ 200.00	
	3230, 3430, 3930, 4130, 4630, 4830, 5030 - w/ 4WD Carraro™ Axle	Tie Rod End 6.625" Long M18x1.50" Left Hand Internal Thread Replaces 1537611C1, 81875596, 81878537	AMVPJ3210	\$ 118.80	
	3230, 3430, 3930, 4130, 4630, 4830, 5030	Tie Rod 7 Holes in Side 0.935" ID, 17.812" Long Replaces 83983704	AME7NN3278AA	\$ 99.50	
	3230, 3430, 3930, 4130, 4630, 4830, 5030, 5610, 5610S, 6610, 6610S, 6810, 6810S, 7010, 7610, 7610S, 7810, 7910, 8010	Ball Joint, Left Hand 7.04" Long M20x1.50" Right Hand Thread M18x1.50" Left Hand Thread Replaces 48084983, 83957148, 87714488	AMCAR49006	\$ 61.75	
	3430, 3930, 4000, 4100, 4330, 4340, 4600, 4610, 4630, 4830, 5030	Tie Rod, Front Drag Link End 9" Long, 0.865" Diameter, Notched Replaces C5NN3A300A	AMD0NN3A300A	\$ 19.00	
	3430 w/ Manual Steering, 4000, 4130, 4600, 4610	Outer Tie Rod, Right Hand 3.75" Long, 0.75" Diameter 16 Internal Thread	AMC5NN3289C	\$ 18.00	
	3600, 4100, 4600, 5610, 5700, 6610, 6700, 6710, 7410, 7610, 7700, 7710, 7810, 7810O, 7910, 8000, 8210, 8530, 8630, 8700, 8730, 8830, 9000, 9700, TW5, TW10, TW15, TW20, TW25, TW30, TW35, Utility: 532	Tie Rod, Short 8.625" Long, 1" Diameter, 16 Right Hand Thread Replaces 83906918, 83929289, D5NN3289A	AME1NN3289AA	\$ 26.50	
	4000, 4600, 4610	Outer Tie Rod, Left Hand 19" Long, 0.75" Diameter	AMC5NN3278A	\$ 23.00	
	4835, 5635, 6635, 7635, T5040, T5050, T5060, T5070, T4.55, T4.65, T4.75, T4.90, T4.100, T4.110, T4.120, TL70, TL80, TL80A, TL90, TL90A, TL100, TL100A	Tie Rod End 4" Long M24x1.50" Right Hand Thread	AM5178390	\$ 58.50	
	5000, 5100, 5340, 7000, 7100 - w/ Manual Steering	Drag Link End 5.031" Long, 1" Diameter 16 Right Hand Thread	AMC5NN3307E	\$ 25.00	
	(5000, 5340, 5600, 5610, 6600, 6610, 7000, 7100 - 1965-05/31/67 w/ Manual Steering)	Outer Tie Rod, Left Hand 0.94" Diameter, 17.50" Long 7 Notches	AMC5NN3281C	\$ 44.00	
	5000, 5100, 5600, 5900, 6600, 6610, 7000, 7100, 7600, 7610 - w/ Power Steering	Outer Tie Rod, Right Hand 15.375" Long, 0.937" Diameter, 7 Notches	AMC7NN3280E	\$ 22.00	
	5000, 5100, 5600, 5900, 6600, 6610, 7000, 7100, 7600, 7610 - w/ Power Steering	Outer Tie Rod, Left Hand 15.375" Long, 0.937" Diameter, 7 Notches	AMC7NN3281A	\$ 25.00	







Ford® / New Holland®—Tractor

	Application	Description	Part Number	Retail Price	Core
	5000, 5100, (5600, 6600 - Hi-Clearance), 5610, 5900, 6610, 6700, 7000, 7100, 7600, 7700, 7710	Inner Tie Rod, Right Hand 3.75" Long, 1" Diameter 16 Thread	AMC7NN3289D	\$ 18.00	
	5000, 5100, 5600, 5610, 5900, 6600, 6610, 7000, 7100, 7600, 7610	Drag Link Assembly 50.50" Long	AME0NN3304CA	\$ 77.00	
	5000, 5600, 5610, 6600, 6610, 7000 - 1965-06/67 w/ Manual Steering	Outer Tie Rod, Right Hand 17.50" Long, 0.94" Diameter	AMC5NN3280F	\$ 35.00	
	5100, 5600, (5600, 6600, 7600 - Hi-Clearance), 5610, 5900, 6600, 6610, 7100, 7600, 7610 - w/ Power Steering	Tie Rod, Left Hand 18.125" Long	AMC7NN3B161A	\$ 25.00	
	5110, 5610, 5910, 6610, 6710, 6810, 7410, 7610, 7710	Ball Joint 7.54" Overall Length M20x1.50" Right Hand External Thread M22x1.50" Right Hand External Thread Replaces 1968463C1, 1968468C1, 83957098	AMZP0501310060	\$ 52.50	
	5110, 5610, 6410, 6610, 6610O, 6710, 6810, 7410, 7610, 7610O, 7710	Outer Tie Rod, Right Hand 13.375" Long M22x1.50" Right Hand Thread Replaces 83984963, ZP0501205469	AMZP0501206191	\$ 170.34	
	5640, 6640, 7740, 7840, 8240, 8340 - w/ MFWD	Tie Rod End 9.50" Long M24x1.50" Left Hand Thread Replaces 81863335, CAR48978	AM81863221	\$ 127.00	
	5640, (T6020, T6030 - Tier 3 Delta or Tier 3 Plus), 6640, 7740, (7840, 8240, 8340 - 11/1991 and Later), T6010, TS90, TS100, TS100A, TS110, TS115A, TS130A	Outer Tie Rod, Right Hand 19.875" Long, 1.375" Diameter Replaces E9NN3278AA	AM81864106	\$ 119.38	
	5700, 6700, 6710, 7700, 7710, 8000, 8700, 9000, 9700, TW5, TW15, TW25, TW30	Tie Rod 3.75" Long, 1" Diameter 16 Right Hand Thread	AMD8NN3A302AA	\$ 40.00	
	7840, 7840O, 8240, 8340, T6010, T6020, T6030, T6050, T6070, TS90, TS100, TS100A, TS110, TS110A, TS115A, TS125A, TS130A, TS135A	Tie Rod End 4" Long 1 1/4"x12 UNC Right Hand Thread	AM81863815	\$ 200.00	
	8000, 8200, 8400, 8600, 8700, 9200, 9600 - w/ Wide or All Purpose Axle	Tie Rod 3.812" Long, 1" Diameter 16 Right Hand Thread Use w/ AMC7NN3280D Tie Rod Replaces C5NN3280R, C5NN3307F	AME3NN3307AA	\$ 20.00	
	8000, 8200, 8400, 8600, 8700, 9200, 9600 - w/ Wide or All Purpose Axle	Tie Rod 19.625" Long, 0.937" Diameter, 9 Notches	AMC7NN3280D	\$ 35.00	
	(8530, 8630, 8730, 8830, TW5, TW15, TW25, TW35 - w/ Heavy Duty Wide Adjustable Axle)	Tie Rod 7 Cross Holes 1.187" Diameter, 29.50" Long	AME2NN3280BA	\$ 180.25	
	8530, 8630, 8730, 8830, TW5, TW15, TW25, TW35 - w/ APL 365 Axle	Ball Joint 9" Long M22x1.50" Right Hand Thread M28x1.50" Right Hand Thread Replaces 3957095	AMZP0501205394	\$ 100.00	
	8670, 8670A, 8770, 8770A, 8870, 8870A, 8970, 8970A	Tie Rod 4.125" Long, 1.125" Diameter 12 Right Hand Thread	AM86502997	\$ 55.00	

Ford® / New Holland®—Tractor

Application	Description	Part Number	Retail Price	Core
 8670, 8670A, 8770, 8770A, 8870, 8870A, 8970, 8970A	Tie Rod 7.25" Long, 1.25" Diameter 12 Right Hand Thread	AM86020750	\$ 30.00	
 8670, 8670A, 8770, 8770A, 8870, 8870A, 8970, 8970A	Tie Rod 7.25" Long, 1.25" Diameter 12 Left Hand Thread	AM86020751	\$ 60.00	
8670, 8770, 8870, 8970 - w/ MFWD	Tie Rod, Right Hand 12.75" Long, 1.25" Diameter 12 Right Hand Thread	AM86024885	\$ 175.00	
 8670, 8770, 8870, 8970 - w/ MFWD	Tie Rod, Left Hand 12.75" Long, 1.25" Diameter 12 Left Hand Thread	AM86024884	\$ 241.44	
 8700, 9700, (TW10, TW20 - w/ Standard Short Wheelbase)	Tie Rod 33.062" Long, 1.187" Diameter, 8 Cross Holes	AME1NN3280AA	\$ 50.00	
 T6010, T6020, T6030, T6040, T6050, T6060, T6070, T6080, TS110A, TS115A, TS125A, TS135A	Tie Rod Assembly 58.875" Long M18x1.50" Right Hand Thread M24x1.50" Right Hand Thread	AM5197798	\$ 225.00	
T6010, T6020, T6030, T6050, T6070, T6.125, T6.145, T6.155, T6.165, T6.175, T6.180	Tie Rod End 3.75" Long, 0.875" ID 14 UNF Right Hand Thread	AM81863813	\$ 39.00	
 T6010, T6020, T6030, T6050, T6070, T6.125, T6.145, T6.155, T6.165, T6.175, T6.180, TS125A, TS135A - w/ Heavy Duty Axle	Tie Rod 20.50" Long, 1.362" Diameter	AM81863803	\$ 186.00	
 T6030, T6050, T6070, T6080	Tie Rod Assembly 58 7/8" Long M18x1.50" Right Hand Thread M24x1.50" Right Hand Thread	AM87332622	\$ 175.00	
 T7030, T7040, T7050, T7060, TM175, TM190	Tie Rod End 4" Long 7/8"x14 Right Hand Internal Thread	AM44995130	\$ 85.00	
 T7030, TM175, TM190	Tie Rod End, Left Hand 4.31" Long M24x1.50" Right Hand Thread	AM5198880	\$ 65.00	
T8010, T8020, T8030, T8040, T8050, TG210, TG215, TG230, TG245, TG255, TG275, TG285, TG305	Tie Rod Tube For 10-Bolt Axle	AM87455775	\$ 250.00	
 T8010, T8020, T8030, T8040, T8050, TG210, TG215, TG230, TG245, TG255, TG275, TG285, TG305	Tie Rod, Right Hand 20.21" Long M36x1.50" Right Hand Thread	AM87455779	\$ 425.00	
 T8010, T8020, T8030, T8040, T8050, TG210, TG215, TG230, TG245, TG255, TG275, TG285, TG305	Tie Rod, Left Hand 20.21" Long M36x1.50" Left Hand Thread	AM87455778	\$ 425.00	
 T8010, T8020, T8030, T8040, T8050, TG210, TG215, TG230, TG245, TG255, TG275, TG285, TG305 - w/ SuperSteer™ Axle	Tie Rod End, Right Hand 16" Long M38x1.50" Left Hand Thread Original Assembly must be updated to Metric to use this End Replaces 409569A2	AM87417424	\$ 375.00	
 T8010, T8020, T8030, T8040, T8050, TG210, TG215, TG230, TG245, TG255, TG275, TG285, TG305 - w/ SuperSteer™ Axle	Tie Rod End, Left Hand 16" Long M38x1.50" Left Hand Thread Original Assembly must be updated to Metric to use this End Replaces 409568A2	AM87417425	\$ 375.00	

Ford® / New Holland®—Tractor

	Application	Description	Part Number	Retail Price	Core
	T8010, T8020, T8030, T8040, T8050, TG210, TG215, TG230, TG245, TG255, TG275, TG285, TG305 - w/ SuperSteer™ Axle	Tie Rod End, Right Hand 6.37" Long M38x1.50" Right Hand Thread Original Assembly must be updated to Metric to use this End Replaces 402341A2	AM87417426	\$ 175.00	
	TB80, TB90, TB100, TB110, TB120, TS6020, TS6030	Tie Rod and Coupling, Left Hand Replaces 48084958	AM1997712C2	\$ 210.00	
	TD60D, TD70D, TD75D, TD80D, TD90D, TD95D, TD5010, TD5020, TD5030, TD5050	Tie Rod End 21 3/8" Long Replaces 5086980	AM5085085	\$ 60.00	
	TG210, TG215	Tie Rod M38 Right Hand Thread	AM87455743	\$ 295.00	
	TG210, TG215	Tie Rod M38 Left Hand Thread	AM87455742	\$ 295.00	
	TS100A, TS110A, TS115A	Tie Rod Assembly 54.375" Long M18x1.50" Right Hand Thread M24x1.50" Right Hand Thread	AM5196358	\$ 200.00	
	TT45A, TT50A, TT60A, TT75A	Outer Tie Rod End, Left Hand 27 1/2" Long, 0.867" Diameter	AM9970790	\$ 35.00	





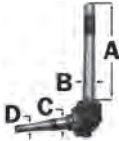
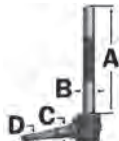
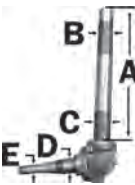
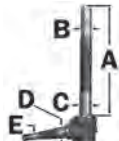
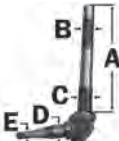

Spindles

Spindles are forged from high grades of alloy steel, machined and assembled to exact specifications that meet or exceed OEM specifications.

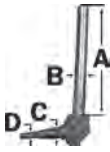

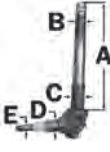
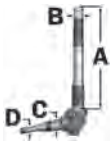

	Application	Description	Part Number	Retail Price	Core
	8N 1948-52, NAA 1953-54	Spindle	Right Hand	AM8N3105B	\$ 65.00
			Left Hand	AM8N3106B	\$ 65.00
			Bushing - Upper	AM2N3109	\$ 3.00
			Thrust Bearing	AMC0NN3123B	\$ 5.00
			Wheel Bearing Kit	WBK-FD-1	\$ 27.00
	2N, 9N - 1939-47	Spindle	Right Hand	AM2N3105	\$ 65.00
			Left Hand	AM2N3106	\$ 65.00
			Bushing - Upper	AM2N3109	\$ 3.00
			Thrust Bearing	AMC0NN3123B	\$ 5.00
			Wheel Bearing Kit	WBK-FD-1	\$ 27.00
	(600, 700, 800, 900, 2000, 4000 - 1955-64) BSN 137818 use WBK-FD-2 ASN 137818 use WBK-FD-3	Spindle	Right Hand	AMNCA3105B	\$ 68.50
		Replaces	Left Hand	AMNCA3106B	\$ 59.00
			Bushing - Upper	AM2N3109	\$ 3.00
			Bushing - Lower	AMNCA3110A	\$ 4.00
			Thrust Bearing	AMC0NN3123B	\$ 5.00
			Wheel Bearing Kit	WBK-FD-2	\$ 28.00
			Wheel Bearing Kit	WBK-FD-3	\$ 26.00
	(2000, 3000 1965-75, Vineyard), (2600, 2610 1976-81, w/o cab), (3600, 3610, 3900, 4100, 1976-80 w/o cab)	Spindle - Keyed	Right Hand	AMC5NN3105U	\$ 70.00
		Heat Treated	Left Hand	AMC5NN3106R	\$ 70.00
			Bushing - Upper	AM2N3109	\$ 3.00
			Bushing - Lower	AMNCA3110A	\$ 4.00
			Thrust Bearing	AMC0NN3123B	\$ 5.00
	2310, 2610, 2910, 3610, 3910, 4110, 4410SU, 4610 Standard, 4610SU - 1981 and Later	Spindle - Keyed	Right Hand	AME0NN3105AA	\$ 75.00
		Standard	Left Hand	AME0NN3106AA	\$ 75.00
			Bushing - Upper	AM2N3109	\$ 3.00
			Bushing - Lower	AMC5NN3110B	\$ 3.50
			Thrust Bearing	AMC5NN3A299A	\$ 6.00

Prices Subject to Change without Prior Notice. The use of original equipment manufacturer (OEM) part numbers or trademarks, e.g. Case® and John Deere®, are for reference purposes only and for indicating product use and compatibility. Our company and the listed replacement parts contained herein are not sponsored, approved or manufactured by the OEM. All parts are New unless designated Reman in the description.

Ford® / New Holland®—Tractor

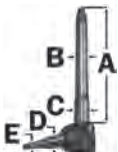
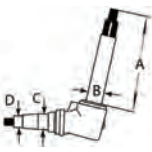
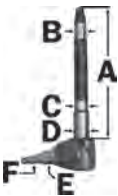
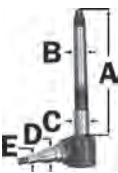
	Application	Description		Part Number	Retail Price	Core
	2600, 3600, 3900, 4100 - 1976-81 w/ Cab	Spindle - Keyed	Right Hand	AMD4NN3105B	\$ 120.00	
		Standard	Left Hand	AMD4NN3106B	\$ 120.00	
		A - 12.00	Thrust Bearing	AM138712	\$ 8.50	
		B - 1.34	Bushing - Lower	AMNCA3110A	\$ 4.00	
		C - 1.25	Wheel Bearing Kit	WBK-FD-4	\$ 20.00	
D - .75						
	(3600, 4100, 4600 - 1975-81 w/ 3 Cylinder Engine), 5700, 6700, 7700	Spindle	Right Hand	AMD5NN3105E	\$ 361.68	
		A - 16.875	Left Hand	AMD5NN3106E	\$ 388.23	
		B - 1.722				
		C - 1.934				
		D - 1.794				
E - 1.125						
	3600, 4100, 4600, 5610, 5700, 6610, 6700, 6710, 7410, 7610, 7700, 7710, 7810, 7810O, 7910, 8210, Utility: 532	Spindle	Right Hand	AMD5NN3105F	\$ 352.97	
		A - 12.875"				
		B - 1.722"				
		C - 1.934"				
		D - 1.625"				
		E - 0.842"				
	4000 1965-75, Excluding Vineyard	Spindle	Right Hand	AMC5NN3105T	\$ 70.00	
		Standard	Left Hand	AMC5NN3106N	\$ 70.00	
		A - 12.125	Bushing - Upper	AM2N3109	\$ 3.00	
		B - 1.244	Bushing - Lower	AMC5NN3110B	\$ 3.50	
		C - 1.465	Thrust Bearing	AMC5NN3A299A	\$ 6.00	
D - 1.375						
E - .75						
	4600 1976-81, 4610 1/81-2/90	Spindle	Right Hand	AMD4NN3105A	\$ 85.00	
		Standard	Left Hand	AMD4NN3106A	\$ 85.00	
		A - 12.25	Bushing - Lower	AMC5NN3110B	\$ 3.50	
		B - 1.464	Thrust Bearing	AMC5NN3A299A	\$ 6.00	
		C - 1.375	Wheel Bearing Kit	WBK-FD-5	\$ 26.00	
D - 0.75						
	5000, 5100, 5600, 6600, 7000, 7100, 7600 - 1963-75 w/ 10x16 Tires	Spindle	Right Hand	AMD2NN3105C	\$ 292.50	
		A - 10.687	Left Hand	AMD2NN3106C	\$ 302.34	
		B - 1.498	Thrust Bearing	AM138712	\$ 8.50	
		C - 1.784	Bushing	AMC5NN3109A	\$ 4.50	
		D - 1.797	Bushing	AMC5NN3110A	\$ 4.00	
E - 1.125						
	(5000, 7000 1965-75 w/o 10x16 Tires), (5600, 6600 1976-81), (5610, 6610 1981 and Later), (7600, 7610, 7700 1976 and Later)	Spindle - Keyed	Right Hand	AMC5NN3105M	\$ 70.00	
		A - 10.625	Left Hand	AMC5NN3106J	\$ 70.00	
		B - 1.498	Thrust Bearing	AM138712	\$ 8.50	
		C - 1.748	Bushing	AMC5NN3109A	\$ 4.50	
		D - 1.625	Bushing	AMC5NN3110A	\$ 4.00	
E - 0.843						
	5640, 6640, 6640O, 7740, 7740O, 7840, 7840O, 8240, 8340, TS90, TS100, TS100A, TS110, TS110A, TS115A, TS125A, TS130A, TS135A	Spindle	Right or Left Hand	AME9NN3105EB	\$ 162.00	
		A - 12.00				
		B - 1.722				
		C - 1.934				
		D - 1.625				
E - 0.843						
	5700, 6700, 6710, 7700, 7710	Spindle	Left Hand	AMD5NN3106F	\$ 449.39	
		Replaces 83908153				
		A - 12.875				
		B - 1.722				
		C - 1.934				
D - 1.625						
E - 0.842						

Ford® / New Holland®—Tractor

Application	Description	Part Number	Retail Price	Core
 5700, 6700, 6710, 7700, 7710 - Hi-Clearance	Spindle	Right Hand AMD5NN3105D	\$ 636.79	
	A - 16.775	Left Hand AMD5NN3106D	\$ 592.56	
	B - 1.722	Thrust Bearing AM138712	\$ 8.50	
	C - 1.934	Wheel Bearing Kit WBK-FD-6	\$ 27.00	
	D - 1.625	Wheel Hub AMC9NN1104D	\$ 53.50	
	E - 0.842			
 8000, 8530, 8630, 8700, 8730, 8830, 9700, TW10, TW20, TW30, TW35	Spindle	Left or Right Hand AMD9NN3105AA	\$ 869.86	
	42 Splines	Thrust Bearing AM138712	\$ 8.50	
	A - 14.75 B - 1.999 C - 2.00 D - 1.50			
 8000, 9000	Spindle	Right Hand AMC9NN3105C	\$ 538.40	
	A - 16.775	Left Hand AMC9NN3106B	\$ 624.91	
	B - 1.638	Thrust Bearing AM138712	\$ 8.50	
	C - 1.722	Bushing AMC5NN3109A	\$ 4.50	
	D - 1.934	Wheel Bearing Kit WBK-FD-7	\$ 40.00	
	E - 1.794 F - 1.125			
 8700, 9700, TW5, TW10, TW15, TW20, TW25, TW35	Spindle	Right Hand AMD5NN3105C	\$ 465.90	
	A - 16.775	Left Hand AMD5NN3106C	\$ 478.53	
	B - 1.722	Thrust Bearing AM138712	\$ 8.50	
	C - 1.934	Wheel Bearing Kit WBK-FD-7	\$ 40.00	
	D - 1.794 E - 1.125			
 (2000, 3000, 4000 1965-07/70), 4110, 4140	Front Axle Support Pin	AMC5NN3127B	\$ 24.00	
	1.75" OD, 4.25" Long Replaces C5NN3127A	Bushing AMC5NN3153C	\$ 6.50	
 (2000, 3000, 4000 - 08/70 and Later), 2100, 2110, 2120, 2310, 2600, 2610, 3055, 3100, 3120, 3310, 3600, 3610, 3910, 4100, 4110, 4140, 4600	Front Axle Support Pin	AMC7NN3127D	\$ 40.00	
	2" OD, 5.50" Long	Bushing AMC7NN3153B	\$ 4.50	
 (5000, 7000, 5600, 6600, 7600, 5610, 6610, 7610 - 1981-03/85)	Front Axle Support Pin - Front	AMC5NN3N159A	\$ 35.00	
	1.875" OD, 9" Long	Bushing AMC5NN3153A	\$ 5.00	
 (5000, 5100, 5110, 5200, 5600, 5610, 6410, 6600, 6610, 6710, 7000, 7100, 7200, 7600, 7610, 7710 - 1981-03/85)	Front Axle Support Pin - Rear	AMC5NN3N160A	\$ 34.15	
	1.25" OD, 5.15" Long	Bushing AMC5NN3446A	\$ 3.00	

Wheel Hubs and Components







Application	Description	Part Number	Retail Price	Core
8N, 501, 600, 601, 700, 800, 801, 900, 2000, 2100, 2600, 2810, 2910, 3000, 3055, 3100, 3230, 3600, 3910, 4000, 4100, 4110, 4140, 4600, 4610, 4630, NAA, Dextra	Hub Cap	AM957E1139	\$ 5.50	
601, 801, 2100, 2310, 2610, 2810, 2910, 3055, 3230, 3610, 3910, 3930, 4000, 4100, 4110, 4130AP, 4130N, 4410SU, 4600, 4610, 4610N, 4610SU 1981 and Later, 4630	Wheel Hub, 6-Bolt	AMC9NN1104E	\$ 50.00	
	Hub Cap	AM2N1139B	\$ 7.00	



Ford® / New Holland®—Tractor

Application	Description	Part Number	Retail Price	Core
501, 600, 700, 800, 900, 2000, 2100, 2300, 2600, 2610 1976-81 w/o Cab, 2910, 3000, 3100, 3300, 3600, 3610 1976-81 w/o Cab, 3900, 3910, 4000 1955-64 Orchard, 4100, 4140, Dexta	Wheel Hub, 6-Bolt	AMC9NN1104F	\$ 45.00	
2030, 3400 1965-74, 3500, 3550, 3910, 4400, 4410, 4500, 4610, 5100, 5110, 5200, 5600, 5610, 5700, 5900, 6000, 6410, 6600, 6600C, 6610, 6700, 6710, 6810, 7100, 7200, 7410, 7600, 7600C, 7610, 7700, 7710, 8000, 8240, 8340, 8700, 9000, 9700, TW5, TW10, TW15, TW20, TW25, TW30, TW35	Wheel Hub, 6-Bolt Press-In Hub Cap Use w/ WBK-FD-7 Wheel Bearing Kit	AM313020	\$ 85.00	
5000, 5100, 5110, 5200, 5600, 5610, 5640, 5700, 5900, 6410, 6600, 6610, 6640, 6700, 6710, 6810, 7000, 7100, 7200, 7410, 7600, 7610, 7710, 7740, 7810, 7840, 7910, 8210	Wheel Hub, 6-Bolt Requires AMC5NN1130A Threaded Hub Cap Use w/ WBK-FD-6 Wheel Bearing Kit Replaces C5NN1104F, C9NN1104B	AMC9NN1104D	\$ 53.50	
	Hub Cap, Threaded	AMC5NN1130A	\$ 4.00	
8530, 8630, 8730, 8830, TW5, TW10, TW15, TW20, TW25, TW30, TW35	Wheel Hub, 8-Bolt Standard Duty	AME1NN1104AA	\$ 190.00	

Wheel Bearing Kits

Application	Description	Part Number	Retail Price	Core
 2N (1939-47), 8N (1948-52), 9N, NAA (1953-54)	Wheel Bearing Kit	WBK-FD-1	\$ 27.00	
	Components:			
	Inner Cone	1 15118	\$ 8.00	
	Inner Cup	1 15250	\$ 4.75	
	Outer Cone	1 09074	\$ 3.20	
	Outer Cup	1 09196	\$ 5.00	
 (600, 700, 800, 900, 2000, 4000 1955-64) Note: measure spindle bearing size prior to ordering kit, same applications could use WBK-FD-3	Wheel Bearing Kit	WBK-FD-2	\$ 28.00	
	Components:			
	Inner Cone (1.25" ID, 0.75" Wide)	1 15123	\$ 6.00	
	Inner Cup (2.441" OD, 0.5625" Wide)	1 15245	\$ 4.00	
	Outer Cone (0.75" ID, 0.75" Wide)	1 09067	\$ 3.12	
	Outer Cup (1.938" OD, 0.5625" Wide)	1 09195	\$ 2.45	
 (600, 700, 800, 900, 2000, 4000 1955-64) Note: measure spindle bearing size prior to ordering kit, same applications could use WBK-FD-2	Wheel Bearing Kit	WBK-FD-3	\$ 26.00	
	Components:			
	Inner Cone (1.25" ID, 0.5937" Wide)	1 LM67048	\$ 7.00	
	Inner Cup (2.328" OD, 0.465" Wide)	1 LM67010	\$ 2.75	
	Outer Cone (0.75" ID, 0.655" Wide)	1 LM11949	\$ 2.99	
	Outer Cup (1.781" OD, 0.475" Wide)	1 LM11910	\$ 1.70	
 1830, 2310, 2610, 2830, 2910, 2930, 3610, 3910, 3930, 4000 (1965-75 Except Vineyard), 4100, 4110, 4130AP, 4130N, 4610N, 4610SU (1981 and Later), 4630	Wheel Bearing Kit	WBK-FD-5	\$ 26.00	
	Components:			
	Inner Cone	1 LM48548	\$ 6.00	
	Inner Cup	1 LM48510	\$ 4.00	
	Outer Cone	1 LM11949	\$ 2.99	
	Outer Cup	1 LM11910	\$ 1.70	
	Seal	1 AM310195	\$ 5.17	

Ford® / New Holland®—Tractor

Application	Description	Part Number	Retail Price	Core
 (2000, 3000 1965-75), (2600, 3600, 3900, 4100 1975-81), (2610, 3610, 3910, 4110 1981 and Later), Dexta, Super Dexta	Wheel Bearing Kit	WBK-FD-4	\$ 20.00	
	Components:			
	Inner Cone	1 LM67048	\$ 7.00	
	Inner Cup	1 LM67010	\$ 2.75	
	Outer Cone	1 LM11949	\$ 2.99	
	Outer Cup	1 LM11910	\$ 1.70	
	Seal	1 AP19060	\$ 3.00	
 (5000, 7000 - w/o 10.00x16 Tires, 1965-75), 5100, 5110, 5600, 5610, 5640, 5700, 5900, 6410, 6600, 6610, 6640, (6700, 6710, 7710 - w/ Lo- or Hi-Clearance), 6810, 7100 (Left Hand Only), 7600, 7610, 7700, 7740, 7840	Wheel Bearing Kit	WBK-FD-6	\$ 27.00	
	Components:			
	Inner Cone	1 LM501349	\$ 6.00	
	Inner Cup	1 LM501310	\$ 7.50	
	Outer Cone	1 M12649	\$ 4.50	
	Outer Cup	1 M12610	\$ 2.00	
	Seal	1 AP19195	\$ 5.35	
 (5000, 7000 - w/ 10x16 Tires, 1963-75), (8000, 8600, 8700, 9000, 9600, 9700, TW5, TW10, TW15, TW20, TW25 - w/ Standard Axle)	Wheel Bearing Kit	WBK-FD-7	\$ 40.00	
	Components:			
	Inner Cone	1 25590	\$ 11.00	
	Inner Cup	1 25521	\$ 7.50	
	Outer Cone	1 02474	\$ 13.00	
	Outer Cup	1 02420	\$ 5.85	

Steering Arms



Application	Description	Part Number	Retail Price	Core
(5000, 7000 6/66 and Later), 5600, 6600, 7600, 5610, 6610, 7610 - w/ Power Steering	Steering Arm	Center AMD6NN3N670A	\$ 75.00	
	Steering Arm	Right Hand AMC5NN3130A	\$ 55.00	
	Tie Rod attaches from bottom of steering arm	Left Hand AMC5NN3131A	\$ 55.00	
5700, 6700, 6710, 7700, 7710, 7810, 7910, 8210, 8700, 9700, TW10, TW20, TW30	Steering Arm, Left Hand 39 Spline	AMD5NN3131B	\$ 285.00	
Major, Super Major, Power Major	Steering Arm Replaces E1ADKN-3133C	AME1ADKN3133B	\$ 82.00	
(5000, 7000 Series), 5600, 5610, 6600, 6610, 7600, 7610	Center Steering Shaft 4.78" Long	AMC5NN3N703C	\$ 27.00	
	Steering Shaft Bushing, Upper 1.375" (35 mm) Diameter	Upper AMC5NN3179B	\$ 5.50	
	Steering Shaft Bushing, Lower 1" Tall, 1.625" OD	Lower AMC5NN3179A	\$ 5.00	
2N, 8N, 9N, 501, 531, 541, 600, 601, 611, 620, 621, 630, 631, 640, 641, 650, 651, 660, 661, 671, 681, 700, 701, 740, 741, 771, 800, 801, 811, 820, 821, 840, 841, 850, 851, 860, 861, 871, 881, 900, 901, 941, 950, 951, 960, 961, 971, 981, 2000, 2110, 2120, 2310, 2600, 2810, 2910, 3000, 3100, 3110, 3120, 3310, 3600, 3610, 3900, 3910, 4000, 4100, 4110, 4120, 4140, 4200, 4330, 4340, 4600SU, 4610SU	Dust Seal, Steering Arm	AMC5NN3125A	\$ 2.50	

Ford® / New Holland®—Tractor

Axle Center Tubes and Beams

Application	Description	Part Number	Retail Price	Core
2000, 2100, 2310, 2600, 2610, 2810, 2910, 3000, 3055, 3100, 3110, 3120, 3150, Ind: 231, 233, 234	Front Axle Assembly w/ Bushing	AMC7NN3010F	\$ 140.00	

Axle Knee Extensions

Application	Description	Part Number	Retail Price	Core
231, 233, 333, 531, 2000, 2100, 2110, 2120, 2150, 2300, 2310, 2600, 3000, 3055, 3100, 3110, 3120, 3150, 3300, 3310, 3330, 3600, 3900, 4000, 4110, 4140, 4600 - w/ 3 Cylinder Engine	Axle Knee Extension, Left Hand Replaces 81822704	AMC7NN3007J	\$ 130.00	
2000, 2100, 2110, 2120, 2150, 2310, 3000, 3055, 3100, 3110, 3120, 3150, 3310, 4000, 4110, 4140 - w/ 3 Cylinder Engine	Axle Knee Extension, Right Hand	AMC5NN3006G	\$ 160.00	

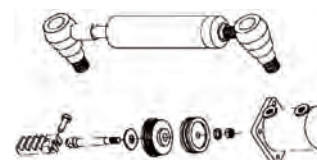

Power Steering Cylinders and Components

Application	Description	Part Number	Retail Price	Core
601, 801, 2000, 3000, 3600, 4600	Power Steering Cylinder Right or Left Hand, 5/8" Diameter Rod 7/16" Male Thread Reff# 81846467	AMD4NN3A540A	\$ 210.00	
601, 801, 2000, 3000, 3600, 4600, Ind/Utility: 230A, 231, 234, 355, 531	Power Steering Cylinder Right or Left Hand, 1/2" Diameter Rod 7/16" Male Thread	AME2NN3A540BA	\$ 266.50	
5610, 5610S, 5900, 6610, 6610S, 7610, 7610S, 7810, 7810S	Power Steering Cylinder	AME3NN3A540BA	\$ 285.00	
5640, 6640, 66400, 7740, 77400, 7840, 78400, TS90, TS100, TS100A, TS110, TS115A	Power Steering Cylinder Replaces 8865697, 81864108, 82037177	AM81869701	\$ 366.00	
7530	Power Steering Cylinder Replaces 5140638, 5143022, 5189897	AM5113130	\$ 232.00	
8670, 8770, 8870, 8970 Standard Steer	Power Steering Cylinder Right and Left Hand Reff# 8501599	AM86508658	\$ 475.00	
T8010, T8020, T8030, T8040, T8050, TG210, TG215, TG230, TG245	Power Steering Cylinder, Right Hand For 10-Bolt Hub	AM87455637	\$ 730.00	
	Power Steering Cylinder, Left Hand For 10-Bolt Hub	AM87455636	\$ 700.00	
T8010, T8020, T8030, T8040, T8050, TG210, TG215, TG230, TG245, TG255, TG275, TG285, TG305 - w/ Super Steer Axle	Power Steering Cylinder, Right Hand Replaces 87455625	AM87455620	\$ 1200.00	
	Power Steering Cylinder, Left Hand Replaces 87421635, 87455621	AM87455619	\$ 1200.00	
T8010, T8020, T8040, T8050, TG210, TG230, TG245, TG255, TG275, TG285, TG305	Power Steering Cylinder, Right Hand For 12-Bolt Axle	AM87455648	\$ 1995.00	
	Power Steering Cylinder, Left Hand For 12-Bolt Axle	AM87455647	\$ 1995.00	
	Seal Kit Use w/ AM87455647 or AM87455648 Power Steering Cylinder	AM87455632	\$ 180.00	
T8.300, T8.320, T8.330, T8.350, T8.360, T8.380, T8.390, T8.410, T8.420, T8.435 - w/ Class 5 Axles	Power Steering Cylinder	AM84336641	\$ 380.00	
TG210, TG230 - w/ 10-Bolt Hubs w/ SupersSeer™ Axle	Power Steering Cylinder MFWD, Right or Left Hand	AM87404328	\$ 475.00	

Ford® / New Holland®—Tractor

Application	Description	Part Number	Retail Price	Core
TG210, TG230, TG255, TG285 - w/ 12-Bolt Hub w/o SuperSteer™ Axle	Power Steering Cylinder DANA® MFWD, Right or Left Hand Ref# 293678A2, 87455650	AM293678A2	\$ 585.00	
TM115, TM120, TM125, TM130, TM135, TM140, TM150, TM155, TM165, TM175, TM190 - w/ MFWD	Power Steering Cylinder Replaces 5164022, 82991196	AM87302891	\$ 304.00	
Ind: (535, 545, 555 Early), 4500 - w/ HD Axles	Power Steering Cylinder, HD Right or Left Hand, 0.75" Diameter Rod	AMD8NN3A540AB	\$ 326.39	
601, 801, 2000, 3000, 3600, 4600, Ind/Utility: 230A, 231, 234, 335, 531	Power Steering Cylinder End 7/16" 20 Female Thread, 2.75" Long Use w/ AME2NN3A540BA Cylinder	AMC5NN3A302B	\$ 13.00	
5100, 5600, 5610, 5900, 6410, 6600, 6610, 6710, 6810, 7100, 7600, 7610, 7810, 8010	Power Steering Cylinder End 3.625" Long, 0.875" Diameter Internal 14 Thread	AME3NN3B539AA	\$ 23.00	
5640, 6640, 7740, 7840, TS100, TS110, TS90	Power Steering Cylinder End 2.875" Long, 1.25" Diameter 12 Right Hand Thread	AM81864115	\$ 35.00	
5700, 6700, 6710, 7700, 7710, 8000, 8700, 9700, TW10, TW20, TW30	Power Steering Cylinder End 3.75" Long, 0.875" Diameter 18 Thread	AMD8NN3B539AB	\$ 58.00	
5700, 6700, 6710, 7700, 7710, 7810, 7910, 8000, 8210, 8530, 8630, 8700, 8730, 8830, 9000, 9700, TW5, TW15, TW25, TW30, TW35	Power Steering Cylinder End 3.75" Long, 1.00" Diameter 16 Right Hand Thread	AME6NN3N981AA	\$ 60.00	
(T8010, T8020, T8030, T8040, T8050, TG210, TG215, TG230, TG245, TG255, TG275, TG285, TG305 - w/ 12 Bolt Hubs w/ SuperSteer™ Axle)	Power Steering Cylinder End 4" Long, 0.89" Thread Length M22x1.50" Right Hand Thread 1.25"x12 UNF Right Hand Thread Replaces 87421641, 87455618	AM47381302	\$ 159.79	
For Aftermarket Power Steering Cylinders that Replace OEM E2NN3A540BA, D4NN3A540A, C5NN3A739B	Power Steering Cylinder End 2.125" Long, 0.687", 18 Thread Not used on OEM Power Steering Cylinders	AME2NN3A540BJ	\$ 20.00	
Ind: (535, 545, 555 Early), 4500 - w/ HD Axles	Power Steering Cylinder End Female Thread, Use w/ AMD8NN3A540AB Cylinder	AMD8NN3A540BJF	\$ 17.00	
For C5NN3A739B OEM Power Steering Cylinder	Power Steering Ball Joint Female Thread	AMCAPN3300A	\$ 20.00	
5640, 6640, 7740, 7840, 8210, 8240, 8340, Backhoe-Loaders: 555E, 575E, 655E, 675E	Power Steering Ball Joint 8.21" Long M22x1.50" and M24x1.50" Right Hand Thread Replaces 247522A1, 83957792, N14377	AM9968018	\$ 75.00	
Ind: (535, 545, 555 Early), 4500 - w/ HD Axles	Power Steering Ball Joint Male Thread	AMD8NN3A540BJM	\$ 13.00	
(T8010, T8020, T8030, T8040, T8050 - w/ 10-Bolt or 12-Bolt Hubs), (T8.275, T8.330, T8.360 - w/ 12-Bolt Hubs All w/ or w/o CVT models w/ DANA® Axle w/o Differential Lock), (T8.390 w/o CVT, (TG210, TG215, TG230, TG245, (TG275, TG285 - w/ Differential Lock) - w/ 10-Bolt Hubs), (TG210, TG230 - w/ 12-Bolt Hubs All w/ Differential Lock or ASN MY00184591 w/o Differential Lock), (TG215, TG245 - w/ 12-Bolt Hubs w/ Differential Lock), (TG255, TG275, TG285 - w/ 12-Bolt Hubs), (TG255, TG285 - w/ 10-Bolt Hubs All w/o Differential Lock or ASN MY00195879 w/ Differential Lock)	Power Steering Cylinder Pin	AM292565A1	\$ 135.00	
3230, 3430, 3930, 4130, 4630, 4830, 5030, (5110, 5610, 6610, 7610, 7710, 7810, 7910 - 02/1987 and Later), 5610S, 6610S, 6810, 7010 ASN 850001M, 7610S, 8010 ASN 800001M, TB80, TB85, TB90, TB100, TB110, TB120 - w/ MFWD	Power Steering Cylinder Seal Kit Axle Reference # - 124961, 149749 Replaces CAR49101	AM83957762	\$ 61.92	
(4030, 4230, 4430, TM115, TM125, TM135 ASN D4628 w/ 4WD Front Axle), (TD55D, TD60D, TD70D, TD85D ASN D5665 w/ 4WD Front Axle), (TD75D, TD80D, TD90D, TD95D, TD5010, TD5020, TD5030, TD5040, TD5050, TM120, TM130, TM140, TS100A, TS110A, TS115A, TS125A, TS130A, TS135A - 4WD Front Axle), TL70 ASN 1198664 w/ 4WD Front Axle	Power Steering Cylinder Seal Kit Use w/ 5098111, 5189887, 5189887R, 5189888 Steering Cylinders	AM5190591	\$ 29.58	

Prices Subject to Change without Prior Notice. The use of original equipment manufacturer (OEM) part numbers or trademarks, e.g. Case® and John Deere®, are for reference purposes only and for indicating product use and compatibility. Our company and the listed replacement parts contained herein are not sponsored, approved or manufactured by the OEM. All parts are New unless designated Reman in the description.

Ford® / New Holland®—Tractor

Remote Valves

Application	Description	Part Number	Retail Price	Core
T6010, T6020, T6030, T6040, T6050, T6060, T6070, T6080, T6090, TS100A, TS115A, TS125A, TS135A	Remote Valve	AM84125295	\$ 2600.00	
2000, 2100, 2110, 2120, 2150, 2300, 2310, 2600, 2610, 2810, 2910, 3000, 3055, 3100, 3110, 3120, 3150, 3230, 3300, 3310, 3330, 3400, 3430, 3500, 3550, 3600, 3610, 3900, 3910, 3930, 4000, 4100, 4110, 4130, 4140, 4200, 4330, 4340, 4400, 4410, 4500, 4600, 4610, 4630, 4830, 5000, 5030, 5100, 5200, 5340, 7000, 7100, 7200	Hydraulic Selector Valve Replaces C5NN0960D, E0NND960AA	AMC5NND960C	\$ 175.00	
T8010, T8020, T8030, T8040, T8050, T9020, T9030, T9040, T9050, T9060, TG210, TG215, TG230, TG245, TG255, TG275, TG285, TG305, TJ275, TJ280, TJ325, TJ330, TJ375, TJ380, TJ425, TJ430, TJ450, TJ480, TJ500, TJ530	Internal Female Coupler Kit Recommended to purchase in quantities of two (pressure and return) Genuine OEM Coupler includes HA345193 O-Ring and Seal Kit Replaces 93328C1, 275182A1, 87776294	AM84262367	\$ 160.00	
T5.105, T5.115, T6.140, T6.150, T6.155, T6.160, T6.175, T7.210, T7.260, T7.270, TS6.110, TS6.120, TS6.125, TS6.140	Hydraulic Remote Valve Coupling M22x1.50" Male Thread Quick Release	AM47370116	\$ 74.80	

Hydraulic Oil Coolers

Application	Description	Part Number	Retail Price	Core
(2600, 3600, 4600, 5600, 6600, 7000, 7600 - w/o Cab), (7100, 7200 - w/ Dual Power), Ind: (231, 233, 333, 335, 531, 532 - w/o Cab)	Hydraulic Oil Cooler	AMD3NNH860A	\$ 316.00	
5110, 5610, 6610, 6610O, 6710, 6810, 7410, 7610, 7610O, 7710	Hydraulic Oil Cooler, Power Steering Core: 3" x 5 1/2" x 1"	AM83954673	\$ 360.00	
T2310, T2320, TC40DA, TC45DA	Hydraulic Oil Cooler Core: 15" x 16" x 1 1/8"	AM87344149	\$ 285.00	
T9010, T9020, (T9030, T9040 ASN Z6F200013), TJ275, TJ280, TJ325, TJ330, TJ375, TJ380, TJ425, TJ430, TJ450, TJ500	Hydraulic Oil Cooler Core: 36" x 29" x 2 1/2" Replaces 345228A1, 361082A1	AM87312759	\$ 1007.00	
T9.615, T9.670	Hydraulic Oil Cooler Core: 24.60" x 19.50" x 4" Transmission Oil Cooler Core: 19.50" x 24.60" x 4"	AM84252569 AM84210954	\$ 1286.00 \$ 1250.00	
(2310, 2610, 2810, 2910, 3610, 3910, 4610 - w/ Transmission Cooler), (2600, 3230, 3430, 3600, 3930, 4130, 4600, 4630, 4830, 5030, 5600, 6600, 7600 - w/ Hydraulic Cooler)	Hydraulic Cooler/Transmission Oil Cooler Replaces 83902919	AMD4NNH860A	\$ 105.00	
8670, 8670A, 8770, 8770A, 8870, 8870A, 8970, 8970A	Charge Oil Cooler Core: 30 1/4" x 21.00" x 2 5/8" Replaces 9860029, 89821609, 89860029	AM86011668	\$ 1210.00	



Hydraulic Pumps

Application	Description	Part Number	Retail Price	Core
2N, 8N, 9N	Hydraulic Pump Rebuild Kit Replaces PTO shaft bushing, PTO shaft gasket, base gasket, safety valve, sump plug gasket, side gasket, piston, side plate gasket, cam block and includes chamber repair kit	AMX47114	\$ 258.00	
775 1/95-10/95, (5640, 6640O, 7740, 7740O, 7840, 8240, 8340 11/91 and Later), 7840O 2/93 and Later	Hydraulic Pump - Engine Mount Auxiliary Pump	AMF0NN600AA	\$ 365.00	

Ford® / New Holland®—Tractor

Application	Description	Part Number	Retail Price	Core
1120, 1215, 1220, 1320, 1520, 1530, 1620, 1630, 1715, 1720, 1725, 1920, 1925, 2120, 3415, TC27D, TC27DA	Hydraulic Pump Replaces SBA340450490	AMSBA340450491	\$ 675.00	
1920, 2120, 3415, T1530, T2310, T2320, T2330, TC35, TC40, TC45	Hydraulic Pump	AMSBA340450991	\$ 675.00	
2310, 2600, 2600N, 2600R, 2600V, 2610, 3600, 3600N, 3600NO, 3600R, 3600V, 3610, 4100, (4110NO, 4110O, 4110V - Prior to 04/1983), 5610, 6610, 6710, 7610, 7710, 7910, 8210, TW5, TW15, TW25, TW35, Ind/Utility: 233	Hydraulic Pump - Engine Mount (Optional) Uses a spin-on oil filter	AME1NN600AB	\$ 350.00	
(2910, 3910, 4110, 4610 4/83 and Later), 4610O, 4610SU	Hydraulic Pump - Engine Mount (Optional)	AME2NN600AB	\$ 365.00	
3010S, 4010S, 4030, 4230, 4430, TD80D Standard Model, TD85F, TD95DHC Plus, TT55, TT65, TT75, Crawlers: TK75F, TK75FA, TK75M, TK75MA, TK75V, TK75VA	Hydraulic Pump 14.35 cc, 10.80 GPM Replaces 1909915, 1909919, 1930068, 5086286, 5094391, 5113284, 5120849, 5129483, 5169772, 5179719, 8280127, 9967928, 84467651, 85086286, 87325370, 87721169, 87737603, 153634445, 320446000	AM84530156	\$ 195.00	
3010S, 4010S, 5010S, TD60D, TD70D, TD75D, TD80D, TD90D, TD90F, TD95, (TT55, TT65, TT75 ASN T00352M), Crawlers: TK76, TK76M, TK80A, TK80MA, TK85, TK85M	Hydraulic Pump - Engine Mount 19.33 cc, 10.80 GPM Replaces 2040333, 5093658, 5094394, 5169770, 5179414, 5179711, 5179714, 9967782, 47562399, 82987745, 87716629, 87737605	AM84530154	\$ 125.00	
3230, 3400, 3430, 3550, 3930, 4100, 4110, 4400, 4410, 4500, 4600, 4610, 4630, Ind: 340, 345C, 345D, 420, 515, 535, 540, 545	Hydraulic Pump - Transmission Mount Does not use a spin-on oil filter	AMD8NN600LB	\$ 295.00	
4000 1965 and Later), Ind: 3550	Hydraulic Pump - Transmission Mount	AMD0NN600F	\$ 565.00	
4835, TL70	Hydraulic Pump Replaces 5129486, 5169039	AM5179728	\$ 110.00	
5000, 5100, 5200, 7000, 7100, 7200 1965-75	Hydraulic Pump - Transmission Mount	AMD0NN600G	\$ 295.00	
5100, 5200, 7100, 7200	Hydraulic Pump - Transmission Mount 20 GPM	AMD2NN600B	\$ 425.00	
5100, 5600, 5610, 6600, 6610, 6700, 6710, 7100, 7600, 7610, 7700, 7710, 7910, 8210	Hydraulic Pump - Transmission Mount Uses a spin-on oil filter	AME0NN600AC	\$ 489.50	
5600, 5700, 6600, 6700, 7600, 7700	Hydraulic Pump - Transmission Mount	AMD8NN600KB	\$ 450.50	
5640, 6640, 7740, 7840, 8240, 8340, TS100, TS110, TS90	Hydraulic Pump - Transmission Mount Tandem Gear Pump	AMF0NN600BB	\$ 717.50	
5640, 6640, 7740, 7840, TS90, TS100, TS110, TS115	Hydraulic Pump - Transmission Mount Replaces 25917715, F0NN600CE, VPK1109	AM82850804	\$ 3950.00	
8000, 8600, 8700, 9000, 9600, 9700 1968-78	Hydraulic Pump - Transmission Mount 16 GPM	AMD5NN600C	\$ 548.00	
8430, 8530, 8630, 8830, TW30, TW35	Hydraulic Pump - Transmission Mount 20 GPM	AME2NN600BA	\$ 295.00	
8670, 8670A, 8770, 8770A, 8870, 8870A, 8970, 8970A	Hydraulic Pump	AM86018162	\$ 1263.50	
(T6010, T6020, T6030, T6040, T6050, T6060, T6070 - Prior to 12/2009), T7030, T7040, T7050, T7060, TM175, TM190, (TS100A, TS115A - Plus/ Deluxe Only), TS125A, TS135A	Hydraulic Pump Used in 45 cc pumps, 113 Liters per Minute Replaces 47127050, 87725827	AM5198694	\$ 2575.00	

Ford® / New Holland®—Tractor

Application	Description	Part Number	Retail Price	Core
T6030, T6040, T6060, T6070, T6080, T6090, T6.120, T6.125, T7.165, T7.175, T7.185, T7.210, T7.225 (MY15 and Later), (T6050, T7.170 - Power Command™ and Range Command™), (T6.140, T6.150, T7.200 - Excluding Auto Command™), (T6.145, T6.180 - Tier 4B 03/2015-01/18, Tier 4B MY18 and Electro Command™), (T6.155, T6.165, T6.175 - Tier 4, Tier 4B 03/2015-01/18, Tier 4B MY18 and Electro Command™), (T6.160 Tier 4, Tier 4B MY18 and Electro Command™), (T7.190 - Excluding Auto Command™ MY15)	Hydraulic Pump 45 cc, 29.80 GPM Replaces 8416091	AM84471387	\$ 2151.75	
T7030, T7040, T7050, T7060, T7.220, T7.230, T7.235, T7.245, T7.250, T7.260, T7.270	Hydraulic Pump	AM84471388	\$ 2040.00	
T9010, T9020, T9030, T9040, T9050, T9060, TJ275, TJ280, TJ330, TJ375, TJ380, TJ425, TJ430, TJ450, TJ480, TJ500, TJ530	Reman Hydraulic Pump	AM432244A3	\$ 850.00	\$ 500.00
TL70, TL80, TL90, TL100, TN55, TN55D, TN55S, TN60A, TN60SA, TN65, TN65D, TN65F, TN65S, TN70, TN70A, TN70D, TN70F, TN75, TN75A, TN75D, TN75F, TN75FA, TN75S, TN80F, TN85FA, TN85SA, TN90F, TN95F, TN95FA	Hydraulic Pump	AM5168841	\$ 445.20	
(T5.110, T5.120 - Except Dual Command™), (T5.95, T5.105, T5.115 - w/ Standard Tier 4 Engine 03/10/2013 and Later and Electro Command™ Tier 4 Engine 06/17/2014 and Later)	Hydraulic Pump	AM47456761	\$ 1050.00	
T8.275, T8.300, T8.320, T8.330, T8.350, T8.360, T8.380, (T8.380, T8.410, T8.435 - SmartTrax™), T8.390, T8.410, T8.420, T8.435	Hydraulic Pump 85 cc, 55.60 GPM, High Capacity	AM47473854	\$ 1683.40	
T8.275, T8.300, T8.320, T8.330, T8.350, T8.360, T8.380, (T8.380, T8.410, T8.435 - SmartTrax™), T8.390, T8.410, T8.435	Hydraulic Pump 63 cc, 41.30 GPM, Standard Capacity Replaces 87538166	AM87538174	\$ 1822.10	
T9.390, T9.615, T9.670, (T9.435, T9.480, T9.530, T9.565, T9.600, T9.645, T9.700 - Optional Equipment on MY17), (T9.435 HD, T9.450, T9.480 HD, T9.505, T9.530 HD, T9.560, T9.565 HD, T9.600 HD, T9.645 HD, T9.700 HD - Optional Equipment)	Hydraulic Pump 85 cc Mega Flow Pump Replaces 84178463	AM47764642	\$ 1731.85	
T9.615, T9.670	Hydraulic Pump Replaces 84194336	AM47528844	\$ 1744.02	
(TW5, TW10, TW20 1979-82), TW15, TW25	Hydraulic Pump - Transmission Mount 16 GPM	AMD8NN600FA	\$ 515.00	
2N, 8N, 9N	Hydraulic Pump Shaft 6 Spline, 13" Long, 3/4" Diameter	AM194354	\$ 24.00	
2N, 8N, 9N	Hydraulic Pump Drive Shaft 13.06" Long, 0.75" Diameter 5/8" Right Hand Thread	AM190760	\$ 31.85	
2N, 8N, 9N	Hydraulic Pump Drive Shaft 10 Spline, 3/8" Long	AM195454	\$ 37.00	
2N, 8N, 9N	Hydraulic Pump Drive Hub 3" Diameter 18 UNF Left Hand Thread	AM191196	\$ 47.00	
4030, 4230, 4430, TN55, TN60A, TN60DA, TN60SA, TN65, TN65D, TN65F, TN65S, TN70, TN70A, TN70D, TN70DA, TN70F, TN70S, TN70SA, TN75, TN75A, TN75DA, TN75F, TN75FA, TN75S, TN75SA, TN80F, TN85FA, TN90F, TN95F, TN95FA	Hydraulic Steering Pump Replaces 569306, 1901323, 1930058, 5088381, 5120406, 5129478, 5179730, 44900783, 87326060, 98420895, 153630659, 153634396, 153634432	AM5179729	\$ 125.00	
5635, 6635, 7635, 8160, 8260, 8360, 8560, TL80, TL90, TL100, TM115, TM120, TM125	Hydraulic Lift Pump 19.33 cc Replaces 5129493, 5143768, 5169041, 5179726	AM84530167	\$ 220.00	

Ford® / New Holland®—Tractor

Application	Description	Part Number	Retail Price	Core
TD60D, TD70D, TD75D, TD80D, TD90D, TD95D Upgrade Model	Hydraulic Lift Pump 11.26 cc Replaces 1901322, 1930061, 5085685, 5088382, 5094395, 5094396, 5129481, 5143767, 5179722, 8273385, 8273973, 9967929, 84467650, 87325369, 87725756, 153633457	AM84530166	\$ 195.00	
TJ425, TJ450, TJ500	Hydraulic Fan Drive Pump 100 cc	AM413152A1	\$ 1927.55	
T9.600, T9.645, T9.700	Hydraulic Fan Drive Pump Replaces 84194336	AM47528844	\$ 1744.02	



Power Steering Pumps and Conversion Kits

Application	Description	Part Number	Retail Price	Core
455C, 555C, 575D, 655C	Power Steering Pump Replaces E9NN3K514BA, E9NN3K514BB	AM81871798	\$ 600.00	
2110, 2600, 3600, 4100, 4100SU, 4500, 4600, 5100, 5600, 6600, 7100, 7600, Ind/Utility: 231, 233, 420, 3500, 3550	Power Steering Pump, Reservoir Style 2.74 GPM at 1100 PSI	AME6NN3K514EA	\$ 231.50	
3230, 3430, 3930, 3930H, 3930N, 3930NO, 4130, 4130N, 4130NO, 4630, 4630O, 4830, 5030 Prior to 05/1993	Power Steering Pump w/ Flat Face Fittings	AME8NN3K514BA	\$ 506.00	
4100, 4600, 4610, 4630, 5100, 5600, 6610, 7100, 7600, 7610	Power Steering Pump, Reservoir Style Used with flare fittings	AME6NN3K514PA99	\$ 265.00	
4200, 5200, 7200	Power Steering Pump, Non-Reservoir Style 3.50 GPM at 1100 PSI Replaces 81851286	AMC7NN3A674G	\$ 750.00	
4610V 4/88-4/89, 5610, 5900, 6610, 6610O	Power Steering Pump, Reservoir Style	AME6NN3K514AB	\$ 308.50	
6710, 7710, 7910, 8210	Power Steering Pump, Reservoir Style	AME6NN3K514TA	\$ 685.00	
8000, 8600, 9000, 9600	Power Steering Pump, Reservoir Style	AMD6NN3K514B	\$ 920.00	
8000, 8600, 8700, 9000, 9600, 9700 1968-2/73	Power Steering Pump, Non-Reservoir Style 4.20 GPM at 1500 PSI	AMC7NN3A674B	\$ 543.50	
8530, 8630, 8730, 8830, TW30, TW35	Power Steering Pump Replaces 3924997, 83924997, D8NN3K514JD	AMD8NN3K514JC	\$ 434.00	
8700, 9700, TW5, TW10, TW15, TW20, TW25	Power Steering Pump, Reservoir Style	AME0NN3K514AB	\$ 474.00	
8730, 8740, 9700 8/1978 and Later, TW30, TW35	Power Steering Pump, Reservoir Style	AMD8NN3K514JD	\$ 550.00	
Ind/Const: 445, 445A, 445C, 445D, 450, 545, 545A, 545C, 545D, 550, 555, 555A, 555B, 655, 655A	Power Steering Pump, Reservoir Style Flows 2.74 GPM at 1600 PSI, 1000 RPM 5/8" Port Diameter	AME7NN3K514CA	\$ 439.00	
Ind: 4000, 4500	Power Steering Pump, Reservoir Style Flows 2.74 GPM at 1250 PSI, 1000 RPM Replaces 83928652, D8NN3K514KB, D8NN3K514KC	AMD8NN3K514C	\$ 867.50	
2000, 3000, 3600, 3610 - w/ 3 Cylinder Engines	Power Steering Conversion Kit Kit includes oil reservoir, hydraulic steering pump, cylinder bracket, steering cylinder & valve, tie rod and hoses	AMX47103	\$ 680.00	
5000 Series w/ 4 Cylinder Engines, 5600, 6600, 6610	Power Steering Conversion Kit Kit includes oil reservoir, hydraulic steering pump, cylinder bracket, steering cylinder, drag link, 5/8" hose clamp, 5/16" pressure hose and 3/8" return hose	AMX47102	\$ 535.00	

Ford® / New Holland®—Tractor



Power Steering Orbit Motors



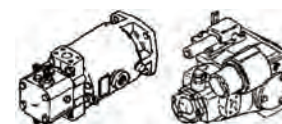

Application	Description	Part Number	Retail Price	Core
500, 555, (700, 755, 800, 825, 850, 900, 950 - All Series II)	Power Steering Orbit Motor 5-Line, Ross Style Pump	AMV53616	\$ 1795.00	
756, 836, 846, 856, 876	Power Steering Orbit Motor 4-Line, Char-Lynn Style Pump	AMV90159	\$ 2050.00	
835, 855, 875, 895, 945, 950, 955, 975	Power Steering Orbit Motor 4-Line, Ross Style Pump	AMV72318	\$ 1950.00	
5110, 5610, 5610S, 5900, 6410, 6610, 6610O, 6610S, 6810, 6810S, 7610, 7610O, 7700, 7710, 7810, 7810S	Power Steering Orbit Motor w/ Relief Valve Replaces 83948972, 86602590, E4NN3A244AA	AM86602557	\$ 574.00	
8000, 8700, 9000, 9700, TW10, TW20, TW30	Power Steering Orbital Motor Roll-Pin Style Replaces 81875266, E3NN3A244CB	AM86585453	\$ 995.00	
(3230, 3430, 3930, 4130, 4630, 4830, 5030, 7010, 8010 - 10/1996 and Later), 5640, 6640, 7740, 7840, 8240, 8340, TD80D, TD90D, TD95D, TD5030, TD5050, TL70, TL80, TL80A, TL90, TL90A, TL100, TL100A, TS90, TS100, TS100A, TS110, TS110A, TS115, TS115A, TS130A, TT55, TT65, TT75, Ind: (345D, 445D, 545D ASN A442030)	Orbital Steering Motor Seal Kit Replaces 82010262	AM9966147	\$ 84.63	

Hydrostats and Components













Application	Description	Part Number	Retail Price	Core
276 Versatile® Bi-Directional	Reman Hydrostat 2-Piece Eaton Hydrostat	H276E-46/46	\$ 3550.00	\$ 500.00











Transmission Components

Application	Description	Part Number	Retail Price	Core
 231, 335, 340, 445, 531, 540, 2000, 2310, 2600, 2610, 2810, 2910, 3000, 3400, 3500, 3600, 3610, 3910, 4000, 4000SU, 4500, 4600SU, 4610	Shift Cover w/ Levers Replaces 82004680	AMC5NN7211F	\$ 60.00	
(2000, 2100, 2110, 2120, 2150, 2300, 2310, 2600, 3000, 3055, 3100, 3110, 3120, 3150, 3190, 3300, 3310, 3330, 3400, 3500, 3550, 3600, 3900, 4000, 4100, 4110, 4140, 4200, 4330, 4340, 4400, 4410, 4500, 4600 - w/ 3 Cylinder Engine), Ind/Const: 231, 233, 333, 335, 420, 515, 531, 532, 533	Shift Lever 13 1/4" Long	AMC7NN7210AD	\$ 25.00	
 8N 1948-52	Countershaft	AM8N7111	\$ 165.00	
 8N, 600, 800, 900, 2000, 4000, NAA	2nd Mainshaft Gear	AMB9NN7A381B	\$ 121.00	
 2000, 2310, 2600, 2610, 3000, 3600, 3610, 3910, 4000, 4110, 4600, 4610	Main Drive Bearing Retainer Fits Models with Transmission Drive PTO or w/o PTO	AMC5NN7050A	\$ 90.00	
 2000, 2600, 2810, 2910, 3000, 3600, 3910, 4000, 4110, 4600, 4610	PTO Input Shaft w/ IPTO	AMD1NN772B	\$ 281.83	



Ford® / New Holland®—Tractor

	Application	Description	Part Number	Retail Price	Core
	5000 Series, 5600, 5700, 6600, 6700, 7000 Series, 7600, 7700	Main Input Shaft 19.125" Long, 25 Splines Fits Models w/o Dual Power Transmissions	AMC5NN7017A	\$ 100.00	
	5610, 5900, 6610, 6710, 7610, 7710 - 1/81-4/84	Main Input Shaft 19.22" Long, 20 Tooth, 10 Splines Fits Models w/ 8 Speed Transmissions w/o Dual Power	AME0NN7017HA	\$ 74.00	
	5110, 5610, 5610S, 5640, 6610, 6610O, 6610S, 6640, 6640O, 6710, 6810, 7010, 7610, 7610O, 7610S, 7710, 7740, 7740O, 7910, 7810S, 7840, 7840O, 8010, 8240, TB100, TB110, TB120, TS90, TS100, TS110	Main Input Shaft 19.22" Long, 20 Tooth, 10 Splines Fits 5/1984 and Later Models w/ 8X2 Transmissions w/o Dual Power, Non-Synchro	AME2NN7017EA	\$ 195.00	
	2000, 3000, 4000 Series, 2310, 2600, 2610, 3600, 3610	Rear Mainshaft 30 Tooth, 17/28 Splines	AMC5NN7C095D	\$ 288.32	
	Early 5000, 7000 Series	Mainshaft 30/16 Tooth	AMC5NN7C094A	\$ 320.78	
	(5000 Series, 7000 Series w/ 7 & 8 Speed Transmission, 1968 and Later), (5600, 5700, 6600, 6700 w/ IPTO), (5610, 6610, 6710 - 1/81-4/84)	Mainshaft 9.937" Long, 30 Tooth, 18/16 Splines Fits Models w/o Dual Power	AMC9NN7C094B	\$ 275.66	
	2000, 3000, 4000 Series, 2310, 2600, 2610, 3610	Countershaft 28 Tooth, 23 ID Splines, 26 Splines Fits Models w/ Transmission Drive PTO	AMC5NN7111M	\$ 140.00	
	5610, 6610, 7610, 7710 - Prior to 1984	Countershaft 11.75" Long, 28/30 Tooth, 20/17 Splines Fits Models w/o Dual Power, w/ 8 Speed Non-Synchro Transmission	AMC9NN7111B	\$ 69.00	
	2000, 3000, 4000 Series, 2310, 2600, 2610, 3610	Countershaft Gear 30/56 Tooth Fits Models w/ 8 Speed Trans	AMC5NN7113D	\$ 175.00	
	2000, 3000, 4000 Series, 2110, 2120, 2300, 2310, 2600, 2610, 2810, 2910, 3110, 3120, 3190, 3230, 3310, 3330, 3400, 3430, 3600, 3610, 3910, 3930, 4100, 4110, 4130, 4140, 4190, 4200, 4330, 4340, 4400, 4410, 4600, 4610, 4830, 5000 Series, 5100, 5110, 5190, 5200, 5340, 5600, 5610, 5640, 5700, 6600, 6610, 6640, 6700, 6710, 6810, 7000 Series, 7010 ASN 850001M, 7100, 7200, 7600, 7610, 7700, 7710, 7740, 7810, 7840, 8010 ASN 800001M, 8240, TS90, TS100, TS110	Output Gear Assembly 28/49 Tooth Fits most 3, 4 and 6 Cylinder Tractors w/ 7 or 8 Speed Transmissions	AME6NN7145AA	\$ 350.00	
	(3000, 4000 Series w/ 8 Speed Transmission 1/65-9/65), (5000, 7000 Series w/ 7 Speed Transmission 1/65-3/68 or 8 Speed Transmission 1/65-9/65)	1st Gear 49/28 Tooth	AMC5NN7N100A	\$ 95.00	

Ford® / New Holland®—Tractor

Application	Description	Part Number	Retail Price	Core
 (230A, 231, 233, 234, 250C, 260C, 333, 334, 335, 340, 340A, 340B, 345D, 445, 445A, 445D, 2000 Series, 2100, 2110, 2120, 2300, 2310, 2600, 2610, 2810, 2910, 3000 Series, 3100, 3110, 3120, 3190, 3230, 3300, 3310, 3400, 3430, 3600, 3610, 3910, 3930, 4000 Series, 4100, 4110, 4130, 4140, 4190, 4200, 4330, 4340, 4400, 4410, 4500, 4600, 4610, 4630 - 09/1965 and Later w/ 3 Cylinder Engine and 8-Speed Transmission), (515, 530A, 531, 532, 540, 540A, 540B, 545, 545A, 545D, 4830, 5000 Series, 5030, 5100, 5110, 5190, 5200, 5340, 5600, 5610, 5700, 6600, 6610, 6700, 6710, 6810, 7000 Series, 7100, 7200, 7600, 7610, 7700 - 09/1965 and Later w/ 4 Cylinder Engine and 7-Speed or 8-Speed Transmission), Ind: (3500, 3550 - 09/1965 and Later w/ 3 Cylinder Engine and 8-Speed Transmission)	1st Gear 46/28 Tooth Replaces C5NN7N100C	AME6NN7N100AA	\$ 187.34	
 2000, 2310, 2610, 3000, 3600, 3610, 4000	2nd Gear 28/43 Tooth Replaces C5NN7102A	AMC5NN7102F	\$ 185.00	
 (2810, 2910, 3910, 4110, 4610 - w/ Non-Synchro Transmission 1981-02/89), 4100, 4600, (5000, 5100, 5200, 5340, 7000, 7100, 7200 - 1973 and Later w/ Independent PTO w/ Dual Power), (5110, 5610, 6610, 6710, 6810, 7610, 7710, 7810 - w/ Non-Synchro Transmission), 5600, 5640, 5700, 6600, 6700, 7010 ASN 850001M, (7600, 7700 - w/ Independent PTO w/ or w/o Dual Power), 7740, 7840, 8010 ASN 800001M, 8240, TB100, TB110, TB120, TS90, TS100, TS110, Ind/Const: 340, (340A, 445 - 1982-05/85), (340B, 540A - 1982 and Later), 420, 445A, 515, 532, 540, (540B, 545A - 06/1985-07/87), 545	2nd Gear 28/43 Tooth w/ 8 Speed Transmission	AME6NN7N101BA	\$ 95.00	
 2000, 2310, 2600, 2610, 3000, 3600, 3610, 4000	3rd Gear 28/35 Tooth	AMC5NN7B340A	\$ 105.00	
 4000 Series, 4100, 4140, 4190, 4200, 4330, 4340, 4400, 4410, 4500, 5000 Series, 5100, 5110 (w/ Dual Power), 5190, 5200, 5340, 5600, 5610, 5700, 6600, 6610, 6700, 6710, 6810	3rd Gear 28/35 Tooth w/ 7 or 8 Speed Transmissions	AME6NN7N315AA	\$ 137.30	
 3000, 3600	Reverse Gear 28/32 Tooth	AMC5NN7K013E	\$ 80.00	
 5000 Series, 5610, 5900, 6600, 6610, 6710, 7610, 7710	Secondary Countershaft 35 Tooth, 16 Splines Fits Models w/ 8 Speed Non-Synchro Transmissions	AMC9NN7113B	\$ 185.00	
 2000, 3000, 4000 Series, 2310, 2600, 2610, 2810, 2910, 3230, 3600, 3610, 3910, 3930, 4600, 4610, 4630, 4830, 5000 Series, 5600, 5610, 5640, 5700, 6600, 6610, 6640, 6700, 6710, 7000 Series, 7600, 7610, 7700, 7710, 7810, 7740, 8240, TS90, TS100, TS110	Countershaft Gear Coupling Sliding, 21 Tooth Fits Models w/ 8 Speed Non-Synchro Transmissions	AME0NN7106BA	\$ 60.00	
 2000, 3000, 4000 Series, 2310, 2610, 2810, 2910, 3230, 3610, 3910, 3930, 4110, 4330, 4610, 4630, 4830, 5000 Series, 5030, 5610, 5640, 6610, 6640, 7000 Series, 7010, 7610, 7710, 7740, 7840, 8010, 8240, Dexta, Super Dexta, TS90, TS100, TS110	Front Gear Shift Coupling Assembly 28 Tooth, 17 Splines Fits most Models w/ 6, 7 or 8 Speed Transmissions	AME6NN7N072AA	\$ 50.00	
 2000 Series, 2100, 2110, 2600, 2610, 2810, 2910, 3000 Series, 3100, 3230, 3330, 3400, 3430, 3500, 3550, 3600, 3610, 3900, 3910, 3930, 4000 Series, 4100, 4110, 4130, 4140, 4190, 4200, 4330, 4340, 4400, 4410, 4500, 4600, 4610, 4630, 4830, 5000 Series, 5030, 5100, 5110, 5190, 5200, 5340, 5600, 5610, 5640, 5700, 6600, 6610, 6640, 6700, 6710, 6810, 7000 Series, 7010 ASN 850001M, 7100, 7200, 7600, 7610, 7700, 7710, 7740, 7810, 7840, 8010 ASN 800001M, 8240, TS90, TS100, TS110	Rear Gear Shift Coupling Assembly 28 Tooth, 20 Splines	AME6NN7N072BA	\$ 95.00	

Ford® / New Holland®—Tractor

Application	Description	Part Number	Retail Price	Core
 2000, 2100, 2600, 3000, 3100, 3400, 3500, 3550, 3600, 3900, 4100, 4200, 4400, 4410, 6710, 6810, 7100, 7600, 7610, 7700, 7710, 8000, 8700, 9000, 9700, TW10, TW20, TW30	Clutch Pedal Return Spring	AMC7NN7N598A	\$ 5.27	
 2100, 2110, 2300, 3000, 3100, 3120, 3190, 3310, 3400, 3600, 3610, 4110	Main Input Shaft 17.75" Long, 19 Tooth, 10 Splines	AMC7NN7017AB	\$ 110.00	
(T7.220, T7.235, T7.250, T7.260 - Power Command)	Friction Disc, Transmission Engagement Clutch	AM5163844	\$ 9.63	

Transmission Discs

Application	Description	Part Number	Retail Price	Core
8160, 8260, 8360, 8560, (T6030, T7040 - Power Command), (T6050, T6070, T6080, T6090, T7.170 - Range Command and Power Command), (T7030, T7050, T7060, T7.185, T7.200, T7.220, T7.230, T7.235, T7.245, T7.260 - Excluding Auto Command), T7.165, T7.165S, (T7.175, T7.190, T7.225 - Excluding Auto Command MY15, MY18), (T7.210 Excluding Non Tier 4B Auto Command and Tier 4B Auto Command MY15, MY18), T7.215S, TM115, TM120, TM125, TM130, TM135, TM140, TM150, TM155, TM165, TM175, TM190	Transmission Clutch Pack Includes (6) Inner Spline Discs and (6) Outer Spline Discs Replaces 5167875, 5167876	AM87530788	\$ 70.53	
8160, 8260, 8360, 8560, T6030, T6050, T6070, T6080, T6090, T7.165, T7.170, T7.175, T7.185, T7.190, T7.200, T7.210, T7.225, TM115, TM120, TM125, TM130, TM135, TM140, TM150, TM155, TM165	Transmission Clutch Pack Note: Please verify model year and serial number for fit before ordering Includes (8) Inner Spline Discs and (8) Outer Spline Discs	AM87530796	\$ 125.55	
T6030, T6050, T6070, T6080, T6090, T7030, T7040, T7050, T7060, T7.165, T7.170, T7.175, T7.185, T7.190, T7.200, T7.210, T7.220, T7.225, T7.230, T7.235, T7.245, T7.250, T7.260, TM120, TM130, TM140, TM155, TM175, TM190	Transmission Clutch Pack Note: Please verify model year and serial number for fit before ordering Includes (8) Inner Spline Discs and (8) Outer Spline Discs Replaces 5165058, 5165059	AM87530789	\$ 105.55	

PTO Assembly Components

Application	Description	Part Number	Retail Price	Core
TM120, TM130, TM155, TM175, TM190	PTO Damper Replaces 47126791, 47127097	AM87302871	\$ 235.00	
231, 233, 234, 333, 334, 335, 340, 531, 535, 2000 1965 and Later, 2100, 2110, 2120, 2150, 2300, 2310, 2600, 2610, 2810, 2910, 3000, 3055, 3100, 3110, 3120, 3150, 3190, 3300, 3310, 3330, 3400, 3600, 3610, 3910, 4000 1965 and Later, 4100, 4110, 4190, 4200, 4330, 4340, 4400, 4410	PTO Shifter Fork Replaces 81801836	AMC5NN720A	\$ 15.00	
TL70, TL70A, TL80, TL100, TL100A	PTO Clutch Disc 44 Spline, 3.85" ID, 5.23" OD, 0.059" Thick	AM5165950	\$ 7.25	
(TL70, TL80, TL90, TL100 BSN C4738)	Separator Plate, PTO Clutch	AM5165954	\$ 6.42	
T6010, T6020, T6030, T6050, T6060, T6070, T6080, T6090, T7030, T7040, T7050, T7060, T7070, T6.120, T6.125, T6.140, T6.145, T6.150, T6.155, T6.160, T6.165, T6.175, T6.180, T7.165, T7.170, T7.175, T7.185, T7.190, T7.200, T7.210, T7.220, T7.225, T7.230, T7.235, T7.245, T7.250, T7.260, T7.270, T7.290, T7.315 Excluding Tier 4B MY18, TM175, TM190, TS100A, TS110A, TS115A, TS130A, TS135A	Friction Disc, PTO Clutch	AM5163844	\$ 9.63	
3600, 4100, 4600, 5000, 5100, 5110, 5600, 5610, 5610S, 5640, 5900, 6000, 6410, 6600, 6610, 6610S, 6640, 6700, 6710, 6810, 7000, 7010, 7100, 7410, 7600, 7610, 7610S, 7700, 7710, 7740, 7810, 7810S, 7910, 8000, 8010, 8200, 8210, 8340, 8600, 8670, 8670A, 8770, 8770A, 8870, 8870A, 8970, 8970A, 9000, 9200, 9600, 9700, TW10, TW20	PTO Brake Band Replaces 81819772, 83924796, 83956644, 89845550, C7NNB726D, E0NNB726AA	AME0NNB726AB	\$ 34.37	

Prices Subject to Change without Prior Notice. The use of original equipment manufacturer (OEM) part numbers or trademarks, e.g. Case® and John Deere®, are for reference purposes only and for indicating product use and compatibility. Our company and the listed replacement parts contained herein are not sponsored, approved or manufactured by the OEM. All parts are New unless designated Reman in the description.

Ford® / New Holland®—Tractor



PTO Shafts and Hubs

Application	Description	Part Number	Retail Price	Core
5000, 5100, 5110, 5600, 5610, 5900, 6410, 6600, 6610, 6700, 6710, 6810, 7100, 7200, 7600, 7610, 7700, 7710 - w/ 8 Speed Non-Synchro Transmissions	PTO Shaft - Internal PTO Drive 39.87" Long, 20 & 25 Spline Requires AME1NNN777AB 20 Spline PTO Hub when replacing C5NN7A684A 15 Spline Shaft	AME4NN7A684AA	\$ 326.83	
5000, 5600, 5610, 5700, 6600, 6610, 6700, 6710, 7000 Series, 7600, 7610, 7700, 7710	PTO Shaft - Internal PTO Drive 25.40" Long, 21 & 25 Spline	AMC5NNA701A	\$ 130.00	
8000, 8200, 8400, 8600, 8700, 9200, 9600, 9700	PTO Shaft - Internal PTO Drive 37.50" Long, 2 Sets of Splines, 22 & 25 Spline Use w/ AMD8NNN778AA PTO Hub	AMD8NN7A684BA	\$ 369.48	
8000, 8200, 8400, 8600, 8700, 9200, 9600, 9700	PTO Shaft - Internal PTO Drive 37.562" Long, 20 Spline Use w/ AME1NNN777AB PTO Hub	AMC9NN7A684A	\$ 505.49	
8000, 8700, 9000, 9700	PTO Shaft - Internal PTO Drive 37.50" Long, 20 Spline Use w/ AME1NNN777AB PTO Hub	AMC7NN7A684D	\$ 420.67	
T6010, T6020, T6030, T6040, T6050, T6060, T6070, T6080, T6090, T7030, T7040, T7050, T7060, T7070, T6.120, T6.140, T6.150, T6.155, T6.160, T6.165, T6.175, T7.185, T7.200, T7.210, T7.220, T7.235, T7.250, T7.260, T7.270, TM115, TM120, TM125, TM130, TM135, TM140, TM150, TM155, TM165, TM175, TM190, TS100A, TS110A, TS115A, TS125A, TS130A, TS135A	PTO Shaft, 540 RPM 6 Tooth Front Spline Replaces 5182612, 5182613	AM47130743	\$ 180.00	
TW10, TW20, TW30	PTO Shaft - Internal PTO Drive 37.50" Long, 3 Sets of Splines, 22 & 25 Spline Use w/ AMD8NNN778AA PTO Hub	AMD8NN7A684AB	\$ 342.01	
TM120, TM175, TS125A	PTO Shaft 1000 RPM, 21 Spline, 1 3/8" Spline Diameter	AM47130744	\$ 131.00	
5000 Series, 5100, 5110, 5600, 5610, 5640, 5700, 5900, 6600, 6610, 6640, 6700, 6710, 6810, 7000 Series, 7010, 7100, 7200, 7410, 7600, 7610, 7700, 7710, 7740, 7810, 7840, 7910, 8010, 8210, 8240, 8400, 8600, 8700, 9000, 9200, 9600, 9700, TS90, TS100, TS110	PTO Hub 20 Spline Use w/ AMC7NN7A684D & AMC9NN7A684A PTO Shafts	AME1NNN777AB	\$ 70.00	
5000, 5110, 5600, 5610, 5900, 6410, 6600, 6610, 6700, 6710, 6810, 7000, 7600, 7610, 7700, 7710	PTO Hub 15 Spline	AMC5NNN777A	\$ 50.00	
8000 Series, 8200, 8400, 8530, 8600, 8630, 8700, 8730, 8830, 9000 Series, 9200, 9600, 9700, TW5, TW10, TW15, TW20, TW25, TW30, TW35	PTO Hub 22 Spline Use w/ AMD8NN7A684BA & AMD8NN7A684AB PTO Shafts	AMD8NNN778AA	\$ 146.00	
233, 234, 333, 334, 335, 515, 2100, 2110, 2120, 2300, 2310, 2600, 2600N, 2600R, 2600V, 2610, 2610V, 3055, 3100, 3110, 3120, 3300, 3310, 3400, 3500, 3550, 3600, 3600N, 3600NO, 3600R, 3600V, 3610, 3610NO, 3610V, 4100, 4110, 4140, 4190, 4200, 4330, 4340, 4400, 4410, 4500	PTO Countershaft Replaces 81801786	AMC5NN702A	\$ 170.00	

Ford® / New Holland®—Tractor



Ford® / New Holland®—Tractor

PTO Output Shafts

Application	Description	Part Number	Retail Price	Core
600, 700, 800, 900	PTO Output Shaft Conversion Kit Converts PTO Output Shaft from 1 1/8" to 1 3/8" Kit includes PTO Output Shaft, Shaft Cover, Front Bearing, Seals, Snap Rings, Collar and Tapered Pin	AMNCA700-38	\$ 107.00	
NAA 1953-54	PTO Output Shaft Conversion Kit Converts PTO Output Shaft from 1 1/8" to 1 3/8" Kit includes PTO Output Shaft, Shaft Cover, Front Bearing, Seals, Gasket, Snap Rings, Collar and Tapered Pin	AMNAA700-38	\$ 125.50	
2N, 8N, 9N	PTO Output Shaft Includes 1 3/8" Shaft, Front Bearing, Seals and Snap Rings	AM9N700-38	\$ 95.00	
	PTO Output Shaft Converts 1 1/8" to 1 3/8" Splines Replaces 9N70038, 18116938	AM9N710B	\$ 85.00	
2000, 2310, 2600, 2610, 2810, 2910, 3000, 3600, 3610, 3910, 4000 Series	PTO Output Shaft, 540 RPM 29.46" Long, 10 spline	AME5NNA728AA	\$ 75.00	
5000, 5100, 5200, 5600, 6600, 6700, 7000, 7100, 7200, 7600, 7700, 8000, 8600, 8700, 9000, 9600, 9700 - w/ 2 Speed PTO	PTO Output Shaft, 540 RPM 11.475" Long, 36 & 38 Tooth Drive Splines	AMD2NNB728A	\$ 120.00	
5000, 5100, 5200, 5600, 5700, 6600, 6700, 7000, 7100, 7200, 7600, 7700, 8000, 8600, 8700, 9000, 9600 - w/ 2 Speed PTO	PTO Output Shaft, 1000 RPM 11.475" Long, 38 Tooth Drive Spline	AMD2NNB728B	\$ 212.48	
5000 w/ Independent PTO, 5100, 5200, 7000 w/ Independent PTO, 7100, 7200 - w/ Single Speed PTO	PTO Output Shaft, 540 RPM 10.88" Long, 29 Tooth Drive Spline	AMD2NNN752C	\$ 161.00	
5000 Series, 5110, 5600, 5610, 5700, 5900, 6600, 6610, 6700, 6710, 6810, 7000 Series, 7600, 7610, 7700, 7710 - w/ Single Speed PTO	PTO Output Shaft, 540 RPM 12.03" Long, 29 Tooth Drive Spline	AME4NNN752AA	\$ 252.69	
5100, 5110, 5600, 5610, 5640, 5900, 6410, 6600, 6610, 6640, 6700, 6710, 6810, 7100, 7600, 7610, 7700, 7710, 7740, 7810, 7840, 7910, 8000, 8210, 8240, 8340, 8670, TW5, TW10, TW15, TW20, TW25 - w/ 2 Speed PTO	PTO Output Shaft, 540 RPM 11.719" Long, 8 Tooth Drive Spline	AME6NNB728AA	\$ 146.29	
5100, 5110, 5600, 5610, 5640, 5900, 6410, 6600, 6610, 6610S, 6640, 6700, 6710, 6810, 7100, 7600, 7610, 7700, 7710, 7740, 7810, 7840, 7910, 8000, 8210, 8240, 8340, 8670, 8700, 9700, TS100, TW5, TW10, TW15, TW20, TW25	PTO Output Shaft, 1000 RPM 8 Spline, 11.719" Long Replaces 86511620, D8NNB728BA	AMD8NNB728BC	\$ 194.55	
8670, 8670A, 8770, 8770A, 8870, 8870A, 8970, 8970A	PTO Output Shaft, 1000 RPM 20 Spline, 1 3/4" Diameter	AM9840406	\$ 313.27	
	PTO Output Shaft, 1000 RPM 21 Spline, 1 3/8" Diameter	AM9843942	\$ 380.50	

PTO Adapters

Application	Description	Part Number	Retail Price	Core
Tractors up to 70HP	PTO Adapter Small 540 to 1000 Spline, 4 1/8" Overall Length Changes PTO from 1 3/8" x 6 spline to 1 3/8" x 21 spline and extends the PTO shaft 4 1/8"	AMX59112	\$ 40.00	
Tractors up to 70HP	PTO Adapter Small 1000 to 540 Spline, 6 3/8" Overall Length Reduces PTO from 1 3/8" x 21 spline to 1 3/8" x 6 spline and extends the PTO shaft 4 1/8"	AMX59108	\$ 40.00	
Tractors up to 100HP	PTO Adapter Large 1000 to 540 Spline, 7 1/2" Overall Length Reduces PTO from 1 3/4" x 20 spline to 1 3/8" x 6 spline and extends the PTO shaft 4 5/8"	AMX59109	\$ 70.00	
Tractors up to 100HP	PTO Adapter Large 1000 to Small 1000 Spline, 7" Overall Length Changes PTO from 1 3/4" x 20 Spline to 1 3/8" x 21 Spline and extends the PTO shaft 4 5/8"	AMX59110	\$ 70.00	

Prices Subject to Change without Prior Notice. The use of original equipment manufacturer (OEM) part numbers or trademarks, e.g. Case® and John Deere®, are for reference purposes only and for indicating product use and compatibility. Our company and the listed replacement parts contained herein are not sponsored, approved or manufactured by the OEM. All parts are New unless designated Reman in the description.

Ford® / New Holland®—Tractor



PTO Gears

Application	Description	Part Number	Retail Price	Core
5610, 5610S, 5640, 6610, 6610S, 6640, 6710, 7010S, 7610, 7610S, 7710, 7740, 7810, 7810S, 7840, 7910, 8210, 8240, 8340	PTO Drive Gear - Double For 540 & 1000 RPM 2 Speed Independent PTO, 20 & 41 Tooth Drive Gear	AME0NN745AA	\$ 125.00	
	PTO Driven Gear - 1000 RPM For 540 & 1000 RPM 2 Speed Independent PTO, 8 Splines, 84 Tooth - Helical	AME0NNA726BA	\$ 394.58	
	PTO Driven Gear - 540 RPM For 540 & 1000 RPM 2 Speed Independent PTO, 70 Tooth	AME0NNA726AD	\$ 325.00	
5000, 5600, 5610, 5700, 6600, 6610, 6700, 6710, 7000 Series, 7600, 7610, 7700, 7710	PTO Driven Gear 81 Tooth Gear, 10 1/8" Outside Diameter	AMC5NNA726A	\$ 225.00	
8000, 8200, 8400, 8600, 8700, 9000, 9200, 9600 9700	PTO Drive Gear 89 Tooth, 11.54" Diameter	AMC7NNA726B	\$ 375.00	



PTO Clutch Parts

Application	Description	Part Number	Retail Price	Core
5000, 5100, 5200, 5340, 5600, 5610, 5700, 5900, 6600, 6610, 6700, 7000, 7100, 7200, 7600, 7610, 7700, 7710	PTO Clutch Pack 3 5/8" Overall Height Includes (4) Discs Replaces 83903939, D5NNN707A	AMD2NNN751D	\$ 225.00	
5000, 5100, 5200, 5340, 5600, 5700, 5900, 6600, 6700, 7000, 7100, 7200, 7600, 7700	PTO Clutch Pack 4-Plate, Preloaded Housing Includes 3 Friction Discs Replaces 83908229, D3NNN751D, D5NNN707A	AMD5NNN751A	\$ 261.00	
5110, 5610, 5610S, 5640, 5900, 6410, 6610, 6640, 6710, 6810, 7410, 7610, 7710, 7740, 7810, 7840, 7910, 8100, 8210, 8240, 8340, TB80, TB85, TB90, TB100, TB110, TB120, TS90, TS100, TS110	PTO Clutch Pack 3 7/8" Overall Height Includes (5) Friction Discs Replaces 81871420, E0NNN751BB	AME0NNN751BA	\$ 225.00	
8530, 8630, 8730, 8830, TW5, TW15, TW25, TW35	Dual Power Clutch Plate External Spline, 4.495" ID, 6.058" OD Replaces 83934543, 83958329, 89823827	AM83958330	\$ 10.83	
8670, 8670A, 8770, 8770A, 8870, 8870A, 8970, 8970A	PTO Clutch Plate External Spline, 4.495" ID, 6.058" OD Replaces 83934543, 83958329, 89823827	AM83958330	\$ 10.83	
5000 Series, 5600, 5610, 5700, 6600, 6610, 6700, 6710, 7000 Series, 7600, 7610, 7700, 7710, 7810	PTO Drive Clutch Hub 25/52 Tooth, 10-Plate Hub	AMF1NNN750AA	\$ 164.62	
5610S, 5640, 6610S, 6640, 7010, 7740, 7840, 8240, 8340, TB80, TB85, TB90, TB100, TB110, TB120, TS90, TS100, TS110, TS115, TS6000, TS6020, TS6030, TV140, TV145, TV6070, Versatile®: (9030E, 9030V - 04/1994 and Later)	PTO Drive Clutch Hub 26 Tooth Gear, 23 Internal Spline, 52 External Spline Replaces 83999197, 83999198, E9NNN750AB	AM81865535	\$ 167.38	
5000 Series, 5600, 5700, 6600, 6700, 7000 Series, 7600, 7700	PTO Drive Clutch Housing w/ Bushing Note: When used on 5000 and 7000 Series w/ Single Speed PTO, Replacing C9NN7R007A Direct Drive Housing Plate w/ D5NN7R007A Drive Housing Plate is Required	AMD5NNN707A	\$ 200.00	
2000, 2310, 2600, 2610, 2810, 2910, 3000, 3600, 3610	PTO Clutch Sleeve Replaces 81801828	AMC5NN717A	\$ 72.00	
5000 Series, 7000 Series	PTO Drive Clutch Valve Support w/ Relief Hole	AMC7NNN776C	\$ 24.00	
5000 Series, 5600, 5610, 5640, 5700, 5900, 6600, 6610, 6640, 6700, 6710, 6810, 7000 Series, 7010, 7600, 7610, 7700, 7710, 7740, 7810, 8010, 8200, TS90, TS100	PTO Drive Clutch Valve Support w/o Relief Hole	AMD2NNN776A	\$ 24.00	

Ford® / New Holland®—Tractor

Application	Description	Part Number	Retail Price	Core
5110, 5610, 5610S, 5640, 6610, 6610S, 6640, 6710, 6810 1981 and Later, (7010, 8010 ASN 850001M), 7610, 7710, 7740, 7810, 7810S, 7840, 7910, 8000, 8200, 8210, 8240, 8530, 8600, 8630, 8700, 8730, 8830, 9000, 9200, 9600, 9700, TB80, TB85, TB90, TB100, TB110, TB120, TS90, TS100, TS110, TW5, TW10, TW15, TW20, TW25, TW30, TW35	Internal Spline Plate Replaces 81870603, 83934543, 83958329	AM83925696	\$ 11.95	

Differentials and Components

Application	Description	Part Number	Retail Price	Core
2000 Series, 2310, 2600, 2610, 2810, 2910, 3000 Series, 3230, 3600, 3610, 3900, 3910, 3930, 4000 Series, 4600, 4610, 4630, 4830, 5000 Series, 5030, 5600, 5610, 5640, 5700, 6600, 6610, 6640, 6700, 7000 Series, 7010, 7600, 7610, 7700, 7710, 7740, 7810, 7840, 8240, TB100, TB110, TB120, TS90, TS100, TS110, TS115	 Side Gear w/ Smooth Outer Surface	AM81803445	\$ 85.00	
	 Side Gear w/ Splined Outer Surface	AM81803451	\$ 100.00	
	 Differential Spider Replaces C5NN4211A	AM81876885	\$ 90.00	
	 Differential Pinion Gear	AM81728114	\$ 35.00	
	 Pinion Thrust Washer	AM508E4230A	\$ 3.50	

Rear Axles and Components

Application	Description	Part Number	Retail Price	Core
8N, NAA, NAB	Rear Axle Hub	AM8N1171	\$ 90.00	
8N, NAA 1948-54	Rear Axle Shaft	AM8N4235B	\$ 147.00	
5000, 5600, 5700, 6600, 6700, Ind: 650, 5500, 6500	Rear Axle Shaft	AMC5NN4244N	\$ 225.00	

Brake Shoes

Application	Description	Part Number	Retail Price	Core
8N, NAA	Brake Shoe Set Set of 4	AM8N2200B	\$ 45.00	
501, 600, 700, 800, 900, (2000, 4000 - w/ 4 Cylinder Engine)	Brake Shoe Set Set of 4	AMNCA2218B	\$ 92.00	
2N, 9N	Brake Shoe Replaces 9N2219A	AM9N2019	\$ 36.41	
231, 335, 2000, 2110, 2310, 2600, 2610, 3000, 3400, 3500, 3600, 3610, Ind: 3500 - All w/ 3 Cylinder Engines	Brake Shoe 2" Wide, Sold Individually (2) Required Per side Note: When Converting 1 1/2" Wide Shoes to 2" Wide Shoes, (8) 957E2069A Pins are Required	AMC7NN2218A	\$ 19.50	
2000, 2600, 2610, (3000, 4110 - 12/1966 and Later), 3600, 3610	Brake Shoe 1 1/2" Wide, Sold Individually (2) Required Per Side	AMD9NN2218AA	\$ 28.00	

Ford® / New Holland®—Tractor

Brake Components

Application	Description	Part Number	Retail Price	Core
Models w/ Internal Wet Brakes	Brake Rod Seal	AM86576339	\$ 3.00	
8N	Brake Drum	AM8N1126	\$ 125.00	
230A, 231, 233, 234, 333, 334, 335, 530A, 531, 2000 Series, 2100, 2110, 2120, 2300, 2310, 2600, 2600N, 2600R, 2600V, 2610, 2610V, 3000 Series, 3100, 3120, 3190, 3300, 3310, 3330, 3400, 3500, 3600, 3600N, 3600NO, 3600R, 3600V, 3610, 3610NO, 3610V, 4000 Series, 4110, Ind: 3500	Brake Drum	AMC5NN1126E	\$ 52.00	
2000, 2110, 2310, 2600, 2610, 3000, 3400, 3600, 4110, Ind/Const: 230A, 233, 234, 333, 334, 335, 530A, 531	Brake Backing Plate Replaces 81815610	AMC5NN2212D	\$ 179.00	
2810, 2910, 3100, 3900, 3910, 4100, 4110, 4600, 4610, Ind: 445, 445A, 445C, 445D, 455	Brake Plate 4.488" ID, 8.228" OD Replaces 81802536	AMC5NN2N315B	\$ 5.00	
3000 Series, 4000 Series, 5000 Series, 5600, 5610, 5900, 6600, 6610, 6810, 7000 Series, 7600, 7610, 7710, 7810	Actuator Rod	AMC7NN2466B	\$ 21.00	
5000, 5100, 5200, 5600, 5610, 5640, 5700, 5900, 6410, 6600, 6600C, 6610, 6640, 6700, 6710, 7000, (7010, 8010 ASN 800001M), 7100, 7200, 7600, 7600C, 7700, 7710, 7740, 7810, 7840, 7910, 8210, 8240, 8340, TB80, TB85, TB90, TB100, TB110, TB120, TS90, TS100, TS110, TS115, TV140, TV145, TV6070	Brake Disc 22 Tooth, 0.19" Thick, 2.086" ID, 8.819" OD Replaces 83956599, C5NN2A097A, C7NN2A097B, E6NN2A097AA	AM87518036	\$ 31.48	
5000 Series, 5600, 5610, 6600, 6610, 6710, 6700, 7000 Series, 7610, 7710, 7600, 7810, 7910, 8210	Brake Actuator Assembly	AMC7NN2N317A	\$ 70.00	
8160, 8260, 8360, 8560, (TM115, TM120, TM125, TM130, TM135, TM140, TM150, TM155, TM165 BSN C4806)	Friction Disc, Handbrake 34 Spline 4.126" ID, 7.067" OD, 0.236" Thick	AM5146036	\$ 51.12	
8160, 8260, 8360, 8560, TM115, TM120, TM130, TM135, TM140, TM150, TM155, TM165	Pressure Ring	AM5152350	\$ 140.50	
T6010, T6020, T6030, T6040, T6050, T6060, T6070, T6080, T6090, T5.95, T5.105, T5.115, T6.120, T6.140, T6.145, T6.150, T6.155, T6.160, T6.165, T6.175, T6.180, T7.170, T7.175, T7.185, T7.190, T7.200, T7.210, T7.225, T7.230, T7.245, T7.260, T7.270, TM115, TM120, TM125, TM130, TM135, TM140, TM150, TM155, TM165 ASN D4806, TS100A, TS110A, TS115A, TS125A, TS130A, TS135A	Brake Pad Single Sided, 0.131" Thick	AM5199607	\$ 12.64	
T6010, T6020, T6030, T6040, T6050, T6060, T6070, T5.95, T5.105, T5.110, T5.115, T5.120, T6.120, T6.125, T6.140, T6.145, T6.150, T6.155, T6.160, T6.165, T6.175, T6.180, TM115, TM125, TM135, TM150, TM165, TS100A, TS110A, TS115A, TS125A, TS130A, TS135A	Brake Plate Splined, 4.134" ID, 7.441" OD, 0.177" Wide	AM47127225	\$ 18.93	
T6010, T6020, T6030, T6040, T6050, T6060, T6070, T6.120, T6.140, T6.150, T6.155, T6.160, T6.165, T6.175, TS100A, TS110A, TS115A, TS125A, TS130A, TS135A	Brake Disc	AM5191497	\$ 124.00	
T6010, T6020, T6030, T6040, T6050, T6060, T6070, TS100A, TS115A, TS125A, TS135A	Brake Disc	AM47131048	\$ 425.00	
T7030, T7040, T7050, T7060, T7070, T7.220, T7.230, T7.235, T7.245, T7.250, T7.260, T7.270, TM175, TM190	Brake Pad, Parking Center Shoes, 4.20 mm Thick	AM5196706	\$ 35.00	
T7030, T7040, T7050, T7060, T7.220, T7.230, T7.235, T7.245, T7.250, T7.260, T7.270	Brake Shoe, Parking Replaces 5196714	AM84152436	\$ 37.00	
T7030, T7040, T7050, T7060, T7070, T7.220, T7.230, T7.235, T7.245, T7.250, T7.260, T7.270, TM175, TM190	Brake Plate, Separator and Parking Replaces 5196708	AM47663732	\$ 30.00	
T8.275, T8.300, T8.320, T8.330, T8.350, T8.360, T8.390, T8.410, T8.420, T8.435	Brake Disc	AM84141962	\$ 82.00	
TG210, TG230, TG255, TG285	Brake Disc, Parking 3.50 mm Thick, 6.87" ID Replaces 87776014	AM195067A2	\$ 60.00	

Ford® / New Holland®—Tractor

Application	Description	Part Number	Retail Price	Core
TL70, TL80, TL90, TL100, TM115, TM120, TM125, TM130, TM135, TM140, TM150, TM155, TM165	Master Cylinder Replaces 82006194, 82018664	AM84558759	\$ 136.44	
TS100A, TS110A, TS115A	Master Cylinder Replaces 47132767	AM84535046	\$ 232.18	

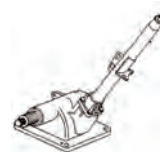

Manual Steering Gearbox Assemblies

Application	Description	Part Number	Retail Price	Core
2000 & 3000 Series - 1/65-12/74 Except 3550, 2600-3600V	Steering Column Assembly	AME0NN3503AA	\$ 575.00	
5100, 5110, 5600, 5610, 5900, 6410, 6600, 6610, 7100, 7600 - Models w/ Cylinder under Radiator	Steering Column Assembly	AMD7NN3503A	\$ 680.00	
8N ASN 216989	Steering Gearbox	AM8N3548B	\$ 495.00	
600, 800, 2000, 3000, 4000, NAA	Steering Gearbox Arm	AM86542743	\$ 89.47	
2000, 2100, 2110, 2120, 2150, 2600, 3000, 3055, 3100, (3110, 3300, 3500 - w/ Manual Steering), 3120, 3150, 3400, 3600, 3900, 4000, 4100, 4110, 4400, 4410, 4600SU, 4610SU	Shaft, Primary Sector Replaces Factory 5 Tooth Single Gear Replaces C5NN3N575A	AMC7NN3N575A	\$ 58.61	
2000, 2100, 2110, 2120, 2150, (2300, 2310, 3300, 3310 - w/ Manual Steering), 2600, 2610, 3000, 3055, 3100, 3110, 3120, 3150, 3330, 3400, 3600, 3610, 3900, 4000, 4600SU, 4610SU	Shaft, Secondary Sector	AMC7NN3N576A	\$ 58.61	

Power Steering Gearbox Assembly and Components

Application	Description	Part Number	Retail Price	Core
5600, 6600, 7600 (1975-81 w/o Cab)	Steering Column Assembly For Power Steering Assembly	AME1NN3N503BC	\$ 1395.00	
2000, 2100, 2110, 2120, 2150, (2310, 2610, 2910, 3610, 3910, 4140 - w/ Power Steering), 2600, 3000, 3055, 3100, 3120, 3150, 3400, 3600, 3900, 4000, 4100, 4110, 4400, 4410, 4600SU, 4610SU	Shaft, Primary Sector Replaces Factory 5 Tooth Single Gear Replaces C5NN3N575A	AMC7NN3N575A	\$ 58.61	
2000, 2100, 2110, 2120, 2150, 2600, 2610, (2910, 4100, 4110, 4140, 4400, 4410 - w/ Power Steering), 3000, 3055, 3100, 3110, 3120, 3150, 3330, 3400, 3600, 3610, 3900, 4000, 4600SU, 4610SU	Shaft, Secondary Sector	AMC7NN3N576A	\$ 58.61	



Steering Shafts

Application	Description	Part Number	Retail Price	Core
8N ASN 216989, 600, 800, 2000, 4000, NAA - w/ 4 Cylinder Engines	Steering Sector Shaft, Right Hand Single, Works with OEM Gears	AM251293	\$ 130.00	
1300, 1500, 1700, 3000, 3600, 3900 Replaces SBA334130041, SBA34130041	Steering Sector Shaft 15/16" to 1" Taper, 5 Tooth, 36 Splines	AM38180-16120	\$ 158.50	
2000, 3000, 4000	Rocker Shaft	AMC9NN3575C	\$ 156.00	
2000, 2600, 3000, 3600, 3900, 4100	Manual Steering Shaft w/ Nut 26.25" Long	AMD2NN3A710B	\$ 60.00	
5000, 5100, 5110, 5600, 5610, 5900, 6410, 6600, 6610, 7410, 7700	Manual Steering Shaft w/ Nut 28.75" Long	AMD2NN3A710A	\$ 60.00	
5000, 5100, 5340, 7000, 7100	Steering Shaft 28.65" Long	AMC5NN3A710A	\$ 164.00	

Ford® / New Holland®—Tractor

Drawbars and Components

All of our drawbars are cut, drilled and heat-treated to exact design and specifications that meet or exceed OEM specifications.



Application	Description	Part Number	Retail Price	Core
2000, 2600, 2610, 2810, 2910, 3000, 3100, 3230, 3430, 3600, 3610, 3910, 3930, 4130, 4610, 4630, 4830	Drawbar 2" x 1" x 32.875" w/ 1.50" Offset, (2) 0.970" Diameter Holes: 1.75" & 3.75" from Front	AM82009197	\$ 165.00	
(2000, 3000, 4110 - w/ Swinging Drawbar), 2600, 2610, 2810, 2910, 3100, 3600, 3610, 3910, 4610	Drawbar 2" x 1" x 30.875" w/ 1.75" Offset, (2) 0.906" Diameter Holes: 1.25" & 3.25" from Front	AM86531346	\$ 65.00	
2600, 3600, 3900, 4100, 4600, Ind: 515, 532	Drawbar 2" x 1.25" x 34.625", (4) 0.937" Diameter Holes: 1.343", 3.343", 5.718" & 7.718" from Front	AMC5NN805F-SPL	\$ 69.00	
(2810, 2910, 3910, 4100, 4110, 4600 - w/ Clevis), (3230, 3430, 3930, 4130, 4630, 4830 - 07/1990 and Later), 4000 w/ 540 RPM PTO, 5030 09/1992 and Later	Drawbar 2" x 1.25" x 32.50" w/ 2.75" Offset, (2) 0.922" Diameter Holes: 1.375" & 5.75" from Front	AMC5NN805J	\$ 95.00	
3230, 3430, 3930, 4130, 4630, 4830, 5030	Drawbar 2" x 1.25" x 32.63"	AM86520237	\$ 167.00	
3900, 4000 w/ 540 or 1000 RPM PTO, 4400, 4600	Drawbar 2" x 1.25" x 34.63" w/ 2.75" Offset, (4) 0.937" Diameter Holes: 1.343", 3.34", 5.718" & 7.718" from Front	AMC5NN805F	\$ 80.00	
4100, 4600, 5000 Series, 5100, 5110, 5200, 5340, 5600, 5610, 5700, 5900, 6410, 6600, 6610, 6700, 6710, 6810, 7000 Series, 7100, 7200, 7410, 7600, 7610, 7700, 7710	Drawbar 2.344" x 1.156" x 33.125", (2) 1.18" Diameter Holes: 1.75" & 4.75" from Front	AMD2NN805A	\$ 85.00	
(5000, 7000 - 1965-06/73), 7100, 7200	Drawbar 2.25" x 1.375" x 34.75"	AMC5NN805A	\$ 110.00	
5100, 5110, 5600, 5610, 5900, 6410, 6600, 6610, 6700, 6710, 6810, 7000, 7100, 7410, 7600, 7610, 7700, 7710, 7810, 7910, 8210	Drawbar, Standard Duty 2.50" x 1.375" x 36.90", (3) 1.165" Diameter Holes: 1.25", 3.25", & 7.75" from Front For Both Single Speed & Dual Speed PTO Tractors because of the Third Hole in the Front of the Drawbar	AME0NN805AC	\$ 89.00	
5640, 6640, 7740, 7840, 8240, 8340	Drawbar 2.25" x 1.625" x 36.25", (3) 1.156" Diameter Holes at 1.25", 3.25" & 7.75" from Front For Standard Swinging Drawbar	AME9NN805AA	\$ 180.00	
7810, 78100, 7910, 8000, 8210, 8400, 8530, 8600, 8630, 8700, 8730, 8830, 9000, 9200, 9600, 9700, TW5, TW10, TW15, TW20, TW25, TW30, TW35	Drawbar 3" x 1.375" x 42.50", (2) holes at 1.125" & 3.25" from front Replaces 83902378, C9NN805A	AMD3NN805A	\$ 256.00	
8210, (8160, 8260, 8360, 8560 BSN C3857 w/ Rollers), (TS90, TS100, TS110, TS115 ASN C3855 w/ Swinging Drawbar)	Drawbar 3" x 1.375" x 41.75", (2) 1.141" Diameter Holes at 1.125" & 2.75" from Front Replaces 82010158	AME3NN805AA12B	\$ 180.00	
T8010, T8020, T8030, T8040	Drawbar Replaces 232515A1, 87773618	AM232515A2	\$ 815.00	
T8010, T8020, T8030, T8040, T8050, TG210, TG215, TG230, TG245, TG255, TG275, TG285, TG305	Drawbar Replaces 310529A1, 719663006, 719663016	AM87680426	\$ 860.00	
T8010, T8020, T8030, T8040, TG210, TG215, TG230, TG245, TG255, TG275, TG285, TG305	Drawbar Replaces 277702A1, 87773807	AM277702A2	\$ 695.00	

Ford® / New Holland®—Tractor

Application	Description	Part Number	Retail Price	Core
TG210, TG230, TG255, TG285	Drawbar 5" x 2" x 57.125", (6) Holes: 1.625", 3.8125", 7.375", 9.50", 11.625" & 13.75" from Front	AM426511A1	\$ 1014.85	
TG215, TG245, TG275, TG305	Drawbar Cat IV	AM87688072	\$ 1556.88	
TM175, TM190	Drawbar	AM82028979	\$ 615.00	
T7.195S, T7.215S, T7.220, T7.235, T7.245, T7.250, T7.260, T7.270, T7.290, T7.315	Drawbar Replaces 87303691, 87561341	AM87561441	\$ 520.00	
230A, 231, 233, 333, 335, 420, 515, 530A, 531, 532, 535, 2000 Series, 2100, 2110, 2120, 2150, 2300, 2310, 2600, 2610, 3000 Series, 3055, 3100, 3110, 3120, 3150, 3300, 3310, 3330, 3400, 3500, 3600, 3610, 3900, 4000 Series, 4100, 4110, 4600, 5600, 5700, 6600, 6700, 7600, 7700, Ind: 3500	Drawbar Hanger	AMD1NN809A	\$ 270.00	

Hammer Straps



Application	Description	Part Number	Retail Price	Core
TG210, TG230, TG255, TG285	Drawbar Hammer Strap	AM232615A3	\$ 135.00	

Rockshaft Components

Application	Description	Part Number	Retail Price	Core
8160, 8260, 8360, 8560, TM115, TM120, TM125, TM130, TM135, TM140, TM150, TM155, TM165	Rockshaft Control Shaft	AM5171027	\$ 375.00	
TM115, TM120, TM125, TM130, TM135, TM140, TM150, TM155, TM165	Rockshaft Lift Arm Replaces 5171960	Left Hand AM87317739	\$ 235.00	
TM140, TM150	Rockshaft Lift Arm	Right Hand AM87317740	\$ 235.00	



Lift Link Assemblies and Components

Application	Description	Part Number	Retail Price	Core
2N, 8N, 9N	Leveling Box Assembly w/ Fork, Right Hand	AM8N577A	\$ 50.00	
2N, 8N, 9N, 501, 541, 600, 601, 611, 621, 630, 631, 640, 641, 650, 651, 660, 661, 671, 681, 700, 701, 740, 741, 771, 800, 801, 811, 820, 821, 840, 841, 850, 851, 860, 861, 871, 881, 900, 901, 941, 950, 951, 960, 961, 971, 981, (2000, 4000 - w/ 4 Cylinder Engine), 2120, 4120	Leveling Box Fork, Right Hand 9" Long	AMEC0N585A	\$ 16.00	
2N, 8N, 9N, 600, 700, 800, 900, 2000, 2100, 2110, 2120, 2150, 2300, 2310, 2600, 2610, 3000, 3120, 3300, 3310, 3330, 3400, 3500, 3600, 3610, 4110, 4600, NAA	Leveling Box Fork, Left Hand Replaces 81802071, 87712987	AMC5NNB863A	\$ 25.00	
2N, 8N, 9N, NAA	Lift Rod Assembly, Left Hand Replaces 9N564B, 182544M92, 81801642	AM1884720M1	\$ 40.00	
600, 601, 800, 801, 2000, 2610, 3000, 3100, 3600, 3610, 4000	Leveling Rod Assembly Replaces C5NN585D, C7NN564B	AMC5NNR862A	\$ 45.00	

Ford® / New Holland®—Tractor

Application	Description	Part Number	Retail Price	Core
2000 Series w/ 3 Cylinder Engines, 2600, 2610, 3000, 3100, 3600, 3610, Ind/Utility: 340, 2100, 3400, 3550, 4110, 4200	Leveling Box Assembly w/ Fork, Right Hand Adjusts from 20.25" to 25.25" center-to-center on mounting holes	AME0NN569AA	\$ 55.00	
2000, 2100, 2110, 2120, 2150, 2300, 2310, 2600, 2610, 3000, 3100, 3120, 3300, 3310, 3330, 3400, 3500, 3600, 3610, 4110, 4600SU	Lift Link Assembly, Left Hand Assembly Includes Knuckle, Rod and Fork Replaces C5NN564D, C5NNR862A, E0NNB484DA	AM2N564B	\$ 35.00	
4000, 4600	Leveling Box Assembly w/ Fork, Right Hand Adjusts from 27.25" to 32.25" center-to-center on mounting holes	AMC5NN569AM	\$ 79.00	
	Lift Link Assembly, Left Hand Assembly includes Knuckle, Rod and Fork	AM4N564B	\$ 35.00	
5000, 5100, 5110, 5200, 5340, 5600, 5610, 5700, 5900, 6000, 6410, 6600, 6600C, 6600O, 6610, 6610O, 6700, 6710, 6810, 7000, 7100, 7200, 7410, 7600, 7600C, 7610, 7610O, 7700, 7710	Lift Link Assembly w/ Fork, Left Hand Replaces C5NNB863CA, VPL2229	AMD2NNN984A	\$ 94.00	
5000, 5100, 5200, 5600, 6600, 6610, 6700, 7100, 7200, 7600, 7700	Leveling Box Assembly w/ Fork, Right Hand Adjusts from 25.00" to 31.00" center-to-center on mounting holes	AMD2NNN983WF	\$ 135.00	
	Components:			
	Level Box Assembly, Right Hand	AMD2NNN983A	\$ 100.00	
	Fork	AMC7NNA935C	\$ 50.00	
5110, 5610, 5900, 6410, 6710, 6810, 7410, 7610, 7710	Leveling Box Assembly w/ Fork, Right Hand Adjusts from 20.25" to 25.25" center-to-center on mounting holes	AME0NN569WF	\$ 165.00	
	Components:			
	Level Box Assembly, Right Hand	AME0NN569KB	\$ 85.00	
	Fork	AMD5NNA935B	\$ 90.00	
5640, 6640, 6640O, 7740, 7740O, 7840, 7840O, 8240, 8340, TV140	Leveling Box Assembly w/ Fork, Right Hand Replaces 82021056, F0NNA935AA, F0NNA954CD	AM83991548	\$ 259.00	
5000, 5100, 5110, 5200, 5340, 5600, 5610, 5700, 5900, 6410, 6600, 6610, 6700, 6710, 6810, 7000, 7100, 7200, 7410, 7600, 7610, 7700, 7710, 8600, 8700, 9000, 9600, 9700, TW10, TW20, TW30	Bevel Gear For Lift Link Assemblies Replaces 81821842	AMC7NN568B	\$ 17.00	
T7030, T7040, T7050, T7060, T7.220, T7.230, T7.235, T7.245, T7.250, T7.260	Lift Link Assembly Replaces 5188140, 47133994	AM84253931	\$ 257.00	

Lower Lift Links



Application	Description	Part Number	Retail Price	Core
(600, 601, 700, 701, 800, 801, 900, 901, 2000, 4000 - w/ 4 Cylinder), (2000, 3000, 3610 - w/ 3 Cylinder)	Lower Lift Arm, Cat I 32.25" Long, 7/8" Hole	Right Hand Left Hand	AMD0NN555D AMD0NN555C	\$ 43.00 \$ 43.00
2310, 2600, 2610, 3000 Series, 3055, 3100, 3310, 3600, 3610, 3900, 4000 Series, 4600, 4610SU, Ind/Utility: 230A, 231, 233, 250C, 260C, 333, 334, 335, 340, 340A, 340B, 345C, 345D, 420, 445, 445A, 445C, 445D, 450, 515, 530A, 531, 532, 535, 540, 540A, 540B, 545, 545A, 545C, 545D, 3550	Lower Lift Arm, Cat I 33.00" Long, 0.875" Hole	Right Hand Left Hand	AME5NN555AA AME5NN556AA	\$ 85.00 \$ 85.00
2810, 2910, 3000, 3055, 3230, 3430, 3900, 3910, 3930, 4000, 4100, 4110, 4130, 4200, 4330, 4340, 4400, 4410, 4600, 4610, 4610SU, 4630, 4830, 5030, Ind/Utility: 250C, 260C, 345D, 445D, 515, 532, 535, 545D, 3550, 4500	Lower Lift Arm, Cat II 35.00" Long, 1 1/8" Hole	Right or Left Hand	AM82002004	\$ 179.85

Ford® / New Holland®—Tractor

Application	Description	Part Number	Retail Price	Core
2310, 2600, 2610, 2810, 2910, 3000 Series, 3055, 3100, 3230, 3310, 3430, 3600, 3610, 3900, 3910, 3930, 4000 Series, 4100, 4110, 4130, 4200, 4330, 4340, 4400, 4410, 4600, 4610SU, 4630, 4830, 5030, Ind/Utility: 230A, 231, 233, 250C, 260C, 333, 334, 335, 340, 340A, 340B, 345C, 345D, 420, 445, 445A, 445C, 445D, 450, 515, 530A, 531, 532, 535, 540, 540A, 540B, 545, 545A, 545C, 545D, 3550, 4500	Lift Arm Replacement Ball, Cat I 0.875" ID, 2.25" OD Use w/ AME5NN556AA, AME5NN555AA or AM82002004 Lift Arm w/ Removable Ball	AME1ADDN995233	\$ 6.93	
5000 Series, 5100, 5200, 5340, 5600, 5700, 6600, 6600C, 6600O, 6700, 7000 Series, 7100, 7200, 7600, 7600C, 7700	Lower Lift Arm, Cat II 35.00" Long, 1 1/8" Hole	Right or Left Hand AMD2NN555E	\$ 65.00	
5000 Series, 5600, 5610, 5700, 5710, 6600, 6610, 6700, 6710, 7000 Series, 7600, 7610, 7700, 7710	Lower Lift Arm, Cat II 37.00" Long, 1 1/8" Hole	Right or Left Hand AM82002013	\$ 140.00	

Three Point Hitch Components

Application	Description	Part Number	Retail Price	Core
2910, 3910, 4110, 4620	Stabilizer Bracket	Right Hand AMC7NND933B	\$ 25.00	
		Left Hand AMC7NND932B	\$ 25.00	
	Stabilizer Bracket U-Bolt	AMC5NN16N321A	\$ 9.00	
5610, 6610, 6710, 7610, 7710, 8210	Stabilizer Bracket	Right Hand AMC7NND933A	\$ 25.00	
		Left Hand AMC7NND932A	\$ 25.00	
	Stabilizer Bracket U-Bolt	AM388838S36	\$ 8.00	
2910, 3910, 4110, 4620	Stabilizer Assembly Complete Assembly w/o Bracket and U-Bolts	Right or Left Hand AMD9NNB856BB	\$ 50.00	
5610, 6610, 6710, 7710, 8210	Stabilizer Assembly Complete Assembly w/o Bracket and U-Bolts	Right or Left Hand AMD9NNB856AA	\$ 185.29	
5000, 5100, 5110, 5200, 5340, 5600, 5610, 5640, 5700, 5900, 6410, 6600, 6610, 6640, 6700, 6710, 6810, 7000, 7100, 7200, 7600, 7610, 7700, 7710, 7740, 7810, 7840, 7910, 8210, 8240, 8340	Draft Control Yoke Replaces 81827128	AMD2NN546A	\$ 60.00	



Quick Hitches







Application	Description	Part Number	Retail Price	Core
Cat II	Quick Hitch, 4" x 6" Beam 36" Wide, Includes 1 1/8" Mounting Pins and Adapter Bushings	AMX741020	\$ 565.00	
Cat III	Quick Hitch, 4" x 6" Beam 38" Wide, Includes 1 7/16" Mounting Pins	AMX741022	\$ 565.00	
Cat III	Quick Hitch, 4" x 6" Beam 44" Wide, Includes 1 7/16" Mounting Pins	AMX741021	\$ 565.00	
8670, 8670A, 8770, 8770A, 8870, 8870A, 8970, 8970A, TM115, TM120, TM125, TM130, TM135, TM140, TM150, TM155, TM165, TS100, TS110, TS115	Pull Arm Latch, CAT III Right or Left Hand For Flat/Hook Style Pull Arm Replaces 3903314M91, 86017137, CH167802	AMAL117727	\$ 60.00	

Ford® / New Holland®—Tractor

Hydraulic Lift Components

	Application	Description	Part Number	Retail Price	Core
	T6030, T6050, T6070, T6080	Hydraulic Lift Cylinder	AM87392350	\$ 360.00	
	2N, 8N, 9N	Hydraulic Lift Cylinder Housing	AM9N510D	\$ 60.00	
	2N, 8N, 9N	Hydraulic Lift Ram Arm	AM8N545B	\$ 60.00	
	600, 700, 800, 900, 2000, 4000 - w/ 4 Cylinder Engines	Hydraulic Lift Ram Arm	AMNCA545B	\$ 70.00	
	2000 Series, 2100, 2110, 2120, 2150, 2300, 2310, 2600N, 2600V, 2610V, 3000 Series, 3100, 3110, 3120, 3150, 3300, 3310, 3330, 3400, 3500, 3600N, 3600V, 3610N, 3610V, 4000 Series, 4110 - w/ 3 Cylinder Engines	Hydraulic Lift Ram Arm	AMC5NN545B	\$ 60.00	
	5000, 5100, 5200, 5340, 5600, 5700, 5900, 6600, 6700, 7600, 7700	Hydraulic Lift Ram Arm	AMC7NN545C	\$ 85.00	
	2310, 2600, 2610, 2910, 3600, 3610, 3900, 3910, 4600, Ind: 230A, 231, 233, 234, 333, 334, 335, 340, 340A, 340B, 530A, 531	Hydraulic Lift Arm, Right Hand Use on AMC5NN544D Hydraulic Lift Shaft	AMC5NNB920D	\$ 50.00	
		Hydraulic Lift Arm, Left Hand Use on AMC5NN544D Hydraulic Lift Shaft	AMC5NNB921D	\$ 50.00	
	5000 Series, 5600, 5610, 5700, 6600, 6610, 6700, 7000, 7600, 7610, 7700, 7810, 7910, 8210	Hydraulic Lift Arm, Right Hand Use on AMC5NN544B Hydraulic Lift Shaft	AME3NN838AA	\$ 80.00	
		Hydraulic Lift Arm, Left Hand Use on AMC5NN544B Hydraulic Lift Shaft	AME3NN839AA	\$ 80.00	
	2310, 2600, 2610, 2910, 3600, 3610, 3900, 3910, 4600, Ind: 230A, 231, 233, 234, 333, 334, 335, 340, 340A, 340B, 530A, 531	Hydraulic Lift Shaft	AMC5NN544D	\$ 90.00	
	5000 Series, 5600, 5610, 5700, 6600, 6610, 6700, 7000, 7600, 7610, 7700, 7810, 7910, 8210	Hydraulic Lift Shaft	AMC5NN544B	\$ 122.36	
	2N, 8N, 9N, 600, 700, 800, 900, (2000, 4000 - w/ 3 or 4 Cylinder Engine), 2310, 2600, 2610, 3000, 3600, 3610, 3910, 4600, NAA, Dexta, Super Dexta, Ind: 230A, 234, 334, 335, 340A 10/1981-04/83, 530A	Lift Cylinder Rod Replaces 957E526	AM86563314	\$ 34.61	
	5000, 5600, 5610, 5640, 5700, 6600, 6610, 6640, 6700, 7000, 7600, 7610, 7640, 7700, 7710, 7740, 7810, 7840, 8210, 8240, 8340, TS90, TS100, TS110	Lift Cylinder Rod	AMC7NN526D	\$ 35.00	

Ford® / New Holland®—Tractor

	Application	Description	Part Number	Retail Price	Core
	2N, 8N, 9N	Hydraulic Lift Piston	AM9N530B	\$ 20.00	
	5000, 5600, 5700, 6600, 6700, 7000, 7600, 7700	Hydraulic Lift Piston 3.75" Diameter	AMD3NN530D	\$ 25.00	
	5600, 5610, 5640, 5700, 5710, 6600, 6610, 6640, 6700, 7600, 7610, 7640, 7700, 7710, 7810, 7840, 7910, 8210, 8240, 8340, 8530, 8630, 8730, 8830, TS90, TS110, TS115, TW5, TW15, TW25, TW35	Hydraulic Lift Piston 4.125" Diameter	AMD5NN530A	\$ 30.00	
	8000, 8200, 8400, 8600, 8700, 9200, 9600, TW5, TW15	Snap Ring For Hydraulic Lift Position Control Lever to Shaft	AM505026	\$ 1.50	
	2000, 2100, 2110, 2120, 2150, 2300, 2310, 2600, 2610, 2810, 2910, 3000, 3055, 3100, 3110, 3120, 3150, 3230, 3300, 3310, 3330, 3400, 3430, 3600, 3610, 3900, 3910, 3930, 4000, 4100, 4110, 4130, 4140, 4200, 4330, 4340, 4400, 4410, 4600, 4610, 4630, 4830, 5030, Ind: 345C, 345D, 420, 445, 445D, 450, 535, 540, 545, 545D, 3500, 3550, 4500	Draft Control Spring Housing Replaces 81815737	AMC5NNN905B	\$ 65.00	
	T8010, T8020, T8030, T8040, T8050, TG210, TG215, TG230, TG245, TG255, TG275, TG285, TG305	Solenoid, Hitch Valve Replaces 87775314	AM188105A1	\$ 70.00	

Toplink Assemblies



Application	Description	Part Number	Retail Price	Core
230A, 2000 Series, 2600, 2610, 3000 Series, 3600, 3610, Ind/Utility: 334, 335, 530A	Toplink Assembly Cat I, 3/4" Holes	AME0NN576DA	\$ 55.00	
2810, 2910, 3000 Series, 3055, 3900, 3910, 4000, 4100, 4110, 4600, 4600SU, 4610, 5000, 5100, 5110, 5200, 5600, 5610, 5700, 5900, 6000, 6600, 6610, 6700, 6710, 6810, 7000, 7100, 7200, 7410, 7600, 7610, 7700, 7710, Ind/Utility: 340, 340A, 340B, 445, 445A, 450, 540, 540A, 540B, 545, 545A, 3550	Toplink Assembly Cat II, 1" Holes	AMD0NN576A	\$ 45.00	
3000 Series, 3910, 4000 Series, 4100, 4110, 4600, 4610, 4610SU, Ind/Utility: 340, 340A, 340B, 445, 445A, 450, 515, 532, 535, 540, 540A, 540B, 545, 545A, 3550, 4500	Toplink Assembly Cat I & II, 3/4" & 1" Holes	AMD6NN576C	\$ 97.35	
2000 (1965 and Later, w/ 3 Cylinder Engine), (2600, 3000, 3600, 3600N - 1975 and Later), 2610 1981-04/83, (3610, 3610N - 1981-82)	Hydraulic Lift Rocker	AME0NN535AA	\$ 75.00	
2N, 8N, 9N, 800, 900, (2000, 4000 w/ 4 Cylinder Engines, Hi-Clearance)	Toplink Bracket	AMNCA535A	\$ 60.00	
2000, 2310, 2600, 2610, 3000, 3600, 3610, 4000SU, 4600SU, 4610SU	Toplink Bracket Replaces E0NN535AA	AMC7NN535C	\$ 60.00	
2000 w/ 3 Cylinder Engines, 2600 - 1975 and Later	Toplink Bracket	AMC7NN535B	\$ 55.00	
2810, 2910, 3000 1965 and Later, 3055, 3600 1975 and Later, 3610 1981 thru 1982, 3910, 4000 3 Cylinder 1965 and Later, 4100, 4110, 4610 1981 and Later, 4610SU, Ind/Utility: 340, 340A, 340B, 445, 445A, 450, 540, 540A, 540B, 545, 545A, 3550, 4400, 4500	Toplink Bracket	AME2NN535BA	\$ 110.00	

Ford® / New Holland®—Tractor

Battery Box Components

Application	Description	Part Number	Retail Price	Core
8N	Battery Box	AM8N10732	\$ 40.00	
	Battery Hold Down	AMNCA10718A	\$ 4.62	
9N, 600, 700, 800, 900, 2000, 4000, Jubilee, NAA	Battery Box Primer Coated, Ready for Paint For 6 Volt Battery	AMC0NN10732T	\$ 57.60	
501, 541, 600, 601, 611, 620, 621, 630, 631, 640, 641, 650, 651, 660, 661, 671, 681, 700, 701, 740, 741, 771, 800, 801, 811, 820, 821, 840, 841, 850, 851, 861, 871, 900, 901, 941, 950, 951, 960, 971, 981, (2000, 4000 - w/ 4 Cylinder Engine), 2031, 2111, 2120, 2130, 2131, 4031, 4120, 4121, 4130, 4131, NAA, NAB, Ind/Const: 1801, 1811, 1821, 1841, 1871, 1881, 2030, 2130, 4030, 4040, 4140	Battery Tray For 6 Volt Battery	AMC0NN10732	\$ 45.00	
2000, 2100, 2110, 2300, 2310, 2600, 2610, 2810, 2910, 3000, 3055, 3100, 3110, 3120, 3150, 3300, 3310, 3330, 3400, 3500, 3600, 3610, 3900, 3910, 4000, 4100, 4110, 4140, 4200, 4330, 4340, 4400, 4410, 4500, 4600, 4600SU, 4610, 4610SU, 5000, 5100, 5110, 7810 - 1965-01/31/67 w/ Diesel Engine	Battery Tray 19.75" x 9" Overall Dimensions Replaces 81814352, C5NN10723A, C5NN10723B	AMC5NN10723H	\$ 82.00	



Side Panels and Hoods

Panels are painted with a primer coat unless otherwise noted.

Application	Description	Part Number	Retail Price	Core
2N, 8N, 9N	Side Panel	Right Hand	AM8N16618A-R	\$ 85.00
		Left Hand	AM8N16618A-L	\$ 85.00
600, 800, 900, NAA	Side Panel	Right Hand	AMC3NN16653A	\$ 134.00
		Left Hand	AMC3NN16652A	\$ 134.00
8N	Hood	AM8N16612	\$ 417.48	
2000, 2100, 2110, 2120, 2300, 2310, 3000, 3055, 3100, 3110, 3120, 3300, 3310, 3330, 3400, 3500, 3550, 4000, 4100, 4110, 4140, 4330, 4340, 4400, 4410, 4500, 7000, 7100, 7200	Hood 31" Long	Right Hand	AMC5NN16625F	\$ 65.00
6600, 6610	Hood Replaces C5NN16626J, C7NN16626C	Left Hand	AMD5NN16626	\$ 80.00



Front Grilles, Nose Cones and Components

Application	Description	Part Number	Retail Price	Core
2N, 8N, 9N	Grille	AM8N8204	\$ 54.00	
231, 233, 333, 335, 515, 531, 532, 2600, 2600N, 2600R, 2600V, 3600, 3600N, 3600NO, 3600R, 3600V, 3900, 4100, 4600, 4600D, 4600U, 4600SU, 5600, 6600, 6600C, 6600D, 7600, 7600C	Grille 1-Piece	AMD5NN8200C	\$ 50.00	
2600, 3600, 3900, 4100, 4600, 5600, 6600, 7600	Grille	AMD5NN8200A	\$ 30.00	
2000, 3000, 4000, 5000 Series	Upper Front Grille, Plastic	AMC9NN8A163AG	\$ 21.00	
2000, 4000 - w/ 4 Cylinder Engine	Front Grille	AMC3NN8200A	\$ 86.00	
2000, 3000, 4000, 5000 Series - 01/1965-12/74	Lower Front Grille, Plastic Replacement lower grille section for tractors w/ external headlights	AMD1NN8151A	\$ 18.00	
2310, 2610, 2810, 2910, 3610, 3910, 4110, 4910, Ind: 230A, 335, 530A	Nose Cone Ref# E4NN6A858AA	AME4NN16A858AA	\$ 200.00	

Ford® / New Holland®—Tractor

Application	Description	Part Number	Retail Price	Core
231, 233, 333, 531, 2000, 2600, 3000, 3600, 4100	Bumper Axle Mount	AMD8NN17750AA	\$ 245.00	
5610, 5700, 6610, 6700, 6710, 7410, 7610, 7700, 7710, 7810, 7810O, 7910, 8000, 8210, 8530, 8630, 8700, 9000, 9700, TW5, TW10, TW15, TW20	Outer Grille Screen, Right Hand Outer Grille Screen, Left Hand Replaces 83909848	AMD5NN8150A AMD5NN8151A	\$ 70.78 \$ 102.08	

Fenders and Components

Fenders are painted with a primer coat unless otherwise noted.







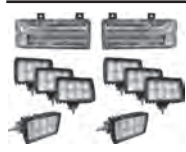

Application	Description	Part Number	Retail Price	Core
2N, 8N, 9N, NAA	Fender w/ Bracket Right or Left Hand	AMC0NN16312A	\$ 152.88	
	Fender w/o Bracket, Skin Only Right or Left Hand	AMC0NN16312SK	\$ 121.41	
601, 611, 621, 631, 641, 651, 661, 671, 681, 801, 811, 821, 841, 851, 861, 871, 881, 2000, 2031, 2150, 2300, 2310, 2600, 2610, 2810, 2910, 3000, 3100, 3110, 3120, 3150, 3230, 3300, 3310, 3330, 3400, 3430, 3500, 3600, 3610, 3900, 3910, 3930, 4000, 4000SU, 4030, 4031, 4120, 4121, 4131, 4400, 4500, 4600, 4600SU, 4610	Fender w/ Bracket, Clam Shell Right or Left Hand	AMC5NN16312AK	\$ 125.00	
2600, 2610, 2810, 2910, 3600, 3610, 3910, 3930, 4100, 4110, 4600, 4610, 4630, 4830, 5030, 5600, 5610, 6600, 6610, 7600, 7610, Ind: 515, 532, 535	Fender, Flat Top Right Hand	AMD8NN16312ABB	\$ 217.00	
	Fender, Flat Top Left Hand	AME5NN16313DA	\$ 210.00	
	Bracket Fits Right or Left Hand	AMD3NN16N319A	\$ 143.50	







Lighting

Application	Description	Part Number	Retail Price	Core
8N, 600, 620, 630, 640, 650, 660, 700, 740, 800, 820, 840, 850, 860, 900, 950, 960, Jubilee, NAA, NAB	Light Bulb, Sealed Beam 4 1/2" Diameter Round Bulb Dimpled Lens 6 Volt	AM8N15514	\$ 24.00	
 Versatile®: 190, 220, 250, 260, 285, 290, 305, 310, 340, 375, 400, 405, 435, 535, 550, 575	LED Floodlight Conversion Kit (2) 6.50" x 4.50" Oval Lights, Each Light is 5000 Lumens, 60 Watts, 5 Amps For 12 Volt to 24 Volt Systems Includes Mounting Brackets, Stainless Steel Hardware and Wiring Harness (Plug-and-Play)	AMTL8320-KIT	\$ 350.00	
 8670, 8670A, 8770, 8770A, 8870, 8870A, 8970, 8970A, Versatile®: 2145, 2160, 2180, 2210	LED Light Kit Includes Right Hand and Left Hand LED Headlight**, (2) Cab Mount LED Floodlights*, (6) Cab/Fender Mount LED Floodlights*, Connectors and Stainless Steel Mounting Hardware For 12 Volt to 24 Volt Systems Uses Original Mount and Wiring *3600 Lumens, 40 Watts, 3.30-3.33 Amps **8200 Lumens, 90 Watts, 7.50 Amps	AMX34162	\$ 1100.00	





Ford® / New Holland®—Tractor

Application	Description	Part Number	Retail Price	Core
 <p>T6020, T6040, T6060, T7030, T7040, T7050, T7060, TG210, TG215, TG230, TG245, TG255, TG275, TG285, TG305, TS100A, TS110A, TS115A, TS125A, TS130A, TS135A Replaces 82031075</p>	<p>LED Upper Cab Light 6" x 3" x 2.50" Rectangle Light 3000 Lumens, 40 Watts, 3.33 Amps For 12 Volt to 24 Volt Systems Due to cab variations, please verify correct part number before ordering</p>	AMTL7040	\$ 90.00	
	<p>LED Upper Cab Light 6" x 3" x 2.50" Rectangle Light 3000 Lumens, 40 Watts, 3.33 Amps For 12 Volt to 24 Volt Systems Due to cab variations, please verify correct part number before ordering</p>	AM82031078	\$ 72.00	
 <p>2310, 2600, 2610, 2810, 2910, 3600, 3610, 3910, 3930, 4200, 4600, 4600SU, 4610, 5200, 5600, 5610, 5900, 6600, 6610, 7000, 7200, 7600, 7610 Replaces D9NN13005CA, D4NN13002C</p>	<p>LED Trapezoid Light Fender Mount 4.50" Sealed Beam Round Light 2800 Lumens, 40 Watts, 3.30 Amps For 12 Volt to 24 Volt Systems Rear Stud Mount w/ Built-In Heat Sink Includes Both Long and Short Rubber Bezels</p>	AMTL2060	\$ 95.00	
	<p>Headlight Sealed Beam, 12 Volt, 2-Wire</p>	AMRE25126	\$ 45.00	
 <p>8670, 8670A, 8770, 8770A, 8870, 8870A, 8970, 8970A, Versatile®/Buhler®: 2145, 2160, 2180, 2210</p>	<p>LED Headlight, Right Hand Hi/Low Beam and Side Beam 8200 Lumens, 90 Watts, 7.50 Amps For 12 Volt to 24 Volt Systems Uses Original Mount and Wiring Replaces 86514346, 86514347</p>	AMTL8970R	\$ 225.00	
	<p>LED Headlight, Left Hand Hi/Low Beam and Side Beam 8200 Lumens, 90 Watts, 7.50 Amps For 12 Volt to 24 Volt Systems Uses Original Mount and Wiring Replaces 86514348, 86514349</p>	AMTL8970L	\$ 225.00	
 <p>2310, 2600, 3600, 4000, 4100, 4200, 4600, 5000, 5200, 5600, 5900, 6600, 6700, 7000, 8600, 8700, 9000, 9700</p>	<p>Halogen Floodlight, Sealed Beam 4.50" Diameter Round Light 2-Terminal Connection For 12 Volt Systems Replaces A47179, AR104119, E3NN15330AA</p>	AMH7606	\$ 13.25	
 <p>Universal Equipment</p>	<p>LED Floodlight All-Position Light 5" Round Light 3200 Lumens, 40 Watts, 3.30 Amps For 12 Volt to 24 Volt Systems Includes Mounting Bracket and Stainless Steel Hardware</p>	AMTL180	\$ 89.00	
 <p>Universal Equipment</p>	<p>LED Floodlight All-Position Light 4.25" x 4.25" Square Light 2650 Lumens, 48 Watts, 4 Amps For 12 Volt to 24 Volt Systems Includes Mounting Bracket and Stainless Steel Hardware</p>	AMTL105F	\$ 95.00	
 <p>Universal Equipment</p>	<p>LED Floodlight All-Position Light 6.25" x 1.75" Rectangle Light 1300 Lumens, 18 Watts, 1.50 Amps For 12 Volt to 24 Volt Systems Includes Mounting Bracket and Stainless Steel Hardware</p>	AMTL118F	\$ 50.00	







Ford® / New Holland®—Tractor

Application	Description	Part Number	Retail Price	Core
 Universal Equipment	LED Floodlight All-Position Light Round Light 6900 Lumens, 50 Watts, 4.10 Amps For 9 Volt to 32 Volt Systems Includes Mounting Bracket and Stainless Steel Hardware	AMTL500F	\$ 120.00	
	LED Floodlight All-Position Light 4.30" Round Light 5040 Lumens, 50 Watts, 4.10 Amps For 12 Volt to 24 Volt Systems Includes Stainless Steel Adjustable Mounting Bracket	AMAT305931	\$ 96.00	
 Universal Equipment	LED Floodlight All-Position Light 4.25" Round Light 2650 Lumens, 42 Watts, 3.50 Amps For 12 Volt to 24 Volt Systems Includes Mounting Bracket and Stainless Steel Hardware	AMTL115F	\$ 59.00	
Universal Equipment	LED Wide Floodlight All-Position Light 5" x 7" Rectangle Light 3800 Lumens, 35 Watts For 12 Volt to 24 Volt Systems	AMX34171	\$ 60.00	
 Universal Equipment	LED Floodlight, Sealed Beam Fender Mount 4.50" Diameter Round Light 1250 Lumens, 18 Watts, 1.50 Amps Trapezoid Pattern For 12 Volt to 24 Volt Systems	AMTL3010	\$ 40.00	
	LED Floodlight Fender Mount 4.50" Diameter Sealed Beam Round Light 1250 Lumens, 18 Watts, 1.20 Amps Trapezoid Pattern For 12 Volt to 24 Volt Systems Lasts 50 times longer than halogen lighting, vibration resistant w/ no filament failures, uses original mount and wiring, Operating temperature of -40°F to 140°F / -40°C to 60°C	AMRE336111	\$ 35.00	
 Universal Equipment	LED Floodlight Fender Mount 4.50" Diameter Sealed Beam Round Light 1440 Lumens, 18 Watts, 1.60 Amps Lasts 50 times longer than halogen lighting, vibration resistant w/ no filament failures, 2-terminal connection, Operating temperature of -40°F to 140°F / -40°C to 60°C	AMRE336112	\$ 67.75	
 T8010, T8020, T8030, T8040, T8050, T8.275, T8.300, T8.320, T8.330, T8.350, T8.360, T8.380, T8.390, T8.410, T8.420, T8.435, TG210, TG215, TG230, TG245, TG255, TG275, TG285, TG305	LED Floodlight Fender Mount w/ Hollow Bolt 6" x 3.50" Rectangle Light 3600 Lumens, 40 Watts, 3.33 Amps For 12 Volt to 24 Volt Systems Uses Original Wiring Includes Deutsch Connector, Mounting Bracket and Stainless Steel Hardware	AMTL3085	\$ 90.00	
 Universal Equipment	LED Floodlight Cab and Fender Mount 3.50" x 6" Rectangle Light 3600 Lumens, 40 Watts, 3 Amps	AMX34146	\$ 65.00	



Ford® / New Holland®—Tractor

Application	Description	Part Number	Retail Price	Core
 8670, 8670A, 8770, 8770A, 8870, 8870A, 8970, 8970A	LED Floodlight Cab Mount 3.50" x 6.00" Rectangle Light 3600 Lumens, 40 Watts, 3 Amps Post on Side Deutsch Connector	AM9846126	\$ 90.00	
 8670, 8670A, 8770, 8770A, 8870, 8870A, 8970, 8970A	LED Floodlight Cab Mount 6" x 3" Rectangle Light 3600 Lumens, 40 Watts, 3.33 Amps For 12 Volt to 24 Volt Systems Uses Original Mount and Wiring Includes Deutsch Connector, Mounting Bracket and Stainless Steel Hardware Replaces 9824851	AMTL3050	\$ 90.00	
 Versatile®: 190, 220, 250, 260, 290, 300, 305, 310, 320, 335 Replaces 86038024	LED Floodlight Hood Mount 5.50" x 3.75" Oval Light 3000 Lumens, 35 Watt, 2.90 Amps For 12 Volt to 24 Volt Systems Use Original Mount and Wiring, Plug-and-Play	AMTL8220	\$ 115.00	
	LED Floodlight Hood Mount 5.50" x 3.75" Oval Light 3000 Lumens, 39 Watts, 2.90 Amps For 12 Volt to 25 Volt Systems Includes Connector for Plug-and-Play Installation Replace 86038024, RE180613, RE181282, RE271573	AMRE271574	\$ 92.00	
 T8010, T8020, T8030, T8040, T8050, TG210, TG215, TG230, TG245, TG255, TG275, TG285, TG305	LED Floodlight Side Mount 6" x 3.50" x 3" Rectangle Light 3600 Lumens, 40 Watts, 3.30 Amps For 12 Volt to 24 Volt Systems Requires Splicing into Original Wiring	AMTL3075	\$ 90.00	
 T8010, T8020, T8030, T8040, T8050, TG210, TG215, TG230, TG245, TG255, TG275, TG285, TG305, TJ275, TJ325, TJ425, TJ450, TJ500 Replaces 87435762, 87773385	LED Floodlight Lower Front, Cab, Fender and ROPS 6" x 3.50" x 6" Rectangle Light 3600 Lumens, 40 Watts, 3.30 Amps For 12 Volt to 24 Volt Systems Includes Connector, Plug-and-Play	AMTL3030	\$ 90.00	
	LED Floodlight Lower Front, Cab, Fender and ROPS 6" x 3.50" x 6" Rectangle Light 3600 Lumens, 40 Watts, 3.30 Amps For 12 Volt to 24 Volt Systems Includes Connector, Plug-and-Play	AM92269C1	\$ 72.00	





Ford® / New Holland®—Tractor

Application	Description	Part Number	Retail Price	Core
 Versatile®: 190, 220, 250, 260, 285, 290, 305, 310, 340, 375, 400, 405, 435, 535, 550, 575	LED Floodlight Upper Front and Rear Cab, Rear Fender and Mid Mount 6.50" x 4" Oval Light 5200 Lumens, 65 Watts, 5.40 Amps For 12 Volt to 24 Volt Systems Housing Has Powder Coat Finish Includes Mounting Bracket and Stainless Steel Hardware	AMTL5680	\$ 125.00	
	LED Floodlight Upper Front and Rear Cab, Rear Fender and Mid Mount 6.50" x 4" Oval Light 5500 Lumens, 65 Watts For 12 Volt to 24 Volt Systems Housing Has Powder Coat Finish Includes Connector and Bracket for Plug-and-Play Installation	AMAH212523	\$ 100.00	
 5640, 6640, 6640O, 7740, 7740O, 7840, 7840O, 8160, 8240, 8260, 8340, 8360, 8560, TM115, TM120, TM125, TM130, TM135, TM140, TM150, TM155, TM165, TM175, TM190, TV140	LED Floodlight/Spotlight Combo Grille Mount 6" x 4" Rectangle Light 3500 Lumens, 60 Watts, 5 Amps For 12 Volt to 24 Volt Systems Includes Mounting Bracket and Stainless Steel Hardware	AMTL7740	\$ 110.00	
	LED Floodlight/Spotlight Combo Grille Mount 6" x 4" Rectangle Light, 3500 Lumens, 60 Watts, 5 Amps For 12 Volt to 24 Volt Systems Includes Mounting Bracket and Stainless Steel Hardware	AMF0NN1305AB	\$ 99.00	
 TS90, TS100, TS110, TS115	LED Floodlight/Spotlight Combo Hood Mount 6" x 4" Rectangle Light 3500 Lumens, 60 Watts, 5 Amps For 12 Volt to 24 Volt Systems Includes Connector, Mounting Brackets and Stainless Steel Hardware	AMTL6070	\$ 110.00	
 Universal Equipment	LED Spotlight All-Position Light 4.25" x 4.25" Square Light 1400 Lumens, 27 Watts, 2.20 Amps For 12 Volt to 24 Volt Systems	AMTL100S	\$ 45.00	
 Universal Equipment	LED Spotlight All-Position Light 6.25" x 1.75" Rectangle Light 1300 Lumens, 18 Watts, 1.50 Amps For 12 Volt to 24 Volt Systems Includes Mounting Bracket and Stainless Steel Hardware	AMTL118S	\$ 50.00	
 Universal Equipment	LED Spotlight All-Position Light Round Light 6900 Lumens, 50 Watts, 4.10 Amps For 9 Volt to 32 Volt Systems Includes Mounting Bracket and Stainless Steel Hardware	AMTL500S	\$ 120.00	





Ford® / New Holland®—Tractor

	Application	Description	Part Number	Retail Price	Core
	Universal Equipment	LED Trapezoid Light Cab and Fender Mount 4.50" Diameter Round Light 2800 Lumens, 40 Watts, 3.30 Amps Trapezoid Pattern For 12 Volt to 24 Volt Systems Bottom Mount w/ Built-In Heat Sink Includes Mounting Bracket, Long and Short Rubber Bezels and Stainless Steel Hardware	AMTL2080	\$ 95.00	
		LED Trapezoid Light Cab and Rear Fender Mount 4.50" Diameter Round Light 2800 Lumens, 40 Watts, 3.30 Amps Trapezoid Pattern For 12 Volt to 24 Volt Systems Bottom Mount w/ Built-In Heat Sink Includes Mounting Bracket, Long and Short Rubber Bezels and Stainless Steel Hardware	AMX33121	\$ 76.00	
	233, 333, 2000, 2100, 2110, 2120, 2150, 2300, 2310, 2600, 2600N, 2600R, 2600V, 3000, 3055, 3100, 3110, 3120, 3150, 3300, 3310, 3330, 3400, 3500, 3550, 3600, 3600N, 3600NO, 3600R, 3600V, 3900, 4000, 4100, 4110, 4140, 4200, 4330, 4340, 4400, 4410, 4500, 4600, 4600NO, 4600O, 4600SU, 5000, 5100, 5200, 5340, 5600, 5700, 6600, 6600C, 6600O, 6700, 6710, 7000, 7100, 7200, 7600, 7600C, 7700, 7710, 7910, 8000, 8210, 8600, 8700, 9000, 9600, 9700, TW5, TW10, TW15, TW20, TW25, TW30, TW35	LED Trapezoid Light Fender Mount 4.50" Sealed Beam Round Light 2200 Lumens, 24 Watts, 2 Amps For 12 Volt to 24 Volt Systems Uses Original Mount and Wiring Replaces RE336111	AMTL3015	\$ 50.00	
	8670, 8670A, 8770, 8770A, 8870, 8870A, 8970, 8970A, Versatile®: 2145, 2160, 2180, 2210	LED Warning Light, Right Hand Cab Mount 4.75" x 3.25" x 2.50" Rectangle Light Amber Lens, 7 Watts, 0.60 Amp For 12 Volt to 24 Volt Systems Includes Stainless Steel Hardware Replaces 86507530	AMTL7015R	\$ 50.00	
		LED Warning Light, Left Hand Cab Mount 4.75" x 3.25" x 2.50" Rectangle Light Amber Lens, 7 Watts, 0.60 Amp For 12 Volt to 24 Volt Systems Includes Stainless Steel Hardware Replaces 86507530	AMTL7015L	\$ 50.00	



Ford® / New Holland®—Tractor

Application	Description	Part Number	Retail Price	Core
 <p>9184, 9280, 9282, 9384, 9480, 9482, 9484, 9680, 9682, 9684, 9880, 9882, 9884</p>	LED Warning Light Cab Mount 3.15" x 6.75" Rectangle Light 9 Watts, 0.75 Amp For 12 Volt to 24 Volt Systems Replaces 92260C1, 107324C91, 130882C91, 216044C91, 216044C92, 9706415, 83977683, 86012669, 86014019, 86016518, 86023276, 87053368	AMX34180	\$ 50.00	
	LED Warning Light Cab Mount 3.15" x 6.75" Rectangle Light 9 Watts, 0.75 Amps For 12 Volt to 24 Volt Systems Replaces 92260C1, 107324C91, 130882C91, 216044C91, 216044C92, 9706415, 83977683, 86012669, 86014019, 86016518, 86023276, 87053368	AM92185C1	\$ 40.00	
T9020, T9030, T9040, T9050, T9060, TJ275, TJ280, TJ325, TJ330, TJ375, TJ380, TJ425, TJ430, TJ450, TJ480, TJ500, TJ530	Warning Light, Side Marker Amber Lenses	AM367321A1	\$ 30.65	
 <p>Universal Equipment</p>	LED Warning Light Cab, Header or Swather Mount Can be used for Turn Signal, Brake or Running Lights 4.125" Diameter Round Light Double Sided, Amber Lenses 25 Bulbs per Side For 12 Volt to 24 Volt Systems	AMTLFL2	\$ 55.00	
	LED Warning Light Cab, Header or Swather Mount Can be used for Turn Signal, Brake or Running Lights 4.125" Diameter Round Light Double Sided, Amber Lenses 25 Bulbs per Side For 12 Volt to 24 Volt Systems	AMX1910149	\$ 44.00	
 <p>Universal Equipment</p>	LED Warning Light Cab, Header or Swather Mount Can be used for Turn Signal, Brake or Running Lights 4.125" Diameter Round Light Double Sided, Red and Amber Lenses 25 Bulbs per Side For 12 Volt to 24 Volt Systems	AMTLFL3	\$ 55.00	
	LED Warning Light Cab, Header or Swather Mount Can be used for Turn Signal, Brake or Running Lights 4.125" Diameter Round Light Double Sided, Red and Amber Lenses 25 Bulbs per Side For 12 Volt to 24 Volt Systems	AMX33126	\$ 44.00	
 <p>Universal Equipment</p>	LED Magnetic Warning Light All-Position Light 360° Flashing Light, Multiple Patterns 9.50" x 6.75" Rectangle Light Magnetic Base or Solid Mount For 12 Volt to 24 Volt Systems Includes Cigarette Lighter Adapter, Wiring and Switch	AMTL1100	\$ 170.00	

Ford® / New Holland®—Tractor

	Application	Description	Part Number	Retail Price	Core
	Universal Equipment	LED Magnetic Warning Light All-Position Light 360° Flashing Light, Multiple Patterns 14" x 6.75" Rectangle Light Magnetic Base or Solid Mount For 12 Volt to 24 Volt Systems Includes Cigarette Lighter Adapter, Wiring and Switch	AMTL1200	\$ 190.00	
	Universal Equipment	Warning Beacon 360° Flashing Beacon, Amber Lens For 0.9435" Diameter Pipe Replaces 84337818, AZ44705, AZ101891	AM82018390	\$ 45.64	
	Universal Equipment	LED Warning Beacon 360° Flashing Beacon 2.75" x 5.25" Light Polycarbonate Amber Lens and Housing For 12 Volt to 24 Volt Systems Includes Solid Mounting Pad and Stainless Steel Hardware	AMTL2100	\$ 30.00	
	Universal Equipment	LED Warning Beacon 360° Flashing Beacon, 3 Different Patterns 5" x 10" Light Amber Lens, 48 Watts, 4 Amps For 12 Volt to 24 Volt Systems Brackets Sold Separately	AMX33131	\$ 75.00	
	Universal Equipment	Warning Beacon Bracket	AMX33132	\$ 15.00	
	Universal Equipment	Warning Beacon Bracket	AMX33133	\$ 15.00	
	Universal Equipment	Warning Beacon Bracket	AMX33137	\$ 15.00	
	Universal Equipment	Warning Beacon Bracket	AMX33135	\$ 15.00	

Ford® / New Holland®—Tractor

Application	Description	Part Number	Retail Price	Core
 Universal Equipment	LED Light Bar 4" Long, 1260 Lumens, Cree Bulbs	AMLED4	\$ 45.00	
	LED Light Bar Flood/Spotlight Combo 10" Long, 5700 Lumens, 50 Watts, 4.20 Amps For 12 Volt to 24 Volt Systems Includes Mounting Bracket and Stainless Steel Hardware	AMTL10SRC	\$ 129.00	
	LED Light Bar Floodlight/Spotlight Combo 14" Long, 5400 Lumens, 72 Watts, 6 Amps Die Cast Aluminum Housing, Polycarbonate Lens For 12 Volt to 24 Volt Systems Includes Mounting Bracket and Heavy Duty Stainless Steel Hardware	AMTLB410C	\$ 150.00	
	LED Light Bar Floodlight/Spotlight Combo 30" Long, 13600 Lumens, 150 Watts, 12.50 Amps For 12 Volt to 24 Volt Systems Includes Mounting Bracket and Stainless Steel Hardware	AMTL30SRC	\$ 230.00	
	LED Light Bar 30" Long, 13860 Lumens, Cree Bulbs	AMLED30	\$ 130.00	
	LED Light Bar Floodlight/Spotlight Combo 40" Long, 17300 Lumens, 200 Watts, 16.70 Amps For 12 Volt to 24 Volt Systems Includes Mounting Brackets and Stainless Steel Hardware	AMTL40SRC	\$ 300.00	
	LED Light Bar 40" Long, 18200 Lumens, Cree Bulbs	AMLED40	\$ 160.00	
	LED Light Bar Floodlight/Spotlight Combo 42" Long, 14500 Lumens, 240 Watts, 19 Amps For 12 Volt to 24 Volt Systems Includes Mounting Bracket and Stainless Steel Hardware Replaces 1163691	AMTLB440C	\$ 250.00	
	LED Light Bar, Curved 50" Long, 21500 Lumens, Cree Bulbs	AMLED50C	\$ 190.00	
	 Universal Equipment	LED Magnetic Work Light All-Position Light 3.25" Square Floodlight 900 Lumens Magnetic Base Includes Lithium Ion Battery, Cigarette Lighter and DC Charger	AMTL2460	\$ 79.00
 2310, 2610, 2810, 2910, 3610, 3910, 3930, 4110, 4610, 4630, 4830, 5110, 5610, 6410, 6610, 6710, 6810, 7410, 7610, 7710, 8210, 8530, 8630, 8730, 8830, TW5, TW15, TW25, TW35, Ind/Const: 230A, 234, 250C, 260C, 334, 335, 340, 340A, 340B, 345C, 345D, 445, 445A, (445C, 445D, 545C, 545D w/o Cab), 450, 530A, 540, 540A, 540B, 545, 545A		Light Switch	AME3NN11654AA	\$ 14.75

Ford® / New Holland®—Tractor





Cab Components—Miscellaneous

Application	Description	Part Number	Retail Price	Core
8670, 8670A, 8770, 8770A	Reman Monitor Replaces 86025959, 86027424, 86027424R	AM84595297R	\$ 3880.00	\$ 250.00
T6030, T6050, T6070, T6080, T6090, T7030, T7040, T7050, T7060, T7070, T7.170, T7.185, T7.200, T7.210, T7.220, T7.235, T7.250, T7.260, T7.270	Reman Monitor Replaces 293255A3, 295133A5, 87668610	AM84604338R	\$ 1650.00	\$ 500.00
T8.275, T8.300, T8.320, T8.330, T8.350, T8.360, T8.380, T8.390, T8.410, T8.420, T8.435	Monitor Bracket Well-suited for use w/ multiple monitors, less restriction of operator's view improves safety. Assembly hardware and tray pad included, monitor mounting hardware not included.	AMSS3178	\$ 202.00	
T8.275, T8.300, T8.320, T8.330, T8.350, T8.360, T8.380, T8.390, T8.410, T8.420, T8.435	Monitor Bracket Well-suited for use w/ multiple monitors, less restriction of operator's view improves safety. Assembly hardware and tray pad included, monitor mounting hardware not included.	AMSS3192	\$ 180.00	
8160, 8260, 8360, 8560, TM115, TM120, TM125, TM130, TM135, TM140, TM150, TM155, TM165, TM175, TM190, (TS90, TS110 - Emissionised), TS100, TS115 Prior to 07/2003	Windshield Wiper Motor Replaces 82858505	AM82016930	\$ 210.00	
T6030, T6050, T6070, T6080, T7030, T7040, T7050, T7060	Cab Mount Isolator	AM87396965	\$ 78.00	









Cab Doors

Application	Description	Part Number	Retail Price	Core
3600, 4600, 4610, 5600, 5610, 6600, 6610, 6710, 7600, 7610, 7700, 7710, 7910, 8200, 8210, 8530, 8630, 8700, 8730, 8830, 9700, TW5, TW10, TW15, TW20, TW25, TW35	Door Molding Kits Sold in Pairs, w/ Blue Push Pins	AMX19105	\$ 195.00	





Glass

Application	Description	Part Number	Retail Price	Core
 T5040, T5050, T5060, T5070, TL70, TL80, TL80A, TL90, TL90A, TL100, TL100A	Front Windshield Glass	AM82002183	\$ 340.00	
 T6010, T6020, T6030, T6040, T6050, T6060, T6070, T6080, TS100A, TS110A, TS115A, TS125A, TS130A, TS135A	Front Windshield Glass Hinged	AM82032042	\$ 255.00	
 T6010, T6020, T6030, T6040, T6050, T6060, T6070, T6080, T6090, T7030, T7040, T7050, TS100A, TS110A, TS115A, TS125A, TS130A, TS135A	Front Windshield Glass Replaces 82030483	AM87304257	\$ 320.00	
 8670, 8670A, 8770, 8770A, 8870, 8870A, 8970, 8970A	Lower Windshield Glass, Right Hand Replaces 89827540	AM9827540	\$ 52.50	
	Lower Windshield Glass - Left Hand Replaces 89827539	AM9827539	\$ 57.00	
T6010, T6020, T6030, T6040, T6050, T6060, T6070, T6080, TS100A, TS110A, TS115A, TS125A, TS130A, TS135A	Lower Front Glass, Right Hand Replaces 82030487	AM87566891	\$ 128.00	
	Lower Front Glass, Left Hand Replaces 82030488	AM87566892	\$ 114.00	

Ford® / New Holland®—Tractor

Application	Description	Part Number	Retail Price	Core
T6010, T6020, T6030, T6040, T6050, T6060, T6070, T6080, T6090, T7030, T7040, T7050, T7060, T7070, TS100A, TS110A, TS115A, TS125A, TS130A, TS135A	Lower Front Glass, Right Hand Replaces 82030485	AM87304259	\$ 91.00	
	Lower Front Glass, Left Hand Replaces 82030486	AM87304261	\$ 118.00	
 233, 234, 333, 334, 2600, 2610, 3600, 3610, 3910, 4100, 4110, 4600, 4610, 5110, 5600, 5610, 5700, 6410, 6600, 6610, 6700, 6710, 6810, 7410, 7600, 7610, 7700, 7710, 7910, 8000 Series, 8210, 8700, 9000 Series, 9700, TW5, TW10, TW15, TW20, TW25, TW30, TW35	Wing Window Top: 20.75" Side: 29.00" & 24.25" Bottom: 29.25"	AMD5NN9425722B	\$ 83.50	
T8010, T8020, T8030, T8040, T8050, T8.275, T8.300, T8.320, T8.330, T8.350, T8.360, T8.380, T8.390, T8.410, T8.420, T8.435, TG210, TG215, TG230, TG245, TG255, TG275, TG285, TG305	Cab Glass, Right Hand Replaces 242536A5, 87773671	AM87417671	\$ 595.00	
 8670, 8670A, 8770, 8770A, 8870, 8870A, 8970, 8970A	Side Glass, Right Hand Hinged Replaces 9861002, 89861002	AM86521435	\$ 115.00	
(5610, 6640, 7740, 7840, 8240, 8340 - Prior to 10/1995), (8670, 8770, 8870, 8970 - 09/1993 and Later), 8670A, 8770A, 8870A, 8970A	Door Glass, Left Hand Replaces 83994233, 86508175, 89823599	AME9NN94032N18BB	\$ 184.00	
 T6010, T6020, T6030, T6040, T6050, T6060, T6070, T6080, T6090, T7030, T7040, T7050, T7060, TS100A, TS110A, TS115A, TS125A, TS130A, TS135A	Door Glass, Right Hand Replaces 82027356, 87528172	AM84280178	\$ 480.00	
 T8010, T8020, T8030, T8040, T8050, T8.275, T8.300, T8.320, T8.330, T8.350, T8.360, T8.380, T8.390, T8.410, T8.420, T8.435, TG215, TG245, TG275, TG305	Door Glass, Left Hand	AM344730A2	\$ 325.00	
 TS100A, TS110A, TS115A, TS125A, TS130A, TS135A	Door Glass, Left Hand Replaces 82027357, 87560786	AM87528171	\$ 410.00	
 5110, 5600, 5610, 6600, 6610, 6810, 7410, 7600, 7610, 7700, 7710, 7810, 7910, 8000, 8210, 8530, 8630, 8700, 8730, 8830, 9000, 9700, TW5, TW10, TW15, TW20, TW25, TW30, TW35	Upper Door Glass, Right or Left Hand Tinted Replaces 82015335, 82019226, D8NN9421410BA	AM83914255	\$ 62.00	
 8670, 8670A, 8770, 8770A, 8870, 8870A, 8970, 8970A	Rear Glass Replaces 9823602, 89823602	AM86002901	\$ 198.50	
 5640, 6640, 7740, 7840, 8240, 8340 - Prior to 06/1994 w/ SuperLux Cab	Rear Glass Replaces 81865244, 83995319	AMF0NN9442038BA	\$ 157.00	
 T6010, T6020, T6030, T6040, T6050, T6060, T6070, T6080, T6090, T7030, T7040, T7050, TS100A, TS110A, TS115A, TS125A, TS130A, TS135A	Rear Glass Replaces 82030887, 87663400	AM87744542	\$ 250.00	

Ford® / New Holland®—Tractor

Application	Description	Part Number	Retail Price	Core
 T8010, T8020, T8030, T8040, T8050, T8.275, T8.300, T8.320, T8.330, T8.350, T8.360, T8.380, T8.390, T8.420, T8.435, TG215, TG245, TG275, TG305	Rear Glass Tinted Replaces 242667A4	AM87309738	\$ 315.00	
 4635, 4835, 5635, (5640, 6640, 7740, 7840, 8240, 8340 - 11/1995 and Later w/ SuperLux Cab), 7635, (8160, 8260, 8360, 8560, TS90, TS100, TS110, TS115 - w/ D3814 Engine w/ SuperLux Cab)	Upper Rear Glass Replaces 5178304, 82005316, VPM7343	AM82016997	\$ 150.00	
 4835, 5635, 6635, 7635, 8160, 8260, 8360, 8560, T5040, T5050, T5060, T5070, TL70, TL70A, TL80, TL80A, TL90, TL90A, TL100, TL100A, TM115, TM120, TM125, TM130, TM135, TM140, TM155, TM165, TM175, TM190, TS90, TS100, TS110, TS115	Lower Rear Glass	AM82000485	\$ 27.00	
(T8010, T8020, T8030, T8040, T8050 BSN Z8RW08527), TG210, (TG215, TG245, TG275, TG305 BSN Z8RW08527), TG230, TG255, TG285	Weatherstrip For Cab Door	AM87534532	\$ 23.10	
T8.275, T8.300, T8.320, T8.330, T8.350, T8.360, T8.380, T8.390, T8.410, T8.420, T8.435, (T8010, T8020, T8030, T8040, T8050, TG215, TG245, TG275, TG305 ASN Z8RW08528)	Weatherstrip For Cab Door	AM84160023	\$ 23.10	
 T8.275, T8.300, T8.320, T8.330, T8.350, T8.360, T8.380, T8.390, T8.410, T8.420, T8.435, T8010, T8020, T8030, T8040, T8050, TG210, TG215, TG230, TG245, TG255, TG275, TG285, TG305	Weatherstrip For Rear Cab Window	AM87534532	\$ 23.10	

Gas Struts



Application	Description	Part Number	Retail Price	Core
8160, 8260, 8360, 8560, TM115, TM120, TM125, TM130, TM135, TM140, TM150, TM155, TM165, TV140, TV145, TV6070 Replaces 82007029	Gas Strut, Hood	AM82019392	\$ 25.00	
TD4020F, TD4030F, TD4040F	Gas Strut, Hood	AM5097656	\$ 39.36	
4835, 5635, 6635, 7635, TL70, TL80, TL80A, TL90, TL90A, TL100, TL100A	Gas Strut, Roof Hatch	AM82002925	\$ 19.00	
5110, 5610, 5640, 6410, 6610, 6640, 6710, 6810, 7610, 7710, 7740, 7810, 7840, 7910, 8210, 8240, 8340, 8530, 8560, 8630, 8730, 8830, TW5, TW15, TW25, TW35	Gas Strut, Roof Hatch	AM83949895	\$ 19.00	
8670, 8670A, 8770, 8770A, 8870, 8870A, 8970, 8970A, T8010, T8020, T8030, T8040, T8050, TG210, TG215, TG230, TG245, TG255, TG275, TG285, TG305	Gas Strut, Door	AM1280263C1	\$ 19.00	
T6000, T7000	Gas Strut, Door Left Hand	AM87374182	\$ 32.00	
TM120, TM130, TM140, TM155, TM175, TM190	Gas Strut, Door	AM82027922	\$ 19.00	
230A, 234, 334, 335, 530A, 1710, 1710O, 1910, 2310, 2610V, 2810, 2910, 3230, 3430, 3610, 3610V, 3910, 3910H, 3910N, 3910R, 3910V, 3930, 3930H, 3930N, 3930NO, 4110, 4110N, 4110NO, 4110O, 4110V, 4130, 4130N, 4130NO, 4610, 4610N, 4610NO, 4610O, 4610SU, 4610V, 4630, 4630N, 4630NO, 4630O, 4830, 4830N, 4830O, 5030, 5030O, 5110, 5610, 6410, 6610, 6610O, 6710, 6810, 7410, 7610, 7610O, 7710, Ind: 45D, 545D	Gas Strut, Rear Window Replaces 3038161M91, 3476187M1, 83932024	AME2NN9444000AA	\$ 15.50	

Ford® / New Holland®—Tractor

Application	Description	Part Number	Retail Price	Core
2310, 2610, 2810, 2910, 3430, 3610, 3910, 3930, 4110, 4130, 4610, 4630, 4830, 5030, 5110, 5610, 6410, 6610, 6710, 6810, 7410, 7610	Gas Strut, Rear Window	AM83932028	\$ 35.00	
4835, 5635, 5640, 6635, 6640, 7635, 7740, 7840, 8160, 8240, 8340, 8360, 8560, TL65, TL70, TL80, TL90, TL100, TM115, TM120, TM125, TM130, TM135, TM140, TM150, TM155, TM165, TM175, TM190, TS90, TS100, TS110, TS115 Replaces 81865239, F0NN9444000BA	Gas Strut, Rear Window	AM82019393	\$ 19.00	
5110, 5610, 6410, 6610, 6710, 6810, 7610, 7710, 7810, 7910, 8210, 8530, 8630, 8730, 8830, TW5, TW15, TW25, TW35	Gas Strut, Rear Window	AME4NN9444000AA	\$ 15.00	
T2310, T2320, T2410, T2420, TC40DA, TC45DA	Gas Strut, Rear Window	AM84320293	\$ 19.00	
T6010, T6020, T6030, T6040, T6050, T6060, T6070, T6080, T7030, T7040, T7050, T7060, TS100A, TS115A, TS125A, TS130A, TS135A	Gas Strut, Rear Window	AM82022486	\$ 19.00	



Fuel Tanks

Application	Description	Part Number	Retail Price	Core
2N, 8N, 9N	Fuel Tank, Metal	AM9N9002	\$ 183.33	
600, 620, 630, 640, 650, 660, 700, 740, 800, 820, 840, 850, 860, 900, 950, 960, NAA, NAB	Fuel Tank For gas models only unless return line has been added for diesel models Tank has option for fuel sender, must be purchased separately Use w/ AM311292 Valve in the bottom of the tank	AMNAA9002E	\$ 220.00	
	Fuel Shut Off Valve	AM311292	\$ 40.16	
600, 800, 900, (2000, 4000 - w/ 4 Cylinder Engines), NAA	Fuel Tank, Metal Only Flat Bottom	AMNAA600	\$ 184.00	











Steering Wheels and Caps









Application	Description	Part Number	Retail Price	Core
8N, 231, 233, 234, 333, 334, 335, 340, 501, 515, 531, 532, 535, 541, 600, 601, 611, 620, 621, 630, 631, 640, 641, 650, 651, 660, 671, 681, 700, 701, 740, 741, 771, 800, 801, 811, 820, 821, 840, 841, 850, 851, 860, 861, 871, 881, 900, 901, 941, 950, 951, 961, 971, 981, 2000, 2120, 2130, 2310 All Purpose, 2600, 2610, 2810, 2910, 3000, 3110, 3120, 3230, 3300, 3310, 3330, 3400, 3430, 3600, 3610, 3900, 3910, 3930, 4000, 4110, 4120, 4130, 4140, 4330, 4340, 4400, 4410, 4600, 4610, 4630, 4830, 5000, 5030, 5100, 5110, 5340, 5600, 5610, 5900, 6600, 6610, 7000, 7600, 7610, NAA, NAB, (2100, 2110 - w/ Power Steering), (2300, 2310 Narrow - w/ Manual Steering)	Steering Wheel 36 Spline, 18" Diameter, 0.785" Hub Diameter	AMD6NN3600B	\$ 20.00	
8N, 600, 700, 800, 900, (2000, 4000 w/ 4 Cylinder Engines), NAA, Jubilee	Steering Wheel 17 5/8" Diameter, 36 Spline Hub, 11/16" Shaft	AM8N3600	\$ 25.00	
9N, 2N (1939-47)	Steering Wheel 17 5/8" Diameter, Keyed Hub, 11/16" Shaft	AM180576M1	\$ 23.00	
1100, 1110, 1120, 1200, 1210, 1215, 1220, 1320, 1520, 1620, 1720, 1920, 2120, 3415, TC30, TC1510, TC1520	Steering Wheel 15 3/4" Diameter, 18 Spline Hub, 3 1/2" Shaft Replaces 66611-41400, SBA334300050, SBA334310110	AM32400-16800	\$ 64.00	
Major, Super Major	Steering Wheel 6-Spline Hub, 18" Diameter 3 Covered Spokes Replaces 81717476, E1ADKN3600A	AME1ADKN3600	\$ 25.00	

Ford® / New Holland®—Tractor











Air Conditioning and Components

Application	Description	Part Number	Retail Price
 5610, 6610, 6710, 6810, 7410, 7610	Compressor Conversion Kit Rotary Tecumseh HR980 to Sanden Includes Compressor, Mounting Bracket, Hoses, O-Rings and Mounting Hardware Requires Pag Oil 100V, 6.76 oz (200 cc)	AMX10189	\$ 520.00
	Ultra Pag Double End Capped, 100V, 8 oz	AMX10267	\$ 12.00
	Universal Pag Oil, 8 oz	AMX10274	\$ 8.25
 5700, 6700, 7700	Compressor Conversion Kit York to Sanden Includes Compressor, Mounting Brackets, Compressor Manifold, Hoses, O-Rings, Belt and Mounting Hardware Requires Pag Oil 100V, 6.76 oz (200 cc)	AMX10195	\$ 520.00
	Ultra Pag Double End Capped, 100V, 8 oz	AMX10267	\$ 12.00
	Universal Pag Oil, 8 oz	AMX10274	\$ 8.25
 5700, 6710, 8000, 8600, 8700, 9000	Compressor Conversion Kit York Style to Aftermarket Sanden Style Includes Compressor, Mounting Brackets, Compressor Manifold, O-Rings and Mounting Hardware See Manufacturer for Oil Type and Quantity	AMX10263	\$ 450.00
	Premium Synthetic Ester Oil, 100V, 12 oz	AMX10273	\$ 11.00
 6610, 6710, 7710	Compressor Conversion Kit Tecumseh, York Upright to Sanden Includes Compressor, Mounting Bracket, Compressor Manifold, Hoses and Mounting Hardware Requires Pag Oil 100V, 6.76 oz (200 cc)	AMX10194	\$ 520.00
	Ultra Pag Double End Capped, 100V, 8 oz	AMX10267	\$ 12.00
	Universal Pag Oil, 8 oz	AMX10274	\$ 8.25
 7710	Compressor Conversion Kit Rotary Tecumseh HR980 to Sanden Includes Compressor, Mounting Bracket, Hose, O-Rings and Mounting Hardware	AMX10190	\$ 520.00
	Compressor to Condenser Hose	AME9NN19N601CA	\$ 95.00
 7810	Compressor Conversion Kit Rotary Tecumseh HR980 Style to Seltec Style Includes Compressor, Mounting Bracket, Hose, O-Rings and Mounting Hardware	AMX10191	\$ 545.00
	Compressor to Condenser Hose	AME9NN19N601CA	\$ 95.00
 7910, 8210	Compressor Conversion Kit Rotary Tecumseh HR980 Style to Sanden Style Includes Compressor, Mounting Bracket, Hose, O-Rings and Mounting Hardware	AMX10192	\$ 545.00
	Compressor to Condenser Hose	AME9NN19N601CA	\$ 95.00
	Compressor Conversion Kit Tecumseh, York Upright to Sanden Includes Compressor, Mounting Bracket, Binary Switch, Hoses, O-Rings and Mounting Hardware For R134a Applications Requires Pag Oil 100V, 6.76 oz (200 cc)	AMX10193	\$ 520.00
 8700, 9700, TW5, TW10, TW15, TW20, TW25, TW30, TW35	Compressor to Condenser Hose	AME9NN19N601CA	\$ 95.00
	Ultra Pag Double End Capped, 100V, 8 oz	AMX10267	\$ 12.00
	Universal Pag Oil, 8 oz	AMX10274	\$ 8.25

Ford® / New Holland®—Tractor

Application	Description	Part Number	Retail Price
 8700, 9700, TW10, TW20, TW30	Compressor Conversion Kit Tecumseh, York Upright to Sanden Style Includes, Compressor, Mounting Bracket, Binary Switch, Hoses, O-Rings and Mounting Hardware For R12 Applications, Must use Original Belt Requires Pag Oil 100V, 6.76 oz (200 cc)	AMX10196	\$ 520.00
	Ultra Pag Double End Capped, 100V, 8 oz	AMX10267	\$ 12.00
	Universal Pag Oil, 8 oz	AMX10274	\$ 8.25
 TW5, TW15, TW25, TW35	Compressor Conversion Kit Rotary Tecumseh HR980 to Sanden Includes Compressor, Mounting Bracket, Binary Switch, Hose, O-Rings and Mounting Hardware Requires Pag Oil 100V, 6.76 oz (200 cc)	AMX10188	\$ 395.00
	Compressor to Condenser Hose	AME9NN19N601CA	\$ 95.00
	Ultra Pag Double End Capped, 100V, 8 oz	AMX10267	\$ 12.00
	Universal Pag Oil, 8 oz	AMX10274	\$ 8.25
 Versatile®: 750, 800, 825, 835, 850, 855, 875, 895, 900, 935, 950	Compressor Conversion Kit York Style to Sanden Style Single Groove Long Body Replacement Kit, Replaces York/Tecumseh Single Groove w/ 2.82" Gauge Line (measure from front side mounting hole to center groove of clutch on original York)	AMX10241	\$ 490.00
 5100, 5600, 5700, 6600, 6700, 7700, 8000, 8600, 8700, 9000, 9600, 9700	Compressor, York Style Right Hand Suction, Rotolock Clutch Not Included Requires Synthetic Ester Oil 100V, 9.50 oz (281 cc)	AM54-032	\$ 225.00
	Double Groove Clutch for York Compressor, 7"	AM470	\$ 101.00
	Premium Synthetic Ester Oil, 100V, 12 oz	AMX10273	\$ 11.00
 5600, 5700, 6600, 6700, 7600, 7700, Backhoes: 550, 555, 555A, 555B, 655, 655A, 755A, 755B, Versatile®: 700, 750, 800, 825, 835, 850, 855, 875, 895, 900, 935, 950 Replaces 130222, 618606, D2NN19D623A, D3NN19D623A	Compressor, York Style Left Hand Suction, Rotolock Clutch Not Included Requires Synthetic Ester Oil 100V, See Manufacturer for Oil Quantity	AMX10225	\$ 260.00
	Double Groove Clutch for York Compressor, 7"	AM470	\$ 101.00
	Premium Synthetic Ester Oil, 100V, 12 oz	AMX10273	\$ 11.00
 5640, 6640, 7740, 7840, 8240, 8340, TS90, TS100, TS110, TS115 - 11/1995 and Later Replaces 82008688, 82016157	Compressor, Sanden SD7H15 12 Volt, w/ Serpentine Belt, 4.68" (119 mm) Clutch Diameter, Vertical #8 and #10 O-Rings, w/o Charge Ports Requires Synthetic Ester Oil 100V, 5.46 oz (135 cc)	AMX10129	\$ 265.00
	Premium Synthetic Ester Oil, 100V, 12 oz	AMX10273	\$ 11.00
 5640, 6640, 7740, 7840, 8240, 8340 - 11/1991-03/94 Replaces F0NN19D629AB, F0NN19D629AA	Compressor, Sanden SD510 Style 12 Volt, w/ 8-Groove Clutch, 5.25" (133 mm) Clutch Diameter, w/o Charge Ports, Top Pad Mount Requires Synthetic Ester Oil 100V, 10.00 oz (300 cc)	AMX10127	\$ 225.00
	Premium Synthetic Ester Oil, 100V, 12 oz	AMX10273	\$ 11.00
 5640, 6640, 7740, 7840, 8240, 8340 Reff# F0NN19D629AA, F0NN19D629AB	Compressor, Sanden SD510 Style 12 Volt, With 6-Groove Clutch for Serpentine Belt, 4.90" (125 mm) Clutch Diameter, Top Pad Mount Aftermarket Requires R12 Mineral Oil, 6.12 oz (180 cc)	AMX10209	\$ 265.00
 7710, 7740, 7810, 7910, 8000, 8210, 8530, 8630, 8700, 8730, 8830, 9030, 9710, FW20, TW5, TW15, TW25, TW35	Compressor, Sanden SD7H15 Style 12 Volt, w/ 2-Groove Clutch, 5.19" (132 mm) Clutch Diameter, O-Ring Connections, w/o Charge Ports Requires Pag Oil 100V, 6.76 oz (200 cc)	AME8NN19D629AA	\$ 245.00
	Ultra Pag Double End Capped, 100V, 8 oz	AMX10267	\$ 12.00
	Universal Pag Oil, 8 oz	AMX10274	\$ 8.25

Ford® / New Holland®—Tractor

Application	Description	Part Number	Retail Price	
 8160, 8260, 8360, 8560, TM115, TM120, TM125, TM130, TM135, TM140, TM150, TM155, TM165, TM175, TM190, Versatile®: TV140, TV145 Replaces 82008689, 82002069	Compressor, Sanden SD7H15 Style 12 Volt, w/ 8-Groove Clutch for Serpentine Belt, 4.68" (119 mm) Clutch Diameter, Vertical #8 and #10 O-Ring Requires Synthetic Ester Oil 100V, 4.56 oz (135 cc) Premium Synthetic Ester Oil, 100V, 12 oz	AM82016158 AMX10273	\$ 265.00 \$ 11.00	
 8670, 8770, 8870, 8970 - 1993 and Later Replaces 9824775	Compressor w/ Dust Cover, Sanden 12 Volt, w/ Serpentine Clutch, 5.19" (132 mm) Clutch Diameter, Horizontal #8 and #10 O-Ring Requires Synthetic Ester Oil 100V, 9.13 oz (270 cc) Premium Synthetic Ester Oil, 100V, 12 oz	AMX10128 AMX10273	\$ 275.00 \$ 11.00	
 9030V, 9184, 9280, 9282, 9384, 9480, 9484, 9682, 9684, Versatile®: 2360, 2375	Compressor, Sanden SD7H15 12 Volt, w/ 2-Groove Clutch, 5.25" (133 mm) Clutch Diameter, Horizontal Tube O-Ring, w/o Charge Ports Requires Synthetic Ester Oil 100V, 10.14 oz (300 cc) Premium Synthetic Ester Oil, 100V, 12 oz	AMX10187 AMX10273	\$ 270.00 \$ 11.00	
 FW20 Replaces SFD351224T91	Compressor, Sanden SD508 Style 12 Volt, w/ 2-Groove Clutch, 5.19" (132 mm) Clutch Diameter, Vertical #8 and #10 Flare Fittings, w/ R12 Charge Ports Requires R12 Mineral Oil, 5.91 oz (175 cc)	AMX10178	\$ 255.00	
 (T4020, T4030, T4040, T4050 Deluxe), T4020V, T4030F, T4030N, T4030V, T4040F, T4040N, T4040V, T4050F, T4050N, T4050V, T4060F, T4060N, T4060V, T5040, T5050, T5060, T5070, (T4.65, T4.75 Non Tier 4A), T4.65V, T4.75F, T4.75V, T4.85F, T4.85V, T4.95F, T4.95V, T4.105F, T4.105V, TD5010, TD5020, TD5030, TD5050	Compressor, Sanden SD7H15 12 Volt, w/ 4-Groove Serpentine Clutch, 4.409" (112 mm) Clutch Diameter Requires Pag Oil 100V, 6.46 oz (190 cc) Ultra Pag Double End Capped, 100V, 8 oz Universal Pag Oil, 8 oz	AM87519620 AMX10267 AMX10274	\$ 275.00 \$ 12.00 \$ 8.25	
	T8010, T8020, T8030, T8040, T8050, T9030, T9040, T9050, T9060, T8.330, TG210, TG215, TG230, TG245, TG255, TG275, TG285, TG305, TJ375, TJ425, TJ450, TJ480, TJ500, TJ530 Replaces 504078610, 86992688, 87775469	Compressor, Sanden SD7H15HD 12 Volt, w/ 8-Groove Clutch, 5.98" (152 mm) Clutch Diameter, Horizontal Tube O-Ring, Direct Mount Requires Pag Oil 100V, 9.64 oz (285 cc) Ultra Pag Double End Capped, 100V, 8 oz Universal Pag Oil, 8 oz	AM86993463 AMX10267 AMX10274	\$ 275.00 \$ 12.00 \$ 8.25
	Versatile®: 700, 750, 800, 825, 835, 850, 855, 875, 895, 900, 935, 950	Compressor Clutch SCSA06C Clutch, 4.80" Coil w/ 1/2" Single Groove, Splined-Type Shaft	AM6A671-97310	\$ 170.00
 Universal Equipment	Low Pressure Switch Normally Open, Opens at 35 PSI, Closes at 46 PSI, Standard 7/16"x20 Thread	AMX10278	\$ 42.00	
 Universal Equipment	Low Pressure Switch Normally Open, Opens at 6 PSI, Closes at 45 PSI, Standard 7/16"x20 Thread	AMX10277	\$ 55.00	
 TG210, TG230, TG255, TG285, TJ425, TJ430, TJ450, TJ500	Low Pressure Switch Normally Open, Opens at 5 PSI, Closes at 18 PSI, 10 mm Metric Thread	AM87000228	\$ 45.00	
 Loaders: LV80, U80, U80B, U80C, W130C, W170C, W190C, W230C, W270C, W300C	Low Pressure Switch Normally Closed, Opens at 23 PSI, Closes at 7 PSI, 10 mm Metric Thread	AM122579A1	\$ 44.00	
 Universal Equipment	High Pressure Switch Normally Open, Opens at 305 PSI, Closes at 395 PSI, 7/16"x20 Thread	AMX10276	\$ 35.00	









Ford® / New Holland®—Tractor

	Application	Description	Part Number	Retail Price
	233, 333, 2600, 3600, 4100, 4600, 5110, 5600, 5610, 5700, 6410, 6600, 6610, 6700, 6710, 6810, 7410, 7600, 7610, 7610O, 7700, 7710, 7810, 7910, 8000, 8210, 8530, 8630, 8700, 8730, 8830, 9000, 9700, TW5, TW10, TW15, TW20, TW25, TW30, TW35	Rotary Adjustable Thermostatic Switch 19 1/2" Capillary Tube Replaces D6NN19N683B	AM87015296	\$ 68.26
	256, 276, 836, 7840, 8000, 8200, 8240, 8340, 8600, 8700, 9000, 9030, 9200, 9600, 9700, 9710 (Replaces D3NN19618A), Ind: 8400, Versatile®: 256, 276, 500, 555, 700, 750, 756, 800, 825, 835, 836, 850, 855, 856, 875, 876, 895, 900, 935, 945, 950, 955, 975, 1150, 1156, D6 (Replaces 9672323)	Rotary Adjustable Thermostatic Switch 36" Capillary Tube	AMX10251	\$ 45.00
	4835, 5635, 6635, 7635, T5040, T5050, T5060, T5070, TD60D, TD70D, TD75D, TD80D, TD90D, TD95D, TD5050, TL70, TL80, TL80A, TL90, TL90A, TL100, TL100A, TN60DA, TN60SA, TN70DA, TN70SA, TN75DA, TN75SA, TN85DA, TN95DA	Receiver Drier w/o High Pressure Switch	AM5165615	\$ 38.00
	Ford®/New Holland® Tractors: (5110, 5610, 6610, 6710, 6810, 7410, 7610, 7710 - 1981-85), (7910, 8210, TW5, TW15, TW25, TW35 - 1982-85), (8700, 9700, TW10, TW20, TW30 - 1981 and Later) Replaces E2NN19825AA, E0NN19825AA14L	Receiver Drier 4" x 9 1/2", Inlet - #6 Female O-Ring, Outlet - #6 Female O-Ring, R12 and R134a Compatible	AMX10157	\$ 38.00
	(5110, 5610, 6610, 6710, 6810, 7410, 7610, 7710, 7910, 8210 - 1985 and Later), 7810 1988 and Later, 8530, 8630, 8730, 8830, (TW5, TW15, TW25, TW35 - 1985 and Later) Replaces E4NN19825AB, E4NN19825AA	Receiver Drier 4" x 7 1/4", Inlet - #6 Male O-Ring, Outlet - #6 Male O-Ring, R12 and R134a Compatible	AMX10158	\$ 38.00
	5600, 5700, 6600, 6700, 7700, 8000, 8700, 9000, 9700, TW10, TW20, TW30 Replaces D6NN19N644B	Receiver Drier 4" x 7 1/2", Side Mount Bracket, R12 and R134a Compatible, Inlet: #8 Quick Coupler, 7/8"-20 Thread, Outlet: #6 Male O-Ring	AMX10179	\$ 28.00
	(5640, 6640, 7740, 7840, 8240, 8340 - 1991-95) Replaces F0NN19825AB, F0NN19825AC, 82000471	Receiver Drier 3" x 15", Inlet - #6, 3/8" Ford Springlock, Outlet - #6, 3/8" Ford Springlock, R12 and R134a Compatible	AMX10159	\$ 45.00
	(5640, 6640, 7740, 7840, 8240 8340 - 1995 and Later), 8160, 8260, 8360, 8560, TM115, TM125, TM135, TM150, TM165, TS90, TS100, TS110, TS115 Replaces 82007131, 82015699, 82012480	Receiver Drier 3" x 10", Inlet - #6 Male O-Ring, Outlet - #6 Female O-Ring, R12 and R134a Compatible	AMX10160	\$ 47.00
	8000, 8600, 9000, 9600 Replaces D3NN19825A	Receiver Drier 3" x 6" Male Flare, R12 and R134a Compatible	AMX10211	\$ 22.00











Ford® / New Holland®—Tractor

	Application	Description	Part Number	Retail Price
	8970A, 8670, 8670A, 8770, 8770A, 8870, 8970, 8870A Replaces 86508374	Receiver Drier 3" X 10", Inlet - #6 Male O-Ring, Outlet - #6 Female O-Ring R12 and R134a Compatible	AM86026354	\$ 45.00
	9030, 9030E, 9030V, Versatile®: 150, 276, 836, 846, 856, 876, 936, 946, 976 Replaces 9672494, 9827053	Receiver Drier 3" x 10 1/2" Male O-Ring, R12 and R134a Compatible	AMX10218	\$ 26.00
	9030V, 9280, 9282, 9384, 9480, 9482, 9680, 9682, 9684, 9880, 9882, 9884 Reference 9705765	Receiver Drier 3" x 9" Male O-Ring, Male Switch Port, R12 and R134 Compatible	AMX10205	\$ 26.00
	FW20, FW30, FW40, FW60 Replaces SFD605818T3	Receiver Drier 3" x 9 1/2" Male Flare, Male Switch Port, R12 and R134a Compatible	AMX10210	\$ 32.00
	B125A, T6010, T6020, T6030, T6040, T6050, T6060, T6070, T6080, T7030, T7040, T7050, T7060, TM115, TM120, TM125, TM130, TM135, TM140, TM150, TM155, TM165, TM175, TM190, TS100A, TS110A, TS115A, TS130A, TS135A, TV145 Replaces 87374420, 82023593, 87343822	Receiver Drier 2 1/2" x 6" Male and Female O-Ring, R12 and R134a Compatible	AMX10214	\$ 33.00
	Versatile®: (900, 700 1972-12/75), (800, 850 1973-12/75) Replaces V18395, V107619	Receiver Drier 3" x 8 1/4" Male Flare, Female Switch Port - OE Parker, R12 and R134a Compatible	AM72161835	\$ 30.00
	4635, 4835, 5635, 6635, 7635, T4050F, T4050V, T5030, T5040, T5050, T5060, T5070, T7510, T7520, T7530, T7540, T7550, TL70, TL70A, TL80, TL80A, TL90, TL90A, TL100, TL100A, TN55D, TN55S, TN60DA, TN60SA, TN65D, TN65S, TN65V, TN70D, TN70DA, TN70F, TN70S, TN70SA, TN75D, TN75DA, TN75F, TN75FA, TN75S, TN75SA, TN75V, TN80, TN80F, TN85DA, TN85FA, TN90F, TN95DA, TN95F, TN95FA, TN95VA Replaces 82002793	Expansion Valve Flange Type, O-Ring Connection, R12 and R134a Compatible	AMX10260	\$ 25.00
	5510 1985 and Later, (5600, 5700, 6600, 6700, 7700 1977 and Later), (5610, 7810 1988 and Later), (6610, 6710, 6810, 7410, 7610, 7710 1981 and Later), (7910, 8210, TW5, TW25, TW35 1982 and Later), (8000, 8600, 9000, 9600 1973 and Later), 8530, 8630, (8700, 9700, TW10, TW20 1976 and Later), 8730, 8830, TW15 1982 and Later, TW30 1976 and Later Replaces D3AH19849AA, D6AH19849AA, E7NN198499AA, 83906905, 83960933, 87022814	Expansion Valve Bulb Type, Externally Equalized, R12 and R134a Compatible, 28" Tube Length, O-Ring Connection	AMX10148	\$ 18.00











Ford® / New Holland®—Tractor

	Application	Description	Part Number	Retail Price
	(5640, 6640, 7740, 7840, 8240, 8340 - 1991 and Later), 8160, 8260, 8360, 8560, TM115, TM120, TM125, TM130, TM135, TM140, TM150, TM155, TM165, TM175, TM190, TS90, TS100, TS110, TS115 Replaces F0NN19849AB, 82000932	Expansion Valve Block Type, R12 and R134a Compatible, O-Ring Connection	AMX10149	\$ 39.00
	8670, 8670A, 8770, 8770A, 8870, 8870A, 8970, 8970A, T8010, T8020, T8030, T8040, T8050, T9020, T9030, T9040, T9050, T9060, TG210, TG215, TG230, TG245, TG255, TG275, TG285, TG305, TJ280, TJ330, TJ275, TJ325, TJ375, TJ380, TJ425, TJ430, TJ450, TJ500, TL70, TJ530, TJ480, TL80, TL90, TL100, TV145 Replaces 86505794	Expansion Valve Block Type, R12 and R134a Compatible, O-Ring Connection	AMX10150	\$ 26.00
	FW20, FW30, FW40, FW60 Replaces F3960933, 83906905, 83915986, 83972479	Expansion Valve Internally Regulated w/ 12" Capacity Tube w/ Flare Connection, R12 and R134a Compatible	AMX10215	\$ 30.00
	T6010, T6020, T6030, T6050, T6060, T6070, T6080, T6090, T7030, T7040, T7050, T7060, T7070, T7.165, T7.170, T7.175, T7.185, T7.190, T7.195S, T7.200, T7.210, T7.215S, T7.220, T7.225, T7.230, T7.235, T7.245, T7.250, T7.260, T7.270, T7.315, TM120, TM130, TM140, TM155, TM175, TM190, TS100A, TS110A, TS115A, TS130A, TS135A	Trinary Switch 7/16"x20 Female Thread Replaces 82019426, 87699591	AM84233818	\$ 56.00
	TV140, TV145, Backhoe-Loaders: 555D, 575D Replaces ABPN83308011, F1NN19849AA	Expansion Valve Block Type, R12 and R134a Compatible, O-Ring Connection	AMX10151	\$ 24.00
	(5640, 6640, 7740 - w/ Sanden Compressor), TS90, TS100, TS110, TS115	Return Line, Front Rubber Suction Hose Replaces Original Steel Line Replaces 82009874, 82013168, 82026275	AMX10283	\$ 65.00
	9280, 9282, 9480, 9482, 9880, 9882, 9884, TV140	Blower Motor Assembly	AM9705742	\$ 260.00
	TG210, TG215, TG230, TG245, TG255, TG275, TG285, TG305, TJ275, TJ280, TJ325, TJ330, TJ375, TJ380, TJ425, TJ430, TJ480, TJ500, TJ530, T9020, T9030, T9040, T9050, T9060	Blower Motor Assembly 12 Volt, Resistor Not Included Replaces 323610A1	AM84222524	\$ 150.00
	233, 333, 1118, 2600, 3600, 4100, 4600, 5110, 5600, 5610, 5700, 6600, 6610, 6700, 6710, 6810, 7410, 7600, 7610, 7700, 7710, (8000, 9000 - 10/1976 and Later), 8600, 8700 08/76-12/81, 9600, (9700, TW10, TW20, TW30 - 08/76-12/81) Replaces D5NN18527A	Blower Motor 3-Speed, Double Shaft, 4-Wire, Reversible, 3/8" Shaft Diameter, 4 1/4" Long	AMX10120	\$ 80.00

Ford® / New Holland®—Tractor

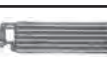

	Application	Description	Part Number	Retail Price
	2600, 3600, 4100, 4600, 5110, 5600, 5610, 5700, 6600, 6610, 6700, 6710, 6810, 7410, 7600, 7610, 7700, 7710, 7810, 7910, 8210, 8530, 8630, 8670, (8700, 9700, TW5, TW10, TW15, TW20, TW25, TW30, TW35 - 1982 and Later), 8730, 8830, 9184, 9280, 9282, 9384, 9480, 9482, 9484, 9680, 9682, 9684, 9880, 9882, 9884, Ind: 233, 333, Versatile®: 276V, 276V-II, 836V, 846V, 856V, 876V, 936V, 946V, 956V, 976V, 1156V, 9030E, 9030V Replaces 86010530	Blower Motor, Vented Single Speed, Double Shaft, 2-Wire, Reversible, 3/8" Shaft Diameter, 4 3/8" Long	AMX10118	\$ 108.00
	8670, 8670A, 8770, 8770A, 8870, 8870A, 8970, 8970A Replaces 86508360	Blower Motor Single Speed, Double Shaft, 2-Wire, Reversible, 5/16" Shaft Diameter, 3 5/8" Long	AMX10111	\$ 55.00
	500, 555, 700, 750, 800, 825, 835, 850, 855, 875, 895, 900, 935, 945, 950, 955, 975 Replaces V56663, N7389	Blower Motor 12 Volt, Vented Motor, Reversible Single Speed, 2-Wire Motor w/ 3/8" Shaft	AMX10221	\$ 115.00
	5640, 6640, 7740, 7840, 8160, 8240, 8260, 8340, 8360, 8560, TM115, TM120, TM125, TM130, TM135, TM140, TM150, TM155, TM165, TM175, TM190, TS90, TS100, TS110, TS115 Replaces 81870361, F0NN18456AA, F0NN18456AB	Blower Motor Double Shaft, 2-wire, 5/16" Shaft Diameter, 2 1/4" and 2 1/2" Long	AMX10115	\$ 100.00
	FW20, FW30, FW40, FW60 - 1977 and Later Replaces SFD014005T1	Blower Motor 12 Volt, 3-Speed, Single Shaft, 6-Wire, Reversible, Stud or Strap Mount, 5/16" Shaft Diameter, 1 3/4" Long	AMX10106	\$ 75.00
	500, 555, 700, 750, 800, 825, 835, 850, 855, 875, 895, 900, 935, 945, 950, 955, 975 Replaces V56663, N7389	Blower Wheel Reversible, Double Vented, Steel Wheel, 3 3/4" Diameter, 4" Long, 3/8" Shaft	AMX10212	\$ 19.00
	5110, 5610, 6410, 6610, 6710, 6810, 7410, 7610, 7710, 7810, 7910, 8210, 8530, 8630, 8730, 8830, TW5, TW15, TW25, TW35	Blower Wheel, Steel 3.75" Diameter, 4" Long, 0.375" Shaft, Double Vented Replaces 83953316, E5NN18459AA, E5NN18459BA	AMH84107	\$ 13.00
	6610, 6810, 7410, 7610, 7700, 7710, 7810, 7910, 8700, 9700, TW10, TW20, TW30, Backhoes: 555, 550, 555A, 555B Replaces D5NN18459A	Blower Wheel, Right Hand, CW Blower Wheel, Left Hand, CCW Double Vented Steel, 4 1/4" Diameter, 3/8" Shaft, Offset 2 1/4", 3 1/2"	AMX10217 AMX10216	\$ 26.00 \$ 26.00
	2600, 2610, 3600, 3610, 3910, 4100, 4110, 4600, 4610, 5600, 5610, 5640, 5700, 6410, 6600, 6610, 6640, 6700, 6710, 6810, 7410, 7600, 7610, 7700, 7710, 7740, 7810, 7910, 8160, 8210, 8240, 8260, 8340, 8360, 8530, 8560, 8630, 8700, 8730, 8830, 9700, TM115, TM120, TM125, TM130, TM135, TM140, TM150, TM155, TM165, TM175, TM190, TW5, TW10, TW20, TW25, TW30, TW35	Blower Motor Switch 3-Speed	AMD5NN15122A	\$ 17.50
	T2310, T2320	Blower Motor Switch 3-Speed Replaces 168822C1, 168822C2, AH84588	AMX10261	\$ 16.00
	TD80D, TD90D, TD95D	Condenser Core: 18" x 12" x 2.75" Replaces 5094971, 5096603	AM84215855	\$ 295.00

Ford® / New Holland®—Tractor

Application	Description	Part Number	Retail Price
 5110, 6710, 6810, 7410, 7710, 7910, 8210	Condenser w/ Oil Cooler Core: 16 3/8" x 19" x 2"	AME1NN19N656BA15M	\$ 275.00
 5610, 6610, 7610, 7810	Condenser Overall: 15 3/4" x 13 1/2" Core: 13" x 11" x 2 1/2"	AME0NN19710AB	\$ 395.00
 (8530, 8630, 8700, 9700 - 1979 and Later), (TW5, TW10, TW15, TW20, TW25 - 1979 and Later w/ Cooler)	Condenser Overall: 23" x 18" x 19" Core: 18" x 2.75"	AME5NN19N656BA	\$ 390.00
 (8670, 8770, 8870 - w/ Condenser in front of Oil Cooler)	Condenser Core: 21 1/2" x 26" x 1 1/4"	AM86501402	\$ 375.00
 T5040, T5050, T5060, T5070, T4.55, T4.65, T4.75, PowerStar™: 65, 75	Condenser Serpentine Style Rows Core: 19" x 14" x 1.25"	AM87542953	\$ 240.00
 T6030, T6050, T6070, T6080	Condenser Core: 15.625" x 20.50" x 0.875" Replaces 87574212	AM87641371	\$ 375.00
 T9020, T9030, T9040, T9050, TJ275, TJ280, TJ325, TJ330, TJ380, TJ425, TJ430, TJ450, TJ500	Condenser	AM87315600	\$ 481.00
(TD70D, TD80D, TD90D, TD95D - Tier 2), TD95DHC, TD5010, TD5020, TD5030, TD5050	Condenser Non-Serviceable Must Use Original Mounting Brackets Serpentine Style Rows Core: 15.50" x 20" x 1.25"	AM84342887	\$ 375.00
TL70, TL80, TL90, TL100	Condenser Core: 19.25" x 15.75" x 2"	AM5166770	\$ 425.00
 TM120, TM130, TM140, TM155, TM175, TM190 Replaces 82019424, 82019425, 82023592	Condenser Core: 20" x 2 3/4" x 11 3/4"	AM82033407	\$ 315.00
 (TW5, TW15, TW25 - 1983-12/89 w/o Cooler)	Condenser w/o Oil Cooler Overall: 22 1/8" x 9" Core: 17 1/2" x 9" x 2"	AMD8NN19710BB	\$ 315.00
 (5110, 5610, 6610, 6710, 6810, 7410, 7610, 7710, 7910, 8210 - 1981-9/85), 8700, 9700, TW10, TW20, (TW5, TW15, TW25, TW35 - 1982-85)	Evaporator Bulb Type Valve Overall: 30 3/4" x 6 1/4" x Width - 6 1/2" Core: 19" x 6" x 4 3/8"	AME0NN18N315AA	\$ 315.00
 (5110, 5610, 6610, 6710, 6810, 7410, 7610, 7710, 7910, 8210, 8530, 8630, 8730, 8830, TW5, TW15, TW25, TW35 - 10/1985 and Later), 7810 02/1988 and Later	Evaporator w/ Heater Core Bulb Type Valve Core: 19" x 4 1/2" x 6" Overall: 27 1/2" x 6" x 8 1/2"	AME4NN18N315AD	\$ 917.00
 2600, 3600, 4100 After 12/1974, 4600, 4600SU, 5600, 5700, 6600, 6700, 7600, 7700, 8000, 8700, 9000, 9700, TW10, TW20, TW30	Evaporator	AMD5NN18N315C	\$ 350.00
 5640, 6640, 7740, 7840, 8160, 8240, 8260, 8340, 8360, 8560, TS100, TS110	Evaporator Core: 25 1/2" x 5" 82034855	AM82009238	\$ 350.00
 (8670, 8770, 8870, 8970 - 06/1996 and Later)	Evaporator Block Type Valve Overall: 27 3/4" x 3 1/8" x 6" Core: 23 3/8" x 3 1/8" x 6"	AM86014818	\$ 260.00

Prices Subject to Change without Prior Notice. The use of original equipment manufacturer (OEM) part numbers or trademarks, e.g. Case® and John Deere®, are for reference purposes only and for indicating product use and compatibility. Our company and the listed replacement parts contained herein are not sponsored, approved or manufactured by the OEM. All parts are New unless designated Reman in the description.

Ford® / New Holland®—Tractor

Application	Description	Part Number	Retail Price
 T6010, T6020, T6030, T6040, T6050, T6060, T6070, TS100A, TS110A, TS115A, TS125A, TS130A, TS135A	Evaporator Core: 18 3/4" x 5" x 6 3/4"	AM82033007	\$ 315.00
 T6010, T6020, T6030, T6040, T6050, T6060, T6070, T6080, T6090, T7030, T7040, T7050, T7060, T7070, T6.120, T6.125, T6.140, T6.145, T6.150, T6.155, T6.160, T6.165, T6.175, T6.180, T7.165, T7.170, T7.175, T7.185, T7.190, T7.200, T7.210, T7.220, T7.225, T7.230, T7.235, T7.245, T7.250, T7.260, T7.315, TS100A, TS110A, TS115A, TS125A, TS130A, TS135A	Evaporator Core: 18 1/2" x 3 3/4" x 5"	AM82033008	\$ 265.00
 TD80D, TD90D, TD5030, TD5050, TM115, TM120, TM125, TM130, TM135, TM140, TM150, TM155, TM165, TM175, TM190	Evaporator Core: 25 1/2" x 3 1/8" x 5"	AM82034855	\$ 350.00

Shop Manuals and Collections

I&T Shop Service Manuals provide the information you need to service virtually any make or model of wheel-type farm tractor. Easy-to-follow procedures, detailed illustrations and comprehensive specifications help guide you through complete tractor maintenance and repair with accuracy and efficiency.



Application	Description	Part Number	Retail Price
Series: 2N, 8N, 9N	Ford®	IT-FO-4	\$ 28.00
Models: NAA	Ford®	IT-FO-19	\$ 28.00
Series: 501, 600, 601, 700, 701, 800, 801, 900, 1801, (2000, 4000 - w/ 4 Cylinder Engines)	Ford®	IT-FO-20	\$ 28.00
Series: (2000, 3000, 4000 - w/ 3 Cylinder Engines) Covers Models Prior to 1975	Ford®	IT-FO-31	\$ 28.00
Models: 2310, 2600, 2610, 3600, 3610, 4100 1974 and Later, 4110, 4600, 4610 Prior to 1984, 4600SU, 4610SU Prior to 1984	Ford®	IT-FO-41	\$ 28.00
Series: 5000, 5600, 5610, 6600, 6610, 6700, 6710, 7000, 7600, 7610, 7700, 7710	Ford®	IT-FO-42	\$ 28.00
Models: 2810, 2910, 3910	Ford®	IT-FO-43	\$ 28.00
Models: 1100, 1110, 1200, 1210, 1300, 1310, 1500, 1510, 1700, 1710, 1900, 1910, 2110	Ford®	IT-FO-44	\$ 28.00
Models: TW5, TW15, TW25, TW35	Ford®	IT-FO-45	\$ 28.00
Models: 1120, 1220, 1320, 1520, 1720, 1920, 2120	Ford®	IT-FO-46	\$ 28.00
Models: 3230, 3430, 3930, 4630, 4830	Ford®	IT-FO-47	\$ 28.00
Models: 2000 Super Dexta, 5000 Super Major, Commander 6000, Fordson Dexta, Fordson Super Dexta, Fordson Major Diesel, Fordson Power Major, Fordson Super Major, New Performance Fordson Major, New Performance Super Dexta, TW10, TW20, TW30, Series: 1000, 1600, 6000, 8000, 8600, 8700, 9000, 9600, 9700	Ford Collection®	IT-FO-201	\$ 31.00
Models: 5640, 6640, 7740, 7840, 8240, 8340	Ford®	IT-FO-48	\$ 28.00

New Holland®—Combine

Table of Contents

Air Cleaner Components	721	Elevator Chains	727
Air Conditioning and Components	748	Elevator Chain Sprockets	727
Alternators	722	Elevator Drive Sprockets	728
Auger Components—Bare Header / Platform	737	Feederhouse Chains	724
Auger Extension Kits	733	Feederhouse Chain Sprockets	725
Augers & Components—Grain Delivery Leveling	732	Feederhouse Components	725
Augers & Components—Horizontal Unloading	728	Final Drives and Components	723
Augers & Components—Vertical Unloading	728	Fuel Components	721
Augers—Grain Tank Bottom	731	Gas Struts	748
Augers—Lower Clean Grain & Components	731	Grain Pans and Components	736
Augers—Lower Tailing Return & Components	731	Grain Tank Auger Floor Liners	733
Axle Drive Shafts and Couplers	724	Grain Tank Extensions	250
Belts—1112, 1114, 1116, 1118, 2450, 2550—Swather	754	Guards and Cutter Bar Parts	739
Belts—1400, 1500	755	Hydraulic Oil Coolers	740
Belts—CR6.80, CR6.90, CR7.90, CR8.90, CR9.90, CR10.90 ...	769	Hydrostats and Components	723
Belts—CR6090, CR7090, CR8080, CR8090	765	Lighting	743
Belts—CR9040, CR9060, CR9070, CR9080, CR9090	766	Platform Components	738
Belts—CR920, CR940, CR960, CR970	764	Poly Skid Plates and Components	742
Belts—CX840, CX860, CX880, CX8070, CX8080, CX8090	767	Power Steering Cylinders and Components	747
Belts—TR70	756	Radiators	722
Belts—TR75, TR85	757	Reel Components	737
Belts—TR86	758	Rock Drum Components	725
Belts—TR87, TR88, TR89, TR99	759	Rotor Bars	726
Belts—TR95	760	Rotor Components	725
Belts—TR96	761	Row Crop Dividers	739
Belts—TR97, TR98	762	Sensors	722
Belts—TX66, TX68	763	Separator Gearbox Components	727
Brakes and Components	724	Sickle Drives and Components	737
Cab Components—Miscellaneous	747	Sickle Knife Heads	737
Chaffer and Sieve Frames and Components	735	Sieves—Lower	735
Chaffers—Adjustable Air Foil	735	Straw Chopper Blades and Components	737
Chaffers—Long Finger Top	734	Tie Rods and Components	747
Chaffers—Short Finger Top	733	Tip-Up Assemblies	251
Concaves and Components	726	Transmission Components	723
Cornhead—Fenders and Snouts	750	Transmissions	723
Cornhead—Row Unit Components	752	Unloading Auger Elbows and Components	730
Cornhead—Stalk Stompers and Components	751	Unloading Drive Components	730
Draper Belts and Components	740		

Fuel Components

Application	Description	Part Number	Retail Price	Core
CR8.90, CR9.90, CR10.90	Sensor, Fuel Pressure	AM5801567640	\$ 200.00	
	Sensor, Low Fuel Pressure	AM5801483105	\$ 445.00	
	Replaces 504343022			

Air Cleaner Components

Application	Description	Part Number	Retail Price	Core
CR6.80, CR6.90, CR7.90, CR8.90, CR9.90, CR10.90, CX8.80	Sensor, Nox Replaces 47688088	AM84422747	\$ 420.00	
CR10.90	Sensor, Air Intake	AM504307953	\$ 76.00	

Prices Subject to Change without Prior Notice. The use of original equipment manufacturer (OEM) part numbers or trademarks, e.g. Case® and John Deere®, are for reference purposes only and for indicating product use and compatibility. Our company and the listed replacement parts contained herein are not sponsored, approved or manufactured by the OEM. All parts are New unless designated Reman in the description.

New Holland®—Combine

Application	Description	Part Number	Retail Price	Core
CR10.90	Pressure Switch, Air Intake	AM47614038	\$ 17.00	

Radiators

Application	Description	Part Number	Retail Price	Core
(CR9040, CR9060, CR9065, CR9070 ASN HAJ110001)	Radiator	AM87378361	\$ 1700.00	
Swathers: H8060, H8080, Speedrower Swathers: 200, 240	Radiator	AM87340496	\$ 1647.00	

Alternators

Application	Description	Part Number	Retail Price	Core
CR920, CR940, CR960, CR970, CR9080, CX7.80, CX7.90, CX8.70, CX8.80, CX840, CX860, CX880, CX8080	Alternator, 14 Volt 220 Amp Note: Special Order Item	AM87592254	\$ 665.00	

Sensors

Application	Description	Part Number	Retail Price	Core
CR920, CR940, CR960, CR970, CR980, CR9040, CR9060, CR9065, CR9070, CR9080, CR9090, CX840, CX860, CX880, CX8070, CX8080, CX8090, Forage Harvesters: FR9040, FR9050, FR9060, FR9080, FR9090, FX30, FX40, FX50, FX60, Pickup Platform: 76C	Sensor, Transmission Speed Replaces 86593627	AM84058860	\$ 64.00	
CR920, CR940, CR960, CR970, CR980, CR9040, CR9060, CR9070, CR9080, CR9090, CX8070, CX8080, CX8090, Forage Harvesters: FR450, FR480, FR500, FR550, FR600, FR650, FR700, FR780, FR850, FR9040, FR9050, FR9060, FR9080, FR9090	Sensor, Spreader Position Proximity	AM84058863	\$ 78.00	
CR6090, CR7090, CR8080, CR8090, CR9040, CR9060, CR9065, CR9070, CR9080, CR9090, CR6.80, CR6.90, CR7.90, CR8.90, CR9.90, CR10.90, CX8080, CX8090, CX8.80, CX8.90, Swathers: 130, 160, 200, 220, 240, 260	Sensor, Feeder and Lateral Tilt Replaces 87649361, 87649363	AM87330286	\$ 117.00	
CR6090, CR7090, CR8080, CR8090, CR9090, CR6.80, CR6.90, CR7.90, CR8.90, CR9.90, CR10.90, CX8.80, CX8.90, Swathers: 130, 160, 200, 220, 240, 260	Temperature Sender, Exhaust Temperature Replaces 47367178, 87482353, LB52S00001P1	AM47478880	\$ 60.00	
CR6090, CR7090, CR8080, CR8090, CR9090, CR6.80, CR6.90, CR7.90, CR8.90, CR10.90, CX8.80, CX8.90	Sensor, Def/AdBlue Tank Level Replaces 47682727, 84161271, LB50P01001P1	AM47512674	\$ 260.00	
CR9040, CR9060, CR9065, CR9070, CR9080	Sensor, Oil Pressure and Temperature Replaces 4890193	AM504358206	\$ 78.00	
CR9040, CR9060, CR9070, CR9.90	Sensor, Clogged Fuel Filter Indicator	AM500346371	\$ 40.00	
CR9040, CR9060, CR9080, CR6.80, CR6.90, CR7.90, CR8.90, CR9.90	Sensor, MAP Temperature/Pressure Replaces 2852821, 4896794, 504073323	AM504372225	\$ 49.00	
CR9070, CR9080, CR9090, CX840, CX860, CX880, CX8070, CX8080, CX8090, Forage Harvesters: FR9040, FR9050, FR9060, FR9080, FR9090	Sensor, Transmission Position Replaces 84269118	AM84457942	\$ 355.00	
(CR6.80, CR6.90, CR7.90, CR8.90 - MY15), CR9.90 (A4 and MY15)	Switch, Engine Exhaust Pressure Replaces 2859674, 4890193, 6901334	AM504358206	\$ 78.00	
CR6.80, CR6.90, CR7.90, CR8.90, CR9.90, CR10.90	Sensor, Exhaust Pressure	AM5801376024	\$ 56.00	
	Sensor, Crankcase Pressure	AM504364902	\$ 183.00	
CR6.80, CR6.90, CR7.90, CR8.90, CR9.90, CR10.90, CX8.80	Sensor, 8-Pin/NH3/Ammonia Replaces 47368956, 84382712	AM47520140	\$ 425.00	
CR6.80, CR6.90, CR7.90, CR8.90, CR9.90, CR10.90, CX8.80, CX8.90, Swathers: 130, 160, 200, 220, 240, 260, Forage Harvesters: FR480, FR550, FR650, FR780	Sensor, Def/AdBlue Quality Replaces 84553250	AM47520143	\$ 320.00	

New Holland®—Combine

Application	Description	Part Number	Retail Price	Core
CR8.90, CR9.90, CR10.90	Sensor, Fuel Pressure and Temperature	AM5801526037	\$ 125.00	
CR10.90	Sensor, Exhaust Pressure	AM5801382522	\$ 104.00	

Hydrostats and Components

Our hydrostats are remanufactured by a remanufacturing facility recognized by Sauer/Sundstrand. All units are assembled by a factory-trained technician, using genuine new and remanufactured replacement parts. All units are fully tested to factory specifications for maximum performance.



Application	Description	Part Number	Retail Price	Core
TR70 BSN 293511	Reman Hydrostat, Sundstrand Replaces AH75517, PG203919	H7700S	\$ 1750.00	\$ 500.00
TR70 ASN 293512, TR75 SN 304740-403000, TR85 SN 308086-310400	Reman Hydrostat, Sundstrand Replaces AH98889, AH107887, AH119038	H7720S	\$ 3350.00	\$ 500.00
TR95	Reman Hydrostat, Sundstrand 2-Piece	H95S	\$ 2150.00	\$ 500.00
CR6090, CR7090, CR8080, CR8090, CR9040, CR9060, CR9065, CR9070, (CR9080, CR9090, CR8.90 Excluding Elevation), CR6.80, CR6.90, CR7.90, CR9.90 Excluding A4B	Hydrostat Pump 125 cc	AM87634751	\$ 6964.45	
CR6090, CR7090, CR8080, CR8090, CR9040, CR9060, CR9065, (CR9070, CR9080, CR9090, CR6.80, CR6.90, CR7.90 - Excluding Revelation), (CR8.90, CR9.90 - MY15, MY16, MY17 and MY18 Revelation)	Hydrostat Motor 125 cc Replaces 84168175	AM47919915	\$ 2427.25	

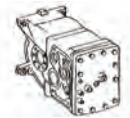

Transmissions

Application	Description	Part Number	Retail Price	Core
TR75 BSN 304739, TR85 BSN 308085	Reman Transmission Units w/ Positorque or Gear Drive	AMT200PT	\$ 1750.00	\$ 400.00
TR75 BSN 304739, TR85 BSN 308085, TR95 BSN 501200	Reman Transmission Units w/ Hydrostat Drives	AMT200H	\$ 1750.00	\$ 400.00

Transmission Components

Application	Description	Part Number	Retail Price	Core
CR920, CR940, CR960, CR970, CR980, CR6090, CR7090, CR8080, CR8090, CR9040, CR9060, CR9065, CR9070, CR9080, CR9090, CR6.80, CR6.90, CR7.90, CR8.90, CR9.90, CR10.90, CX840, CX860, CX880, CX8070, CX8080, CX8090, CX8.80, CX8.90, Forage Harvesters: FR450, FR480, FR500, FR550, FR600, FR650, FR700, FR780, FR850, FR920, FR9040, FR9050, FR9060, FR9080, FR9090	Transmission Output Shaft 8 & 22 Spline, 13.85" Long	AM84069687	\$ 200.00	
CR920, CR940, CR960, CR970, CR980, CR6090, CR7090, CR8080, CR8090, CR9040, CR9060, CR9065, CR9070, CR9080, CR9090, CR6.80, CR6.90, CR7.90, CR8.90, CR9.90, CR10.90, CX860, CX880, CX8070, CX8080, CX8090, CX8.80, CX8.90, Forage Harvesters: FR480, FR500, FR600, FR650, FR700, FR780, FR850, FR920, FR9040, FR9050, FR9060, FR9080, FR9090	Differential Shaft w/ Lock 8 & 22 Spline, 17.09" Long	AM84069688	\$ 241.33	



Final Drives and Components

Application	Description	Part Number	Retail Price	Core
TR70 BSN 197550 Replaces 272592	Reman Final Drive 11:90 Ratio, Big Pinion, Pinion # - H85817	FD11-90BP	\$ 1350.00	\$ 100.00

New Holland®—Combine

Application	Description	Part Number	Retail Price	Core
TR95 BSN 501200	Reman Final Drive Planetary Type	FD8820PT	\$ 2000.00	\$ 350.00
CR940, CR960, CR970, CR980, CR6090, CR7090, CR8080, CR8090, CR9060, CR9065, CR9070, CR9080, CR9090, CR6.80, CR6.90, CR7.90, CR8.90, CR9.90, CX860, CX880, CX8070, CX8080, CX8090	Pinion Shaft 18 Tooth Replaces 84074717	AM84449593	\$ 940.00	
TR70 BSN 197550	Pinion Shaft 11 Tooth, 8.32" Long For use in 11:104 and 11:90 Big Pinion Final Drives	AMH85817	\$ 140.00	

Axle Drive Shafts and Couplers

Application	Description	Part Number	Retail Price	Core
CR920, CR940, CR960, CR970, CR980, CR8090, CR9040, CR9060, CR9070, CR9080, CR9090, CR6.80, CR6.90, CR7.90, CR8.90, CR9.90, CR10.90, CX840, CX860, CX880, CX8070, CX8080, CX8090, CX8.80, CX8.90 - w/o Axle Extensions	Axle Drive Shaft 22 Spline Left Hand	26.12" Long AM84440162	\$ 377.66	
CR970, CR980, CR9070, (CX860, CX880 ASN D348), CX8070, CX8080, CX8090 - w/o Axle Extensions	Axle Drive Shaft 22 Spline Right Hand	36.38" Long AM84440165	\$ 361.64	
CR970, CR980, CR9070, CX860, CX880, CX8080, CX8090 - w/ 265 mm Axle Extensions	Axle Drive Shaft 22 Spline Right Hand Replaces 84440972	46.75" Long AM84440974	\$ 268.78	
	Axle Drive Shaft 22 Spline Left Hand	36.50" Long AM84440967	\$ 256.07	
CR920, CR940, CR960, CR970, CR9040, CR9060, CR9070, CX760, CX840 ASN D412, (CX860, CX880 ASN D348), CX8040, CX8050	Axle Drive Shaft Coupler 22 Spline	4.09" Long AM84438982	\$ 99.66	



Brakes and Components

Application	Description	Part Number	Retail Price	Core
TR70, TR75 BSN 304739, TR85 BSN 308085, TR95 BSN 501200	Brake Drum Cast Iron	AMH85887	\$ 285.00	

Feederhouse Chains

Our feederhouse chains utilize high-quality materials to meet or exceed OEM specifications. Slats are mounted using 3/8" grade 5 plated bolts and locknuts for easy replacement. Chains feature full side plates and high-strength steel for added durability. All feederhouse chains come with serrated slats unless otherwise noted. Call for different slats and chain configurations available to fit your application.



Application	Description	Part Number	Retail Price	Core
CR920, CR940, CR960, CR9040, CR9060	Feederhouse Chain 3 Chain Assembly	AM87372056	\$ 1846.15	
CR970, CR980, CR9070, CR9080	Feederhouse Chain 3 Chain Assembly	AM87372057	\$ 2046.15	
TR70, TR75, TR85	Feederhouse Chain 93 links - slat every 2nd & 4th link, chrome pins 15.25" center-to-center on sprockets, CA557	AMX28033L	\$ 1047.68	
TR75, TR85, TR86, TR87, TR89, TR96 ASN 529779, TR97, TR98, TR99	Feederhouse Chain 93 links - slat every 2nd & 4th link, chrome pins 17.125" center-to-center on sprockets, CA557	AM9623769L	\$ 559.90	

New Holland®—Combine

Application	Description	Part Number	Retail Price	Core
TR75, TR85, TR86, TR87, TR89, TR96 ASN 529779, TR97, TR98, TR99	Feederhouse Chain 93 links - slat every 2nd link, chrome pins 17.125" center-to-center on sprockets, CA557	AMX28035L	\$ 1028.75	
TR95, TR96 BSN 526378	Feederhouse Chain 93 links - slat every 2nd & 4th link, chrome pins 21.125" center-to-center on sprockets, CA557	AM696235L	\$ 1034.83	

Feederhouse Chain Sprockets

To extend the life of your chain assemblies, always replace the sprockets when installing a new chain.



Application	Description	Part Number	Retail Price	Core
(CR9040, CR9060, CR9070 ASN HAJ111001), CR9080	Feederhouse Chain Sprocket Outside	AM87665225	\$ 157.60	
TR70, TR75 BSN 304699, TR85 BSN 307999	Feederhouse Chain Sprocket 12 Tooth, 1.75" Round	Center AM765721 Outside AM765720	\$ 75.84 \$ 52.82	
TR75 ASN 304699, TR85 ASN 307999, TR86, TR95, TR96, TR97, TR98, TR99	Feederhouse Chain Sprocket 12 Tooth, 1.75" Hex	Center AM766380 Outside AM766379	\$ 89.00 \$ 99.00	

Feederhouse Components

Application	Description	Part Number	Retail Price	Core
CR920, CR940, CR960, CR970, CR980, CR7090 (A4), CR8090, CR9040, CR9060, CR9065, CR9070, CR9080, CR9090, CR8.90, CR9.90	Wear Strip	AM86551643	\$ 25.00	
TR70, TR75, TR85, TR95	Feeder Drum Idler Bearing 1 1/8" (28.60 mm) Hex Bore, 1.4843" (37.70 mm) Wide, 2.8346" (72 mm) OD	AM121602	\$ 17.00	

Rock Drum Components

Application	Description	Part Number	Retail Price	Core
(CR920, CR940, CR960 ASN HAJ100800), (CR970, CR980 ASN HAJ100822), CR6090, CR7090, CR8080, CR8090, CR9040, CR9060, CR9065, CR9070, CR9080, CR9090, CR6.80, CR6.90, CR7.90, CR8.90, CR9.90, CR10.90	Drum Arm Spacer 1.07" Long, 0.656" ID, 1" OD Replaces 86621437, 87013282	AM87021332	\$ 9.25	

Rotor Components

Application	Description	Part Number	Retail Price	Core
920, 940, 960, 9060, CR9040, TR70, TR75, TR85, TR86, TR87, TR88, TR89, TR95, TR96, TR97, TR98, TR99	Wear Bars, Set of 2	Right Hand AM86584738 Left Hand AM86584737	\$ 61.54 \$ 61.54	
CR920, CR940, CR960, CR970, CR980, CR6090, CR7090, CR8080, CR8090, CR9040, CR9060, CR9065, CR9070, CR9080, CR9090, CR6.80, CR6.90, CR7.90, TR75, TR85, TR86, TR87, TR88, TR89, TR96, TR97, TR98, TR99	Wear Plate, Set of 2 Hardened Hardware Included Replaces 621792	Left Hand AM86584739	\$ 127.18	
CR9040, CR9060, CR9070, CR9080, CR9090	Rotor Extension Serrated	Right Hand AM87700823 Left Hand AM87700825	\$ 189.23 \$ 172.31	
CR920, CR940, CR960, CR970, CR980, CR6090, CR7090, CR8080, CR8090, CR9040 09/2006-11, CR9070, CR9080, CR9090, CR6.80, CR6.90, CR7.80, CR7.90, CR8.90, CR9.90, CR10.90	Rotor Drive Coupling, Splined For Dual Speed Rotor Drive	AM86980985	\$ 75.00	

New Holland®—Combine

Application	Description	Part Number	Retail Price	Core
CR970, CR980, CR8090, CR9070 Non-Elevation, CR9080, CR9090, CR6.90, CR7.90, CR8.90, CR9.90, CR10.90	Rotor Drive Coupling, 8-Bolt 12 Tooth For Small Grain Rotor Assemblies (Standard and Hard Threshing) and Twin Pitch Corn, Grain and Rice (Standard and High Performance) Replaces 7280751	AM84222993	\$ 350.00	
TR70, TR75, TR85, TR86, TR88, TR89, TR95, TR96, TR97, TR98, TR99	Ball Bearing, Front Rotor Shaft Support Replaces 80609150, 86533335, B92630	AM86575514	\$ 94.90	

Rotor Bars

Application	Description	Part Number	Retail Price	Core
CR920, CR940, CR960, CR9040, CR9060, TR86 ASN 529739, TR87, TR88, TR89, TR96 ASN 529779, TR97, TR98, TR99	Rotor Rasp Bar Kit, Right Hand	AM82797035	\$ 1476.92	
	Components:			
	Rasp Bar, Leading (Set of 2)	3 AM86503256	\$ 307.69	
	Rasp Bar, Trailing (Set of 2)	3 AM9800346	\$ 145.39	
CR920, CR940, CR960, CR9040, CR9060, TR86 ASN 529739, TR87, TR88, TR89, TR96 ASN 529779, TR97, TR98, TR99	Rotor Rasp Bar Kit, Left Hand	AM82797034	\$ 1346.15	
	Components:			
	Rasp Bar, Leading (Set of 2)	3 AM86503255	\$ 307.69	
	Rasp Bar, Trailing (Set of 2)	3 AM9800347	\$ 132.62	
CR920, CR940, CR960, CR9040, CR9060, TR86 ASN 529739, TR87, TR88, TR89, TR96 ASN 529779, TR97, TR98, TR99	Rotor Rasp Bar Kit, Leading, Right Hand	AM82797031	\$ 884.61	
	Components:			
	Rasp Bar, Leading (Set of 2)	3 AM86503256	\$ 307.69	
	Rotor Rasp Bar Kit, Leading, Left Hand	AM82797030	\$ 884.61	
CR920, CR940, CR960, CR9040, CR9060, TR86 ASN 529739, TR87, TR88, TR89, TR96 ASN 529779, TR97, TR98, TR99	Rotor Rasp Bar Kit, Tailing, Right Hand	AM82797033	\$ 395.38	
	Components:			
	Rasp Bar, Trailing (Set of 2)	3 AM9800346	\$ 145.39	
	Rotor Rasp Bar Kit, Tailing, Left Hand	AM82797032	\$ 467.69	
CR920, CR940, CR960, CR9040, CR9060, TR86 ASN 529739, TR87, TR88, TR89, TR96 ASN 529779, TR97, TR98, TR99	Rotor Rasp Bar Kit, Tailing, Left Hand	AM82797032	\$ 467.69	
	Components:			
	Rasp Bar, Trailing (Set of 2)	3 AM9800347	\$ 132.62	
	Rotor Rasp Bar, Leading	Right Hand AM84050520 Set of 3 Left Hand AM84050519 (3) Sets Required	\$ 423.08 \$ 423.08	
CR970, CR980, CR9070, CR9080	Rotor Rasp Bar, Trailing	Right Hand AM84060997 Set of 3 Left Hand AM84060998 (3) Sets Required	\$ 233.85 \$ 235.38	
	Rotor Rasp Bar Kit	AMONH-70	\$ 624.06	
	(16) 3-Hole Bars w/ Mounting Hardware			
	TR75, TR76, TR85, TR86 BSN 529738, TR95 ASN 501851, TR96 BSN 529778 - w/ Style I S3 Rotor	Cylinder Bar Kit (12) Right and Left Hand 2-Hole Flat Bars w/ Mounting Hardware	Hardened AMONH-95H	\$ 1866.71



Concaves and Components

Application	Description	Part Number	Retail Price	Core
CR970, CR980, CR9070, CR9080, CR9090	Concave Kit, Narrow Wire Includes Concave, Concave Extension and Hardware	AM87651759	\$ 2017.08	

New Holland®—Combine

Application	Description	Part Number	Retail Price	Core
CR920, CR940, CR960	Concave, Narrow Wire 64 Wires Replaces 47449673	AM87536102	\$ 825.00	
	Concave, Wide Wire 45 Wires Replaces 87536120	AM86588198	\$ 700.00	
TR86 ASN 526601, TR87, TR88, TR89, TR96 ASN 527821, TR97, TR98, TR99	Concave, Set of 2 Rotary - 11 cross bars, narrow spaced wires Comes w/ Right and Left Hand	AMCNH-96-11	\$ 2388.85	
	Concave, Set of 2 8 cross bars, 2 rows of removable wires Comes w/ Right and Left Hand	AMCNH-96-8ST	\$ 1997.08	
CR920, CR940, CR960	Concave Extension, Narrow Wire Replaces 47444217	AM86585615	\$ 475.00	
CR920, CR940, CR960, CR970, CR980, CR9040, CR9060, CR9070, CR9080, CR9090, CR6.80, CR6.90, CR7.90, CR8.90, CR9.90, CX8090	Concave Motor Replaces 87011029	AM84194644	\$ 515.00	

Separator Gearbox Components

Application	Description	Part Number	Retail Price	Core
CR6090, CR7090, CR8080, CR8090, CR9040, CR9060, CR9065, CR9070, CR9080, CR9090, CR6.80, CR6.90, CR7.90, CR8.90, CR9.90	Bearing, Cam Follower Replaces 418732A1, 1315343C1	AM86582880	\$ 34.50	

Elevator Chains

Elevator chains include rubber paddles attached with 5/16" plated bolts and nuts (unless noted in the individual description). Chains feature full side plates for added strength.



Application	Description	Part Number	Retail Price	Core
TR70 ASN 215983, TR75, TR85, TR89	Clean Grain Elevator Chain 78 links - 4 1/4" x 3 3/8" paddles every 4th link	AM248043L	\$ 184.35	
TR86, TR87, TR89, TR95, TR96, TR97	Clean Grain Elevator Chain 78 links - 7" x 3 5/16" paddles every 4th link	AM782440L	\$ 211.50	
CR920, CR940, CR960, CR970, CR9040, CR9060, CR9070, CR9080	Clean Grain Elevator Chain 148 links - 7 3/7" x 3 13/16" paddles	AM87373433	\$ 759.93	
TR70, TR75, TR85, TR86, TR87, 985, 975, 980, 990, 995	Return Grain Elevator Chain 129 links - 4 1/4" x 3 3/8" paddles every 6th link	AM248044L	\$ 247.28	

Elevator Chain Sprockets

To extend the life of your chain assemblies, always replace the sprockets when installing a new chain.



Application	Description	Part Number	Retail Price	Core
TR70, TR75, TR76, TR85, TR86, TR87, TR88, TR95, TR96, TR97, TR98	Elevator Chain Sprocket 9 Tooth, 1.00" Round	AM784744	\$ 67.69	
TR75, TR85, TR87, TR89, TR95, TR96, TR97, TR98, TR99	Elevator Chain Sprocket 9 Tooth, 1.125" Round	AM773824	\$ 86.15	
TR87, TR88, TR89, TR98, TR99	Elevator Chain Sprocket 9 Tooth, 1.375" Round	AM86512666	\$ 88.73	

New Holland®—Combine



Elevator Drive Sprockets

Application	Description	Part Number	Retail Price	Core
CR920, CR940, CR960, CR970, CR9040, CR9060, CR9070, CR9080	Elevator Driven Sprocket For Clean Grain Elevator	AM84437648	\$ 78.46	

Augers & Components—Vertical Unloading

All augers are made with continuous roll-formed flighting for accuracy and durability.

Application	Description	Part Number	Retail Price	Core
CR920, CR940, CR960, CR970, CR980, CR9040, CR9060, CR9065, CR9070 Non-Elevation, CR9080 USA 03/2009-11	Vertical Unloading Auger, Extended Wear Extended Wear, 47" Overall Length, Left Hand Flighting, 14 1/2" Flighting Diameter, Shaft Diameter - 8 Internal Spline Both Ends, 11 1/2" Pitch Replaces 84447940, 87733266	AM87756536	\$ 950.00	
	Unloading Auger Drive Hub (2) Required per Auger	AM87011705	\$ 21.00	
CR6.90 (MY19, MY20), CR7.90, CR8.90, CR9.90, CR10.90 10/18 and Later	Vertical Unloading Auger, Extended Wear Extended Wear, High Capacity, 41 1/4" Overall Length, Left Hand Flighting, 15 1/2" Flighting Diameter, Shaft Diameter - 8 Internal Spline and 8 Internal Spline, 10 1/2" Pitch Replaces 47886358	AM47886360	\$ 825.00	
5088, 5130, 5140, 6088, 6130, 6140, 7010, 7088, 7120, 7130, 7140, 7230, 8010, 8120, 8230, 9010, 9120, 9230 Will not fit models w/ cast Unloading Auger Elbow	Vertical Unloading Auger Liner Kit Includes Repair Ring and Full Sump Liner Kit All Weld-In Only	AMX29088	\$ 1125.00	
CR8.80, CR8.90, CR9.90, CR10.90 For Models w/ Cast Iron Unloading Auger Elbow	Vertical Unloading Auger Liner	AMX29145	\$ 1125.00	
CR920, CR940, CR960, CR970, CR980, CR6090, CR7090, CR8090, CR9040, CR9070, CR9080, CR9090, CR6.80, CR6.90, CR7.90, CR8.90, CX840, CX8070, CX8080, CX8090, CX8.80, CX8.90	Unloading Auger Gearbox, Lower	AM84320052	\$ 955.00	
CR9040, CR9060 (09/2006-11), CR9065, CR9070, CR9080 03/2009-11, CR920, CR940, CR960, CR970, CR980, CX840, CX860, CX880, CX8070, (CX8080, CX8090 2006-13)	Unloading Auger Bevel Gear	AM84437278	\$ 125.00	
R920, CR940, CR960, CR970, CR980, CR9040, CR9060, CR9065, CR9070, CR9080, CR9090	Repair Ring For Repair of Top of Vertical Unload Tube	AMX29111	\$ 62.00	

Augers & Components—Horizontal Unloading

Application	Description	Part Number	Retail Price	Core
CR920, CR940, CR960, CR970, CR980, CR6090, CR7090, CR8080, CR8090 (A3 and A4), CR9040, CR9060, CR9065, CR9070, CR9080, CR9090 (Excluding G4), CR6.80, CR6.90, CR7.80, CR7.90, CX840, CX860, CX880, CX8070, CX8080, CX8090, CX8.80, CX8.90	Horizontal Unloading Auger Extended Wear, Left Hand Flighting, 12 1/2" Flighting Diameter, Shaft Diameter - 1.18" and 8 Internal Spline, 16" Pitch Replaces 84073843, 87280339, 87560311, 87575221	214 15/16" AM84447941	\$ 1339.00	
	Bearing	AMJD10384	\$ 22.00	
CR920, CR940, CR960, CR970, CR980, CX840, CX860, CX880, CX8070, CX8080, CX8090	Horizontal Unloading Auger Tube Replaces 84457972	AM84071578	\$ 2678.00	

New Holland®—Combine

Application	Description		Part Number	Retail Price	Core
CR920, CR940, CR960, CR970, CR980, CR6090, CR7090, CR8080, CR8090 (A3 and A4), CR9040*, CR9060*, CR9065 (21' and 24' System), (CR9070*, CR9080, CR9090 - Non-Elevation), (CR6.80, CR6.90, CR7.90 - MY15, MY16 and MY17) *5.50 mm Standard Wear or ASN Y8G112000 w/ 21' or 24' System	Horizontal Unloading Auger Tube Extended Wear Replaces 87280552, 87284775	216"	AM87470158	\$ 2283.57	
CR920, CR940, CR960, CR970, CR980, CR9040, CR9060, CR9065, CR9070 Non-Elevation, CR9080, CR9090 Elevation, CX8070 (A3 and A4), CX8080 (A3, A4 and A4 Elevation), CX8090 (A4 and A4 Elevation), CR7.80 (MY21), CR7.90 (A4A Revelation and MY21), CX8.80, CX8.90	Horizontal Unloading Auger Replaces 84331632, 87280340, 87280341, 87575225, 87657822	38"	AM87575223	\$ 832.41	
CR920, CR940, CR960, CR970, CR980, CR980, CR9040, CR9060, CR9065, CR9070 Non-Elevation, CR9080, CR9090 Elevation, CX8070 (A3 and A4), CX8080 (A3, A4 and A4 Elevation), CX8090 (A4 and A4 Elevation), CR7.80 (MY21), CR7.90 (A4A Revelation and MY21), CX8.80, CX8.90	Bearing		HC207-22	\$ 23.06	
CR920, CR940, CR960, CR970, CR980, CR9040, CR9060, CR9065, CR9070, CR9080	Horizontal Unloading Auger Extension Extended Wear, 3' Extension, 21 Spline, 4.50" Tube Diameter Replaces 87280340, 87280341, 87575225	38"	AM87657822	\$ 846.40	
	Bearing		HC207-22	\$ 23.06	
CR920, CR940, CR960, CR970, CR9040, CR9060, CR9070, CR9080, CX8070, CX8080, CX8090	Bearing Support Use w/ 3" Unloading Auger Extension		AM84072623	\$ 32.97	
CR8090 (G4), CR9090 (G4), CR8.90 (MY15 and MY16), CR9.90 (A4, A4B, MY15 and MY16), CR10.90 (A4)	Horizontal Unloading Auger Extension Extended Wear, 5' Extension, Left Hand Flighting, 14" Flighting Diameter, Shaft Diameter - 1 3/4" and 24 Internal Spline, 4.50" Tube Diameter, 14" Pitch Replaces 47395184, 84362490, 84384607	64 1/4"	AM47395186	\$ 1040.00	
	Bearing w/ Lock Collar		AM84416910	\$ 52.13	
CR8090 (G4), CR9090 (G4), CR8.90 (MY15 and MY16), CR9.90 (A4, A4B, MY15 and MY16), CR10.90 (A4) - All w/ 7.20' Extension	Horizontal Unloading Auger - Front Inner Fold Extended Wear, Left Hand Flighting, 14" Flighting Diameter, Shaft Diameter - 1.62" and 24 Internal Spline, 14" Pitch Replaces 84512841	90 1/2"	AM47395188	\$ 1050.00	
	Bearing w/ Lock Collar		AM84416910	\$ 52.13	
CR9040, CR9060, CR9065, CR9070	Horizontal Unloading Auger Extended Wear, 4.50" Tube Diameter Replaces 87280358, 87318083, 87575221	212.50"	AM87729509	\$ 1500.75	
	Bearing		AMJD10384	\$ 22.00	
CR8.90 (MY15, MY16 and MY17), CR9.90 (A4, A4B, MY15, MY16 and MY17), CR10.90 (A4)	Horizontal Unloading Auger - Front Inner Fold Extended Wear, Left Hand Flighting, 14" Flighting Diameter, Shaft Diameter - 1.62" and 24 Internal Spline, 14" Pitch	116 5/8"	AM47523765	\$ 1229.00	
	Bearing w/ Lock Collar		AM84489731	\$ 37.17	
CR8.90 (MY15, MY16 and MY17), CR9.90 (A4, A4B, MY15 and MY16), CR10.90 (A4)	Horizontal Unloading Auger - Middle Inner Fold Extended Wear, Left Hand Flighting, 14" Flighting Diameter, Shaft Diameter - 1.382" and 24 Internal Spline, 14" Pitch	91 3/4"	AM47523269	\$ 998.00	
	Bearing w/ Lock Collar		AM84416910	\$ 52.13	
CR8.90, CR9.90, CR10.90	Horizontal Unloading Auger - Rear Outer Fold Extended Wear Replaces 47395202, 47425443, 84365603, 84416898, 84529926	95.25"	AM47445370	\$ 1401.77	
	Bearing w/ Lock Collar		AM84489731	\$ 37.17	

New Holland®—Combine

Application	Description	Part Number	Retail Price	Core
CR8.90*, CR9.90*, CR10.90 *Excluding Models A5 11/2020 and Later, D4, MY15, MY19, MY20 and TRA5 11/2020 and Later	Horizontal Unloading Auger Extended Wear, High Capacity, Left Hand Flighting, 14" Flighting Diameter, Shaft Diameter - 1 3/16" and 8 Internal Spline, 14 1/2" Pitch	227 5/8" AM47897750	\$ 1943.00	
	Bearing	AMJD10384	\$ 22.00	

Unloading Auger Elbows and Components

Application	Description	Part Number	Retail Price	Core
CR920, CR940, CR960, CR970, CR980, CR6090, CR6.80 04/2015-12/18, CR6.90, CR7.90, CR7090, CR8080, CR8090, CR9040, CR9065, CR9070, CR9080, CR9090	Unloading Auger Elbow Black Replaces 87044522, 87280557, 87281407, 87354631, 87757649	AM84126362	\$ 1825.00	
CR920, CR940, CR960, CR970, CR980, CR6090, CR7090, CR8080, (CR8090, CR9090 - Excluding G4), CR9040, CR9060, CR9065, CR9070, CR9080, CR6.80, CR6.90, CR7.80, CR7.90, CR8.90 (D4 Elevation), CX840, CX860, CX880, CX8070, CX8080, CX8090, CX8.80, CX8.90	Unloading Auger Gearbox Standard Unload Rate w/ 24 Spline Output Shaft w/ 16 Tooth Inner Bevel Gear Replaces 84320130, 86523576	AM87331084	\$ 940.00	
(CR8090, CR9090 - G4), CR8.90 Excluding D4 Elevation, CR9.90, CR10.90	Upper Unloading Auger Gearbox High Capacity Gearbox w/ 24 Spline Output Shaft w/ 16 Tooth Inner Bevel Gear Replaces 47919991, 84262051	AM47941493	\$ 1320.00	
CR920, CR940, CR960, CR970, CR980, CR6090, CR7090, CR8080, CR8090, CR9040, CR9060, CR9065, CR9070, CR9080, CR9090, CR6.80, CR6.90, CR7.90, CR8.90, CX840, CX860, CX880, CX8070, CX8080, CX8090, CX8.80, CX8.90	Upper Unloading Auger Gearbox Shaft 15 Tooth, 21 Spline, 6.34" Long	AM87331114	\$ 275.00	
	Lower Unloading Auger Gearbox Shaft 8 & 21 Spline, 7.81" Long	AM86623219	\$ 131.81	
CR920, CR940, CR960, CR970, CR980, CR6090, CR7090, CR8080, CR8090 (A3, A4), CR9065, CR9070, CR9080, CR9090 (Except G4), CR6.80, CR6.90, CR7.90, CX840, CX860, CX880, CX8070, CX8080, CX8090, CX8.80, CX8.90	Unloading Auger Elbow Bushing 1.57" Tall, 16.06" ID, 17.32" OD	AM86558526	\$ 68.00	

Unloading Drive Components

Application	Description	Part Number	Retail Price	Core
CR920, CR940, CR960, CR970, CR980, CR6090, CR7090, CR8080, CR8090, CR9040, CR9060, CR9065, CR9070, CR9080, CR9090, CR6.80, CR6.90, CR7.90, CR8.90, CX840, CX860, CX880, CX8060, CX8070, CX8080, CX8090, CX8.80, CX8.90	Unloading Auger Drive Hub 21 Tooth Replaces 84073608, 84073843, 86563106	AM87011705	\$ 21.00	
CR920, CR940, CR960, CR970, CR9040, CR9060, CR9070, CX840, CX860, CX880, CX8070, CX8080, CX8090	Unloader Drive Sprocket 38 Tooth	AM84069777	\$ 80.69	
CR920, CR940, CR960, CR970, CR9040, CR9060, CR9070, CX840, CX860, CX880, CX8070, CX8080, CX8090	Unloader Idler Sprocket 15 Tooth	AM86627639	\$ 20.00	
TR70, TR75, TR85, TR86, TR87, TR88	Shaft w/ Bevel Gear For Unloading Gearbox 13 Tooth, 15 Spline	AM247762	\$ 348.72	

New Holland®—Combine

Augers—Grain Tank Bottom

All augers are made with continuous roll-formed fighting for accuracy and durability.



Application	Description	Part Number	Retail Price	Core
CR920, CR940, CR960, CR970, CR980, CR9040, CR9060, CR9070 - Standard Wear and Extended Wear), CR9065 Extended Wear	Grain Tank Bottom Auger, Front Extended Wear, 120 3/4" Overall Length, Right Hand Fighting, 8 1/4" Fighting Diameter, Shaft Diameter - 2" and 1.18", 9 3/8" Pitch Replaces 84075319	AM87280345	\$ 387.00	
	Grain Tank Bottom Auger, Rear Extended Wear, 120 3/4" Overall Length, Right Hand Fighting, 8 1/4" Fighting Diameter, Shaft Diameter - 2" and 1.18", 9 3/8" Pitch Replaces 84075320	AM87280343	\$ 504.00	
	Bearing - Cover End	AMJD10384	\$ 22.00	
CR9065, CR9080 USA - Standard Wear	Grain Tank Bottom Auger, Front Extended Wear, 120 3/4" Overall Length, Right Hand Fighting, 8 1/4" Fighting Diameter, Shaft Diameter - 2" and 1.18", 9 3/8" Pitch Replaces 84075320	AM87280343	\$ 504.00	
	Grain Tank Bottom Auger, Rear Extended Wear, 120 3/4" Overall Length, Right Hand Fighting, 8 1/4" Fighting Diameter, Shaft Diameter - 2" and 1.18", 9 3/8" Pitch Replaces 84075319	AM87280345	\$ 387.00	
	Bearing - Cover End	AMJD10384	\$ 22.00	
CX840, CX860, CX8070 2006-04/11	Grain Tank Bottom Auger, Front Replaces 87280349	AM84075321	\$ 450.00	
	Grain Tank Bottom Auger, Rear Replaces 87280347	AM84075322	\$ 450.00	
	Bearing - Cover End	AMJD10384	\$ 22.00	

New Holland®—Combine

Augers—Lower Clean Grain & Components

All augers are made with continuous roll-formed fighting for accuracy and durability.



Application	Description	Part Number	Retail Price	Core
CR920, CR940, CR960, CR970, CR980, CR6090, CR7090, CR8070, CR9040, CR9060	Clean Grain and Return Grain Auger Trough Full Liner Kit Set of 2 Stainless Steel Weld-In Full Troughs, Narrow Frame 68" Overall Length Includes Stainless Steel for Door Covers	AMX29159	\$ 1061.00	
CR920, CR940, CR960, CR9040, CR9060	Bottom Grain Elevator Auger Extended Wear	94.75" AM87011549	\$ 743.08	
CR920, CR940, CR960, CR970, CR980, CR6090, CR7090, CR8070, CR8080, CR9040, CR9060	Clean Grain and Return Grain Auger Trough Liner Patch Kit Set of 2 Stainless Steel Weld-In Liners (Narrow Frame)	24" AMX29120	\$ 868.00	
CR970, CR980, CR9070, CR9080	Bottom Grain Elevator Auger Extended Wear	99.87" AM87011551	\$ 769.95	

Augers—Lower Tailing Return & Components

All augers are made with continuous roll-formed fighting for accuracy and durability.

Application	Description	Part Number	Retail Price	Core
CR920, CR940, CR960, CR970, CR980, CR6090, CR7090, CR8070, CR9040, CR9060	Clean Grain and Return Grain Auger Set of 2 Stainless Steel Weld-In Full Troughs, Narrow Frame Includes Stainless Steel for Door Covers	AMX29159	\$ 1061.00	

New Holland®—Combine

New Holland®—Combine

Application	Description	Part Number	Retail Price	Core
CR920, CR940, CR960, CR970, CR980, CR6090, CR7090, CR8080, CR8090, CR9040, CR9060, CR9065, CR9070, CR9080, CR9090, CR6.80, CR6.90, CR7.90, CR8.90, CR9.90, CR10.90, CX840, CX860, CX880, CX8070, CX8080, CX8090, CX8.80, CX8.90	Lower Return Auger Trough Cover Standard, w/o Holes, 62.55" Long	AM84078027	\$ 57.47	
CR920, CR940, CR960, CR970, CR980, CR6090, CR7090, CR8080, CR8090, CR9040, CR9060, CR9065, CR9070, CR9080, CR9090, (CR8.90, CR9.90 - Prior to MY18)	Clean Grain and Return Grain Auger Trough Liner Patch Kit Set of 2 Stainless Steel Weld-In Liners (Narrow Frame)	24" AMX29120	\$ 868.00	
CR920, CR940, CR960, CR9040, CR9060, CR9060, CR9070, CR9080	Tailing Elevator Auger, Left Hand Extended Wear	64.125" AM84182961	\$ 743.08	
CR920, CR940, CR9040	Bottom Tailing Elevator Auger Extended Wear	79.125" AM84078345	\$ 685.23	
CR960, CR970, CR980, CR9060, CR9070, CR9080	Tailing Elevator Auger, Right Hand Extended Wear	64.125" AM84182959	\$ 775.09	
CR960, CR9060	Bottom Tailing Elevator Auger Extended Wear	89.375" AM84400769	\$ 609.30	
CR970, CR980, CR9070, CR9080	Bottom Tailing Elevator Auger Extended Wear	99.625" AM84078346	\$ 1095.24	

Augers & Components—Grain Delivery Leveling

All augers are made with continuous roll-formed fighting for accuracy and durability.



Application	Description	Part Number	Retail Price	Core
(CR920, CR940, CR960, CR970, CR980 - w/ Grain Tank Covers), CR9040, CR9060	Bubble Up Upper Auger Extended Wear	27.50" AM87283765	\$ 718.43	
CR920, CR940, CR960, CR970, CR9040, CR9060, CR9070, CR9080	Bubble Up Lower Auger Extended Wear	38.625" AM87283749	\$ 640.00	
CR940, CR960, CR970, CR980, CR9040, CR9060, CR9070, CR9080	Bubble Up Upper Auger Tube Extended Wear	34.016" AM87011622	\$ 579.43	
CR920, CR940, CR960, CR970, CR9040, CR9060, CR9070, CR9080	Bubble Up Auger Base Tube Extended Wear	AM84330302	\$ 968.73	
CR920, CR940, CR960, CR970, CR980, CR6090, CR7090, CR8080, CR8090, CR9040, CR9060, CR9065, CR9070, CR9080, CR9090, CX8070, CX8080, CX8090	Bubble Up Auger Liner Repair Sleeve Includes Mounting Bolt Kit	AMX29118	\$ 386.00	
CR920, CR940, CR960, CR970, CR980, CR6090, CR7090, CR8080, CR8090, CR9040, CR9060, CR9065, CR9070, CR9080, CR9090, CR6.80, CR6.90, CR7.90, CR8.80, CR8.90, CX840, CX860, CX880, CX8070, CX8080, CX8090, CX8.80, CX8.90	Bubble Up Auger Liner Repair Sleeve 12-Gauge Steel Includes Mounting Bolt Kit Bubble Up Auger Lower End Plate	AMX29117 AMX29178	\$ 514.00 \$ 70.00	
CR920, CR940, CR960, CR970, CR980, CR6090, CR7090, CR8080, CR8090, CR9040, CR9060, CR9065, CR9070, CR9080, CR6.80, CR6.90, CR7.90, CR8.90, CR9.90, CR10.90, CX840, CX860, CX880, CX8070, CX8090, CX8.80, CX8.90	Bearing 2.838" OD, 1.378" Bore Replaces 80212606, 80212607, 84814912, 87605590	HC207-22	\$ 23.06	
(CR940, CR960, CR970, CR980 ASN HAJ101877), CR9040, CR9060, CR9070, CR9080	Bubble Up Upper Auger Extended Wear	42.50" AM87283757	\$ 778.46	
TR70, TR75, TR76, TR85, TR86, TR87, TR88	Bubble Up Auger Extended Wear, 8.50" Fighting Diameter, Left Hand Rotation	84.50" AM786011	\$ 446.00	
	Bearing	NPS100RPC	\$ 6.50	
TR89, TR95, TR96, TR97, TR98	Bubble Up Auger 2.25" Fighting Diameter, Left Hand Rotation	87.50" AM86537976	\$ 1035.97	

New Holland®—Combine

Application	Description	Part Number	Retail Price	Core
TR95, TR96, TR97, TR98 BSN 563258	Bubble Up Auger Right Hand Rotation	88" AM86550393	\$ 893.63	
	Bearing	NPS100RPC	\$ 6.50	

Auger Extension Kits

Application	Description	Part Number	Retail Price	Core
CR920, CR940, CR960, CR960A, CR970, CR980, CR6090, CR7090, CR8070, CR8080, CR8090, CR9040, CR9060, CR9065, CR9070, CR9080, CR9090, CX720, CX760, CX780, CX840, CX860, CX6090, CX8040, CX8060, CX8070, CX8080, CX8090	Unloading Auger Extension Kit	AMNH3EXT	\$ 1800.00	
CR920, CR940, CR960, CR960A, CR970, CR980, CR6090, CR7090, CR8070, CR8080, CR8090, CR9040, CR9060, CR9065, CR9070, CR9080, CR9090, CX720, CX760, CX780, CX840, CX860, CX6090, CX8040, CX8060, CX8070, CX8080, CX8090, TR86, TR87, TR88, TR89, TR95, TR96, TR97, TR98, TR99, TX66, TX68	Poly Snout Use w/ AMNH2EXT or AMNH3EXT Unloading Auger Extension Kits	AMNH3EXT-PS	\$ 350.00	
TR86, TR87, TR88, TR89, TR95, TR96, TR97, TR98, TR99, TX66, TX68	Unloading Auger Extension Kit	AMNH2EXT	\$ 2025.00	

Grain Tank Auger Floor Liners

Application	Description	Part Number	Retail Price	Core
CR920, CR940, CR960, CR970, CR970, CR980, CR9040, CR9070	Grain Tank Auger Floor Liner Kit	AMX27431	\$ 434.50	
CR8.90, CR9.90, CR10.90, TX36	Grain Tank Auger Floor Liner Kit High Capacity Unload System Includes Stainless Steel Panels for both Grain Tank Auger Troughs, Rivets and Installation Instructions Replaces 84478565	AM84529552	\$ 525.00	
TR70, TR75, TR85, TR95, TR86, TR96	Grain Tank Auger Floor Liner Kit	AMX27430	\$ 220.00	
CR6090, CR7090, CR8080, CR8090, CR9040, CR9060, CR9065, CR9070, CR9080, CR9090	Grain Tank Auger Floor Liner Includes Stainless Steel Panels for both Grain Tank Auger Troughs, Rivets and Installation Instructions Replaces 87315123, 87662994	AM87662984	\$ 750.00	
CR920, CR940, CR960, CR970, CR980, CR9040, CR9060, CR9065, CR9070, CR9080, CR9090	Sump Liner Kit 4-Piece	AMX29160	\$ 257.00	

Chaffers—Short Finger Top

Adjustable short finger chaffers with 1 1/8" wire spacing. For use in cereal and fine seed crops. Our presieves feature 1 1/8" wire spacing.

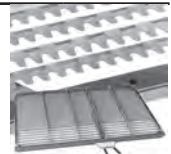

Application	Description	Part Number	Retail Price	Core
TR89, TR95 ASN 501851, TR96, TR97, TR98, TR99	Short Finger Top Chaffer	53.91" x 47.88" AM802398	\$ 663.00	
CR920, CR940, CR960, (CR6090, CR7090 - A4 Prior to 12/09/2012), CR8080 (A4), CR9040, CR9060, CR9065, (CR6.80, CR6.90 - Non-Elevation 11/06/2015 and Later), (CR7.90 - MY15, MY16 11/06/2015 and Later or MY17 Prior to 11/06/2015)	Short Finger Top Chaffer (1) Required	59.125" x 51.75" AM87109828	\$ 665.00	
CR6090*, CR7090*, CR8080*, CR6.80**, CR6.90**, CR7.90** *G4 Models Only **Prior to MY18	Short Finger Top Chaffer Closed Slat (1) Required	59.125" x 51.75" AM87109836	\$ 642.00	

Prices Subject to Change without Prior Notice. The use of original equipment manufacturer (OEM) part numbers or trademarks, e.g. Case® and John Deere®, are for reference purposes only and for indicating product use and compatibility. Our company and the listed replacement parts contained herein are not sponsored, approved or manufactured by the OEM. All parts are New unless designated Reman in the description.

New Holland®—Combine

New Holland®—Combine

Application	Description	Part Number	Retail Price	Core
CR970, CR980, CR8090, CR9070, CR9080, CR9090, (CR8.90, CR9.90 - Prior to MY18), CR10.90 (Non-Elevation), CX840, CX860, CX880, CX8070, CX8080, CX8090, CX8.80, CX8.90	Short Finger Top Chaffer Closed Slat, 1 5/8" Spacing Double Handle, Manual Adjust (2) Required	56.813" x 30.938" AM87109838	\$ 392.00	
CR970, CR980, CR8090 (A4), CR9080 (Non-Elevation), (CR8.90, CR9.90 - Prior to MY18), (CX8070, CX8080, CX8090 - A4 or ASN D600 Prior to 04/2011)	Short Finger Top Chaffer Closed Slat, 1 1/8" Spacing (2) Required	56.813" x 30.938" AM87109830	\$ 485.00	
TR89, TR95 ASN 501851, TR96, TR97, TR98, TR99	Short Finger Top Chaffer Extension (1) Required	AM771088	\$ 413.00	
CR8090 (A3 and A4), CR9070 (Non-Elevation), CR9080, CR9090 (A4), (CR8.90, CR9.90 - MY16 and MY17 11/06/2015 and Later)	Short Finger Chaffer Precleaner 1 1/8" Spacing Replaces 84084942	29.878" x 61.938" AM87109817	\$ 420.00	
CR6090*, CR7090*, CR8080*, CR6.80**, CR6.90**, CR7.90** *A4 Prior to 12/09/2012 **Prior to MY18 Before 11/06/2015	Presieve (1) Required Replaces 84084941, 87109824	29.878" x 51.75" AM87109815	\$ 360.00	
CR6090, CR7090, CR8080, CR8090, CR9040, CR9060, CR9065, CR9070, CR9080, CR9090, CX8080, CX8090	Chaffer Actuator Replaces 47421232	AM84208481	\$ 525.00	

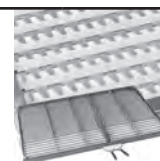

Chaffers—Long Finger Top

Adjustable long finger chaffers with 1 5/8" wire spacing. For use in large seed crops such as corn and beans. Our Presieves feature 1 1/8" or 1 5/8" wire spacing.

Application	Description	Part Number	Retail Price	Core
TR70, TR75, TR76, TR85, TR86, TR87, TR88	Long Finger Top Chaffer	38.91" x 47.88" AM204636	\$ 438.02	
TR70, TR75, TR76, TR85, TR86, TR87, TR88	Long Finger Top Chaffer Dual Adjust	38.91" x 47.88" AM804233	\$ 829.00	
TR89, TR95 ASN 501851, TR96, TR97, TR98, TR99	Long Finger Top Chaffer Dual Adjust	53.91" x 47.88" AM804235	\$ 715.00	
CR940, CR960, CR6090, CR7090, CR8080, CR9040, CR9060, CR9065, (CR6.80, CR6.90, CR7.90 - Prior to MY18)	Long Finger Top Chaffer 1 5/8" Spacing (1) Required	59.125" x 51.75" AM87109832	\$ 610.00	
CR970, CR980, CR8090, CR9080 (A3), CR9090 (Non-Elevation), (CR8.90, CR9.90 - Prior to MY18), (CX8070 A3, A4 or ASN D600 Prior to 04/2011), (CX8080 A3, A4, Elevation or ASN D600 Prior to 04/2011), (CX8090 A4, Elevation or ASN D600 Prior to 04/2011), CX8.80, CX8.90	Long Finger Top Chaffer 1 5/8" Spacing (2) Required	56.813" x 30.938" AM87109834	\$ 450.00	
CR970, CR980, CR6090, CR7090, CR8090, CR9070, CR9080 (A3 or USA), CR9090 Non-Elevation, CR6.80, CR6.90, CR7.90, (CR8.90, CR9.90 - MY15, MY16 and MY17)	Long Finger Chaffer Precleaner 1 5/8" Spacing (2) Required Replaces 84083981, 87042470, 87105820	29.878" x 61.938" AM87109826	\$ 395.00	
CR6090, CR7090, CR8090, CR9040, CR9060, CR9065, (CR6.80, CR6.90, CR7.90 - Prior to MY18)	Presieve Corn, Galvanized 1 1/8" Spacing (1) Required	29.878" x 51.75" AM87109819	\$ 638.50	
CR8090, CR9070, CR9080 (A3), CR9090 (Non-Elevation), (CR8.90, CR9.90 - Prior to MY18)	Presieve Corn, Galvanized 1 5/8" Spacing (1) Required Replaces 84083263	29.88" x 61.93" AM87109821	\$ 801.28	
CR6090, CR7090, CR8080, CR8090, CR9040, CR9060, CR9065, CR9070, CR9080, CR9090, CX8080, CX8090	Chaffer Actuator Replaces 47421232	AM84208481	\$ 525.00	

New Holland®—Combine



Chaffers—Adjustable Air Foil

Application	Description	Part Number	Retail Price	Core
CR920, CR940, CR960, CR970, CR980, CR6090, CR7090, CR8080, CR8090, CR9040, CR9060, CR9070, CR9080, CR9090, CR6.80, CR6.90, CR7.90, CR8.90, CR9.90, CX8070, CX8080, CX8.80, CX8.90	Adjustable Air Foil Top Chaffer Galvanized Double Handle, Manual Adjust (2) Required	56.813" x 30.94" AM87109842	\$ 1207.88	
CR6090, CR7090, CR8080, CR8090, CR9040, CR9060, CR9070, CR9080, CR9090, CX8080, CX8090	Chaffer Actuator Replaces 47421232	AM84208481	\$ 525.00	

Sieves—Lower

Adjustable, blunt, short and long finger bottom sieves with 1 1/8" and 1 5/8" wire spacing. For use in cereal and fine seed grains.

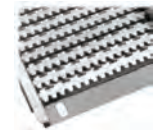

Application	Description	Part Number	Retail Price	Core
TR89, TR95 ASN 501851, TR96, TR97, TR98, TR99	Blunt Finger Bottom Sieve	53.91" x 47.88" AM771089	\$ 652.00	
CR920, CR940, CR960, CR6090, CR7090, CR8080, CR9040, CR9060, CR9065, (CR6.80, CR6.90, CR7.90 - Non-Revelation)	Short Finger Bottom Sieve Galvanized, Closed Slat, 1 5/8" Spacing (1) Required Replaces 86999992	59.125" x 51.75" AM87109848	\$ 510.00	
CR920, CR940, CR960, (CR9040, CR9060 BSN YAG113786), CR9065	Short Finger Bottom Sieve Galvanized, 1 1/8" Spacing (1) Required Replaces 84319322	59.125" x 51.75" AM87109844	\$ 550.00	
CR970, CR980, CR9070 BSN YAG113786, CR9080	Short Finger Bottom Sieve 1 1/8" Spacing (2) Required	56.813" x 30.938" AM87109846	\$ 485.00	
CR970, CR980, CR8090, CR9070, CR9080, CR9090, CR8.90, CR9.90 (A4, A4B, MY15, MY16 and MY17), (CR10.90, CX8.80, CX8.90 - A4), CX8070, CX8080, CX8090	Long Finger Bottom Sieve Galvanized, 1 5/8" Spacing (2) Required Replaces 84400473	56.813" x 30.938" AM87109850	\$ 470.00	
CR920, CR940, CR960, CR970, CR980, CR9040, CR9060, CR9065, CR9070, CR9080, CX840, CX880, CX8070, CX8080, CX8090	Sieve Adjuster Replaces 87011813, 87378807, 87387458	AM84335407	\$ 525.00	

Chaffer and Sieve Frames and Components

Application	Description	Part Number	Retail Price	Core
CR970, CR980, CR9070, CR9080	Chaffer Shoe Frame, Upper, Wide Replaces 84462369	AM87491650	\$ 2507.69	
CR920, CR940, CR960, CR970, CR980, CR6090, CR7090, CR8080, CR8090, CR9040, CR9060, CR9065, CR9070, CR9080, CR9090, CR6.80, CR6.90, CR7.90, CR8.90, CR9.90	Shaker Shoe Arm, Upper	AM87314041	\$ 158.20	
CR6090, CR7090, CR8080, CR8090, CR9040, CR9060, CR9065, CR9070, CR9080, CR9090, CR6.80, CR6.90, CR7.90, CR8.90, CR9.90, CR10.90, CX8080, CX8090, CX8.80, CX8.90	Shaker Shoe Arm, Lower	AM87562561	\$ 93.92	
CR920, CR940, CR960, CR970, CR980, CR6090, CR7090, CR8080, CR8090, CR9040, CR9060, CR9065, CR9070, CR9080, CR9090, CR6.80, CR6.90, CR7.90, CR8.90, CR9.90, CR10.90, CX8080, CX8090, CX8.80, CX8.90	Shaker Shoe Drive Arm	AM87317702	\$ 232.41	

New Holland®—Combine

New Holland®—Combine

Application	Description	Part Number	Retail Price	Core
CR920, CR940, CR960, CR970, CR980, CR6090, CR7090, CR8080, CR8090, CR9040, CR9060, CR9065, CR9070, CR9080, CR9090, CR6.80, CR6.90, CR7.90, CR8.90, CR9.90	Shaker Shoe Drive Arm, Upper	Right Hand AM87314573	\$ 116.89	
		Left Hand AM87314571	\$ 126.10	
CR920, CR940, CR960, CR970, CR980, CR6090, CR7090, CR8080, CR8090, CR9040, CR9060, CR9065, CR9070, CR9080, CR6.80, CR6.90, CR7.90, CR8.90, CR9.90, CR10.90, CX840, CX860, CX880, CX8070, CX8080, CX8090, CX8.80, CX8.90	Bearing Housing, Upper Shoe Drive Replaces 80442901, 84032313, 84097461	AM84446877	\$ 10.80	
CR920, CR940, CR960, CR970, CR9040, CR9060, CR9070, CX840, CX860, CX880, CX8070, CX8080, CX8090	Bearing Housing Half, Shaker Shoe Replaces 80320033	AM320033	\$ 11.33	
CR920, CR940, CR960, CR970, CR980, CR6090, CR7090, CR8080, CR8090, CR9040, CR9060, CR9065, CR9070, CR9080, CR9090, CR6.80, CR6.90, CR7.90, CR8.90, CR9.90, CR10.90, CX840, CX860, CX880, CX8070, CX8080, CX8090, CX8.80, CX8.90	Roller, Cleaning Shoe Pivot Frame Self-Leveling Replaces 89504221	AM434817	\$ 25.92	
CR6090, CR7090, CR8080, CR8090, CR9070, CR9080, CR9090, CR6.80, CR6.90, CR7.90, CR8.90, CR9.90, CR10.90, CX840, CX860, CX880, CX8070, CX8080, CX8090, CX8.80, CX8.90	Rubber Bushing, Upper Shaker Shoe Drive Replaces 442446, 80442446	AM84459072	\$ 39.19	
CR920, CR940, CR960, CR970, CR9040, CR9060, CR9070, CX840, CX860, CX880, CX8070, CX8080, CX8090, TR70, TR85, TR86, TR87, TR88, TR89, TR95, TR96, TR97, TR98, TR99	Rubber Bushing, Shaker Shoe Replaces 190068, 398810	AM84000052	\$ 4.76	
CR920, CR940, CR960, CR970, CR9040, CR9060, CR9070, CX840, CX860, CX880, CX8070, CX8080, CX8090	Bushing, Upper Shaker Shoe 0.64" ID, 2.05" Long	AM84052651	\$ 6.01	
	Bushing, Upper Shaker Shoe Replaces 80338222	AM338222	\$ 4.03	
CR920, CR940, CR960, CR970, CR980, CR6090, CR7090, CR8080, CR8090, CR9040, CR9060, CR9065, CR9070, CR9080, CR9090, CR6.80, CR6.90, CR7.90, CR8.90, CR9.90, CR10.90, CX840, CX860, CX880, CX8070, CX8080, CX8090, CX8.80, CX8.90, TX66, TX68	Bushing, Upper Shoe Arm Replaces 84097509, 84320630, 89811082	AM9811082	\$ 76.26	
CR920, CR940, CR960, CR970, CR980, CR6090, CR7090, CR8080, CR8090, CR9040, CR9060, CR9065, CR9070, CR9080, CR9090, CR6.80, CR6.90, CR7.90, CR8.90, CR9.90, CR10.90, CX840, CX860, CX880, CX8070, CX8080, CX8090	Upper Shoe Drive Support	Right Hand AM84320472	\$ 159.79	
	Middle Pivot Plate	Left Hand AM84320470	\$ 132.78	
CR920, CR940, CR960, CR970, CR6090, CR7090, CR8080, CR8090, CR9040, CR9060, CR9065, CR9070, CR9080, CR9090, CR6.80, CR6.90, CR7.90, CR8.90, CR9.90, CX840, CX860, CX880, CX8070, CX8080, CX8090	Upper Shoe Drive Support	Right Hand AM84334453	\$ 36.21	
	Lower Bushing Mount	Left Hand AM84334452	\$ 47.91	

Grain Pans and Components

Application	Description	Part Number	Retail Price	Core
CR920, CR940, CR960, CR970, CR980, CR6090, CR7090, CR8080, CR8090, CR9040, CR9060, CR9070, CR9080, CR9090, CR6.80, CR6.90, CR7.90, CR8.90, CR9.90	Grain Pan Canvas Seal Replaces 87376933	AM87376934	\$ 26.00	
CR920, CR940, CR960, CR6090, CR7090, CR8080, CR8090, CR9040, CR9060, CR9065, CR9070, CR9080, CR9090, CR6.80, CR6.90, CR7.80, CR7.90, CR8.90, CR9.90	Grain Pan Canvas Seal	AM87391543	\$ 28.00	

New Holland®—Combine



Straw Chopper Blades and Components

Hardened-steel chopper blades.

Application	Description	Part Number	Retail Price	Core
TR70, TR75, TR85	Straw Chopper Blade Kit Set of 3 Hardened-Steel Blades Includes Hardware	AM71310275	\$ 20.00	
TR87, TR88, TR95 ASN 501601, TR96	Ball Bearing, w/ Straw Chopper Rotor Replaces 80609150, 86533335, B92630	AM86575514	\$ 94.90	

Sickle Knife Heads



Application	Description	Part Number	Retail Price	Core
Platforms: 71C, 73C, 74C, 970, 971, 972, 973	Sickle Knife Head Single Drive	AM848094	\$ 90.00	

Auger Components—Bare Header / Platform

Application	Description	Part Number	Retail Price	Core
Platforms: 740CF, 760CG, 790CP, 880CF	Finger Holder	AM84362468	\$ 14.00	
Platforms: 740CF, 760CG, 790CP, 840CD, 880CF	Auger Finger	AM84194057	\$ 15.00	
Draper Platforms: 82C, 83C, 86C	Auger Finger Sold in Multiples of 5, Priced Individually Replaces 87561023	AM47548630	\$ 9.00	
Platforms: (72C, 74C BSN PNL017801), 82C, 83C, 84C, 86C, 760CR Replaces 87666079, 87051323, 87685315	Finger Guide Use w/ AM1302699C1 Finger	AM87620690	\$ 3.75	

Sickle Drives and Components

Application	Description	Part Number	Retail Price	Core
Platforms: 71C, 72C, 73C, 74C, 720CG	Wobble Box	AM85000175	\$ 1147.00	
Platforms: 82C, 83C, 84C, 86C	Wobble Box	AM338670A1	\$ 1575.00	
Platforms: 740CF, 760CG	Wobble Box	AM87724927	\$ 1075.00	



Reel Components

Application	Description	Part Number	Retail Price	Core
Platforms: 71C, 72C, 73C, 74C, 92C, 94C, 740CF Replaces 783707, 86608282, 86620758	Reel Tine Nylon, Double Wing Unit, 6" Spacing Includes Hardware Sold in Multiples of 25, Priced Individually	AMX27222	\$ 2.25	
Platforms: 71C, 72C, 73C, 74C, 92C, 94C, 740CF Replaces 86608284, 86620757	Reel Tine, Right Hand Wing 6" Spacing, Includes Hardware	AMX29057	\$ 3.76	
Platforms: 71C, 72C, 73C, 74C, 92C, 94C, 740CF Replaces 86608283, 86620755	Reel Tine, Left Hand Wing Nylon, 6" Spacing Includes Hardware	AMX29056	\$ 3.76	
Platforms: 83C, 86C	Reel Tine, HD Sold in Multiples of 25, Priced Individually	AM87561020	\$ 3.00	

New Holland®—Combine

Application	Description	Part Number	Retail Price	Core
Platforms: 92C, 971, 973, 994, 994D Replaces 1989438C1, 9842263, B93868, B94710	Reel Tine Nylon, 3-Piece Double Wing Unit 4.50" Spacing Includes Hardware Sold in Multiples of 25, Priced Individually Replaces center tine, some modification required for right and left hand sides	AMTINE	\$ 2.00	
Platforms: 971, 973 Replaces 1970586C1, B93866, B1970586C1	Reel Tine For Platforms w/ Tear Drop Bats and Tines Mounted to Rear of the Steel Bat	AM1970586C1	\$ 1.58	
Draper Platforms: 88C, 92C, 94C, 994, 994D	Reel Tine, Flexible Tear Drop Style Replaces 276306M1, 700708862, 800714195	AM86562205	\$ 2.26	
Draper Platforms: 421HB, 425HB, 430HB, 436HB, 840CD, 880CF	Reel Tine Sold in Multiples of 25, Priced Individually Replaces 48056250, 48151645, 84566589	AM47392794	\$ 3.60	
Platforms: 71C, 72C, 73C, 74C, 971, 973	Quick Fingers, 10 Pack	AMX27550	\$ 22.00	
Draper Platform: 86C	Quick Finger Repair Tine	AMX41116	\$ 2.95	
Draper Platforms: 94C, 994, 994D, Rigid Platforms: 71C, 72C, 971, Flex Platforms: 73C, 74C, 973	Reel Bearing Replaces 84469382, 89842300, 9842300	AM1347084C1	\$ 1.95	
Draper Platforms: 92C, 94C, 994, 994D, Flex Platforms: 73C, 74C, 973, Rigid Platforms: 71C, 72C, 971	Eccentric Bushing, Pickup Reel - Female Replaces 86518392	AM114951A1	\$ 2.50	
Draper Platforms: 18HB, 21HB, 25HB, 30HB, 36HB, 94C, 994, 994D, Rigid Platforms: 71C, 72C, 971, 973, Flex Platforms: 73C, 74C	Eccentric Bushing, Pickup Reel - Male Replaces 86518393	AM114952A1	\$ 2.50	
Platforms: 72C, 74C	Reel Drive Sprocket 51 Tooth, 1.57" ID Replaces 87036543	AM129973A1	\$ 85.00	
Platform: 972	Reel Repair Kit, Roll Pin Style For reel pipes w/ 4 1/2" reel finger spacing and roll pins or plastic washers on each side of the plastic bearing	AMBN-KITRP	\$ 29.50	

Platform Components

Application	Description	Part Number	Retail Price	Core
Platforms: 72C, 74C	Reel Drive Sprocket 17 Tooth, 1.125" Bore w/ Keyway	AM87035837	\$ 35.00	
Platform: 740CF	Support Bracket, Left Hand	AM84296810	\$ 160.00	
Platforms: 740CF, 760CG	Sprocket 47 Tooth For Slow RPM Auger Drive Replaces 47579289	AM84209468	\$ 265.00	
Platforms: 740CF, 840C	Sprocket Assembly 43 Tooth, 80 Pitch	AM84176718	\$ 210.00	
Platform: 840CD, 880CF - 11/2011 and Later	Turret Flap	AM47553645	\$ 75.00	
Platform: 740CF	Spring Nut, Upper	AM124366A1	\$ 50.00	
	Spring Plug, Lower	AM1313104C1	\$ 40.00	
CR6090, CR7090, CR8080, CR8090, CR9080, CR9090, CR6.80, CR6.90, CR7.90, CR8.90, CR9.90, CR10.90, CX8070, CX8080, CX8090, CX8.80, CX8.90, Forage Harvesters: FR450, FR480, FR500, FR550, FR600, FR650, FR700, FR780, FR850	Quick Male Coupling, Header Coupler Replaces 47472035, 84435502	AM47360258	\$ 32.00	
	Quick Male Coupling, Header Coupler Replaces 47870683, 87691267	AM84580534	\$ 21.00	

New Holland®—Combine

Row Crop Dividers

Eliminate costly grain loss from knocked down plants. Change from short to long dividers in minutes. Safer transportation and easy storage. Sectional design allows you to replace only the damaged piece which saves you money.



Application	Description	Part Number	Retail Price	Core
Flex Platform: 972	Complete Set of Dividers, Long	AMSCD400FD	\$ 1350.00	
	Components:			
	Rear Divider	1 AMSCD100FD-RH	\$ 400.00	
	Rear Divider	1 AMSCD100FD-LH	\$ 400.00	
	Divider Front Wing Section, Long	2 AMSCD200	\$ 550.00	
	Divider Nose Bar	2 AMSCD300	\$ 50.00	
Flex Platform: 972	Complete Set of Dividers, Short	AMSCD500FD	\$ 1175.00	
	Components:			
	Rear Divider	1 AMSCD100FD-RH	\$ 400.00	
	Rear Divider	1 AMSCD100FD-LH	\$ 400.00	
	Divider Nose Bar	2 AMSCD300	\$ 50.00	
	Short Divider Tip	2 AMSCD250	\$ 75.00	
Flex Platform: 972	Short Divider Tip	AMSCD250	\$ 75.00	

Guards and Cutter Bar Parts



Application	Description	Part Number	Retail Price	Core
Platforms: 71C, 72C (20' Single Drive BSN PNL017001 or 20', 25' and 30' Double Drive BSN PNL017001), 73C, 74C (20', 25' and 30' Double Drive BSN PNL017001), 970, 971, 972, 973, Draper Platforms: 1116D Replaces 219191, 748178, 858778	Knife Guard, Double Pronged w/ Trash Bar Use w/ 3" Cutter Bar Knife	AM86615982	\$ 11.75	
Platforms: 71C, 72C (25' Single Drive BSN PNL071001 or 25' and 30' Double Drive BSN PNL071001), 73C, 74C (20', 25' and 30' Double Drive BSN PNL071001), 971, 973, 1116H, Draper Platform: 1116D	Knife Guard, Double Pronged w/ Trashbar Use w/ 3" Cutter Bar Knife For Drive Head End Replaces 9801347, 86521590, 86553346, 86615983, 87042358, 87042360	AM86615984	\$ 17.00	
Platforms: 71C, 72C, 73C, 74C, 971, 973	Knife Guard 4-Prong Bottom Guard	AM87015708	\$ 10.00	
Platforms: 72C*, 74C** *20' and 25' Single Drive, 25' Double Drive SN PNL017001-PNL018301, or 30' Double Drive ASN PNL017000 **20' and 25' Single Drive, 20' and 25' Double Drive SN PNL017001-PNL018301, or 30' and 35' Double Drive ASN PNL017000	Knife Guard, Double Pronged w/o Trashbar Use w/ 3" Cutter Bar Knife For Drive Head End Replaces 483500R3, 1326787C1, 1326787C2, 1326787C3	AM87442329	\$ 12.25	
	Knife Guard, Double Pronged w/o Trashbar Use w/ 3" Cutter Bar Knife Replaces 334305A1, 87442324	AM1307299C2	\$ 12.00	
Platforms: 740CF (25', 30' and 35' Single Drive or 30' and 35' Double Drive), Draper Platforms: 840CD, 880CF	Knife Guard, Double Pronged w/o Trashbar Use w/ 3" Cutter Bar Knife	AM87702973	\$ 16.00	
Platform: 740CF, Draper Platforms: 840CD, 880CF (40' Platform)	Knife Guard, Double Pronged w/o Trashbar Use w/ 3" Cutter Bar Knife	AM87702974	\$ 15.00	

New Holland®—Combine

New Holland®—Combine

Application	Description	Part Number	Retail Price	Core
Draper Platforms: 84C, 86C	Knife Guard, Double Pronged Drive Head Guard (3) Required per Single Knife, (6) Required per Double Knife	AM118345	\$ 12.00	
	Knife Guard First Guard, Left Hand w/ Cross Bar Double Heat Treated (1) Required per Head Replaces 47709129, 87422039	AM118301	\$ 13.00	
	Knife Guard Last Guard, Right Hand w/ Cross Bar Double Heat Treated (1) Required per Head Replaces 47709128, 87422040	AM118302	\$ 13.00	
Grain Platform: 760CG	Knife Guard, Double Pronged Special, Center w/ Cross Bar	AM86615983	\$ 13.50	
Platforms: 84C, 86C	Sickle Section, Coarse 3.25" Long, 3" Wide, 2.125" Hole Spacing Sold in Multiples of 25, Priced Individually	AM158516	\$ 1.50	
Platforms: 72C, 74C	Knife Clip, Low Profile Adjustable Replaces 1307280C3, 71346158, 86630786, H84412	AMX29115	\$ 14.75	
	Knife Clip, Low Profile Replaces 1307280C3, 71346158, 86630786, H84412	AMX27554	\$ 3.95	
Platforms: 84C, 86C Replaces 338591A1, 84399893	Hold Down Clip Hi-Arch Includes Nut and Bolt	AM118499	\$ 6.85	

Hydraulic Oil Coolers

Application	Description	Part Number	Retail Price	Core
Speedrower Swathers: 200, 240	Condenser w/ Oil Cooler Core: 30 7/8" x 31" x 3.80" Replaces 87340522	AM87490300	\$ 1070.00	



Draper Belts and Components

Application	Description	Part Number	Retail Price	Core
Platforms: 82C, 86C - w/ Center Delivery	Draper Center Feeder Belt 78.50" x 63.46" Single V-Guide	AM87560973	\$ 415.00	
Platforms: 83C, 86C Replaces 172193	Draper Belt, HD 20' Right and Left Hand, 41.60" x 158.24" Single V-Guide	AM47611890	\$ 450.00	
Platforms: 83C, 86C Replaces 172194, 47563846, 87560977, 87605706	Draper Belt, HD 25' Right and Left Hand, 41.60" x 217.24" Single V-Guide	AM47767475	\$ 575.00	
Platforms: 82C, 83C, 86C - w/ Double or Triple Delivery	Draper Belt, HD 30' Right and Left Hand, 41.60" x 277.24" Single V-Guide	AM47489938	\$ 645.00	
Platforms: 82C, 83C, 86C - w/ Double Delivery Replaces 47679354	Draper Belt, HD 35' Right Hand, 41.60" x 337.24" Single V-Guide	AM87560979	\$ 750.00	

New Holland®—Combine

Application	Description	Part Number	Retail Price	Core
Platforms: 83C, 86C Replaces 47767476, 51471583, 84122227	Draper Belt, HD 45' Right and Left Hand, 41.60" x 457.24" Single V-Guide	AM84399888	\$ 1019.00	
Platforms: 83C, 86C - w/ Double Delivery Replaces 47610129, 47679353	Draper Belt, HD 40' Right and Left Hand, 41.60" x 397.24" Single V-Guide	AM87560980	\$ 1004.00	
Platform: 84C	Draper Center Feeder Belt 38.40" x 97.00" Single V-Guide For 38.00" Feed Deck	AM338361A1	\$ 338.00	
Platform: 84C w/ Center Delivery Replaces 430272A1	Draper Center Feeder Belt 45.00" x 97.00" Single V-Guide For 45.00" Feed Deck	AM114267	\$ 319.00	
Platform: 84C w/ Double Delivery	Draper Belt, HD 30' Right and Left Hand, 41.60" x 309.00" Single V-Guide	AM346022A1	\$ 674.00	
	Draper Belt, HD 36' Right Hand, 41.60" x 405.00" Single V-Guide	AM372312A1	\$ 934.00	
	Draper Belt, HD 36' Left Hand, 41.60" x 357.00" Single V-Guide	AM372311A1	\$ 783.00	
Platform: 84C w/ End Delivery	Draper Belt, HD 36' Right Hand - Outboard Deck, 41.60" x 154.00" Single V-Guide	AM372321A1	\$ 485.00	
	Draper Belt, HD 39' Right Hand - Outboard Deck, 41.60" x 182.00" Single V-Guide	AM87446869	\$ 448.00	
Platform: 84C w/ Center Delivery	Draper Belt, HD 39' Right Hand, 41.60" x 433.00" Single V-Guide	AM87446870	\$ 940.00	
	Draper Belt, HD 39' Left Hand, 41.60" x 389.00" Single V-Guide	AM87446868	\$ 891.00	
Platforms: 92C, 94C, 994	Draper Center Feeder Belt 68.75" x 65.00"	AM86616916	\$ 390.00	
Platform: 94C ASN 091101 w/ Center Delivery	Side Draper Belt 42', Right or Left Hand, 41.75" x 448.00" Single V-Guide Replaces 84388981	AM83725	\$ 879.00	
	Side Draper Belt 36', Right or Left Hand, 41.75" x 374.00" Single V-Guide Replaces 84480130	AM83721	\$ 759.00	
Platform: 94C BSN 091100 - w/ Center Delivery	Side Draper Belt Right or Left Hand, 42.00" x 448.00" No Guide Replaces 84480163	AM83466	\$ 672.00	
	Side Draper Belt Right or Left Hand, 42.00" x 423.00" No Guide Replaces 84480464	AM83467	\$ 643.00	
	Side Draper Belt Right or Left Hand, 42.00" x 374.00" No Guide Replaces 84480154	AM70363	\$ 577.00	
Platform: 94C BSN 091100 w/ Center Delivery	Side Draper Belt Right or Left Hand 42.00" x 174.00" No Guide Replaces 84480149	AM70362	\$ 500.00	

New Holland®—Combine







Application	Description	Part Number	Retail Price	Core
Platform: 840CD, 880CF Replaces 47932768, 84289411	Draper Center Feeder Belt 42.00" x 60.24" Single V-Guide	AM47435658	\$ 264.00	
Platforms: 840C Rigid, 880CF, 840CD	Draper Center Feeder Belt 42.00" x 50.24" Single V-Guide Replaces 47377069, 47435660	AM47932836	\$ 264.00	
Platform: 840C	Side Draper Belt 25' Right and Left Hand, 41.60" x 207.40" Single V-Guide	AM47371562	\$ 576.00	
Platforms: 840C, 880CF Replaces 84307562	Side Draper Belt 30' Right and Left Hand, 41.60" x 267.40" Single V-Guide	AM47371565	\$ 638.00	
Platforms: 840C, 880CF Replaces 87743629	Side Draper Belt 35' Right and Left Hand, 41.60" x 327.40" Single V-Guide	AM47371567	\$ 750.00	
Platforms: 840C, 880CF Replaces 87478999	Side Draper Belt 40' Right and Left Hand, 41.60" x 387.40" Single V-Guide	AM84487818	\$ 873.00	
Platforms: 840C, 880CF Replaces 87753630	Side Draper Belt 45' Right and Left Hand, 41.60" x 447.40" Single V-Guide	AM47371571	\$ 983.00	
Platforms: 840C, 880CF	Draper Belt Repair Kit For 41.60" Belt Includes 34" Repair Section of RAPTOR Material, Pre-Punched for Connector, (2) Steel Tube Connectors and Hardware	AM1014727	\$ 190.00	
Platforms: 82C, 83C, 86C	Steel Tube Connector Set For 41.60" Belts 39.80" Long Includes (2) Steel Tube Connectors and Hardware	AM1002377	\$ 40.00	
Platforms: Most Models	Steel Tube Connector 10 Holes, 38.78" Long	AM1005840	\$ 33.00	

Poly Skid Plates and Components







Application	Description	Part Number	Retail Price	Core
Platforms: 82C, 83C, 86C	Poly Skid Plate, Right End Replaces 87561542	AM165386	\$ 50.00	
	Poly Skid Plate, Left End Replaces 87561540	AM165188	\$ 50.00	
	Poly Skid Plate, Center Replaces 47414657, 87561539	AM165208	\$ 60.00	
	Poly Skid Plate Transition Pan (4) Required Replaces 87597512	AM151551	\$ 45.00	
Draper Platforms: 82C, 83C, 84C ASN PPP001119 w/ 30' or 36' Platform, 86C	Poly Skid Plate, Cutterbar	AM87532221	\$ 9.50	
Platforms: 4F30, 4R30, 4F35, 4R35, 4F40, 4R40, 4F45, 4R45, 740CF, 840CD, 880CF	Skid Shoe Narrow	AM251206A2	\$ 17.00	
Platforms: 840C, 880CF, 740CF, 742CF	Skid Shoe	AM377580A1	\$ 8.00	

New Holland®—Combine

Lighting

	Application	Description	Part Number	Retail Price	Core
	Swathers: H8000, H8040, H8060, HW305, HW305S, HW325, HW345, HW365	LED Cab Light Kit (6) Round Spotlights, Each Light is 5000 Lumens, 35 Watts, 3 Amps For 12 Volt to 24 Volt Systems Includes Mounting Brackets and Wire Harness for Plug-and-Play Installation	AMTLNH8000	\$ 590.00	
	Universal Equipment	LED Floodlight All-Position Light 4.25" x 4.25" Square Light 2650 Lumens, 48 Watts, 4 Amps For 12 Volt to 24 Volt Systems Includes Mounting Bracket and Stainless Steel Hardware	AMTL105F	\$ 95.00	
	Universal Equipment	LED Floodlight All-Position Light 6.25" x 1.75" Rectangle Light 1300 Lumens, 18 Watts, 1.50 Amps For 12 Volt to 24 Volt Systems Includes Mounting Bracket and Stainless Steel Hardware	AMTL118F	\$ 50.00	
	Universal Equipment	LED Floodlight All-Position Light 5" Round Light 3200 Lumens, 40 Watts, 3.30 Amps For 12 Volt to 24 Volt Systems Includes Mounting Bracket and Stainless Steel Hardware	AMTL180	\$ 89.00	
	Universal Equipment	LED Floodlight All-Position Light Round Light 6900 Lumens, 50 Watts, 4.10 Amps For 9 Volt to 32 Volt Systems Includes Mounting Bracket and Stainless Steel Hardware	AMTL500F	\$ 120.00	
		LED Floodlight All-Position Light 4.30" Round Light 5040 Lumens, 50 Watts, 4.10 Amps For 12 Volt to 24 Volt Systems Includes Stainless Steel Adjustable Mounting Bracket	AMAT305931	\$ 96.00	
	Universal Equipment	LED Floodlight All-Position Light 4.25" Round Light 2650 Lumens, 42 Watts, 3.50 Amps For 12 Volt to 24 Volt Systems Includes Mounting Bracket and Stainless Steel Hardware	AMTL115F	\$ 59.00	
	Universal Equipment	LED Wide Floodlight All-Position Light 5" x 7" Rectangle Light 3800 Lumens, 35 Watts For 12 Volt to 24 Volt Systems	AMX34171	\$ 60.00	
	Universal Equipment	LED Floodlight, Sealed Beam Fender Mount 4.50" Diameter Round Light 1250 Lumens, 18 Watts, 1.50 Amps Trapezoid Pattern For 12 Volt to 24 Volt Systems	AMTL3010	\$ 40.00	
		LED Floodlight Fender Mount 4.50" Diameter Sealed Beam Round Light 1250 Lumens, 18 Watts, 1.20 Amps Trapezoid Pattern For 12 Volt to 24 Volt Systems Lasts 50 times longer than halogen lighting, vibration resistant w/ no filament failures, uses original mount and wiring, Operating temperature of -40°F to 140°F / -40°C to 60°C	AMRE336111	\$ 35.00	





New Holland®—Combine

Application	Description	Part Number	Retail Price	Core
 Universal Equipment	LED Floodlight Fender Mount 4.50" Diameter Sealed Beam Round Light 1440 Lumens, 18 Watts, 1.60 Amps Lasts 50 times longer than halogen lighting, vibration resistant w/ no filament failures, 2-terminal connection, Operating temperature of -40°F to 140°F / -40°C to 60°C	AMRE336112	\$ 67.75	
 Versatile® Sprayers: SX235, SX275, SX240, SX280 Replaces 86038024	LED Floodlight Hood Mount 5.50" x 3.75" Oval Light 3000 Lumens, 35 Watt, 2.90 Amps For 12 Volt to 24 Volt Systems Use Original Mount and Wiring, Plug-and-Play	AMTL8220	\$ 115.00	
	LED Floodlight Hood Mount 5.50" x 3.75" Oval Light 3000 Lumens, 39 Watts, 2.90 Amps For 12 Volt to 25 Volt Systems Includes Connector for Plug-and-Play Installation Replace 86038024, RE180613, RE181282, RE271573	AMRE271574	\$ 92.00	
 Universal Equipment	LED Floodlight Cab and Fender Mount 3.50" x 6" Rectangle Light 3600 Lumens, 40 Watts, 3 Amps	AMX34146	\$ 65.00	
 Universal Equipment	LED Spotlight All-Position Light 4.25" x 4.25" Square Light 1400 Lumens, 27 Watts, 2.20 Amps For 12 Volt to 24 Volt Systems	AMTL100S	\$ 45.00	
 Universal Equipment	LED Spotlight All-Position Light 6.25" x 1.75" Rectangle Light 1300 Lumens, 18 Watts, 1.50 Amps For 12 Volt to 24 Volt Systems Includes Mounting Bracket and Stainless Steel Hardware	AMTL118S	\$ 50.00	
 Universal Equipment	LED Spotlight All-Position Light Round Light 6900 Lumens, 50 Watts, 4.10 Amps For 9 Volt to 32 Volt Systems Includes Mounting Bracket and Stainless Steel Hardware	AMTL500S	\$ 120.00	
 Universal Equipment	LED Trapezoid Light Cab and Fender Mount 4.50" Diameter Round Light 2800 Lumens, 40 Watts, 3.30 Amps Trapezoid Pattern For 12 Volt to 24 Volt Systems Bottom Mount w/ Built-In Heat Sink Includes Mounting Bracket, Long and Short Rubber Bezels and Stainless Steel Hardware	AMTL2080	\$ 95.00	
	LED Trapezoid Light Cab and Rear Fender Mount 4.50" Diameter Round Light 2800 Lumens, 40 Watts, 3.30 Amps Trapezoid Pattern For 12 Volt to 24 Volt Systems Bottom Mount w/ Built-In Heat Sink Includes Mounting Bracket, Long and Short Rubber Bezels and Stainless Steel Hardware	AMX33121	\$ 76.00	
Swather Platforms: 12HS, 14HS, 16HS	Warning Light, Side Marker Amber Lenses	AM367321A1	\$ 30.65	



New Holland®—Combine

Application	Description	Part Number	Retail Price	Core
 Universal Equipment	LED Warning Light Cab, Header or Swather Mount Can be used for Turn Signal, Brake or Running Lights 4.125" Diameter Round Light Double Sided, Amber Lenses 25 Bulbs per Side For 12 Volt to 24 Volt Systems	AMTLFL2	\$ 55.00	
	LED Warning Light Cab, Header or Swather Mount Can be used for Turn Signal, Brake or Running Lights 4.125" Diameter Round Light Double Sided, Amber Lenses 25 Bulbs per Side For 12 Volt to 24 Volt Systems	AMX1910149	\$ 44.00	
 Universal Equipment	LED Warning Light Cab, Header or Swather Mount Can be used for Turn Signal, Brake or Running Lights 4.125" Diameter Round Light Double Sided, Red and Amber Lenses 25 Bulbs per Side For 12 Volt to 24 Volt Systems	AMTLFL3	\$ 55.00	
	LED Warning Light Cab, Header or Swather Mount Can be used for Turn Signal, Brake or Running Lights 4.125" Diameter Round Light Double Sided, Red and Amber Lenses 25 Bulbs per Side For 12 Volt to 24 Volt Systems	AMX33126	\$ 44.00	
 Universal Equipment	LED Magnetic Warning Light All-Position Light 360° Flashing Light, Multiple Patterns 9.50" x 6.75" Rectangle Light Magnetic Base or Solid Mount For 12 Volt to 24 Volt Systems Includes Cigarette Lighter Adapter, Wiring and Switch	AMTL1100	\$ 170.00	
 Universal Equipment	LED Magnetic Warning Light All-Position Light 360° Flashing Light, Multiple Patterns 14" x 6.75" Rectangle Light Magnetic Base or Solid Mount For 12 Volt to 24 Volt Systems Includes Cigarette Lighter Adapter, Wiring and Switch	AMTL1200	\$ 190.00	
Universal Equipment	Warning Beacon 360° Flashing Beacon, Amber Lens For 0.9435" Diameter Pipe Replaces 84337818, AZ44705, AZ101891	AM82018390	\$ 45.64	
 Universal Equipment	LED Warning Beacon 360° Flashing Beacon 2.75" x 5.25" Light Polycarbonate Amber Lens and Housing For 12 Volt to 24 Volt Systems Includes Solid Mounting Pad and Stainless Steel Hardware	AMTL2100	\$ 30.00	
 Universal Equipment	LED Warning Beacon 360° Flashing Beacon, 3 Different Patterns 5" x 10" Light Amber Lens, 48 Watts, 4 Amps For 12 Volt to 24 Volt Systems Brackets Sold Separately	AMX33131	\$ 75.00	
 Universal Equipment	Warning Beacon Bracket	AMX33132	\$ 15.00	

New Holland®—Combine

Application	Description	Part Number	Retail Price	Core
 Universal Equipment	Warning Beacon Bracket	AMX33133	\$ 15.00	
 Universal Equipment	Warning Beacon Bracket	AMX33137	\$ 15.00	
 Universal Equipment	Warning Beacon Bracket	AMX33135	\$ 15.00	
 Universal Equipment	LED Light Bar 4" Long, 1260 Lumens, Cree Bulbs	AMLED4	\$ 45.00	
	LED Light Bar Flood/Spotlight Combo 10" Long, 5700 Lumens, 50 Watts, 4.20 Amps For 12 Volt to 24 Volt Systems Includes Mounting Bracket and Stainless Steel Hardware	AMTL10SRC	\$ 129.00	
	LED Light Bar Floodlight/Spotlight Combo 14" Long, 5400 Lumens, 72 Watts, 6 Amps Die Cast Aluminum Housing, Polycarbonate Lens For 12 Volt to 24 Volt Systems Includes Mounting Bracket and Heavy Duty Stainless Steel Hardware	AMTLB410C	\$ 150.00	
	LED Light Bar Floodlight/Spotlight Combo 30" Long, 13600 Lumens, 150 Watts, 12.50 Amps For 12 Volt to 24 Volt Systems Includes Mounting Bracket and Stainless Steel Hardware	AMTL30SRC	\$ 230.00	
	LED Light Bar 30" Long, 13860 Lumens, Cree Bulbs	AMLED30	\$ 130.00	
	LED Light Bar Floodlight/Spotlight Combo 40" Long, 17300 Lumens, 200 Watts, 16.70 Amps For 12 Volt to 24 Volt Systems Includes Mounting Brackets and Stainless Steel Hardware	AMTL40SRC	\$ 300.00	
	LED Light Bar 40" Long, 18200 Lumens, Cree Bulbs	AMLED40	\$ 160.00	
	LED Light Bar Floodlight/Spotlight Combo 42" Long, 14500 Lumens, 240 Watts, 19 Amps For 12 Volt to 24 Volt Systems Includes Mounting Bracket and Stainless Steel Hardware Replaces 1163691	AMTLB440C	\$ 250.00	
	LED Light Bar, Curved 50" Long, 21500 Lumens, Cree Bulbs	AMLED50C	\$ 190.00	
	 Universal Equipment	LED Magnetic Work Light All-Position Light 3.25" Square Floodlight 900 Lumens Magnetic Base Includes Lithium Ion Battery, Cigarette Lighter and DC Charger	AMTL2460	\$ 79.00

New Holland®—Combine

Application	Description	Part Number	Retail Price	Core
 Universal Sprayers	LED Blue Work Light 4.25" x 4.50" x 3.00" Rectangle Light 2650 Lumens, 42 Watts, 3.50 Amps For 12 Volt to 24 Volt Systems Includes Stainless Steel Hardware and Mounting Bracket	AMTLFL5	\$ 59.00	
 CR920, CR940, CR960, CR970, CR980, CR6090, CR7090, CR8090, CR9040, CR9060, CR9065, CR9070, CR9080, CR9090, CX8070, CX8080, CX8090	Light Switch, Work Light	AM87603462	\$ 39.00	
 CR6.80, CR6.90, CR7.90, CR8.90, CR9.90, CR10.90, CX8.80, CX8.90	Hazard Switch	AM84370689	\$ 35.00	

Cab Components—Miscellaneous

Application	Description	Part Number	Retail Price	Core
CR920, CR940, CR960, CR970	Reman AFS Display Monitor Universal Display Plus Monitor (2) Data Card Ports located on Left Hand Side of Monitor and (2) Electrical Ports located on Bottom of Monitor	AM295133A3	\$ 1650.00	\$ 500.00
CR9080, CR9090	Reman Monitor Replaces 293255A3, 295133A5, 87668610	AM84604338R	\$ 1650.00	\$ 500.00

Tie Rods and Components

Application	Description	Part Number	Retail Price	Core
 CR920, CR940, CR960, CR970, CR9040, CR9060, CR9070, CX840, CX860, CX880, CX8070, CX8080, CX8090	Tie Rod 4.75" Long M30x1.50" Right Hand Thread Replaces 84073399	AM84442906	\$ 47.00	
CR920, CR940, CR960, CR970, CR980, CR6090, CR7090, CR8080, CR8090, CR9040, CR9060, CR9065, CR9070, CR9080, CR9090, CR6.80, CR6.90, CR7.90, CR8.90, CR9.90, CR10.90, CX840, CX860, CX880, CX8070, CX8080, CX8090, CX8.80, CX8.90	Tie Rod Tube, Right Hand	AM84074074	\$ 310.00	

Power Steering Cylinders and Components

Application	Description	Part Number	Retail Price	Core
CR920, CR940, CR960, CR970, CR9040, CR9060, CR9070, CX840, CX860, CX880, CX8070, CX8080, CX8090	Power Steering Cylinder End 3.75" Long M16x1.50" Right Hand Thread Replaces 84073454	AM84814042	\$ 55.00	
CR920, CR940, CR960, CR970, CR980, CR6090, CR7090, CR8080, CR8090, CR9040, CR9060, CR9065, CR9070, CR9080, CR9090, CR6.80, CR6.90, CR7.90, CR8.90, CR9.90, CR10.90, CX840, CX860, CX880, CX8070, CX8080, CX8090, CX8.80, CX8.90	Power Steering Cylinder Seal Kit For Auto-Guidance Enabled Steering Cylinder	AM84455606	\$ 110.00	









New Holland®—Combine



Gas Struts

Application	Description	Part Number	Retail Price	Core
CR920, CR940, CR960, CR970, CR9040, CR9060, CR9070, CX840, CX860, CX880, CX8070, CX8080, CX8090, Swathers: H8040, H8060, HW325, HW345, HW365	Gas Strut, Door Right and Left Hand	AM84320293	\$ 19.00	



Air Conditioning and Components

Application	Description	Part Number	Retail Price
 TR70	Compressor Conversion Kit Tecumseh, York Upright Style to Sanden Style Includes Compressor, Mounting Bracket, Compressor Manifold, Belt, Service Valves and Mounting Hardware	AMX10197	\$ 520.00
 TR86	Compressor Conversion Kit Tecumseh, York Upright Style to Seltec Style Includes Compressor, Mounting Bracket, O-Rings, Belt, Service Valves and Mounting Hardware	AMX10198	\$ 485.00
 Forage Harvesters: 1915, 2100	Compressor Conversion Kit York Style to Aftermarket Sanden Style Includes Compressor, Mounting Brackets, Compressor Manifold, O-Rings and Mounting Hardware See Manufacturer for Oil Type and Quantity	AMX10263	\$ 450.00
 (CR920, CR940 ASN HAJ100801), (CR9040, CR9060 BSN HAJ111001), CR9070	Compressor, Sanden SD7H15HD 12 Volt, w/ 8-Groove Clutch, 5.98" (152 mm) Clutch Diameter, Horizontal Tube O-Ring, Direct Mount Requires Pag Oil 100V, 9.64 oz (285 cc)	AM86993463	\$ 275.00
	Ultra Pag Double End Capped, 100V, 8 oz	AMX10267	\$ 12.00
	Universal Pag Oil, 8 oz	AMX10274	\$ 8.25
 CR6090, CR7090, CR8080, CR8090, CR9090, CR6.80, CR6.90, CR7.90, CR8.90, CR9.90, CR10.90, CX8070, CX8080, CX8090, Forage Harvesters: FR450, FR480, FR500, FR550, FR600, FR650, FR780	Compressor w/ Clutch Replaces 5801558535	AM84279787	\$ 395.00
 TR70, TR75, TR85, TR86, TR95, TR96	Compressor, York Style Left Hand Suction, Rotolock Clutch Not Included Requires Synthetic Ester Oil 100V, See Manufacturer for Oil Quantity	AMX10225	\$ 260.00
	Double Groove Clutch for York Compressor, 7"	AM470	\$ 101.00
	Premium Synthetic Ester Oil, 100V, 12 oz	AMX10273	\$ 11.00
 TR86, TR96, TX36	Compressor, Sanden SD7H15 12 Volt, w/ 2-Groove Clutch, 5.25" (133 mm) Clutch Diameter, Horizontal Tube O-Ring, w/o Charge Ports Requires Synthetic Ester Oil 100V, 10.14 oz (300 cc)	AMX10187	\$ 270.00
	Premium Synthetic Ester Oil, 100V, 12 oz	AMX10273	\$ 11.00
 TR87, TR88, TR89, TR97, TR98, TR99 - Twin Rotor Combines	Compressor, Sanden SD5H1 12 Volt, w/ 2-Groove Clutch, 5.25" Clutch Diameter, 3 1/4" Inside Ear Measurement (Front to Rear), Vertical #8 and #10 O-Ring, w/o Charge Ports, w/ 1-Wire Bullet Connector Requires Pag Oil 100V, 6.00 oz (177 cc)	AM86508521	\$ 195.00
	Ultra Pag Double End Capped, 100V, 8 oz	AMX10267	\$ 12.00
	Universal Pag Oil, 8 oz	AMX10274	\$ 8.25

New Holland®—Combine

Application	Description	Part Number	Retail Price
 Swathers: 2450, 2550	Compressor w/ Dust Cover, Sanden SD7H15 Style 12 Volt, w/ 6-Groove Clutch for Serpentine Belt, 4.92" (125 mm) Clutch Diameter, Vertical #8 and #10 O-Ring Requires Synthetic Ester Oil 100V, 9.13 oz (270 cc)	AM9827954	\$ 260.00
	Premium Synthetic Ester Oil, 100V, 12 oz	AMX10273	\$ 11.00
 Universal Equipment	High Pressure Switch Normally Open, Opens at 305 PSI, Closes at 395 PSI, 7/16"x20 Thread	AMX10276	\$ 35.00
 Universal Equipment	Low Pressure Switch Normally Open, Opens at 6 PSI, Closes at 45 PSI, Standard 7/16"x20 Thread	AMX10277	\$ 55.00
 Universal Equipment	Low Pressure Switch Normally Open, Opens at 35 PSI, Closes at 46 PSI, Standard 7/16"x20 Thread	AMX10278	\$ 42.00
 CR920, CR940, CR960, CR970, CR9040, CR9060, CR9070, CX840, CX860, CX880, Swathers: HW325, HW345, HW365	Low Pressure Switch Normally Open, Opens at 5 PSI, Closes at 18 PSI, 10 mm Metric Thread	AM87000228	\$ 45.00
 CR920, CR940, CR960, CR970, CR980, CR9040, CR9060, CR9070, CR9080 Replaces 87105840	Receiver Drier Receiver Drier, Import 4" x 7 1/2", Inlet - #6 Female O-Ring, Outlet - #6 Male O-Ring, R12 and R134a Compatible	AMX10154 AMX10208	\$ 25.00 \$ 22.00
	Receiver Drier 3" x 10", Outlet - #6 3/8" Female O-Ring, Inlet - #6 3/8" Male O-Ring	AM84058791	\$ 33.67
 TR70, Swathers: 903, 905, 907, 909, 910, 912, 1112, 1114, Forage Harvester: 1890 Replaces 130217	Receiver Drier 3" x 6" Male Flare, R12 and R134a Compatible	AMX10211	\$ 22.00
 TR75, TR85, TR86, TR87, TR88, TR89, TR95, TR96, TR97, TR98, TR99, Swathers: 1118, 2450, 2550, HW300, HW320, HW340, Forage Harvesters: 1915, 1900, 2100, 2115, Mower Conditioner: 1499 Replaces 9827053	Receiver Drier 3" x 10 1/2" Male O-Ring, R12 and R134a Compatible	AMX10218	\$ 26.00
 8030, 8080, 8340, 8350, 8360, 8370, TR75, TR85, TR95 Replaces 80449624	Expansion Valve Bulb Type, Externally Equalized, R12 and R134a Compatible, 14" Tube Length, O-Ring Connection	AMX10145	\$ 20.00
 CR920, CR940, CR960, CR970, CR980, CR9040, CR9060, CR9070, CX720, CX740, CX760, CX780, CX820, CX840, CX860, CX880, CX8030, CX8040, CX8050, CX8060, CX8070, CX8080, CX8090, Swathers: H8040, H8060, H8080, HW325, HW345, HW365 Replaces 87033212	Expansion Valve Block Type, R12 and R134a Compatible, O-Ring Connection	AMX10150	\$ 26.00
 TR70, Swathers: 903, 905, 907, 909, 910, 912, 1100, 1112, 1114, Forage Harvester: 1890, Mower Conditioners: 1496, 1499 Replaces 9617883	Expansion Valve Internally Regulated w/ 12" Capacity Tube w/ Flare Connection, R12 and R134a Compatible	AMX10215	\$ 30.00

New Holland®—Combine

Application	Description	Part Number	Retail Price
 TR70, TR75, TR85, TR86, TR87, TR88, TR89, TR95, TR96, TR97, TR98 BSN 566087, TR99 BSN 565944, Swathers: 1100, 1112, 1114, 1116, 1118 Replaces 274653	Blower Motor 3-Speed, Double Shaft, 4-Wire, Reversible, 3/8" Shaft Diameter, 4 1/4" Long	AMX10120	\$ 80.00
 Speedrower Swathers: 200, 240	Condenser w/ Oil Cooler Core: 30 7/8" x 31" x 3.80" Replaces 87340522	AM87490300	\$ 1070.00
Swathers: H8040, H8060, H8080	Charge Air Cooler Core: 33.00" x 14.30" x 3" Replaces 87039232	AM87340512	\$ 950.00
Swathers: H8040, H8060, H8080, Speedrower Swathers: 200, 240	Charge Air Cooler	AM87340510	\$ 1325.00
 TR86, TR87, TR88, TR96, TR97, TR98, Swathers: 1116, 1118, 2450, 2550	Evaporator Block Type Valve Core: 28" x 1 7/8" x 5"	AM627257	\$ 300.00

Cornhead—Fenders and Snouts

Application	Description	Part Number	Retail Price	Core
 96C, 98C, 98D, 99C, 996	Wear Strip 30" Long For Inner Dividers	Right Hand AM86553710	\$ 43.00	
		Left Hand AM86553709	\$ 43.00	
 96C, 98C, 98D, 99C	Wear Tip - 20", 22" or 30"	AM87015179	\$ 41.00	
 96C, 98C, 98D, 99C	Wear Tip - 20" or 22"	AM87015178	\$ 41.00	
Most Models	Poly Gathering Chain Guard White 8.90" x 23", Includes Hardware	AMX27152	\$ 21.00	
 996	Ear Saver Sold Individually (2) Required per Row Replaces 86526475	AMX27177	\$ 15.00	
 966	Ear Saver Sold Individually (2) Required per Row	AM86526475	\$ 8.00	
Most Models	Ear Saver (1) Inside and (1) Outside Required per Row, Excluding 974 Cornheads which Require (2) Inside per Row	Inside Snout AMX27182	\$ 10.75	
		Outside Snout AMX27183	\$ 12.75	
 980C	Ear Saver 30" Row Spacing	Inside Snout AM47483715	\$ 7.95	
 980C	Ear Saver 30" Row Spacing	Outside Snout AM47515996	\$ 7.95	
 Models w/ Poly Snout	Poly Skid Bubble Tip	Outside Snout AMX27150	\$ 18.50	
 Models w/ Poly Snout	Poly Skid Bubble Tip	Inside Snout AMX27151	\$ 18.50	

New Holland®—Combine

Cornhead—Stalk Stompers and Components

Kits include header mounting brackets, 12" stalk stomper shoes, stalk stomper torsion mounts, u-bolts and mounting hardware. Kits require 2" x 2" square tool bar.



Application	Description	Part Number	Retail Price	Core
96C, 98C, 98D, 996	Stalk Stomper Kit, 2 Row For 8 Row and 12 Row Covers 1 Row on Each Side of Feederhouse No Coverage Below Feederhouse Replaces 73343983	AMX31000	\$ 1000.00	
	Stalk Stomper Kit, 4 Row For 8 Row and 12 Row Cornheads Covers 2 Rows on Each Side of Feederhouse No Coverage Below Feederhouse Replaces 73343984	AMX31003	\$ 1550.00	
	Stalk Stomper Kit, 4 Row For 8 Row and 12 Row Cornheads Covers 2 Rows Below Feederhouse and 2 Outer Rows (1 per side) Replaces 73343985	AMX31004	\$ 1600.00	
	Stalk Stomper Kit, 6 Row For 8 Row and 12 Row Cornheads Covers 2 Rows Below Feederhouse and 4 Outer Rows (2 per side) Replaces 73343986	AMX31006	\$ 2500.00	
	Stalk Stomper Kit, 6 Row For 8 Row and 12 Row Cornheads Covers 3 Rows on Each Side of Feederhouse No Coverage Below Feederhouse Replaces 73343987	AMX31007	\$ 2450.00	
96C, 98C, 98D, 996	Stalk Stomper Kit, 8 Row For 8 Row and 12 Row Cornheads Covers 2 Rows Below Feederhouse and 6 Outer Rows (3 per side) Replaces 73343988	AMX31008	\$ 2950.00	
	Stalk Stomper Kit, 12 Row For 8 Row and 12 Row Cornheads Covers 2 Rows Below Feederhouse and 10 Outer Rows (5 per side) Replaces 73343989	AMX31009	\$ 3825.00	
96C, 98C, 98D, 996	Stalk Stomper Kit, 4 Row For 6 Row Cornheads Covers 2 Rows on Each side of Feederhouse No Coverage Below Feederhouse Replaces 73343973	AMX31001	\$ 1550.00	
	Stalk Stomper Kit, 4 Row For 6 Row Cornheads Covers 2 Rows Below Feederhouse and 2 Outer Rows (1 per side) Replaces 73343974	AMX31002	\$ 1600.00	
	Stalk Stomper Kit, 6 Row For 6 Row Cornheads Covers 2 Rows Below Feederhouse and 4 Outer Rows (2 per side) Replaces 73343975	AMX31005	\$ 2450.00	

New Holland®—Combine

New Holland®—Combine

Application	Description	Part Number	Retail Price	Core
99C, 980	Stalk Stomper Kit, 2 Row Kit Covers 1 Row on Each Side of Cornhead Replaces 73343950	AMX31010	\$ 1000.00	
	Stalk Stomper Kit, 4 Row Kit Covers 2 Rows on Each Side of Cornhead Replaces 73343951	AMX31011	\$ 1500.00	
	Stalk Stomper Kit, 6 Row Kit Covers 3 Rows on Each Side of Cornhead Replaces 73343952	AMX31012	\$ 2000.00	
	Stalk Stomper Kit, 8 Row Kit Covers 6 Rows on Each Side of Cornhead Replaces 73343953	AMX31013	\$ 2650.00	
	Stalk Stomper Kit, 12 Row Kit Covers 6 Rows on Each Side of Cornhead Replaces 73343954	AMX31014	\$ 3600.00	
	Stalk Stomper Kit, 12 Row Folding Head Kit Covers 6 Rows on Each Side of Cornhead Replaces 73343967	AMX31015	\$ 3900.00	
	Stalk Stomper Kit, 16 Row Covers 8 Rows on Each Side of Cornhead Replaces 73343955	AMX31016	\$ 4225.00	
	Stalk Stomper Kit, 18 Row Kit Covers 9 Rows on Each Side of Cornhead Replaces 73343956	AMX31017	\$ 4700.00	
96C, 98C, 98D, 996	Header Mounting Bracket	AMX30007	\$ 180.00	
96C, 98C, 98D, 996	Header Bracket, Right End For 6 Row Header Kits	AMX30009	\$ 165.00	
	Header Bracket, Left End For 6 Row Header Kits	AMX30008	\$ 165.00	
	Header Bracket, Center	AMX30012	\$ 55.00	
96C, 98C, 98D, 99C, 980, 996	Single Row Shoe, 12" Includes Torsion Mounting Bracket	AMX30000	\$ 320.00	
96C, 98C, 98D, 99C, 996, 980	Replacement Shoe, 12" Torsion Mounting Bracket Not Included	AMX30002	\$ 125.00	
96C, 98C, 98D, 996	Single Center Shoe, 12"	AMX30001	\$ 320.00	
96C, 98C, 98D, 99C, 980, 996	Stalk Stomper Torsion Unit	AMX30005	\$ 160.00	
	Tool Bar 2" x 2" Square, 72" Long, 3/16" Sidewall Thickness	AMX30003	\$ 75.00	
	Tool Bar 2" x 2" Square, 102" Long, 3/16" Sidewall Thickness	AMX30004	\$ 105.00	
99C, 980	Tool Bar Mounting Bracket	AMX30010	\$ 80.00	
96C, 98C, 98D, 996	Offset Tool Bar Mounting Bracket	AMX30011	\$ 90.00	
96C, 98C, 98D, 99C, 980, 996	Tool Bar Splice Bracket Use to splice 2 Tool Bars together to add extended length for various row spacing and additional rows	AMX30006	\$ 42.00	

Cornhead—Row Unit Components

	Application	Description	Part Number	Retail Price	Core
	962 Prior to 1977	Gathering Chain	AM262179	\$ 57.00	
	98D, 974, 996	Gathering Chain, Black 48 Links, 8 Lug 2.63" Wide Attachment Links	AMCHG-100	\$ 30.00	
	99C	Gathering Chain, Black 76 Links, 8 Lug Replaces 84977231	AM84251979	\$ 70.00	





New Holland®—Combine

New Holland®—Combine

	Application	Description	Part Number	Retail Price	Core
	96C, 98D - 2011 and Later	Gathering Chain 6 Lug	AM84284709	\$ 55.00	
	99C, 980C	Idler Sprocket Replaces 84977538, 87473652	AM47906258	\$ 90.00	
	99C, 980C, 980CR w/ Chopping Row Units, (9208, 9212, 9216, 9218 - w/o Chopping Row Units)	Idler Sprocket Replaces 47906258, 84977538	AM87473652	\$ 62.00	
	974, 996	Idler Sprocket, Non-Greaseable 8 Tooth, 0.65" ID	AMAN102448	\$ 12.50	
	96C, 98C, 98D, 996N, 996R, 996W	Gathering Chain Drive Sprocket 8 Tooth	AM86611371	\$ 27.00	
	98D	Gathering Chain Drive Sprocket 7 Tooth	AM86837081	\$ 16.00	
	96C, 98C, 98D, 996	Auger Support, Front	AM86729260	\$ 34.00	
	99C, 980C	Stalk Roll Knife, 4 per Roll Extended Wear, 5.40 mm Thick	AM84499693	\$ 42.00	
	962	Stalk Roll Knife, Right Hand	AM703415	\$ 20.00	
		Stalk Roll Knife, Left Hand	AM703414	\$ 20.00	
	96C, 98C, 98D	Stalk Roll Barrel, Binocular Replaces 86626793, 87107017, 87107018	AM87663360	\$ 360.00	
	96C, 98C, 974, 996	Chain Guide	AM86611426	\$ 35.00	
	98D	Chain Guide, Right Hand	AM87593362	\$ 73.00	
		Chain Guide, Left Hand	AM84316263	\$ 87.00	
	99C, 980C, 9208, (9212, 9216, 9218 - w/o Stalk Chopper)	Chain Guide Wear Strip	AM84977612	\$ 20.00	
	974	Deck Plate, Right or Left Hand (2) Required per Row Replaces 86611428	AM9825691	\$ 35.00	
	980CF BSN 697	Deck Plate, Right Hand For Non-Chopping Heads	AM84972758	\$ 55.00	
	980CR BSN 697	Deck Plate, Left Hand For Non-Chopping Heads	AM47474090	\$ 41.00	
	99C, 980C, 5505, 5506, 9208, 9212, 9216, 9218	Shield, Right Hand Replaces 87662218	AM47640768	\$ 135.00	
	996	Deck Plate, Right Hand Replaces 86611537, 86978031	AM86978032	\$ 33.00	
	996	Deck Plate, Left Hand Manual Adjust Replaces 86611536	AM87047540	\$ 33.00	

Prices Subject to Change without Prior Notice. The use of original equipment manufacturer (OEM) part numbers or trademarks, e.g. Case® and John Deere®, are for reference purposes only and for indicating product use and compatibility. Our company and the listed replacement parts contained herein are not sponsored, approved or manufactured by the OEM. All parts are New unless designated Reman in the description.

New Holland®—Combine

Application	Description	Part Number	Retail Price	Core
 98C	Deck Plate, Left Hand Hydraulic Adjust Replaces 86611535, 86980000	AM87047608	\$ 70.00	
 98C	Wear Plate Replaces 86583946	AM87027837	\$ 19.00	
96C, 98C, 98D, 974, 996	Bearing Flange	AM86620027	\$ 9.10	
96C, 98C, 98D, 962, 974, 996	Auger Drive Bearing 1 1/8" (28.60 mm) Hex Bore, 1.4843" (37.70 mm) Wide, 2.8346" (72 mm) OD	AM121602	\$ 17.00	
 9208, 9212, 9216, 9218	Rubber Curtain	AM48113581	\$ 14.00	
 99C, 980CF, 980CR	Rubber Curtain	AM84977584	\$ 18.00	

Belts—1112, 1114, 1116, 1118, 2450, 2550—Swather

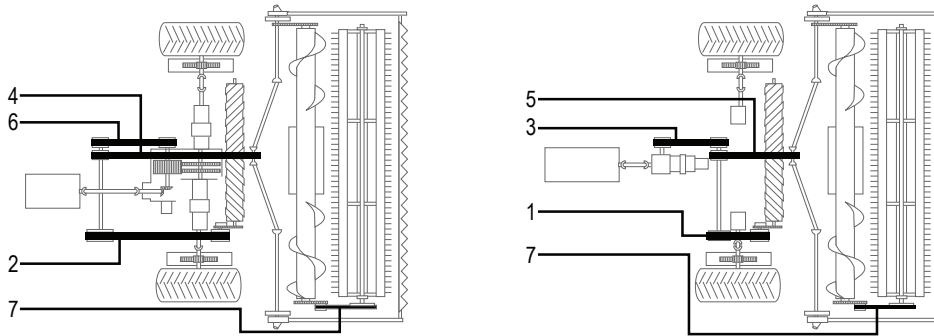

Application	Description	Part Number	Retail Price
1 1116, 1118	Conditioner	AM625241	\$ 182.00
2 1112, 1114	Conditioner Drive, 4 Band	AM625241	\$ 182.00
3 1116, 1118	Header Clutch, 3 Groove	AM189131	\$ 77.75
4 1112, 1114	Header Drive	AM182381	\$ 55.00
5 1116, 1118	Header, 2 Groove	AM643307	\$ 64.00
6 1112, 1114	Jackshaft, 3 Band	AM189130	\$ 106.00
7 1112, 1114, 1116, 1118	Reel	AM9622032	\$ 61.00
NI 2450, 2550	Sickle Drive and Auger	AM703747	\$ 47.00
NI 2450, 2550	Conditioner	AM86528541	\$ 39.00

New Holland®—Combine

Belts—1400, 1500

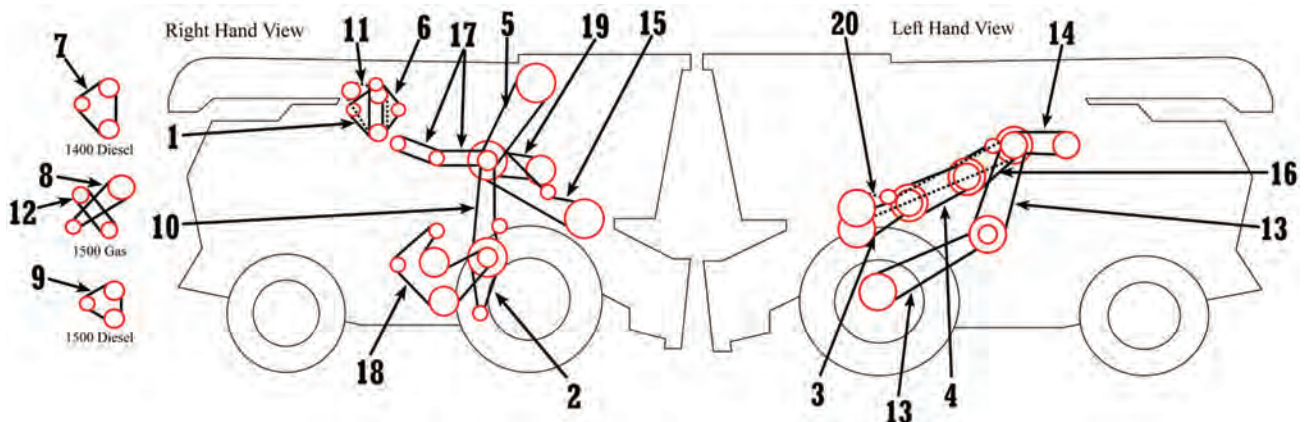

Application	Description	Part Number	Retail Price
1 1400	Alternator / Water Pump	AM500599	\$ 10.29
2 1400	Clean Fan Drive	AM320935	\$ 48.17
3 1400, 1500	Drum Variable Drive	AM336784	\$ 207.00
4 1400, 1500	Drum Variator	AM336784	\$ 207.00
5 1400, 1500	Elevator Drive	AM230164	\$ 50.60
6 1400	Fan	AM500595	\$ 11.09
7 1400	Fan / Alternator	AM576775	\$ 14.30
8 1500	Fan / Alternator	AM576775	\$ 14.30
9 1500	Fan / Alternator - Dsl Engine	AM9601666	\$ 34.00
10 1400, 1500	Fan Variable Drive	AM247782	\$ 45.00
11 1400	Governor	AM9672216	\$ 8.00
12 1500	Governor	AM500602	\$ 12.30
13 1400	Ground Variable Drive	AM356024	\$ 201.00
13 1500	Ground Variable Drive	AM356025	\$ 228.00
13 1400	Ground Variable Drive, Low Speed	AM354115	\$ 186.00
13 1500	Ground Variable Drive, Low Speed	AM350776	\$ 171.95
14 1400, 1500	Hydraulic Pump Set of 2	AM335258	\$ 28.00
15 1400	Intermediate Drive	AM375977	\$ 109.92
15 1500	Intermediate Drive	AM324391	\$ 108.70
16 1400, 1500	Intermediate to Shaft	AM323646	\$ 115.60
17 1400, 1500	Rotary Screen	AM696719	\$ 9.00
18 1400, 1500	Straw Walker	AM378672	\$ 77.58
19 1500	Tailings Elevator Drive	AM323413	\$ 33.24
20 1400, 1500	Unloading	AM9800111	\$ 84.98

New Holland®—Combine

New Holland®—Combine

Belts—TR70

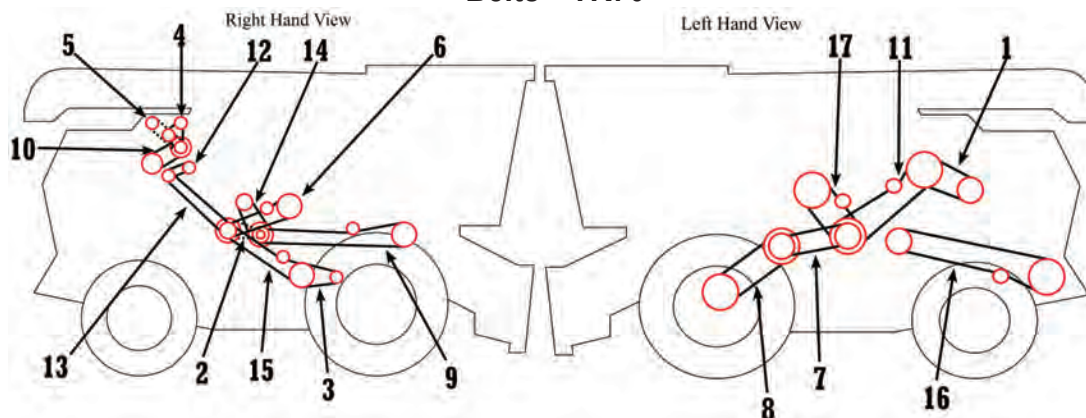

Application	Description	Part Number	Retail Price
1 TR70	Air Conditioner (Gas & Cat Dsl)	AM264557	\$ 14.38
1 TR70	Air Conditioner (Ford Dsl)	AM577240	\$ 16.00
2 TR70	Beater Drive	AM577900	\$ 34.00
3 TR70	Cleaning Fan Drive	AM792809	\$ 63.00
4 TR70	Fan & Alternator (Gas)	AM86514610	\$ 18.00
4 TR70 BSN 293492	Fan & Alternator (Cat Diesel)	AM254084	\$ 17.23
4 TR70 ASN 293493	Fan & Alternator (Cat Diesel)	AM626654	\$ 26.00
4 TR70	Fan & Alternator (Ford Diesel)	AM576774	\$ 25.25
5 TR70	Governor (Gas Engine)	AM266209	\$ 8.63
6 TR70	Grain Elevator Drive	AM703747	\$ 47.00
7 TR70	Ground Speed Vari-Drive	AM717700	\$ 143.00
8 TR70	Ground Speed Hydro-Drive	AM268612	\$ 148.00
8 TR70	Ground Speed Vari-Drive	AM636645	\$ 342.00
9 TR70	Header Drive	AM246980	\$ 142.00
10 TR70	Hydraulic Pump Drive (Ford Dsl) Set of 2	AM576772	\$ 31.53
10 TR70	Hydraulic Pump Drive (Gas & Cat Dsl) Set of 2	AM248332	\$ 27.00
11 TR70	Main Drive, Power Band (Gas & Cat Dsl)	AM246978	\$ 183.00
11 TR70	Main Drive, Power Band (Ford Dsl)	AM576771	\$ 125.00
12 TR70	Rotary Screen Drive	AM696719	\$ 9.00
13 TR70	Rotary Screen, Jackshaft Drive	AM246771	\$ 22.75
14 TR70	Rotor Drive	AM254093	\$ 248.00
14 TR70	Rotor Drive (Opt for High Speed)	AM715785	\$ 240.00
15 TR70	Shaker Shoe Drive	AM785415	\$ 113.25
16 TR70 BSN 300588	Straw Chopper Drive	AM578206	\$ 38.18
16 TR70 ASN 300589	Straw Chopper Drive	AM246727	\$ 48.00
16 TR70 BSN 299959	Straw Spreader	AM246727	\$ 48.00
16 TR70 ASN 299960	Straw Spreader	AM230143	\$ 50.00
17 TR70	Unloading Auger Drive	AM247782	\$ 45.00

New Holland®—Combine

Belts—TR75, TR85

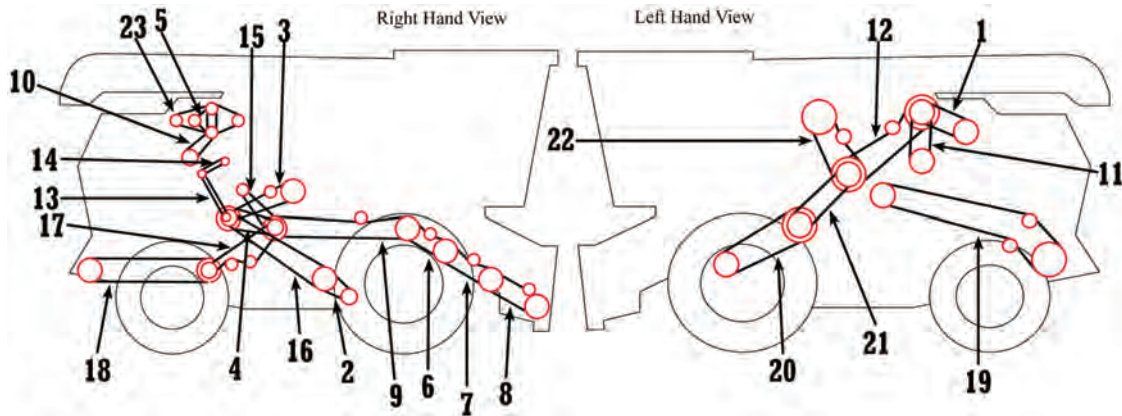

New Holland®—Combine

Application	Description	Part Number	Retail Price
1 TR75 BSN 403000, TR85 BSN 310400	Air Compressor, 54.50"	AM577240	\$ 16.00
1 TR75 BSN 403000, TR85 BSN 310400	Air Compressor, 52.75"	AM264557	\$ 14.38
1 TR75 ASN 403001, TR85 ASN 310401	Air Compressor, 48"	AM259346	\$ 13.17
2 TR75, TR85	Cleaning Fan, Vari-Drive 58" Standard	AM792809	\$ 63.00
2 TR75, TR85	Cleaning Fan, Vari-Drive 46" Slow-Down	AM624398	\$ 53.00
3 TR75, TR85	Clean Grain Elevator Drive	AM703747	\$ 47.00
4 TR75, TR85	Discharge Beater	AM577900	\$ 34.00
5 TR75, TR85	Engine Fan (Ford)	AM772654	\$ 16.18
6 TR75 BSN 403276, TR85 BSN 404301	Feeder Drive Set of 3	AM620944	\$ 102.00
6 TR86 BSN 527530	Engine Fan Set of 2	AM647901	\$ 22.00
7 TR75 S/N 304740-403725, TR85 S/N 308000-404264	Feeder Drive, Fixed Speed Set of 2	AM621367	\$ 83.00
7 TR75 ASN 403301, TR85 ASN 404301, TR75 S/N 304740-403725, TR85 S/N 308000-404264	Feeder Drive, Variable Speed	AM849514	\$ 270.00
8 TR75 S/N 304740-403725, TR85 S/N 308000-404264	Feeder Drive, Variable Speed	AM632890	\$ 125.00
8 TR75 ASN 403301, TR85 ASN 404301, TR75 S/N 304740-403725, TR85 S/N 308000-404264	Feeder Drive, Variable Speed	AM849514	\$ 270.00
9 TR75 BSN 403276, TR85 BSN 404301	Header Drive	AM246980	\$ 142.00
9 TR75 ASN 403301, TR85 ASN 404301	Header Drive, 193"	AM682008	\$ 185.00
10 TR75	Hydraulic Pump Drive (Ford) Set of 2	AM576772	\$ 31.53
10 TR75	Hydraulic Pump Drive (w/ Cat) Set of 2	AM248332	\$ 27.00
11 TR75 BSN 403000, TR85 BSN 310400	Hydrostatic Charge Pump	AM259477	\$ 16.50
12 TR75 BSN 403000	Main Shaft Drive	AM576771	\$ 125.00
12 TR85 BSN 403000	Main Shaft Drive	AM246978	\$ 183.00
12 TR75 ASN 403301, TR85 ASN 404301	Main Shaft Drive, Standard Traction	AM795009	\$ 183.86
13 TR75, TR85	Rotary Screen, Lower 68.30"	AM612305	\$ 21.00
13 TR75, TR85	Rotary Screen, Lower 65.75"	AM610767	\$ 17.10
14 TR75, TR85	Rotary Screen, Upper	AM716254	\$ 23.00
15 TR75, TR85	Rotary Vari-Drive	AM717700	\$ 143.00
15 TR75 ASN 304700, TR85 ASN 308000	Rotor Vari-Drive, Standard Rotor	AM86518570	\$ 185.00
15 TR75 BSN 304699, TR85 BSN 3079999	Rotary Vari-Drive, High Speed Rotor	AM86518571	\$ 275.00
16 TR75, TR85	Shaker Shoe Drive	AM785415	\$ 113.25
17 TR75, TR85	Straw Chopper, Front	AM717075	\$ 60.00
18 TR75, TR85	Straw Chopper, Rear	AM614040	\$ 70.00
19 TR75, TR85	Straw Spreader Drive	AM230143	\$ 50.00

Prices Subject to Change without Prior Notice. The use of original equipment manufacturer (OEM) part numbers or trademarks, e.g. Case® and John Deere®, are for reference purposes only and for indicating product use and compatibility. Our company and the listed replacement parts contained herein are not sponsored, approved or manufactured by the OEM. All parts are New unless designated Reman in the description.

New Holland®—Combine

Application	Description	Part Number	Retail Price
19 TR75, TR85	Straw Chopper Drive	AM246727	\$ 48.00
20 TR75, TR85	Traction Hydro Drive, Lower	AM716414	\$ 140.00
20 TR75 S/N 304740-403000, TR85 S/N 308086-310400	Traction Hydro Drive, Lower Set of 3	AM635042	\$ 115.00
20 TR75, TR85	Traction Hydro Drive, Lower	AM636645	\$ 342.00
21 TR75 BSN 403000, TR85 BSN 310400	Traction Hydro Drive, Upper Set of 3	AM716416	\$ 139.00
21 TR75 BSN 304739, TR85 BSN 308085	New Standard Traction, Vari-Drive, Upper	AM717700	\$ 143.00
21 TR75 ASN 304740, TR85 ASN 308086	New Standard Traction, Vari-Drive, Upper	AM254093	\$ 248.00
22 TR75, TR85	Unloading Auger Drive	AM247782	\$ 45.00
23 TR75 BSN 403000	Water Pump and Alternator	AM772656	\$ 16.08

New Holland®—Combine

Belts—TR86

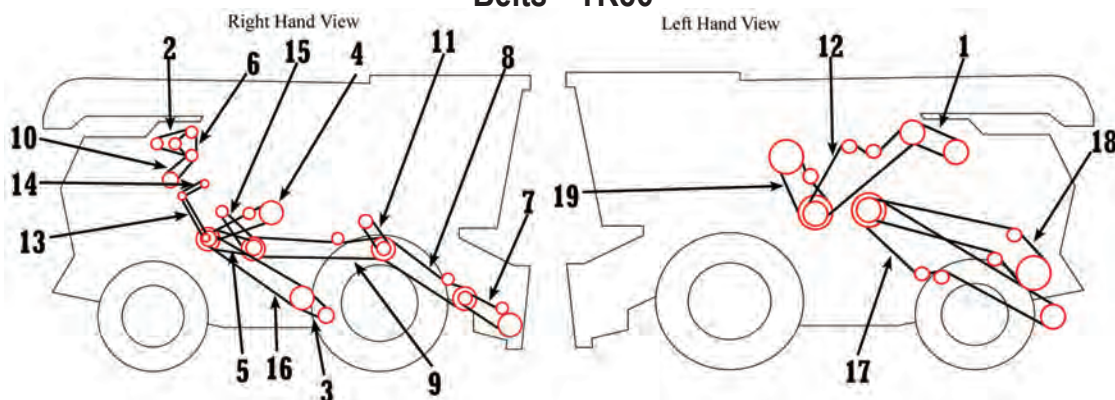

Application	Description	Part Number	Retail Price
1 TR86 BSN 527631	Air Conditioner Compressor	AM259346	\$ 13.17
1 TR86 S/N 527631-529659	Air Conditioner Compressor	AM577240	\$ 16.00
2 TR86 BSN 527530	Alternator, Set of 2	AM626654	\$ 26.00
2 TR86 ASN 527531	Alternator, Set of 2	AM572981	\$ 16.66
3 TR86	Cleaning Fan, Vari-Drive 58" Standard	AM792809	\$ 63.00
3 TR86	Cleaning Fan, Vari-Drive 52" Slow-Down	AM624398	\$ 53.00
4 TR86	Clean Grain Elevator Drive	AM703747	\$ 47.00
5 TR75, TR85	Engine Fan (w/ Cat) Set of 2	AM647901	\$ 22.00
5 TR86	Discharge Beater Drive	AM86520043	\$ 64.50
6 TR86 ASN 527531	Engine Fan, Hydraulic Pump, Set of 2	AM855676	\$ 29.66
7 TR86	Feeder Drive	AM699268	\$ 265.00
8 TR86	Feeder Drive, Fixed Speed Set of 2	AM621367	\$ 83.00
8 TR86	Feeder Drive, Small Grain Special	AM9613963	\$ 195.00
8 TR86	Feeder Drive, Variable Speed	AM849514	\$ 270.00
9 TR86	Header Drive	AM682008	\$ 185.00
10 TR86 BSN 527530	Hydraulic Pump Set of 2	AM248332	\$ 27.00
10 TR86 ASN 527531	Hydraulic Pump, Set of 2	AM855676	\$ 29.66
11 TR86	Hydraulic Reel Drive Pump Drive	AM244025	\$ 19.00
12 TR86 BSN 527530	Main Shaft Drive, Hydrostatic	AM788803	\$ 303.00
12 TR86 ASN 527531	Main Shaft Drive, Hydrostatic	AM797978	\$ 270.71
13 TR86 BSN 527530	Rotary Screen Drive, Primary	AM610767	\$ 17.10
13 TR86 ASN 527531	Rotary Screen Drive, Primary	AM612305	\$ 21.00
14 TR86	Rotary Screen, Secondary	AM716254	\$ 23.00

New Holland®—Combine

Application	Description	Part Number	Retail Price
15 TR86	Rotor Vari-Drive, Standard	AM86518570	\$ 185.00
15 TR86	Rotary Vari-Drive, High Speed	AM86518571	\$ 275.00
16 TR86	Shaker Shoe Drive	AM785415	\$ 113.25
17 TR86	Straw Chopper Drive	AM86547070	\$ 126.00
18 TR86	Straw Spreader Drive	AM230143	\$ 50.00
19 TR86	Unloading Auger Drive	AM694982	\$ 55.00

Belts—TR87, TR88, TR89, TR99

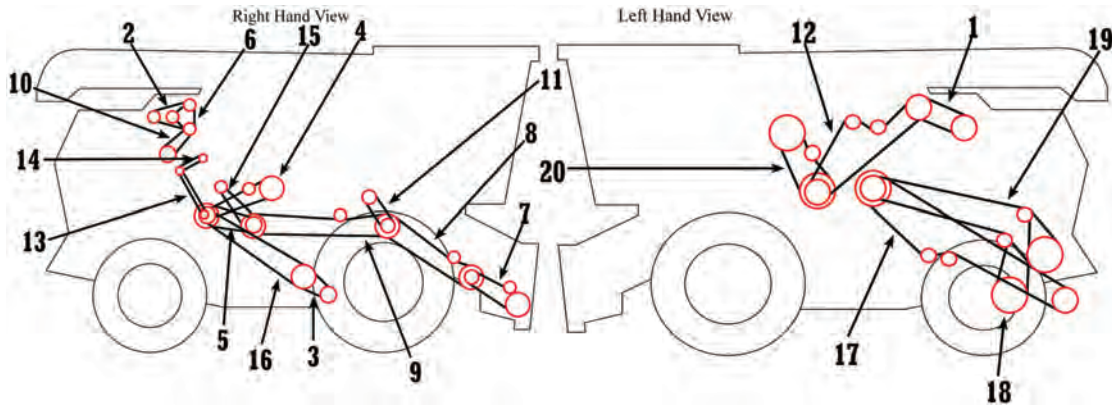

Application	Description	Part Number	Retail Price
1 TR87	A/C Compressor	AM577240	\$ 16.00
1 TR88, TR89, TR99	A/C Compressor	AM9842660	\$ 13.00
2 TR87	Alternator	AM577240	\$ 16.00
2 TR88	Alternator	AM86513664	\$ 33.75
3 TR87, TR88	Cleaning Fan, 58" Standard	AM792809	\$ 63.00
3 TR87, TR88	Cleaning Fan, 52" Slow Down Kit	AM624398	\$ 53.00
3 TR89, TR99	Cleaning Fan, 52" Slow Down Kit	AM710752	\$ 53.50
3 TR89, TR99	Cleaning Fan, 61.60" Intermediate Kit	AM773300	\$ 48.00
3 TR89, TR99	Cleaning Fan, 69.50" High Speed Kit	AM792811	\$ 48.00
4 TR87, TR88	Clean Grain Elevator Drive	AM703747	\$ 47.00
4 TR89, TR99	Clean Grain Elevator Drive	AM9604713	\$ 75.00
5 TR87, TR88	Discharge Beater	AM86520043	\$ 64.50
5 TR89, TR99	Discharge Beater	AM86520042	\$ 58.00
6 TR87	Water Pump Drive	AM592711	\$ 12.75
6 TR87	Engine Fan, Hydraulic Pump	AM855676	\$ 29.66
6 TR89, TR99	Hydraulic Pump	AM773255	\$ 33.87
7 TR87, TR88, TR89, TR99	Feeder Drive	AM699268	\$ 265.00
8 TR87	Feederhouse Drive, Fixed Speed Set of 2	AM621367	\$ 83.00
8 TR88, TR89, TR99	Feederhouse Drive, Fixed Speed	AM9613963	\$ 195.00
8 TR89, TR99 w/ Row Cornhead	Feederhouse Drive, Fixed Speed	AM86537319	\$ 213.00
8 TR87, TR88	Feeder Drive, Variable Speed	AM849514	\$ 270.00
8 TR89, TR99	Feeder Drive, Variable Speed	AM9601511	\$ 270.00
9 TR87, TR88	Header Drive	AM682008	\$ 185.00
9 TR89	Header Drive	AM86503087	\$ 168.86
10 TR87	Hydraulic Pump	AM855676	\$ 29.66
10 TR88, TR89, TR99	Hydraulic Pump	AM773255	\$ 33.87
11 TR87, TR89, TR99	Hydraulic Reel Drive Pump	AM9609607	\$ 17.00
11 TR88	Hydraulic Reel Drive Pump	AM244025	\$ 19.00

Prices Subject to Change without Prior Notice. The use of original equipment manufacturer (OEM) part numbers or trademarks, e.g. Case® and John Deere®, are for reference purposes only and for indicating product use and compatibility. Our company and the listed replacement parts contained herein are not sponsored, approved or manufactured by the OEM. All parts are New unless designated Reman in the description.

New Holland®—Combine

New Holland®—Combine

Application	Description	Part Number	Retail Price
12 TR87	Main Drive, Hydrostatic	AM797978	\$ 270.71
12 TR89, TR99	Main Drive, Hydrostatic	AM86514163	\$ 310.00
13 TR87	Rotary Screen Drive, Primary	AM612305	\$ 21.00
13 TR88	Rotary Screen Drive, Primary	AM573957	\$ 18.00
14 TR87, TR88	Rotary Screen Drive, Secondary	AM716254	\$ 23.00
15 TR87, TR88	Rotor Variable Drive, Standard	AM86518570	\$ 185.00
15 TR87, TR88	Rotor Variable Drive, High Speed	AM86518571	\$ 275.00
15 TR89	Rotor Variable Drive, Standard	AM86518568	\$ 324.06
15 TR89	Rotor Variable Drive, High Speed	AM86518569	\$ 353.00
16 TR87, TR88	Shaker Shoe Drive	AM785415	\$ 113.25
16 TR89, TR99	Shaker Shoe Drive	AM80774747	\$ 92.00
17 TR87, TR88, TR89	Straw Chopper Drive	AM86547070	\$ 126.00
17 TR99	Straw Chopper Drive	AM86547809	\$ 172.00
18 TR89, TR99	Straw Chopper, Infeed Drive	AM618040	\$ 67.00
19 TR87	Straw Spreader Drive	AM230143	\$ 50.00
19 TR89, TR99	Straw Spreader Drive	AM618040	\$ 67.00
20 TR87, TR88	Unloading Auger Drive	AM694982	\$ 55.00
20 TR89, TR99	Unloading Auger Drive	AM86514256	\$ 54.00

Belts—TR95

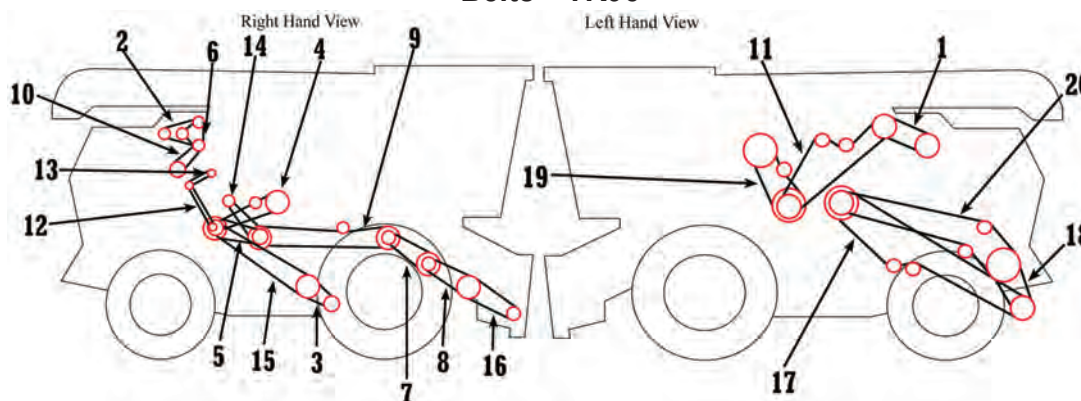

Application	Description	Part Number	Retail Price
1 TR95 BSN 500200	Air Conditioner Compressor, 52.75"	AM264557	\$ 14.38
1 TR95 ASN 500201	Air Conditioner Compressor, 48"	AM259346	\$ 13.17
2 TR95	Alternator, Water Pump Drive	AM626654	\$ 26.00
3 TR95	Cleaning Fan, Vari-Drive	AM792811	\$ 48.00
3 TR95	Cleaning Fan, Vari-Drive w/ Int. Speed Kit	AM773300	\$ 48.00
3 TR95	Cleaning Fan, Vari-Drive w/ Slow Down	AM710752	\$ 53.50
4 TR95	Clean Grain Elevator Drive	AM230164	\$ 50.60
5 TR95	Discharge Beater Drive	AM86520042	\$ 58.00
6 TR95	Engine Fan Drive	AM768340	\$ 21.40
7 TR95	Feeder Drive Set of 3	AM620944	\$ 102.00
8 TR95	Fixed Speed Feeder Set of 2	AM621367	\$ 83.00
8 TR95	Vari-Speed Feeder	AM849514	\$ 270.00
9 TR95	Header Drive	AM246980	\$ 142.00
10 TR95	Hydraulic Pump	AM624650	\$ 41.00
11 TR95 BSN 501850	Main Shaft & Hydrostatic Pump Drive	AM795008	\$ 303.00
11 TR95 ASN 801851	Main Shaft & Hydrostatic Pump Drive	AM649035	\$ 434.00

New Holland®—Combine

Application	Description	Part Number	Retail Price
12 TR95	Rotary Screen Drive	AM615790	\$ 11.64
13 TR95	Rotary Screen Secondary Drive	AM716254	\$ 23.00
14 TR95 BSN 500200	Rotor Drive	AM86518569	\$ 353.00
14 TR95 BSN 501850	Rotor Drive	AM787583	\$ 267.00
14 TR95 ASN 801851	Rotor Drive	AM86518568	\$ 324.06
15 TR85	Shaker Shoe Drive	AM80774747	\$ 92.00
16 TR95	Stoneroll Drive (Set of 5)	AM632890	\$ 125.00
17 TR95	Straw Chopper Beater Drive	AM86547070	\$ 126.00
18 TR95	Straw Spreader	AM618040	\$ 67.00
19 TR95	Unloading Auger Drive	AM86514256	\$ 54.00
20 TR95	Straw Spreader	AM230143	\$ 50.00

Belts—TR96

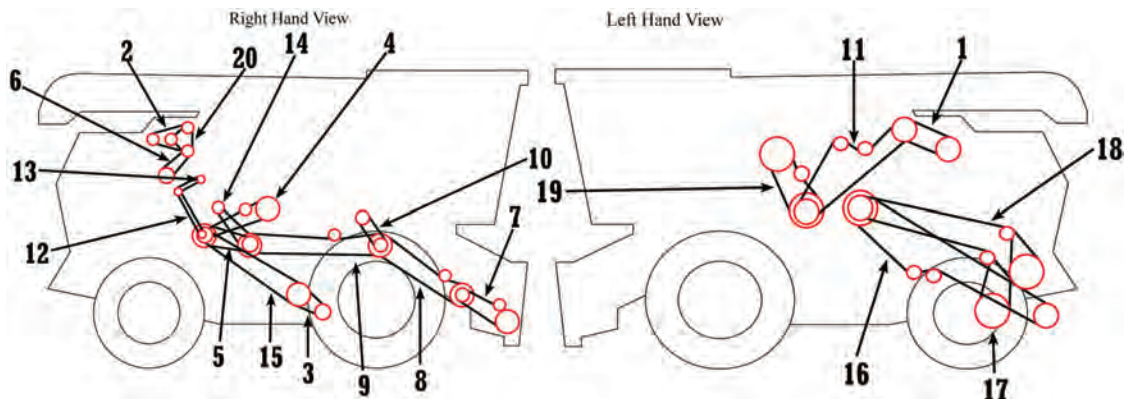

Application	Description	Part Number	Retail Price
1 TR96 BSN 529778	Air Conditioner Compressor	AM259346	\$ 13.17
1 TR96 ASN 529779	Air Conditioner Compressor	AM626657	\$ 9.28
2 TR96 BSN 528155	Alternator, Set of 2	AM626654	\$ 26.00
2 TR96 S/N 528156 & 53006	Alternator, Set of 2	AM572981	\$ 16.66
2 TR96 ASN 530066	Alternator	AM626657	\$ 9.28
3 TR96	Cleaning Fan, Vari-Drive 52" Slow-Down	AM710752	\$ 53.50
3 TR96	Cleaning Fan, Vari-Drive 61.60" Int. Speed	AM773300	\$ 48.00
3 TR96	Cleaning Fan, Vari-Drive 69.50" High Speed	AM792811	\$ 48.00
4 TR96	Clean Grain Elevator Drive	AM230164	\$ 50.60
4 TR96	Clean Grain Elevator Drive (Improved)	AM9604713	\$ 75.00
5 TR96	Discharge Beater Drive	AM86520042	\$ 58.00
6 TR96	Hydraulic Pump	AM624650	\$ 41.00
6 TR96 BSN 528155	Engine Fan	AM768340	\$ 21.40
6 TR96 ASN 528156	Engine Fan and Hydraulic Pump	AM855676	\$ 29.66
7 TR96	Feeder Drive	AM699268	\$ 265.00
8 TR96 BSN 529778	Fixed Speed Feeder Drive Set of 2	AM621367	\$ 83.00
8 TR96	Straw Chopper Drive	AM86547070	\$ 126.00
8 TR96 BSN 528560	Vari-Speed Feeder Drive	AM849514	\$ 270.00
8 TR96 ASN 528561	Vari-Speed Feeder Drive	AM9601511	\$ 270.00
9 TR96	Header Drive	AM682008	\$ 185.00
10 TR96	Hydraulic Pump Drive	AM244025	\$ 19.00
11 TR96 BSN 528155	Main Shaft Drive, Hydrostatic	AM649035	\$ 434.00
11 TR96 ASN 529778	Main Shaft Drive, Hydrostatic	AM797979	\$ 355.00
12 TR96 BSN 529778	Rotary Screen Drive, Primary	AM615790	\$ 11.64

Prices Subject to Change without Prior Notice. The use of original equipment manufacturer (OEM) part numbers or trademarks, e.g. Case® and John Deere®, are for reference purposes only and for indicating product use and compatibility. Our company and the listed replacement parts contained herein are not sponsored, approved or manufactured by the OEM. All parts are New unless designated Reman in the description.

New Holland®—Combine

Application	Description	Part Number	Retail Price
13 TR96 BSN 529778	Rotary Screen, Secondary	AM716254	\$ 23.00
14 TR96	Rotor, Vari-Drive, Standard	AM86518568	\$ 324.06
14 TR96	Rotor, Vari-Drive, High Speed	AM86518569	\$ 353.00
15 TR96	Shaker Shoe Drive	AM80774747	\$ 92.00
16 TR96	Straw Chopper Drive	AM86547070	\$ 126.00
17 TR96	Straw Chopper, Infeed Drum Drive	AM230143	\$ 50.00
18 TR96	Straw Spreader Drive	AM618040	\$ 67.00
19 TR96	Unloading Auger Drive	AM86514256	\$ 54.00
20 TR96 ASN 528156	Water Pump Drive	AM592711	\$ 12.75

Belts—TR97, TR98

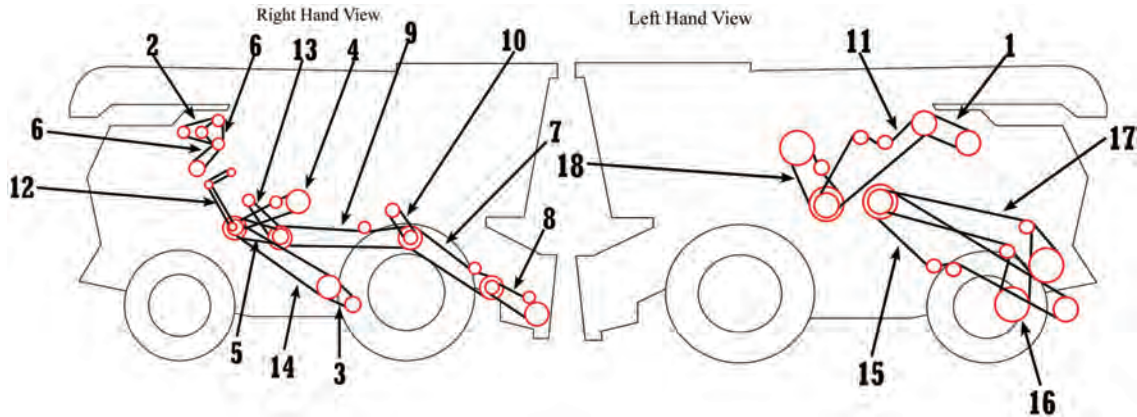

Application	Description	Part Number	Retail Price
1 TR97	Air Conditioner Compressor	AM626657	\$ 9.28
1 TR98	Air Conditioner Compressor	AM577240	\$ 16.00
2 TR97	Alternator, Set of 2	AM572981	\$ 16.66
2 TR98	Alternator	AM86513664	\$ 33.75
3 TR97, TR98	Cleaning Fan, 61.60" Intermediate Kit	AM773300	\$ 48.00
3 TR97, TR98	Cleaning Fan, 52" Slow Down Kit	AM710752	\$ 53.50
3 TR97, TR98	Cleaning Fan, 69.50" High Speed Kit	AM792811	\$ 48.00
4 TR97, TR98	Clean Grain Elevator Drive	AM230164	\$ 50.60
4 TR97, TR98	Clean Grain Elevator Drive (Improved)	AM9604713	\$ 75.00
5 TR97	Discharge Beater	AM86520042	\$ 58.00
6 TR97	Engine Fan, Hydraulic Pump (Set of 2)	AM855676	\$ 29.66
6 TR98	Hydraulic Pump (Set of 2)	AM773255	\$ 33.87
6 TR98	Water Pump Drive	AM9672216	\$ 8.00
6 TR97	Water Pump Drive (Ford)	AM592711	\$ 12.75
7 TR97	Fixed Speed Feeder Set of 2	AM621367	\$ 83.00
7 TR98	Fixed Speed Feeder	AM9613963	\$ 195.00
7 TR97, TR98	Vari-Speed Feeder	AM9601511	\$ 270.00
8 TR97, TR98	Feeder Drive, Banded	AM699268	\$ 265.00
9 TR97	Header Drive	AM682008	\$ 185.00
9 TR98	Header Drive	AM86503087	\$ 168.86
10 TR97, TR98	Hydraulic Reel Drive Pump	AM9609607	\$ 17.00
11 TR97	Main Shaft Drive, Hydrostatic, Banded	AM797979	\$ 355.00
11 TR98	Main Shaft Drive, Hydrostatic, Banded	AM86514163	\$ 310.00
13 TR97	Rotor Variable Drive, Standard	AM86518568	\$ 324.06
13 TR97	Rotor Variable Drive, High Speed	AM86518569	\$ 353.00

New Holland®—Combine

Application	Description	Part Number	Retail Price
14 TR97, TR98	Shaker Shoe Drive	AM80774747	\$ 92.00
15 TR97, TR98	Straw Chopper Drive	AM86547070	\$ 126.00
16 TR97, TR98	Straw Chopper, Infeed Drum Drive	AM230143	\$ 50.00
17 TR97, TR98	Straw Spreader Drive	AM618040	\$ 67.00
18 TR97, TR98	Unloading Auger Drive	AM86514256	\$ 54.00

Belts—TX66, TX68

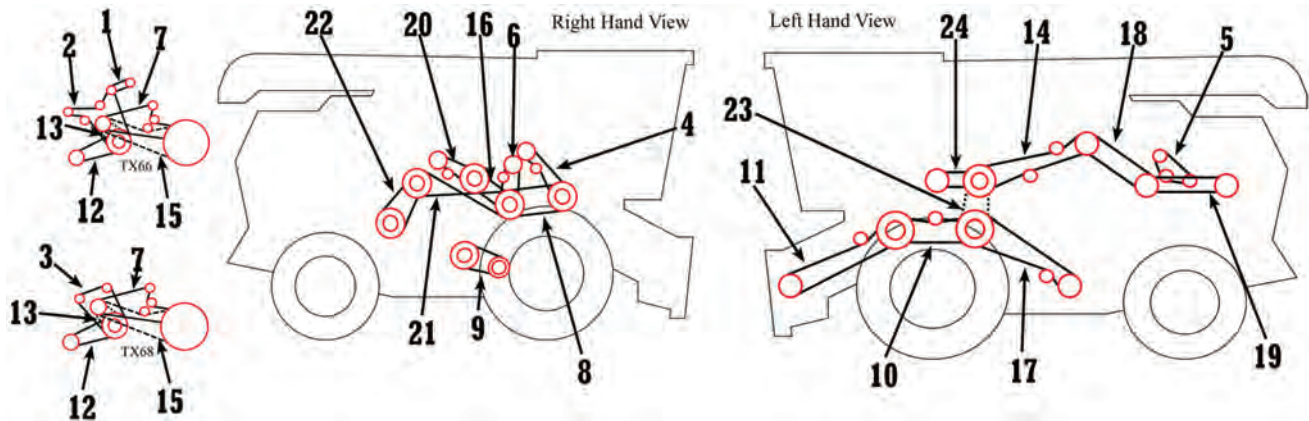

Application	Description	Part Number	Retail Price
3 TX68	Alternator & A/C Drive	AM84007307	\$ 91.29
6 TX66, TX68	Clean Grain Drive	AM86514520	\$ 40.54
6 TX66, TX68	Clean Grain Drive	AM84015852	\$ 40.54
7 TX66, TX68	Cooling Fan Drive	AM9850261	\$ 87.00
8 TX66, TX68	Drum Variable Drive	AM9832601	\$ 250.00
9 TX66, TX68	Fan Variable Drive	AM9502654	\$ 76.25
10 TX66, TX68	Feeder Drive	AM9832309	\$ 239.00
11 TX66, TX68	Header Drive	AM84012390	\$ 264.18
12 TX66	Hydraulic Pump Drive	AM9839030	\$ 31.00
12 TX68	Hydraulic Pump Drive	AM9835816	\$ 12.00
13 TX66	Intermediate Shaft Drive	AM84007307	\$ 91.29
14 TX66	Main Drive	AM922911	\$ 322.35
16 TX66, TX68	Rotary Separator Drive	AM9850770	\$ 32.07
17 TX66, TX68	Shaker Shoe Drive	AM448794	\$ 86.00
20 TX66, TX68	Strawflow Beater Drive	AM84015852	\$ 40.54
21 TX66, TX68	Straw Walker Drive	AM754389	\$ 31.59
22 TX66, TX68	Straw Walker Drive	AM754388	\$ 22.25
23 TX66, TX68	Threshing Drive	AM455865	\$ 134.51
24 TX66, TX68	Unloading Auger Drive	AM9814069	\$ 55.00

New Holland®—Combine

New Holland®—Combine

Belts—CR920, CR940, CR960, CR970

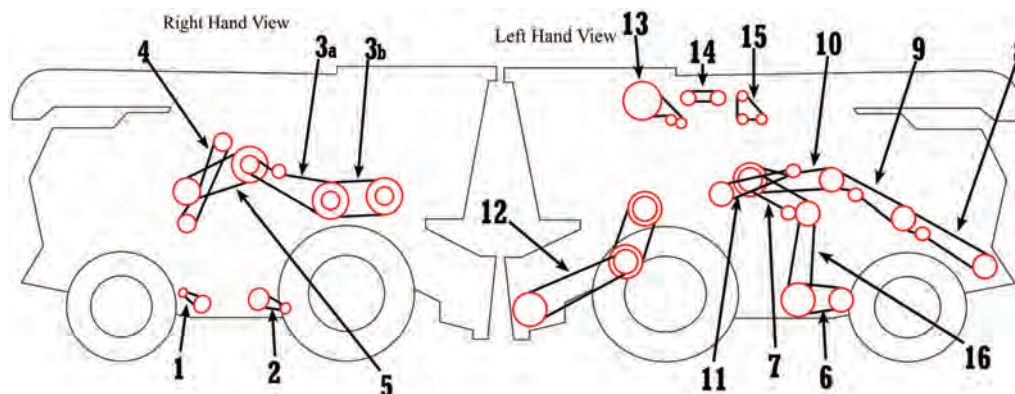

Application	Description	Part Number	Retail Price
1 CR960, CR970	Return Elevator Drive, RH Set of 2	AM84058339	\$ 32.15
2 CR920, CR940, CR960, CR970	Variator Drive Cleaning Fan, Self Level	AM84817627	\$ 78.00
2 CR920, CR940, CR960, CR970	Variator Drive Cleaning Fan, Fixed Shoe	AM919739	\$ 320.61
2 CR920, CR940, CR960, CR970	Variator Drive Fan, Self Level, Grass Seed EQ	AM84023277	\$ 146.17
2 CR920, CR940, CR960, CR970	Variator Drive Fan, Fixed Shoe, Grass Seed EQ	AM84023278	\$ 95.00
3a CR920, CR940, CR960, CR970	Feeder Drive, Primary w/ Variator	AM86729163	\$ 146.06
3a CR920, CR940, CR960, CR970	Feeder Drive, Primary w/o Variator	AM86589482	\$ 170.00
3b CR920, CR940, CR960, CR970	Feeder Drive, Vari-Speed w/ Variator	AM86596143	\$ 336.00
4 CR920, CR940, CR960, CR970	Elevator Grain Drive	AM86595191	\$ 32.75
5 CR920, CR940, CR960, CR970	Rotor Variator, STD, 115.91"	AM87053803	\$ 528.00
5 CR920, CR940	Rotor Variator, STD w/ Max Speed Req, 113.97"	AM86596697	\$ 299.00
5 CR920, CR940, CR960	Rotor Variator, High Performance, 117.99"	AM87676816	\$ 512.00
5 CR920, CR940, CR960	Rotor Variator, High Speed, 117.99"	AM87053804	\$ 511.40
5 CR970	Rotor Variator, STD, 113.07"	AM87053805	\$ 446.91
5 CR970	Rotor Variator, High Performance, 115.91"	AM87540195	\$ 325.00
5 CR920, CR940, CR960, CR970	Rotor Variator, High Speed	AM86563175	\$ 335.00
6 CR920, CR940, CR960, CR970	Return Drive, LH	AM84056913	\$ 40.65
6 CR920, CR940, CR960, CR970	Return Drive, LH Enhanced Clean	AM87325684	\$ 45.29
7 CR920, CR940, CR960, CR970	Beater Drive	AM87580099	\$ 84.00
8 CR920, CR940, CR960, CR970 BSN HAJ101501	Chopper Drive, Lower	AM84320963	\$ 101.00
8 CR920, CR940, CR960, CR970 ASN HAJ101501	Chopper Drive, Lower	AM87580100	\$ 78.00
9 CR920, CR940, CR960, CR970 BSN HAJ101501	Chopper Drive, Upper	AM84320963	\$ 101.00
9 CR920, CR940, CR960, CR970 ASN HAJ101501	Chopper Drive, Upper	AM87031779	\$ 87.61
10 CR920, CR940, CR960, CR970	Main Drive	AM87580097	\$ 156.12
11 CR920, CR940, CR960, CR970	Unloading Auger Drive 2 Banded Belt	AM87011585	\$ 92.00
12 CR920, CR940, CR960, CR970	Feeder Drive, Secondary	AM84072421	\$ 293.00
13 CR920, CR940, CR960, CR970	Rotary Fan	AM84057085	\$ 29.00
14 CR920, CR940, CR960, CR970	Rotary Fan	AM87325327	\$ 6.75
15 CR920, CR940, CR960, CR970	Rotary Fan	AM445930	\$ 26.50
15 CR920, CR940, CR960, CR970	Rotary Fan, High Speed, 9 Blade	AM87323050	\$ 31.00
16 CR920, CR940, CR960, CR970	Shaker Shoe	AM86566287	\$ 55.00
16 CR920, CR940, CR960, CR970	Shaker Shoe, Enhanced Clean	AM87315599	\$ 45.60
NI CR920, CR940 BSN HAJ100801	A/C Compressor, Water Pump and Alternator	AM84057710	\$ 36.46
NI CR920, CR940 ASN HAJ100801	A/C Compressor, Water Pump and Alternator	AM84447961	\$ 68.32
NI CR960	A/C Compressor	AM84818007	\$ 12.00
NI CR970	A/C Compressor	AM84818008	\$ 13.46
NI CR920, CR940	Air Compressor, Blow Off System	AM84061465	\$ 22.25

New Holland®—Combine

Belts—CR6090, CR7090, CR8080, CR8090

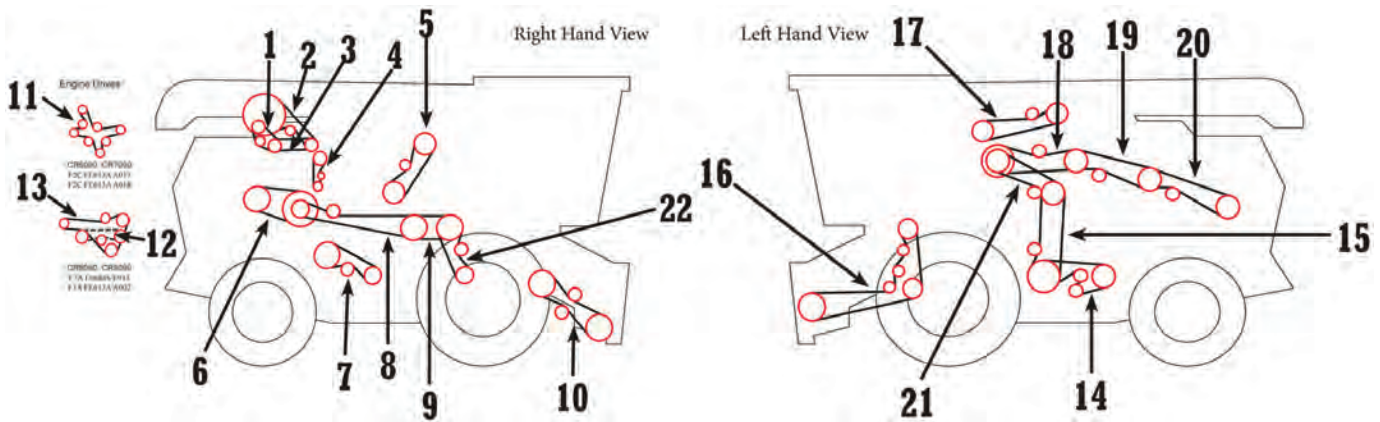

Application	Description	Part Number	Retail Price
1 CR6090, CR7090	Fan Drive	AM918062	\$ 39.00
1 CR8080, CR8090	Fan Drive	AM87284244	\$ 22.75
2 CR6090, CR7090, CR8080, CR8090	Rotary Screen (Upper)	AM87664428	\$ 32.00
3 CR6090, CR7090	Rotary Screen (Lower)	AM87556830	\$ 12.00
3 CR8080, CR8090	Rotary Screen (Lower)	AM84817635	\$ 35.95
4 CR6090, CR7090, CR8080, CR8090 - 09/2012 and Later	Dust Screen Aspirator	AM84422774	\$ 13.47
5 CR6090, CR7090, CR8080, CR8090	Grain Elevator Drive	AM84137965	\$ 103.00
6 CR6090, CR7090, CR8080 - Prior to 07/2012	Drum Variator	AM87676816	\$ 512.00
6 CR6090, CR7090, CR8080 - 07/2012 and Later	Drum Variator	AM84491659	\$ 511.10
6 CR8090 Prior to 07/2012	Drum Variator	AM87540195	\$ 325.00
6 CR8090 07/2012 and Later	Drum Variator	AM84491658	\$ 325.10
7 CR6090, CR7090, CR8080, CR8090	Bottom Auger and Tailings Elevator, Right Hand	AM84332132	\$ 32.15
8 CR6090, CR7090, CR8080, CR8090	Header Drive (Corn and Bean Only)	AM84352808	\$ 177.00
8 CR6090, CR7090, CR8080, CR8090	Header Drive (Grain Only)	AM84352807	\$ 162.00
8 CR6090, CR7090, CR8080, CR8090 - Prior to 02/2012	Header Drive, Variable (Corn and Bean Only)	AM84298895	\$ 158.00
8 CR6090, CR7090, CR8080, CR8090 - 02/2012 and Later	Header Drive, Variable (Corn and Bean Only)	AM84589013	\$ 227.70
8 CR8090	Header Drive (ADV Stone Protect)	AM84298895	\$ 158.00
8 CR8090	Header Drive (ADV Stone Protect)	AM84589013	\$ 227.70
9 CR6090, CR7090, CR8080, CR8090	Feeder Drive Variator (Corn and Bean Only)	AM87583907	\$ 304.34
9 CR8080	Feeder Drive Variator (ADV Stone Protect)	AM84398996	\$ 123.00
10 CR6090, CR7090, CR8080, CR8090	Feeder Drive, Right Hand	AM84254480	\$ 146.00
11 CR6090, CR7090	Engine Belt (F2C FE613A A017 and A018) Replaces 47452304	AM84292639	\$ 20.00
12 CR8080, CR8090	A/C Belt (F3A E0684S E913 and F3A FE613A A002) Replaces 87592007, 504368979	AM84238514	\$ 11.50
13 CR8080, CR8090	Alternator / Water Pump (F3A E0684S E913 and F3A FE613A A002)	AM84238513	\$ 36.00
14 CR6090, CR7090, CR8080, CR8090	Shaker Shoe Drive, Self-Leveling	AM84353448	\$ 50.00
15 CR6090, CR7090, CR8080, CR8090	Beater, Intermediate Drive	AM87315599	\$ 45.60
15 CR6090, CR7090, CR8080, CR8090, CR9080	Beater Drive	AM51462504	\$ 74.00
15 CR6090, CR7090, CR8080, CR8090	Beater Speed Up	AM51449123	\$ 72.00
17 CR6090, CR7090, CR8080, CR8090	Unloading Auger Drive	AM47451475	\$ 174.00
16 CR6090, CR7090, CR8080, CR8090	Feeder Drive, Left Hand (2 Banded Belt)	AM84274885	\$ 246.00
16 CR6090, CR7090, CR8080, CR8090	Feeder Drive, Left Hand 4 Banded Belt	AM87545653	\$ 337.00

New Holland®—Combine

Application	Description	Part Number	Retail Price
16 CR8080	Feeder Drive, Left Hand (ADV Stone Protect)	AM84394081	\$ 567.00
17 CR6090, CR7090, CR8080, CR8090	Unloading Auger Drive 2 Banded Belt	AM87011585	\$ 92.00
18 CR6090, CR7090, CR8080, CR8090	Main Drive	AM87545651	\$ 208.00
19 CR6090, CR7090, CR8080	Chopper, Intermediate Drive (Front)	AM87580100	\$ 78.00
19 CR8090	Chopper, Intermediate Drive (Front)	AM87557181	\$ 191.41
19 CR6090, CR7090, CR8080, CR8090	Chopper, Intermediate Drive (For Chopper Ready Drive)	AM87580100	\$ 78.00
20 CR6090, CR7090, CR8080	Chopper, Intermediate Drive (Rear)	AM87580100	\$ 78.00
20 CR8090	Chopper, Intermediate Drive (Rear)	AM84188121	\$ 156.00
21 CR6090, CR7090, CR8080, CR8090	Beater Drive	AM87546479	\$ 90.30
22 CR8090	Stone Trap Drive, Low Speed (ADV Stone Protect)	AM84398998	\$ 124.88
22 CR8090	Stone Trap Drive, High Speed (ADV Stone Protect)	AM84398997	\$ 140.00

Belts—CR9040, CR9060, CR9070, CR9080, CR9090

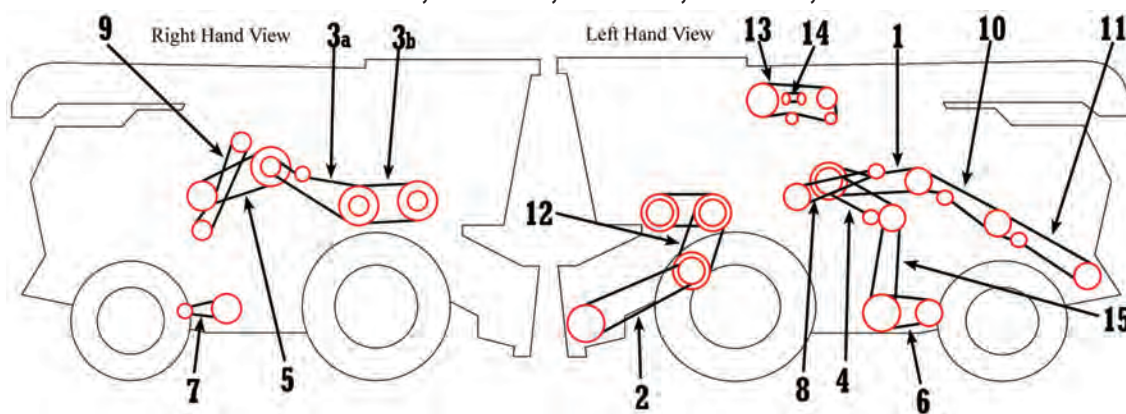

Application	Description	Part Number	Retail Price
1 CR9040, CR9060 (STD)	Main Drive	AM87580097	\$ 156.12
1 CR9060 (OPT), CR9070, CR9080, CR9090	Main Drive	AM87545651	\$ 208.00
2 CR9040, CR9060 (STD)	Feeder Drive, Secondary	AM84072421	\$ 293.00
2 CR9060 (OPT), CR9070, CR9080, CR9090	Feederhouse Drive, Secondary 4 Banded Belt	AM87545653	\$ 337.00
3a CR9040, CR9060, CR9070	Feeder Drive, Primary w/ Variator STD Drive	AM86729163	\$ 146.06
3a CR9040, CR9060, CR9070, CR9080	Feeder Drive, Primary, Speed Up Drive w/ Variator	AM87583899	\$ 137.00
3a CR9040, CR9060, CR9070, CR9080	Feeder Drive, Primary w/o Variator	AM86589482	\$ 170.00
3b CR9040, CR9060, CR9070	Feeder Drive, Vari-Speed w/ Variator STD Drive	AM86596143	\$ 336.00
3b CR9040, CR9060, CR9070, CR9080	Feeder Drive, Vari-SPD, Speed Up w/ Variator	AM87583907	\$ 304.34
3ab CR9090	Feeder Drive	AM87741240	\$ 169.07
4 CR9040, CR9060	Beater Drive	AM87580099	\$ 84.00
4 CR9060 (OPT), CR9070, CR9080, CR9090	Beater Drive	AM87546479	\$ 90.30
4 CR9090	Beater Drive	AM51462504	\$ 74.00
4 CR9080, CR9090	Beater Speed Up	AM51449123	\$ 72.00
5 CR9040, CR9060	Rotor Variator, 117.99"	AM87053804	\$ 511.40
5 CR9070	Rotor Variator, 115.91"	AM8705380	Call for Price
5 CR9060, CR9070 BSN C627	Rotor Variator, 117.99"	AM87622201	\$ 511.40
5 CR9060, CR9070 ASN D627	Rotor Variator, High Performance, 117.99"	AM87676816	\$ 512.00
5 CR9080, CR9090 BSN C660	Rotor Variator, 115.91"	AM87547837	\$ 325.00
5 CR980, CR9090 ASN D660	Rotor Variator, High Performance, 115.91"	AM87540195	\$ 325.00

New Holland®—Combine

New Holland®—Combine

Application	Description	Part Number	Retail Price
6 CR9040, CR9060, CR9070, CR9080, CR9090	Return Drive, LH	AM87325684	\$ 45.29
7 CR9040, CR9060, CR9070, CR9090 BSN C676	Bottom Auger Tailings Elevator Set of 2	AM84058339	\$ 32.15
7 CR9080, CR9090 BSN F676720	Tailings Elevator Drive, RH	AM84455757	\$ 32.15
7 CR9090 ASN D720	Tailings Elevator Drive, RH	AM84196804	\$ 39.00
8 CR9040, CR9060, CR9070, CR9080, CR9090	Unloading Auger Drive 2 Banded Belt	AM87011585	\$ 92.00
8 CR9090	Unloading Auger Drive	AM47451475	\$ 174.00
9 CR9040, CR9060, CR9070, CR9080	Elevator Grain Drive	AM87319821	\$ 78.10
9 CR9090	Elevator Grain Drive	AM84137965	\$ 103.00
10 CR9040, CR9060, CR9070, CR9080	Chopper w/ Spreader	AM87031779	\$ 87.61
10 CR9090	Chopper w/ Spreader	AM87557181	\$ 191.41
11 CR9040, CR9060, CR9070, CR9080	Chopper Drive	AM87580100	\$ 78.00
11 CR9090 BSN C724	Chopper Drive	AM87526022	\$ 107.21
11 CR9090 ASN D724	Chopper Drive	AM84168012	\$ 100.00
12 CR9090	Fan Drive, Hydraulic	AM87636309	\$ 23.90
13 CR9090	Dust Screen	AM87653464	\$ 44.92
14 CR9090	Dust Screen	AM9818704	\$ 23.00
15 CR9040, CR9060, CR9070, CR9080, CR9090	Shaker Shoe Drive	AM87315599	\$ 45.60
NI CR9040, CR9060	A/C Compressor	AM504212528	\$ 18.53
NI CR9070, CR9080	A/C Compressor Replaces 87592007, 504368979	AM84238514	\$ 11.50
NI CR9090	A/C Unit, Lower	AM84818008	\$ 13.46
NI CR9090	A/C Unit, Upper	AM87662910	\$ 33.50
NI CR9090	A/C Unit, Middle	AM87663279	\$ 36.00
NI CR9040, CR9060	Water Pump	AM87344277	\$ 36.00

Belts—CX840, CX860, CX880, CX8070, CX8080, CX8090

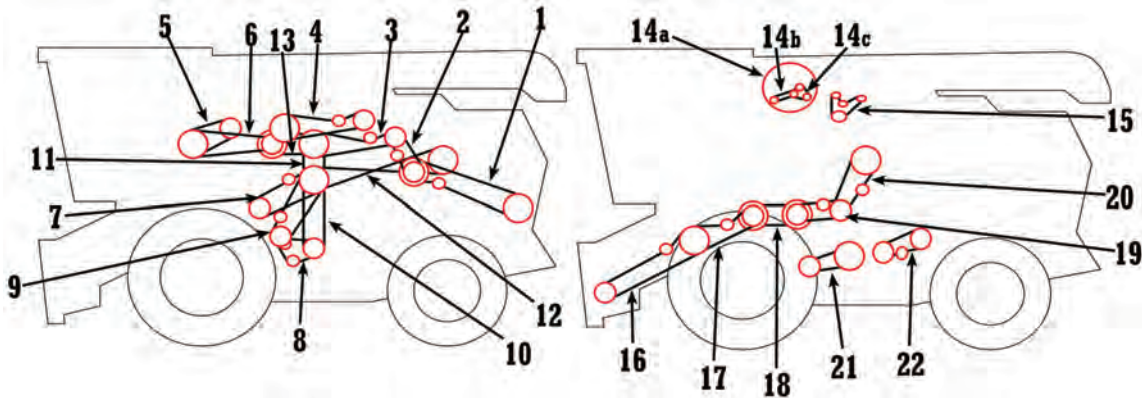

Application	Description	Part Number	Retail Price
1 CX840, CX860, CX880	Chopper Drive, Lower	AM84075635	\$ 119.00
1 CX8070, CX8080, CX8090 BSN C724	Chopper Drive, Lower	AM87339998	\$ 178.38
1 CX8070, CX8080, CX8090 ASN D724	Chopper Drive, Lower	AM84175580	\$ 178.38
2 CX840, CX860, CX880	Chopper Drive, Upper	AM84075345	\$ 90.30
2 CX8070, CX8080, CX8090 ASN C724	Chopper Drive, Upper	AM84175581	\$ 91.50
3 CX840, CX860, CX880	Main Drive	AM84057914	\$ 262.53
3 CX8070, CX8080, CX8090 BSN C724	Main Drive	AM84057914	\$ 262.53
3 CX8070, CX8080, CX8090 ASN D724	Main Drive	AM84175582	\$ 258.00
4 CX840, CX860, CX880, CX8070, CX8080, CX8090	Unloading Auger	AM84061293	\$ 89.00
5 CX840, CX860, CX880, CX8070, CX8080, CX8090	Beater Drive	AM84045256	\$ 57.64

Prices Subject to Change without Prior Notice. The use of original equipment manufacturer (OEM) part numbers or trademarks, e.g. Case® and John Deere®, are for reference purposes only and for indicating product use and compatibility. Our company and the listed replacement parts contained herein are not sponsored, approved or manufactured by the OEM. All parts are New unless designated Reman in the description.

New Holland®—Combine

Application	Description	Part Number	Retail Price
6 CX840, CX860, CX880, CX8070, CX8080, CX8090	Drum Drive w/ or w/o Reduction	AM84061615	\$ 145.00
7 CX840, CX860, CX880, CX8070, CX8080, CX8090	Shaker Shoe, Fixed Shoe	AM84432785	\$ 47.47
8 CX840, CX860, CX880, CX8070, CX8080, CX8090	Shaker Shoe, Self Leveling	AM84056913	\$ 40.65
9 CX840, CX860, CX880, CX8070, CX8080, CX8090	Tailings Elevator and Shaker Shoe, Self Level	AM84057874	\$ 59.50
10 CX840, CX860, CX880, CX8070, CX8080, CX8090	Tailings Elevator, Fixed Shoe	AM84435035	\$ 99.00
11 CX840, CX860, CX880, CX8070, CX8080, CX8090	Cleaning Drive, Intermediate Shaft	AM84057392	\$ 75.52
12 CX840, CX860, CX880, CX8070, CX8080, CX8090	Straw Walker	AM84057482	\$ 53.00
13 CX840, CX860, CX880, CX8070, CX8080	Variator Drum	AM84035748	\$ 293.00
13 CX8090	Variator Drum	AM87635650	\$ 443.52
14a CX840, CX860, CX880, CX8070, CX8080, CX8090 BSN C600	Rotary Fan	AM84057085	\$ 29.00
14a CX8070, CX8080, CX8090 ASN D600	Rotary Fan	AM87664428	\$ 32.00
14b CX840, CX860, CX880, CX8070, CX8080, CX8090	Rotary Fan	AM84061465	\$ 22.25
14c CX840, CX860, CX880	Rotary Fan, High Speed	AM87337385	\$ 30.71
14c CX840, CX860, CX880, CX8070, CX8080	Rotary Fan	AM9835816	\$ 12.00
14c CX8090	Rotary Fan	AM84459056	\$ 45.00
15 CX840	A/C Compressor, Water Pump and Alternator	AM84057710	\$ 36.46
16 CX840, CX860, CX880, CX8070, CX8080, CX8090	Straw Elevator, 2 Band	AM84434260	\$ 160.00
17 CX840, CX860, CX880, CX8070, CX8080, CX8090	Straw Elevator, 2 Band	AM84434295	\$ 78.00
17 CX840, CX860, CX880, CX8070, CX8080, CX8090	Straw Elevator, 4 Band	AM84334995	\$ 412.00
18 CX840, CX860, CX880, CX8070, CX8080, CX8090	Header Drive	AM84061279	\$ 146.06
19 CX840, CX860, CX880 BSN C416	Elevator Drive, Rotary	AM84057393	\$ 87.00
19 CX840, CX860, CX880 ASN D416	Separator Drive, Rotary	AM84457079	\$ 74.82
19 CX8070, CX8080, CX8090	Separator Drive, Rotary	AM84457079	\$ 74.82
20 CX840, CX860, CX880, CX8070, CX8080, CX8090	Grain Elevator	AM84073457	\$ 27.29
21 CX840, CX860, CX880, CX8070, CX8080, CX8090	Variator Speed Fan, Fixed Shoe	AM919739	\$ 320.61
21 CX840, CX860, CX880	Variator Drive Fan, Self Level	AM9502654	\$ 76.25
21 CX8070, CX8080, CX8090	Variator Drive Fan, Self Level	AM84817627	\$ 78.00
21 CX840, CX860, CX880, CX8070, CX8080, CX8090	Variator Drive Fan, Fixed Shoe, Grass Seed EQ	AM84023278	\$ 95.00
21 CX840, CX860, CX880, CX8070, CX8080, CX8090	Variator Drive Fan, Self Level, Grass Seed EQ	AM84023277	\$ 146.17
22 CX840, CX860, CX880	Bottom Auger Tailings Elevator Set of 2	AM84058339	\$ 32.15
22 CX8070, CX8080, CX8090 BSN C676	Bottom Auger Tailings Elevator Set of 2	AM84058339	\$ 32.15
22 CX8070, CX8080, CX8090 ASN D720	Bottom Auger Tailings Elevator	AM84196804	\$ 39.00
22 CX8070, CX8080, CX8090 BSN F676720	Bottom Auger Tailings Elevator	AM84455757	\$ 32.15
NI CX860 ASN D348, CX8070, CX8080 BSN C564	A/C Compressor, Dryer	AM84818007	\$ 12.00
NI CX880 ASN D348, CX8090	A/C Compressor, Dryer	AM84818008	\$ 13.46

New Holland®—Combine

Belts—CR6.80, CR6.90, CR7.90, CR8.90, CR9.90, CR10.90

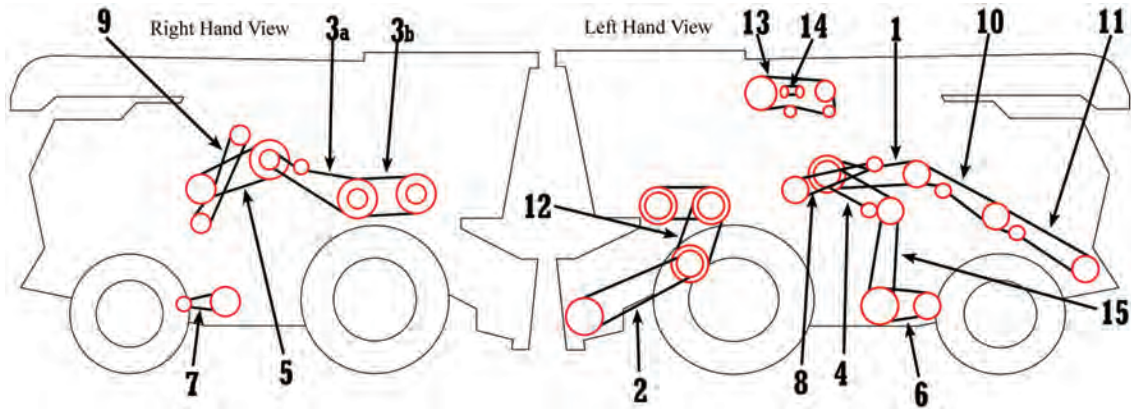

Application	Description	Part Number	Retail Price
1 CR6.80, CR6.90, CR7.90	Fan Drive	AM918062	\$ 39.00
1 CR8.90	Fan Drive	AM84336005	\$ 26.17
1 CR9.90	Fan Drive	AM87663279	\$ 36.00
2 CR6.80, CR6.90, CR7.90	Dust Screen, Upper Long Belt	AM87664428	\$ 32.00
2 CR8.90, CR9.90	Dust Screen, Upper Long Belt	AM87758085	\$ 31.80
3 CR6.80, CR6.90, CR7.90	Dust Screen, Lower Short Belt	AM87556830	\$ 12.00
4 CR6.80, CR6.90, CR7.90, CR8.90, CR9.90, CR10.90	Dust Screen Aspirator	AM84422774	\$ 13.47
5 CR6.80, CR6.90, CR7.90, CR8.90, CR9.90, CR10.90	Elevator Grain Drive	AM84137965	\$ 103.00
6 CR8.90, CR9.90	Rotor Drum Variator	AM84491658	\$ 325.10
6 CR10.90	Rotor Drum Variator	AM87540195	\$ 325.00
7 CR6.80, CR6.90, CR7.90, CR8.90, CR9.90, CR10.90	Bottom Auger and Tailings Elevator, Right Hand	AM84332132	\$ 32.15
8 CR6.90, CR7.90, CR8.90, CR9.90	Variable Header Drive w/o Dynamic Feed Roll	AM84589013	\$ 227.70
8 CR10.90	Variable Header Drive w/ Dynamic Feed Roll High Speed	AM84589013	\$ 227.70
9 CR6.90, CR7.90, CR8.90, CR9.90, CR10.90	Variable Header Drive w/ Dynamic Feed Roll	AM47487792	\$ 502.00
9 CR6.80, CR6.90, CR7.90, CR8.90, CR9.90	Variable Header Drive w/o Dynamic Feed Roll	AM87583907	\$ 304.34
9 CR6.90, CR7.90, CR8.90, CR9.90, CR10.90	Header Drive w/ Dynamic Feed Roll High Speed	AM84398996	\$ 123.00
10 CR6.80, CR6.90, CR7.90, CR8.90, CR9.90, CR10.90	Feeder Drive w/o Dynamic Feed Roll, Right Hand	AM84254480	\$ 146.00
11 CR6.80, CR6.90, CR7.90	A/C Compressor Drive Replaces 47452304	AM84292639	\$ 20.00
12 CR8.90, CR9.90, CR10.90	Compressor Replaces 87592007, 504368979	AM84238514	\$ 11.50
13 CR8.90	Alternator	AM47506727	\$ 28.00
13 CR9.90	Alternator	AM47513876	\$ 41.00
13 CR10.90	Alternator	AM47569912	\$ 29.29
14 CR6.80, CR6.90, CR7.90, CR8.90, CR9.90, CR10.90	Shaker Shoe Drive	AM84353448	\$ 50.00
15 CR6.80, CR6.90, CR7.90, CR8.90, CR9.90, CR10.90	Beater and Cleaning Drive	AM87315599	\$ 45.60
16 CR6.80, CR6.90, CR7.90, CR8.90, CR9.90, CR10.90	Feeder Drive w/ Dynamic Feed Roll, Left Hand	AM84582509	\$ 435.00
16 CR6.90, CR7.90, CR8.90, CR9.90	Feeder Drive w/o Dynamic Feed Roll 2 Banded Belt	AM84274885	\$ 246.00
16 CR6.80, CR6.90, CR7.90, CR8.90, CR9.90, CR10.90	Feeder Drive w/o Dynamic Feed Roll, Left Hand (Corn Only) 4 Banded Belt	AM87545653	\$ 337.00

Prices Subject to Change without Prior Notice. The use of original equipment manufacturer (OEM) part numbers or trademarks, e.g. Case® and John Deere®, are for reference purposes only and for indicating product use and compatibility. Our company and the listed replacement parts contained herein are not sponsored, approved or manufactured by the OEM. All parts are New unless designated Reman in the description.

New Holland®—Combine

	Application	Description	Part Number	Retail Price
17	CR6.80, CR6.90, CR7.90	Unloading Auger Drive 2 Banded Belt	AM87011585	\$ 92.00
17	CR8.90, CR9.90, CR10.90	Unloading Auger Drive	AM47499273	\$ 136.94
17	CR7.90, CR8.90, CR9.90, CR10.90	Unloading Auger Drive	AM47451475	\$ 174.00
18	CR6.80, CR6.90, CR7.90	Main Drive	AM87545651	\$ 208.00
18	CR8.90, CR9.90	Main Drive	AM47414501	\$ 179.00
18	(CR9.90, CR10.90 Early)	Main Drive	AM47554216	\$ 359.00
19	CR6.80, CR6.90, CR7.90	Straw Chopper Drive, Front	AM87580100	\$ 78.00
20	CR8.90, CR9.90, CR10.90	Straw Chopper Drive, Rear	AM87580100	\$ 78.00
20	CR8.90, CR9.90, CR10.90	Straw Chopper, Rear	AM84188121	\$ 156.00
21	CR6.80, CR6.90, CR7.90, CR8.90, CR9.90, CR10.90	Beater Drive	AM87546479	\$ 90.30
21	CR6.80, CR6.90, CR7.90, CR8.90, CR9.90	Beater Drive	AM51462504	\$ 74.00
21	CR6.80, CR6.90, CR7.90, CR8.90, CR9.90, CR10.90	Beater Speed Up	AM51449123	\$ 72.00
22	CR6.80, CR6.90, CR7.90, CR8.90, CR9.90, CR10.90	Crop Feeding Drive, Slow Speed	AM84398998	\$ 124.88
22	CR6.80, CR6.90, CR7.90, CR8.90, CR9.90, CR10.90	Crop Feeding Drive High and Dual Speed	AM47434574	\$ 140.81
23	CR10.90	Dust Screen, Upper Belt	AM47649529	\$ 51.48
24	CR10.90	Dust Screen, Middle Belt	AM87662910	\$ 33.50
27	CR10.90	Fan Drive	AM87663279	\$ 36.00
27	CR6.80, CR6.90, CR7.90, CR8.90, CR9.90, CR10.90	Header Drive w/o Dynamic Feed Roll	AM47452756	\$ 161.00
27	CR6.80, CR6.90, CR7.90, CR8.90, CR9.90, CR10.90	Header Drive (Corn Only)	AM47441074	\$ 233.00
NI	CR9.90, CR10.90	Hydraulic Fan Drive	AM87683178	\$ 30.00
NI	CR6.90, CR7.90, CR8.90, CR9.90, CR10.90	Variator Drum	AM47998736	\$ 530.00

Ford®/New Holland®—Industrial / Construction

Table of Contents

Air Conditioning and Component.....	772	Radiators Hoses.....	771
Crankshafts	771	Rear Wheel Drive	772
Hydraulic Pumps	771		

Crankshafts

Application	Description	Part Number	Retail Price	Core
Backhoe-Loader: 7500, Wheel Loader: A62 Replaces 1598N, D5NN6303FA, D9NN6110AA, D9NN6303A, D9NN6303AA, E5NN6303CA	Crankshaft w/ Gear BSD444 268 CID 4.4 Liter 4 Cylinder Engine 4.400" Stroke, 4.4007" - 4.403" Bore, 2.7496" - 2.7504" Rod, 3.3713" - 3.3723" Main Flange - Centering Ring, 6 Bolt Holes, 1 Dowel Hole Snout - 1 Bolt Hole, 1 Keyway, w/ 78 Tooth Balance Drive Gear 12.50 mm Wide, Right Hand Helix	AME5NN6303DA-2	\$ 495.00	
Backhoe-Loader: 7500, Wheel Loader: A62 Replaces D5NN6303FA, D9NN6110AA, D9NN6303A, D9NN6303AA, E5NN6303CA	Crankshaft w/ Gear BSD444 268 CID 4.4 Liter 4 Cylinder Engine 4.400" Stroke, 4.4007" - 4.403" Bore, 2.7496" - 2.7504" Rod, 3.3713" - 3.3723" Main Flange - Centering Ring, 6 Bolt Holes, 1 Dowel Hole Snout - 1 Bolt Hole, 1 Keyway, w/ 76 Tooth Balance Drive Gear 15.00 mm Wide, Right Hand Helix	AME5NN6303DA-76-2	\$ 495.00	



Radiators Hoses

Application	Description	Part Number	Retail Price	Core
Backhoe-Loaders: (450, 550, 555, 650, 655A Prior to 7/31/1987, 6500 - Diesel)	Radiator Hose, Upper 1.50" ID Replaces 81805628, 83907414, C5NN8260A, C5NN8260B, D5NN8260DV	AMD5NN8260D	\$ 5.95	
Backhoe-Loaders: 450 Gas or Diesel, 6500	Radiator Hose, Lower 1.645" & 1.757" ID Replaces 81805638, 83907879, 87745803, C5NN8286CV	AMC5NN8286C	\$ 10.95	

Hydraulic Pumps

Application	Description	Part Number	Retail Price	Core
Graders: F140, F140 VP, F140B, F170, F170B, F200, F200B, G140, G140 VP, G170, G170 6X6, G170 VP, G200, G200 6X6, RG170.B, RG170.B VHP-QSB, RG200.B	Hydraulic Pump 90 cc	AM75323556	\$ 4250.00	
Wheel Loaders: LW130.B, W130, W130B, W130C, W130TC	Hydraulic Pump Replaces 377608A1, 75320405, 76082592	AM47773405	\$ 2103.00	
Wheel Loaders: LW170.B, W170B, W170C	Hydraulic Pump, Front 63 cc Replaces 8604947, 87435911	AM8602879	\$ 3210.00	
Wheel Loaders: LW170.B, W170B, W170C	Hydraulic Pump, Rear 43 cc	AM8602880	\$ 2090.00	
Wheel Loaders: W190B, W190C	Hydraulic Pump, Front 43 cc Replaces 47777726	AM87332520	\$ 1950.00	
Wheel Loaders: W190B, W190C	Hydraulic Pump, Rear 65 cc Replaces 47777727	AM87332521	\$ 1695.00	

Ford®/New Holland®—Industrial / Construction

Application	Description	Part Number	Retail Price	Core
Wheel Loader: W270C	Hydraulic Pump, Rear Replaces 84327051	AM48009612	\$ 2705.00	
Wheel Loaders: W270C, W300C	Hydraulic Pump, Front Replaces 84327082	AM48009611	\$ 2748.00	

Rear Wheel Drive

Application	Description	Part Number	Retail Price	Core
Crawlers/Dozers: D75, D75B, D85, D85B, D95, D95B, DC75, DC85, DC95, LW50 SN 190013-190032, LW50.B ASN 506169, LW80.B Tier 2 ASN 560630, W50BTC, W50TC, W60BTC, W70BTC, W80BTX, W80TC	Hydraulic Wheel Motor 80 cc	AM401629A2	\$ 3960.00	

Air Conditioning and Components

Application	Description	Part Number	Retail Price	Core
Backhoe-Loaders - 550, 555, 555A, 555B, 555C, 555D, 575D, 655, 655A, 655C, 655D, 675D, 755, 755A, 755B Replaces 86010530	Blower Motor, Vented Single Speed, Double Shaft, 2-Wire, Reversible, 3/8" Shaft Diameter, 4 3/8" Long	AMX10118	\$ 108.00	

Geringhoff®—Cornhead

Table of Contents



Cornhead—Row Unit Components 773

Cornhead—Stalk Stompers and Components 773



Cornhead—Stalk Stompers and Components

Application	Description	Part Number	Retail Price	Core	
Horizon Series	Stalk Stomper Kit, 2 Row Covers 1 Row on Each side of Cornhead	AMX31032	\$ 825.00		
	Stalk Stomper Kit, 4 Row Covers 2 Rows on Each side of Cornhead	AMX31033	\$ 1300.00		
	Stalk Stomper Kit, 6 Row Covers 3 Rows on Each side of Cornhead	AMX31034	\$ 2025.00		
	Stalk Stomper Kit, 8 Row Covers 4 Rows on Each side of Cornhead	AMX31035	\$ 2675.00		
	Stalk Stomper Kit, 12 Row Covers 6 Rows on Each side of Cornhead	AMX31036	\$ 3425.00		
	Stalk Stomper Kit, 16 Row Covers 8 Rows on Each side of Cornhead	AMX31037	\$ 4000.00		
	Stalk Stomper Kit, 18 Row Covers 9 Rows on Each side of Cornhead	AMX31038	\$ 4675.00		
	NorthStar™, Patriot, Rota Disc®	Stalk Stomper Kit, 2 Row Covers 1 Row on Each side of Cornhead	AMX31039	\$ 825.00	
		Stalk Stomper Kit, 4 Row Covers 2 Rows on Each side of Cornhead	AMX31040	\$ 1300.00	
Stalk Stomper Kit, 6 Row Covers 3 Rows on Each side of Cornhead		AMX31041	\$ 2025.00		
Stalk Stomper Kit, 8 Row Covers 4 Rows on Each side of Cornhead		AMX31042	\$ 2675.00		
Stalk Stomper Kit, 12 Row Covers 6 Rows on Each side of Cornhead		AMX31043	\$ 3425.00		
Stalk Stomper Kit, 16 Row Covers 8 Rows on Each side of Cornhead		AMX31044	\$ 4000.00		
Horizon Series		Header Mounting Bracket, Right Hand	AMX30017	\$ 55.00	
		Header Mounting Bracket, Left Hand	AMX30018	\$ 55.00	
NorthStar™, Rota Disc®	Header Mounting Bracket, Right Hand	AMX30019	\$ 55.00		
	Header Mounting Bracket, Left Hand	AMX30020	\$ 55.00		
	End Support Bracket Set Accommodates 2" x 2" Square Toolbar Includes Right and Left Hand Bracket	AMX30021	\$ 130.00		

Cornhead—Row Unit Components

Application	Description	Part Number	Retail Price	Core
 (MS Cornstar™, NorthStar™, Rota Disc® - w/ 20" and 22" Row Spacing), (PC Series - w/ 28"-38" Row Spacing)	Gathering Chain 72 Links, 6 Lugs	AM034850	\$ 76.00	
	Gathering Chain 72 Links, 9 Lugs	AM034860	\$ 70.00	
 MS Cornstar™, NorthStar™, Rota Disc® - w/ 30"-40" Row Spacing	Gathering Chain 76 Link, 6 Lugs	AM34851	\$ 70.00	
	Gathering Chain 76 Links, 9 Lugs	AM34859	\$ 70.00	

Geringhoff®—Cornhead

	Application	Description		Part Number	Retail Price	Core
	Rota Disc®	Chopping Disc Standard, (15) Required per Shaft		AM501063	\$ 45.00	
		Chopping Disc Hard Surfaced, (15) Required per Shaft		AM501064	\$ 49.00	
	Rota Disc®	Snapping Roll Knife	Right Hand	AM502356	\$ 46.00	
		Hard Surfaced, (2) Required per Roll	Left Hand	AM502357	\$ 46.00	
	NorthStar™	Snapping Roll Knife	Right or Left Hand	AM502351	\$ 35.00	
	Rota Disc®	Knife Disc		AM501060	\$ 29.00	
	MS Cornstar™, NorthStar™, Rota Disc® - w/ 30" Row Spacing	Idler Sprocket 17 Tooth		AM032012	\$ 42.00	

Honey Bee®—Header

Table of Contents

Draper Belts..... 775



Draper Belts

Application	Description	Part Number	Retail Price	Core
Platform: AF230	Side Draper Belt 30', 41.75" x 286"	AM89048	\$ 609.00	
Platform: AF236	Side Draper Belt 36', 41.75" x 358"	AM89049	\$ 765.00	
Platform: AF250	Side Draper Belt 50', 41.75" x 526"	AM89052	\$ 1109.00	
Platform: AF245	Side Draper Belt 45', 41.75" x 466"	AM89051	\$ 983.00	
Platform: AF225	Side Draper Belt 41.75" x 226"	AM201376	\$ 507.00	
Platform: AF240	Side Draper Belt 41.75" x 406" Single V-Guide	AM89050	\$ 832.00	
Platforms: SP18, SP21, SP25, SP30, SP36, SP40, SP42	Draper Center Feeder Belt 68.75" x 65.00"	AM86616916	\$ 390.00	
Platform: SP25 2009-16 w/ Center Delivery	Side Draper Belt 25', Right or Left Hand, 41.75" x 236.00" Single V-Guide	AM83714	\$ 504.00	
Platforms: SP36 2009-16 w/ Center Delivery	Side Draper Belt 36', Right or Left Hand, 41.75" x 374.00" Single V-Guide Replaces 84480130	AM83721	\$ 759.00	
Platform: SP42 2009-16 w/ Center Delivery	Side Draper Belt 42', Right or Left Hand, 41.75" x 448.00" Single V-Guide Replaces 84388981	AM83725	\$ 879.00	
Platform: SP40 2006-2008 - w/ Center Delivery	Side Draper Belt Right or Left Hand, 42.00" x 423.00" No Guide Replaces 84480464	AM83467	\$ 643.00	
Platform: SP36 1999-2008 - w/ Center Delivery	Side Draper Belt Right or Left Hand, 42.00" x 374.00" No Guide Replaces 84480154	AM70363	\$ 577.00	
Platform: SP25 1999-2008 w/ Center Delivery	Side Draper Belt Right or Left Hand, 42.00" x 236.00" No Guide	AM64261	\$ 432.00	
Platform: SP30 1999-2008 w/ Center Delivery	Side Draper Belt Right or Left Hand 42.00" x 174.00" No Guide Replaces 84480149	AM70362	\$ 500.00	

Honey Bee®—Header

International®—Tractor

Table of Contents

Air Cleaner Components.....	799	Manifolds and Components.....	795
Air Conditioning and Components.....	843	Mechanical Front Wheel Drive Parts.....	800
Alternators.....	799	MFWD Differentials and Components.....	802
Axle Center Tubes and Beams.....	809	MFWD Hub Components.....	801
Axle Knee Extensions.....	809	MFWD Hubs and Housings.....	800
Axle Pivot Assembly and Pins.....	810	Mufflers and Exhaust.....	796
Ball and Socket Parts.....	810	Multiple Control Valves.....	813
Battery Boxes and Components.....	831	Oil Coolers, Engine.....	783
Belts.....	789	Oil Pumps, Engine.....	782
Brake Pinion Shafts.....	825	Overhaul Kits.....	777
Brakes and Components.....	823	Planetary Gears.....	823
Cab Components—Miscellaneous.....	841	Power Steering Cylinders and Components.....	811
Cab Doors.....	840	Power Steering Orbit Motors.....	813
Camshafts and Lifters.....	781	Power Steering Pumps and Conversion Kits.....	812
Carburetors.....	790	PTO Adapters.....	818
Clear View Cap Kits.....	846	PTO Assemblies and Components.....	821
Connecting Rods.....	780	PTO Shafts.....	817
Cowl (Dash) Covers.....	833	PTO Shields.....	822
Crankshaft Damper Pulleys.....	781	Quick Hitches.....	830
Crankshafts.....	780	Radiator Hoses and Thermostats.....	785
Cylinder Heads, Bare.....	782	Radiators and Components.....	783
Decals.....	832	Remote Valves and Valve Kits.....	813
Differentials and Components.....	823	Ring Gears and Pinions.....	823
Distributors.....	798	Shift Lever Housing and Cover.....	818
Draft Sensing Parts.....	831	Shop Manuals and Collections.....	846
Drawbars and Components.....	825	Shortblock Assemblies.....	777
Fenders, Platforms and Components.....	833	Side Panels.....	832
Flywheels and Ring Gears.....	787	Spindles.....	804
Front Axle Repair Kits.....	800	Starters.....	98
Front Grilles, Nose Cones and Components.....	832	Steering Arms and Components.....	808
Fuel Lift Pumps.....	791	Steering Wheels and Caps.....	842
Gas Struts.....	842	Steps.....	834
Gear Set Conversion for 88 Series.....	818	Sway Limiters.....	831
Glass.....	841	Tachometers.....	799
Grab Handles.....	842	Three Point Hitch Components.....	828
Hammer Straps.....	827	Tie Rods and Components.....	802
Hydraulic Oil Cooler.....	811	Toplink Assemblies.....	830
Hydraulic Pumps.....	811	Torque Amplifier Assemblies and Components.....	818
Hydrostats and Components.....	814	Transmission Components, Range and Speed.....	814
Injection Pumps.....	791	Transmission Parts.....	817
Injectors.....	794	Turbochargers.....	795
IPTO Gear Bearings and Seal Kits.....	820	Water Pumps.....	788
IPTO Shafts.....	819	Wheel Bearing Kits.....	807
Lift Link Assemblies and Components.....	827	Wheel Hubs and Components.....	807
Lighting.....	835	Wheel Wedges and Components.....	823
Longblock Assemblies.....	777	Wide Front Ends.....	800
Lower Lift Links.....	830		

International®—Tractor



Longblock Assemblies

Our remanufactured longblocks meet the highest standards in quality. All remanufactured components are inspected for structural integrity, cracks and dimensional specifications and then remanufactured back to OEM specifications. The components are then assembled using the highest quality new parts. We back this with one of the best warranties in the industry.

Application	Description	Part Number	Retail Price	Core
1066, 1086 - w/ DT414 6 Cylinder Engine	Reman Longblock Assembly Vent in Valve Cover	LBHT414T2	\$ 5600.00	\$ 1500.00
1486, 1586 - w/ DT436 6 Cylinder Engine	Reman Longblock Assembly Vent in Valve Cover	LBHT436T2	\$ 5600.00	\$ 1500.00
3588, 3788 - w/ DT466 6 Cylinder Engine	Reman Longblock Assembly Vent in Valve Cover	LBHT466T2	\$ 5600.00	\$ 1500.00

Shortblock Assemblies

Our remanufactured shortblocks meet the highest standards in quality. All remanufactured components are inspected for structural integrity, cracks and dimensional specifications and then remanufactured back to OEM specifications. The components are then assembled using the highest quality new parts. We back this with one of the best warranties in the industry.



Application	Description	Part Number	Retail Price	Core
454, 464, 474, 484, 485, 495, Ind; 2400A, 2400B - All w/ 179 3 Cylinder Diesel Engine	Reman Shortblock Assembly	SBIH179D	\$ 4450.00	\$ 750.00
544, 574, 674, 684 - w/ 239 4 Cylinder Diesel Engine	Reman Shortblock Assembly	SBIH239D	\$ 4550.00	\$ 1500.00
884, 885 - w/ 268 4 Cylinder Diesel Engine	Reman Shortblock Assembly	SBIH268D	\$ 4600.00	\$ 1500.00
706, 756 - w/ 310 6 Cylinder Diesel Engine	Reman Shortblock Assembly	SBIH310D706	\$ 4950.00	\$ 1000.00
786, 826, 886, 2826, 3088, 3288 - w/ 358 6 Cylinder Diesel Engine	Reman Shortblock Assembly	SBIH358D826	\$ 5600.00	\$ 1000.00
856, 1026 - w/ D407 6 Cylinder Diesel Engine	Reman Shortblock Assembly	SBIH407D856	\$ 5600.00	\$ 1250.00
1256, 1456 - w/ DT407 6 Cylinder Diesel Engine	Reman Shortblock Assembly	SBIH407DT1456	\$ 5600.00	\$ 1250.00



Overhaul Kits

Application	Description		Retail Price	Core
Cub*, Cub Lo-Boy*, Cub 154, Cub 185 Lo-Boy	C60 Engine - Gas	Inframe Kit	\$ 446.00	
*High Compression Upgrade to Domed Aluminum Pistons from Original Cast Iron Pistons	Engine BSN 264568	Overhaul Kit	\$ 495.00	
A, (Super A, Super AV SN 250001-310299), AV, B, BN, C* SN 000501-047999 & ASN 048499	C113 Engine - Gas and LPG	Inframe Kit	\$ 460.00	
*w/ Block Marked 251069R1 or 366204R2	Dome Top Pistons, Engines w/o Water Pump Conversion	Overhaul Kit	\$ 473.00	
100, 140, 200, Super A, Super C	C113 and C123 Engine - Gas and LPG	Overhaul Kit	\$ 462.00	
	C113 (ASN 31301), C123 (ASN 35831)			
130, 140, 230, 240	C133 and C123 Engine - Gas and LPG	Inframe Kit	\$ 423.00	
	Dome Top Pistons, Engines w/ Water Pump	Overhaul Kit	\$ 478.00	
330, 340	C135 Engine - Gas and LPG	Inframe Kit	\$ 711.00	
	Engine BSN 100501	Overhaul Kit	\$ 735.00	
404, Ind: 2404	C135 Engine - Gas and LPG	Inframe Kit	\$ 812.00	
	Engine ASN 100500	Overhaul Kit	\$ 820.00	
(H, HV BSN 391358), (I4, O4, OS4, W4 BSN 033340)	C152 Engine - Gas	Inframe Kit	\$ 565.00	
	Early, Dome Top Piston	Overhaul Kit	\$ 587.00	

Prices Subject to Change without Prior Notice. The use of original equipment manufacturer (OEM) part numbers or trademarks, e.g. Case® and John Deere®, are for reference purposes only and for indicating product use and compatibility. Our company and the listed replacement parts contained herein are not sponsored, approved or manufactured by the OEM. All parts are New unless designated Reman in the description.

International®—Tractor

Application	Description		Retail Price	Core
(H, HV ASN 391357), (I4, O4, OS4, W4 ASN 033339)	C152 Engine - Gas Late, Dome Top Piston	Inframe Kit	\$ 490.00	
		Overhaul Kit	\$ 561.00	
444, 504, Ind/Const: 2444, 2500, 2504, 3514	C153 Engine - Gas and LPG	Inframe Kit	\$ 551.00	
		Overhaul Kit	\$ 622.00	
Super H, Super HV, Super I4, Super W4	C164 Engine - Gas	Inframe Kit	\$ 820.00	
		Overhaul Kit	\$ 819.00	
300, 350	C169 and C175 Engine - Gas and LPG	Inframe Kit	\$ 559.00	
		Overhaul Kit	\$ 604.00	
544, 574, 674, Ind/Const: 2500A, 2505B, 2510B, 2514B, 2544, 3500A, Wheel Loader: 100	C200 Engine - Gas and LPG	Inframe Kit	\$ 573.00	
		Overhaul Kit	\$ 613.00	
460	C221 Engine - Gas and LPG Engine BSN 035094	Inframe Kit	\$ 736.00	
		C221 Engine - Gas and LPG Engine ASN 035093	Inframe Kit	\$ 761.00
		C221 Engine - Gas and LPG	Overhaul Kit	\$ 527.00
I6 BSN 035600, (M, MV BSN 2780050), (O6, W6 BSN 035464), Ind/Const: T6 BSN 007611	C248 Engine - Gas Early	Inframe Kit	\$ 837.00	
		Overhaul Kit	\$ 971.00	
Ind/Const: T-6 ASN 007610	C248 Engine - Gas Late	Inframe Kit	\$ 804.00	
		Overhaul Kit	\$ 862.00	
560 Engine BSN 036694, 660 Engine BSN 038982, Crawler: (T-6 62 Series Engine BSN 036694)	C263 Engine - Gas and LPG	Inframe Kit	\$ 755.00	
		Overhaul Kit	\$ 755.00	
656, 706, Ind/Const: 2656, 2706, 3800, 3850, T-6 (62 Series)	C263 Engine - Gas and LPG Late	Inframe Kit	\$ 604.00	
		Overhaul Kit	\$ 634.00	
(400, W400 BSN 031240), Super M, Super W6, Ind/Const: T-6 (61 Series)	C264 Engine - Gas and LPG Engine BSN 163808, Dome Top Piston, 1.312" Piston Pin	Inframe Kit	\$ 613.00	
		Overhaul Kit	\$ 634.00	
(400, W400 ASN 031239), 450, W450	C264 and C281 Engine - Gas and LPG C264 Engine ASN 163807, Fire Crater Head Pistons, 1.00" Piston Pin	Inframe Kit	\$ 655.00	
		Overhaul Kit	\$ 695.00	
666, 686, 706, 756, 766, Hydro 70, Hydro 86, Ind/Const: 2706, 2756	C291 Engine - Gas and LPG	Inframe Kit	\$ 550.00	
		Overhaul Kit	\$ 610.00	
806, 826, 856, Ind/Const: 2806, 2826, 2856	C301 Engine - Gas and LPG	Inframe Kit	\$ 707.00	
		Overhaul Kit	\$ 713.00	
364, 384, 424, 444, B414, Ind/Const: 2424, 2444, 3414, 3444	BD154 Engine - Diesel	Inframe Kit	\$ 544.00	
		Overhaul Kit	\$ 605.00	
454, 464, 484, 485, 495, Ind/Const: 2400A, 3400A, 4500	D179 Engine - Diesel	Inframe Kit	\$ 690.00	
		Overhaul Kit	\$ 689.00	
(504 Farmall® Engine BSN 012093 or International® Engine BSN 011525), Ind/Const: (2500, 2504 Engine BSN 011525), 3514 Engine BSN 012090	D188 Engine - Diesel Early	Inframe Kit	\$ 739.00	
		Overhaul Kit	\$ 774.00	
(504 Farmall® Engine ASN 012092 or International® Engine ASN 011524), Ind/Const: (2500, 2504 Engine ASN 011524), 3514 Engine ASN 012089	D188 Engine - Diesel Late	Inframe Kit	\$ 713.00	
		Overhaul Kit	\$ 778.00	
584, 585, 595, 624, 654, 3230, Ind/Const: 100, TD-7	D206 Engine - Diesel	Inframe Kit	\$ 874.00	
		Overhaul Kit	\$ 966.00	
460	D236 Engine - Diesel Engine BSN 005611	Inframe Kit	\$ 1745.00	
		Overhaul Kit	\$ 1802.00	
606, Ind/Const: 2606, 3616	D236 Engine - Diesel Engine SN 013754-016620	Inframe Kit	\$ 1058.00	
		Overhaul Kit	\$ 1317.00	
544, 574, 664, 674, 684, 685, 695, Ind/Const: 100E, 125, 125C, 250A, 2500, 2500A, 2500B, 2505B, 2510B, 2514B, 2544, 3500A, 3514, TD-7E, TD-8C	D239 Engine - Diesel	Inframe Kit	\$ 691.00	
		Overhaul Kit	\$ 742.00	

International®—Tractor

Application	Description		Retail Price	Core
Ind/Const: 125E, TD-8E	DT239 Engine - Diesel	Inframe Kit	\$ 1011.00	
		Overhaul Kit	\$ 1122.00	
784, 844, Hydro 84	D246 Engine - Diesel Engine BSN D123041	Inframe Kit	\$ 791.00	
		Overhaul Kit	\$ 802.00	
884 Engine ASN D052919, 885, 895, 4230, Ind/Const: 270A, 510 Engine ASN D003779, TD-8C	D268 Engine - Diesel	Inframe Kit	\$ 775.00	
		Overhaul Kit	\$ 808.00	
560 Engine BSN 006766, 660 Engine BSN 004370, Ind/Const: (TD-6 62 Series, Engine BSN 002XXX), TD-9 92 Series, TD-9B Engine BSN 006903	D282 and DT282 Engine - Diesel	Inframe Kit	\$ 740.00	
		Overhaul Kit	\$ 750.00	
(560, 660, 656, 706 Engine SN 044822-071777), Ind/Const: (2656, 2706 Engine SN 044822- 071777), (TD-6 62 Series, Engine SN 002XXX- 003711), TD-9B Engine SN 006903-011440	D282 and DT282 Engine - Diesel	Inframe Kit	\$ 740.00	
		Overhaul Kit	\$ 750.00	
686, 706, 756, Hydro 86, Ind/Const: 2706, 2756	D310 Engine - Diesel	Inframe Kit	\$ 978.00	
		Overhaul Kit	\$ 1095.00	
666, 686, Hydro 70, Hydro 86	D312 Engine - Diesel	Inframe Kit	\$ 1781.00	
		Overhaul Kit	\$ 1908.00	
786, 826, 886, 3088, 3288, Ind/Const: 520B Dresser, 2826	D358 Engine - Diesel	Inframe Kit	\$ 978.00	
		Overhaul Kit	\$ 1283.00	
766, 886, Ind/Const: 515, H60E	D360 Engine - Diesel	Inframe Kit	\$ 1115.00	
		Overhaul Kit	\$ 1221.00	
806, Ind: 2806	D361 Engine - Diesel	Inframe Kit	\$ 1180.00	
		Overhaul Kit	\$ 1278.00	
1206, Ind/Const: 21206, E200, TD-15B	DT361 Engine - Diesel	Inframe Kit	\$ 1502.00	
		Overhaul Kit	\$ 1727.00	
856, 1026, 1256, Ind/Const: 2856, 21026, 21256, TD-15B	D407 and DT407 Engine - Diesel	Inframe Kit	\$ 1079.00	
		Overhaul Kit	\$ 1190.00	
1456, Ind/Const: 21456, E200	DT407 Engine - Diesel	Inframe Kit	\$ 1113.00	
		Overhaul Kit	\$ 1185.00	
966	D414 Engine - Diesel	Inframe Kit	\$ 1018.00	
		Overhaul Kit	\$ 1216.00	
1066, 1086	DT414 Engine - Diesel	Inframe Kit	\$ 1018.00	
		Overhaul Kit	\$ 1216.00	
986, 1066, 3688, Hydro 100, Hydro 186	D436 Engine - Diesel	Inframe Kit	\$ 1018.00	
		Overhaul Kit	\$ 1216.00	
1466, 1486, 1566, 1586, 3388, 4166, 4186, 5088, 6388	DT436 Engine - Diesel	Inframe Kit	\$ 1018.00	
		Overhaul Kit	\$ 1216.00	
3588, 3788, 4366, 4386, 5288, 5488, 6588, 6788	DT466 Engine - Diesel Engine BSN 439618	Inframe Kit	\$ 1018.00	
		Overhaul Kit	\$ 1216.00	
(4366, 4386, 5488, 7288, 7488 - w/ DT466A Engine), (3488, 3588, 3788, 4386, 5288, 5488, 6588, 6788 - w/ DT466B Engine), Combines: (1470 BSN 12001, 1480 BSN 44001 - w/ DT466B Engine), 1470 ASN 12001 w/ DT466C Engine	DT466 Engine - Diesel SN 076440-439617, SN 439618-440035 DT466C	Inframe Kit	\$ 1093.00	
		Overhaul Kit	\$ 1169.00	
5488, 7288, 7488, Ind/Const: 540 Dresser	DT466 Engine - Diesel Engine SN 439618-532980	Inframe Kit	\$ 1018.00	
		Overhaul Kit	\$ 1216.00	



Crankshafts

Application	Description	Part Number	Retail Price	Core
364, 384, 444 - w/ D154, D165, D171, BD154 or 144 Engines Replaces 247-5143, 05700AB, 751303, 751303R2, 751303R3, 751303R5	Crankshaft D154 154 CID 2.5 Liter, D165 165 CID 2.7 Liter - 4 Cylinder Engines 4" Stroke, (154) 3.500", (165) 3.625", (171) 3.6875" Bore, 2.374" - 2.375" Rod, 2.499" - 2.500" Main Flange - No Centering Ring, 4 Bolt Holes, 2 Dowel Pin Holes Snout - Threaded End, 2 Keyways	AM3110995R91	\$ 235.00	
544, 574, 674, 684 Replaces 182752R2, 2744406R1, 3132752R3, 3144626R1	Crankshaft D239 239 CID 3.9 Liter 4 Cylinder Diesel Engine 5.0625" Stroke, 3.875" Bore, 2.5185" - 2.5193" Rod, 3.1484" - 3.1492" Main Flange - Flat, 7 Bolt Holes, 1 Dowel Hole, w/ 80 Tooth Helical Balance Gear in Center 5/8" Wide Snout - Straight, 3 Bolt Holes	AM3144626R91	\$ 695.00	
826, 886, 955XC, 2826, 3088, 3288, Combines: 1420 Replaces 3136036R95	Crankshaft D358, DT358 - 358 CID 5.8 Liter 6 Cylinder Diesel Engines 5.059" Stroke, 3.875" - 3.8759" Bore, 2.5185" - 2.5193" Rod, 3.1484" - 3.1492" Main Flange - No Centering Ring, Flat, 7 Bolt Holes, 1 Dowel Snout - 3 Bolt Holes, Bolt On Counterweights	AM3059514R1-2	\$ 975.00	
966, 1066, 1086, Combine: 815	Crankshaft D414 and DT414 - 6.8 Liter, 414 CID, 6 Cylinder Diesel Engines	AM675050C1	\$ 1425.00	
1466, 1486, 1566, 1586, 3688, 4166, 4186, Hydro 100	Crankshaft D436, DT436 - 436 CID 7.1 Liter 6 Cylinder Diesel Engines 5.040" Stroke Flange - Flat, 8 Bolt Holes Snout - Straight, 3 Bolt Holes, 1 Keyway	AM675051C1	\$ 1425.00	
3588, 3788, 4366, 4386, 5288, 5488, Ind/Utility: E412, H80B, L175C Replaces 675591C1, 675591C2, 675591C3, 675591C4, 675669C3, 1816975C1	Crankshaft DT466, DT466B, DT466C, DT466E, DT1466B - 7.6 Liter, 466 CID 6 Cylinder Diesel Engine 5.350" Stroke, 4.3005" - 4.3015" Bore, 2.9977" - 2.999" Rod, 3.3742" - 3.3755" Main Flange - Flat, 8-Bolt Holes Snout - Straight, 3 Bolt Holes, 1 Keyway, w/ 33 Tooth Timing Gear, Left Hand Helix, w/ 41 Tooth Oil Pump Drive Gear	AM675669C93	\$ 1425.00	
(Cub, Cub Lo-Boy BSN 261717)	Crankshaft	AM353743R93	\$ 335.00	
Ind: 510B Replaces 218528R2, 218528R3	Crankshaft 268 268 CID 4.4 Liter 4 Cylinder Diesel Engine 5.500" Stroke, 3.937" Bore, 2.5185" - 2.5193" Rod, 3.1484" - 3.1492" Main Flange - Flat, 7 Bolt Holes, 1 Dowel Snout - Straight, 3 Bolt Holes	AM3228376R91	\$ 610.00	

Connecting Rods

All connecting rods are cleaned and inspected for defects prior to remanufacturing. Rods are then shot-peened for stress relief and the size is checked against OEM specifications. New piston pin bushings are installed in each rod and bored to the correct center-to-center dimensions. The center-to-center dimension greatly affects the performance of your engine and is a step that many remanufacturers ignore. Final assembly of our connecting rods include installation of new rod bolts and verifying product dimensions, including bend and twist, one final time.



Application	Description	Part Number	Retail Price	Core
Engines: D414, D436, D466, DT414, DT436, DT466, DT466B, DT466C, DT1466, DT1466B, DT1466C	Connecting Rod Reman Connecting Rod Replaces 688923C91, 671659C1, 675640C91, 684294C91	AM688923C91 AMCR688922-R	\$ 128.50 \$ 100.00	
460, 560, 565, 706, 756 - w/ Gas	Reman Connecting Rod Cast # - 367406	AMCR367406-R	\$ 106.00	\$ 20.00

International®—Tractor

Application	Description	Part Number	Retail Price	Core
544, 574, 674, 786, 826, 886 Late, 3088	Reman Connecting Rod 1.181" Wide Bearing Cast # - 3055030	AMCR3055030-R	\$ 225.00	\$ 35.00
	Reman Connecting Rod 1.264" Wide Bearing Cast # - 3055030	AMCR3055030-RE	\$ 225.00	\$ 35.00
(560, 660 Diesel - Late), 706 Diesel	Reman Connecting Rod Cast # - 306280	AMCR306280-R	\$ 125.00	\$ 30.00
666, 686, 766, 886 Early, Hydro 70, Hydro 86	Reman Connecting Rod Cast # - 672116	AMCR672116-R	\$ 115.00	\$ 35.00
686, 706, 756 Diesel, Hydro 86	Reman Connecting Rod Cast # - 3055029	AMCR3055029-R	\$ 175.00	\$ 35.00
806 Diesel, 856	Reman Connecting Rod Cast # - 332260	AMCR332260-R	\$ 115.00	\$ 35.00
966, 986, 1066, 1086, 1466, 1486, 1566, 1586, 3388, 3588, 3788, 4166, 4186, 4366, 5088, 5288, 5488, Hydro 100, Hydro 186	Reman Connecting Rod Cast # - 688923	AMCR688923-R	\$ 106.00	\$ 35.00
1256, 1456	Reman Connecting Rod Cast # - 670678, 1.625" Pin Diameter	AMCR670678-R	\$ 172.00	\$ 35.00



Crankshaft Damper Pulleys

Application	Description	Part Number	Retail Price	Core
666, 686, 766, 886 BSN 14472, 966, 986, 1066, 1086, 3488, 3588, 3688, 4166, 4186, 5088, 6588, Hydro 70, Hydro 86, Hydro 100, Hydro 186 - w/ D312, D360, D414, D436, D466, DT414, DT436 or DT466 Engine	Crankshaft Damper Pulley	AM680275C92	\$ 262.00	
806, 856, 1026, 1206, 1256, 1456, Ind: 2806, 2856, 21026, 21206, 21256, 21456	Crankshaft Damper Pulley 3.57" Wide, 1.9365" ID, 9.136" OD	AM701036C93	\$ 308.00	
(1466, 1486, 1566, 1586 - w/ DT436 Engine), (3788, 5288, 6788 - w/ DT466 Engine), Combines: (1480, 1640, 1660, 1680 - w/ DT466)	Crankshaft Damper Pulley	AM683459C94	\$ 295.00	

Camshafts and Lifters



Application	Description	Part Number	Retail Price	Core
966, 986, 1066, 1086, 1466, 1486, 1566, 1586, 3388, 3488, 3588, 3688, 3788, 4166, 4186, 4366, 4386, 5088, 5288, 5488, 6388, 6588, 6788, Hydro 100, Hydro 186	Camshaft and Lifter Kit 0.996" Lifter Diameter Includes Gear, Key and Thrust Washer	AMCB1012	\$ 537.00	
Gas & LP Engines: C221, C236, C282, C291, C301, Diesel Engines: D236, D282, D301	Camshaft	AM367229R1	\$ 275.00	
D361 and D407 6 Cylinder Diesel Engines	Camshaft Requires 1 5/8" Cam Plate	AM670349C1	\$ 275.00	
	Lifter, Mushroom	AM407ML	\$ 10.00	
966, 986, 1066, 1086, 1466, 1486, 1566, 1586, 3488, 3588, 3788, 4166, 4186, 4366, 4386, 5088, 5288, 5488, 6388, 6588, 6788, 7288, 7488, Hydro 100	Camshaft Lifter For all 414, 436, 466 Engines (Using Deep Well 1" Lifters)	AM1802337C1 AM400NL	\$ 205.00 \$ 8.00	
414, 436, 466 Engines	Lifter, Deep Well 1 1/8" Diameter	AM400WL	\$ 8.50	
All D466 Diesel Engines w/ Roller Lifter Camshafts (w/ serial prefix 466, 467, 468 1975-1993)	Camshaft	AM1810744C1	\$ 315.00	

International®—Tractor

Cylinder Heads, Bare

Our remanufactured cylinder heads are cleaned, pressure-tested and resurfaced. New seats and guides are installed using OEM specifications. These heads are ready for final assembly.



Application	Description	Part Number	Retail Price	Core
Cub 154, Cub	Cylinder Head, Bare	AM251228R11	\$ 215.00	
364, 384, 434, 444, B414 - w/ BD154 Diesel Engine	Cylinder Head, Bare w/ Guides	AM3044490R1	\$ 425.00	
460, 560 Gas	Reman Cylinder Head, Bare Cast # - 367188R	AMCHIH263GB	\$ 1150.00	\$ 50.00
560 w/ 282 Engine	Reman Cylinder Head, Bare Cast # - 278368R	AMCHIH282D-1B	\$ 1625.00	\$ 250.00
706 w/ 282 Engine	Reman Cylinder Head, Bare Cast # - 323771R	AMCHIH282D-2B	\$ 1625.00	\$ 250.00
686, 706, 756 - w/ 310 Engine	Reman Cylinder Head, Bare Cast # - 3055050R1	AMCHIH310DB	\$ 650.00	\$ 50.00
1066, 1086, 1466, 1486, 1566, 1586 - w/ 400 Series Engine	Reman Cylinder Head, Bare Cast # - 680426C1	AMCHIH466DB	\$ 1625.00	\$ 50.00
130, 140, 200, 230, 240, 330, 340, 404, 424, 444, 504, Super A, Super C, Ind/Const: 2404, 2424, 2444, 2500, 2504, 3514	Valve Train Kit Includes (4) Exhaust Valves, 5.27" Long, 45°, (4) Intake Valves, 5.28" Long, 45°, (8) Valve Guides, (4) Exhaust Valve Springs, (4) Intake Valve Springs and (16) Valve Keepers	AMVK1041	\$ 163.00	

Oil Pumps, Engine

All of our remanufactured engine oil pumps are disassembled, thoroughly cleaned and inspected. All worn parts are replaced and tolerances are checked to guarantee our oil pumps will perform to OEM specifications. The pump is reassembled and - as a safety measure - each pump is lubricated with Clevite Bearing Guard to ensure there is no damage during initial start up. Replacing the engine oil pump during an overhaul is a step many people overlook.



Application	Description	Part Number	Retail Price	Core
340, 460, 560, 606, 660, 656, 666, 686, 706, 756, 766, 826, 856, Hydro 70, Hydro 86, Ind/Const: 2606, 2656, 2706, 2756, 2806, 2826, 2856, 3616, 3800, 3850, 9000, (T-6, TD-6 62 Series), TD-9 92 Series, TD-9B, TD-340, Combines: 101, 151, 151 HillSide, 181, 315, 403, 615, Cotton Pickers: 214, 214A, 220, 220A, 414, 416, 420, 422, 612, 616, 622	Engine Oil Pump Screens Not Included	AM379138R91	\$ 224.25	
460, 504, 560, 606, 660, 656, 706, Ind: 2504, 2606, 2656, 2706, 3514, 3616, Crawlers/Dozers: (T-6, TD-6 62 Series), TD-9 Series 2, TD-9B, Wheel Loaders: 3800, 3850	Engine Oil Pump Use w/ Floating Screen	AM230421R91	\$ 225.00	
533, 584, 585, 595, 633, 644, 684, 685, 695, 784, 844, 884, 885, 896, 995, 3220, 3230, 4210, 4230, 4240, Hydro 85 - w/ D239 4 Cylinder Engine	Engine Oil Pump	AM3136430R95	\$ 225.00	
786, 826, 886	Engine Oil Pump	AM3136434R91	\$ 320.00	
3088, 3288	Reman Engine Oil Pump	AM3136433R95	\$ 425.00	\$ 50.00
Engines: 361, 407, 407T	Reman Engine Oil Pump	AM332520R94	\$ 725.00	\$ 200.00
Engines: 414, 436, 466	Engine Oil Pump	1" Gear AM1802666C91-1	\$ 181.72	
	Engine Oil Pump	1 1/4" Gear AM1808832C92	\$ 151.84	
Engines: D-312, D-360, D-414, D-436, D-466, DT-414, DT-436, DT-466, DT-466B, DTI-466, DTI-466B, DTI-466C	Engine Oil Pump Replaces 1802666C91, 108666C92, 675361C2	AM84409645	\$ 195.00	
766, 886, 966, 1066, 1086, 3488, 3588, 3788, 4366, 4386, 5288, 5488, 6588, 6788, 7288, 7488, Cotton Pickers: 414, 420, Diesel Engines: 436, 466, D-236, D-282, D-312, D-360, D-361, D-407, D-414, DT-DT-361, DT-407, DT-414, DT-429, DT-436, DT-466, DT-466B, DTI-466, DTI-466B, DTI-466C, V-800	Oil Pan Drain Plug Replaces 445096	AM688067C1	\$ 5.00	



Oil Coolers, Engine

Application	Description	Part Number	Retail Price	Core
Engines: D414, D436, DT414, DT436, DT466	Engine Oil Cooler	AM1810171C2	\$ 325.00	
Combines: 1660, 1666, 1670, 1680, 1688, 2166, 2188, 2366, 2377, 2388, Cotton Pickers: 1822, 1824, 2022, 2024, 2055, 2155, 2555 - All w/ 8.3 Cummins® Engine	Oil Cooler 12 Fins	AMJ918175	\$ 135.00	



Radiators and Components

Application	Description	Part Number	Retail Price	Core
140 1958-80	Radiator Replaces OEM Radiators w/ larger necks Core: 16 3/4" x 16" x 2" 3 Rows, 6 Fins per Inch	AM369400R94	\$ 450.00	
385 SN 5001-5287 & ASN 18001, 485 BSN 16472 & ASN 18001, 885 BSN 18001 - w/o A/C	Radiator Overall: 19" x 22 1/4" Core: 19" x 18 1/2" x 2" 3 Rows, 9 Fins per Inch	AM84524C93	\$ 250.00	
395, 495, 595, 695, 895 - 2WD w/o A/C	Radiator Core: 19 1/4" x 22 3/8" x 2"	AM1536373C1	\$ 435.00	
434, B275, B414	Radiator Overall: 16" x 16 1/2" x 2 5/8" Replaces 3107750R91, 3070812R92, 3044008R95, 845198R92, 3044008R91, 845201R92	AM3107749R91	\$ 575.00	
(460, 560 - Gas or Diesel), 660	Radiator Overall: 28 1/2" x 20 3/8" Core: 21 3/4" x 18 5/8" x 3 3/8" 5 Rows, 8 Fins per Inch Replaces 370414R1	AM370415R92	\$ 390.00	
504	Radiator Core: 15 1/2" x 20 1/4" x 2 1/8" 4 Rows	AM377090R92	\$ 612.00	
544 w/ Farmall® Gas Engine and Gear Drive, 666 Hydro ASN 10552, 706 w/ Farmall® Gas Engine ASN 37237 or International® Gas Engine 5274, 756 Gas	Radiator Core: 19 1/8" x 20 3/8" x 2 3/4" 4 Rows, 8 Fins per Inch	AM65426C1	\$ 475.00	
574, 674, Ind: 2500A - All w/ Diesel	Radiator Replaces 66496C2, 539567R1	AM539567R2	\$ 340.00	
574, Ind: 2500A - All w/ Gas Engines & Synchromesh Transmissions	Radiator Replaces 402202R1	AM539566R2	\$ 425.00	
585, 595, 685, 695, 885, 895 - w/ A/C	Radiator Overall: 18 1/2" x 25" Core: 19 3/8" x 19 5/16" x 2 1/4" 5 Rows, 9 Fins per Inch	AM84673C6	\$ 477.00	
656 w/ Farmall® Gas Engine or International® Diesel Engine, 706 w/ Farmall® Diesel Engine or International® Diesel BSN 5273, 706 Gas or LPG Engine w/ Heavy Duty Cooling, 756 Gas or LPG Engine w/ Heavy Duty Cooling	Radiator Long Neck Style Radiator, Lower Hose Left Side 2 3/4" Fill Neck Height	AM378713R92	\$ 450.00	
656, 2656 - w/ Gas or Diesel and Gear or Hydro Drive	Radiator Short Neck Style, 3/4" Fill Neck Height Core: 19" x 20 1/4" x 3 1/4"	AM396496R2	\$ 475.00	
666, 686, 706 w/ Farmall® Diesel Engine ASN 37237 or International® Diesel Engine ASN 5274, 756 Diesel, Hydro 70, Ind: 2706, 2756	Radiator Lower Hose Right Side Core: 19" x 20 3/8" x 3 1/4" Replaces 65427C1	AM396352R91	\$ 440.00	

International®—Tractor

Application	Description	Part Number	Retail Price	Core
(766, 886 - w/ D360 Diesel Engine), 966 (Gear Drive), 966 Hydro, 986, 1066, 1086, 1466, 1486, 1566, 1586, Hydro 100, Hydro 186	Radiator Overall: 23 3/8" x 30" Core: 22 1/2" x 24" x 3 7/8" 6 Rows, 8 Fins per Inch	AM71611C1	\$ 535.00	
786, 886 - w/ German Diesel Engine	Radiator Core: 22 1/8" x 24" x 2"	AM104594C2	\$ 675.00	
766, 886, 966, 986, 1066, 1086, 1466, (1486, 1586 - w/o A/C), 1566, Hydro 100, Hydro 186 - w/ A/C	Radiator Core: 22.50" x 24" 5 Rows, 8 Fins per Inch Replaces 71610C1, 121723C1, 533586R2	AM121725C1	\$ 760.38	
(806, 856 - Diesel, LPG & Heavy Duty Gas), 826 Gas, 1026, 1256, 1456	Radiator Core: 23" x 18 3/4" x 3 1/4" 5 Rows, 8 Fins per Inch Replaces 39193R91	AM386860R91	\$ 440.00	
826 Diesel	Radiator	AM405998R1	\$ 475.00	
3088, 3288, 3488 Hydro, 3688 w/ Cab	Radiator w/ 1 1/2" PTO Hole Core: 27" x 32 1/4" x 3 3/8" 5 Rows, 10 Fins per Inch	AM146503C1	\$ 1180.00	
3388, 3588, 3788, 6388, 6588, 6788	Radiator Core: 25" x 25 3/4" x 3 3/4"	AM130814C3	\$ 1130.00	
5088, 5288, 5488	Radiator Core: 26" x 30 1/2" x 3 3/8" 5 Rows, 9 Fins per Inch	AM146508C1	\$ 795.00	
Farmall®: 100, 130, 230, Super A, Super C	Radiator Core: 16" x 16" x 2 3/4" 4 Rows, 10 Fins per Inch	AM356356R94	\$ 320.00	
Farmall®: 400, 450	Radiator Core: 18 5/8" x 21 3/4" x 3 3/8" 5 Rows, 8 Fins per Inch Replaces 361417R93	AM361416R93	\$ 452.00	
Farmall®: A ASN 41320, B ASN 40193	Radiator Requires 81711544 Radiator Cap and 43984D Gasket Replaces 358105R91	AM58124DBX	\$ 275.00	
Farmall®: C	Radiator Core: 16" x 16" x 2 3/4" 4 Rows, 9 Fins per Inch	AM354875R93	\$ 325.00	
Farmall®: Cub	Radiator Core: 11 1/4" x 13 3/4" x 1 5/8" 3 Rows, 8 Fins per Inch	AM351878R92	\$ 150.00	
O4, OS4, W4, Super W4, Farmall®: H, Super H, HV, Super HV	Radiator Overall: 18" x 23 1/2" Core: 16" x 17 3/4" x 3 1/4" 5 Rows, 8 Fins per Inch	AM352628R92	\$ 370.00	
M, MD, Super M	Radiator Core: 18 3/4" x 21 3/4" x 1 5/8" 3 Rows, 8 Fins per Inch	AM352629R92	\$ 385.00	
3388, 3588, 3788, 4366, 4386, 4568, 4586, 4786, 6388, 6588, 6788, 7288, 7488	Radiator Cap Coolant Reservoir	AM437702C1	\$ 17.00	
3388, 3588, 3788, 4366, 4386, 4568, 4586, 4786, 6388, 7288, 7488	Overflow Tank Replaces 437703C2, 437703C3	AM437703C1	\$ 48.00	
544, 656, 664, 666, 686, 706, 756, 766, 786, 806, 826, 856, 886, 966, 986, 1066, 1086, 1206, 1256, 1456, 1466, 1468, 1486, 1566, 1568, 1586, 4100, 4156, 4166, 4186, Hydro 70, Hydro 86, Hydro 100, Hydro 186, Ind: 2544, 2656, 2706, 2756, 2806, 2826, 21206, 21256, 21456	Radiator Mounting Plate Bracket Replaces 3787109R91GV	AM378710R91	\$ 23.00	



Radiator Hoses and Thermostats

Application	Description	Part Number	Retail Price	Core
234	Radiator Hose, Upper 1.25" & 1.375" ID	AM1275081C1	\$ 13.70	
244, 254	Radiator Hose, Upper 1.312" & 1.375" ID	AM1269619C1	\$ 19.58	
460, 606	Radiator Hose, Upper 2" ID	AM369346R2	\$ 16.35	
474, 574 Diesel, 585, 674, 684, 685, 784, 785, 884, 885 BSN 3084, Hydro 84, Ind: 2500	Radiator Hose, Upper	AM402207R1	\$ 15.44	
504, Ind: 2504	Radiator Hose, Upper 2" ID	AM375172R1	\$ 10.11	
	Radiator Hose, Upper 2" ID	AM377145R1	\$ 14.46	
523, 644, 724, 743, 744, 745, 844, 845, 856	Radiator Hose, Upper 1.25" & 1.56" ID Replaces B513011	AM3134507R1	\$ 11.84	
544 Diesel, 664, Ind: 2544	Radiator Hose, Upper 2" ID	AM402212R1	\$ 24.35	
544 Diesel, Ind: 2544	Radiator Hose, Upper 2" ID	AM402346R1	\$ 19.55	
544, Ind: 2544 - All w/ Gas Engine	Radiator Hose, Upper 2" ID	AM401425R1	\$ 25.55	
560, Farmall®: 460	Radiator Hose, Upper 2" ID	AM369921R1	\$ 18.02	
574, 674, Ind: 2500 - All w/ Gas Engine	Radiator Hose, Upper 1.50" & 2" ID	AM402206R1	\$ 13.79	
656, 706 BSN 5274 and Farmall® BSN 37237, Ind: 2656, 2706 BSN 5274 and Farmall® BSN 37237	Radiator Hose, Upper 2" ID	AM379237R2	\$ 21.90	
656, 756 ASN 8328 and Farmall® ASN 15185, Hydro 70, Hydro 86 - w/ D310 Engine Ind: 2756 Farmall® ASN 15186	Radiator Hose, Upper 2" ID	AM406766R1	\$ 11.60	
660	Radiator Hose, Upper 2" ID	AM372640R1	\$ 28.66	
666, 686, 706 ASN 5273 and Farmall® ASN 37236, 756, Hydro 70, Hydro 86, Ind: 2706 ASN 5273 and Farmall® ASN 37236, 2756 - All w/ Gas Engine	Radiator Hose, Upper 2" ID	AM396353R1	\$ 20.78	
666, 686, Hydro 70, Hydro 86 - w/ D312 Engine	Radiator Hose, Upper 2" & 2.25" ID	AM65429C1	\$ 17.85	
706, 756, Ind: 2706, 2756, Engines: C263, C291, D282, D310	Radiator Hose, Upper 2" ID	AM396354R1	\$ 9.26	
766 w/ D368 Diesel Engine	Radiator Hose, Upper 2.25" ID	AM66003C1	\$ 27.00	
786, 886 w/ D358 Engine	Radiator Hose, Upper 2" ID	AM104595C1	\$ 17.04	
806, 826, 856 - Gas	Radiator Hose, Upper 2" ID	AM380379R1	\$ 25.95	
806, 856 - Diesel	Radiator Hose, Upper 2" & 2.25" ID	AM380380R1	\$ 10.49	
826, Ind: 2826 - All w/ Diesel Engine	Radiator Hose, Upper	AM405964R1	\$ 16.66	
1026, 1206, 1456, Ind: 21026, 21206, 21456	Radiator Hose, Upper	AM391932R1	\$ 22.80	
1066, 1086, 1466, 1486, 1566, 1586, Hydro 100, Hydro 186	Radiator Hose, Upper 2" & 2.25" ID	AM532680R1	\$ 10.66	
3088, 3288	Radiator Hose, Upper 2" ID	AM130295C1	\$ 31.19	
3488, 3688	Radiator Hose, Upper 2" & 2.25" ID	AM130270C1	\$ 25.29	
5088, 5288, 5488	Radiator Hose, Upper 2" & 2.25" ID	AM120780C1	\$ 35.52	

International®—Tractor

Application	Description	Part Number	Retail Price	Core
234	Radiator Hose, Lower 1.062" & 1.375" ID	AM1269609C1	\$ 17.10	
244, 254	Radiator Hose, Lower 1.312" & 1.375" ID	AM1269620C1	\$ 35.19	
Farmall®: 300, 350	Radiator Hose, Lower 1.50" ID	AM362833R1	\$ 14.33	
340*, 504 Gas, Ind: 2504, Farmall®: 300, 350 *w/ 369086R92 or 375394R91 Radiator Assembly	Radiator Hose, Lower 1.50" ID, 2.562" Long Replaces 48827DA	AM367834R2	\$ 3.22	
354, 364, 384, 434, B414	Radiator Hose, Lower 1.375" ID Replaces 3112068R1, B513009	AM3044009R1	\$ 9.03	
460, 560, 656, 660, 706	Radiator Hose, Lower 2" ID	AM371307R1	\$ 12.00	
460, 560, 656, 660, 706, 826, 995, Ind: 2656, 2706, Engines: C221, C263, C291, C301	Radiator Hose, Lower 2" ID	AM369922R1	\$ 10.00	
474, 574, 584, 595, 674, 684, 685, 695, 784, 884, 885, 995	Radiator Hose, Lower 1.532" & 2" ID Replaces 1706-1031	AM402205R1	\$ 10.00	
666, 686, Hydro 70, Hydro 86 - w/ D312 Engine	Radiator Hose, Lower 2" & 2.625" ID	AM65430C1	\$ 24.82	
(666, Hydro 70, Hydro 86 - w/ D310 Engine), 686, 706 ASN 5273 & Farmall® ASN 37236A, (756, 826 - Diesel), Ind: 2706 ASN 5273, 2756, 2826 Diesel	Radiator Hose, Lower 2" ID	AM396355R1	\$ 17.39	
766 Gas	Radiator Hose, Lower	AM532676R1	\$ 26.36	
	Radiator Hose, Lower 2" ID	AM532679R1	\$ 22.00	
766 Diesel	Radiator Hose, Lower 2.50" & 2.625" ID	AM532678R1	\$ 13.79	
806, 826, 856 - Gas	Radiator Hose, Lower 2" ID	AM378704R1	\$ 19.56	
806, 856 - Diesel	Radiator Hose, Lower 2" ID Replaces 380448R1	AM380448R2	\$ 13.12	
886 w/ D358 Engine	Radiator Hose, Lower 1.781" & 2" ID	AM131422C1	\$ 9.74	
	Radiator Hose, Lower	AM131421C1	\$ 13.33	
966, 986, 1066, 1086, 1466, 1486, 1566, 1586, Hydro 100, Hydro 186	Radiator Hose, Lower 2.50" & 2.625" ID	AM532681R1	\$ 5.02	
3088, 3288	Radiator Hose, Lower	AM1252883C1	\$ 12.51	
3388, 3588, 3788, 6388, 6588, 6788	Radiator Hose, Lower	AM131417C1	\$ 27.81	
3388, 3588, 3788, 6388, 6588, 6788, Combines: 815, 915	Radiator Hose, Upper 2", 2.25" ID Replaces 548216C1	AM548216R1	\$ 25.71	
3488, 3688	Radiator Hose, Lower	AM130271C1	\$ 22.92	
5088, 5288, 5488	Radiator Hose, Lower 2.50" & 2.75" ID	AM120779C1	\$ 30.40	
(666, 686, 766, 886, Hydro 70, Hydro 86 - Diesel), 966, 986, 1066, 1086, 1466, 1486, 1566, 1586, 3388, 3488, 3588, 3688, 3788, 4166, 4186, 4366, 5088, 5288, 6388, 6588, 6788, 7288, 7488, Hydro 186, Combines: 815, 915	Thermostat By-Pass Hose 1.16" ID	AM672242C2	\$ 6.68	
666, 686, 766, 886, 966, 986, 1086, 1466, 1486, 1566, 1586, 3388, 3488, 3588, 3688, 3788, 4166, 4186, 4366, 4386, 5088, 5288, 5488, 6388, 6588, 6788, Hydro 100	Thermostat Opening temperature of 190°F	AM684739C1	\$ 45.00	
H, Super H	Thermostat Hose 1.25" ID, 1.75" Long	AM45607DA	\$ 1.52	



Flywheels and Ring Gears

Application	Description	Part Number	Retail Price	Core
300, 330, 340, 350, 400, 450, 460, 504, 544, 560, 606, 656, 660, 664, 666, 686, Ind: 2544, 2606, 2656	Flywheel, Torque Amplifier Replaces 359895R1, 359895R2, 359895R3	AM359895	\$ 135.00	
574, 584, 595, 674, 684, 784, 884 - w/ D239 Engine	Flywheel For use w/ 11" Clutch	AM3136044R42	\$ 475.00	
656 Gear Drive Only	Flywheel	AM388302R21	\$ 1014.33	
706, 756, 786, 826, 886, 3088, 3288 - w/ D310 or D358 Diesel Engine	Flywheel	AM3055980R1	\$ 932.53	
(766, 886 - w/ D360 Diesel), 966, 986, 1066, 3488, 3688, Hydro 100, Hydro 186	Flywheel For use w/ 12" Clutch	AM672211C91	\$ 1155.63	
806 w/ D361 Engine, (856, 1026 - w/ D407 Engine), Ind: (2856, 21026 - w/ D407 Engine)	Flywheel Use w/ 12" Clutch	AM341603R31	\$ 450.00	
1066, 1086, 1466, 1486, 1566, 1586, 4166, 4186, 6388	Flywheel For use w/ 14" Clutch	AM672215C91	\$ 395.00	
1206, 1256, 1456, Ind: 21206, 21256, 21456 - All w/ DT361 or DT407 Engine	Flywheel For Use w/ 14" Clutch	AM326760R41	\$ 650.00	
3388, 3588, 3788, 6388, 6588, 6788	Flywheel	AM142022C91	\$ 525.00	
454 ASN 021314, 484, 485, 495, 3220 w/ 11" Clutch	Flywheel w/ Ring Gear 126 Tooth	AM3144614R95	\$ 1128.51	
666, 686 - w/ Gear Drive w/ 312 Diesel Engine	Flywheel w/ Ring Gear 134 Tooth Replaces 680712C91	AM282208A1	\$ 980.31	
686 w/ 310 Diesel Engine	Flywheel w/ Ring Gear	AM3218731R92	\$ 959.53	
56 Diesel, 400, 450, 660, M, Super M, MD, Super MD, Super W6, W400, W450, WD6	Flywheel Ring Gear 125 Tooth, 0.80" Wide, 14.485" ID, 15.72" OD	AM266142R1	\$ 107.05	
300, 330, 340, 350, Super H, W4	Flywheel Ring Gear 104 Tooth, 0.55" Wide, 12" ID, 13.165" OD	AM45638DB	\$ 61.00	
340, 350, 424, 460, 504, 544, 606, 656 Gear Drive w/ D282 Engine, 666, 686, Ind: 2424, 2444, 2504 BSN 13675, 2544, 2606, 3514 BSN 29632 w/o Shuttle	Flywheel Ring Gear 134 Tooth, 0.485" Wide, 12.332" ID, 13.56" OD	AM367042R1	\$ 63.62	
385, 395, 454, 484, 485, 495, 574, 584, 595, 684, 685, 695, 784	Flywheel Ring Gear 126 Tooth, 14.63" ID, 15.93" OD	AM60883H	\$ 45.00	
706, 756, 766, 786, 826, 856, 886, 966, 986, 1026, 1066 Hydro, 3088, 3288, 3488 Hydro, 3688 Hydro, Hydro 100, Hydro 186, Ind: 2826, 2856, 21026 - All w/ Diesel	Flywheel Ring Gear 132 Tooth, 15.49" ID, 16.68" OD	AM341604R1	\$ 50.00	
884, 885, 895, 995	Flywheel Ring Gear 128 Tooth, 0.5625" Wide, 4.625" ID, 16.125" OD	AM3218637R1	\$ 138.42	
(1066, 1086 - Gear Drive), 1206, 1256, 1456, 1466, 1468, 1486, 1566, 1568, 1586, 3388, 3588, 3788, 4100, 4156, 4166, 4186, 6388, 6588, 6788, Ind: 21206, 21256, 21456	Flywheel Ring Gear 132 Tooth, 15.49" ID, 16.69" OD,	AM326759R1	\$ 115.72	
4366, 4386, 5088, 5288, 5488	Flywheel Ring Gear 138 Tooth, 16.18" ID, 16.95" OD	AM1813752C1	\$ 139.85	
5088, 5288, 5488, 7488	Drive Plate 13 Spline, 13.87" OD Replaces 92590C1, 92590C2, 1251902C1, 1251902C2, 184429C1, 188013C91, 230233A1	AM184429C2	\$ 135.00	

International®—Tractor

Water Pumps

The remanufactured water pumps we supply have an extra step added to the remanufacturing process to ensure quality. Since the bearing and seal assembly are critical in performance, we ensure air-tight seals by vacuum testing our water pumps prior to packaging. This guarantees no leakage will occur after your water pump has been installed.



Application	Description	Part Number	Retail Price	Core
100, 130, 200, 230, 240, Super A, C, Super A1, Super C	Water Pump Engines - C113, C123	AM355760R93	\$ 65.00	
200, 230, 240, 330, 340, 404, 504, Ind: 2404, 2504, Crawler/Dozers: T4, T5, T340	Reman Water Pump w/ Hub Includes Backplate Gasket and Mounting Gasket Backplate Not Included	AM367683	\$ 95.00	\$ 40.00
(340, 460, 504, 560, 606, 656, 660, 666, 686, 706 - w/ Gas or Diesel), (756, 766, 806, 826, 856, Hydro 70, Hydro 86 - w/ Gas), Ind: (2504, 2606, 2656, 2706 - w/ Gas or Diesel), (2756, 2806, 2826, 2856 - w/ Gas)	Water Pump Gas Engines - C221, C263, C291, C301 Diesel Engines - D166, D188, D236, D282 Replaces 534270R91, 701128C94	AM601816C92	\$ 90.00	
354, B414, 434, 444	Water Pump	AM3119778R92	\$ 74.50	
400, 450, M, MD, MDV, MV, Super M, Super MTA, W6, WD6	Water Pump w/ Adjustable Pulley	AM353729R92	\$ 234.00	
414	Water Pump Engine - BD154 Diesel	AM703820R97	\$ 84.00	
(454, 464, 484, 574, 584, 674, 684, 784, Hydro 84 - w/ D179, D206, D239 or D246 Diesel Engine), 884, 885, 895, 995, 4210, 4230, 4240, Ind: 2500A	Water Pump w/ Hub Replaces 3132739R94	AM3136053R92	\$ 62.00	
454, 464, 544, 574, 674, Ind: 2400A, 2400B, 2405B, 2410B, 2500A, 2500B, 2544, 3414, 3514, Backhoe-Loaders: 3400A, 3500, 3500A, Forklifts: 4500A, 4500B - All w/ Gas	Water Pump	AM400677R92	\$ 122.50	
533, 633, 833	Water Pump	AM3132738R94	\$ 84.00	
656, 666, 686, Hydro 70, Hydro 86, Ind: 2656	Reman Water Pump Engine - C291	AM601816C92-6-R	\$ 100.00	\$ 25.00
656, Ind: 2656	Reman Water Pump Engine - D282	AM701128C94-R	\$ 95.00	\$ 25.00
666, 686, 766, 866, 966, 986, 1066, 1086, 1466, 1486, 1566, 1586, 3388, 3488, 3588, 3688, 3788, 4166, 4186, 4366, 4386, 5088, 5288, 5488, 6388, 6588, 6788, Hydro 70, Hydro 80, Hydro 100, Hydro 186	Water Pump	AM673162C94	\$ 110.00	
(666, 686, Hydro 70, Hydro 86 - w/ D312 Engine), (766, 886 - w/ D360 Engine), 966 w/ D414 Engine, (986, 3688, Hydro 100 - w/ D436 Engine), Combine: 815	Water Pump Includes Mounting Gasket Replaces 673623C92, 677415C93	AM673623C91	\$ 120.00	
686, 706, 756, 786, 826, 886, 3088, 3288, Hydro 70, Hydro 86, Ind: 2706, 2826 - All w/ D310 or D358 Engine	Water Pump w/ Hub	AM3132676R93	\$ 80.00	
806, 856, 1026, 1206, 1256, 1456, Ind: 2806, 2856, 21026, 21206, 21256, 21456	Water Pump w/ Hub Engines - D361, D407, DT361, DT407	AM701335C92	\$ 110.00	
H, HV, Super H, Super HV, W4	Water Pump Replaces 54148DA	AM54148	\$ 199.00	
Combines: 615 Late, 715 Late	Reman Water Pump Engine - C263	AM534270R91-R	\$ 97.00	\$ 25.00
Combines: 815, 915	Reman Water Pump Engine - D407	AM701335-COM	\$ 135.00	\$ 25.00
460, 560, 606, 656, 660, 666, 686, 706, 756, 766, 826, 856, Ind: 856, 2606, 2656, 2706, 2756 - All w/ Gas Engine	Water Pump Pulley 4 Mounting Holes Distance Between Mounting Holes: 1.937" Center-to-Center Use w/ AM601816C92 Water Pump	AM395815R2	\$ 47.50	
(340, 504 - w/ Diesel), (460, 560, 606, 660, 706, 806 - w/ Gas), Ind: 2504 w/ Diesel, Combine: 303, Cotton Pickers: 414, 420	Water Pump By-Pass Hose 0.926" Long, 0.59" ID, 6.41" OD	AM437575C3	\$ 9.98	

International®—Tractor

Belts

Application	Description	Part Number	Retail Price	Core
574 Gas	Fan Belt, Alt / Gen Belt	AM532031R2	\$ 11.84	
574 Diesel	Fan Belt	AM534311R1	\$ 23.00	
	Alt / Gen Belt	AM532031R2	\$ 11.84	
656 Farmall Gas	Fan Belt, Alt / Gen Belt, Water Pump	AM403617R1	\$ 12.25	
656 Farmall Diesel (Fan Belt - 49")	Fan Belt, Alt / Gen Belt, Water Pump	AM385738R1	\$ 11.19	
656 Farmall Diesel (Fan Belt - 49.50")	Fan Belt	AM385674R1	\$ 18.65	
	Alt / Gen Belt	AM385738R1	\$ 11.19	
656 International® Gas w/ Gear Drive Transmission	Fan Belt	AM396829R1	\$ 6.84	
	Alt / Gen Belt, Water Pump	AM403617R1	\$ 12.25	
656 Int. Gas Hydrostat Transmission	Fan Belt	AM403348R1	\$ 22.00	
656 International® Gas w/ Hydrostat Transmission	Alt / Gen Belt, Water Pump	AM403617R1	\$ 12.25	
656 International® Diesel w/ Gear Drive Transmission	Fan Belt	AM396830R1	\$ 11.80	
	Alt / Gen Belt, Water Pump	AM385738R1	\$ 11.19	
656 International® Diesel w/ Hydrostat Transmission	Fan Belt	AM378113R2	\$ 18.63	
	Alt / Gen Belt, Water Pump	AM385738R1	\$ 11.19	
674 Gas	Fan Belt, Alt / Gen Belt	AM532031R2	\$ 11.84	
674 Diesel	Fan Belt, Alt / Gen Belt, Water Pump	AM534311R1	\$ 23.00	
706 w/ D282 Engine Engine Diesel ASN 49664	Fan Belt	AM385674R1	\$ 18.65	
706 w/ D282 Diesel Engine ASN 49664	Alt / Gen Belt, Water Pump	AM385738R1	\$ 11.19	
706 Diesel BSN 49664 w/ D282 Engine	Fan Belt	AM378113R2	\$ 18.63	
706 w/ D282 Diesel Engine BSN 49664	Alt / Gen Belt, Water Pump	AM385738R1	\$ 11.19	
706 w/ D282 Diesel Engine BSN 5274	Fan Belt, Alt / Gen Belt, Water Pump	AM385674R1	\$ 18.65	
706 w/ D282 or D310 Diesel Engine ASN 5274	Fan Belt, Alt / Gen Belt, Water Pump	AM530076R1	\$ 19.44	
756 Gas	Fan Belt, Alt / Gen Belt, Water Pump	AM403617R1	\$ 12.25	
756 Diesel	Fan Belt, Alt / Gen Belt	AM530076R1	\$ 19.44	
766 Gas	Fan Belt, Alt / Gen Belt, Water Pump	AM403617R1	\$ 12.25	
	A/C Compressor Belt	AM65337C2	\$ 14.00	
766 Diesel	Fan Belt, Alt / Gen Belt	AM532746R2	\$ 21.00	
	A/C Compressor Belt	AM65337C2	\$ 14.00	
806 Gas	Fan Belt, Alt / Gen Belt, Water Pump	AM403617R1	\$ 12.25	
656 International® Gas w/ Hydrostat Transmission	Fan Belt, Alt / Gen Belt	AM403348R1	\$ 22.00	
806 Gas Only w/ Gen.	Water Pump Belt	AM403617R1	\$ 12.25	
806 Diesel - 66"	Fan Belt, Alt / Gen Belt	AM380060R1	\$ 16.35	
806 Diesel - 66.50"	Fan Belt, Alt / Gen Belt	AM385120R2	\$ 19.27	
826 Gas	Fan Belt	AM406097R1	\$ 12.34	
	Alt / Gen Belt, Water Pump	AM403617R1	\$ 12.25	
826 Diesel	Fan Belt, Alt / Gen Belt, Water Pump	AM530076R1	\$ 19.44	
856 Gas	Fan Belt, Alt / Gen Belt, Water Pump	AM403617R1	\$ 12.25	
856 Diesel	Fan Belt, Alt / Gen Belt, Water Pump	AM385120R2	\$ 19.27	
884 Diesel	Fan Belt, Alt / Gen Belt	AM3129140R1	\$ 21.00	
886 w/ 358 Diesel Engine w/ A/C	Fan Belt, Alt / Gen Belt	AM537072R92	\$ 20.00	
	Water Pump Belt	AM291019C2	\$ 17.40	
886 w/ 358 Diesel Engine w/o A/C	Fan Belt, Alt / Gen Belt	AM401191R1	\$ 18.00	
886 w/ 360 Diesel Engine	Fan Belt, Alt / Gen Belt	AM532746R2	\$ 21.00	
	A/ C Compressor Belt	AM291019C2	\$ 17.40	
966 Diesel	Fan Belt, Alt / Gen Belt	AM532746R2	\$ 21.00	
	A/C Compressor Belt	AM65337C2	\$ 14.00	

Prices Subject to Change without Prior Notice. The use of original equipment manufacturer (OEM) part numbers or trademarks, e.g. Case® and John Deere®, are for reference purposes only and for indicating product use and compatibility. Our company and the listed replacement parts contained herein are not sponsored, approved or manufactured by the OEM. All parts are New unless designated Reman in the description.

International®—Tractor

Application	Description	Part Number	Retail Price	Core
986 Diesel	Fan Belt, Alt / Gen Belt	AM532746R2	\$ 21.00	
986 Diesel w/ A/C	Fan Belt, Alt / Gen Belt	AM537072R92	\$ 20.00	
	Water Pump Belt	AM406097R1	\$ 12.34	
995, 996	Fan Belt, Alt / Gen Belt	AMK68073	\$ 9.35	
1026 Diesel	Fan Belt, Alt / Gen Belt, Water Pump	AM385120R2	\$ 19.27	
1066 Diesel	Fan Belt, Alt / Gen Belt	AM532746R2	\$ 21.00	
	A/C Compressor Belt	AM65337C2	\$ 14.00	
1086 Diesel	Fan Belt, Alt / Gen Belt	AM532746R2	\$ 21.00	
1086 Diesel w/ A/C	Fan Belt, Alt / Gen Belt	AM537072R92	\$ 20.00	
	Water Pump Belt	AM406097R1	\$ 12.34	
1205, 1256, 1456 Diesel	Fan Belt, Alt / Gen Belt, Water Pump	AM385120R2	\$ 19.27	
1466 Diesel	Fan Belt, Alt / Gen Belt	AM532746R2	\$ 21.00	
	A/C Compressor Belt	AM65337C2	\$ 14.00	
1468 Diesel	Fan Belt	AM427205C91	\$ 37.00	
	Alt / Gen Belt, Water Pump	AM236161R2	\$ 17.00	
	A/C Compressor Belt	AM527621R1	\$ 12.00	
1486 Diesel	Fan Belt, Alt / Gen Belt	AM532746R2	\$ 21.00	
1486 Diesel w/ AC	Fan Belt, Alt / Gen Belt	AM537072R92	\$ 20.00	
1486 Diesel w/ A/C	Water Pump Belt	AM874097C1	\$ 11.25	
1566 Diesel w/ A/C	Fan Belt, Alt / Gen Belt	AM537072R92	\$ 20.00	
	Water Pump Belt	AM65337C2	\$ 14.00	
1568 Diesel	Fan Belt	AM427205C91	\$ 37.00	
	Alt / Gen Belt , Water Pump	AM236161R2	\$ 17.00	
	A/C Compressor Belt	AM527621R1	\$ 12.00	
1586 Diesel	Fan Belt, Alt / Gen Belt	AM532746R2	\$ 21.00	
1586 Diesel w/ A/C	Fan Belt, Alt / Gen Belt	AM537072R92	\$ 20.00	
	Water Pump Belt	AM874097C1	\$ 11.25	
3088, 3288 Diesel	Fan Belt, Alt / Gen Belt, Water Pump	AM80130C1	\$ 16.18	
	A/C Compressor Belt	AM280210C2	\$ 11.20	
3488 Diesel	Fan Belt, Alt / Gen Belt, Water Pump	AM537072R92	\$ 20.00	
	A/C Compressor Belt	AM1250587C1	\$ 11.40	
3388, 3588, 3788 Diesel w/ A/C	Fan Belt, Alt / Gen Belt	AM537072R92	\$ 20.00	
3388, 3588, 3788 Diesel - w/ A/C	Water Pump Belt	AM874097C1	\$ 11.25	
3588, 3788 Diesel	Fan Belt, Alt / Gen Belt	AM532746R2	\$ 21.00	
3688, 5088, 5288, 5488 Diesel	Fan Belt, Alt / Gen Belt, Water Pump	AM131201C92	\$ 42.90	
4366, 4386 Diesel ASN 1501	Fan Belt, Alt / Gen Belt, Water Pump	AM131201C92	\$ 42.90	
	A/C Compressor Belt	AM65337C2	\$ 14.00	

Carburetors

Application	Description	Part Number	Retail Price	Core
130, 140, 200, 230, 240, 330, 340, 404, A, B, C Super A	Carburetor, Zenith	AMX82002	\$ 508.00	
240, 330, 340, 404, Ind: 2404 - All w/ C135 4 Cylinder Engine	Reman Carburetor	AM367700R93	\$ 195.00	\$ 100.00
300	Reman Carburetor	AM361525R92	\$ 195.00	\$ 100.00
314, B414	Reman Carburetor	AM3063945R91	\$ 325.00	\$ 100.00
400, 450	Reman Carburetor	AM362173R92	\$ 195.00	\$ 100.00
424, 444	Carburetor, Zenith	AMX82003	\$ 456.00	
454, 464, 504, 544, 574, 656, 666, 674, 686, Hydro 70, Hydro 86	Carburetor	AMX82007	\$ 550.00	
460	Reman Carburetor	AM367258R92	\$ 195.00	\$ 100.00
560	Reman Carburetor	AM367259R92	\$ 195.00	\$ 100.00
656	Reman Carburetor	AM396966R91	\$ 195.00	\$ 100.00

International®—Tractor

Application	Description	Part Number	Retail Price	Core
656	Reman Carburetor	AM388296R91	\$ 195.00	\$ 100.00
706	Reman Carburetor	AM388424R92	\$ 195.00	\$ 100.00
A, Super A, A1, A-1, Super A-1, AV, Super AV, Super AV-1, B, BN	Carburetor, Zenith	AM385608R91	\$ 219.50	
C Farmall	Reman Carburetor	AM375595R91	\$ 195.00	\$ 100.00
Cub BSN 312389	Reman Carburetor	AM71523C92	\$ 200.00	\$ 100.00
H	Reman Carburetor	AM50981DC	\$ 225.00	\$ 100.00
M	Reman Carburetor	AM50983DB	\$ 195.00	\$ 100.00

Fuel Lift Pumps

Application	Description	Part Number	Retail Price	Core
B414, 434, 444, 354 - w/ BD144 or BD154 Engine	Fuel Lift Pump	AM708294R93	\$ 20.00	
656 Row Crop, 666, 686, 706, 756, 766, 806, 826, 856, 966, 1026, 1066, 1206, 1256, 1456, 1466, 1468, 1566, 1568, Hydro 70, Hydro 86, Hydro 100, Ind: (2706, 2756, 2806, 2826, 21026, 21206, 21256, 21456 - Gas)	Fuel Sending Unit Operates from 32 to 244 ohms Works w/ negative or positive ground Includes Mounting Gasket	AM378427R91	\$ 53.00	

Injection Pumps

All of our injection pumps are disassembled, thoroughly cleaned and inspected. All worn out parts are replaced and the pumps are reassembled with new gaskets. Pumps are tested for leaks and fuel delivery at low idle, high idle, full load, part load and at start up. Any pumps with an automatic advance system has the advance set. As an additional quality check, all pumps are tested with a special oil that will not varnish inside the pump.



Application	Description	Part Number	Retail Price	Core
70 w/ Hydro Transmission	Reman Injection Pump Bosch, Mfg # - 100-6A-100A9238-5	AMPH70-B100	\$ 1095.00	\$ 350.00
100 w/ Hydro Transmission	Reman Injection Pump Bosch, Mfg # - 100-6A-100A9233-3, 9274-1	AMPH100-B100	\$ 1095.00	\$ 350.00
186 w/ Hydro Transmission	Reman Injection Pump Bosch, Mfg # - 100-6A-100A9298-3	AMPH186-B100	\$ 1095.00	\$ 350.00
560	Reman Injection Pump Roosa Master, Mfg # - DBGFC631-AF, 26AE, 49AE, 101AE	AMP560-DBGFC	\$ 975.00	\$ 300.00
584	Reman Injection Pump Bosch, Mfg # - EPVA4/70H1150CR81/3	AMP584-EPVA	\$ 1750.00	\$ 200.00
656 w/ Standard Transmission	Reman Injection Pump Roosa Master, Mfg # - DBGFC631-93AE, 100AE, 126AE, 26AJ, 45AJ	AMP656-DBG631	\$ 975.00	\$ 300.00
656 Hydro	Reman Injection Pump Roosa Master, Mfg # - DBGFC631-33AJ, 48AJ	AMP656-DBG633	\$ 975.00	\$ 300.00
666, 686 w/ Gear Drive Transmission	Reman Injection Pump Bosch, Mfg # - 100-6A-100A9238-4, 9278-1	AMP666-B100	\$ 1095.00	\$ 350.00
666, 686 w/ Hydro Transmission	Reman Injection Pump Bosch, Mfg # - 100-6A 100A9265-1, 9278-2	AMP686-B100	\$ 1095.00	\$ 350.00
706	Reman Injection Pump Roosa Master, Mfg # - DBGFC631-20AJ, 40AJ	AMP706-DBGFC	\$ 975.00	\$ 300.00
706, 756	Reman Injection Pump Bosch, Mfg # - EPVA6/10H1150CR21/5	AMP706-EPVA	\$ 1750.00	\$ 200.00
766 w/ Hydro Transmission	Reman Injection Pump Bosch, Mfg # - 100-6A-100A9238-6, 9255-6, 9256-2, 9275-1	AMP766-B100	\$ 1095.00	\$ 350.00
806	Reman Injection Pump Roosa Master, Mfg # - DBGFC637-53AJ, 8GS, 6GS, 3DH, 8DH, 11KC	AMP806-DBGFC	\$ 1250.00	\$ 300.00
826	Reman Injection Pump Bosch, Mfg # - EPVA6/10H1150CR21/5	AMP826-EPVA	\$ 1350.00	\$ 200.00
856	Reman Injection Pump Roosa Master, Mfg # - DBGFC637-5DH, 9DH, 1GS, 2KC, 1JW	AMP856-DBGFC	\$ 1250.00	\$ 300.00
886	Reman Injection Pump Bosch, Mfg # - 100-6A-100A9298-1	AMP886-B100	\$ 1095.00	\$ 350.00

International®—Tractor

Application	Description	Part Number	Retail Price	Core
966	Reman Injection Pump Bosch, Mfg # - 100-6A-100A9231-1, 9238-1, 9238-2, 9256-1, 9275-2	AMP966-B100	\$ 1095.00	\$ 350.00
986	Reman Injection Pump Bosch, Mfg # - 100-6A-100A9298-2	AMP986-B100	\$ 1095.00	\$ 350.00
1026	Reman Injection Pump Roosa Master, Mfg # - DBGFC637-11GS, 2JW, 2KC	AMP1026-DBGFC	\$ 975.00	\$ 300.00
1066	Reman Injection Pump Bosch, Mfg # - 100-6A-100A9233-1, 9233-2, 9257-1, 9274-6, 9275-3	AMP1066-B100	\$ 1095.00	\$ 350.00
1086	Reman Injection Pump Bosch, Mfg # - 100-6A-100A9274-11, 9274-13	AMP1086-B100	\$ 1095.00	\$ 350.00
1206	Reman Injection Pump Roosa Master, Mfg # - DBGFC637-52AJ, 2DH, 7DH, 5GS, 7GD, 10KC	AMP1206-DBGFC	\$ 975.00	\$ 300.00
1256	Reman Injection Pump Roosa Master, Mfg # - DBGFC637-6DH, 10DH, 2GS, 3JW, 12KC	AMP1256-DBGFC	\$ 975.00	\$ 300.00
1420	Reman Injection Pump Roosa Master, Mfg # - VE6/12F1350R64	AMP1420-EPVE	\$ 1250.00	\$ 200.00
1440 w/ 436 Engine BSN 66056	Reman Injection Pump Bosch, Mfg # - 100-6A-100A-9407-7	AMP1440-B100-7	\$ 1095.00	\$ 350.00
1440 w/ 436 Engine	Reman Injection Pump Bosch, Mfg # - 100-6A-100A-9554-28, 9558-7	AMP1440-B100-28	\$ 1095.00	\$ 350.00
1440 w/ 436 Engine	Reman Injection Pump Bosch, Mfg # - 100-6A-100A-9558-9, 9566-1	AMP1440-B100-9	\$ 1095.00	\$ 350.00
1456	Reman Injection Pump Roosa Master, Mfg # - DCGFC627-1JS, 4JN	AMP1456-DCGFC	\$ 1050.00	\$ 300.00
1460 w/ 436 Engine	Reman Injection Pump Bosch, Mfg # - 100-6A-100A-9281-13	AMP1460-B100-13	\$ 1095.00	\$ 350.00
1460 w/ 436 Engine	Reman Injection Pump Bosch, Mfg # - 100-6A-100A-9281-17, 9281-20, 9554-20	AMP1460-B100-17	\$ 1095.00	\$ 350.00
1460 w/ 466 Engine	Reman Injection Pump Bosch, Mfg # - 100-6A-100A-9554-26 For use on 180 HP engines	AMP1460-B100-26	\$ 1095.00	\$ 350.00
1460 w/ 466 Engine	Reman Injection Pump Bosch, Mfg # - 100-6A-100A-9554-27 For use on 190 HP engines	AMP1460-B100-27	\$ 1095.00	\$ 350.00
1466	Reman Injection Pump Bosch, Mfg # - 100-6A-100A9232-2, 9258-2, 9274-7, 9275-4	AMP1466-B100	\$ 1095.00	\$ 350.00
1480 w/ 436 Engine	Reman Injection Pump Bosch, Mfg # - 100-6A-100A-9281-14	AMP1480-B100-14	\$ 1095.00	\$ 350.00
1480 w/ 436B Engine	Reman Injection Pump Bosch, Mfg # - 100-6A-100A-9281-18	AMP1480-B100-18	\$ 1095.00	\$ 350.00
1480 w/ 466B Engine	Reman Injection Pump Bosch, Mfg # - 100-6A-100A-9281-19, 9281-24, 9281-25	AMP1480-B100-19	\$ 1095.00	\$ 350.00
1480 w/ 466 Engine	Reman Injection Pump Bosch, Mfg # - 100-6A-100A-9554-25	AMP1480-B100-25	\$ 1095.00	\$ 350.00
1486	Reman Injection Pump Bosch, Mfg # - 100-6A-100A9258-2, 9275-4, 9275-6, 9275-7	AMP1486-B100	\$ 1095.00	\$ 350.00
1566	Reman Injection Pump Bosch, Mfg # - 100-6A-100A9258-1, 9275-5	AMP1566-B100	\$ 1095.00	\$ 350.00
1568	Reman Injection Pump	AM465498C91	\$ 1350.00	\$ 350.00
1586	Reman Injection Pump Bosch, Mfg # - 100-61-100A9274-12, 9274-14	AMP1586-B100	\$ 1095.00	\$ 350.00
1640	Reman Injection Pump Bosch, Mfg # - 100-6A-100A-9577-1	AMP1640-B100	\$ 1095.00	\$ 350.00
1660	Reman Injection Pump Bosch, Mfg # - 100-6A-100A-9577-2	AMP1660-B100	\$ 1095.00	\$ 350.00
1660	Reman Injection Pump Bosch, Mfg # - PES64A 100D 3203 RS2691	AMP1660-PES	\$ 1425.00	\$ 200.00
1680	Reman Injection Pump Bosch, Mfg # - 100-6A-100A-9578-1	AMP1680-B100	\$ 1095.00	\$ 350.00

International®—Tractor

Application	Description	Part Number	Retail Price	Core
1680	Reman Injection Pump Bosch, Mfg # - PES6MW100/1200RS1137-2	AMP1680-PES	\$ 1650.00	\$ 200.00
3388	Reman Injection Pump Bosch, Mfg # - 100-6A-100A9274-21, 9274-23, 9550-32	AMP3388-B100	\$ 1095.00	\$ 350.00
3488	Reman Injection Pump Bosch, Mfg # - 100-6A-100A9550-26, 9565-26	AMP3488-B100	\$ 1095.00	\$ 350.00
3588	Reman Injection Pump Bosch, Mfg # - 100-6A-100A9274-17, 9274-20, 9274-22, 9550-31	AMP3588-B100	\$ 1095.00	\$ 350.00
3688	Reman Injection Pump Bosch, Mfg # - 100-6A-100A9550-27, 9565-27	AMP3688-B100	\$ 1095.00	\$ 350.00
3788	Reman Injection Pump Bosch, Mfg # - 100-6A-100A9274-19, 9550-30	AMP3788-B100	\$ 1095.00	\$ 350.00
3788, 5488	Reman Injection Pump Bosch, Mfg # - PES6MW100/320RS	AMP5488-PES	\$ 1850.00	\$ 200.00
3788, 5488	Reman Injection Pump Bosch, Mfg # - PES6W320RS1121	AMP3788-PES	\$ 1475.00	\$ 200.00
4166	Reman Injection Pump Bosch, Mfg # - 100-6A-100A9274-3, 9232-8	AMP4166-B100	\$ 1095.00	\$ 350.00
4186	Reman Injection Pump Bosch, Mfg # - 100-6A-100A9274-13	AMP4186-B100	\$ 1095.00	\$ 350.00
4366	Reman Injection Pump Bosch, Mfg # - 100-6A-100A9277-1, 9348-1	AMP4366-B100	\$ 1095.00	\$ 350.00
4386	Reman Injection Pump Bosch, Mfg # - 100-6A-1009400-1, 9410-1, 9410-2	AMP4386-B100	\$ 1095.00	\$ 350.00
5088	Reman Injection Pump Bosch, Mfg # - 100-6A-100A9550-28	AMP5088-B100	\$ 1095.00	\$ 350.00
5288	Reman Injection Pump Bosch, Mfg # - 100-6A-100A9550-29	AMP5288-B100	\$ 1095.00	\$ 350.00
5488	Reman Injection Pump Bosch, Mfg # - 100-6A-100A9551-2	AMP5488-B100	\$ 1095.00	\$ 350.00
385, 484 ASN 6307, 584 ASN 6936, 684 ASN 7232, 784 ASN 7112, 884 ASN 6620, Hydro 84 ASN 6001	Fuel Shutoff Cable 50.50" Long Replaces 3129712R1	AM3234947R2	\$ 42.43	
395, 495 - Diesel	Fuel Shutoff Cable 34 1/2" Long	AM1333000C1	\$ 36.29	
(454, 464 - Diesel), Ind: 2400 Diesel	Fuel Shutoff Cable 32" Long	AM529000R1	\$ 14.86	
454 BSN 101443, 474 w/ Bosch Pump, 574, 584 BSN 6936, 585 BSN 9270, 674, 684 BSN 7233, 685 BSN 10157, 784 BSN 7113, 785 BSN 12359, 884 BSN 6621, 885 BSN 1428, Hydro 84 BSN 6002, Ind: 2400A BSN 101442, 2500A	Fuel Shutoff Cable 38" Long	AM529001R1	\$ 17.74	
(544, 664 - Diesel), Ind: 2544 Diesel ASN 14272	Fuel Shutoff Cable 47 1/2" Long	AM530762R2	\$ 29.26	
595, 685 ASN 25893, 695, 885 ASN 26399, 895, 995	Fuel Shutoff Cable 38 1/2" Long	AM1333003C1	\$ 46.75	
595, 695, 895, 995	Fuel Shutoff Cable 53 3/4" Long Replaces 1965053C2, 1333179C1	AM1965053C2	\$ 39.71	
826 Diesel, Ind: 2826 Diesel	Fuel Shutoff Cable 67" Long	AM530332R1	\$ 35.78	

Prices Subject to Change without Prior Notice. The use of original equipment manufacturer (OEM) part numbers or trademarks, e.g. Case® and John Deere®, are for reference purposes only and for indicating product use and compatibility. Our company and the listed replacement parts contained herein are not sponsored, approved or manufactured by the OEM. All parts are New unless designated Reman in the description.

International®—Tractor

Application	Description	Part Number	Retail Price	Core
986, 1086, 1486, 1586, 3088, 3288, 3488, 3688, 5088, 5288, 5488, Hydro 186	Throttle Cable 72.50" Long Replaces 104079C1	AM1251797C2	\$ 75.74	
3388, 3588, 3788, 6388, 6588, 6788, 7288, 7488	Throttle Cable 132" Long	AM127338C2	\$ 98.18	

Injectors

Our remanufactured injectors are disassembled and thoroughly cleaned. The internal components are lapped to ensure there is no leakage. All tips are inspected for hole erosion and opening pressure; and the spray pattern is tested using OEM specifications.



Application	Description	Part Number	Retail Price	Core
(460, 560 Early)	Reman Injector Holder # - 279264R1 Valve # - ADE10S7C	NIH-ADE10S7C	\$ 105.00	\$ 75.00
(460, 560 Late), 656, 706	Reman Injector Holder # - 310389R1 Valve # - 332496 MICRO	NIH-332496	\$ 105.00	\$ 75.00
666, 766, Hydro 70	Reman Injector Holder # - AKN90M6425A Valve # - ADB 152M164-7	NAKN-A	\$ 45.00	\$ 20.00
706, 756 - German	Reman Injector Stud Mount Holder # - KBAL90S104/4 Valve # - DLL150S2641	NKBAL-150S2641	\$ 45.00	\$ 20.00
826 German	Reman Injector Stud Mount Holder # - KBAL90S81/4 Valve # - DLL150S417	NKBAL-150S417	\$ 45.00	\$ 20.00
1066, 1086 Early, 1466, 1486 Early	Injector Code B	AM631571C91	\$ 60.00	
1206 Early	Reman Injector Holder # - KBAL97SC1/13 Valve # - DLL145S320	NIH-145S320	\$ 105.00	\$ 75.00
806, 856 Early, 1206 Late	Reman Injector Holder # - KBAL97SC1/13 Valve # - DLL150S260	NKBAL-150S260	\$ 45.00	\$ 20.00
	Reman Injector w/ New Tip Holder # - KBAL97SC1/13 Valve # - DLL150S260	NKBAL-150S260RC	\$ 85.00	\$ 20.00
856 Late	Reman Injector Holder # - KBAL97SC1/13 Valve # - DLL150S532	NKBAL-150S532	\$ 45.00	\$ 20.00
886, 966, 986, Hydro 186	Reman Injector Holder # - AKN90M6425A Valve # - ADB152M206-7	NAKN-J	\$ 45.00	\$ 20.00
1026, 1256, 1456	Reman Injector Holder # - KBAL97SC1/13 Valve # - DLL145S416	NKBAL-145S416	\$ 45.00	\$ 20.00
(1086, 1486, 1586 Late)	Injector, Code P	AM749945C91	\$ 60.00	
	Reman Injector w/ New Tip Holder # - AKN90M6425A Valve # - ADB152M213-8	NAKN-PRC	\$ 85.00	\$ 35.00
666, 686, 766, 886, 966, 986, 1066, 1086, 1466, 1486, 1566, 3388, 3488, 3588, 3688, 3788, 4166, 4186, 4366, 4386, 4568, 4586, 4786, 5088, 5288, 5488, 6388, 6588, 6788, Hydro 70, Hydro 86, Hydro 100 - All w/ D312, D360, D414, DT414, D436, DT436, D466 and DT466 Engines	Injector Sleeve	AM675442C1	\$ 8.00	



Turbochargers

Application	Description	Part Number	Retail Price	Core
1026, 1256, 1456	Reman Turbocharger 3LD229, Schwitzer Replaces 702277C91, 749605C91	AM146718	\$ 690.00	\$ 200.00
1066, 1086, 1466, 1486, 1566, 1586, 3388, 3488, 4100, 4156, 4166, 4186, 4386 Engine BSN 77300, 5088, 5288, 5488, 6388	Turbocharger T04B18, AiResearch Replaces 675795C91, 684240C91, A184785	AM409570-16	\$ 365.00	
3588, 3688, 3788, 4386 Engine ASN 77300, 4366, 6588, 6788, 7288, 7488	Turbocharger T04B25, AiResearch Replaces A184781	AM409770	\$ 700.00	
1066, 1466, 1566, 4166, 4186, 4366, 4386 - w/ DT414, DT436 or DT466 Engine	Exhaust Sleeve	AM675317C2	\$ 44.00	
1086, 1486, 1586 - w/ DT414 or DT436 Engine	Exhaust Sleeve	AM107594C1	\$ 65.00	



Manifolds and Components

Application	Description	Part Number	Retail Price	Core
Cub	Intake and Exhaust Manifold	AM405023R2	\$ 90.00	
	Manifold Gasket Replaces 251333R2	AMX36246	\$ 5.00	
A, Super A, B, C, Super C	Intake and Exhaust Manifold	AM251175R21	\$ 138.00	
	Manifold Gasket Replaces 35201R4	AMX36247	\$ 6.50	
230, 400, 450, M, Super M, Super W6	Intake and Exhaust Manifold	AM358308R11	\$ 155.00	
300, 350, H, Super H, W4, Super W4	Intake and Exhaust Manifold	AM362536R21	\$ 145.00	
	Manifold Gasket Replaces 1342802C1	AMX36249	\$ 5.90	
504, 2504 - Gas	Intake and Exhaust Manifold	AM377179R11	\$ 186.00	
	Manifold Gasket Replaces 352014R4	AMX36250	\$ 16.00	
460, 560, 656, 706, 806 - Gas	Exhaust Manifold	AM384290R21	\$ 205.00	
454, 464, 574, 674, Ind: 2400A, 2400B, 2500A, 3514 Gas, Backhoe-Loaders: 3400A, 3500A	Intake and Exhaust Manifold	AM406046R1	\$ 170.00	
	Manifold Gasket Replaces 530682R1	AMX36209	\$ 31.00	
460, 560, 656, 666, 706, 756, 806, 826, 856, Ind: 2756, 2826, 2856 - All w/ Gas	Intake Manifold	AM393705R11	\$ 196.00	
1026, 1206, 1256, 1456	Exhaust Elbow	AM670034C1	\$ 125.00	
1026, 1256, 1456, 21256, 21456	Exhaust Manifold - Center Section	AM670813C91	\$ 157.00	
1066, 1466, 1566, 4166, 4186, 4366, 4386	Exhaust Elbow	AM675316C2	\$ 65.00	
1086, 1486, 1586 - w/ Non-Aspirated Muffler	Exhaust Elbow	AM103980C1	\$ 72.00	
1086, 1486, 1586 - w/ Aspirated Muffler	Exhaust Elbow	AM146494C1	\$ 133.00	
Engines: D414, D436, D466, DT414, DT436, DT466, DT466B, DT1466, DT1466B, DT1466C, Combines: 1640 BSN JJC0034705, 1660 BSN JJC0038346, 1680 BSN JJC0045689	Rear Manifold	AM675779C3	\$ 135.00	
1066, 1086, 1466, 1486, 1566, 1586, 3388, 4166, 4186, 6388	Front Manifold	AM683562C1	\$ 225.00	

International®—Tractor

Mufflers and Exhaust

Our mufflers are manufactured by experienced craftsmen here in the United States. All mufflers have welded seams. Aluminized steel is used for critical components. These features ensure that our products resist the corrosive effects of air, heat and the by-products of combustion that work to shorten muffler life. Additionally, they are painted either silver or black to cosmetically match its OEM counterpart, as well as provide further protection from the elements.

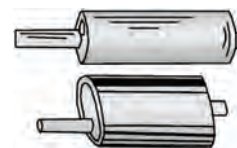

Application	Description	Part Number	Retail Price	Core
Universal Tractors	Exhaust Pipe Black Finish, Straight Pipe 4" ID, Overall Length 47.50"	AM400SP	\$ 59.00	
Universal Tractors	Exhaust Pipe Diameter 3.50", Length 48"	AMS312X48	\$ 57.00	
230, 300, 350, 400, 450, H, Super H, W4, Super W4, M, Super M, Super W6	Exhaust Pipe Inlet 2"	AM361384R1	\$ 15.00	
300 SN 9501-62482 w/ C-169 Gas Engine	Muffler Horizontal Round, Inlet 1 5/8", Length 24"	AM362483R91	\$ 34.00	
300, 350, 504	Muffler Horizontal Round, Inlet 1 5/8", Length 22 1/2"	AM365966R91	\$ 30.00	
(330, 340 - w/ C-135 Gas Engine), Farmall®: (100, 130, 140, 200, 230, 240, 330, 340 - w/ C-123 Gas Engine), (A, Super A, B, BN, C, Super C - 1939-54)	Muffler Round, Inlet 1 15/16", Length 29"	AM360720R91	\$ 28.00	
385, 484, 584, 684, 784, 884 - 1982 and Later w/ Diesel Engine	Muffler Vertical Oval, Inlet 2 5/16", Length 46 1/2"	AM83207C1	\$ 100.00	
424, 444, 504, Ind: 2424, 2444, 2504 - All w/ C135 Gas Engine	Muffler Vertical Round, Inlet ID 1 15/16", Length 27"	AM403825R1	\$ 27.00	
	Inlet Clamp	CL-200	\$ 4.00	
	Rain Cap	RC-2	\$ 13.00	
424, 2424 w/ B144 Gas Engine, B414	Muffler Horizontal Oval, Inlet 1 7/8", Length 38" Replaces 3047572R91, 3047572R92, 3047572R94	AM3047572R93	\$ 58.00	
454, 574, 674 - w/ C200 Gas or D239 Diesel Engine	Muffler Oval, Inlet 2 3/8", Length 30"	AM533924R1	\$ 60.00	
	Inlet Clamp	CL-212	\$ 7.00	
	Rain Cap	RC-2	\$ 13.00	
454, 460, 464, 544, 560, 574, 606, 656, 660, 674, 706	Exhaust Pipe Length 3 1/4"	AM366780R1	\$ 31.00	
460, 560, 606, 656, 660, 666, 686, 706, 756, 766, 806, 826, 856, Hydro 70, Hydro 86	Exhaust Pipe 2 15/16" OD	AM383974R2	\$ 35.00	
	544 w/ C200 Gas or D239 Diesel Engine	Muffler Round, Inlet 2 3/8", Length 29"	AM370644R92	\$ 30.00
	Inlet Clamp	CL-212	\$ 7.00	
	Rain Cap	RC-3	\$ 14.50	
	600, 650, T9, TD9, TD14, WD9	Muffler Vertical Round, Inlet 3 1/2", Length 22" Replaces 637661C1	AM264117R92	\$ 42.21
(666, 686, 706, 766, Hydro 70, Hydro 86 - w/ C263 or C291 Gas Engine), 706 (w/ D310 Diesel Engine), 806 (w/ C301 Gas or D361 Diesel Engine), 826 (w/ C301 Gas Engine), 856 (w/ 301 Gas or D407 Diesel Engine)	Muffler Vertical Oval, Inlet ID 2 15/16", Length 34"	AM530578R3	\$ 103.00	
	Inlet Clamp	CL-300	\$ 6.00	
	Rain Cap	RC-7	\$ 14.50	
706 w/ D310 Diesel Engine	Muffler Vertical Round, Inlet 2 3/8", Length 34"	AM384346R91	\$ 37.00	
	Inlet Clamp	CL-212	\$ 7.00	
	Rain Cap	RC-3	\$ 14.50	
706, 756 - w/ D310 Diesel Engine, 826 w/ D358 Diesel Engine	Muffler Vertical Oval, Inlet 2 15/16", Length 42"	AM530880R2	\$ 103.00	
	Inlet Clamp	CL-300	\$ 6.00	
	Rain Cap	RC-4	\$ 16.00	

International®—Tractor

Application	Description	Part Number	Retail Price	Core
(706, 756 w/ C291 Gas Engine), 856 w/ C301 Gas Engine	Muffler Vertical Round, Inlet ID 2 15/16", Length 34"	AM398511R1	\$ 50.00	
706 w/ C263 Gas Engine, 806 w/ C301 Gas or D361 Diesel Engine	Muffler Round, Inlet 2 15/16", Length 34"	AM384345R91	\$ 53.00	
	Inlet Clamp	CL-300	\$ 6.00	
	Rain Cap	RC-4	\$ 16.00	
766 w/ D361 Diesel Engine, 966 w/ D414 Diesel Engine, Hydro 100 w/ D436 Diesel Engine	Muffler Vertical Oval, Inlet 3 3/16", Length 50" Replaces 534545R4	AM534546R1	\$ 133.00	
	Clamp	CL-400	\$ 6.50	
	Rain Cap	RC-4	\$ 16.00	
886, 986, H186	Muffler Eliminator	AM131108C1	\$ 136.00	
(1026, 1256, 1456 - w/ DT407 Diesel Engine), 1206 w/ DT361 Diesel Engine	Muffler Oval, Inlet 3 3/4", Length 38"	AM530577R1	\$ 112.00	
	Clamp	CL-400	\$ 6.50	
	Rain Cap	RC-8	\$ 16.50	
1066 w/ DT414 Diesel Engine, 1466 w/ DT436 Diesel Engine	Muffler Oval, Inlet 3 3/4", Length 44"	AM534546R3	\$ 130.00	
	Inlet Clamp	CL-314	\$ 6.00	
	Rain Cap	RC-8	\$ 16.50	
1086, 1486, 1586 - w/ Non-Aspirated Muffler	Muffler Replaces 103978C1, 103978C2	AM103978C2	\$ 170.00	
	Muffler Eliminator Use w/ original stack, painted black	AM103978C1	\$ 145.00	
	Muffler Eliminator Use w/ original stack, painted black Replaces 146530C1	AM146530C1	\$ 210.00	
1086, 1486, 1586 - w/ Aspirated Muffler, 1981 and Later	Muffler Eliminator Use w/ original stack, painted black Replaces 146530C1	AM146530C1	\$ 210.00	
3488, 3688	Muffler Eliminator Use w/ original stack, painted black Replaces 130452C2	AMX39107	\$ 242.00	
5088, 5288, 5488	Muffler	AM144057C5	\$ 427.00	
	Muffler Eliminator	AM144057C4	\$ 269.00	
	Use w/ original stack, painted black			
B275, B414	Muffler Vertical Round, Inlet 2", Length 34" Replaces 707713R92, 751779R92, 3109792R92	AM3109793R91	\$ 26.50	
A, Super A, B, C, Super C	Exhaust Pipe Inlet 1 1/2"	AM356354R1	\$ 19.00	
B414	Muffler Vertical Round, Inlet 2", Length 41"	AM3046362R91	\$ 26.25	
Cub	Muffler Vertical Round, Inlet 1 3/8", Length 22"	AM351436R92	\$ 25.00	
Cub Lo-Boy	Muffler Horizontal Round, Inlet 1 3/8", Length 22"	AM361116R91	\$ 28.00	
(Farmall A, Super A, B, BN, C, Super C - 1939-54), (Farmall 100, 130, 140, 200, 230, 240 - w/ C123 Gas Engine), 330, 340 Farmall	Inlet Clamp	CL-200	\$ 4.00	
	Rain Cap	RC-2	\$ 13.00	
H, Super H, HV, Super HV, MD, MDV, Super M, Super MD, Super MDV, Super MTA, Super MV, Super W-4, W-400 Gas & Diesel, W-450 LPG & Diesel, W-6, WD-6, Super W-6 Gas & LPG, Super W-6 TA, Super WD-6, 340 Diesel, 300, 350, 400 Gas & Diesel, 450, 460, 560	Muffler Round, Inlet 2 3/8", Length 29"	AM350601R95	\$ 30.00	
	Inlet Clamp	CL-212	\$ 7.00	
	Rain Cap	RC-3	\$ 14.50	
H, Super H, W-4, 300, 350	Muffler Round, Inlet 2 3/8", Length 24"	AM350600R95	\$ 30.00	
	Inlet Clamp	CL-212	\$ 7.00	
	Rain Cap	RC-3	\$ 14.50	

Prices Subject to Change without Prior Notice. The use of original equipment manufacturer (OEM) part numbers or trademarks, e.g. Case® and John Deere®, are for reference purposes only and for indicating product use and compatibility. Our company and the listed replacement parts contained herein are not sponsored, approved or manufactured by the OEM. All parts are New unless designated Reman in the description.

International®—Tractor

Application	Description	Part Number	Retail Price	Core
Combines: 1460, 1480	Muffler Round, Inlet 3 3/4", Length 28"	AM131086C91	\$ 130.00	
	Clamp	CL-400	\$ 6.50	

Starters

All of our remanufactured starters are disassembled, cleaned and inspected. Almost all units receive new field coils. If it meets OEM specifications the armature is test turned and under cut, otherwise it is replaced with a quality factory remanufactured or new part. Starters with factory solenoids have the solenoids replaced with new parts. The drive is carefully inspected and if it does not meet specifications it is replaced with new or quality factory remanufactured drives.



Application	Description	Part Number	Retail Price	Core
385, 395, (454, 464, 574, 674 - Diesel), 484, 485, 495, 584, 585, 595, 684, 685, 695, 784, 884, 895, 995, 3220, 3230, 4210, 4230, 4240	Starter Lucas, Mfg # - 27508, Direct Drive, 10 Tooth, 2.80kW, 3-Ear Mount	AM189330A5	\$ 176.50	
454, 474, 574, Ind: 2400A, 2500A - All w/ Diesel Engine and Hydrostat Transmission	Starter, 12 Volt HD Planetary Gear Reduction, 10 Tooth Steel Pinions, Steel Ring Gear, 4kW, CW Rotation For Diesel Engines Replaces 1113391, 1113672	AMX34112	\$ 285.00	
	Solenoid Use w/ AMX34112 Starter	AMX34113	\$ 60.00	
686 Diesel	Reman Starter, 12 Volt Delco 20MT	AM1109252	\$ 415.46	\$ 50.00
766, 786, 856, 886, 966, 1066, 1086, 1466, 1468, 1566, 1568, 1586, 2856, 3088, 3288, 3588, 3688, 3788, 4166, 6388, 6588, 6788	Starter, 12 Volt HD Planetary Gear Reduction, 10 Tooth Steel Pinions, Steel Ring Gear, CCW Rotation	AMX34111	\$ 425.00	
4568, 4586, 4786	Reman Starter, 12 Volt Delco 40MT	AM1114074	\$ 374.00	\$ 100.00
H, HV, M, Super M, MV	Starter, 6 Volt Delco Style # - 1107448, 10 Tooth, CCW Rotation, w/ Post Start, 2-Bolt Mount	AM104219A2	\$ 157.50	
Super H, Super HV, M, Super M, MV	Starter, 6 Volt Delco, w/ Push Button, 3-Bolt Mount	AM1108012	\$ 180.50	
140 ASN 45001, 248 ASN 000816, 258 ASN 000808, 278 ASN 000801, 385, 484 ASN 006501, 485 ASN 007100, 544, 584 ASN 006953, 585 ASN 009312, 656, 664, 666, (684, Hydro 84 ASN 007253), 685 ASN 010178, 686, 706, 756, 766, 784 ASN 000716, 785 ASN 012442, 786, 806, 826, 856, 884 ASN 006643, 885 ASN 002001, 886, 966, 986, 1026, 1066, 1086, 1206, 1256, 1456, 1466, 1468, 1486, 1566, 1568, 1586, 2400, 3088, 3288, 3388, 3488, 3588, 3688, 3788, 4100, 4156, 4166, 5088 BSN 006243, 5288 BSN 004210, 5488 ASN 002425, 6388, 6588, 6788, Cub ASN 239827, Cub 154, Cub 185 Lo-Boy, Hydro 70, Hydro 86, Hydro 100, Hydro 186, Ind: 2544, 2656, 2706, 2756, 2806, 2826, 21026, 21206, 21256, 21456, Backhoe-Loader: 260A, Cotton Pickers: 616, 622	Neutral Starting Switch Replaces 121629C3, 83954C91, AH98872	AMX34147	\$ 30.00	

Distributors



Application	Description	Part Number	Retail Price	Core
100, 130, 140, 200, 300, 350, 400, 450, 504, A, B, C, Cub, H, M	Distributor Assembly For original replacement or Magneto to Distributor change over	AM353892R91	\$ 198.50	
460, 560, 606, 706, 806, Ind: 2606, 2706, 2806	Distributor Cap Replaces 356189R92	AM368062R91	\$ 17.95	

International®—Tractor

Air Cleaner Components

Application	Description	Part Number	Retail Price	Core
400, 450, 460, 504, 560, 606, 660, M, Ind/Const: 2504, 2544, 2606 Replaces 365413R1	Small Precleaner Bowl 7" Diameter	AMP02-0227	\$ 10.00	
1026, 1206, 1256, 1456, Ind/Const: 21026, 21256, 21456 Replaces 277377R1, 3031564R1	Large Precleaner Bowl 10.50" Diameter	AMP01-6330	\$ 12.00	
454 ASN 6683, 544 Hydro, 574 ASN 4540, Ind: 2400 ASN 6683, 2500 ASN 4540, 2544 Hydro - All Gas	Air Cleaner Hose, Inlet 2.25" & 2.50" ID	AM382400R1	\$ 14.55	
(606, 674 - Gas), Ind: 2606 Diesel	Air Cleaner Hose, Inlet 2.25" & 2.50" ID	AM382400R1	\$ 14.55	
656, 706, 756, 766, 806, 826, 856, Ind: 2706, 2756, 2806, 2826, 2856 - All w/ Gas Engine with 2 1/2" Outside Diameter Air Cleaner Pipe	Air Cleaner Hose, Lower 2.25" & 2.50" ID	AM382400R1	\$ 14.55	

Tachometers

Application	Description	Part Number	Retail Price	Core
258, 268, 584, 585, 684, 685, 784, 884, 885, 895, Hydro 84	Tachometer Replaces 3121926R91	AM3125106R92	\$ 51.50	
560 Gas or Diesel	Tachometer Replaces 383093R91	AM84212507	\$ 42.50	
706, 806, 1206, Ind: 2706, 2806, 21206	Tachometer Replaces 388588R91	AM84212504	\$ 39.50	
330, 340, 404, 424, 444, 504 Gas	Tachometer Cable 47.50" Long	AM150938R91	\$ 32.57	
330, 340, 460, 504, 544, 606, 656, Ind: 2504, 2544 Gas, 2656 Check length before ordering, Cable is used for different applications on different models	Tachometer Cable 44" Long Replaces 397016R91	AM397016R92	\$ 46.52	
330, 340, 460, 560, 660, 886, 986, 1086, 1468, 1486, 3688	Tachometer Cable 63" Long	AM401830R92	\$ 30.00	
385 SN 5001-5287 & ASN 18000 w/o Cab, (454, 464 - Diesel), 485, Ind: 2400A Diesel	Tachometer Cable 51.25" Long	AMA39404	\$ 34.14	
424, 444, Ind: 2424, 2444	Tachometer Cable 37" Long	AM388524R91	\$ 45.96	
454, 464, 574, 674, Ind: 2400A, 2500A - All Gas	Tachometer Cable 38" Long	AM529795R92	\$ 45.80	
666 w/ D310 Engine, 766, 806, 856, 1026, 1206, 1256, 1456, 3088, 3288, 4166, 4186, 4366 - w/ Diesel	Tachometer Cable Nylon Sheath, 80" Long Replaces 89159R91, 341210C91, 84845R92, 385082C91, 387916R91, 393328R91, 393328R92	AM393328R93	\$ 28.00	
666, 686, Hydro 70, Hydro 84 - w/ D312 Engine	Tachometer Cable 76" Long	AM65325C93	\$ 45.00	
544, 656, Ind: 2544 Hydro, 2656	Speedometer Cable 42" Long	AM400727R91	\$ 34.21	
(766, 826, 966 - Hydro), 1026, Hydro 100, Hydro 1066 Check length before ordering, Cable is used for different applications on different models	Speedometer Cable 44" Long Replaces 397016R91	AM397016R92	\$ 46.52	
3488, Hydro 186	Hydro Control Cable 48.25" Long	AM104311C1	\$ 62.64	



Alternators

Application	Description	Part Number	Retail Price	Core
766, 786, 966, 986, 1066, 1086, 1466, 1468, 1486, 1566, 1586, (3388, 3588, 3788, 6388, 6588, 6788 - w/ A/C, w/o Auxiliary Lighting Attachment), 4166, 4186, 4366, 4386	Alternator Pulley, Double Groove Cast Iron, 4.38" (111 mm) OD, 0.67" (17 mm) Bore For Delco 10SI Type 116 Series IR/EF Alternators Replaces 537070R1	AM24-1106	\$ 30.00	





Prices Subject to Change without Prior Notice. The use of original equipment manufacturer (OEM) part numbers or trademarks, e.g. Case® and John Deere®, are for reference purposes only and for indicating product use and compatibility. Our company and the listed replacement parts contained herein are not sponsored, approved or manufactured by the OEM. All parts are New unless designated Reman in the description.



Wide Front Ends



Application	Description	Part Number	Retail Price	Core
806 - 56 Wide Front	Reman Wide Front End	WF806	\$ 1750.00	\$ 100.00
86 Series Wide Front, Early	Reman Wide Front End	WF86E	\$ 1750.00	\$ 200.00
86 Series Wide Front, Late	Reman Wide Front End 2-Piece, Upper Bolster Only	WF86L	\$ 1750.00	\$ 200.00

Front Axle Repair Kits

Application	Description	Part Number	Retail Price	Core
 766, 966, 1066, 1466, 1468 - w/ Block Style Steering Cylinder End	Minor Repair Kit Kit Includes: (1) Each of - Block Style Cylinder End, Tapered Pin, Ball, Center Arm and Front Pivot Pins (2) Each of - Thrust Bearings, Inner and Outer Tie Rods, Trunnions, Trunnion Cap Bolts, Front Pivot and Trunnion Bushings, Center Arm Bushings	AMX4710104	\$ 395.00	
 766, 966, 1066, 1466 - w/ Block Style Steering Cylinder End	Major Repair Kit Kit Includes All Minor Repair Kit Parts Plus: (2) Each of - Taper-Mate Spindles, Steering Arms, Nuts and Washers (4) of - Knee Bushings	AMX4710105	\$ 725.00	
 (766, 886, 966, 986, 1066, 1086, 1466, 1468, 1486, 1586, Hydro 186 - Late w/ Tie Rod Style Power Steering Cylinder End), (3088, 3288, 3488, 3688, 5088, 5288, 5488, 6388, 6588, 6788 - Early w/ Tie Rod Style Power Steering Cylinder End) Does Not Fit Models w/ Rear Pivot Pin	Minor Repair Kit Kit Includes: (1) Each of - Tie Rod Style Cylinder End, Ball, Center Arm and Front Pivot Pins (2) Each of - Thrust Bearings, Inner and Outer Tie Rods, Trunnions, Trunnion Cap Bolts, Front Pivot and Trunnion Bushings, Center Arm Bushings	AMX4710106	\$ 395.00	
 (766, 886, 966, 986, 1066, 1086, 1466, 1468, 1486, 1586, Hydro 186 - Late w/ Tie Rod Style Power Steering Cylinder End), (3088, 3288, 3488, 3688, 5088, 5288, 5488, 6388, 6588, 6788 - Early w/ Tie Rod Style Power Steering Cylinder End)	Major Repair Kit Kit Includes All Minor Repair Kit Parts Plus: (2) Each of - Taper-Mate Spindles, Steering Arms, Nuts and Washers (4) Knee Bushings	AMX4710107	\$ 725.00	





Mechanical Front Wheel Drive Parts

MFWD Hubs and Housings









Application	Description	Part Number	Retail Price	Core
 258, 584, 585 ASN 18001, 644, 684, 685, 744, 784, 785, 844, 884, 885 BSN 3083, Hydro 84 - w/ ZF Axle	Steering Knuckle, Right Hand	AM3230955R1	\$ 265.00	
 258, 584, 585 ASN 18001, 644, 684, 685, 744, 784, 785, 844, 884, 885 BSN 3083, Hydro 84 - w/ ZF Axle	Steering Knuckle, Left Hand	AM3230954R1	\$ 265.00	

International®—Tractor

Mechanical Front Wheel Drive Parts

	Application	Description	Part Number	Retail Price	Core
	258, 584, 585 ASN 18001, 644, 684, 685, 744, 784, 785, 844, 884, 885 BSN 3083, Hydro 84 - w/ APL1351 Front Axle	Trunnion	AM3216588R1	\$ 50.00	
	585, 644, 685, 743, 744, 745, 785, 844, 856, 885	Trunnion	AML35606	\$ 30.00	
	5088, 5288, 5488	Trunnion Cap	AM86505030	\$ 210.00	
	258, 584, 684, 685 BSN 18001, 784, 884, 885 BSN 18001, Hydro 84	Front Axle	AM1502272C1	\$ 200.00	
	706, 756, 806, 826, 856, 966, 986, 1026, 1066, 1086, 1206, 1256, 1456, 1466, 1486, Hydro 100, Hydro 186 - w/ Coleman MFWD Axle	Boot	AM389050R1	\$ 100.00	



MFWD Hub Components

	Application	Description	Part Number	Retail Price	Core
	(385, 485, 585 ASN 18001), 395, 495, 595	Planetary Pinion Gear	AM81455C1	\$ 200.00	
	584, 585, 644, 684, 685, 744, 784, 844, 884, Hydro 84, Ind: 258, 268	Planetary Pinion Gear 26 Tooth Replaces 3230261R1, L35588	AMZP1927562	\$ 157.70	
	956, 1056	Planetary Pinion Gear	AM81688C1	\$ 180.00	
	5088, 5288, 5488	Planetary Pinion Gear	AM1349038C1	\$ 115.00	
	385 SN 5001-5287 & ASN 18001, (485, 585 ASN 18001), 395, 495, 595	Planetary Pinion Shaft	AM81453C1	\$ 200.00	
	956, 1056	Planetary Pinion Shaft	AM81683C1	\$ 170.00	
	(385, 485, 585 ASN 18001), 395, 495, 595	Ring Gear	AM81452C1	\$ 575.00	
	5088, 5288, 5488	Ring Gear Replaces 86505064	AM1277250C1	\$ 545.00	
	5088, 5288, 5488	Sun Shaft Replaces 1961770C1, 86016137	AM250728A1	\$ 175.00	
	786, 886, 986, 1086, 1486, 1586, 3088, 3288, 3488, 3688, 5088, 5288, 5488, Hydro 186 - w/ All Wheel Drive	Needle Bearing	AM78831C1	\$ 0.65	

International®—Tractor







Mechanical Front Wheel
Drive Parts

MFWD Differentials and Components

Application	Description	Part Number	Retail Price	Core
 644, 744, 844	Axle Shaft, Short	AM3230276R1	\$ 225.00	
 644, 744, 844	Axle Shaft, Long	AM3230278R1	\$ 285.00	













Tie Rods and Components

Our line of agricultural tie rods meet the highest-quality standards without high prices. They are designed to meet or exceed OEM specifications.







Application	Description	Part Number	Retail Price	Core
 100, 130, 140, 200, 230, 240, 330, 340, 404, 424, 444, 454, 464, 484, 485, 504, 2424, Super A, A1, AV, AV1, C, Cub, Cub Lo-Boy	Tie Rod, Outer 3.062" Long, 0.687" Diameter Right Hand 18 Thread	AM356540R91	\$ 17.00	
100, 130, 140, Cub, Cub Lo-Boy, Super A, Super A-1, Super AV, Super AV-1	Tie Rod Tube 16.125" Long, 1" OD	AM360411R1	\$ 61.41	
 100, 130, 140, Super A, Super A-1, Super AV, Super AV-1	Tie Rod 14.81" Long, 0.624" OD	AM356544R11	\$ 95.37	
100, 130, 140, Super A, Super A-1, Super AV, Super AV-1	Tie Rod Tube 16.062" Long, 0.875" OD	AM356548R2	\$ 62.46	
248 ASN 1591, 258, 385, 395, 484, 485, 495, 584, 585, 595, 674, 684, 685, 695, 784, 884, 885, 895	Tie Rod Tube 16.187" Long, 7/8" ID 16 Internal Thread Replaces 3116408R1, 3116408R2	AM3116408R3	\$ 29.25	
350, 400, 450, 460, 504, 544, 560, 656, 706, 756, H, Super H, M, Super M, Super MTA	Tie Rod Assembly 18.75" Long	AM11411	\$ 136.60	
 384, 385, (454, 464, 485 - w/ Swept 44-72" and 48-80"), (495, 585, 595, 695 - Swept), 574, 674, 784, 884, 885, Ind: 2400A	Tie Rod 15" Long, 0.75" Diameter 7 Screw Holes	AM65079C91	\$ 30.00	
 384, 385, 464 BSN 104042 w/ Swept 44-72", 485 w/ Swept 48-80", (495, 595, 695 - w/ Swept), 574, 585, 674, 784, 884, 885, Ind: 2400A w/ Swept 56-76"	Tie Rod 13.75" Long, 0.75" Diameter 6 Screw Holes	AM65074C91	\$ 30.00	
 384, 385, 485 w/ 48-80" Swept-Back Axle, 495, 574, 585, 595, 674, 695 Swept-Back Axle, 784, 884, 885, Ind: 2400A w/ 56-76" Swept Axle	Tie Rod, Outer 16" Long, 0.75" Diameter, 7 notches, 9/16" Diameter Thread Size on Ball Joint End Used w/ 405836R1 Left Hand Steering Arm and 405837R1 Right Hand Steering Arm	AM65082C91	\$ 22.00	
 384, 495, 585, 595, 695	Tie Rod, Outer 15.75" Long, 0.812" Diameter 6 Screw Holes	AM3129380R2	\$ 24.00	
385, 454, 464, 484, 574, 584, (Ind: 2400, 2500 - w/ Swept-Back Axle)	Tie Rod Tube 16.44" Long, 1" OD Replaces 527659R1	AM527659R2	\$ 36.50	
385, 454 ASN 100005, 484, 574 ASN 100000, 584, 674, (684, 784, 884, Hydro 84 - w/ 52"-80" Tread), Ind: 2400A, 2500A ASN 100000 - All w/ Straight Adjustable Axle	Tie Rod Tube 16.19" Long, 1" OD	AM67529C1	\$ 40.00	

International®—Tractor

International®—Tractor



	Application	Description	Part Number	Retail Price	Core
	385, 454, 485, 574, 674, Ind: 2400A	Tie Rod, Inner 3.062" Long, 0.687" Diameter Right Hand 18 Thread	AM527658R91	\$ 23.00	
	385 Swept, 495, 684, 685, 695 Straight, 784, 884, 885	Tie Rod 3.75" Long, 0.875" Diameter Right Hand 16 Thread	AM3116407R3	\$ 18.00	
	385 Swept, 495, 684, 685, 695 Straight, 784, 884, 885	Tie Rod 15" Long, 0.812" Diameter	AM3116406R3	\$ 30.00	
	(454, 484 - w/ Swept Axle 48-80"), 464 w/ Swept Axle 48-80" ASN 104042	Tie Rod, Outer 16" Long, 0.75" Diameter, 7 notches, 1/2" Diameter Thread Size On Ball Joint End Used w/ 405833R1 Left Hand Steering Arm and 405834R1 Right Hand Steering Arm	AM65077C91	\$ 28.00	
	454, 484, 485, 495, 544, 574, 584, 585, 595, 595XL, 656, 684, 685, 685XL, 884, 885, 885XL, 895, 895XL, Hydro 84, Ind: 2400A, 2500A, 2544, 2656 - All w/ Non-Adjustable Axle	Tie Rod End 4.06" Long, 0.812" Diameter 16 UN Right Hand Thread	AM379327R91	\$ 25.00	
	454, 484, 485, 495, 544, 574, 584, 585, 595, 595XL, 656, 684, 685, 685XL, 884, 885, 885XL, 895, 895XL, Hydro 84, Ind: 2400A, 2500A, 2544, 2656 - All w/ Non-Adjustable Axle	Tie Rod End 4.06" Long, 0.812" Diameter 16 UN Left Hand Thread	AM379326R91	\$ 25.00	
	460, 544, 560, 656, 660, 666, 686, 706, 756, 766, 786, 806, 826, 856, 966, 986, 1026, 1066, 1086, 1206, 1256, 1456, 1466, 1486, 1566, 1568, 1586, 3088, 3288, 3488, 3688, (5088, 5288, 5488 - w/ Standard Axle), Hydro 70, Hydro 100, Hydro 186	Tie Rod Assembly Components: Tie Rod, Inner 1 Tie Rod, Outer 1 Tube 1 Clamp 1 Jam Nut 1	AM223313 AM384006R92 AM359984R93 AM383917R1 AM359986R1 AM374062R1	\$ 79.00 \$ 14.00 \$ 28.00 \$ 20.00 \$ 3.00 \$ 8.00	
	460, 544, 560, 660, 656, 666, 706, 756, 766, 786, 806, 826, 856, 886, 966, 986, 1026, 1066, 1086, 1206, 1256, 1456, 1466, 1486, 1566, 1568, 1586, Hydro 70, Hydro 100, Hydro 186	Tie Rod, Inner 3.75" Long, 1" Diameter Right Hand 16 Thread	AM384006R92	\$ 14.00	
	460, 544, 560, 660, 656, 666, 706, 756, 766, 786, 806, 826, 856, 886, 966, 986, 1026, 1066, 1086, 1206, 1256, 1456, 1466, 1486, 1566, 1568, 1586, Hydro 70, Hydro 100, Hydro 186	Tie Rod, Outer 15.75" Long, 0.92" Diameter, 6 Notches	AM359984R93	\$ 28.00	
	460, 544, 560, 660, 656, 666, 706, 756, 766, 786, 806, 826, 856, 886, 966, 986, 1026, 1066, 1086, 1206, 1256, 1456, 1466, 1486, 1566, 1568, 1586, Hydro 70, Hydro 100, Hydro 186	Tie Rod Tube 18" Long	AM383917R1	\$ 20.00	
	504, 544, 606, 656, 2504, 2544, 2606, 2656 - w/ HD Fixed Axle	Tie Rod 4" Long, 0.812" Diameter Right Hand 16 Thread	AM382570R92	\$ 53.36	
	544, 656, Ind: 2544, 2656	Tie Rod 3.75" Long 1.00"x16 UN Right Hand External Thread	AM379551R92	\$ 62.86	
	544, 656, Ind: 2544, 2656 - All w/ Fixed Tread Front Axle	Tie Rod Tube w/ End 16.625" Long, 1" Diameter	AM382569R92	\$ 131.99	
	585, 595, 684, 685	Tie Rod 14.125" Long, 0.812" Diameter, 6 Screw Holes Replaces 1332805C1	AM3125171R2	\$ 33.00	

International®—Tractor

	Application	Description	Part Number	Retail Price	Core
	706, 756, 806, 856	Tie Rod, Inner 3.75" Long, 1" Diameter Left Hand 16 Thread	AM384005R91	\$ 13.00	
	5088, 5288, 5488 - w/ MFWD	Tie Rod 5.375" Long, 1.125" Diameter 12 Right Hand Thread	AM1277451C1	\$ 35.00	
	5088, 5288, 5488 - w/ MFWD	Tie Rod 5.375" Long, 1.125" Diameter 12 Left Hand Thread	AM1277452C1	\$ 35.00	
	5088, 5288, 5488 - w/ High Capacity Axle	Tie Rod 4.10" Long, 1.125" Diameter 12 Right Hand Thread	AM1280658C1	\$ 26.00	
	5088, 5288, 5488 - w/ High Capacity Axle	Tie Rod 7 Holes, 15.275" Long, 1.185" Diameter	AM1280662C1	\$ 35.00	
	5088, 5288, 5488	Tie Rod Tube 17.06" Long	AM1280657C1	\$ 30.00	

Spindles

Spindles are forged from high grades of alloy steel, machined and assembled to exact specifications that meet or exceed OEM specifications.

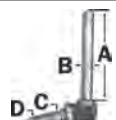
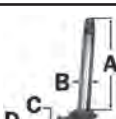
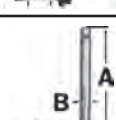
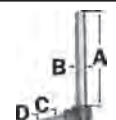



	Application	Description		Part Number	Retail Price	Core
	200, 230, 240, 404, 424, 444, 2404, 2424, 2444	Spindle A - 8.00 B - 1.42 C - 1.25 D - 0.75	Right or Left Hand Wheel Bearing Kit	AM371705R91 WBK-IH-1	\$ 362.09 \$ 30.00	
	200, 230, 240, 404, 425, 444, 2404, 2424 - w/ Hi-Clearance 20" and 45" to 69" Narrow Tread	Spindle A - 11.00 B - 1.42 C - 1.25 D - 0.75	Right or Left Hand Wheel Bearing Kit	AM373890R91 WBK-IH-1	\$ 288.98 \$ 30.00	
	248, 258, 385, 454, 484, 485, 574, 584, 585, 595, 695, 895, 995, 2400, 2500	Spindle A - 12.125 B - 1.667 C - 1.78 D - 1.375	Right or Left Hand Wheel Bearing Kit	AM67535C91 WBK-IH-9	\$ 213.99 \$ 36.00	
	Utility: 300, 350 Will Not Fit Farmall Models	Spindle A - 12.375 B - 1.667 C - 1.375 D - 0.937	Right or Left Hand Wheel Bearing Kit	AM361845R92 WBK-IH-4	\$ 336.62 \$ 72.00	
	400, 450, M Late, Super M, Super MTA	Spindle A - 14.562 B - 1.667 C - 1.688 D - 1.375	Right Hand Left Hand	AM360408R91 AM360407R91	\$ 278.21 \$ 281.14	
	454 BSN 5020 - w/ Swept-Back Axle	Spindle A - 11.687 B - 1.423 C - 1.25 D - 0.75	Right or Left Hand	AM405838R11	\$ 314.37	
	454 ASN 5020, 464, 484 - w/ Swept-Back Axle	Spindle A - 11.625 B - 1.423 C - 1.377 D - 0.865	Right or Left Hand	AM536061R2	\$ 274.74	

International®—Tractor

	Application	Description		Part Number	Retail Price	Core
	460, 544, 656	Spindle	Right Hand	AM383911R91	\$ 175.00	
		A - 12.375	Left Hand	AM383910R91	\$ 175.00	
		B - 1.667	Wheel Bearing Kit	WBK-IH-2	\$ 39.00	
		C - 1.375 D - 0.842				
	460, 544, 656	Spindle	Right or Left Hand	AM405427R92	\$ 165.00	
		A - 12.75	Wheel Bearing Kit	WBK-IH-2	\$ 39.00	
		B - 1.667				
		C - 1.375 D - .842				
	544, 656 - Row Crop ASN 13200	Spindle	Right or Left Hand	AM530338R92	\$ 155.00	
		A - 14.875	Wheel Bearing Kit	WBK-IH-3	\$ 26.00	
		B - 1.667				
		C - 1.78 D - 1.375				
	Utility: (544, 656 ASN 13200)	Spindle	Right or Left Hand	AM406267R92	\$ 165.00	
		A - 11.375	Thrust Bearing	AM185106C91	\$ 9.00	
		B - 1.667	Wheel Bearing Kit	WBK-IH-3	\$ 26.00	
		C - 1.78 D - 1.375				
	560, 656, 706, 756, 806, 826, 856, 1026, 1206, 1256	Spindle	Right Hand	AM383913R92	\$ 155.00	
		A - 12.375	Left Hand	AM383912R92	\$ 155.00	
		B - 1.667	Thrust Bearing	AM185106C91	\$ 9.00	
		C - 1.78 D - 1.375	Wheel Bearing Kit	WBK-IH-3	\$ 26.00	
	Utility: 574, 584, 585, 674, 2500A - w/ Row Crop Axle	Spindle	Right or Left Hand	AM527292R92	\$ 215.77	
		A - 15.25	Thrust Bearing	AM185106C91	\$ 9.00	
		B - 1.667	Wheel Bearing Kit	WBK-IH-6	\$ 50.00	
		C - 1.375 D - 0.842				
	Utility: 574, 584, 2500A - w/ Swept Back Axles	Spindle	Right or Left Hand	AM405840R11	\$ 195.00	
		A - 12.25	Thrust Bearing	AM185106C91	\$ 9.00	
		B - 1.667	Wheel Bearing Kit	WBK-IH-2	\$ 39.00	
		C - 1.375 D - 0.842				
	584, 585, 595, 684, 685, 695, 784, 785, 795, 884, 885, 895, Hydro 84	Spindle	Right or Left Hand	AM3121270R91	\$ 227.50	
		A - 8.312	Wheel Bearing Kit	WBK-IH-9	\$ 36.00	
		B - 1.667				
		C - 1.78 D - 1.375				
	585, 595, 684, 685, 695, 784, 785, 884, 995, Hydro 84	Spindle	Right or Left Hand	AM3121261R91	\$ 218.49	
		A - 11.25				
		B - 1.667				
		C - 1.78 D - 1.375				
	656 BSN 13200, Utility: 504, 544 BSN 13200	Spindle	Right or Left Hand	AM406265R92	\$ 165.00	
		A - 11.375	Wheel Bearing Kit	WBK-IH-2	\$ 39.00	
		B - 1.667				
		C - 1.375 D - 0.842				
	656, 666, 686, 756, 766, 786, 826, 856, 886, 966, 986, 1026, 1066, 1086, 1256, 1456, 1466, 1468, 1486, 1566, 1568, 1586, Hydro 70, Hydro 86, Hydro 100, Hydro 186	Spindle	Right or Left Hand	AM71785C92	\$ 170.00	
		24 Spline	Thrust Bearing	AM185106C91	\$ 9.00	
		A - 12.75	Wheel Bearing Kit	WBK-IH-3	\$ 26.00	
		B - 1.667 C - 1.78 D - 1.375				

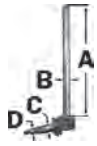
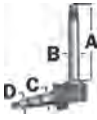
Prices Subject to Change without Prior Notice. The use of original equipment manufacturer (OEM) part numbers or trademarks, e.g. Case® and John Deere®, are for reference purposes only and for indicating product use and compatibility. Our company and the listed replacement parts contained herein are not sponsored, approved or manufactured by the OEM. All parts are New unless designated Reman in the description.

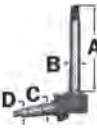
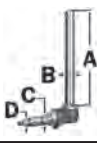
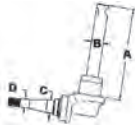
International®—Tractor



	Application	Description		Part Number	Retail Price	Core	
	656, 666, 686, 706, 756, 766, 786, 826, 856, 886, 966, 986, 1026, 1066, 1086, 1466, 1468, 1486, 3088, 3288, 3688, Hydro 70, Hydro 86, Hydro 100, Hydro 186	Spindle	Right Hand	AM384258R93	\$ 275.00		
		A - 24.25	Left Hand	AM384257R93	\$ 377.46		
		B - 1.667					
		C - 1.78					
		D - 1.375					
	684, 784, 884, Hydro 84 - w/ Straight Adjustable Low Profile Axle	Spindle	Right or Left Hand	AM3125872R91	\$ 388.73		
		A - 9.50					
		B - 1.667					
		C - 1.78					
		D - 1.375					
	656, 666, 686, 756, 766, 786, 826, 856, 886, 966, 986, 1026, 1066, 1086, 1256, 1456, 1466, 1468, 1486, 1566, 1568, 1586, 3088, 3288, 3488 Hydro, 3688, 5088, 5288, 5488, Hydro 70, Hydro 86, Hydro 100, Hydro 186	Tapermate Spindle Kit	Right or Left Hand	AM71785TMS	\$ 240.00		
		Includes: AM71785TM	Thrust Bearing	AM185106C91	\$ 9.00		
		Spindle, AM531248TM	Wheel Bearing Kit	WBK-IH-3	\$ 26.00		
		Steering Arm, Nut and Washer					
		A - 12.75					
		B - 1.667					
		C - 1.78					
		D - 1.375					
	656, 666, 686, 756, 766, 786, 826, 856, 886, 966, 986, 1026, 1066, 1086, 1256, 1456, 1466, 1468, 1486, 1566, 1568, 1586, 3088, 3288, 3488 Hydro, 3688, 5088, 5288, 5488, Hydro 70, Hydro 86, Hydro 100, Hydro 186	Tapermate Spindle	Right or Left Hand	AM71785TM	\$ 215.00		
		17 Spline	Thrust Bearing	AM185106C91	\$ 9.00		
		Includes Spindle, Nut, Ring and Washer	Wheel Bearing Kit	WBK-IH-3	\$ 26.00		
		A - 12.75					
		B - 1.667					
		C - 1.78					
		D - 1.375					
	674, 684, 884, Hydro 84 - w/ Straight Axles	Spindle	Right or Left Hand	AM67526C91	\$ 222.24		
		A - 15.25	Thrust Bearing	AM185106C91	\$ 9.00		
		B - 1.66	Wheel Bearing Kit	WBK-IH-9	\$ 36.00		
		C - 1.78					
		D - 1.375					
	Farmall M Early w/ OEM Wide Front Axle	Spindle	Right Hand	AM51700DE	\$ 311.78		
		Location of keyway must be known before ordering	Left Hand	AM51699DE	\$ 317.61		
		A - 10.625	Wheel Bearing Kit	WBK-IH-4	\$ 72.00		
		B - 1.356					
		C - 1.375					
		D - 0.937					
	5088, 5288, 5488 - w/ Adjustable High Capacity Front Axle	Spindle Bushing		AM1259518C1	\$ 36.23		
	230, 240, 300, 330, 340, 350, 400, 404, 450, 504, 544, 560, 606, 656, 660, 664, 666, 706, 756, 786, 806, 826, 856, 886, 966, 986, 1026, 1066, 1086, 1206, 1256, 1456, 1466, 1468, 1486, 1566, 1568, 1586, 2404, 2424, 2444, 2504, 2544, 3088, 3288, 3488, 3688, 5088, 5288, 5488, H70, H86, H100, H186, M, MD	Nut		AM427546	\$ 3.65		
		Fits all 1.667"					
		International® spindles					
		w/ a 1.375" threaded shaft					





Wheel Hubs and Components

Application	Description	Part Number	Retail Price	Core
248 ASN 1591, 258, 268, 454, 484, 485, 574, 584, 585, 595, 674, 684, 685, 695, 784, 785, 884, 885, 895, 995, 2400	Wheel Hub, 6-Bolt Includes Installed Studs Replaces 67527C92	AM67527C91	\$ 110.00	
385, 395, 454, 484, 485, 495, 574, 584, 585, 595, 595XL, 674, 685, 685XL, 695, 695XL, 885, 895, 995	Front Wheel Hub, 6-Bolt Use w/ WBK-IH-6 Wheel Bearing Kit Replaces 1708-4502	AM406294R21	\$ 138.07	
540, 544, 656, 666, 686, 706, 756, 766, 786, 806, 826, 856, 886, 966, 986, 1026, 1066, 1086, 1206, 1256, 1456, 1466, 1468, 1486, 1566, 1568, 1586, 3088, 3288, 3688, 5088, 5288, 5488, Hydro 70, Hydro 86, Hydro 100, Hydro 186, Ind: 2656, 2706, 2756, 2826, 2856, 21026	Wheel Hub, 6-Bolt	AM391823R11	\$ 59.00	
544, 560, 656, 666, 686, 706, 756, 766, 786, 806, 826, 856, 886, 966, 986, 1026, 1066, 1086, 1206, 1256, 1456, 1466, 1468, 1486, 1566, 1568, 1586, 2656, 2706, 2756, 2826, 2856, 3088, 3288, 3688, 5088, 5288, H70, H86, H100, H186	Wheel Hub, 8-Bolt	AM391824R11	\$ 90.00	

Wheel Bearing Kits

Application	Description	Part Number	Retail Price	Core
 200, 230, 240, 330, 340, 404, 424, 444, Ind: 2404, 2424, 2444, 2504	Wheel Bearing Kit	WBK-IH-1	\$ 30.00	
	Components:			
	Inner Cone	1 LM67048	\$ 7.00	
	Inner Cup	1 LM67010	\$ 2.75	
	Outer Cone	1 LM11949	\$ 2.99	
	Outer Cup	1 LM11910	\$ 1.70	
	Seal	1 AP19230	\$ 7.00	
	Sleeve	1 AP19260	\$ 6.00	
Gasket	1 IH1G	\$ 1.00		
 Farmall: 300, 330 Utility, 350, H, Super H, HV, Super HV, M, MD, MF, W4 Note: fits hubs used on International® OEM wide front assemblies only	Wheel Bearing Kit	WBK-IH-4	\$ 72.00	
	Components:			
	Inner Cone	1 14138A	\$ 7.00	
	Inner Cup	1 14274	\$ 5.50	
	Outer Cone	1 1779	\$ 11.50	
	Outer Cup	1 1729	\$ 6.00	
	Seal	1 AP19240	\$ 9.00	
	Seal	1 AP19245	\$ 15.50	
	Sleeve	1 AP19250	\$ 9.00	
	 300B, 385, 395, 454, 484, 485, 495, 574, 584, 585, 595, 674, 685, 695, 784, Ind: 2400A, 2500A	Wheel Bearing Kit	WBK-IH-6	\$ 50.00
Components:				
Inner Cone		1 LM48548	\$ 6.00	
Inner Cup		1 LM48510	\$ 4.00	
Outer Cup		1 M12610	\$ 2.00	
Seal		1 AP19265	\$ 15.00	
Sleeve		1 AP19235	\$ 7.00	
Outer Cone	1 M12649	\$ 4.50		

International®—Tractor

Application	Description	Part Number	Retail Price	Core
 460, 504, 544, 606, 656, 2606	Wheel Bearing Kit	WBK-IH-2	\$ 39.00	
	Components:			
	Inner Cone	1 LM48548	\$ 6.00	
	Inner Cup	1 LM48510	\$ 4.00	
	Outer Cone	1 M12649	\$ 4.50	
	Outer Cup	1 M12610	\$ 2.00	
	Seal	1 AP19245	\$ 15.50	
	Sleeve	1 AP19250	\$ 9.00	
	Gasket	1 IH2G	\$ 1.00	
 544, 560, 656, 666, 686, 706, 756, 766, 786, 806, 826, 856, 886, 966, 986, 1026, 1066, 1086, 1206, 1256, 1456, 1466, 1468, 1486, 1566, 1568, 1586, 3088, 3288, 3488 Hydro, 3688, 5088, 5288, 5488, Hydro 70, Hydro 86, Hydro 100, Hydro 186, Ind: 2656, 2706, 2756, 2826, 2856, 21026, Combines: 815, 915, Cotton Pickers: 782, 1822, 1844, 2022, 2044	Wheel Bearing Kit	WBK-IH-3	\$ 26.00	
	Components:			
	Inner Cone	1 LM603049	\$ 7.25	
	Inner Cup	1 LM603011	\$ 3.25	
	Outer Cone	1 LM48548	\$ 6.00	
	Outer Cup	1 LM48510	\$ 4.00	
	Seal	1 AP19225	\$ 8.50	
	Sleeve	1 AP19255	\$ 5.50	
	Gasket	1 IH2G	\$ 1.00	
 574, 584, 585, 595, 674, 684, 685, 695, 784, 884, 885, 895, Hydro 84	Wheel Bearing Kit	WBK-IH-9	\$ 36.00	
	Components:			
	Inner Cone	1 LM102949	\$ 9.00	
	Inner Cup	1 LM102910	\$ 5.00	
	Outer Cone	1 L68149	\$ 5.00	
	Outer Cup	1 L68111	\$ 3.00	
	Seal	1 AP19225	\$ 8.50	
	Sleeve	1 AP19270	\$ 5.00	

Steering Arms and Components



Application	Description	Part Number	Retail Price	Core
424, 444, 544, 504, 606	Steering Arm, Center	AM379553R11	\$ 203.66	
504, 544, 656	Steering Arm, Center	AM379555R11	\$ 171.27	
504, 544, 606, 656	Steering Arm 24 Spline, 4.25" Drop	Right Hand	AM379643R1	\$ 272.56
		Left Hand	AM379642R1	\$ 276.94
544, 560, 656, 666, 686, 706, 756, 806, 826, 856, 1026, 1206, 1256, Hydro 70	Steering Arm, Center	AM358970R1	\$ 100.00	
544, 656, 706, 756, 806, 826, 856, 1026, 1206, 1256, 1456	Steering Arm Keyed	AM383914R1	\$ 115.00	
656, 666, 686, 756, 766, 786, 826, 856, 886, 966, 986, 1026, 1066, 1086, 1256, 1456, 1466, 1468, 1486, 1566, 1568, 1586, 3088, 3288, 3488 Hydro, 3688, 5088, 5288, 5488, Hydro 70, Hydro 86, Hydro 100, Hydro 186	Steering Arm For Taper-Mate Spindles	Right or Left Hand	AM531248TM	\$ 80.00
706, 756, 806, 826, 856, 1026, 1206, 1256, 1456	Steering Arm 24 Spline, 2" Drop	Right Hand	AM384017R3	\$ 196.73
		Left Hand	AM384016R3	\$ 171.66

International®—Tractor

Application	Description	Part Number	Retail Price	Core
766, 786, 886, 966, 986, 1066, 1086, 1466, 1468, 1486, 1566, 1568, 1586, 1588, 3088, 3288, Hydro 100, Hydro 186	Steering Arm For OEM-Style Spindles	Right Hand AM531249R2 Left Hand AM531248R2	\$ 50.00 \$ 45.00	
	Steering Arm Spline is 0.03" undersized w/ snap ring groove below splines	Right Hand AM531249US Left Hand AM531248US	\$ 55.00 \$ 67.08	
	Steering Arm Spline is 0.03" undersized Fits spindles with square shoulder below splines	Right Hand AM531249US-86 Left Hand AM531248US-86	\$ 55.00 \$ 55.00	
	Steering Arm, Center Replaces 531235R11	AM71787C91	\$ 368.26	
5088, 5288, 5488	Steering Arm 36 Tooth	Right Hand AM1259527C2	\$ 102.11	
		Left Hand AM1259526C2	\$ 120.13	
	Steering Arm 24 Tooth	Right Hand AM148419C1	\$ 144.53	
		Left Hand AM148418C1	\$ 103.21	
766, 786, 886, 966, 986, 1066, 1086, 1466, 1468, 1566, 1568, 1586, 3088, 3288, 3488, 3688, 5088, 5288, 5488, Hydro 100, Hydro 186	Center Steering Arm Bushing	AM71788C1	\$ 8.00	
766, 786, 886, 966, 986, 1066, 1086, 1466, 1468, 1566, 1586, 3088, 3288, 3488, 3688, 5088, 5288, Hydro 100, Hydro 186	Center Arm Pivot Pin 7.44" Long	AM531239R1	\$ 40.00	
766, 966, 1066, 1468, 1566, 1568	Cylinder Pin, Tapered Includes Nut, Jam Nut and Washer	AM223314	\$ 64.72	
786, 886, 966, 986, 1066, 1086, 1466, 1486, 1566, 1586, 3088, 3288, 3488, 3688, 5088, 5288, 5488, Hydro 100, Hydro 186	Axle Pivot Bushing 2.006" ID, 2.125" OD, 1.49" Long	AM531242R1	\$ 10.00	
766, 786, 986, 1066, 1086, 1468, 1486, 1566, 1568, 1586, 3488, 3688, 5088	Bolt For Steering Arm Trunnion Cap 18 UNF Thread, 5/8" Diameter	AM531238R1	\$ 6.20	

Axle Center Tubes and Beams



Application	Description	Part Number	Retail Price	Core
460, 544, 560, 656, 660, 666, 686, 706, 756, 806, 826, 856, 1026, 1206, Hydro 70	Center Tube 4.50" Diameter, 42.50" Long	AM358976R31	\$ 435.00	
300, 350, 400, 450, 460, 544, 560, 656, 660, 706, 756, 806, 826, 856, 1026, 1206, 1256, H, Super H ASN 19234, HV, M, Super M ASN 60001, MD, MDV, MV, Ind: 2544, 2706, 2826, 2856, 21026, 21206, 21256 - All w/ Wide Tread Adjustable Front Axle	Stay Rod Assembly	AM360405R11	\$ 460.00	

Axle Knee Extensions



Application	Description	Part Number	Retail Price	Core
385, 395, 484, 485, 495, 574, 584, 585, 595, 695, 885, 895, 995, Ind: 2500A - All w/ Swept-Back Axle	Axle Knee Extension, Right Hand 9.50" Tall (from Top to Thrust Bearing) Includes Spindle Bushings, 1.68" ID Replaces 405713R12	AM66702C91	\$ 611.22	
454, 464, 484 - w/ Swept-Back Axle	Axle Knee Extension, Right Hand 9.25" Tall (from Top to Thrust Bearing) Includes Spindle Bushings, 1.451" ID Replaces 405708R12	AM66696C91	\$ 401.36	

International®—Tractor

Application	Description	Part Number	Retail Price	Core
454, 464, 484 - w/ Swept-Back Axle	Axle Knee Extension, Left Hand 9.25" Tall (from Top to Thrust Bearing) Includes Spindle Bushings, 1.451" ID Replaces 405707R12	AM66695C91	\$ 418.17	
504, 544, 606, 656, 664, Ind: 2504, 2544, 2606, 2656	Axle Knee Extension 3.25" Diameter	AM379641R91	\$ 411.43	
460, 544, 560, 660, 666, 686, 706, 806, 1206, 1256, Hydro 70	Knee w/ Bushings 3.875" Diameter	AM370689R21	\$ 235.00	
766, 786, 886, 966, 986, 1066, 1086, 1466, 1468, 1486, 1566, 1586, 3088, 3288, 3488 Hydro, 5088, 5188, 5288, Hydro 100, Hydro 186	Knee w/ Bushings 4.375" Diameter	AM531260R92	\$ 270.00	
460, 544, 560, 660, 666, 686, 706, 766, 786, 806, 886, 966, 986, 1066, 1086, 1206, 1256, 1466, 1468, 1486, 1566, 1586, 3088, 3288, 5088, 5188, 5288, Hydro 70, Hydro 100, Hydro 186, Hydro 3488	Knee Bushing (2) Required per Knee Used in AM370689R21 and AM531260R92 Knee Extensions	AM358958R2	\$ 10.00	



Ball and Socket Parts

Application	Description	Part Number	Retail Price	Core
786, 886, 986, 1086, 1486, 1586, 3088, 3288, 3488, 3688, 3688HC, 5088, 5288, 5488, Hydro 186	Pivot Pin, Rear 3.54" Long, 1.248" Diameter Replaces 120732C1	AM120732C1	\$ 54.90	
544, 560, 656, 666, 686, 706, 756, 806, 826, 856, 1206, 1256, 1456, Hydro 70	Upper Socket Cap 3" Center-to-Center Hole Spacing	AM535861R1	\$ 25.00	
	Lower Socket Cap, 2-Bolt	AM60763DB	\$ 15.00	
766, 786, 886, 966, 986, 1026, 1066, 1086, 1466, 1468, 1486, 1566, 1586	Upper Socket Cap 3 3/4" Center-to-Center Hole Spacing	AM533808R1	\$ 26.00	
	Lower Socket Cap, 2-Bolt	AM379953R1	\$ 13.00	
766, 786, 886, 966, 986, 1066, 1086, 1466, 1468, 1486, 1566, 1586	Ball	AM65320C3	\$ 20.00	
460, 544, 560*, 660*, 666, 686, 706, 826, 856, 1026, 1206, 1256, 1456, Hydro 70, Hydro 86, Farmall®: 300, 350, 400, 450, 460, 656*, 706, 756, 806, Ind: 2544, 2706, 2826, 2856, 21026, 21206, 21256	Stay Rod Cap Shim Sold in Multiples of 5, Priced Individually	AM60762D	\$ 4.32	

*Excluding High Clearance Models



Axle Pivot Assembly and Pins

Application	Description	Part Number	Retail Price	Core
460, 544, 560, 656, 660, 666, 686, 706, 756, 806, 826, 1026, 1206, Hydro 70	Pivot Bolster	AM383909R4	\$ 235.00	
766, 786, 886, 966, 986, 1066, 1086, 1466, 1486, 1586, Hydro 100, Hydro 186	Pivot Bolster	AM531263R1	\$ 557.33	
706, 756, 766, 786, 826, 856, 886, 966, 986, 1026, 1066, 1086, 1206, 1456, 1466, 1468, 1486, 1566, 1568, 1586, Hydro 100, Ind: 2706, 2756, 2826, 2856	Bolster Pin Use w/ AM379941R1 Pin	AMU5360	\$ 3.22	
460, 544, 560, 656, 660, 666, 686, 706, 756, 806, 826, 1026, 1206, Hydro 70	Pivot Pin 8.50" Long, 1.50" Diameter	AM379941R1	\$ 85.74	
544, 560, 656, 660, 666, 686, 706, 756, 766, 786, 806, 826, 856, 886, 966, 986, 1026, 1066, 1086, 1206, 1256, 1456, 1466, 1486, Hydro 70, Hydro 86, Hydro 100, Hydro 186	Pivot Pin 8.50" Long, 1.232" Diameter	AM358978R2	\$ 25.00	
766, 786, 886, 966, 986, 1066, 1086, 1466, 1486, 1586, Hydro 100, Hydro 186	Pivot Pin 6.937" Long, 2" Diameter	AM531240R1	\$ 50.00	

International®—Tractor

Application	Description	Part Number	Retail Price	Core
786, 886, 986, 1086, 1486, 1586, 3088, 3288, 3488, 3688, 3688HC, 5088, 5288, 5488, Hydro 186	Pivot Pin Bushing, Rear 1.06" Long, 1.256" ID, 1.377" OD	AM482669R1	\$ 22.10	

Hydraulic Oil Cooler

Application	Description	Part Number	Retail Price	Core
766, 786, 886, 966, 986, 1066, 1086, 1466, 1468, 1486 - w/o A/C	Hydraulic Oil Cooler Replaces 533233R1	AM120300C1	\$ 275.00	
(786, 886, 986, 1086, 1486 - w/ A/C)	Transmission Oil Cooler Core: 8.00" x 17.75" x 1.50" Replaces 104740C1	AM104238C1	\$ 317.00	



Hydraulic Pumps

Application	Description	Part Number	Retail Price	Core
986 SN 24000-27999, 1086 SN 48000-54999, 1486 SN 20000-29149, 1586 ASN 21000, 3488, 3688	Hydraulic Pump Conversion Kit Pump sold separately, Use w/ AM70935-N to convert piston pump to gear pump	AM830456	\$ 1300.00	\$ 150.00
3388, 3588, 3788, 6588, 6788	Hydraulic Pump Conversion Kit Pump sold separately, Use w/ AM70935-N to convert piston pump to gear pump	AM830457	\$ 1450.00	\$ 150.00
100, 130, 140, 200, 230, A-1, AV, Super AV, AV-1, C, Super C	Hydraulic Pump Replaces 383013R94	AM384506R94	\$ 485.00	
300, 350, Super H - Gas	Hydraulic Pump 10 GPM, Standard	AM128191-N	\$ 835.00	
330, 340, Ind: 444, 2444	Hydraulic Pump 9 GPM, gaskets not included Replaces 368632R91, 368633R92, 368894R91, 377031R91	AM376993R94	\$ 759.37	
354, 364, 424, 444, B275, B414, Ind: 2300A, 2424, 2444 - All w/ Diesel Engine	Hydraulic Pump Replaces 1121539R91, 3072694R91	AM704330R95	\$ 225.00	
400, 450, Super M, Super MTA - Gas	Hydraulic Pump 12 GPM, Standard	AM128190-N	\$ 775.00	
454, 464, 484, 574, 584, 674, 684, 784, 884, Hydro 84, Ind: 2400A, 2500A, Backhoe-Loader: 3400A	Hydraulic Pump Note: If tractor has not been previously updated to this latest pump, an installation kit must be ordered. Caution should be taken on installing higher gallonage pumps on tractors not equipped w/ high capacity oil coolers and engine cooling fan.	AM93835N	\$ 358.00	
504, 544, 606, 656, 660, 706, 756, 766, 806, 826, 856, 966, 986, 1026, 1066, 1086, 1206, 1256, 1456, 1466, 1468, 1486, 1566, 1586, 3388, 3488, 3588, 3688, 6588, 6788, Hydro 100, Ind: 2504, 2544, 2606, 2656, 2706, 2756, 2826, 2856, 21026, 21256, 21456	Hydraulic Pump 17 GPM	AM70935-N	\$ 385.00	
986 SN 24000-27999, 1086 SN 48000-54999, 1486 SN 26000-29149, 1586 ASN 21000, 3388, 3488 w/ Draft, 3588, 3688 Hydro, 3788	Reman Hydraulic Pump Piston Pump	AM1263450-R	\$ 1495.00	\$ 500.00



Power Steering Cylinders and Components

Application	Description	Part Number	Retail Price	Core
238, 248, 258, 268, 385, 395, 454, 464, 474, 475, 484, 485, 495, 574, 584, 585, 595, 674, 684, 685, 784, 785, 884, 885, 895, 2400, 2500	Power Steering Cylinder Replaces 549667R1, 549667R91, 549667R93, 84336125	AM188842A1	\$ 325.00	

International®—Tractor

Application	Description	Part Number	Retail Price	Core
766, 786, 966, 986, 1066, 1086, 1466, 1486, 1566, 1568, 1586, (3088, 3288, 3688 - w/o All Wheel Drive), Hydro 100, Hydro 186, Hydro 3488 w/o All Wheel Drive, (5088, 5288, 5488 - w/ Standard Adjustable Tread Front Axle)	Power Steering Cylinder Replaces Late Style Cylinder w/ Tie Rod End, Tie Rod End Not Included	AM63864C91	\$ 320.00	
766, 966, 1066, 1466, 1566, 1568, Hydro 100	Power Steering Cylinder Early Style Straight Pin w/o Square End	AM533279R93	\$ 387.00	
(278, 584, 585, 684, 685, 784, 785, 884, 885 BSN 3084, Hydro 84 - w/ ZF Axle)	Power Steering Cylinder End 4.812" Long M30x1.50" Right Hand Thread Replaces 3141529R93	AM3141529R91	\$ 104.09	
484, 544, 584, 656, 684, 784, 884, Hydro 84, Ind: 2400A, 2500A, 2544, 2656	Power Steering Cylinder End 2.75" Long 7/8"x14 UNF Right Hand Thread For Cast Iron Non-Adjustable Front Axle	AM378817R91	\$ 73.50	
666, 686, 766, 786, 886, 966, 1066, 1086, 1466, 1468, 1486, 1566, 1568, 3088, 3288, 3688, Hydro 100, Hydro 186, 5088, 5288, 5488 - w/ 2WD	Power Steering Cylinder End 0.875" ID, 14 NF Thread Replaces Cylinder End Manufactured by TRW or O&S Bearing Replaces 71820C91	AM1280566C2	\$ 40.00	
766, 966, 1066, 1466, 1566, 1568, Hydro 100	Power Steering Cylinder End Used on early style straight pin power steering cylinders	AM533287R2	\$ 44.00	
5088, 5288, 5488	Power Steering Cylinder End, MFWD	AM1277261C1	\$ 120.00	
766, 786, 886, 966, 986, 1066, 1086, 1466, 1486, 1566, 1568, 1586, Hydro 100, Hydro 186	Power Steering Cylinder Rod	AM533286R21	\$ 160.00	
786, 886, 986, 1066, 1086, 1468, 1566, 1568, 1586, 3488, 3688, 5088, Hydro 100, Hydro 186	Trunnion Steering Cylinder Pivot Bushing Sold in Set of 2, Priced Individually 1.635" OD, 1.51" ID, 0.42" Wide	AM531237R1 AM533283R1	\$ 18.00 \$ 6.00	



Power Steering Pumps and Conversion Kits

Application	Description	Part Number	Retail Price	Core
330, 340, 460, 560, 660	Power Steering Pump 2.70 GPM	AM371135-N	\$ 310.00	
504, 606, 2504, 2606, 3488, 21026, Hydro 100, Hydro 186, Hydro 826, Hydro 966, Hydro 1026, Hydro 1066, Hydro 2826	Power Steering Pump 4.50 GPM	AM378866-N	\$ 485.00	
544, 656, 666, 686, Hydro 70, Hydro 86, Ind: 2544, 2656	Power Steering Pump 9 GPM	AM391351R94	\$ 485.00	
706, 756, 766, 786, 806, (826, 966, 1026, 1066 - w/ Gear Drive), 856, 886, 986, 1086, 1206, 1256, 1456, 1466, 1468, 1486, 1566, 1568, 1586, 3088, 3288, 3688, Ind: 2706, 2756, 2826 Gear Drive, 2856, 21256, 21456	Power Steering / MCV Pump 12 GPM Replaces 527397R93	AM120114-N	\$ 355.00	
706, 756 BSN 8424, 806, 856 BSN 9492, 4100, Ind: 2706, 2756 BSN 8424, 2856 BSN 9492, 21206, 21256, Farmall®: 756 BSN 17635, 1206	Drive Gear 19 Tooth For Power Steering Pump	AM382332R1	\$ 170.89	
756, 766, 786, 826, 856, 886, 966, 986, 1066, 1086, 1456, 1466, 1468, 1566, 1568, 1586, 3088, 3288, 3688, 4156, 4166, 4186, Ind: 2756, 2826, 2856, 21456	Hydraulic Pump Drive Gear 19 Tooth, 25° Replaces 527397R93	AM405181R1	\$ 66.00	
3388, 3588, 3788	Power Steering Conversion Kit Includes New Gear Pump, Hoses and Fittings	AM3588PS-K	\$ 1075.00	\$ 250.00



Multiple Control Valves

Application	Description	Part Number	Retail Price	Core
86 Series w/o Torque Amplifier Assembly	Reman Multiple Control Valve	AM1263287C91	\$ 595.00	\$ 200.00
606, 656, 666, 706, 756, 766, 806, 826, 856, 966, 1026, 1066, 1206, 1256, 1456, 1466, 1566, 1586 - w/o Torque Amplifier Assembly	Reman Multiple Control Valve	AM533361NTA	\$ 595.00	\$ 200.00
606, 656, 666, 706, 756, 766, 806, 826, 856, 966, 1026, 1066, 1206, 1256, 1456, 1466, 1566, 1586 - w/ Torque Amplifier Assembly	Reman Multiple Control Valve	AM533361R92	\$ 595.00	\$ 200.00
766, 786, 886, 966, 986, 1066, 1086, 1466, 1468, 1486, 1566, 1568, 1586, 3388, 3588, 3788 - w/ Torque Amplifier Assembly	Reman Multiple Control Valve	AM1263289	\$ 595.00	\$ 200.00
706, 756, 766, 786, 806, 826, 856, 886, 966, 986, 1026, 1066, 1086, 1206, 1256, 1466, 1468, 1486, 1566, 1568, 1586, 3088, 3288, 3388, 3588, 3788, 6388, 6588, 6788, Ind: 2706, 2756, 2806, 2826, 2856, 21026, 21206, 21256, 21456	Gasket Set, MCV	AM393877R93	\$ 50.00	
706, 756, 766, 786, 806, 826, 856, 886, 966, 986, 1066, 1086, 1206, 1256, 1466, 1486, 1566, 3088, 3288, 3588, 6388, 6588, Ind: 2706, 2806, 2856, 21256, 21456	Spring Kit	AM830458	\$ 45.00	

Power Steering Orbit Motors



Application	Description	Part Number	Retail Price	Core
400, 450, M, Super M, MTA - w/ Gas or LPG	Power Steering Orbit Motor Port Block Not Included	AM207-1015	\$ 1055.00	
	Port Block Use w/ AM207-1015 Orbit Motor	AM208-1015	\$ 85.00	
385, 484, 485, 584, 585, 684, 685, 884, 885	Power Steering Orbit Motor	AM67698C94	\$ 285.00	
766, 966, 1066, 1466, 1468, 1566, 1568, Hydro 100 - Non-Tilt Tractors Only	Power Steering Orbit Motor Splined w/ Threads	AM70111C94	\$ 1390.00	
786, 886, 986, 1086, 1486, 3688, 5088, 5288, 5488, Hydro 3488	Power Steering Orbit Motor Roll Pin Style	AM1263446C91	\$ 1215.00	

Remote Valves and Valve Kits



Application	Description	Part Number	Retail Price	Core
06 & 66 Series	Reman Hydraulic Valve Open on both sides	AM529910-R	\$ 625.00	\$ 100.00
	Reman Hydraulic Valve Closed on one side	AM529911-R	\$ 725.00	\$ 100.00
66 & 86 Series	Reman Remote Coupler	AM544786-R	\$ 495.00	\$ 75.00
786, 886, 986, 1086, 1486, 1586, 3088, 3288, 3388, 3488, 3588, 3688, 3488, 4586, 4786, 5088, 5288, 5488, 6388, 6533, 6788, Hydro 186	Hydraulic Coupler Mounting Plate	AM120012C1	\$ 35.00	
86 Series	Reman Remote Valve Open Center	AM62464C94	\$ 550.00	\$ 100.00
5088, 5288, 5488, 7288, 7488	Reman Remote Coupler Assembly	AM1272192-R	\$ 595.00	\$ 75.00
706, 806 - Early	Reman Second Valve Kit Includes Reman Valve and Coupler, New Hoses, and Handle Kit (Short, Rectangular, Cast Iron Handle)	RVK806	\$ 1050.00	
706 Late, 756, 766, 806 Late, 826, 856, 966, 1026, 1066, 1206, 1256, 1456, 1466, 1468, 1566, 1586, Hydro 100, Ind: 2504, 2544, 2606, 2656, 2706, 2756, 2826, 2856, 21026, 21256, 21456	Reman Second Valve Kit Includes Reman Valve and Coupler, New Hoses and Handle Kit (17 1/2", Round, Steel Handle)	RVK1066	\$ 1050.00	

International®—Tractor

Application	Description	Part Number	Retail Price	Core
786, 886, 986, 1086, 1486, 1586, Hydro 186 - w/o Piston Hydraulic Pump	Reman Third Valve Kit Includes Reman Valve and Coupler, New Hoses, and Handle Kit	RVK1086	\$ 1050.00	
766, 786, 886, 966, 986, 1066, 1086, 1466, 1468, 1486, 1566, 1568, 1586, 3088, 3288, 3388, 3488, 3588, 3788, 4366, 4568, 4586, 4786, 5088, 5288, 5488, Hydro 100, Hydro 186	Hydraulic Coupler Conversion Kit Converts International® Harvester Remote Couplers to ISO/Pioneer Couplers Includes: (2) 8301373 7/8" x 14 Thread Male Coupler Tips, (2) Cap Screws, (2) Washers, (2) Snap Rings, (2) Automatic Dust Caps and (4) O-Rings	AMX47115	\$ 225.00	
	Hydraulic Coupler Conversion Kit Converts International® Harvester Remote Couplers to ISO/Pioneer Couplers Includes (2) 8301372 1/2" x 14 NPTF Thread Male Coupler Tips, (2) Cap Screws, (2) Washers, (2) Snap Rings, (2) Automatic Dust Caps and (4) O-Rings	AMX47116	\$ 225.00	
404, 454, 464, 504, 544, 574, 656, 664, 666, 674, 686, 706, 756, 766, 856, 966, 1026, 1066, 1256, 1466, 1468, 1566, 1568, 2400, 2500, Hydro 70, Hydro 86, Hydro 100, 4WD: 4100, 4156, 4166, 4186, 4366, 4386, 4568, 4586, 4786, Ind: 2404, 2504, 2544, 2656, 2706, 2756, 2856, 21026, Farmall®: 404, 504, 544, 656, 706, 756	Repair Kit, Control Valve Open Center Includes Piston, Poppet Assembly and O-Rings	AM383548R92	\$ 275.00	
454, 574, 656, 766, 806, 856, 966, 1026, 1066 Gear Drive, 1206, 1256, 1456, 1466, 1468, 4156, 4166, 4186, Hydro 100, Ind/Const: 2400A, 2500A, 2656, 2806, 2856, 4100, 21026, 21206, 21256, 21456	Relief Valve 2000 PSI For Hitch Pump Circuit Replaces 388208R92, 388208R93	AM388208R91	\$ 180.00	
686, 756, 766, 786, 856, 886, 966, 986, 1026, 1066, 1086, 1086, 1466, 1468, 1566, 1568, 1586, 3088, 3288, 3388, 3488, 3588, 3688, 4166, 4186, 4366, 4386, 4568, 4586, 4786, 5088, 5288, 5488, 6388, 6588, Hydro 70, Hydro 86, Hydro 186	Hydraulic Port Lever	AMSS2001	\$ 36.00	
706, 756, 766, 806, 826, 856, 966, 1026, 1066, 1206, 1256, 1456, 1466, 1468, 1566, 1568, Hydro 100, Ind: 2706, 2756, 2806, 2826, 2856, 21026, 21206, 21256, 21456	Control Lever Knob	AM389168R1	\$ 6.00	

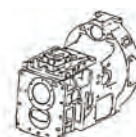

Hydrostats and Components

Application	Description	Part Number	Retail Price	Core
3488, Hydro 100, Hydro 186, Hydro 1066	Hydro Drive Plate, 6-Bolt 14" x 1 3/8", 13 Spline, 13" Center-to-Center Holes	AM69298	\$ 185.00	
826, 1026	Hydro Drive Plate, 6-Bolt 14 x 1 3/16", 11 Spline, 13" Center-to-Center Holes	AM406036	\$ 150.00	

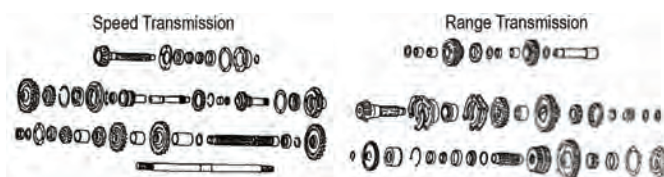









Transmission Components, Range and Speed

Application	Description	Part Number	Retail Price	Core
56, 66, 86, 88 Series Tractors	1st Gear	AM406473R1	\$ 125.00	











International®—Tractor



	Application	Description	Part Number	Retail Price	Core
	826, 856 Late, 966, 986, 1066, 1086, 1456, 1466, 1468, 1486, 3388, 3588, 3688, Ind: 2826, 2856 Late, 21456 - All T/A & Non-T/A	Mainshaft Replaces 529828	AM529434R1	\$ 275.00	
	826, 856 ASN 9493, 966, 986, 1066, 1086, 1456, 1466, 1468, 1486, 3388, 3588, 3688, 6388, 6588, Hydro 100 - w/o Torque Amplifier, Ind: 2826, 2856, 21456, Farmall®: 856 ASN 27287 w/o Torque Amplifier	Mainshaft Replaces 529282R1	AM529282R2	\$ 569.68	
	1566, 1568, 1586, 3788 - T/A & Non-T/A Tractors	Mainshaft Replaces 68048C1	AM68141	\$ 475.00	
	756 Late, 766, 786, 826, 856 Late, 886, 966, 986, 1066, 1086, 1456, 1466, 1468, 1486, 3088, 3288, 3688, Ind: 2756 Late, 2826, 2856 Late, 21456	1st & 2nd Gear on Mainshaft Sliding, 46 & 41 Tooth, 20 Spline	AM528674	\$ 370.00	
	756 Late, 766, 786, 826, 856 Late, 886, 966, 986, 1066, 1086, 1456, 1466, 1468, 1486, 3088, 3288, 3388, 3588, 3688, Ind: 2756 Late, 2826, 2856 Late, 21456	3rd & 4th Gear on Mainshaft Sliding	AM528675	\$ 210.00	
	756 Late, 766, 786, 826, 856 Late, 886, 966, 986, 1066, 1086, 1456, 1466, 1468, 1486, 3088, 3288, 3688, Ind: 2756 Late, 2826, 2856 Late, 21456	Constant Mesh on Mainshaft	AM528670R1	\$ 108.00	
	756 Late, 766, 786, 826, 856 Late, 886, 966, 986, 1066, 1086, 1456, 1466, 1468, 1486, 3088, 3288, 3688, Ind: 2756 Late, 2826, 2856 Late, 21456	2nd Gear on Countershaft Driven	AM528672	\$ 145.00	
	756 Late, 766, 786, 826, 856 Late, 886, 966, 986, 1066, 1086, 1456, 1466, 1468, 1486, 3088, 3288, 3688, Ind: 2756 Late, 2826, 2856 Late, 21456	3rd Gear on Countershaft Driven	AM528671	\$ 135.00	
	756 Late, 766, 786, 826, 856 Late, 886, 966, 986, 1066, 1086, 1456, 1466, 1468, 1486, 3088, 3288, 3688, Ind: 2756 Late, 2826, 2856 Late, 21456	Constant Mesh on Countershaft	AM528673	\$ 160.00	
	706, 756, 766, 786, 806, 826, 856, 886, 966, 986, 1066, 1086, 1206, 1256, 1456, 1466, 1468, 1486, 1566, 1568, 1586, 3088, 3288, 3388, 3588, 3688, 3788, 4100, 4156, 4166, 4186, 6388, 6588, 6788, Ind: 2706, 2756, 2806, 2826, 2856, 21206, 21256, 21456	Countershaft	AM148951	\$ 300.00	
	706, 756, 766, 786, 806, 826, 856, 886, 966, 986, 1066, 1086, 1206, 1256, 1456, 1466, 1468, 1486, 1566, 1568, 1586, 3088, 3288, 3388, 3588, 3688, 3788, 4100, 4156, 4166, 4186, 6388, 6588, 6788, Ind: 2706, 2756, 2806, 2826, 2856, 21206, 21256, 21456	Countershaft Nut Left Hand Thread	AM148952	\$ 17.50	
	706, 756, 766, 786, 806, 826, 856, 886, 966, 986, 1066, 1086, 1206, 1256, 1456, 1466, 1468, 1566, 1568, 1586, 3088, 3288, 3388, 3588, 3688, 3688HC, 3788, 4100, 4156, 4166, 4186, 6388, 6588, 6788, Ind: 2706, 2756, 2806, 2826, 2856, 21206, 21256, 21456	Reverse Idler Gear 30 Tooth Replaces 380299R1	AM393523R1	\$ 289.16	
	706, 756, 766, 806, 826, 856, 966, 1026, 1066, 1206, 1256, 1456, 1466, 1468, 1566, 1568, Hydro 100, Ind: 2706, 2756, 2806, 2826, 2856, 21026, 21206, 21256, 21456	Reverse Drive on Pinion Shaft	AM380288R1	\$ 220.00	

Prices Subject to Change without Prior Notice. The use of original equipment manufacturer (OEM) part numbers or trademarks, e.g. Case® and John Deere®, are for reference purposes only and for indicating product use and compatibility. Our company and the listed replacement parts contained herein are not sponsored, approved or manufactured by the OEM. All parts are New unless designated Reman in the description.

International®—Tractor

Application	Description	Part Number	Retail Price	Core
 06-66 Series	High / Low Driven Gear w/ Bushing Cast # - 380290	AM528683R11	\$ 170.00	
 786, 986, 1086, 1486, 1586, 3288, 3388, 3588, 3688, 3788, 6388, 6588, 6788	Shifter Kit Includes Duckfoot, Arm and Mounting Hardware	AM71526KIT	\$ 115.55	
 756, 766 BSN 17047, 826, 856 1968-71, 966 BSN 32222, 1026, 1066 BSN 57646, 1256, 1456, 1466 BSN 30000, (1468, 1566 BSN 1305), 1568 BSN 7994, Ind: 2756, 2826, 2856	Hi/Lo Shift Kit Includes Shaft w/ Lever and Splined Arm	AM398285KIT	\$ 195.65	
766 ASN 7047, 966 ASN 3222, 1066 ASN 57645, 1086, 1466 BSN 30001, 1566	Hi/Lo Shift Kit Includes Shaft w/ Duckfoot, Shift Lever, (2) Control Arms, (2) Rollers, Spring, Roll Pin and Allen Head Bolt	AMIH6688KIT	\$ 174.20	
 756, 766, 786, 826, 856, 886, 966, 986, 1026, 1066, 1086, 1256, 1456, 1466, 1468, 1486, 1566, 1568, 1586, 3088, 3288, 3388, 3488, 3588, 3688, 3788, 6388, 6588, 6788, Hydro 100, Hydro 186, Ind: 2756, 2826, 2856, 21026, 21256, 21456	High-Low Shift Fork	AM398279R2	\$ 86.61	
 706, 756, 766, 806, 826, 856, 966, 1026, 1066, 1206, 1256, 1456, 1466, 1468, 1566, 1568, Hydro 100, Ind/Const: 2706, 2756, 2806, 2826, 2856, 21206, 21256, 21456	Selector Link Assembly For Upper Range Transmission	AM393354R91	\$ 30.02	
100, 706, 756, 766, 806, 826, 856, 966, 1026, 1066, 1206, 1256, 1456, 1466, 1468, 1566, 1568, Hydro 100, Ind: 2706, 2756, 2806, 2826, 2856, 21026, 21206, 21256, 21456	Park Lock Kit	AM390856KIT	\$ 40.37	
 706, 756, 766, 806, 826, 856, 886, 986, 1026, 1066, 1086, 1206, 1256, 1456, 1466, 1468, 1468, 1486, 1568, 1586, 3088, 3288, 3388, 3488, 3588, 3688, 3788, 6388, 6588, 6788, Hydro 100, Hydro 186	Park Pawl	AM139141C1	\$ 278.04	
 706, 756, 766, 786, 806, 826, 856, 886, 966, 986, 1066, 1086, 1206, 1256, 1456, 1466, 1468, 1486, 1566, 1568, 1596, 3388, 3588, 3788, Hydro 100, Ind: 2706, 2756, 2806, 2826, 2856, 21206, 21456	Transmission Brake Lever Replaces 384311R11, 384311R21	AM1981317C1	\$ 66.51	
756, 766 BSN 17046, 856, 966 BSN 32222, 1026, 1066 BSN 57646, 1256, 1456, 1466 BSN 30000, (1468, 1566 BSN 1305), 1568 BSN 7994	Shift Cover Repair Kit	AMIH5686KIT	\$ 224.98	
 756, 766 BSN 17047, 856, 966 BSN 32222, 1026, 1066 BSN 57646, 1256, 1456, 1466 BSN 30000, (1468, 1566 BSN 1305), 1568 BSN 7994	Upper Shaft, Reverse Shift Replaces 398291R2	AM398291	\$ 120.16	
 756, 766 BSN 17046, 856, 966 BSN 32221, 1026, 1066 BSN 57645, 1256, 1456, 1466 BSN 30000, (1468, 1566 BSN 1305), 1568 BSN 7994	Lower Shaft, Reverse Shift	AM398297R1	\$ 68.64	
706, 806, 1206	Reverse Shift Pivot Arm Assembly Includes Detent and O-Rings Replaces 380312R13	AM380312-K	\$ 67.00	
786, 886, 986, 1086, 1486, 1586, 3088, 3288, 3388, 3588, 3688, 3788, 6388, 6588, 6788	Reverse Shift Shaft	AM120262C1	\$ 148.42	

International®—Tractor

Application	Description	Part Number	Retail Price	Core
 706, 806, 1206, Ind: 2706, 2806, 21206	Cam Pivot Shaft	AM391018R21	\$ 22.00	
706, 756, 766, 786, 806, 826, 856, 966, 986, 1066, 1086, 1206, 1256, 1456, 1466, 1468, 1486, 1566, 1568, 1586, 3088, 3288, 3388, 3588, 3688, 4100, 4156, 4166, 4186, 6388, 6588, 6788, Ind: 2706, 2756, 2806, 2826, 21206, 21256, 21456	Detent Roller	AM380115R2	\$ 5.65	
 766, 806 Hi/Lo Transmission, 966 BSN 032222, 1066, 1466, 1468	Cover Gasket For Range Transmission	AM380315R2	\$ 7.55	
756, 766, 856, 966, 1026, 1066, 1256, 1456, 1466, 1468, 1566, 1568	Detent, Reverse Replaces 528183R1	AM398294R1	\$ 50.90	
 756, 766, 786, 856, 886, 966, 986, 1026, 1066, 1086, 1256, 1456, 1466, 1468, 1486, 1566, 1568, 1586, 3088, 3288, 3388, 3488, 3588, 3688, 3788, 6388, 6588, 6788	Control Arm Kit Includes (2) Arms, (2) Detent Rollers and Spring	AM398300KIT	\$ 73.11	
5088, 5288, 5488	Backing Plate 4.06" ID, 7.97" OD, 0.39" Thick	AM139018C3	\$ 298.87	
5088, 5288, 5488	Friction Plate 35 Tooth, 4.605" ID, 8" OD, 0.12" Thick	AM120767C3	\$ 27.28	
5088, 5288, 5488	Friction Plate, Shift Clutch	AM1286401C1	\$ 20.94	
5088, 5288, 5488	Piston Return Plate 4.062" ID, 7.953" OD, 0.121" Thick	AM120696C1	\$ 32.47	
5088, 5288	Separator Plate	AM120768C3	\$ 55.19	
5488	Separator Plate 4.72" ID, 9.61" OD, 0.139" Thick	AM1264928C2	\$ 46.68	
5488	Master Clutch Plate Pack	AM1264940C94	\$ 417.73	

Transmission Parts

Application	Description	Part Number	Retail Price	Core
H	3rd & 4th Drive Gear, 31 & 35 Tooth	AM56417DA	\$ 153.96	
H	4th & 5th Drive Gear, 18 & 35 Tooth	AM56420DA	\$ 120.00	

PTO Shafts

Application	Description	Part Number	Retail Price	Core
06, 56, 66, 68 & 86 Series	PTO Shaft 1000 RPM	AM120985C1	\$ 235.00	
(56, 66, 86, & 88 Series - w/ Dual Speed PTO), (706-1086 - w/ Single Speed PTO)	PTO Shaft 540 RPM, 10.815" Long, 13 Drive Spline	AM393111R1	\$ 120.00	
454 ASN 8078, 464, 484, 574, 584 BSN 6804, 674, 684 BSN 6844, 784 BSN 6826, 884 BSN 6377, Hydro 84 BSN 5796, Ind: 2400AASN 692, 2500A	PTO Shaft, 540 RPM 27 Spline, 9.60" Long	AM3113017R1	\$ 168.67	
5088, 5288	PTO Shaft 540 RPM, 10.435" Long, 13 Tooth Front Spline	AM148663C1	\$ 145.00	
5088 BSN 8263, 5288 BSN 6029, 5488 BSN 4070 - w/ Dual Speed	PTO Shaft 1000 RPM, 12.78" Long, 17 Tooth Front Spline	AM148664C1	\$ 250.00	
5088 ASN 8263, 5288 ASN 6029, 5488 ASN 4070 - w/ Dual Speed	PTO Shaft 1000 RPM, 12.78" Long, 17 Tooth Front Spline	AM1285757C1	\$ 225.00	

Prices Subject to Change without Prior Notice. The use of original equipment manufacturer (OEM) part numbers or trademarks, e.g. Case® and John Deere®, are for reference purposes only and for indicating product use and compatibility. Our company and the listed replacement parts contained herein are not sponsored, approved or manufactured by the OEM. All parts are New unless designated Reman in the description.

International®—Tractor

PTO Adapters

Application	Description	Part Number	Retail Price	Core
Tractors up to 70HP	PTO Adapter Small 540 to 1000 Spline, 4 1/8" Overall Length Changes PTO from 1 3/8" x 6 spline to 1 3/8" x 21 spline and extends the PTO shaft 4 1/8"	AMX59112	\$ 40.00	
Tractors up to 70HP	PTO Adapter Small 1000 to 540 Spline, 6 3/8" Overall Length Reduces PTO from 1 3/8" x 21 spline to 1 3/8" x 6 spline and extends the PTO shaft 4 1/8"	AMX59108	\$ 40.00	
Tractors up to 100HP	PTO Adapter Large 1000 to 540 Spline, 7 1/2" Overall Length Reduces PTO from 1 3/4" x 20 spline to 1 3/8" x 6 spline and extends the PTO shaft 4 5/8"	AMX59109	\$ 70.00	
Tractors up to 100HP	PTO Adapter Large 1000 to Small 1000 Spline, 7" Overall Length Changes PTO from 1 3/4" x 20 spline to 1 3/8" x 21 spline and extends the PTO shaft 4 5/8"	AMX59110	\$ 70.00	



Gear Set Conversion for 88 Series

Application	Description	Part Number	Retail Price	Core
5088, 5288, 5488	Gear Set Conversion Our gear set conversion allows you to use the late style transmission plates on early serial number tractors. Not sold individually.	AM5288-GK	\$ 325.00	



Shift Lever Housing and Cover

Application	Description	Part Number	Retail Price	Core
756, 766, 826, 856, 966, 1066, 1256, 1456, 1466, 1468, 1566, 1568	Range Shift Lever	AM529489R1	\$ 83.66	
756, 766, 826, 966, 1066, 1256, 1456, 1466, 1468, Ind: 2756, 2826, 21256, 21456 - All w/ Gear Drive	Shift Lever Cover	AM398005R2	\$ 45.00	
	Shift Lever Housing	AM398006R1	\$ 62.00	



Torque Amplifier Assemblies and Components

Application	Description	Part Number	Retail Price	Core
300, 330, 340, 350, 460, 504, 554, 664, Ind: 2504, 2544 - All w/o Belt Pulley Drive Gear	Reman Torque Amplifier Assembly 2.13" Bearing	AM402778	\$ 625.00	\$ 100.00
300, 350, 460 - Farmall w/ Belt Pulley Drive Gear	Reman Torque Amplifier Assembly	AM363854	\$ 690.00	\$ 100.00
504, Ind: 2504 - All w/o Belt Pulley Drive Gear	Reman Torque Amplifier Assembly 2.10" Bearing	AM394812	\$ 690.00	\$ 100.00
544, 606, Ind: 2544, 2606 - All w/o Belt Pulley Drive Gear	Reman Torque Amplifier Assembly	AM394813	\$ 625.00	\$ 100.00
656, 666, 686 - w/o Belt Pulley Drive Gear	Reman Torque Amplifier Assembly	AM394814	\$ 625.00	\$ 100.00
Super MTA, 400, 450, 560, 660 - w/o Belt Pulley Drive Gear	Reman Torque Amplifier Assembly	AM363499	\$ 625.00	\$ 100.00
706, 756, 766, 806, 826, 856, 886, 966, 986, 1066, 1086, 1206, 1256, 1456, 1466, 1468, 1486, (3088, 3288, 3688 - w/ Mechanical Park Brake)	Reman Hydraulic Torque Amplifier Assembly TA529	TA529	\$ 795.00	\$ 100.00
	Reman Hydraulic Torque Amplifier Assembly Heavy Duty	TA529-HD	\$ 895.00	\$ 100.00
1566, 1568, 1586, 3788, 6788	Reman Hydraulic Torque Amplifier Assembly	TA681	\$ 895.00	\$ 100.00
3388, 3588, 6388, 6588	Reman Hydraulic Torque Amplifier Assembly	TA142	\$ 895.00	\$ 100.00
300, 330, 340, 350, 460, 504, 544, 606, 656, 666, 686, Ind: 2504, 2544, 2606	Torque Amplifier Gasket Kit	AM395915R93	\$ 61.96	

International®—Tractor

Application	Description	Part Number	Retail Price	Core
706, 756, 766, 806, 826, 856, 966, 986, 1066, 1086, 1206, 1256, 1456, 1466, 1468, 1486, 3088, 3288, 3688	Torque Amplifier Gasket Kit	AM79020	\$ 72.00	
1566, 1568, 1586, 3788	Torque Amplifier Gasket Kit	AM79018	\$ 72.00	
3388, 3588, 6388, 6588	Torque Amplifier Gasket Kit	AM79019	\$ 95.00	
Super MTA, 400, 450, 560, 660 - w/ Belt Pulley Drive Gear	Torque Amplifier Gasket Kit	AM373338R91	\$ 49.68	
300, 330, 340, 350, 460, 504, 544, 606, 656, 664, 666, 686, Ind: 2504, 2544, 2606	Mechanical TA Gasket Kit Includes Carrier Seals IPTO Seals and O-Rings Not Included	AM8395915	\$ 96.00	
278, 474, 485, 585, 685, 785, 885 BSN 3084	Torque Amplifier Disc Kit Includes (6) Friction Discs, (4) Steel Plates and (2) Seals Replaces 534936R92	AM534936R93	\$ 190.48	
706, 756, 766, 806, 826, 856, 966, 986, 1066, 1086, 1206, 1256, 1456, 1466, 1468, 1486, 3088, 3288, 3688	Torque Amplifier Elimination Kit	AM830431	\$ 465.00	\$ 100.00
1566, 1568, 1586, 3788	Torque Amplifier Elimination Kit	AM830432	\$ 520.00	\$ 100.00
3388, 3588, 6388, 6588, 6788	Torque Amplifier Elimination Kit	AM830442	\$ 470.00	\$ 100.00
Super MTA, 400, 450, 460, 560, 660	Torque Amplifier Elimination Kit	AM8363499E	\$ 385.00	\$ 80.00
706, 756, 766, 786, 806, 826, 856, 866, 886, 966, 986, 1066, 1086, 1206, 1256, 1456, 1466, 1486, 3288, 3388, 3588, 3688, 6388, 6588	Torque Amplifier Quill Shaft Includes Inner Needle Bearing	AM382349	\$ 150.00	
1566, 1568, 1586, 3788, 6788	Torque Amplifier Quill Shaft Includes Inner Needle Bearing	AM68139	\$ 172.00	
786, 886, 986, 1086, 1486, 1586, 3388, 3588, 3788	Torque Amplifier Control Cable 26.25" Long	AM120003C2	\$ 46.68	



IPTO Shafts

Application	Description	Part Number	Retail Price	Core
300, 330, 340, 350, 460 - Planetary PTO	IPTO Shaft and Gear 1 11/16" Diameter, 16 Spline, 25 Tooth	AM362619-N	\$ 215.00	
330, 340, 460 - w/ 540 RPM Clutch Type IPTO	IPTO Shaft and Gear 1 11/16" OD, 16 Spline, 24 Tooth	AM373666-N	\$ 220.00	
400, 450, Super M, Super MTA	IPTO Shaft and Gear 25 Tooth, 17 Spline 1 3/4" OD	AM360468-N	\$ 160.95	
400, 450, Super MTA	Reman IPTO Shaft and Gear 1 3/4" Diameter, 17 Spline, 25 Tooth	AM360468-R	\$ 150.00	\$ 10.00
454, 464, 484, 485, 495, 574, 584, 674, 684, 784, 884, 885, Hydro 70, Hydro 84, Ind: 2400A	IPTO Shaft and Gear 1 5/8" Diameter, 21 Tooth, 10 Spline Requires 71229C2 Carrier and 108982C1 Seal when used to replace 398235R1 or 66347C3 IPTO Shaft and Gear	AM71230-N	\$ 100.00	
560 - Planetary PTO	IPTO Shaft and Gear 1 3/4" Diameter, 17 Spline, 22 Tooth	AM370662-N	\$ 155.40	
560	IPTO Drive Gear	AM373656R1	\$ 170.00	
656 w/ 540 RPM, 2656	Reman IPTO Shaft and Gear 1 11/16" Diameter, 16 Spline, 24 Tooth	AM388627-R	\$ 135.00	\$ 10.00

International®—Tractor

Application	Description	Part Number	Retail Price	Core
706, 756* (Farmall® BSN 17635, International® BSN 8424), 806, 856* (Farmall® BSN 27286, International® BSN 9492), 1206, 1256, 4100, Ind: 2706, 2756* (Farmall® BSN 17635, International® BSN 8424), 2806, 2856* (Farmall® BSN 27286, International® BSN 9492), 21206, 21256 *Check serial number of tractor and degree of angle on teeth before ordering	IPTO Shaft and Gear 1 3/4" Diameter, 28 Tooth w/ 20° Tooth Angle, 17 Spline	AM380261-N	\$ 89.00	
756, 766, 766, 786, 826, 856, 966, 986, 1066, 1086, 1456, 1466, 1468, 1486, 3088, 3288, 3688, Ind: 2756, 2826, 21456	IPTO Shaft and Gear 1 3/4" Diameter, 17 Spline, 28 Tooth w/ 25° tooth angle	AM528676-N	\$ 89.00	
(766, 966, 1066, 1466, 1468 - Late), 1486	IPTO Shaft and Gear 1 3/4" Diameter, 17 Spline, 26 Tooth w/ 25° tooth angle Check degree of angle of teeth before ordering	AM67596C1	\$ 89.00	
1566, 1568	IPTO Shaft and Gear 1 7/8" Diameter, 18 Spline, 26 Tooth w/ 25° tooth angle	AM67749C1	\$ 114.00	
1586, 3388, 3588, 3788, 5788, 6388, 6588	IPTO Shaft and Gear 1 7/8" Diameter, 18 Spline, 28 Tooth, w/ 25° tooth angle	AM104401C1	\$ 117.39	
4156, 4166, 4186	Reman IPTO Shaft and Gear 1 3/4" Diameter, 17 Spline, 28 Tooth w/ 25° tooth angle	AM405182-R	\$ 105.00	\$ 10.00



IPTO Gear Bearings and Seal Kits

Application	Description	Part Number	Retail Price	Core
Super MTA, 400, 450, 560, 660	IPTO Gear Bearing & Seal Kit Includes Release Bearing, Pilot Bearing, (2) IPTO Seals and IPTO Bearing Cage O-Ring	AM30436	\$ 75.00	
330, 340, 504, 2504	IPTO Gear Bearing & Seal Kit Includes Release Bearing, Pilot Bearing, (2) IPTO Seals and IPTO Bearing Cage O-Ring	AM30435	\$ 80.00	
300, 350, 460, 544, 606, 656, 664, 666, 686, 2544, 2606, 2656	IPTO Gear Bearing & Seal Kit Includes Release Bearing, Pilot Bearing, (2) IPTO Seals and IPTO Bearing Cage O-Ring	AM30434	\$ 75.00	
706, 756, 766, 786, 806, 826, 856, 886, 966, 986, 1066, 1086, 1206, 1256, 1456, 1466, 1468, 1486, 3088, 3288, 3688, 4100, 4156, 4166, 4186, Ind: 2706, 2756, 2806, 2856, 21206, 21256, 21456	IPTO Gear Bearing & Seal Kit Includes Release Bearing, Pilot Bearing, IPTO Inner Seal, IPTO Outer Seal and IPTO Bearing Cage O-Ring	AM30416	\$ 56.00	
3388, 3588, 6388, 6588	IPTO Gear Bearing & Seal Kit Includes Release Bearing, Pilot Bearing, IPTO Inner Seal, IPTO Outer Seal and IPTO Bearing Cage O-Ring	AM30420	\$ 65.00	
1566, 1586, 1568, 3788, 6788	IPTO Gear Bearing & Seal Kit Includes Release Bearing, Pilot Bearing, IPTO Inner Seal, IPTO Outer Seal and IPTO Bearing Cage O-Ring	AM30418	\$ 70.00	
1066, 1086, 1466, 1468, 1486, 1586, 3388, 3588, 3788, 4156, 4166, 4186, 6388, 6588, 6788	IPTO Driveshaft Bearing Use w/ AM405182-R, AM528676-N or AM104401C1 IPTO Shaft and Gear	AM70227C91	\$ 70.70	

International®—Tractor



PTO Assemblies and Components

Application	Description	Part Number	Retail Price	Core
706, 756, 806, 856, 886, 966, 986, 1066, 1086, 3388, Hydro 100, Hydro 186, Ind: 2706, 2756, 2806, 2856	Reman Dual Speed Pumpkin Assembly 540/1000 RPM For Mechanical PTO Square Block, Pull Up to Engage	AM9020	\$ 1500.00	\$ 500.00
786, 886, 986, 1086, 1566, 1568, 1586, 3088, 3288, 3388, 3488 Hydro, 3588, 3688, 3688HC, 3788, Hydro 186	Reman Dual Speed Pumpkin Assembly 540/1000 RPM For Hydraulic PTO Smooth Shaft, Push Down to Engage	AM9021	\$ 1850.00	\$ 500.00
5088, 5288, 5488	Reman Dual Speed Pumpkin Assembly 540/1000 RPM For Hydraulic PTO	AM9024	\$ 2500.00	\$ 1500.00
5088, 5288, 5488	Dual Speed Conversion Kit	AMX59104	\$ 1500.00	
Late 86 Series, Early 88 Series - w/ Hydraulic PTO	Dual Speed Conversion Kit	AMX59105	\$ 1500.00	
(706-1086 - w/ Single Speed PTO), (56, 66, 86, 88 Series - w/ Dual Speed PTO)	Standard PTO Clutch Kit Consists of (5) fiber and (12) steel discs	AM68802C91	\$ 50.00	
(706-1466 - w/ Single Speed PTO), (56, 66, 86, 88 Series - Dual Speed PTO)	Heavy Duty PTO Clutch Kit Consists of (7) fiber and (9) steel discs	AM68803C91	\$ 50.00	
544, 656, 664, 666, 686, 706, 756, 766, 786, 806, 826, 856, 886, 966, 986, 1026, 1066, 1086, 1206, 1256, 1456, 1466, 1468, 1486, 1566, 1568, 1586, 3088, 3288, 3388, 3488, 3588, 3688, 3788, 5088, 5288, 5488, 6388, 6788, Hydro 86, Hydro 186	PTO Clutch Disc 51 Spline, 3.73" ID, 5.30" OD Replaces 381490R4, 1277392C1, 1997688C1	AM381490R1	\$ 4.00	
544, 656, 664, 666, 686, 706, 756, 766, 786, 806, 826, 856, 886, 966, 986, 1026, 1066, 1086, 1206, 1256, 1456, 1466, 1468, 1486, 1566, 1568, 1586, 3088, 3288, 3388, 3488, 3588, 3688, 3788, 5088, 5288, 5488, 6388, 6788, Hydro 86, Hydro 186	PTO Separator Plate 4.07" ID, 5.30" OD Replaces 1277392C1, 1997688C1	AM381489R3	\$ 4.00	
06, 56, 66, 68 & 86 Series	PTO Housing Cover	AM64785C92	\$ 576.16	
706, 756, 766, 786, 806, 826, 856, 886, 966, 986, 1026, 1066, 1086, 1086, 3088, 3288, 3388, 3488, 3688, 5088, 5288, 5488, 6388, Hydro 100, Hydro 186, Farmall: 706, 756, 806, 826, Ind: 2706, 2756, 2806, 2826, 2856, 21026	PTO Idler Shaft	AM381507R1	\$ 40.00	
706, 756, 766, 786, 806, 826, 856, 886, 966, 986, 1026, 1066, 1086, 3088, 3288, 3388, 3488, 3688, 5088, 5288, 5488, 3388, Ind: 2706, 2756, 2806, 2826, 2856, 21026 - w/ Dual Speed PTO - All w/ Dual Speed PTO	PTO Idler Gear Thrust Washer	AM381508R1	\$ 30.00	
706, 756, 766, 786, 806, 826, 856, 886, 966, 986, 1026, 1066, 1086, 3088, 3288, 3388, 3488, 3688, 5088, 5288, 5488, 3388, Ind: 2706, 2756, 2806, 2826, 2856, 21026	PTO Shaft Seal Backup Washer For Independent PTO Shaft, 540 RPM on Dual Speed PTO	AM393211R1	\$ 15.00	
706, 756, 766, 786, 806, 826, 856, 886, 966, 986, 1026, 1066, 1086, 1486, 3088, 3288, 3388, 3488, 3688, 5088, 5288, 5488, 6388, Hydro 100, Hydro 186, Ind: 2706, 2756, 2806, 2826, 2856, 21026, Farmall®: 706, 756, 806, 826	PTO Gear, Driven	AM381506R1	\$ 375.00	
706, 756, 766, 786, 806, 826, 856, 886, 966, 986, 1026, 1066, 1086, 3088, 3288, 3388, 3488, 3688, 5088, 5288, 5488, 6388, Hydro 100, Hydro 186, Ind: 2706, 2756, 2806, 2826, 2856, 21026, Farmall®: 706, 756, 806, 826	PTO Gear, Idler 27 Tooth	AM381509R1	\$ 195.00	
3088, 3288, 3388, 3488, 3588, 3688, 3788, 5088, 5288, 5488, 6388, 6588, 6788, 7288, 7488	PTO Clutch Piston	AM68080C2	\$ 100.00	
3088, 3288, 3488, 3688, 6388, 6588, 6788	PTO Control Cable	AM130566C1	\$ 79.84	
5088, 5288, 5488	PTO Control Cable 50.50" Long	AM143961C1	\$ 102.17	

Prices Subject to Change without Prior Notice. The use of original equipment manufacturer (OEM) part numbers or trademarks, e.g. Case® and John Deere®, are for reference purposes only and for indicating product use and compatibility. Our company and the listed replacement parts contained herein are not sponsored, approved or manufactured by the OEM. All parts are New unless designated Reman in the description.

International®—Tractor

Application	Description	Part Number	Retail Price	Core
706, 756, 766, 806, 826, 856, 886 BSN 17000, 966, 986 BSN 23999, 1026, 1066, 1086 BSN 48000, 1206, 1256, 1456, 1466, 1468, 1486 BSN 26000, 3388 BSN 10385, 3788, Hydro 100, Hydro 1066, Ind: 2706, 2756, 2806, 2856, 21026, 21206, 21256, 21456	PTO Gasket & Seal Kit Includes Pistons	AM77721C92	\$ 95.00	
786, 886 ASN 17000, 986 ASN 24000, 1086 ASN 48000, 1486 ASN 26000, 1566, 1568, 1586, 3088, 3288, 3388 ASN 10385, 3488 Hydro, 3588, 3688, 6388, 6588, 6788, Hydro 186	PTO Gasket & Seal Kit	AM77720C93	\$ 51.25	
(544, 656, 664, 666, 686, 756, 1456, 1466, 1468, 1486, 1566, 1568, 1586, 3588, 3788, 6588, 6788, 7288, 7488, Hydro 70, Hydro 86 - w/ Single Speed PTO), (706, 756, 806, 826, 856, 1026, 5088, 5288, 5488 - w/ Single Speed or Dual Speed PTO), (766, 786, 886, 966, 986, 1066, 1086, 3088, 3288, 3388, 3488, 3688, 4100, 4156, 4166, 4186, 6388, Hydro 100, Hydro 186 - w/ Dual Speed PTO), Ind: (2544, 2656, 21206, 21256, 21456 - w/ Single Speed PTO), (2706, 2806, 2826, 2856, 21026 - w/ Single Speed or Dual Speed PTO), 2756 w/ Dual Speed PTO	PTO Clutch Cup Seal Ring	AM381485R1	\$ 6.00	
(544, 656, 664, 666, 686, 756, 1456, 1466, 1468, 1486, 1566, 1568, 1586, 4100, 4156, 4166, 4186, 3588, 3788, 6588, 6788, 7288, 7488, Hydro 70, Hydro 86 - w/ Single Speed PTO), (766, 786, 886, 966, 986, 1066, 1086, 3088, 3288, 3388, 3488, 3688, 6388, Hydro 100, Hydro 186 - w/ Dual Speed PTO), (826, 856, 1026, 5088, 5288, 5488 - w/ Single Speed or Dual Speed PTO), Ind: (2544, 2656, 2756, 21456 - w/ Single Speed PTO), (2826, 21026 - w/ Single Speed or Dual Speed PTO), 2856 w/ Dual Speed PTO	PTO Clutch Housing Gasket	AM529565R1	\$ 10.00	
706, 756, 766, 786, 806, 826, 856, 886, 966, 986, 1026, 1066, 1086, 1486, 3088, 3288, 3388, 3488, 3688, 3688HC, 5088, 5288, 5488, 6388, Hydro 100, Hydro 186, Ind: 2706, 2756, 2806, 2826, 2856, 21026, Farmall®: 706, 756, 806, 826	Spacer For Independent PTO Output Shaft, 540 RPM	AM381505R1	\$ 26.00	
4100, 4156, 4166, 4186	Bearing Seal For PTO Output Shaft	AM380182R91	\$ 14.00	



PTO Shields

Application	Description	Part Number	Retail Price	Core
200, 230 Gas, 240, Super A, Super A-1, Super AV, Super AV-1, C, Super C	PTO Shield w/ Belt Pulley	AM55398DB	\$ 70.00	
H, HV, Super H, Super HV	PTO Shield	AM66387DBX	\$ 113.00	
504, 560, 606 Gas, 660, Ind: 2504, 2606, Farmall®: 504, 560	PTO Shield	AM364712R21	\$ 63.52	
786, 886, 986, 1086, 3088, 3288, 3388, 3488, 3688, 5088, 5288, 5488, 6388, Hydro 100	PTO Shield Primer Coated, Ready for Paint	AM1264503C1	\$ 61.55	
786, 886, 986, 1086, 3088, 3288, 3388, 3488, 3688, 5088, 5288, 5488, 6388, Hydro 100	PTO Shield	AM1264520C1	\$ 34.93	



Ring Gears and Pinions

Application	Description	Part Number	Retail Price	Core
706, 756, 766, 786, 806, 826, 856, 886, 966, 986, 1066, 1086, 1206, 1256, 1456, 1468, 1486, 3088, 3288, 3388, 3588, 3688	Ring Gear and Pinion Set Requires late style bearing and bearing retainer, See AM528684KIT	AM528707R93	\$ 625.00	
	Bearing and Retainer Kit Bearing and Retainer Kit for use w/ AM528707R93 Ring and Pinion Set Contains late style bearing and bearing retainer	AM528684KIT	\$ 960.00	

Planetary Gears

Application	Description	Part Number	Retail Price	Core
5088, 5288, 7288	Planetary Gear, 27 Tooth	AM1251840C1	\$ 143.52	

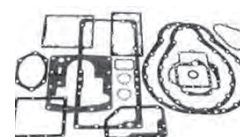

Differentials and Components

Application	Description	Part Number	Retail Price	Core
706, 756, 766, 786, 806, 826, 856, 886, 966, 986, 1026, 1066, 1086, 1206, 1256, 1456, 1466, 1468, 1486, 1566, 1568, 1586, 3088, 3288, 3388, 3488, 3588, 3688, 3788, 6388, 6588, 6788	Rear End Overhaul Gasket Set	AM386683	\$ 160.00	



Wheel Wedges and Components

Application	Description	Part Number	Retail Price	Core
706, 756, 766, 806, 856, 966, 1066, 3088, 3388, 3488, 3588, 3688, Hydro 100, Hydro 186	Wheel Wedges For 3 1/4" Axles	AM1287801C91	\$ 120.00	
1086, 1456, 1466, 1486	Wheel Wedges For 3 1/2" Axles	AM1287802C92	\$ 120.00	
706, 756, 766, 786, 806, 826, 966, 986, 1026, 1066, 1456, 1466, 3088, 3288, 3488, 3688, 6788, Hydro 100, Hydro 186	Wedge Bolt HD 78NF Thread	AM223312	\$ 61.27	



Brakes and Components

Application	Description	Part Number	Retail Price	Core
706, 756, 766, 806, 826, 856, 966, 1026, 1066, Hydro 100	Brake Kit Includes (1) Brake Piston Assembly, (2) Bonded Brake Disc, (1) Brake Piston Inner O-Ring, (1) Brake Piston Outer O-Ring, (1) O-Ring, (1) Brake Shaft Outer Seal and (4) Brake Piston Return Spring Replaces 384367R2, 1975468C2, 2385236	AM384166KIT	\$ 204.54	
5088, 5288, 5488	Brake Plate Kit	AM1264581C91	\$ 775.00	
	Components:			
	Brake Disc	8 AM120488C2	\$ 60.00	
	Brake Plate, Separator	8 AM120486C1	\$ 35.00	
	Brake Return Adjuster Plate	2 AM139189C1	\$ 44.00	

International®—Tractor

Application	Description	Part Number	Retail Price	Core
200, 230, 240, 330, 340, 404, Super C, Ind: 2404	Brake Disc, Bonded 10 Spline, 2.75" ID, 5" OD Replaces 356071R91, 368181R92	AM1975456C2	\$ 9.50	
284 Gas BSN 009036	Brake Disc 16 Spline, 2.015" ID, 7.875" OD	AM973625C2	\$ 112.48	
300, 350, H ASN 391356, Super H, Super W4	Brake Disc, Bonded 10 Spline, 3.375" ID, 5.625" OD Replaces 1975457C3, 368183R91, 358195R91	AM1975457C2	\$ 13.00	
340D, 460, 504, 606, Ind: 2504, 2606	Brake Disc, Bonded 10 Spline, 3.125" ID, 6" OD Replaces 368292R92	AM1975460C2	\$ 12.00	
340, 460, 504, 606, Ind/Utility: 330 Diesel, 2504, 2606, Farmall®: 340 Diesel	Brake Actuating Assembly	AM368293R91	\$ 259.49	
354, 364, 384, 424, 444, 2300, (3414, 3444 - Late), Ind: 2424, 2444	Brake Disc, Bonded 10 Spline, 3.50" ID, 6.50" OD Replaces 395161R1	AM1975464C2	\$ 15.00	
385, 395, 484, 485, 495, 584, 585, 595, 684, 685, 695, 784, 884, 885, 895, Hydro 84	Brake Disc 15 Spline, 10.19" OD (2) Required Brake Plate 8.12" ID, 10.20" OD (2) Required	AM114622C2 AM399736R3	\$ 100.00 \$ 80.00	
400, 450	Brake Actuating Assembly	AM366182R93	\$ 262.18	
400, 450, M, Super M, Super MTA, W6, Super W6, WD6	Brake Disc, Bonded 12 Spline, 3.50" ID, 6.50" OD Replaces 121961C92, 321162R91, 351117R91, 368179R91, 1963810C1	AM1963810C2	\$ 16.00	
560, 660	Brake Disc, Bonded 12 Spline, 4" ID, 7.125" OD Replaces 121963C91, 369079R92 Brake Actuating Assembly Brake Housing	AM1975446C2 AM369080R91 AM369065R3	\$ 16.00 \$ 294.93 \$ 246.45	
656, 664, 666, 685, Hydro 70, Hydro 86, Ind: 2656	Brake Disc, Bonded 10 Spline, 3.50" ID, 6.50" OD Replaces 391445R91	AM1975463C2	\$ 15.00	
656, 664, (666, 686 - w/ Gear Drive), Hydro 70, Hydro 86, Ind: 2656	Brake Actuating Assembly	AM391446R91	\$ 232.38	
(706 Farmall ASN 29001 & International® ASN 4601), 756, 766, (806 Farmall® ASN 23001 & International® ASN 5701), 826, 856, 966, 1026, 1066, 1206, 1256, Hydro 100, Ind: (2706 Farmall® ASN 29001 & International® ASN 4601), 2756, (2806 Farmall® ASN 23001 & International® ASN 5701), 2826, 2856, 21026, 21256	Intermediate Brake Plate	AM392777R2	\$ 35.00	
706, 756, 766, 806, 826, 856, 966, 1026, 1066, Hydro 100, Ind: 2706, 2756, 2806, 2826	Brake Disc, Bonded 12 Spline, 5" ID, 8" OD	AM1975468C2	\$ 20.00	
706, 756, 766, 806, 826, 856, 966, 1026, 1066, 1206, 1256	Seal Kit Use w/ AM1975468C2 Disc Kit Includes O-Rings and Lip Type Seal for Bull Pinion Shaft Complete Kit for One Side of Tractor	AM66487C91	\$ 19.84	
756, 766, 786, 826, 856, 886, 966, 986, 1026, 1066, 1086, 1466, 1468, 1486, 3088, 3288, 3388, 3488, 3588, 3688, 3788, 4386, 4586, 6388, 6588, 6788, Hydro 100, Hydro 186, Ind: 2756, 2826, 2856, 21026	Brake Piston Housing O-Ring	AM530789R1	\$ 8.00	
756, 766, 826, 856, 966, 1026, 1066, 1256, Hydro 100, Ind: 2756, 2826, 2856, 21026, 21256	Primary Brake Plate	AM527444R1	\$ 55.00	

International®—Tractor

Application	Description	Part Number	Retail Price	Core
786, 886, 986, 1086, 1486, 3088, 3288, 3388, 3488 Hydro, 3588, 3688, 3788, 6388, 6588, 6788, Hydro 186	Wet Brake Disc Kit Includes (6) Fiber Plates, (7) Steel Plates and (3) O-Rings Complete Kit for One Side of Tractor Replaces 120235C93	AM120235C94	\$ 145.00	
	Wet Brake Disc, Fiber (6) Required per Side Replaces 104712C1, 104712C2	AM104712C21	\$ 18.00	
	Wet Brake Disc, Steel (7) Required per Side	AM104713C21	\$ 12.00	
	O-Ring Kit Use w/ AM120235C94 Complete Kit for One Side of Tractor	AM120235ORK	\$ 11.00	
786, 886, 986, 3088, 3288, 3388, 3488, 3588, 3688, 3788, 6388, 6588, 6788, Hydro 186	Brake Piston	AM104655C1	\$ 113.73	
1086, 1486, 4386 ASN 1501, 4586	Brake Piston	AM104656C1	\$ 142.40	
1456, 1466, 1468	Brake Disc 12 Spline, 2.1875" ID, 11.375" OD Replaces 528702R2	AM1975472C1	\$ 47.00	
1466, 1468	Primary Brake Plate, Right Hand	AM537119R1	\$ 211.05	
	Primary Brake Plate, Left Hand	AM537120R1	\$ 262.43	
1466, 1468	Intermediate Brake Plate	AM537124R1	\$ 207.47	
5088, 5288, 5488, 7288, 7488	Brake Piston	AM120490C1	\$ 128.95	
H, HV	Brake Band	AM58344DCX	\$ 43.00	
M, MD, MDV Hi-Clearance, MV Hi-Clearance	Lined Brake Band	AM58345DCX	\$ 45.00	

Brake Pinion Shafts



Application	Description	Part Number	Retail Price	Core
(1086, 1486, 3688, 3788, (4386, 4586 Front Differential ASN 1501)	Brake Pinion Shaft w/o Differential Lock	AM104657C1	\$ 549.79	
1086, 1486, 4386 ASN 1642, 4586 ASN 1501	Brake Pinion Shaft, Right Hand w/ Differential Lock	AM104680C1	\$ 636.85	
1086, 1486, 4386 ASN 1642, 4586 ASN 1501	Brake Pinion Shaft, Left Hand w/ Differential Lock	AM104676C1	\$ 679.96	
1456, 1466, 1468, 4568	Brake Pinion Shaft w/o Differential Lock	AM528709R2	\$ 200.00	

Drawbars and Components



Application	Description	Part Number	Retail Price	Core
354, 364, 384, 424, 444, Ind: 2300A	Drawbar 2.375" x 1.187" x 35.75" w/ 2.125" Offset, (1) 1.18" Diameter Hole: 1.312" from Front	AM3111194R1	\$ 184.47	
385, 395, 454, 464, 485, 495, 574, 585, 595, 674, 684, 685, 885, 895, 2400, 2500	Drawbar 38" x 2.25" x 1.375", (4) 1.008" Diameter Holes at 1.20", 3.20", 4.90" & 6.90" from Front	AM406467SPL	\$ 141.50	
544, 656, 666, 686, Hydro 70, Hydro 86	Drawbar Stub, Standard Duty 2.50" x 1.50" x 26.25", (2) 1.04" Diameter Holes: 6.39" & 8.39" from Front	AM389099R1	\$ 115.00	
706, 756, 766, 786, 806, 826, 856, 886, 966, 986, 1026, 1066, 1086, 1206, 1256, 1456, 1466, 1486, 1566, 1586	Drawbar, HD 2.75" x 1.50" x 56.00", (1) 1.385" Diameter Hole: 1.50" from Front	AM223351	\$ 165.00	

International®—Tractor

Application	Description	Part Number	Retail Price	Core
706, 756, 766, 786, 806, 826, 856, 886, 966, 986, 1026, 1066, 1086, 1206, 1256, 1456, 1466, 1486, 1566, 1586	Drawbar, HD 3.00" x 1.50" x 62.25" w/ Hammer Strap Holes, (3) 1.39" Diameter Holes: 1.75", 5.937" & 15.312" from Front	AM223353	\$ 215.00	
706, 756, 766, 786, 806, 826, 856, 886, 966, 986, 1026, 1066, 1086, 1206, 1256, 1456, 1466, 1486, 1566, 1586	Drawbar 2.75" x 1.50" x 58.125", (1) 1.39" Diameter Hole: 1.875" from Front	AM223352	\$ 280.00	
706, 756, 766 BSN 13892, 806, 826, 856, 966 BSN 270896, 1026	Drawbar, Standard Duty 2.50" x 1.50" x 45.75", (2) 1.165" Diameter Holes: 1.50" & 10.50" from Front Can also replace 2-Piece Drawbar & Tube Replaces 393150R1	AM381706R2	\$ 130.00	
706 ASN 19250 w/ 3-Point Hitch, (756, 766, 826, 1026 BSN 13892), 806 SN 14500-23000 w/ 3-Point Hitch, 966 BSN 270896	Drawbar Stub, Standard Duty 2.50" x 1.50" x 26.25", (1) 1.04" Diameter Hole: 10.50" from Front	AM397065R1	\$ 87.00	
(766, 1206, 1256, 1456 ASN 13892), 966 ASN 270897	Drawbar, Standard Duty 2.50" x 1.50" x 38.75", (2) 1.04" Diameter Holes: 22.50" & 28" from Front	AM397066R1	\$ 135.00	
5088	Drawbar, Offset 3" x 1.50" x 58.50" w/ 2.25" Offset	AM142617C4	\$ 255.00	
5288, 5488	Drawbar, Straight 3" x 1.50" x 60.50"	AM142616C2	\$ 235.00	
H, Super H	Drawbar, Offset 0.75" x 50.50"	AM357530R1	\$ 216.45	
1066	Rear Drawbar 38.75" x 2.50" x 1.50", (4) Holes at 1.50" (1.145" Diameter), 5.51" (0.687" Diameter), 6.92" (0.656" Diameter), 14.12" (1.031" Diameter) from End	AM535799R1	\$ 184.00	
385, 454, 464, 485, 495, 574, 585, 595, 674, 684, 685, 695, 884, 885, 895, Ind: 2400A, 2500A	Drawbar Support	AM406468R31	\$ 148.63	
544, 656, 666, 686, Hydro 70, Hydro 86 - w/ 3-Point Hitch	Drawbar Support	AM389360R1	\$ 402.53	
706, 756, 766, 806, 826, 856, 966, 1026 - w/ Fast Hitch	Drawbar Support	AM389064R1	\$ 290.00	
706, 756, 806, 826, 856, 866, 966, 1026	Drawbar Support For 1-Piece Drawbar	AM383385R3	\$ 273.61	
756, 766, 806, 856, 966, 1026, 1066	Drawbar Support Replaces 539749R1	AM539749R91	\$ 340.43	
706, 756, 766, 806, 826, 856, 966, 1026, 1066	Drawbar Support Plate Use w/ 1-Piece or Heavy Duty Drawbar	AM400714R1	\$ 125.10	
706 ASN 19250 w/ 3-Point Hitch, (756, 766, 826, 1026 BSN 13892), 806 SN 14500-23000 w/ 3-Point Hitch, (856 w/ 2-Point or 3-Point Hitch and Diesel Custom ASN 21116), 966 BSN 270896	Drawbar Tube Assembly 34.875" Long	AM393501R11	\$ 377.16	
1066, 1206, 1256, 1456, 1466, 1468	Drawbar Tube Assembly 47.50" Long	AM391988R91	\$ 449.74	
544, 656, 664, 666, 686, Hydro 70, Hydro 86	Drawbar Tube, Front 25.50" Long	AM389100R11	\$ 289.82	
756, 766, 806, 826, 1026, 1066, 1206, 1256, 1456, 1466, 1468, 1566, 1568, Ind: 2756, 2806, 2826, 2856, 21026, 21256, 21456	Drawbar Pin, Front 1" x 3 3/4" Pin w/ Head For 2-Piece Drawbar	AM389428R1	\$ 25.30	





International®—Tractor



Hammer Straps





Application	Description	Part Number	Retail Price	Core
766, 786, 856, 886, 966, 986, 1026, 1066, 1086, 1466, 1468, 1486, 3088, 3288, 3388, 3488, 3588, 3688, 3788, 5088, 6388, 6588, 6788, Hydro 100, Hydro 186, Ind: 2856, 21026	Drawbar Hammer Strap Pin Hole 5.50" from Bend in Strap 5" Center-to-Center Mounting Holes Requires AM368514R1 Spacer	AM400297R1	\$ 190.00	
	Spacer Use w/ AM400297R1 Hammer Strap	AM368514R1	\$ 10.00	

Lift Link Assemblies and Components







Application	Description	Part Number	Retail Price	Core
300, 330, 340, 350, 400, 460, 560, 606, 660	Lift Link Assembly, Left Hand Can be used as Right Hand if the Duckhead Pivot Assembly is flipped over For 2-Point Fast Hitch Also Includes Leveling Screw and Duckhead Pivot Assembly	AM223305	\$ 195.16	
 (395, 495 - w/ Flange Type Rear Axle), (584, 585, 595, 685, 695, 784, 884, 885, 895, 995 - w/ Telescopic Lower Links)	Lift Link Assembly, Right Hand - Cat II 18.125" Screw, 14.50" Fork	AM223323	\$ 95.00	
 454, 464, 484, 485, 495, 574, 584, 585, 595, 674	Lift Link Assembly, Right Hand - Cat I 14.375" Screw, 14.50" Fork	AM223320	\$ 130.00	
 454, 464, 484, 574, 584, 595, 674, 684, 784, 884, 895, 995	Lift Link Assembly, Right Hand - Cat II 15.875" Screw, 14.50" Fork	AM223321	\$ 130.00	
544, 656, 666, 686, Hydro 70, Hydro 86	Lift Link Assembly, Right or Left Hand	AM223306	\$ 208.30	
 584, 674, 784, 884, (585, 595, 685, 695, 885, 895, 995 - w/ Bar Type Rear Axle)	Lift Link Assembly, Right Hand - Cat II 16.625" Screw, 14.50" Fork	AM223322	\$ 130.00	
706, 756, 766, 806, 826, 966	Lift Link Assembly Right or Left Hand, w/ 3-Point Hitch 11.75" Long	AM223308	\$ 192.57	
Components:				
	Leveling Screw Housing	1 AM395142R1	\$ 98.86	
	Leveling Screw Pivot Assembly	1 AM223315	\$ 69.74	
	Hitch Leveling Screw	1 AM382165R11	\$ 70.00	
	Crank Handle	1 AM523861R2	\$ 9.00	
706, 756, 766, 806, 826, 966, 1066	Lift Link Assembly Right or Left Hand, w/ 2-Point Fast Hitch	AM223307	\$ 168.62	
Components:				
	Leveling Screw Housing	1 AM395142R1	\$ 98.86	
	Leveling Screw Pivot Assembly	1 AM223315	\$ 69.74	
	Hitch Leveling Screw	1 AM389542R1	\$ 40.00	
	Crank Handle	1 AM523861R2	\$ 9.00	
 756, 766, 826, 856, 966, 1206, Hydro 100	Lift Link Assembly, Left Hand - Cat II	AM223309	\$ 170.00	
Components:				
	Hitch Leveling Screw Assembly	1 AM397095R2	\$ 52.00	
	Leveling Screw Housing	1 AM396752R1	\$ 57.99	
	Crank Handle	1 AM523861R2	\$ 9.00	

Prices Subject to Change without Prior Notice. The use of original equipment manufacturer (OEM) part numbers or trademarks, e.g. Case® and John Deere®, are for reference purposes only and for indicating product use and compatibility. Our company and the listed replacement parts contained herein are not sponsored, approved or manufactured by the OEM. All parts are New unless designated Reman in the description.











International®—Tractor

	Application	Description	Part Number	Retail Price	Core
	756, 766, 826, 856, 966, 1206, Hydro 100	Lift Link Assembly, Right Hand - Cat II	AM223310	\$ 200.00	
		Components:			
		Hitch Leveling Screw Assembly	1 AM397096R2	\$ 55.00	
		Leveling Screw Housing	1 AM396752R1	\$ 57.99	
		Crank Handle	1 AM523861R2	\$ 9.00	
	5088, 5288, 5488	Lift Link Assembly - Cat III Center Casting Measures 17" Replaces 1272944C2	AMX741019	\$ 250.00	
		Components:			
		Leveling Screw Housing	1 AM149836C4	\$ 135.00	
		Upper Adj. Lift Link	1 AMX741023	\$ 135.00	
		Lower Adj. Lift Link	1 AM149837C1	\$ 65.00	
		Turnbuckle Lock	1 AM123464C3	\$ 8.00	
	474, 574, 674, Ind: 2500A	Lift Link Screw w/ Bevel Gear	AM69992C91	\$ 21.00	
	5088, 5288, 5488	Lift Link, Upper Adjustment Screw 11.50" Long, 1.25"-7 Right Hand Screw Thread	AM149838C1	\$ 50.00	
	300, 330, 340, 350, 400, 450, 460, 504, 560, 606, 660, Ind: 2504, 2606	Leveling Screw Housing 11.50" Long	AM522819R1	\$ 84.79	
	574, 584, (585, 595, 685, 695, 885, 995 - w/ Bar Axle), 674, 684, 784, 884	Hitch Leveling Screw 18.125" Long, 0.875" Diameter Replaces 3116725R91	AM69993C91	\$ 77.74	
	385, 395, 454, 464, 474, 484, 485, 495, 584, 585, 595, 684, 685, 695, 784, 785, 795, 884, 885, 895	Adjusting Rod Nut, Lift Link	AM527937R1	\$ 6.00	

Three Point Hitch Components

	Application	Description	Part Number	Retail Price	Core
	544, 656, 666, 686, Hydro 70, Hydro 86	Hitch Leveling Screw 25.50" Long, 1" Diameter w/ 6" of threads	AM389542R1	\$ 40.00	
	706, 806 - w/ Three Point Hitch	Hitch Leveling Screw 27" Long, 1" Diameter w/ 5" of threads	AM382165R11	\$ 70.00	
	786, 886, 986, 1086, 1486, 1566, 1568, 1586, 3088, 3288, 3388, 3488 Hydro, 3588, 3688, 3788, 6388, 6588, 6788, Hydro 186	Lift Link Upper Adjustment Screw 10" Long, 1.25"-7 Right Hand Thread	AM108584C1	\$ 80.64	
	786, 886, 986, 1086, 1486, 1566, 1568, 1586, 3088, 3288, 3388, 3488 Hydro, 3588, 3688, 3788, 6388, 6588, 6788, Hydro 186	Lift Link Lower Adjustment Screw 12" Long, w/ 1.25"-7 Left Hand Thread	AM108583C1	\$ 118.26	
	756, 766, 826, 856, 966, 1026, 1206, Hydro 100	Hitch Leveling Screw Assembly 22.50" Long, 1.125" Diameter, Right Hand Thread	AM397096R2	\$ 55.00	
		Hitch Leveling Screw Assembly 22.50" Long, 1.125" Diameter, Left Hand Thread	AM397095R2	\$ 52.00	
	544, 656, 664, 666, 686, Hydro 70 - w/ 2-Point or 3-Point Hitch	Leveling Screw Housing 16.75" Long Use w/ AM389542R1	AM538970R1	\$ 70.00	
	706, 806, 756, 766, 966, 1066	Leveling Screw Housing 11.75" Long Use w/ AM382165R1	AM395142R1	\$ 98.86	

International®—Tractor

	Application	Description	Part Number	Retail Price	Core
	706 Late, 756, 766, 806 Late, 826, 856, 966, 1026, 1206, Hydro 100	Leveling Screw Housing, Cat II 16.50" Long	AM396752R1	\$ 57.99	
	1026, 1206, 1256, 1456, 1066, 1466, 1468, 1566, Hydro 100	Leveling Screw Housing, Cat III 16.375" Long	AM398384R1	\$ 85.00	
	454, 464, 484, 574, 584, 674, 684, 784, 884	Leveling Screw Housing, Cat II 1 5/8" spacing between ears	AM402635R4	\$ 60.00	
	786, 886, 986, 1086, 1486, 1566, 1568, 1586, 3088, 3288, 3388, 3488 Hydro, 3588, 3688, 3788, 6388, 6588, 6788, Hydro 186	Leveling Screw Housing, Cat III 14.25" w/ 1.25" screw thread	AM72877C1	\$ 95.00	
	130, 140, 504, 544, 606, 644, 656, 664, 666, 686, 706, 756, 766, 806, 826, 856, 966, 1026, 1066, 1206, 1256, 1466, 1468, 1566, 1568, Hydro 70, Hydro 86, Hydro 100, Ind: 2504, 2606, 2706, 2806	Leveling Screw Pivot Assembly For 1" Shaft Includes Pivot Assembly, Collar w/ Set Screws, Hardened Washer and Weld-On Washer	AM223315	\$ 69.74	
	385, 395, 454, 464, 484, 485, 495	Lift Arm Assembly	AM223317	\$ 82.00	
	656, 666, 686, 706, 756, 766, 786, 806, 826, 856, 886, 986, 1026, 1066, 1086, 1206, 1256	Lift Arm Latch, Cat II	AM398373R1	\$ 27.46	
	986, 1066, 1086, 1206, 1256, 1456, 1466, 1468, 1486, 1566, 1568, 1586, 3088, 3288, 3388, 3488, 3588, 3688, 3788, 5088, 5288, 5488, 6388, 6588, 6788, 7288, 7488, Ind: 21206, 21256, 21456	Lift Arm Latch, Cat III	AM398399R1	\$ 25.41	
	06 & 56 Series - w/ Fast Hitch	Lift Arm Latch	AM393500R1	\$ 31.44	
	300, 330, 340, 400, 544, 560, 606, 656, 660, 666, 686, 706, 756, 766, 806, 826, 856, 966, 1066, 1206, Hydro 70, Hydro 86, Hydro 100, Ind: 2606	Crank Handle	AM523861R2	\$ 9.00	
	706, 756, 766, 786, 806, 826, 856, 886, 966, 986, 1026, 3088, 3288, 3488 Hydro, 3688, Hydro 100, Hydro 186, Ind: 2706, 2756, 2806, 2826, 2856	Stabilizer Control Arm	AM382386R2	\$ 222.61	
	706, 756, 766, 806, 826, 856, 966, 1026, 1066, 1206, Hydro 100	Pivot Pin Use w/ AM382386R2 Stabilizer Control Arm	AM383362R2	\$ 36.37	
	544, 656, 664, 666, 686, 706, 756, 766, 786, 806, 826, 856, 886, 966, 986, 1026, 3088, 3288, 3488 Hydro, 3688, Hydro 70, Hydro 86, Hydro 100, Hydro 186, Ind: 2544, 2656, 2706, 2756, 2806, 2826, 2856, 21026	Front Stabilizer Eyebolt	AM382390R1	\$ 34.21	
	706, 756, 766, 786, 806, 826, 856, 886, 966, 986, 1026, 1066, 1206, 3088, 3288, 3488 Hydro, 3688, Hydro 100, Hydro 186, Ind: 2706, 2756, 2806, 2826, 2856	Rear Stabilizer Eyebolt	AM382397R1	\$ 39.96	
	1066, 1086, 1206, 1256, 1456, 1466, 1468, 1486, 1566, 1568, 1586, 3388, 3588, 3788	Stabilizer Stud 1.25" Diameter	AM406247R1	\$ 32.37	
	385, 395, 454, 464, 484, 485, 495, 2400	Lift Link Upper Yoke 14.38" Long, 0.875" Diameter	AM527967R1	\$ 25.00	
	474, 574, 584, 595, 596XL, 674, 684, 685, 695, 784, 884, 895, Hydro 84, Ind: 2500A	Lift Link Upper Yoke 19.25" Long, 0.875" Diameter	AM527948R91	\$ 22.00	

Prices Subject to Change without Prior Notice. The use of original equipment manufacturer (OEM) part numbers or trademarks, e.g. Case® and John Deere®, are for reference purposes only and for indicating product use and compatibility. Our company and the listed replacement parts contained herein are not sponsored, approved or manufactured by the OEM. All parts are New unless designated Reman in the description.

International®—Tractor

Application	Description	Part Number	Retail Price	Core
1066, 1206, 1256, 1456, 1466, 1468	Lift Link Rod	AM398378R1	\$ 181.11	

Quick Hitches



Application	Description	Part Number	Retail Price	Core
Cat II	Quick Hitch, 4" x 6" Beam 36" Wide, Includes 1 1/8" Mounting Pins and Adapter Bushings	AMX741020	\$ 565.00	
Cat III	Quick Hitch, 4" x 6" Beam 38" Wide, Includes 1 7/16" Mounting Pins	AMX741022	\$ 565.00	
Cat III	Quick Hitch, 4" x 6" Beam 44" Wide, Includes 1 7/16" Mounting Pins	AMX741021	\$ 565.00	

Lower Lift Links



Application	Description	Part Number	Retail Price	Core
3088*, 3288*, 3388*, 3488*, 3588*, 3688*, 3788*, 5088*, 5288*, 5488* *AM1272681C1 Bushing is required when upgrading these models from Cat II to Cat III	Lower Lift Link, Cat III Rigid	Right Hand AM134318A2	\$ 425.00	
3088*, 3288*, 3388*, 3488*, 3588*, 3688*, 3788*, 5088*, 5288*, 5488* *AM1272681C1 Bushing is required when upgrading these models from Cat II to Cat III	Lower Lift Link, Cat III Adjustable	Left Hand AMX741017 (Not Available)		
Components:				
	Front Lift Link, Left Hand	1 AM130316A1	\$ 275.00	
	Latch	1 AM398399R1	\$ 25.41	
	Stiffner Latch Plate	2 AM382193R1	\$ 7.00	
	Spring Latch Plate	2 AM382192R1	\$ 5.00	
3088, 3288, 3388, 3488, 3588, 3688, 3788, 5088, 5288, 5488	Bushing, Cat II to Cat III Use w/ AM134318A2 Lift Arm to upgrade from Cat II to Cat III	AM1272681C1	\$ 35.00	

Toplink Assemblies



Application	Description	Part Number	Retail Price	Core
786, 886, 986, 3088, 3288, 3388, 3488, 3588, 3688 - w/ Lateral Type Hitch	Toplink Assembly, Cat II Also Includes Center Link Body	AM108632C93	\$ 175.00	
Components:				
	Center Link End - Front	1 AM395970R2	\$ 90.00	
	Center Link End - Rear	1 AM395968R2	\$ 90.00	
	Center Link Handle	1 AM108592C2	\$ 15.00	
1066, 1086, 1466, 1486, 1566 ASN 11256, 1568 ASN 7809, 1586, 3088, 3288, 3388, 3488, 3588, 3688, 3788, 5088, 5288, 5488, 6388, 6588, 6788	Toplink Assembly, Cat III Center Link Body has 1 3/4" Thread	AM1331855C3	\$ 225.00	
Components:				
	Center Link End - Front	1 AM1981988C1	\$ 125.00	
	Center Link End - Rear	1 AM1282082C2	\$ 110.00	
	Center Link Body	1 AM1954223C1	\$ 85.00	
	Center Link Handle	1 AM1331863C2	\$ 35.00	
544, 656, 666, 686, Hydro 70, Hydro 86	Toplink Bracket Replaces 389372R21	AM389372R41	\$ 187.33	
706, 806, 856, 966, 1206, 1256	Toplink Bracket	AM382212R41	\$ 152.91	

International®—Tractor

Application	Description	Part Number	Retail Price	Core
H186, 786, 886, 986, 1066, 1086, 1466, 1566, 1568, 1586, 3088, 3288, 3388, 3488, 3588, 3688, 3788, 5088, 5288, 5488, 6388, 6588, 6788, 7288, 7488	Turnbuckle Lock	AM123464C3	\$ 8.00	
1066, 1086, 1466, 1486, 1566 ASN 11256, 1568 ASN 7809, 1586, 3088, 3288, 3388, 3488, 3588, 3688, 3788, 5088, 5288, 5488, 6388, 6588, 6788	Toplink Handle Retainer	AMIHHR	\$ 0.75	

Sway Limiters



Application	Description	Part Number	Retail Price	Core
400, 450, 560, 660 - w/ Fast Hitch	Sway Limiter	AM522820R23	\$ 200.91	
544, 656, 664, 666, 686, Hydro 70, Hydro 86, Ind: 2544, 2656	Lateral Limiter Yoke 7 5/16" Long	AM400836R1	\$ 169.67	
	Sway Limiter Yoke	AM389369R1	\$ 58.02	
706, 756, 766, 786, 806, 826, 856, 886, 966, 986, 1026, 3088, 3288, 3488, 3688, Hydro 100, Hydro 186	Sway Limiter Lockout Pin	AM383363R11	\$ 15.59	
756, 766, 826, 856, 966, 1026, 1206, Hydro 100	Complete Sway Limiter Assembly w/ Pins	AM406242R2	\$ 70.00	
	Sway Limiter Yoke, 3" Long	AM406244R1	\$ 40.00	
	Sway Limiter Yoke, 7.25" Long	AM406243R2	\$ 40.00	
	Sway Limiter Stud, 8" Long, 1 1/8" Diameter	AM386198R1	\$ 32.00	
1066, 1086, 1206, 1256, 1456, 1466, 1468, 1486, 1566, 1568, 1586, 3388, 3588, 3788	Hitch Stabilizer Assembly	AM406250R1	\$ 141.74	
	Sway Limiter Yoke, Front 3.98" Long	AM406249R1	\$ 75.14	
	Eyebolt, Front Stabilizer	AM392185R1	\$ 19.63	
	Pivot Pin No Threads, Will Replace 392184R1 Threaded Pin Replaces 392184R1	AM67693C1	\$ 42.04	
1066, 1086, 1206, 1256, 1456, 1466, 1468, 1486, 1568, 1586, 3388, 3588, 3788	Yoke, Rear Stabilizer 6.125" Long	AM406248R2	\$ 76.57	
1066, 1086, 1206, 1256, 1466, 1468, 1486, 1566, 1568, 1586, 3388, 3588, 3788, Ind: 21206, 21256	Rear Stabilizer Eyebolt	AM392195R1	\$ 59.85	



Draft Sensing Parts

Application	Description	Part Number	Retail Price	Core
1206, 1256, 1456, 1066, 1466, 1468, 1566, 1568	Torque Tube Slotted Hole Style	AM392085R3	\$ 350.00	
	Crank Arm Slotted Hole Style	Left Hand AM392090R3	\$ 130.00	
1086, 1486, 1586, 3388, 3588, 3788	Torque Tube Round Hole Style	AM71386C1	\$ 390.00	
	Crank Arm Round Hole Style	Right Hand AM71389C1	\$ 275.00	
		Left Hand AM71388C1	\$ 275.00	

Battery Boxes and Components



Application	Description	Part Number	Retail Price	Core
(300, 350 - Gas), (400 Farmall, 450 Farmall - Gas or Diesel)	Battery Box w/ International® imprint on end	AM362059R92	\$ 130.00	

Prices Subject to Change without Prior Notice. The use of original equipment manufacturer (OEM) part numbers or trademarks, e.g. Case® and John Deere®, are for reference purposes only and for indicating product use and compatibility. Our company and the listed replacement parts contained herein are not sponsored, approved or manufactured by the OEM. All parts are New unless designated Reman in the description.

International®—Tractor

Application	Description	Part Number	Retail Price	Core
06, 56, 66 Series	Battery Box Cover	AM71717C91	\$ 20.00	
544, 656, 666, 686, Hydro 70, Hydro 86 Will Not Fit Utility Models	Battery Box Cover	AM538585R2	\$ 70.00	
06, 56, 66 Series - Gear Drive	Battery Box Tray	Right Hand AM399055R1	\$ 60.00	
	Battery Box Tray	Left Hand AM399048R1	\$ 60.00	
766, 856 w/ Diesel Engine BSN 9049, (966, 1066 - w/ Hydrostatic Drive), 1026, 1256 BSN 8450, 1456, Hydro 100, Farmall®: 856 w/ Diesel Engine BSN 19306, 1256 BSN 13175, 1456 - All w/o Cabs	Battery Box Tray	Right Hand AM399047R1	\$ 62.50	
	Battery Box Tray Replaces 399046R	Left Hand AM399046R2	\$ 62.50	

Decals

Application	Description	Part Number	Retail Price	Core
806	Decal Set, Hood	AMI806	\$ 36.97	
1566 Early	Decal Set, Hood	AMI1566	\$ 36.64	



Side Panels

Application	Description	Part Number	Retail Price	Core
1066, 1466, 1566, Hydro 100	Rear Heat Baffle	Right Hand AM531508R1	\$ 31.00	
		Left Hand AM531507R1	\$ 31.00	
504, 656, 706, 806, 1206	Side Emblem Includes Retaining Clips and Mounting Hardware	AM377796R1	\$ 87.00	
756, 826, 856, 1026, 1256, 1456	Side Emblem Restoration Quality Overall: 31" x 3" Includes Retaining Clips and Mounting Hardware	AM2753920R1	\$ 97.00	



Front Grilles, Nose Cones and Components

Application	Description	Part Number	Retail Price	Core
766, 786, 886, 966, 986, 1066, 1086, 1466, 1468, 1486, 1566, 1568, 1586	Grille, Steel	AM531231STL	\$ 110.00	
	Grille, Plastic	AM531231R1	\$ 110.00	
	Screen, Fits Behind Grille	AM531233R2	\$ 70.00	
766, 786, 886, 966, 986, 1086, 1466, 1468, 1486, 1566, 1568, 1586, Hydro 100, Hydro 186	Headlight Support	AM71780C1	\$ 75.00	
666, 686, 766, 786, 886, 966, 986, 1066, 1086, 1466, 1468, 1486, 1566, 1568, 1586, 4366, 4386, 4568, 4586, 4786, Hydro 70, Hydro 86, Hydro 100, Hydro 186	Hood Ornament Die Cast, Chrome Plated Includes Retaining Clips	AM538005R1	\$ 22.00	
240, 340, 404, 444, 460, 504, 544, 560, 606, 656, 660, 664, 706, 756, 826, Ind: 2544, 2606, 2656, 2706, 2756, 2826	Hood Ornament Die Cast, Chrome Plated Includes Mounting Screws	AM369180R1	\$ 65.00	

International®—Tractor

Application	Description	Part Number	Retail Price	Core
544, 656, 664, 706	Emblem Used on Front Grille Plastic Construction 2 Mounting Holes on Backside Overall: 3.625" x 4" Includes Mounting Hardware	AM2751848R1	\$ 18.00	
	Emblem Used on Front Grille Die Cast Construction Overall: 3.625" x 4" Includes Mounting Hardware	AM2751845R1	\$ 44.00	
756, 806, 826, 856, 1026, 1206, 1256, 1456	Emblem Used on Front Grille Die Cast Construction Overall: 3.625" x 4" Includes Stainless Steel Mounting Hardware	AM2751809R1	\$ 44.50	
756, 826, 856, 1026, 1206, 1256, 1456	Emblem Used on Front Grille and Cab Plastic Construction Overall: 3.625" x 4" Includes Mounting Hardware	AM2751847R1	\$ 18.00	
4156, 4166, 4186, 4366, 4386	Emblem Used on Cab Die Cast Construction Overall: 3.625" x 4" Includes Mounting Hardware	AM2751845R1	\$ 44.00	
	Emblem Used on Cab Plastic Construction 2 Mounting Holes on Backside Overall: 3.625" x 4" Includes Mounting Hardware	AM2751848R1	\$ 18.00	



Cowl (Dash) Covers

Application	Description	Part Number	Retail Price	Core
544, 656, 666, 686, Hydro 70, Hydro 86, Ind: 2544, 2656	Cowl Cover	Right Hand AM388737R1	\$ 123.34	
	Cowl Cover	Left Hand AM388736R1	\$ 138.37	



Fenders, Platforms and Components







Fenders are painted with a primer coat unless otherwise noted.

Application	Description	Part Number	Retail Price	Core
200, 230, Super C	Fender	Right or Left Hand	AM351248R92	\$ 185.00
	Primer Coated, Ready for Paint			
544, 656, 706, 756, 806, 826, 856, 1026, 1206, 1256, 1456	Fender	Right Hand	AM399329R2	\$ 275.00
	Two Headlight Opening	Left Hand	AM399328R2	\$ 275.00
	Restoration Quality			
	Primer Coated, Ready for Paint Includes Grommet			
666, 686, 766, 966, 1066, 1466, 1468, 1566, 1568, Hydro 70, Hydro 86, Hydro 100	Fender	Right Hand	AM533188R1	\$ 275.00
	Single Headlight Opening	Left Hand	AM533187R1	\$ 275.00
	Restoration Quality			
	Primer Coated, Ready for Paint Includes Grommet			
H, Super H, M, Super M, 300, 330, 350, 400, 450	Fender Clamshell style fender	Right or Left Hand	AM51500DB	\$ 125.00

International®—Tractor







Application	Description	Part Number	Retail Price	Core
656, 666, 686, 706, 756, 806, 826, 856, 966, 1026, 1066, 1256, 1456, 1466, 1566, 1568	Fender Mounting Bracket	Right Hand	AM399340R1	\$ 90.00
		Left Hand	AM399339R1	\$ 90.00
	Mounting Bracket U-Bolt		AM536670R1	\$ 10.00
766 1972-78, 966 1971 Only, 1066 1974-78, 1466 1972-77, 1468 1974-76, Hydro 100	Fender Bracket Channel Style	Right Hand	AM65118C1	\$ 165.00
		Left Hand	AM65117C1	\$ 165.00
504, 544, 656, 666, 686, 756, 766, 806, 826, 856, 966, 1026, 1066, 1206, 1256, 1456, 1466, 1468, 1566, 1568, Hydro 70, Hydro 86, Hydro 100	Grommet, Fender Handle 4.50" x 1.50" ID, 5.75" x 2.75" OD		AMR20759	\$ 8.00
766, 966, 1066, 1466, 1468, 1566, 1568, Hydro 100	Platform		AM534486R2	\$ 225.00
1066, 1466, 1468, 1566, 1568, 766, 966, Hydro 100	Front Platform Plate		AM534485R2	\$ 55.00
	Front Seat Cover Plate		AM398013R3	\$ 34.00
	Rear Seat Cover Plate		AM398015R2	\$ 34.00
766, 966, 1066, 1466, 1468, 1566, 1568, Hydro 100	Extension	Right Hand	AM534494R2	\$ 45.00
		Left Hand	AM534493R2	\$ 45.00
766, 966, 1066, 1466, 1468, 1566, 1568, Hydro 100	Angle Assembly, Front		AM406281R1	\$ 40.00

Steps







Application	Description	Part Number	Retail Price	Core
 706, 756, 766, 806, 826, 856, 966, 1026, 1066, 1456, 1466, 1566	Step	Right Hand	AM395123R1	\$ 58.00
		Left Hand	AM395230R1	\$ 58.00
 786, 886, 986, 1086, 1486, 1586, Hydro 186 For OEM Steps Only	Step Extension Kit Reduce step height from 24" to 15", Includes right and left hand side		AMX19106	\$ 100.00
 886, 986, 1086, 1486, 1586, 5088*, 5288*, 5488*, Hydro 186 *On these models the shroud must be cut to match	Step Kit 3 Steps, 15" Step Width, 9" Step Height	Right Hand	AMX19110	\$ 225.00
		Left Hand	AMX19108	\$ 225.00
 06, 26, 56 & 66 Series - w/o Cab	Step Kit 3 Steps, 10 3/8" Step Width, 19 1/2" Step Height Step Height w/ Handle is 48 1/8"		AMX19121	\$ 295.00
 06, 26, 56 & 66 Series - w/o Cab	4th Step Kit w/ Rubber Side Plate Can be added to AMX19121 to create 4th step		AMX19124	\$ 80.00
 06 & 66 Series - w/ Cab, Excluding Hiniker® Cabs	Step Kit 9" Step Height, 14.50" Step Width Includes (3) Steps, Side Plates, Mounting Brackets and Hardware	Left Hand	AMSS3347	\$ 553.00
86 Series, 88 Series, 2+2	Handrail	Right Hand	AMSS3325	\$ 73.00

International®—Tractor

Lighting

	Application	Description	Part Number	Retail Price	Core
	3088, 3288, 3488, 3688, 5088, 5288, 5488	LED Light Kit Includes (2) LED Headlights*, (2) LED Floodlights, (4) LED Sealed Round Lights**, Stainless Steel Mounting Hardware and Mounting Bracket For Models w/ Rectangle Light by Stairs For 12 Volt to 24 Volt Systems Plug-and-Play Installation *3500 Lumens, 60 Watts, 5 Amps ** 2200 Lumens, 24 Watts, 2 Amps	AMX34194	\$ 600.00	
	06, 56 & 66 Series - w/ Flat Top Fenders	Single Beam Headlight Assembly Wire Inside Stud	AM388945R91	\$ 30.00	
	395, 495, 595, 695, 895, 995	Headlight, Right Hand Includes Hardware Replaces 1964579C2, 1964881C1	AM1964881C2	\$ 127.00	
		Headlight, Left Hand Include Hardware Replaces 1964580C2, 1964882C1	AM1964882C2	\$ 127.00	
	664, 666, 686, 706, 756, 766, 786, 806, 826, 856, 886, 966, 986, 1026, 1066, 1086, 1206, 1256, 1456, 1466, 1468, 1486, 1566, 1568, 1586, 3088, 3288, 3388, 3488, 3514, 3588, 3616, 3688, 3788, 4100, 4156, 4166, 4186, 4300, 4366, 4386, 4568, 4586, 4786, 5088, 5288, 5488, 6388, 6588, 6788, 7288, 7388, 7488, Hydro 70, Hydro 86, Hydro 100, Hydro 186, Farmall® Row Crop: 504, 544, 656 Replaces 131508C1, 388945R91, 388946R91, 533063R91	LED Trapezoid Light Fender Mount 4.50" Sealed Beam Round Light 2800 Lumens, 40 Watts, 3.30 Amps For 12 Volt to 24 Volt Systems Rear Stud Mount w/ Built-In Heat Sink Includes Both Long and Short Rubber Bezels	AMTL2060	\$ 95.00	
		Headlight Sealed Beam, 12 Volt, 2-Wire	AMRE25126	\$ 45.00	
	Universal Equipment	LED Floodlight All-Position Light 4.25" x 4.25" Square Light 2650 Lumens, 48 Watts, 4 Amps For 12 Volt to 24 Volt Systems Includes Mounting Bracket and Stainless Steel Hardware	AMTL105F	\$ 95.00	
	Universal Equipment	LED Floodlight All-Position Light 6.25" x 1.75" Rectangle Light 1300 Lumens, 18 Watts, 1.50 Amps For 12 Volt to 24 Volt Systems Includes Mounting Bracket and Stainless Steel Hardware	AMTL118F	\$ 50.00	
	Universal Equipment	LED Floodlight All-Position Light 5" Round Light 3200 Lumens, 40 Watts, 3.30 Amps For 12 Volt to 24 Volt Systems Includes Mounting Bracket and Stainless Steel Hardware	AMTL180	\$ 89.00	

International®—Tractor





Application	Description	Part Number	Retail Price	Core
 Universal Equipment	LED Floodlight All-Position Light Round Light 6900 Lumens, 50 Watts, 4.10 Amps For 9 Volt to 32 Volt Systems Includes Mounting Bracket and Stainless Steel Hardware	AMTL500F	\$ 120.00	
	LED Floodlight All-Position Light 4.30" Round Light 5040 Lumens, 50 Watts, 4.10 Amps For 12 Volt to 24 Volt Systems Includes Stainless Steel Adjustable Mounting Bracket	AMAT305931	\$ 96.00	
 Universal Equipment	LED Floodlight All-Position Light 4.25" Round Light 2650 Lumens, 42 Watts, 3.50 Amps For 12 Volt to 24 Volt Systems Includes Mounting Bracket and Stainless Steel Hardware	AMTL115F	\$ 59.00	
 Universal Equipment	LED Wide Floodlight All-Position Light 5" x 7" Rectangle Light 3800 Lumens, 35 Watts For 12 Volt to 24 Volt Systems	AMX34171	\$ 60.00	
 Universal Equipment	LED Floodlight, Sealed Beam Fender Mount 4.50" Diameter Round Light 1250 Lumens, 18 Watts, 1.50 Amps Trapezoid Pattern For 12 Volt to 24 Volt Systems Replaces 131203C1, 373662R1, 373662R91	AMTL3010	\$ 40.00	
	LED Floodlight Fender Mount 4.50" Diameter Sealed Beam Round Light 1250 Lumens, 18 Watts, 1.20 Amps Trapezoid Pattern For 12 Volt to 24 Volt Systems Lasts 50 times longer than halogen lighting, vibration resistant w/ no filament failures, uses original mount and wiring, Operating temperature of -40°F to 140°F / -40°C to 60°C Replaces 131203C1, 373662R1, 373662R91	AMRE336111	\$ 35.00	
 Universal Equipment	LED Floodlight Fender Mount 4.50" Diameter Sealed Beam Round Light 1440 Lumens, 18 Watts, 1.60 Amps Lasts 50 times longer than halogen lighting, vibration resistant w/ no filament failures, 2-terminal connection, Operating temperature of -40°F to 140°F / -40°C to 60°C	AMRE336112	\$ 67.75	
 786, 806, 886, 966, 986, 1066, 1086, 1256, 1466, 1486, 1566, 1568	LED Floodlight Hood, Front and Rear Fender Mount 5" Diameter Round Light 2800 Lumens, 40 Watts, 3.30 Amps Trapezoid Pattern 1/2" rear stud mount w/ built-in heat sink for cooling, a brighter light and longer life, Includes both long and short rubber bezels, For use w/ stud mounted front fender lights	AMAR85859	\$ 90.00	

International®—Tractor





Application	Description	Part Number	Retail Price	Core
 3088, 3288, 3488, 3688, 5088, 5288, 5488	LED Floodlight Hood Mount 8.25" x 5.75" Rectangle Light 3500 Lumens, 60 Watts, 5 Amps For 12 Volt to 24 Volt Systems Uses Original Mount and Wiring Includes Mounting Bracket and Stainless Steel Hardware	AMTL2010	\$ 110.00	
	LED Floodlight Hood Mount 8.25" x 5.75" Rectangle Light 4500 Lumens, 60 Watts, 5 Amps For 12 Volt to 24 Volt Systems	AM131227C92	\$ 88.00	
 3088, 3288, 3488, 3688, 5088, 5288, 5488	LED Floodlight 4" x 6" Rectangle Light 3500 Lumens, 60 Watts, 5 Amps For 12 Volt to 24 Volt Systems Includes Stainless Steel Hardware Replaces 146479C1	AMTL2040	\$ 110.00	
 Universal Equipment	LED Floodlight Cab and Fender Mount 3.50" x 6" Rectangle Light 3600 Lumens, 40 Watts, 3 Amps	AMX34146	\$ 65.00	
 385, 485, 585, 685, 885	LED Floodlight/Spotlight Cab Mount 4" x 6.50" Rectangle Light Dual Hi/Lo Beam 3500 Lumens, 60 Watts, 5 Amps For 12 Volt to 24 Volt Systems Replaces 138225A1, 183162A1, 353657A1, 87367623	AMTL6090	\$ 99.00	
	LED Floodlight/Spotlight Cab Mount 4" x 6.50" Rectangle Light Dual Hi/Lo Beam 3500 Lumens, 60 Watts, 5 Amps For 12 Volt to 24 Volt Systems Replaces 138225A1, 183162A1, 353657A1	AM87367623	\$ 79.20	
 Universal Equipment	LED Spotlight All-Position Light 4.25" x 4.25" Square Light 1400 Lumens, 27 Watts, 2.20 Amps For 12 Volt to 24 Volt Systems	AMTL100S	\$ 45.00	
 Universal Equipment	LED Spotlight All-Position Light 6.25" x 1.75" Rectangle Light 1300 Lumens, 18 Watts, 1.50 Amps For 12 Volt to 24 Volt Systems Includes Mounting Bracket and Stainless Steel Hardware	AMTL118S	\$ 50.00	
 Universal Equipment	LED Spotlight All-Position Light Round Light 6900 Lumens, 50 Watts, 4.10 Amps For 9 Volt to 32 Volt Systems Includes Mounting Bracket and Stainless Steel Hardware	AMTL500S	\$ 120.00	
 544, 656, 666, 686, 706, 756, 766, 786, 806, 826, 856, 886, 966, 986, 1026, 1066, 1086, 1206, 1256, 1456, 1466, 1468, 1486, 1566, 1568, 1586, 3088, 3288, 3388, 3488, 3588, 3688, 3788, 5088, 5288, 5488	LED Trapezoid Light Fender Mount 4.50" Sealed Beam Round Light 2200 Lumens, 24 Watts, 2 Amps For 12 Volt to 24 Volt Systems Uses Original Mount and Wiring Replaces RE336111	AMTL3015	\$ 50.00	

Prices Subject to Change without Prior Notice. The use of original equipment manufacturer (OEM) part numbers or trademarks, e.g. Case® and John Deere®, are for reference purposes only and for indicating product use and compatibility. Our company and the listed replacement parts contained herein are not sponsored, approved or manufactured by the OEM. All parts are New unless designated Reman in the description.

International®—Tractor

	Application	Description	Part Number	Retail Price	Core
	Universal Equipment	LED Trapezoid Light Cab and Fender Mount 4.50" Diameter Round Light 2800 Lumens, 40 Watts, 3.30 Amps Trapezoid Pattern For 12 Volt to 24 Volt Systems Bottom Mount w/ Built-In Heat Sink Includes Mounting Bracket, Long and Short Rubber Bezels, and Stainless Steel Hardware Replaces 131368C92	AMTL2080	\$ 95.00	
		LED Trapezoid Light Cab and Rear Fender Mount 4.50" Diameter Round Light 2800 Lumens, 40 Watts, 3.30 Amps Trapezoid Pattern For 12 Volt to 24 Volt Systems Bottom Mount w/ Built-In Heat Sink Includes Mounting Bracket, Long and Short Rubber Bezels and Stainless Steel Hardware Replaces 131368C92	AMX33121	\$ 76.00	
	Universal Equipment	LED Warning Light Cab, Header or Swather Mount Can be used for Turn Signal, Brake or Running Lights 4.125" Diameter Round Light Double Sided, Amber Lenses 25 Bulbs per Side For 12 Volt to 24 Volt Systems	AMTLFL2	\$ 55.00	
		LED Warning Light Cab, Header or Swather Mount Can be used for Turn Signal, Brake or Running Lights 4.125" Diameter Round Light Double Sided, Amber Lenses 25 Bulbs per Side For 12 Volt to 24 Volt Systems	AMX1910149	\$ 44.00	
	Universal Equipment	LED Warning Light Cab, Header or Swather Mount Can be used for Turn Signal, Brake or Running Lights 4.125" Diameter Round Light Double Sided, Red and Amber Lenses 25 Bulbs per Side For 12 Volt to 24 Volt Systems	AMTLFL3	\$ 55.00	
		LED Warning Light Cab, Header or Swather Mount Can be used for Turn Signal, Brake or Running Lights 4.125" Diameter Round Light Double Sided, Red and Amber Lenses 25 Bulbs per Side For 12 Volt to 24 Volt Systems	AMX33126	\$ 44.00	
	Universal Equipment	LED Magnetic Warning Light All-Position Light 360° Flashing Light, Multiple Patterns 9.50" x 6.75" Rectangle Light Magnetic Base or Solid Mount For 12 Volt to 24 Volt Systems Includes Cigarette Lighter Adapter, Wiring and Switch	AMTL1100	\$ 170.00	
	Universal Equipment	LED Magnetic Warning Light All-Position Light 360° Flashing Light, Multiple Patterns 14" x 6.75" Rectangle Light Magnetic Base or Solid Mount For 12 Volt to 24 Volt Systems Includes Cigarette Lighter Adapter, Wiring and Switch	AMTL1200	\$ 190.00	

International®—Tractor

	Application	Description	Part Number	Retail Price	Core
	Universal Equipment	Warning Beacon 360° Flashing Beacon, Amber Lens For 0.9435" Diameter Pipe Replaces 84337818, AZ44705, AZ101891	AM82018390	\$ 45.64	
	Universal Equipment	LED Warning Beacon 360° Flashing Beacon 2.75" x 5.25" Light Polycarbonate Amber Lens and Housing For 12 Volt to 24 Volt Systems Includes Solid Mounting Pad and Stainless Steel Hardware	AMTL2100	\$ 30.00	
	Universal Equipment	LED Warning Beacon 360° Flashing Beacon, 3 Different Patterns 5" x 10" Light Amber Lens, 48 Watts, 4 Amps For 12 Volt to 24 Volt Systems Brackets Sold Separately	AMX33131	\$ 75.00	
	Universal Equipment	Warning Beacon Bracket	AMX33132	\$ 15.00	
	Universal Equipment	Warning Beacon Bracket	AMX33133	\$ 15.00	
	Universal Equipment	Warning Beacon Bracket	AMX33137	\$ 15.00	
	Universal Equipment	Warning Beacon Bracket	AMX33135	\$ 15.00	

International®—Tractor

Application	Description	Part Number	Retail Price	Core
 Universal Equipment	LED Light Bar 4" Long, 1260 Lumens, Cree Bulbs	AMLED4	\$ 45.00	
	LED Light Bar Flood/Spotlight Combo 10" Long, 5700 Lumens, 50 Watts, 4.20 Amps For 12 Volt to 24 Volt Systems Includes Mounting Bracket and Stainless Steel Hardware	AMTL10SRC	\$ 129.00	
	LED Light Bar Floodlight/Spotlight Combo 14" Long, 5400 Lumens, 72 Watts, 6 Amps Die Cast Aluminum Housing, Polycarbonate Lens For 12 Volt to 24 Volt Systems Includes Mounting Bracket and Heavy Duty Stainless Hardware	AMTLB410C	\$ 150.00	
	LED Light Bar Floodlight/Spotlight Combo 30" Long, 13600 Lumens, 150 Watts, 12.50 Amps For 12 Volt to 24 Volt Systems Includes Mounting Bracket and Stainless Steel Hardware	AMTL30SRC	\$ 230.00	
	LED Light Bar 30" Long, 13860 Lumens, Cree Bulbs	AMLED30	\$ 130.00	
	LED Light Bar Floodlight/Spotlight Combo 40" Long, 17300 Lumens, 200 Watts, 16.70 Amps For 12 Volt to 24 Volt Systems Includes Mounting Brackets and Stainless Steel Hardware	AMTL40SRC	\$ 300.00	
	LED Light Bar 40" Long, 18200 Lumens, Cree Bulbs	AMLED40	\$ 160.00	
	LED Light Bar Floodlight/Spotlight Combo 42" Long, 14500 Lumens, 240 Watts, 19 Amps For 12 Volt to 24 Volt Systems Includes Mounting Bracket and Stainless Steel Hardware Replaces 1163691	AMTLB440C	\$ 250.00	
	LED Light Bar, Curved 50" Long, 21500 Lumens, Cree Bulbs	AMLED50C	\$ 190.00	
	 Universal Equipment	LED Magnetic Work Light All-Position Light 3.25" Square Floodlight 900 Lumens Magnetic Base Includes Lithium Ion Battery, Cigarette Lighter and DC Charger	AMTL2460	\$ 79.00
 544, 656, 664, 666, 756, 766, 826, 856, 966, 1026, 1066, 1256, 1456, 1466, 1468, 1566, 1568, 4166, 4366, Hydro 70, Hydro 100		Rotary Light Switch 4-Position Switch, 0.67" Thread Diameter	AM403571R1	\$ 53.00
A, B	Rear Light Cable 38 1/4" Long	AM30711DX	\$ 34.10	
A, AV	Rear Light Cable 53" Long	AM358117R91	\$ 24.97	

Cab Doors

Door frame only. No glass, seal or hardware included.



Application	Description	Part Number	Retail Price	Core
766, 966, 1066, 1466, 1468, 1566, 1568, Hydro 100	Cab Door Frame, Left Hand Primer Coated, Ready for Paint For Factory Red or White Cab	AM117831C91	\$ 395.00	

International®—Tractor







Application	Description	Part Number	Retail Price	Core
786, 886, 986, 1086, 1486, 1586, 3088, 3288, 3388, 3488 Hydro, 3588, 3688, 3788, 5088, 5488, 6388, 6588, 6788, 7288, 7488, Hydro 186	Cab Door Frame, Left Hand Primer Coated, Ready for Paint	AM143348C3	\$ 595.00	



Cab Components—Miscellaneous



Application	Description	Part Number	Retail Price	Core
3088, 3288, 3488, 3688, 6088, 6288, 6488, 6388, 6588, 6788, 7288, 7488	Front Lower Panel Right Hand Left Hand	AM143173C3 AM143172C3	\$ 212.00 \$ 212.00	
786, 886, 986, 1086, 1486, 1586, 3088, 3288, 3488, 3588, 3688, 3788, 5088, 5288, 5488, 6388, 6588, 6788, Hydro 186	Cab Mount Isolator	AM117722C4	\$ 25.00	

Glass

Application	Description	Part Number	Retail Price	Core
786, 886, 986, 1086, 1486, 1586, 3088, 3288, 3388, 3488, 3588, 3688, 3788, 5088, 5288, 5488, 6388, 6588, 6788, Hydro 186	Upper Front Glass Replaces 112083	AM109133C3	\$ 183.00	
 786, 886, 986, 1086, 1486, 1586, 3088, 3288, 3388, 3488, 3588, 3688, 3788, 5088, 5288, 5488, 6388, 6588, 6788, Hydro 186	Lower Front Glass, Right Hand	AM109132C2	\$ 36.00	
	Lower Front Glass, Left Hand	AM109131C2	\$ 35.00	
 786, 886, 986, 1086, 1486, 1586, 3388, 3588, 3788, Hydro 186 - w/ Cab BSN 107806	Wing Window, Right or Left Hand 31.25" Tall (Rear Corner to Rear Corner)	AM109319C2	\$ 45.00	
	Wing Window, Right or Left Hand 32 7/8" Tall (Rear Corner to Rear Corner)	AM1250436C2	\$ 50.00	
 966, 1066, 1466, 1566, 1568 - w/ Factory Red Cab	Wing Window, Right or Left Hand	AM109168C1	\$ 44.00	
 786, 886, 986, 1086, 1486, 1586, 3088, 3288, 3388, 3588, 3688, 3788, 5088, 5288, 5488, 6388, 6588, 6788, Hydro 186	Door Glass, Right or Left Hand	AM109584C2	\$ 65.00	
 766, 966, 1066, 1466, 1468, 1566, 1568, Hydro 100	Door Glass, Right or Left Hand	AM539123R1	\$ 69.00	
 786, 886, 986, 1086, 1486, 1586, 3088, 3288, 3388, 3588, 3688, 3788, 5088, 5288, 5488, 6388, 6588, 6788	Rear Glass	AM109318C2	\$ 89.00	

Prices Subject to Change without Prior Notice. The use of original equipment manufacturer (OEM) part numbers or trademarks, e.g. Case® and John Deere®, are for reference purposes only and for indicating product use and compatibility. Our company and the listed replacement parts contained herein are not sponsored, approved or manufactured by the OEM. All parts are New unless designated Reman in the description.

International®—Tractor

Application	Description	Part Number	Retail Price	Core
 766, 966, 1066, 1466, 1566, 1568, Hydro 100	Rear Glass Fits Red or White Deluxe Cab	AM539124R1	\$ 110.00	
 766 ASN 12235, 966 ASN 21920, 1066 ASN 33177, 1466 ASN 19426, 1468 ASN 9663, 1566, 1568, Hydro 100 - w/ Deluxe Cab	Weatherstrip 600" (50') Long For Window Seal	AM64517C1	\$ 353.44	

Gas Struts

Application	Description	Part Number	Retail Price	Core
886, 986, 1086, 1486, 1586, 3088, 3288, 3388, 3488, 3588, 3688, 3788, 5088, 5288, 5488, 6388, 6588, 6788, Hydro 186	Door Cylinder Kit, Right Hand	AMSS3319	\$ 86.00	
	Door Cylinder Kit, Left Hand	AMSS3320	\$ 86.00	



Grab Handles

Application	Description	Part Number	Retail Price	Core
706, 756, 766, 806, 826, 856, 966, 1206, 1256, 1456, 1466, 1468 - w/ Gear Drive	Grab Handle	Right Hand AM399306R2	\$ 31.00	
		Left Hand AM397890R2	\$ 30.00	









Steering Wheels and Caps

Application	Description	Part Number	Retail Price	Core
A, Super A, B, C, Cub	Steering Wheel 15" Diameter, 3 Spokes (Bare), Keyed Hub For 3/4" Steering Shaft	AM60069D	\$ 37.50	
Super A Late, C, Super C, H, HV, M, Super M, MD, W4, Super W4, W6, Super W6, W9, 100, 130, 200, 230, (300, 350, 400, 450 - w/o Power Steering)	Steering Wheel 17 5/8" Diameter, 3 Spokes (Bare), Keyed and Straight Hub For 3/4" Steering Shaft	AM60070D	\$ 35.50	
404, 424, 444, 474, 504, 544, 574, 584, 585, 606, 656, 664, 666, 674, 684, 685, 686, 706, 756, 766, 784, 785, 786, 806, 826, 856, 884, 885, 886, 966, 986, 1026, 1066, 1086, 1206, 1256, 1456, 1466, 1468, 1486, 1566, 1586, 2500, 2504, 3088, 3288, 3388, 3488, 3588, 3688, 3788, 4100, 4156, 4166, 4186, 4366, 4386, 4586, 4786, 5088, 5288, 5488, 6388, 6588, 6788, 7588, Hydro 70, Hydro 86, Hydro 100, Hydro 186, Ind: 2404, 2424, 2444	Steering Wheel Steering Wheel Cap Non-tilt Models	AM385156R1 AM378395R1	\$ 41.50 \$ 7.00	













International®—Tractor

Air Conditioning and Components

Application	Description	Part Number	Retail Price
 <p>766, 786, 886, 966, 986, 1066, 1086, 1466, 1468, 1486, 1566, 1568, 1586, 4166, 4186, 4366, 4386, Hydro 100, Hydro 186</p>	Compressor Conversion Kit York Style to Sanden Style Includes Compressor, Mounting Bracket, Compressor Manifold, O-Rings and Mounting Hardware Requires AMX10202 Service Valve Kit to Replace Original Service Valves Requires Pag Oil 100V, 6.76 oz (200 cc)	AMX10165	\$ 395.00
	Service Valve Kit	AMX10202	\$ 35.00
	R134a Tube O-Ring to O-Ring or Flare Fitting Insert Flare Adapters for Flare Applications		
	Ultra Pag Double End Capped, 100V, 8 oz	AMX10267	\$ 12.00
	Universal Pag Oil, 8 oz	AMX10274	\$ 8.25
	Sanden Replacement Compressor Requires Pag Oil 100V, 6.76 oz (200 cc)	AMX10185	\$ 325.00
	Compressor to Condenser Hose Replaces A145696	AMX10170	\$ 50.00
	Ultra Pag Double End Capped, 100V, 8 oz	AMX10267	\$ 12.00
	Universal Pag Oil, 8 oz	AMX10274	\$ 8.25
	 <p>3088, 3388, 3488, 3588, 3688, 3788, 5088, 5288, 5488, 6388, 6588, 6788, 7288, 7488</p>	Compressor Conversion Kit York Style to Sanden Style Includes Compressor, Mounting Brackets, Compressor Manifold, O-Rings and Mounting Hardware Requires Pag Oil 100V, 6.76 oz (200 cc)	AMX10201
Ultra Pag Double End Capped, 100V, 8 oz		AMX10267	\$ 12.00
Universal Pag Oil, 8 oz		AMX10274	\$ 8.25
Sanden Replacement Compressor Requires Pag Oil 100V, 6.76 oz (200 cc)		AMX10242	\$ 315.00
Ultra Pag Double End Capped, 100V, 8 oz		AMX10267	\$ 12.00
Universal Pag Oil, 8 oz		AMX10274	\$ 8.25
 <p>656, 706, 756, 766, 806, 856, 966, 1066, 1466, 1468, 1566, 1568, 4166, 4186, Hydro 100, Ind: 2656, 2706, 2756, 2806, 2856 Replaces 417888C93</p>	Compressor, York Style Left Hand Suction, Rotolock Clutch Not Included Requires Synthetic Ester Oil 100V, See Manufacturer for Oil Quantity	AMX10225	\$ 260.00
	Double Groove Clutch for York Compressor, 7"	AM470	\$ 101.00
	Premium Synthetic Ester Oil, 100V, 12 oz	AMX10273	\$ 11.00
 <p>786, 886, 986, 1086, 1486, 1586, 3388, 3588, 3788, 4366, 4568, 4586, Hydro 186</p>	Compressor, York Style Right Hand Suction, Rotolock Clutch Not Included Requires Synthetic Ester Oil 100V, 9.50 oz (281 cc)	AM54-032	\$ 225.00
	Double Groove Clutch for York Compressor, 7"	AM470	\$ 101.00
	Premium Synthetic Ester Oil, 100V, 12 oz	AMX10273	\$ 11.00
 <p>3088, 3288, 3488, 3688, 5088, 5288, 5488, 6388, 6588, 6788, 7288, 7488 Replaces 1924008C1, 1924008C2</p>	Compressor, York Style Right Hand Suction, O-Ring Fitting, Clutch Not Included Requires Synthetic Ester Oil 100V, 9.50 oz (281 cc)	AMX10177	\$ 225.00
	Double Groove Clutch for York Compressor, 7"	AM470	\$ 101.00
	Premium Synthetic Ester Oil, 100V, 12 oz	AMX10273	\$ 11.00
 <p>766, 966, 1066, 1466, 1468, 1566, 1568, 4166, 4186 Replaces 539069R2</p>	High Pressure Switch Normally Closed, Opens at 375 PSI, Closes at 225 PSI 7/16"x20 Thread	AM539069R2	\$ 34.00
 <p>Universal Equipment</p>	High Pressure Switch Normally Open, Opens at 305 PSI, Closes at 395 PSI, 7/16"x20 Thread	AMX10276	\$ 35.00

Prices Subject to Change without Prior Notice. The use of original equipment manufacturer (OEM) part numbers or trademarks, e.g. Case® and John Deere®, are for reference purposes only and for indicating product use and compatibility. Our company and the listed replacement parts contained herein are not sponsored, approved or manufactured by the OEM. All parts are New unless designated Reman in the description.

International®—Tractor

	Application	Description	Part Number	Retail Price
	Universal Equipment	Low Pressure Switch Normally Open, Opens at 6 PSI, Closes at 45 PSI, Standard 7/16"x20 Thread	AMX10277	\$ 55.00
	Universal Equipment	Low Pressure Switch Normally Open, Opens at 35 PSI, Closes at 46 PSI, Standard 7/16"x20 Thread	AMX10278	\$ 42.00
	766, 786, 886, 966, 986, 1066, 1086, 1466, 1468, 1486, 1566, 1568, 1586, 4166, 4186, (Hydro 100, Hydro 186 BSN 16527)	Receiver Drier Replaces 111218C1	AMX10172	\$ 30.00
	786 SN 10592-107806, 886 SN 14354- 107806, 986 SN 119122-107806, 1086 SN 34298-107806, 1486 SN 18586- 107806, 1586 SN 16528-107806, (3388, 3588, 3788 BSN 107806), Hydro 186 SN 10592-107806	Receiver Drier 4" x 6 3/4", Inlet - #6, 3/8" Female O-Ring, Outlet - #6, 3/8" Male O-Ring, R12 and R134a Compatible Replaces 118304C2	AMX10162	\$ 32.00
	(786, 886, 986, 1086, 1486, 1586, 3388, 3588, 3788 ASN 107807), 3088, 3288, 3488, 3688, 5088, 5288, 5488, 6388, 6588, 6788, 7288 Replaces 143469C2, 1990758C2	Receiver Drier 4" x 7 3/4", Inlet - #6, 3/8" Male O-Ring, Outlet - #6, 3/8" Female O-Ring, Front Mount, R12 and R134a Compatible	AMX10161	\$ 30.00
	656, 706, 756, 806, 856, 4366, 4386, 4568, 4586, 4786, Ind: 2656, 2706, 2756, 2806, 2856 Replaces 25-055, 25-084, 25-1038, 70179C1, 244562R1	Expansion Valve Internally Regulated w/ 12" Capacity Tube w/ Flare Connection, R12 and R134a Compatible	AMX10215	\$ 30.00
	766, 966, 1066, 1466, 1468, 1566, 1568 Replaces 66398C1, 539064R1	Expansion Valve Bulb Type, Externally Equalized, R12 and R134a Compatible, 12" Tube Length, Flare Connection	AMX10153	\$ 25.00
	786 BSN 10591, 886 BSN 14353, 986 BSN 19121, 1086 BSN 34297, 1486 BSN 18585, 1586 BSN 16527, 4166, 4186, Hydro 186 BSN 10591 Replaces 66398C1, 1336422C1	Expansion Valve Bulb Type, R12 and R134a Compatible, 19" Tube Length, Flare Connection	AMX10146	\$ 20.00
	786 SN 10592-107806, 886 SN 143541- 107806, 986 SN 19122-107806, 1086 SN 34298-107806, 1486 SN 18586- 107806, 1586 SN 16528-107806, 3388 BSN 107806, 3588 BSN 107806, 3788 BSN 107806 Replaces 118305C3	Expansion Valve Bulb Type, Externally Equalized, R12 and R134a Compatible, 14" Tube Length, O-Ring Connection	AMX10145	\$ 20.00
	(786, 886, 986, 1086, 1486, 1586, 3388, 3588, 3788 ASN 107807), 3088, 3288, 3488, 3688, 5088, 5288, 5488, 6388, 6588, 6788, 7288, 7488 Replaces 118321C1	Expansion Valve Block Type, R12 and R134a Compatible, O-Ring Connection	AMX10151	\$ 24.00
	886, 986, 1086, 1486, 1586, Hydro 186	Compressor to Condenser Hose Flare Fittings Replaces 109238C1	AM109277C1	\$ 30.00
	886, 986, 1086, 1486, 1586, Hydro 186	Receiver Drier to Evaporator Hose Flare Fittings	AM109267C2	\$ 50.00
	100, 766, 786, 886, 966, 986, 1086, 1466, 1468, 1486, 1566, 1568, 1586, 3288, 3388, 3588, 3788, 4568, 4586, 4786, 4166, 4186, 4366, 4386, Hydro 100, Hydro 186	Adapter Kit Rotolock to O-Ring or Flare Service Valve	AMX10204	\$ 32.00

International®—Tractor

	Application	Description	Part Number	Retail Price
	686, 786, 886, 986, 1086, 1486, 1586, 4186, 4386, 4586	Service Valve Kit R134a Tube O-Ring to O-Ring or Flare Fitting Insert Flare Adapters for Flare Applications	AMX10202	\$ 35.00
	585, 595, 685, 695, 885, 895, 995, 3220, 3230, 4210, 4230, 4240 Replaces 1974779C1, 1977564C1, 1977564C2, 335190A1	Blower Motor Assembly w/o Resistor 12 Volt, Includes Wiring Harness	AMX10121	\$ 180.00
	766, (786, 886, 986, 1086, 1486, 1586, 3388, 3588, 3788, Hydro 186 - w/ Cab BSN 107806), 966, 1066, 1466, 1468, 1566, 1568, 4166, 4186, 4366, 4386, 4568, 4586, 4786, Hydro 100 Replaces 1987399C3, 70902C1	Blower Motor 3-Speed, Double Shaft, 4-Wire, Reversible, 3/8" Shaft Diameter, 4 1/4" Long	AMX10120	\$ 80.00
	(786, 886, 986, 1086, 1486, 1586, 3388, 3588, 3788, Hydro 186 ASN 107807) Replaces 190333A1	Blower Motor, Vented Single Speed, Double Shaft, 2-Wire, Reversible, 3/8" Shaft Diameter, 4 3/8" Long	AMX10118	\$ 108.00
	766, 966, 1066, 1466, 1468, 1566, 1568, Hydro 100 Replaces 539054R1, 539054R2	Blower Wheel Reversible, Double Vented, Steel Wheel, 3 3/4" Diameter, 4" Long, 3/8" Shaft	AMX10212	\$ 19.00
	786, 886, 986, 1086, 1486, 1586, 3088, 3288, 3388, 3488, 3588, 3688, 3788, 5088, 5288, 5488, 6388, 6588, 6788, Hydro 186 Replaces 539018R2	Blower Wheel, Right Hand, CW Blower Wheel, Left Hand, CCW Double Vented Steel, 4 1/4" Diameter, 3/8" Shaft, Offset 2 1/4", 3 1/2"	AMX10217 AMX10216	\$ 26.00 \$ 26.00
	786, 886, 986, 1086, 1486, 1586, 3088, 3288, 3388, 3488, 3588, 3688, 3788, 5088, 5288, 5488, 6388, 6588, 6788, 7288, 7488, Hydro 186	Blower Motor Kit, HD 12 Volt Dual Motor Assembly, 3-Speed 22 7/16" x 5 5/8" Mounting Base	AM1255878C92	\$ 245.00
	786, 886, 986, 1086, 1486, 1586, 3088, 3288, 3388, 3488, 3588, 3688, 3788, 4366, 4386, 4568, 4586, 4786, 5088, 5288, 5488, 6388, 6588, 6788, 7288, 7488, Hydro 186	Blower Motor Switch 3-Speed Replaces 168822C1, 168822C2, AH84588	AMX10261	\$ 16.00
	786, 986, 1086, 1486, 1586, 3388, 3588, 3788	Condenser For #6 & #8 O-Ring Fitting Size Replaces 118316C1	AM118316C2	\$ 200.00
	(786, 886, 986, 1086, 1486, 1586 - w/ Cab ASN 107807), 3088, 3288, (3388, 3588, 3788 - w/ Cab ASN 107807), 3488, 5088, 5288, 5488, 6388, 6588, 6788, 7288, 7488, Hydro 186 w/ Cab ASN 107807	Evaporator w/ Heater Core, Late Block Type Valve, O-Ring Fitting Includes Expansion Valve Core: 25" x 5" x 6"	AM1974632C3	\$ 345.00
	886, 986, 1086, 1486, 1586, 3388, 3588, 3788, Hydro 186 - w/ Cab BSN 107806	Evaporator, Early Bulb Type Valve Overall: 32 1/2" x 5" x 6" Core: 25" x 3 1/2" x 6" Replaces 111468C2	AM118315C1	\$ 250.00
	4366, 4386, 4568, 4586, 4786 - 4WD	Evaporator	AM70178C92	\$ 315.00
	766, 966, 1066, 1466, 1468, 1566, 1568, Hydro 100 - w/ International® Deluxe Cab and Factory A/C	Evaporator	AM539059R1	\$ 350.00



Shop Manuals and Collections

I&T Shop Service Manuals provide the information you need to service virtually any make or model of wheel-type farm tractor. Easy-to-follow procedures, detailed illustrations and comprehensive specifications help guide you through complete tractor maintenance and repair with accuracy and efficiency.

Application	Description	Part Number	Retail Price
Super & Non-Super Series: A, B, C, Cub (Prior to 1957), H, M, MD, MTA, MTAD, 4, 6, D6, W6TA, W6TAD, 9, D9	International Harvester®	IT-IH-8	\$ 28.00
Models: 300, 300 Utility, 350, 350 Utility, 350D, 350D Utility, 400, 400D, W400, W400D, 450, 450D, W450, W450D	International Harvester®	IT-IH-10	\$ 28.00
Models: 460, 560, 606, 660, 2606	International Harvester®	IT-IH-25	\$ 28.00
Models: 706, 756, 806, 856, 1206, 1256, 1456, Ind Models: 2706, 2756, 2806, 2856, 21206, 21256, 21456	International Harvester®	IT-IH-32	\$ 28.00
Models: Cub 154, Cub 184, Cub 185 Lo-Boy, Cub Lo-Boy, Farmall Cub	International Harvester®	IT-IH-50	\$ 28.00
Models: 234, Hydro 234, 244, 254	International Harvester®	IT-IH-55	\$ 31.00
Models: 5088, 5288, 5488	International Harvester®	IT-IH-56	\$ 28.00
Models: 100, 130, 140, 200, 230, 240, 404, Models: 330, 340, 504, Models: B-275, B-414, 354, 364, 384, 424, 444, Ind Models: 2404, 2504, 2424, 2444	International Harvester® Collection	IT-IH-201	\$ 31.00
Models: 544, 656, 666, 686, Hydro 70, Hydro 86, Models: Hydro 100, Hydro 186, 1466, 1468, 1486, 1566, 1568, 1586, Models: 684, 784, 884, Hydro 84	International Harvester® Collection	IT-IH-202	\$ 31.00
Models: 766, 826, 966, 1026, 1066, Models: 454, 464, 484, 574, 584, 674, Models: 786, 886, 986, 1086	International Harvester® Collection	IT-IH-203	\$ 31.00



Clear View Cap Kits

Application	Description	Part Number	Retail Price	Core
9310, 9330, 9350, 9360, 9370, 9380	Cap Kit, Clear View Includes 16 Idler & 24 Roller Caps and Hardware	AMX92001	\$ 895.00	

International®—Industrial / Construction

Table of Contents

Crankshafts 847

Starters 847

Crankshafts

Application	Description	Part Number	Retail Price	Core
544, 574, 674, 684 Replaces 182752R2, 2744406R1, 3132752R3, 3144626R1	Crankshaft D239 239 CID 3.9 Liter 4 Cylinder Diesel Engine 5.0625" Stroke, 3.875" Bore, 2.5185" - 2.5193" Rod , 3.1484" - 3.1492" Main Flange - Flat, 7 Bolt Holes, 1 Dowel Hole, w/ 80 Tooth Helical Balance Gear in Center 5/8" Wide Snout - Straight, 3 Bolt Holes	AM3144626R91	\$ 695.00	
966, 1066, 1086, Combine: 815	Crankshaft D414 and DT414 - 6.8 Liter, 414 CID, 6 Cylinder Diesel Engines	AM675050C1	\$ 1425.00	
3588, 3788, 4366, 4386, 5288, 5488, Ind/Utility: E412, H80B, L175C Replaces 675591C1, 675591C2, 675591C3, 675591C4, 675669C3, 1816975C1	Crankshaft DT466, DT466B, DT466C, DT466E, DT1466B - 7.6 Liter, 466 CID 6 Cylinder Diesel Engine 5.350" Stroke, 4.3005" - 4.3015" Bore, 2.9977" - 2.999" Rod, 3.3742" - 3.3755" Main Flange - Flat, 8-Bolt Holes Snout - Straight, 3 Bolt Holes, 1 Keyway, w/ 33 Tooth Timing Gear, Left Hand Helix, w/ 41 Tooth Oil Pump Drive Gear	AM675669C93	\$ 1425.00	

Starters

Application	Description	Part Number	Retail Price	Core
Crawler/Dozer: TD7C, TD7E, TD8C, TD8E, TD100C, TD100E, TD125C, TD125E, TD165 - Diesel	Starter, 12 Volt HD Planetary Gear Reduction, 10 Tooth Steel Pinions, Steel Ring Gear, 4kW, CW Rotation For Diesel Engines Replaces 1113391, 1113672	AMX34112	\$ 285.00	
	Solenoid Use w/ AMX34112 Starter	AMX34113	\$ 60.00	

John Deere®—Tractor

Table of Contents

Air Cleaner Components	915	Mufflers and Exhaust	908
Air Conditioning and Components	1054	Oil Coolers, Engine	869
Alternators	917	Oil Pump Components	869
Axle Assemblies	937	Oil Pumps, Engine	866
Axle Center Tubes and Beams	957	Overhaul Kits	852
Axle Knee Extensions	957	Pony Motor Coils	917
Axle Pivot Assembly and Pins	958	Power Steering Cylinders and Components	967
Balancer Shafts	864	Power Steering Orbit Motor	968
Battery Boxes and Components	1014	Power Steering Pump	966
Belts	890	PTO Adapters	990
Brake Pinion Shaft and Gears	996	PTO Shafts	987
Brakes and Components	992	PTO Shields	991
Cab Components—Miscellaneous	1037	Quad-Range™ Packs and Components	975
Cab Doors	1041	Quick Hitches and Components	1006
Cab Roofs and Liners	1042	Radiator Hoses and Thermostats	875
Camshafts and Lifters	862	Radiators and Components	870
Carburetors	892	Rear Axle Components	992
Connecting Rods	859	Rear Power Shift Packs and Components	976
Cowl (Dash) Covers	1019	Remote Valve Kits	969
Crankshaft Pulleys and Dampers	860	Ring Gears and Pinions	991
Crankshafts	856	Rockshafts and Components	1002
Cylinder Heads	864	Selective Control Valves and Couplers	969
Decals	1016	Sensors	920
Differentials and Components	991	Shop Manuals and Collections	1067
Drawbars and Components	997	Shortblock Assemblies	851
Drawbar Supports	1000	Side Moldings	1018
Fan Clutches	888	Side Panels, Front	1018
Fenders, Platforms and Components	1019	Side Panels, Rear	1018
Flywheels and Components	880	Side Rails	1014
Front Grilles, Nose Cones and Components	1019	Side Screens	1015
Front Power Shift Packs and Components	976	Spindles	947
Fuel Lift Pumps	892	Starter Conversion Kits	914
Fuel Tanks and Components	1052	Starters	912
Gas Struts	1052	Steering Arms	955
Glass	1043	Steering Columns and Valves	968
Hammer Straps	1001	Steering Wheels and Caps	1053
Hoods	1015	Steps	1040
Hydraulic Covers and Parts	973	Sway Blocks	1012
Hydraulic Oil Coolers	959	Tachometers, Gauges and Instrument Clusters	915
Hydraulic Pump Components	964	Tie Rods and Components	937
Hydraulic Pumps	961	Toplink Assemblies and Components	1010
Injection Pumps	893	Topshaft Components	974
Injectors	899	Topshafts	973
Lift Link Assemblies and Components	1004	Track Parts	1068
Lighting	1021	Tracks	1067
Load Sensing Shafts	1008	Transmission Components	981
Longblock Assemblies	849	Transmission Discs	984
Lower Lift Links	1007	Transmissions	977
Manifolds and Components	906	Transmission Separator Plates	985
Mechanical Front Wheel Drive Parts	922	Turbochargers and Components	903
MFWD Differentials and Components	932	Water Pumps and Components	881
MFWD Driveshafts	935	Weights	1001
MFWD Hub Components	926	Wheel Bearing Kits	953
MFWD Hubs and Housings	922	Wheel Hubs and Components	952
		Wide Front Ends	921

LED Floodlamp, Sealed Beam

AMRE336112

- Lasts 50 times longer than halogen lighting
- Vibration resistant
- No filament failures
- 6 diodes (3 watts each) provide 1440 lumens
- Draws less current than comparable halogens
- 2-terminal connection
- Operating temperature: - 40 to 140 degrees Fahrenheit / - 40 to 60 degrees Celsius
- All new, remanufactured and recycled tractor parts have a one-year warranty

Fits John Deere® Tractors: 2010, 2040, 2240, 2510, 2520, 2840, 2940, 3010, 3020, 4000, 4010, 4020, 4030, 4040, 4050, 4055, 4230, 4240, 4250, 4255, 4320, 4430, 4440, 4450, 4455, 4520, 4555, 4560, 4620, 4630, 4640, 4650, 4755, 4760, 4840, 4850, 4955, 4960, 5010, 5020, 6030, 7020, 7520, 8430 (1974-1981), 8440, 8450, 8560, 8570, 8630, 8640, 8650, 8760, 8770, 8850, 8870, 8960, 8970, 9100, 9200, 9300, 9300T, 9400, 9400T

Replaces RE285628, RE336111



More Styles Available, See Lighting

Longblock Assemblies

Our remanufactured longblocks meet the highest standards in quality. All remanufactured components are inspected for structural integrity, cracks and dimensional specifications and then remanufactured back to OEM specifications. The components are then assembled using the highest quality new parts. We back this with one of the best warranties in the industry.



Application	Description	Part Number	Retail Price	Core
Most Models	Reman Longblock Assembly Crank Nose 1-Bolt Taper, 3-Bolt Injection Pump, Aux Drive Front Cover	LBJD4045PT6410-3	\$ 5750.00	\$ 1500.00
	Reman Longblock Assembly Crank Nose (4) Bolt Straight, (3) Bolt Injection Pump, Aux Drive Front Cover	LBJD4045PT6410-4	\$ 5750.00	\$ 1500.00
4230 w/ 404 6 Cylinder Diesel Engine	Reman Longblock Assembly	LBJD404D4230	\$ 9150.00	\$ 1000.00
4240 Early w/ 466 6 Cylinder Diesel Engine, Cam Driven	Reman Longblock Assembly	LBJD466DE4240	\$ 9150.00	\$ 1500.00
4240 Late w/ 466 6 Cylinder Diesel Engine, Crank Driven	Reman Longblock Assembly	LBJD466DL4240	\$ 9150.00	\$ 1500.00
4250, 4450, 4650 - w/ 466T 6 Cylinder Diesel Engine	Reman Longblock Assembly	LBJD466T4650	\$ 9150.00	\$ 1500.00
4255, 4455, 4555, 4755 - w/ 6076T 6 Cylinder Diesel Engine	Reman Longblock Assembly Width of Timing Gear Needed Block Cast # - R88379, R109777, R122729	LBJD6076T4755	\$ 9150.00	\$ 1500.00
4430, 4630 - w/ 404T 6 Cylinder Diesel Engine	Reman Longblock Assembly	LBJD404T4630	\$ 9150.00	\$ 1000.00
4440 Early w/ 466T 6 Cylinder Diesel Engine, Cam Driven	Reman Longblock Assembly	LBJD466TE4440	\$ 9150.00	\$ 1500.00
4440 Late w/ 466T 6 Cylinder Diesel Engine, Crank Driven	Reman Longblock Assembly	LBJD466TL4440	\$ 9150.00	\$ 1500.00
4450	Reman Longblock Assembly	LBJD466T4450	\$ 9150.00	\$ 1500.00
4560, 4760 - w/ 6076T 6 Cylinder Diesel Engine	Reman Longblock Assembly	LBJD6076T4760	\$ 9150.00	\$ 1500.00
4640 Early w/ 466T 6 Cylinder Diesel Engine, Cam Driven	Reman Longblock Assembly	LBJD466TE4640	\$ 9150.00	\$ 1500.00
4640 Late w/ 466T 6 Cylinder Diesel Engine, Crank Driven	Reman Longblock Assembly	LBJD466TL4640	\$ 9150.00	\$ 1500.00
4840 Early, 8440 Early - w/ 466T 6 Cylinder Diesel Engine, Cam Driven	Reman Longblock Assembly	LBJD466TE4840	\$ 9150.00	\$ 1500.00

Prices Subject to Change without Prior Notice. The use of original equipment manufacturer (OEM) part numbers or trademarks, e.g. Case® and John Deere®, are for reference purposes only and for indicating product use and compatibility. Our company and the listed replacement parts contained herein are not sponsored, approved or manufactured by the OEM. All parts are New unless designated Reman in the description.

John Deere®—Tractor

Application	Description	Part Number	Retail Price	Core
4840 Late, 8440 Late - w/ 466T 6 Cylinder Diesel Engine, Crank Driven	Reman Longblock Assembly	LBJD466TL4840	\$ 9150.00	\$ 1500.00
4850, 8450 - w/ 466T 6 Cylinder Diesel Engine	Reman Longblock Assembly	LBJD466T4850	\$ 9150.00	\$ 1500.00
4955, 4960 - w/ 6076T 6 Cylinder Diesel Engine	Reman Longblock Assembly 1" Timing Gear Block Cast # - R88380, R109780, R122730	LBJD6076T4955	\$ 9150.00	\$ 1500.00
6110*, 6210* - w/ TL063 Engine), 6120** w/ TL070 Engine, 6215** w/ TL064 Engine, 6220** w/ TL071 Engine, 6310* w/ TL055 Engine, 6320* w/ HL073 Engine, 6405** w/ TL062 Engine, 6410* w/ TL056 Engine, 6420* w/ HL070 Engine - All w/ 4-Bolt Straight Crankshaft *Models with Delphi Lucas DP201 Injection Pump **Models with Stanadyne® DB4 Injection Pump	Reman Longblock Assembly	LBJD4045PT6410-1	\$ 5750.00	\$ 1500.00
6110*, 6120** w/ TL070 Engine, 6210* w/ TL063 Engine, 6220** w/ TL071 Engine, 6215** w/ TL064 Engine, 6310* w/ TL055 Engine, 6320* w/ HL073 Engine, 6405** w/ TL062 Engine, 6410* w/ TL056 Engine, 6420* w/ HL070 Engine *w/ 1-Bolt Tapered Crankshaft and Delphi Lucas DP201 Injection Pump **w/ 1-Bolt Tapered Crankshaft and Stanadyne® DB4 Injection Pump	Reman Longblock Assembly	LBJD4045PT6410-2	\$ 5750.00	\$ 1500.00
(6120, 6420 - w/ HL271 Engine), (6215, 6220, 6415 - w/ HL272 Engine), 6320 w/ HL270 Engine - All w/ 1-Bolt Taper Crankshaft w/ Sensor Wheel and w/ Stanadyne® DE10 Electronic Injection Pump	Reman Longblock Assembly	LBJD4045PT6420-5	\$ 5750.00	\$ 1500.00
(7710, 7810 BSN 089999)	Reman Longblock Assembly	LBJD8.1PT7810E	\$ 10900.00	\$ 1500.00
8100, 8100T, 8110, 8110T, 8200, 8200T, 8210, 8210T, 8300, 8300T, 8310, 8310T, 8400, 8400T, 8410, 8410T	Reman Longblock Assembly Spur Oil Pump Drive Gear	LBJD8.1PT8400L	\$ 10900.00	\$ 1500.00
	Reman Longblock Assembly Helical Oil Pump Drive Gear	LBJD8.1PT8400E	\$ 10900.00	\$ 1500.00
8120, 8120T, 8220, 8220T, 8320, 8320T, 8420, 8420T, 8520, 8520T	Reman Longblock Assembly	LBJD8.1PT8520	\$ 10900.00	\$ 1500.00
8300	Reman Longblock Assembly	LBJD6076T8300	\$ 9100.00	\$ 1500.00
8400 ASN 010000	Reman Longblock Assembly	LBJD6081T8400	\$ 10900.00	\$ 1500.00
8560	Reman Longblock Assembly 235 Horsepower	LBJD60769600W95	\$ 9150.00	\$ 1500.00
8760	Reman Longblock Assembly	LBJD6101-8760	\$ 17500.00	\$ 6000.00
8770	Reman Longblock Assembly	LBJD6101-8770	\$ 17500.00	\$ 6000.00
8870	Reman Longblock Assembly	LBJD6101-8870	\$ 17500.00	\$ 6000.00
9100, 9200, 9300, 9300T, 9400, 9400T	Reman Engine, Complete	CRJD6125T9420L	\$ 32500.00	\$ 7500.00
9220, 9320, 9320T, 9420, 9420T, 9520, 9520T, 9620, 9620T	Reman Engine, Complete	CRJD6125T9420M	\$ 32500.00	\$ 7500.00
9330, 9430, 9430T, 9530, 9530T, 9630, 9630T	Reman Engine, Complete 13.5 Liter	AMRG38073-R	\$ 37500.00	\$ 7500.00
9630, 9630T	Reman Engine, Complete 13.5 Liter, High Power, Tier 3 Replaces SE502565	CRJD6135T9630H	\$ 37500.00	\$ 7500.00
Models w/ 4045T Engine	Reman Engine, Complete	CRJD4045T3	\$ 10000.00	\$ 1250.00
9220, 9300, 9300T, 9320, 9320T, 9400, 9400T, 9420T, 9520T, 9620T, 9860STS ASN 030000, Excavator: 450C LC, Wheel Loaders: 744J, 824J	Reman Engine, Complete 12.5 Liter, 6125, HH003	CRJD6125T9860L	\$ 32500.00	\$ 7500.00
7200, 7210, 7400, 7405, 7410, 7500, 7510, 7600, 7610 BSN 089999, 7630, 7700, 7710, 7720, 7730, 7800, 7810, 7815 BSN 053261, 7830, 7920, 7930	Engine Mount Isolator	AMRE60720	\$ 27.94	

John Deere®—Tractor

Shortblock Assemblies

Our remanufactured shortblocks meet the highest standards in quality. All remanufactured components are inspected for structural integrity, cracks and dimensional specifications and then remanufactured back to OEM specifications. The components are then assembled using the highest quality new parts. We back this with one of the best warranties in the industry.



John Deere®—Tractor

Application	Description	Part Number	Retail Price	Core
2255, Sprayer: 6000 - w/ 4039D 4 Cylinder Diesel (Non-Turbo) Engine	Reman Shortblock Assembly	SBJD4039D	\$ 4250.00	\$ 750.00
Engines: 3010D, 315D Power Units, Stationary Engines, 4039T 4 Cylinder Diesel (Turbo)	Reman Shortblock Assembly	SBJD4039T	\$ 4250.00	\$ 750.00
2355, Sprayer: 6000 - w/ 4039 4 Cylinder Diesel (Non-Turbo) Engine	Reman Shortblock Assembly Long Nose Crankshaft	SBJD4039DLN	\$ 4250.00	\$ 750.00
2555, 5500, 6200, 6300, 6400, 6500, Sprayers: 6100, 6600 - w/ 4039 4 Cylinder Diesel (Turbo) Engine	Reman Shortblock Assembly Long Nose Crankshaft	SBJD4039TLN	\$ 4250.00	\$ 750.00
2940, 2950, 2955, 3150, 3155 - w/ 359 6 Cylinder Diesel (Non-Turbo) Engine	Reman Shortblock Assembly	SBJD359D2950	\$ 5000.00	\$ 1000.00
4050 ASN 006593 w/ 359 6 Cylinder Diesel (Turbo) Engine	Reman Shortblock Assembly	SBJD359T9400	\$ 5400.00	\$ 1000.00
3010, 3020 Early - w/ 270 4 Cylinder Diesel Engine	Reman Shortblock Assembly	SBJD270DE3020	\$ 4750.00	\$ 1250.00
3020 Late w/ 270 4 Cylinder Diesel Engine	Reman Shortblock Assembly	SBJD270DL3020	\$ 4750.00	\$ 1250.00
4010, 4020 BSN 200999 - w/ 381 6 Cylinder Diesel Engine	Reman Shortblock Assembly	SBJD381DE4020	\$ 5550.00	\$ 1250.00
4000, 4020 ASN 201000 - w/ 404 6 Cylinder Diesel Engine	Reman Shortblock Assembly	SBJD381DL4020	\$ 5550.00	\$ 1250.00
4230 w/ 404 6 Cylinder Diesel Engine	Reman Shortblock Assembly	SBJD404D4230	\$ 5950.00	\$ 750.00
4320, 4520, 4620, 7020 Early - w/ 404 6 Cylinder Diesel Engine	Reman Shortblock Assembly	SBJD404T4320	\$ 5550.00	\$ 1250.00
4430, 4630, 7020 Late - w/ 404T 6 Cylinder Diesel Engine	Reman Shortblock Assembly	SBJD404T4430	\$ 5950.00	\$ 750.00
4240 Early w/ 466 6 Cylinder Diesel Engine, Cam Driven	Reman Shortblock Assembly	SBJD466E4240	\$ 5950.00	\$ 1000.00
4440 Early w/ 466 6 Cylinder Diesel Engine, Cam Driven	Reman Shortblock Assembly	SBJD466E4440	\$ 5950.00	\$ 1000.00
4640 Early w/ 466 6 Cylinder Diesel Engine, Cam Driven	Reman Shortblock Assembly	SBJD466E4640	\$ 5950.00	\$ 1000.00
4840 Early w/ 466 6 Cylinder Diesel Engine, Cam Driven	Reman Shortblock Assembly	SBJD466E4840	\$ 5950.00	\$ 1000.00
8430 Early w/ 466 6 Cylinder Diesel Engine, Cam Driven	Reman Shortblock Assembly	SBJD466E8430	\$ 5950.00	\$ 1000.00
4240 Late w/ 466 6 Cylinder Diesel Engine, Crank Driven	Reman Shortblock Assembly	SBJD466L4240	\$ 5400.00	\$ 1250.00
4440 Late w/ 466 6 Cylinder Diesel Engine, Crank Driven	Reman Shortblock Assembly	SBJD466L4440	\$ 5950.00	\$ 1250.00
4640 Late w/ 466 6 Cylinder Diesel Engine, Crank Driven	Reman Shortblock Assembly	SBJD466L4640	\$ 5950.00	\$ 1250.00
4840 Late w/ 466 6 Cylinder Diesel Engine, Crank Driven	Reman Shortblock Assembly	SBJD466L4840	\$ 5950.00	\$ 1250.00
8430 Late w/ 466 6 Cylinder Diesel Engine, Crank Driven	Reman Shortblock Assembly	SBJD466L8430	\$ 5950.00	\$ 1250.00
4050 Early w/ 466T 6 Cylinder Diesel Engine	Reman Shortblock Assembly	SBJD466TE4050	\$ 5950.00	\$ 1250.00
4250, 4450, 4650 Early - w/ 466T 6 Cylinder Diesel Engine	Reman Shortblock Assembly	SBJD466TE4650	\$ 5950.00	\$ 1250.00
4850 Early w/ 466T 6 Cylinder Diesel Engine	Reman Shortblock Assembly	SBJD466TE4850	\$ 5950.00	\$ 1250.00
4050 Late w/ 466T 6 Cylinder Diesel Engine	Reman Shortblock Assembly	SBJD466TL4050	\$ 5950.00	\$ 1250.00

Prices Subject to Change without Prior Notice. The use of original equipment manufacturer (OEM) part numbers or trademarks, e.g. Case® and John Deere®, are for reference purposes only and for indicating product use and compatibility. Our company and the listed replacement parts contained herein are not sponsored, approved or manufactured by the OEM. All parts are New unless designated Reman in the description.

John Deere®—Tractor

Application	Description	Part Number	Retail Price	Core
4250, 4450, 4650 Late - w/ 466T 6 Cylinder Diesel Engine	Reman Shortblock Assembly	SBJD466TL4650	\$ 5950.00	\$ 1250.00
4850 Late w/ 466T 6 Cylinder Diesel Engine	Reman Shortblock Assembly	SBJD466TL4850	\$ 5950.00	\$ 1250.00
6030, 7520 - w/ 531A 6 Cylinder Diesel Engine	Reman Shortblock Assembly	SBJD531A6030	\$ 7800.00	\$ 1250.00
5020 w/ 531D 6 Cylinder Diesel Engine	Reman Shortblock Assembly	SBJD531D5020	\$ 7800.00	\$ 1250.00
Engines: Power Units, Stationary Engines, 6059 6 Cylinder Diesel	Reman Shortblock Assembly	SBJD6059D	\$ 5000.00	\$ 1000.00
7200, 9330, 9400 - w/ 6059T 6 Cylinder Diesel Engine	Reman Shortblock Assembly	SBJD6059T	\$ 5000.00	\$ 1000.00
4055, 4255, 4455, 4555, 4560, 4760, 4755 - w/ 6076T 6 Cylinder Diesel Engine	Reman Shortblock Assembly 1" Wide Timing Gear Block Cast # - R88379, R109777, R122729	SBJD6076L4755	\$ 5950.00	\$ 1250.00
4955, 4960 - w/ 6076T 6 Cylinder Diesel Engine	Reman Shortblock Assembly 1" Wide Timing Gear Block Cast # - R88380, RA109780, R122730	SBJD6076L4955	\$ 5950.00	\$ 1250.00
8630, 8640 Early - w/ 619 6 Cylinder Diesel Engine, Cam Driven	Reman Shortblock Assembly	SBJD619E8630	\$ 7800.00	\$ 1000.00
8640 Early, 8650 - w/ 619 6 Cylinder Diesel Engine, Crank Driven	Reman Shortblock Assembly Block Cast # - R105739	SBJD619L8650	\$ 7800.00	\$ 1250.00
8760	Reman Shortblock Assembly, 10.1	SBJD6101-8760	\$ 9900.00	\$ 1500.00
8770, 8870	Reman Shortblock Assembly, 10.1	SBJD6101-8870	\$ 9900.00	\$ 1500.00
6.8L Non-PowerTech™ Engines	Reman Shortblock Assembly	SBJD6068T	\$ 5950.00	\$ 1000.00
6.8L PowerTech™ Engines	Reman Shortblock Assembly	SBJD6068PT-D	\$ 5950.00	\$ 1000.00
6.8L PowerTech™ Engines	Reman Shortblock Assembly	SBJD6068PT-T	\$ 5950.00	\$ 1000.00



Overhaul Kits

Application	Description		Retail Price	Core
320 BSN 320854, M	320 Engine - Gas	Inframe Kit	\$ 547.00	
40, 320 ASN 320854, 330	100 Engine - Gas	Inframe Kit	\$ 554.00	
		Overhaul Kit	\$ 554.00	
420, 430	113 Engine - Gas	Inframe Kit	\$ 602.00	
		Overhaul Kit	\$ 627.00	
1020 Engine BSN 162079, Ind: 300 Transmission	135 Engine - Gas	Inframe Kit	\$ 706.00	
BSN 106069, Sprayers: (600, 700, 734 Engine BSN 162301), Swathers: (215A, 880 Engine BSN 162301)	O-Ring Grooves on Sleeves	Overhaul Kit	\$ 676.00	
1020 Engine ASN 162078, Ind: 300 Transmission	135 Engine - Gas	Inframe Kit	\$ 656.00	
ASN 106068, 300B, 301, 301A, Sprayers: (600, 600A, 700, 734 Engine ASN 162300), Swathers: (215A, 880 Engine ASN 162300)	O-Ring Grooves in Block	Overhaul Kit	\$ 735.00	

John Deere®—Tractor

Application	Description		Retail Price	Core
920 Engine SN 038345-075000, 1020 Engine SN 035894-154765, Ind: 300 BSN 101360 w/ Engine ASN 036348, Utility: 820 Engine BSN 075000, Sprayers: (600 Hi-Cycle, 700, 734 Engine SN 036348-154765)	152 Engine - Diesel	Inframe Kit	\$ 469.00	
		Overhaul Kit	\$ 564.00	
920 Engine ASN 074999, 1020 Engine ASN 154765, Ind: 300 ASN 101359, (300B, 301A BSN 710724), 301, Utility: 820 Engine ASN 074999, 830	152 Engine - Diesel	Inframe Kit	\$ 469.00	
		Overhaul Kit	\$ 538.00	
930, (1020, 1120 Engine ASN 199742), 1030, 1130, 1530 Engine ASN 179600, 2040 BSN 350000, Ind: 300B ASN 710723, 301A ASN 710721, 302, Utility: 830	164 Engine - Diesel	Inframe Kit	\$ 468.00	
		Overhaul Kit	\$ 544.00	
1020 Engine SN 085100-199742, 1120 Engine SN 075000-199742, 1520 Engine ASN 160309, 1530 Engine BSN 179601	164 Engine - Diesel	Inframe Kit	\$ 430.00	
		Overhaul Kit	\$ 536.00	
1120 Engine BSN 075000, 1520	3164DB Engine - Diesel	Inframe Kit	\$ 484.00	
		Overhaul Kit	\$ 560.00	
2020 Engine BSN 159927, 2510, Ind: 400 Transmission BSN 104931, Combine: 45 ASN 046000, Swather: 880	180 Engine - Gas	Inframe Kit	\$ 922.00	
		Overhaul Kit	\$ 773.00	
2020 Engine BSN 75000, 2510 Engine SN 047545-157576, Ind: 400 SN 036277-104242, Swather: 880 Engine BSN 158258	202 Engine - Diesel O-Ring Grooves On Sleeves	Inframe Kit	\$ 645.00	
		Overhaul Kit	\$ 720.00	
(2020, 2510 Engine ASN 157575), Ind: 400 ASN 104241, 401, Swather: 880 Engine ASN 158257	202 Engine - Diesel	Inframe Kit	\$ 572.00	
		Overhaul Kit	\$ 671.00	
2520, Combine: 3300 BSN 003001	202 Engine - Gas Engine BSN 157354	Inframe Kit	\$ 1487.00	
		Overhaul Kit	\$ 1587.00	
	202 Engine - Gas Engine ASN 157353	Inframe Kit	\$ 1610.00	
		Overhaul Kit	\$ 1587.00	
2030 Engine BSN 275485, 2120 Engine SN 075000-199742, 2520 Engine ASN 157575, Combines: (3300, 4400 Engine BSN 277616), Swather: 2270 Engine BSN 277616	4219 and 4219T Engine - Diesel	Inframe Kit	\$ 567.00	
		Overhaul Kit	\$ 664.00	
2030 Engine ASN 275484, 2120 Engine ASN 199742, 2440, Ind: 401B, 401C, 401D, Combines: (3300, 4400 Engine ASN 277615), Cotton Picker: 499 Engine ASN 277615, Sprayer: 6000, Swathers: 2270 Engine ASN 277615, 2280, 2420	4219 and 4219T Engine - Diesel	Inframe Kit	\$ 621.00	
		Overhaul Kit	\$ 707.00	
2120 Engine SN 046067-074999, 2520 Engine BSN 157576	4219D Engine - Diesel	Inframe Kit	\$ 639.00	
		Overhaul Kit	\$ 736.00	
2040, 2150, 2255, Utility: 2155, 2240	3179 Engine - Diesel	Inframe Kit	\$ 433.00	
		Overhaul Kit	\$ 511.00	
2355N	3179T Engine - Diesel	Overhaul Kit	\$ 521.00	
2130, 2350, 2355, 2550, 2555 w/ Collar Shift Transmission, Sprayer: 6000 Engine SN 132891-302609, Swathers: 2360, 3430 Engine BSN 300000	4239 Engine - Diesel	Inframe Kit	\$ 572.00	
		Overhaul Kit	\$ 675.00	
2140, 2555 w/ Syncro Transmission, 2750, 2755, 2855N, Swather: 3830 Engine BSN 300000	4239 and 4239T Engine - Diesel	Inframe Kit	\$ 577.00	
		Overhaul Kit	\$ 685.00	
2630, 2640	4276D Engine - Diesel	Inframe Kit	\$ 669.00	
		Overhaul Kit	\$ 707.00	
3120 Engine BSN 075000, Combines: 55 ASN 083000 w/ Engine BSN 158976, 95 ASN 035000, 95H ASN 037500 with Engine BSN 158976, Cotton Picker: 699 Engine BSN 158976	6303E Engine - Diesel	Inframe Kit	\$ 935.00	
		Overhaul Kit	\$ 1019.00	

John Deere®—Tractor

Application	Description		Retail Price	Core
3120 Engine ASN 74999, Combines: (55 ASN 83000 w/ Engine ASN 158975), 95 ASN 35000, (95H ASN 37500 w/ Engine ASN 158975), Cotton Picker: 699 Engine ASN 158975	6303L Engine - Diesel	Inframe Kit	\$ 842.00	
		Overhaul Kit	\$ 981.00	
2840, 3030, 3130, 4030, Combine: 6600, Cotton Picker: 9900, Cotton Strippers: 482, 484	6329 Engine - Diesel High Compression Piston	Inframe Kit	\$ 1113.00	
2840, 3030, 3130, 4030*, Combines: (4400, 6600 Engine ASN 277647), 4420, Cotton Strippers: 482, 484, 9900 *NR97345 Oil Pan Gasket Required, Not Included	6329 Engine - Diesel Standard Compression Piston	Inframe Kit	\$ 906.00	
		Overhaul Kit	\$ 967.00	
4030* Engine BSN 277550, Combine: 6600 Engine SN 156943-277647, Cotton Pickers: (499, 699 Engine SN 156943-277647) *NR97345 Oil Pan Gasket Required, Not Included	6329 Engine - Diesel	Inframe Kit	\$ 839.00	
		Overhaul Kit	\$ 959.00	
Combine: 6600, Cotton Pickers: 499, 699	6329 Engine - Diesel Engine BSN 156943	Inframe Kit	\$ 680.00	
		Overhaul Kit	\$ 1063.00	
2940, 2950, 2955, 3040, 3055, 3140, 3150, 3155, Combines: 4420, 4425, 4435, Cotton Pickers: 9910, 9920, Cotton Strippers: 484 ASN 0276, 7440	6359 Engine - Diesel High Ring, Piston Marked RE19282	Inframe Kit	\$ 844.00	
		Overhaul Kit	\$ 936.00	
3255, 4050 ASN 006509, Combines: 4435, 9400 Engine BSN 337246, Cotton Pickers: 9920, 9930 Engine BSN 300000, Cotton Stripper: 7445 Engine BSN 300000	6359T Engine - Diesel Low Ring, Piston Marked NRE15600	Inframe Kit	\$ 858.00	
3255, 4050, Combines: 4435 Hydro, 9400 Engine BSN 337246, Cotton Pickers: 9920, 9930, Cotton Stripper: 7445 Engine BSN 300000	6359T Engine - Diesel High Ring, Piston Marked NRE19278	Overhaul Kit	\$ 958.00	
3010, Ind: 500	201 Engine - Gas and LPG	Inframe Kit	\$ 868.00	
		Overhaul Kit	\$ 1075.00	
3020 BSN 122999	227 Engine - LPG	Inframe Kit	\$ 1112.00	
3020 BSN 123000, Ind: 500	227 Engine - Gas	Inframe Kit	\$ 630.00	
		Overhaul Kit	\$ 664.00	
3010 w/ 254 Engine BSN 050000, 3020 w/ 270 Engine SN 050000-124999, Ind: 500 w/ 270 Engine SN 050000-124999	254 and 270 Engine - Diesel All Service Cylinder Kits are 4.250" Bore	Inframe Kit	\$ 731.00	
		Overhaul Kit	\$ 825.00	
3010 w/ 254 Engine BSN 050000, 3020 BSN 130000 w/ 270 Engine, Ind: 500 w/ 270 Engine	254 and 270 Engine - Diesel Replacement Blocks Marked R40910, R46350, R46430 All Service Cylinder Kits are 4.250" Bore	Inframe Kit	\$ 709.00	
		Overhaul Kit	\$ 735.00	
3020, Ind: 500	270 Engine - Diesel Engine SN 050000-124999, Hyperperformance Original Blocks Marked R32020, R40850	Inframe Kit	\$ 965.00	
		Overhaul Kit	\$ 1065.00	
3020 ASN 122999, Ind: 510	270 Engine - Diesel Engine ASN 124999	Inframe Kit	\$ 769.00	
		Overhaul Kit	\$ 691.00	
3020, Ind: 510	270 Engine - Diesel Engine ASN 124999, Hyperperformance	Inframe Kit	\$ 992.00	
		Overhaul Kit	\$ 1071.00	
4020 BSN 201000, Combine: 105 SN 004501-019000, Ind: 600 BSN 201000	6341 Engine - Gas	Inframe Kit	\$ 865.00	
		Overhaul Kit	\$ 926.00	
4020	6341 Engine - Gas and LPG	Inframe Kit	Call for Price	
		Overhaul Kit	Call for Price	
4010 w/ 381D Engine BSN 065000, 4020 w/ 404D Engine SN 065000-214999, Ind: 600 w/ 404D Engine SN 065000-214999, Combine: (105 SN 003001-019000 w/ 404D Engine SN 065000-214999)	381 and 404 Engine - Diesel Original Block Marked R26070, R33180, R34340, R40890, R40900 All Service Cylinder Kits are 4.250" Bore	Inframe Kit	\$ 1026.00	
		Overhaul Kit	\$ 1059.00	
	381 and 404 Engine - Diesel Original Block Marked R26070, R33180, R34340, R40890, R40900, Hyperperformance All Service Cylinder Kits are 4.250" Bore	Inframe Kit	\$ 1376.00	
		Overhaul Kit	\$ 1487.00	

John Deere®—Tractor

Application	Description		Retail Price	Core
4000, 4020 ASN 200999, Ind: 600 ASN 200999, Combines: 105, 6602, 7700 BSN 8001	404 Engine - Diesel	Inframe Kit	\$ 1086.00	
	Engine SN 215000-335845	Overhaul Kit	\$ 1136.00	
	404 Engine - Diesel	Inframe Kit	\$ 1376.00	
	Engine SN 215000-335845, Hyperformance	Overhaul Kit	\$ 1514.00	
4040, 4230, Combines: 6600 ASN 156500, 6602 ASN 001500, 7700 ASN 008000	6404 Engine - Diesel	Inframe Kit	\$ 1070.00	
	Engine ASN 335845	Overhaul Kit	\$ 1151.00	
	6404 Engine - Diesel	Inframe Kit	\$ 1376.00	
	Engine ASN 335845, Hyperformance	Overhaul Kit	\$ 1514.00	
4430, 4630, 7020, Combines: 6600SH ASN 305672, (6602, 7700 ASN 163500), Forage Harvesters: 5200, 5440	6404T and 6404A Engine - Diesel	Inframe Kit	\$ 1167.00	
	Engine ASN 335845	Overhaul Kit	\$ 1286.00	
	6404T and 6404A Engine - Diesel	Inframe Kit	\$ 1502.00	
	Engine ASN 335845, Hyperformance	Overhaul Kit	\$ 1643.00	
4320, 4520, 4620, 7020, Forage Harvester: 5200	6404T and 6404A Engine - Diesel	Inframe Kit	\$ 1195.00	
	Engine SN 215000-335845	Overhaul Kit	\$ 1348.00	
	6404T and 6404A Engine - Diesel	Inframe Kit	\$ 1581.00	
	Engine SN 215000-335845, Hyperformance	Overhaul Kit	\$ 1755.00	
4050, 4240, Combine: 6620	6466D Engine - Diesel	Inframe Kit	\$ 1263.00	
		Overhaul Kit	\$ 1339.00	
4440, 4640, 4840, 8430, 8440, 8450, Combine: 6602, 6620, 6622, 7720, 8820, Cotton Picker: 9940, Forage Harvester: 5720	6466T and 6466A Engine - Diesel	Inframe Kit	\$ 1266.00	
	Early Connecting Rod	Overhaul Kit	\$ 1347.00	
	6466T and 6466A Engine - Diesel	Inframe Kit	\$ 1588.00	
	Early Connecting Rod, Hyperformance	Overhaul Kit	\$ 1773.00	
4250, 4450, 4455, 4650, 4850, 8450, Combines: 6620, 6622, 7720, 7722, 8820, Cotton Pickers: 9940, 9950, Forage Harvesters: 5720, 5730	6466T and 6466A Engine - Diesel	Inframe Kit	\$ 1250.00	
	Late Connecting Rod	Overhaul Kit	\$ 1347.00	
	6466T and 6466A Engine - Diesel	Inframe Kit	\$ 1690.00	
	Late Connecting Rod, Hyperformance	Overhaul Kit	\$ 1812.00	
4055, 4255, 4455, 4555, 4560, 4755, 4760, 7700, 7800, 8100, 8200, 8300, 8570, Combines: 9500, 9600, CTS, Cotton Pickers: 9960, 9965, 9970, Forage Harvester: 6610	6076A and 6076T Engine - Diesel	Inframe Kit	\$ 1650.00	
	Engine BSN 499999, Hyperformance			
(4055, 4255, 4555, 4560, 4755, 4760, 7700, 7800 - w/ Engine BSN 500000), (8100, 8200, 8300 BSN 010000 w/ Engine BSN 500000), 4455, 8570 Engine ASN 568444, Combines: (9500, 9600, CTS Engine BSN 500000), Cotton Pickers: (9960, 9965, 9970 Engine BSN 500000), Forage Harvester: 6610 Engine BSN 500000	6076, 6076A and 6076T Engines - Diesel	Inframe Kit	\$ 1412.00	
(4055, 4255, 4555, 4560, 4755, 4760 Engine BSN 500000), 4455, Combines: (9500, 9600 Engine BSN 500000), Cotton Pickers: 9960 Engine BSN 500000	6076, 6076A and 6076T Engines - Diesel	Overhaul Kit	\$ 1584.00	
8560, 8570, 4955, 4960	6076A and 6076T Engine - Diesel	Inframe Kit	\$ 1374.00	
6030, 7520	6531A Engine - Diesel	Inframe Kit	\$ 2413.00	
		Overhaul Kit	\$ 2362.00	
5010	6531D Engine - Diesel	Inframe Kit	\$ 2919.00	
		Overhaul Kit	\$ 3251.00	
5020, 6030	6531D Engine - Diesel	Inframe Kit	\$ 2482.00	
		Overhaul Kit	\$ 2482.00	
7520	6531T Engine - Diesel	Inframe Kit	\$ 2163.00	
		Overhaul Kit	\$ 2402.00	
8630 Engine BSN 033815, Forage Harvester: 5460 Engine BSN 034541	6619T and 6619A Engine - Diesel	Inframe Kit	\$ 1893.00	
	Early, Curved Counterbore Relief	Overhaul Kit	\$ 1945.00	

John Deere®—Tractor

Application	Description		Retail Price	Core
8640 Engine SN 033815-049059, 8650 Engine BSN 049060, Forage Harvesters: (5460, 5820 Engine SN 034541-048933)	6619T and 6619A Engine - Diesel	Inframe Kit	\$ 1868.00	
	Mid, Curved Counterbore Relief	Overhaul Kit	\$ 2125.00	
8650 Engine ASN 049059, 8760 Engine BSN 500000, Forage Harvesters: (5820, 5830 Engine ASN 048933)	6101 A/H and 6619 A/T Engine - Diesel	Inframe Kit	\$ 1713.00	
	6101 Early, 6619 Late, Square Counterbore Relief	Overhaul Kit	\$ 1952.00	
Swather: 3430 Engine ASN 299999	4039D Engine - Diesel	Inframe Kit	\$ 572.00	
		Overhaul Kit	\$ 675.00	
5500, 6200, 6200L, 6300, 6300L	4039DT Engine - Diesel	Inframe Kit	\$ 661.00	
Sprayers: 6100, 6500, 6600, Swather: 3830 Engine ASN 299999	4039DT Engine - Diesel	Inframe Kit	\$ 616.00	
		Overhaul Kit	\$ 959.00	
5500, 5500N, 6200, 6200L, 6300, 6300L	4039T Engine - Diesel	Overhaul Kit	\$ 849.00	
6400, 6400L, 6500, 6500L	4045DT Engine - Diesel	Inframe Kit	\$ 770.00	
5410, 5415, 5415N, 5420, 5420N, 5615, Ind: 210LE, Skid Steer Loaders: 270, 280	4.5D PowerTech™ Engine - Diesel	Inframe Kit	\$ 704.00	
		Major Overhaul Kit	\$ 705.00	
6110, 6110L, 6120, 6120L, 6210, 6210L, 6215, 6220, 6220L, 6310, 6310L, 6310S, 6320, 6320L, 6403, 6405, 6410, 6410L, 6410S, 6415, 6420, 6420L, 6420S, 6510L, 6510S, 6520L	4045H and 4045T PowerTech™ Engine - Diesel Early	Inframe Kit	\$ 705.00	
	4045H and 4045T PowerTech™ Engine - Diesel Early	Overhaul Kit	\$ 750.00	
	4045H and 4045T PowerTech™ Engine - Diesel Late	Inframe Kit	\$ 705.00	
5425, 5425N, 5510, 5510N, 5520, 5520N, 5525, 5525N, 5715, Ind: 210LE, Sprayer: 6700, Swathers: 4890, 4895	4045T PowerTech™ Engine - Diesel	Inframe Kit	\$ 704.00	
		Overhaul Kit	\$ 741.00	
6603, Cotton Picker: 9935, Cotton Strippers: 7455, 7460, Swather: 4990	6.8T PowerTech™ Engine - Diesel Early Connecting Rod Marked R123959	Inframe Kit	\$ 1049.00	
	6.8T PowerTech™ Engine - Diesel Late Connecting Rod Marked R500000	Overhaul Kit	\$ 1197.00	
		Inframe Kit	\$ 1378.00	
		Overhaul Kit	\$ 1208.00	
(7710, 7810 BSN 090000), (8100, 8200, 8300 ASN 009999), 8100T, 8110, 8110T, 8200T, 8210, 8210T, 8300T, 8310, 8310T, 8400, 8400T, 9100, Combines: 9510, 9550 BSN 700201, 9550SH BSN 700701, Cotton Picker: 9970	8.1 PowerTech™ Engine - Diesel SN 086536-199999	Inframe Kit	\$ 1667.00	
		Overhaul Kit	\$ 1889.00	
(7710, 7810 BSN 90000), (8100, 8200 ASN 009999), 8100T, 8110, 8110T, 8200T, 8210, 8210T, 8300 ASN 009999, 8300T, 8310, 8310T, 8400, 8400T, 9100, Combines: 9510, 9550 BSN 700201, 9550SH BSN 700701, Cotton Picker: 9970	6081 A/H PowerTech™ Engine - Diesel Engine BSN 086536	Inframe Kit	\$ 1668.00	
		Overhaul Kit	\$ 1890.00	

Crankshafts



Application	Description	Part Number	Retail Price	Core
454, 1640, 1830, 1840, 2020, 2030, 2040, 2040S, 2100, 2120, 2130, 2140, 2440, 2510 Diesel, 2550, 2555, 2750, 2755, 6200, 6300, Ind: 401, 401A, 401B, 401C, 401D, Combines: 3300, 6602, 6620, 6622, Sprayer: 6000 Hi-Cycle Replaces R23517, R81959, R94644, RE33197, RE48748, RE57664, T23480, T23517, T28743	Crankshaft (202, 219, 239 BSN 769619), 4039D, 4039T - 4 Cylinder Engines 4.330" Stroke, (202) 3.8579" - 3.859", (219) 4.020", (239) 4.192" - 4.194 Bore, 2.748" - 2.7488" Rod, 3.1235" - 3.1245" Main Flange - No Centering Ring, Flat, 4 Bolt Holes, 1 Dowel Snout - Straight, No Splines, 1 Bolt Hole, 1 Keyway	AMAT18030	\$ 535.00	

John Deere®—Tractor

Application	Description	Part Number	Retail Price	Core
940, 1020, 1030, 1040, 1120, 1130, 1140, 1520, 1530, 1630, 2020, 2040, 2150, 2155, 2255, 2355NCS, 355NTSS, 5200, 5300, 5400, Ind: 300, 300B, 301, 302A, Utility: 820, 830, 2240 Replaces RE46896, RE47637, T23516, T23516T, T20031T	Crankshaft 3-152, 3-164, 3-179, 3029, 3029D Diesel Engines 4.328" Stroke, (152) 3.8581" - 3.8595", (164) 3.875", (179) 4.192", (179T) 4.190" Bore, 2.748" - 2.749" Rod, 3.123" - 3.124" Main Flange - 4 Bolt Holes, 1 Dowel Snout - 1 Bolt Hole, 1 Keyway, w/ Gear	AMAT18031	\$ 660.00	
(1550, 1750, 1850 ASN 92775), 2355N, 5105, 5200, 5205, 5210, 5300, 5320N, 5400, 5400N, Utility: 2155	Crankshaft, Cast	AMRE50979	\$ 750.00	
2630, 2640 Replaces R54501	Crankshaft 4-276D, 4-276T - 276 CID 4.5 Liter 4 Cylinder Diesel Engines 5" Stroke, 4.192" - 4.194" Bore, 3.063" - 3.064" Rod, 3.1235" - 3.1245" Main Flange - 4 Bolt Holes, 1 Dowel Pin Hole Snout - 1 Bolt Hole, 2 Keyways	AMRE56792	\$ 720.00	
2755 Replaces R23909, R81959, R97926, R97928, R121018, RE65224	Crankshaft 4039, 4239 ASN 769620 w/ 2.360" (60 mm) Long Snout Engines 4.331" Stroke, 4.192" - 4.194" Bore, 2.748" - 2.7488" Rod, 3.1236" - 3.1244" Main Flange - No Centering Ring, Flat, 4 Bolt Holes, 1 Dowel Hole Snout - 1 Bolt Hole, 2 Keyways (Keyway 5/16" x 1 1/8"), w/ 24 Tooth Timing Gear, Left Hand Helix	AMRE20585	\$ 575.00	
2840, 2940, 2950, 2955, 3120, 3130, 3140, 3150, 3155TSS, 4030, 4420, 4425, 7484. Utility: 4400, Cotton Pickers: 699, 9900, 9910, 9920, 9930 Replaces R45541, R108658, R108679, RE502190, T23266	Crankshaft 6-303, 6-329, 6-359, 6059D, 6059T Engines 4.330" Stroke, (303) 3.860", (329) 4.020", (359) 4.190" Bore, 2.748" - 2.7488" Rod, 3.1236" - 3.1244" Main Flange - No Centering Ring, Flat, 4 Bolt Holes, 1 Dowel Snout - 1 Bolt Hole, 1 Keyway	AMAT22562	\$ 830.00	
3010, 3020, Ind: 500, 510 Replaces R26540R, R46498	Crankshaft 254 4.2 Liter Diesel Engine BSN 129999 4.750" Stroke, 4.125" Bore, 2.998" - 2.999" Rod, 3.3715" - 3.3725" Main Flange - Flat, 4 Bolt Holes, 2 Dowels Snout - 1 Bolt Hole, 1 Keyway, w/ Balancer Gear	AMAR26428	\$ 1565.00	
3020 ASN 130000, Ind: 500, 510 Replaces R40570, R46498	Crankshaft 4.750" Stroke Flange - Centering Ring, 6 Bolt Holes, 1 Dowels Snout - Straight, 1 Bolt Hole, 1 Keyway, w/ Balanced Gear Installed	AMAR40485	\$ 1650.00	
4000, 4010, 4020, 4040, 4230, 4240, 4430, 4440, 4450, 4630, 4640, 4650, 4840, 4850, 4960, 8430, 8440, 8450, Ind: 600, Combines: 7720 Late, 8820, Cotton Picker: 9950, Forage Harvesters: 5460, 5720, 5730 Replaces AR96189, R26506, R26506R, R56919, R56934, R56979, R63451, R87544A, RE42675, RE53203, RE53477	Crankshaft 466 ASN 50000, 6076 BSN 187657 - 7.6 Liter Diesel Engines w/ Crank Driven Oil Pump 4.750" Stroke, 4.5615" - 4.5635" Bore, 2.998" - 2.999" Rod, 3.372" - 3.373" Main Flange - Centering Ring, 6 Bolt Holes, 1 Dowel Snout - Straight, 3" Short Nose, 1 Bolt Hole, 1 Keyway, w/ Oil Pump Drive Gear, 2.75" Long to the Shoulder of the 1st Main Journal to the End of the Snout	AMRE53422	\$ 1350.00	
4010, 4020 BSN 200999 Replaces AR26431, R26560, RE63292	Crankshaft 6-404 Early, 6.381 Early 4.750" Stroke, 4.250" Bore, 2.998" - 2.999" Rod, 3.3715" - 3.3725" Main Flange - Flat, 4 Bolt Holes, 2 Dowel Holes Snout - 1 Bolt Hole, 1 Keyway, w/ Gear	AMAR26431	\$ 1345.00	
4010, 4020 ASN 201000, 4040, 4230, 4240, 4320, 4430, 4620, 4630, 7020 Replaces R26540, R26560, R26560R, R56919, R56934, RE53422, RE63451	Crankshaft w/o Pump Drive Gear 6-404 Late 6.6 Liter, 6-466 Early 7.6 Liter - Diesel w/o Crank Driven Oil Pump 4.720" Stroke, 4.250" Bore, 2.998" - 2.999" Rod, 3.3715" - 3.3725" Main Flange - Centering Ring, 6 Bolt Holes, 1 Dowel Hole Snout - Bolt Holes, 2 Keyways	AMAR96189	\$ 1350.00	

John Deere®—Tractor

Application	Description	Part Number	Retail Price	Core
4455, 4555, 4755, 4760, 4955, 4960, 7700, 7800, 8560, 8570, Cotton Picker: 9960 Replaces R104855, RE42671, RE63293	Crankshaft w/ Gear 6076, 6076A, 6076D, 6076H, 6076T 7.6 Liter Diesel Engine SN 187658-499999 4.750" Stroke, 4.5615" - 4.5635" Bore, 2.998" - 2.999" Rod, 3.372" - 3.373" Main Flange - Centering Ring, 6 Bolt Holes, 1 Dowel Snout - 1 Bolt Hole, 2 Keyways, 3.40" Long from the Shoulder of the 1st Main Journal to the End of the Snout	AMRE53201	\$ 1350.00	
5403, 5410, 5415, 5415H, 5420, 5420N, 5425, 5425N, 5510, 5510N, 5520, 5520N, 5525, 5525N, 5605, 5615, 5705, 5715, 5715HC, 6110, 6110L, 6120, 6120L, 6210, 6210L, 6215, 6220, 6220L, 6310, 6310L, 6310S, 6320, 6320L, 6403, 6405, 6410, 6410L, 6410S, 6415, 6420, 6420L, 6510L, 6510S, 6520L, Ind: 210LE, Sprayer: 6700 Replaces R113596, RE50618	Crankshaft 4.5 PowerTech™ Straight Nose 4 Cylinder Engine 5" Stroke, 4.192" - 4.194" Bore, 3.063" - 3.064" Rod, 3.123" - 3.124" Main Flange - No Centering Ring, Flat, 4 Bolt Holes, 1 Dowel Hole Snout - Straight, 4 Bolt Holes, 1 Keyway, w/ 30 Tooth Helical Timing Gear	AMRE504638	\$ 775.00	
5605, 5705, 6110L, 6120L, 6210, 6210L, 6215, 6220, 6220L, 6310, 6310L, 6310S, 6320L, 6405, 6410, 6410L, 6410S, 6415 ASN 196071, 6420, 6420L, 6510L, 6510S, 6520L, Premium Models: 6230, 6330 Replaces R503715	Crankshaft 4.5 PowerTech™ Taper Nose 4 Cylinder Engine 5" Stroke, 4.192" - 4.194" Bore, 3.063" - 3.064" Rod, 3.123" - 3.124" Main Flange - No Centering Ring, Flat, 4 Bolt Holes, 1 Dowel Hole Snout - Tapered, 1 Bolt Hole, 1 Keyway, w/ Timing Gear	AMRE506195	\$ 895.00	
6205, 6505, 6510, 6515, 6520, 6800, 6900, 7400, 7410, 7500, 7600, 7630, 7730, 7830, 7930, Combines: 9400, 9560STS, 9570STS, 9580STS, S550, T550, W540 Replaces RE52850, RE515785	Crankshaft 6.8 Power Tech, 414 CID. 6.8 Liter, 6 Cylinder 5" Stroke, 4.192" Bore, 3.063" - 3.064" Rod, 3.123" - 3.124" Main Flange - No Centering Ring, 6 Bolt Holes, 1 Dowel Hole Snout - Straight Double Step Nose, 4 Bolt Holes, w/ 30 Tooth Timing Gear, Left Hand Helix	AMRE504639	\$ 1675.00	
7130, 7220, 7230, 7320, 7330, 7420, 7520, 7630, 7720, 7730, 7820, Combines: 9550, 9550SH, 9560, 9560SH, 9560STS, 9570STS, Cotton Picker: 9970, Sprayers: 4720, 4830 Replaces R503470	Crankshaft 6068HRW60, 6068HRW62, 6068HRW71 - 6.8 PowerTech™ Tier II 414 CID 6.8 Liter 6 Cylinder Engines 5" Stroke, 4.192" Bore, 3.063" Rod, 3.123" Main Flange - No Centering Ring, Flat, 6 Bolt Holes, 1 Dowel Snout - Tapered, 1 Bolt Hole, 1 Keyway, No Timing Gear	AMRE505921	\$ 915.00	
7200, 7400, 7600, Combine: 9400 Replaces R54619, R104523, RE33687, RE502191	Crankshaft 6068, 6068D, 6068T, 6414, 6414D Engines 5" Stroke, 4.192" Bore, 3.063" - 3.064" Rod, 3.123" - 3.124" Main Flange - Flat, 4 Bolt Holes, 1 Dowel Snout - Straight, 1 Keyway, 1 Bolt Hole, 1 Front Helical Gear	AMRE45517	\$ 1350.00	
(7230R, 7250R, 7260R, 7270R, 7280, 7290R BSN 080000), 7310R ASN 080001, 8120, 8220, 8320, 8400R ASN 115000, 8420, 8520, 9360R BSN 014999, 9370R ASN 015000, (8235R, 8260R, 8285, 8310R, 8335R, 8360R SN 016001-090000), (8245R, 8270R, 8295R, 8320R, 8345R, 8370R ASN 090001), (8320RT, 8345RT, 8370RT ASN 912001), Combines: S650, S660, S670, S670HM, S760, S770, Forage Harvesters: (8100, 8200 SN 513822-515599) Sprayers: R4038, R4045 Replaces DZ100385, RE533517, RE565972	Crankshaft 6090 PowerTech™ Engine	AMRE548603	\$ 2700.00	

John Deere®—Tractor

Application	Description	Part Number	Retail Price	Core
7700, 7800, 8100, 8200, 8300, 8560, 8570, Combines: 1185, 2066 European, 9500, 9600, Cotton Pickers: 9965, 9970	Crankshaft 6076 Late 6 Cylinder Engine 4.375" Stroke, 4.5615" - 4.5635" Bore, 2.998" - 2.999" Rod, 3.372" - 3.373" Main Flange - Centering Ring, 6 Bolt Holes, 1 Dowel Hole, w/ 74 Tooth Oil Pump Drive Gear, Right Hand Helix Snout - 1 Bolt Hole, 2 Keyways, w/ 27 Tooth Straight Timing Gear, 3" Nose	AMRG23551	\$ 1550.00	
7720, 7820, 7920, 8120, 8120T, 8220, 8220T, 8320, 8320T, 8420, 8420T, 8520, 8520T, Combines: 9650STS, 9660STS, 9750STS, 9760STS, 9780CTS, Forage Harvesters: 7200, 7300, 7400, 7500	Crankshaft 8.1 PowerTech™ Early BSN 142156 6 Cylinder Engine 5.059" Stroke, 4.560" Bore, 2.998" - 2.999" Rod, 3.748" - 3.749" Main Flange - Centering Ring, 6 Bolt Holes, 1 Dowel Hole, w/ 72 Tooth Straight Oil Pump Drive Gear Snout - Straight, 1 Bolt Hole, 2 Keyways, w/ 27 Tooth Timing Gear 27 mm Wide	AMRE534314	\$ 2175.00	
7810, 7820, 7920, 8100, 8100T, 8110T, 8120T, 8200, 8200T, 8210T, 8220T, 8300, 8300T, 8310T, 8320T, 8400, 8400T, 8410T, 8420T, 8520T, 9100, 9120, Combines: 9510, 9510SH, 9550, 9550SH, 9560STS, 9610, 9650, 9650CTS, 9650STS, 9660, 9660CTS, 9660STS, 9750STS, 9760STS, 9780CTS SN 071443-072697 & ASN 072800, CTS, CTS II, Cotton Pickers: 9970, 9976, 9986, 9996, Sprayer: 4920 Replaces R35502, RE55522	Crankshaft w/ Gears 8.1 PowerTech™ Late 6 Cylinder Engine ASN 142157 5.059" Stroke, 4.560" Bore, 2.998" - 2.999" Rod, 3.748" - 3.749" Main Flange - Centering Ring, 6 Bolt Holes, 1 Dowel Hole, w/ 74 Tooth Oil Pump Drive Gear, Right Hand Helix Snout - Straight, 1 Bolt Hole, 2 Keyways, w/ 27 Tooth Timing Gear 27 mm Wide	AMRE535300	\$ 2175.00	
8120, 8220, 8225R, 8320, 8420, (8245R, 8270R, 8295R, 8320R, 8320RT, 8345RT, 8520 ASN 090001), Combines: S670, S760, S770, Forage Harvesters: 8100, 8200, Sprayer: R4045 Replaces R526075	Crankshaft 6090 PowerTech™ Engine	AMRE540429	\$ 2850.00	
8630, 8640, 8650, Ind: 700, 700A Rplaces AR36350R, AR47403, AR69264, AR78403, R36350, R57730, R63476, R63478	Crankshaft w/ Gear 6-531 8.7 Liter, 6-619 10.1 Liter BSN 499999 - Diesel Engines 5" Stroke, 5.1245" - 5.1263" Bore, 3.498" - 3.499" Rod, 3.748" - 3.749" Main Flange - Flat, 6 Bolt Holes, 2 Large Dowels Snout - Straight, 1 Large Bolt Hole, w/ Timing Gear, w/ Oil Pump Drive Gear	AMAR92533	\$ 2350.00	
Utility: 790, 2720, 3032E, 3033R, 3036E, 3038E, 3045R, 3120, 3203, 3320, 3520, 3720, 4105, 4300, 4310, 4400, 4410	Crankshaft	AMAM880894	\$ 729.00	

Connecting Rods

All connecting rods are cleaned and inspected for defects prior to remanufacturing. Rods are then shot-peened for stress relief and the size is checked against OEM specifications. New piston pin bushings are installed in each rod and bored to the correct center-to-center dimensions. The center-to-center dimension greatly affects the performance of your engine and is a step that many remanufacturers ignore. Final assembly of our connecting rods include installation of new rod bolts and verifying product dimensions, including bend and twist, one final time.



Application	Description	Part Number	Retail Price	Core
2.9 PowerTech™ Engine	Reman Connecting Rod Cast # - R121092	AMCRR121092-R	\$ 155.00	\$ 60.00
8.1 PowerTech™ Engine	Reman Connecting Rod Cast # - R501034	AMCRR501034-R	\$ 215.00	\$ 60.00
Engines: 179T, 239T, 276T, 414 Power Unit	Reman Connecting Rod Cast # - R56187, R58979, 1.625" Pin Diameter	AMCRR56187-R	\$ 140.00	\$ 55.00

John Deere®—Tractor

Application	Description	Part Number	Retail Price	Core
1030, 1130, 1630, 1640, 1830, 1840, 1850, 2030, 2040, 2130, 2150, 2255, 2350, 2355, 2440, 2520, 2550, 2555, 2840, 2950 ASN 630299, 2955, 3030, 3040, 3055, 3130, 3140, 3150, 3155, Utility: 2155 - All w/ 3039D, 4039, 6059D and 6359D Engines	Connecting Rod Cast # - R80034	AMRE21076	\$ 70.00	
1520, 1530, 2020, 2030, 2250, 2510, 2520, 4030	Reman Connecting Rod Cast # - T20007	AMCRT20007-R	\$ 120.00	\$ 20.00
1520, 1530, 2040, 2150, 2255, 2350, 2355, 2440, 2550, 2840, 2940, 2950, 2955, Utility: 2240	Reman Connecting Rod Cast # - R51727	AMCRR51727-R	\$ 120.00	\$ 35.00
2040, 2150, 2255, 2350, 2355, 2440, 2550, 2555, Utility: 2155, 2240	Reman Connecting Rod Cast # - R80034	AMCRR80034-R	\$ 120.00	\$ 35.00
2630, 2640	Reman Connecting Rod 1.375" Pin Diameter Cast # - R54617	AMCRR54617-R	\$ 140.00	\$ 30.00
2750, 2755, 2850, 4050, 5500, 5500N, 6200, 6200L, 6300, 6300L, 7200, 9400 - w/ 4039, 4239T and 6059 Engines	Connecting Rod Cast # - R113612, R80032	AMRE42733	\$ 104.06	
3010, 3020, 4000 Late, 4010, 4020, 4230	Reman Connecting Rod Cast # - R26047	AMCRR26047-R	\$ 130.00	\$ 60.00
3010, 3020, 4010, 4020, 4040, 4230, Combines: 6600, 7700	Connecting Rod Cast # - R26047, R58880, R66923	AMAR70910	\$ 105.20	
4050 Early, 4055, 4250, 4255, 4440, 4450, 4455, 4555, 4560, 4640, 4650, 4755, 4760, 4840, 4850, 4955, 4960, 7700, 7800, 8100, 8200, 8300, 8430, 8440, 8450, 8560, 8570 - w/ 6076 Engine	Connecting Rod Cast # - R71074	AMAR93341	\$ 125.00	
4055, 4250, 4255, 4450, 4455, 4650, 4755, 4850, 4955	Reman Connecting Rod Cast # - R71074	AMCRR71074-R	\$ 165.00	\$ 60.00
4320, 4240, 4430, 4520, 4620, 4630	Reman Connecting Rod Cast # - R41423	AMCRR41423-R	\$ 150.00	\$ 60.00
4440, 4640, 4840	Reman Connecting Rod Cast # - R57303	AMCRR57303-R	\$ 150.00	\$ 60.00
5010, 5020	Reman Connecting Rod Cast # - R35048	AMCRR35048-R	\$ 185.00	\$ 45.00
5410, 5415, 5415N, 5420, 5420N, 5425, 5425N, 5510N, 5520, 5525, 5525N, 5615, 5715, Ind: 210LE, Cotton Pickers: 7455, 7460, Sprayer: 6700	Connecting Rod 1.375" Pin Diameter Replaces RE60272	AMRE500002	\$ 90.00	
6030, 7520	Reman Connecting Rod Cast # - R48315	AMCRR48315-R	\$ 185.00	\$ 45.00
8430, 8530 - w/ 6090H PowerTech™ Plus 9.0 Liter Diesel Engine	Connecting Rod	AMRE535554	\$ 245.00	
8630 Early	Reman Connecting Rod Cast # - R57484	AMCRR57484-R	\$ 185.00	\$ 50.00
8640 Late, 8650	Reman Connecting Rod Cast # - R63959	AMCRR63959-R	\$ 185.00	\$ 60.00



Crankshaft Pulleys and Dampers

Application	Description	Part Number	Retail Price	Core
1830, 2020, 2030, 2130, 2630, 2640, Ind: 401B, 401C, 401D	Crankshaft Pulley w/ Damper Single Groove, 5.59" OD Replaces T24440, T25365, T47412	AMR80808	\$ 110.00	

John Deere®—Tractor

Application	Description	Part Number	Retail Price	Core
2955, 3055, 3155, 3255 - w/o Front PTO	Crankshaft Pulley w/ Damper	AMRE26920	\$ 179.28	
3020, 4000, 4020, 4230 - w/ Gas Engine	Crankshaft Pulley Replaces R34366, R47624	AMR53031	\$ 142.02	
4000, 4010, 4020 - w/ Diesel, w/o A/C	Crankshaft Pulley w/ Damper Single Groove	AMAR58172	\$ 145.00	
4000, 4020 ASN 199000 w/ Diesel Engine and A/C	Crankshaft Pulley w/ Damper Replaces AR48191, AR50394	AMAR58176	\$ 274.68	
4040, 4230, 4240, 4320, 4430, 4440, 4455 Mexico	Crankshaft Pulley w/ Damper	AMAR57241	\$ 155.00	
4050, 4055, 4250, 4255, 4450, 4455, 4555, 4560, 4650 ASN 259893, 4755, 4760, 4850 ASN 259893, 4955, 4960, 8450 ASN 259893, Cotton Pickers: 9950, 9960, 9965, 9970	Crankshaft Pulley w/ Damper	AMRE15018	\$ 185.00	
4320, 4520, 4620, 4630, 7020, Forage Harvesters: 5200, 5400, 5440 - w/ A/C	Crankshaft Pulley, Inner Replaces R46573	AMR48396	\$ 145.60	
4630, 7020 ASN 335845, Forage Harvesters: (5200, 5400 ASN 335845), 5440	Crankshaft Pulley	AMR50414	\$ 425.26	
5225, 5325, 5325N, Utility: 4120, 4320, 4520, 4720	Crankshaft Pulley w/ Sleeve	AMRE520244	\$ 32.41	
(8100, 8200, 8300 BSN 016632), 8100T, 8110T, 8120, 8120T, 8200T, 8210T, 8220, 8220T, 8300T, 8310T, 8320, 8320T, 8400, 8410, 8420, 8420T, 8520, 8520T, 9100 BSN 038791, Combines: (9510, 9510SH BSN 369521), (9610, CTS II BSN 039521), Cotton Picker: 9976 BSN 038791, Forage Harvesters: 6610, 6650	Crankshaft Pulley w/ Damper	AMRE57603	\$ 195.00	
8100, 8100T, 8110, 8110T, 8200, 8200T, 8210, 8210T, 8300, 8300T, 8310, 8310T, Combines: 9500, 9600, CTS	Damper	AMRE24975	\$ 245.00	
8120, 8120T, 8220, 8220T, 8320, 8320T, 8420, 8420T, 8520, 8520T, 9100 ASN 038792, 9120, Combines: 9560STS, 9650STS, 9660STS, 9750STS, 9760STS, Cotton Picker: 9976 w/ HN001 Engine ASN 038791, Forage Harvester: 6610	Damper	AMRE500917	\$ 309.10	
8560, 8570	Crankshaft Pulley w/ Damper	AMRE16127	\$ 620.00	
8560, 8570, 8760, 8770, 8870, 8960, 9200, 9220, 9300, 9320 - w/ Mechanical Shift Transmission	Damper, Engine Drive Coupler Replaces RE23861	AMRE222311	\$ 1825.00	
8970, 9200, 9220, 9300, 9300T, 9320, 9320T, 9330, 9400T, 9410R, 9420, 9420R, 9420T, 9430, 9430T, 9460R, 9460RT, 9470R, 9470RT, 9510R, 9510RT, 9520, 9520R, 9520RT, 9520T, 9530, 9530T, 9560R, 9560RT, 9570R, 9570RT, 9620, 9630, 9630T, Forage Harvesters: 7280, 7380, 7480, 7580, 7780 - All w/ Powershift Transmission	Damper, Flywheel Replaces RE46855, RE222829	AMRE220150	\$ 835.00	
Combines: (9510, 9510SH, 9550, 9550SH, 9610, CTS II ASN 039521), 9650, 9650CTS, 9660, 9660CTS, Cotton Pickers: 9970, 9976 w/ HN003 Engine, 9986, 9996, Forage Harvester: 6610	Damper	AMRE500934	\$ 353.04	
(6120, 6120L, 6215, 6220, 6220L, 6320, 6320L, 6415, 6420, 6420L, 6520L ASN 752632), 6230, 6330, 6430, 7130, 7130, Premium Model: 7330	Engine Mount Rubber Isolator 4 Required	AMAL161468	\$ 38.00	

John Deere®—Tractor



Camshafts and Lifters

Application	Description	Part Number	Retail Price	Core
Models w/ 6076 ASN 500000 or 8.1 PowerTech™ Engine	Camshaft & Lifter Kit Cast # - R120872	AMRE57054	\$ 530.28	
2020, 2030, 2120, 2350, 2355, 2510, 2520, 2550, 2555, 2630, 2640, 2750, 2755, 2855 - w/ 202, 219, 239, 276, 4039 or 4045 Diesel Engine	Camshaft	AMR82820	\$ 140.00	
2940, 2950, 2955, 3120, 3130, 3150, 3155, 4030, 4050, 7200, 7400, 7600, Combines: 4400, 4425, 6600, 9400, Cotton Pickers: 9900, 9910, 9920, 9930, Cotton Strippers: 7445, 7450, 7455 - All w/ 303, 329, 359, 414, 6059 or 6068 Diesel Engine	Camshaft	AMR82821	\$ 225.00	
	Lifter	AMT20073	\$ 10.00	
3010 Early, 3020 - w/ Early 270 Engine	Camshaft & Gear Kit	AMAR32730	\$ 255.00	
	Components:			
	Camshaft 1	AMR46427	\$ 210.00	
	Oil Pump Drive Gear 1	AMR32428	\$ 90.00	
	Lifter	AMR26342	\$ 8.79	
	Block Cast # - R26070, R33180, R34340, R40890, R40900			
3010, 3020 - w/ Early 270 Engine w/ Replacement Block	Camshaft, Lifter & Gear Kit	AMAR49143	\$ 285.00	
	Block Cast # - R46350, R46450			
	Components:			
	Camshaft 1	AMR46427	\$ 210.00	
	Lifter 8	AMR52773	\$ 6.51	
	Oil Pump Drive Gear 1	AMR32428	\$ 90.00	
3020 Late	Camshaft & Lifter Kit	AMAR44393	\$ 345.00	
	Block Cast # - R40700, R48430, R45720			
	Components:			
	Camshaft 1	AMR42351	\$ 250.00	
	Lifter 8	AMR52773	\$ 6.51	
4000, 4020 ASN 201000, 4050, 4230, 4240 - w/ 404D ASN 215000 or 466D (Non-Turbo) Engine	Camshaft & Lifter Kit	AMAR100386	\$ 325.00	
	Block Cast # - R40610, R43310, R45980, R47020, R47110, R4710, R48440, R49470, R49650, R59850, R72128			
4010, 4020 BSN 200999 - w/ 404 Engine BSN 215000	Camshaft & Gear Kit	AMAR32732	\$ 325.00	
	Components:			
	Camshaft 1	AMR33778	\$ 285.00	
	Oil Pump Drive Gear 1	AMR32428	\$ 90.00	
	Lifter	AMR26342	\$ 8.79	
	Block Cast # - R26070, R33180, R34340, R40890, R40900			
4030, Combines: 4400, 4420, 6600, Cotton Picker: 9900 w/ Tachometer Drive Shaft	Reman Camshaft Marked T20464 Replaces AT25185	AMT20464TGRG	\$ 175.00	\$ 50.00

John Deere®—Tractor

Application	Description	Part Number	Retail Price	Core
4055, 4250, 4255, 4320, 4430, 4440, 4450, 4455, 4520, 4620, 4630, 4640, 4650, 4840, 4850, 7020, 8430, 8440, 8450, Combines: 6600, 6620, 7700, 7720, 8820 - All w/ (404A, 404T ASN 335845), 466AASN 67684 or 466T ASN 253372 Diesel Engine	Camshaft & Lifter Kit Block Cast # - R44310, R45980, R47020, R47110, R49470, R49650, R59850, R72128 Components: Camshaft w/o Gear Lifter	AMAR100385 1 AMR71529 12 AMR52773	\$ 325.00 \$ 285.00 \$ 6.51	
	Reman Camshaft Block Cast #- R44310, R45980, R47020, R47110, R49470, R49650, R59850, R72128	AMR71529GRG	\$ 250.00	\$ 50.00
4055, 4255, 4455, 4555, 4560, 4755, 4760, 4955, 4960, 8560 - w/ 6076 Engine BSN 499999	Camshaft & Lifters Kit Cast # - R108370 Components: Camshaft Lifter	AMRG22421 1 AMR108370 12 AMR105379	\$ 425.00 \$ 315.00 \$ 8.16	
5010, 5010-I, 5020, 6030, 7520, 8630, 8640, 8650, 8760, Ind: 700, 700A	Camshaft Replaces R40469, R44982, R54843, R63406, AR36822	AMRE11137	\$ 359.72	
(5010, 5020, 6030 Engine ASN 282915), 7520, 8630, 8640, 8650, 8760 - w/ 531 or 619 Diesel Engine	Reground Lifter	AM531/619	\$ 35.00	\$ 30.00
5010, 5020, 6030, 7520, 8560, 8630, 8640, 8650, 8760, 8960, Ind: 700A, Forage Harvesters: 5200, 5400, 5440, 5460, 5720, 5820, 5730, 5830	Reman Camshaft Replaces R63406, R77447, R77448	AMRE11137GRG	\$ 295.00	\$ 100.00
5210, 5310, 5403, 5410, 5415, 5415N, 5420, 5420N, 5425, 5425N, 5510, 5510N, 5520, 5520N, 5525, 5525N, 5605, 5615, 5705, 5715, 6110, 6110L, 6120, 6120L, 6210, 6210L, 6215, 6220, 6220L, 6310, 6310L, 6310S, 6320, 6320L, 6403, 6405, 6410, 6410L, 6410S, 6415, 6420, 6420L, 6420S, 6510, 6510S, 6520L, 6603, 6605, 6615, 6715, 7210, 7220, 7320, 7405, 7410, 7420, 7505, 7510, 7515, 7520, 7610, 7720, 7810, 7815, 7820, Ind: 210, Combines: 9400, 9410, 9450, 9550, 9550SH, 9560, 9560SH, Cotton Picker: 9935, Cotton Strippers: 7455, 7460, Sprayers: 4700, 4710, 4720, 6700	Lifter 4.5, 6.8 PowerTech™ Engine	AMR123565	\$ 7.19	
5310N, 5510N, 6110, 6110L, 6210, 6210L, 6310, 6310L, 6310S, 6405, 6410L, 6410S, 6510L, 6510S	Reman Camshaft 4.5 Liter	AMR135439RG	\$ 325.00	\$ 50.00
5403, 5410, 5415N, 5420, 5420N, 5510, 5510N, 5520, 5520N, 5605, 5615, 5705, 5715, 6110, 6110L, 6120, 6120L, 6210, 6210L, 6215, 6220, 6220L, 6310, 6310L, 6310S, 6320, 6320L, 6403, 6405, 6410, 6410L, 6410S, 6415, 6420, 6420L, 6420S, 6510, 6510L, 6510S, 6520, 6520L, Ind: 210LE, Sprayer: 6700	Camshaft Replaces R135439	AMRE56375	\$ 255.00	
Utility: 790, 990, 2720, 3032E, 3033R, 3036E, 3038E, 3045R, 3120, 3203, 3320, 3520, 3720, 4005, 4044R, 4049M, 4049R, 4105, 4300, 4310, 4400, 4410, 4500, 4510, 4600, 4610, 4700, 4710	Lifter	AMM801046	\$ 10.00	
Utility: 790, 2720, 3032E, 3033R, 3036E, 3038E, 3045R, 3120, 3203, 3320, 3520, 3720, 4105, 4400, 4410	Camshaft	AMAM876430	\$ 187.15	



Balancer Shafts

Application	Description	Part Number	Retail Price	Core
1640, 1830, 1840 BSN 429999, 2030, 2040, 2040S, 2130, 2350, 2355, 2440, 2510, 2520, 2550, 2555, Sprayer: 6000 Hi-Cycle, Diesel Engines: 202, 219, 239, 239T ASN 746397	Balancer Shaft Replaces AR61351, R54054, RE26282	Right Hand AMRE56349	\$ 85.47	
	Balancer Shaft Replaces AR61352, RE26283	Left Hand AMRE56350	\$ 130.00	
2140, 2555 w/ 4239T Engine BSN 746396, 2630, 2640, 2750, (2755, 2855N Engine BSN 746396), 6400, 6500	Balancer Shaft Weighted Style Cast # - R54634	Right Hand AMAR69710	\$ 90.00	
	Balancer Shaft Weighted Style Cast # - R54634	Left Hand AMAR69711	\$ 90.00	
5410, 5415, 5415N, 5420N, 5425, 5425N, 5510, 5510N, 5520, 5520N, 5525N, 5615, 6110, 6110L, 6120, 6120L, 6210, 6210L, 6215, 6220, 6220L, 6225, 6230, 6310, 6310L, 6310S, 6320, 6320L, 6330, 6403, 6405, 6410, 6410L, 6410S, 6415, 6420, 6420L, 6420S, 6425, 6510L, 6510S, 6520L, 7130, Premium Models: 6230, 6330, 6430, 7130, Ind: 210LE, Sprayer: 6700	Balancer Shaft Replaces RE69364	Right Hand AMRE500448	\$ 120.00	

Cylinder Heads

Our remanufactured cylinder heads are cleaned, pressure-tested and resurfaced. New seats and guides are installed using OEM specifications. These heads are ready for final assembly.



Application	Description	Part Number	Retail Price	Core
2020, 2030, 2750, 2755, 2855 - w/ 202, 4219, 4239 and 4276 Diesel Engines	Reman Cylinder Head, Bare Cast # - R57078, R54560, R56790	AMCHJD219B	\$ 750.00	\$ 100.00
2950 - 2955, 3055, 3150, 3155, 4050	Reman Cylinder Head, Bare Cast # - R61035, R54550, R62143	AMCHJD329B	\$ 1175.00	\$ 100.00
3010	Reman Cylinder Head, Bare Cast # - R26030, R32040	AMCHJD270-2B	\$ 1225.00	\$ 100.00
3020 Late	Reman Cylinder Head, Bare Cast # - R40540	AMCHJD270-3B	\$ 1225.00	\$ 100.00
3020 w/ D270 or D254 Diesel Engine	Reman Cylinder Head, Bare Cast # - R34860	AMCHJD270B	\$ 1225.00	\$ 100.00
4010 w/ D381 Diesel Engine	Reman Cylinder Head, Bare Cast # - R26050	AMCHJD381B	\$ 1400.00	\$ 100.00
4000, 4020 - w/ D381 or D404 Diesel Engine	Reman Cylinder Head, Bare Cast # - R34850	AMCHJD404-1B	\$ 1600.00	\$ 100.00
4020 Late w/ D381 or D404 Diesel Engine	Reman Cylinder Head, Bare Cast # - R40560, R46090	AMCHJD404-2B	\$ 1600.00	\$ 100.00
4030 w/ 6329 Diesel Engine	Reman Cylinder Head, Bare Cast # - R53220	AMCHJD329-3B	\$ 1175.00	\$ 100.00
4030, 4420, 6600	Reman Cylinder Head, Bare 2-Bolt Side Outlet for Thermostat Housing Cast # - R55950	AMCHJD329-2B	\$ 1225.00	\$ 100.00
4040, 4050, 4230 Engine ASN 532430, Combines: (6600, 7700 Engine ASN 532430)	Reman Cylinder Head w/ Valves Replaces AR85231, R58044, R59849, R64730, R86701, RE12975	AMCHJD404-5WV	\$ 2050.00	\$ 200.00
4040, (4050, 4240 Engine BSN 180010), 4230 Engine BSN 532430, Combines: (6600, 7700 Engine ASN 532430), 6620 Engine BSN 197685, 7720 Engine BSN 197682	Reman Cylinder Head w/ Valves Replaces R58044, R59849, R64730, SE501665	AMCHJD466-1WV	\$ 2250.00	\$ 200.00

John Deere®—Tractor

Application	Description	Part Number	Retail Price	Core
4040, 4430, 4440, 4630, 4640, 4840, 8440 - w/ DT404 or 466 Engine	Reman Cylinder Head, Bare Cast # - 76315, R58673, R59876, R61521, R67906	AMCHJD466-2B	\$ 1700.00	\$ 100.00
4050, 4250, 4450, 4650, 4850, 8450 - w/ DT466 Engine, H Pattern	Reman Cylinder Head, Bare Cast # - R67906, R76315, R76384, R86696	AMCHJD466-4B	\$ 1700.00	\$ 200.00
4230 w/ D404 Engine	Reman Cylinder Head, Bare Cast # - R53200 (Pencil Injectors)	AMCHJD404-3B	\$ 1600.00	\$ 100.00
	Reman Cylinder Head, Bare Cast # - R59849	AMCHJD404-5B	\$ 1600.00	\$ 100.00
4050 - w/ D466 (Non-Turbo) Engine	Reman Cylinder Head, Bare Cast # - R75641, R86701	AMCHJD466-3B	\$ 1700.00	\$ 100.00
4230, 4240, 4050 - w/ 6466 (Non-Turbo) Engine	Reman Cylinder Head, Bare Cast # - R58044, R64730	AMCHJD466-1B	\$ 1800.00	\$ 350.00
4230, 4620 - w/ 6404 Engine	Reman Cylinder Head, Bare Cast # - R47320	AMCHJD404-7B	\$ 1600.00	\$ 100.00
4520 w/ D404 Engine	Reman Cylinder Head, Bare Cast # - R43120, R43920	AMCHJD404-6B	\$ 1600.00	\$ 100.00
4755, 4955, Combine: 9600	Reman Cylinder Head, Bare Cast # - R86427, R102932, R122112, R122491	AMCHJD6076-1B	\$ 1850.00	\$ 100.00
	Reman Cylinder Head w/ Valves	AMCHJD6076-1WV	\$ 2450.00	\$ 350.00
5020 w/ D531 or D619 Engine	Reman Cylinder Head, Bare Cast # - R40100, R41867 Pencil Injector	AMCHJD531-1B	\$ 2050.00	\$ 100.00
6030, 7520 - w/ D531 Engine	Reman Cylinder Head, Bare Cast # - R48270 Smooth Injector, R86702 Same as Big Injector	AMCHJD531-2B	\$ 2050.00	\$ 100.00
7130, 7230, 7330, 7430	Reman Cylinder Head, Bare Cast # - R519581	AMCHJD6.8-B24	\$ 2500.00	\$ 500.00
8630, 8640 - w/ 619 Engine	Reman Cylinder Head, Bare Cast # - R57425, R74124, R81234, R86703	AMCHJD619B	\$ 2050.00	\$ 1000.00
8760	Reman Cylinder Head, Bare Cast # - R100259	AMCHJD10.1-B	\$ 2750.00	\$ 500.00
	Reman Cylinder Head w/ Valves	AMCHJD10.1-WV	\$ 3500.00	\$ 500.00
8770, 8870	Reman Cylinder Head, Bare Cast # - R119814, R121675	AMCHJD10.1-1B	\$ 4950.00	\$ 1000.00
	Reman Cylinder Head w/ Valves Replaces R121675	AMCHJD10.1-1WV	\$ 5700.00	\$ 1000.00
8850	Reman Cylinder Head, Bare Cast # - R73272	AMCHJD8955B	\$ 1500.00	\$ 100.00
8130, 8230, 8330, 8430, 8530, 9230, Combines: 9660, 9760STS, 9770STS	Reman Cylinder Head w/ Valves Cast # - R525583 Will Not Replace other Cast Numbers Replaces SE501747, RE523680, RE530370	AMCHJD9.0-WV	\$ 2650.00	\$ 500.00
9100, 9120, 9200, 9220, 9300, 9300T, 9320, 9320T, 9400, 9400T, 9420, 9420T, 9520, 9520T, 9620, 9620T, Combines: 9750STS, 9860STS, 9880STS, Forage Harvesters: 7200, 7300, 7400, 7500, 7700, 7800	Reman Cylinder Head w/ Valves Single Fuel Rail Replaces R515452, R518554, SE500708	AMCHJD12.5-2WV	\$ 6500.00	\$ 2000.00
9200, 9300, 9300T, 9400, 9400T, Forage Harvesters: 6750, 6850, 6950 - All w/ Engine BSN 010637	Reman Cylinder Head w/ Valves Dual Fuel Rail Replaces R115594, R136222, RE69912	AMCHJD12.5-1WV	\$ 6500.00	\$ 2000.00

John Deere®—Tractor

Application	Description	Part Number	Retail Price	Core
9410R, 9420R, 9420RX, 9430, 9430T, 9460R, 9470R, 9470RT, 9470RX, 9520R, 9520RT, 9520RX, 9530, 9530T, 9570R, 9570RT, 9570RX, 9630, 9630T, Combines: 9870STS, S680, S680HM, S690, S690HM, S780, S790, Cotton Pickers: 7760, CP690, Forage Harvesters: 7350, 7280, 7450, 7480, 7550, 7580, 8300, 8400, 8500, 8600	Reman Cylinder Head w/ Valves Cast # - R525711 Replaces RE542776, SE5025698	AMCHJD13.5-2WV	\$ 6300.00	\$ 2500.00
4055, 4255, 4455, 4555, 4560, 4755, 4760, 4955, 4960, 7700, 7800, 8100, 8200, 8300, 8560, 8570, Combines: 9500, 9600, CTS, Cotton Pickers: 9960, 9965, 9970, Forage Harvester: 6610	Valve Train Kit Includes (6) Exhaust Valves*, (6) Intake Valves**, (12) Valve Springs, (12) Valve Rotators and (24) Valve Keepers *6.172" Long, 30° **6.055" Long, 30° Replaces R84619, R91822, RE11410	AMVK1042	\$ 352.00	
2030, 2040, 2120, 2130, 2350, 2355, 2440, 2510, 2520, 2550, 2630, 2640, Ind: 400, 401, 401B, Combine: 3300, Cotton Picker: 499, Sprayer: 6000	Valve Train Kit Includes (4) Exhaust Valves*, (4) Intake Valves, (8) Valve Springs and (16) Valve Keepers *5.155" Long, 45° Replaces R26125, R79623, R79624	AMVK1043	\$ 74.00	
2040, 2150, 2255, Ind: 301, 301A, 302, Utility: 2155, 2240	Valve Train Kit Includes (3) Exhaust Valves*, (3) Intake Valves*, (6) Valve Springs and (12) Valve Keepers *5.155" Long, 45° Replaces R26125, R79623, R79624	AMVK1044	\$ 56.00	

Oil Pumps, Engine

All of our remanufactured engine oil pumps are disassembled, thoroughly cleaned and inspected. All worn parts are replaced and tolerances are checked to guarantee our oil pumps will perform to OEM specifications. The pump is reassembled and - as a safety measure - each pump is lubricated with Clevite Bearing Guard to ensure there is no damage during initial start up. Replacing the engine oil pump during an overhaul is a step many people overlook.



Application	Description	Part Number	Retail Price	Core
2150, 2255, 2350, 2355, 2355N, 2550, 2555, 2750, 2755, 2855N, 2950, 2955, 3055, 3150, 3155, 3255, 5105 w/ Engine BSN 279979, 5200, 5205 w/ Engine BSN 292061, (5210, 5220, 5310, 5310N, 5320, 5320N Early), 5300, 5400, 5400N, 5410, 5500, 5500N, 5510, 6200, 6200L, 6300, 6300L, 6400, 6400L, 6500, 6500L, Utility: 2155, 2240 BSN 349999	Oil Pump Repair Kit Includes (2) Oil Tubes and (2) O-Rings Marked R54615 Replaces DD14760, RE35685	AMRE52020	\$ 131.00	
Engines: 4039, 4045, 4239, 4276, 6359D, 6359T	Reman Engine Oil Pump Housing Marked R54629 or R97587, 1-Piece Cast Housing w/ Steel Plate, 2" Wide Gears Includes Oil Pump Intake (Sump)	AMAR79464R	\$ 430.00	\$ 200.00
Engines: 4039, 4045, 4239, 4276, 6359D, 6359T	Engine Oil Pump Housing Marked R54629 or R97587, 1-Piece Cast Housing w/ Steel Plate, 2" Wide Gears Does Not Include Oil Pump Intake (Sump)	AMAR79463	\$ 132.06	
Tractors w/ 619 Diesel Engine	Reman Engine Oil Pump Crankshaft Driven	AMAR94478R	\$ 735.00	\$ 200.00
4555, 4560, 4640, 4650, 4755, 4760, 4840, 4850, 4955, 4960, 8430, 8440, 8450, 8650, Combines: 9500, 9600 - All w/ 6466 Diesel Engine	Reman Engine Oil Pump Crankshaft Driven	AMAR99341R	\$ 650.00	\$ 200.00
152, 164, 179, 202, 219, 239, 239T, 303, 329, 359	Engine Oil Pump Housing Marked R54615, 2-Piece Cast Iron Housing, 1 5/8" Wide Gears	AMRE55343	\$ 69.00	

John Deere®—Tractor

Application	Description	Part Number	Retail Price	Core
3010 Diesel Engine BSN 33000	Reman Engine Oil Pump 3-Piece Shaft and Gear Style, Camshaft Driven 15 Tooth Drive Gear	AMAR76546R	\$ 735.00	\$ 200.00
3010, 3020 - w/ Gas	Reman Engine Oil Pump	AMAR31884R	\$ 735.00	\$ 200.00
3010, 3020 Engine BSN 033000 - w/ Diesel	Reman Engine Oil Pump 3-Piece Shaft and Gear Style, Camshaft Driven 20 Tooth Drive Gear	AMAR76545R	\$ 735.00	\$ 200.00
3020 Diesel Engine ASN 033000	Reman Engine Oil Pump 1-Piece Shaft and Gear Style, Camshaft Driven 20 Tooth Drive Gear	AMAR31885R	\$ 735.00	\$ 200.00
4010 Diesel Engine BSN 039499	Reman Engine Oil Pump 3-Piece Shaft and Gear Style, Camshaft Driven 15 Tooth Drive Gear	AMAR53106R	\$ 735.00	\$ 200.00
4010 Engine ASN 039500, 4020 - w/ Diesel	Reman Engine Oil Pump 1-Piece Shaft and Gear Style, Camshaft Driven 20 Tooth Drive Gear	AMAR53103R	\$ 735.00	\$ 200.00
4020 Diesel	Reman Engine Oil Pump 3-Piece Shaft and Gear Style, Camshaft Driven 20 Tooth Drive Gear	AMAR31887R	\$ 735.00	\$ 200.00
4040, 4230, 4240, 4430, 4440, 4630, 7020 ASN 335846	Reman Engine Oil Pump Camshaft Driven	AMAR77489R	\$ 735.00	\$ 200.00
4050, 4055, 4250, 4255, 4450, 4455, 4555, 4560, 4650, 4755, 4760, 4850, 4955, 4960, 7520, 7710, 7810, 8100T, 8110, 8120, 8200T, 8210, 8220, 8300T, 8310, 8320, 8400T, 8410, 8420, 8520, 8560, 8760, 8770, 8870, 8970	Engine Oil Pump Crankshaft Driven Early models w/ cast elbow built into the pump will require RE42653 Bolt-On Pickup Tube and Screen Assembly	AMRE507076	\$ 220.82	
4320, 4520, 4620	Reman Engine Oil Pump Camshaft Driven, Has Slotted Shaft for Injection Pump	AMAR75896SR	\$ 735.00	\$ 200.00
4620, 7020	Reman Engine Oil Pump Camshaft Driven	AMAR75896R	\$ 735.00	\$ 200.00
4640, 4840, 8430, 8440	Reman Engine Oil Pump Camshaft Driven	AMAR77493R	\$ 735.00	\$ 200.00
5010, 5020, 6030 - w/ 531D Diesel Engine	Reman Engine Oil Pump Camshaft Driven	AMAR68310R	\$ 735.00	\$ 200.00
5103, 5105 w/ Engine ASN 279978, 5205 w/ Engine ASN 292060, (5210, 5220, 5310, 5310N, 5320, 5420N, 5520N - Late), 5303, 5403	Engine Oil Pump Marked RE515079	AMRE515746	\$ 365.76	
5410, 5510, 5420, 5520, 5403, 5605, 5705, 6110, 6210, 6310, 6410, 6220, 6215, 6320, 6403, 6405, 6415, 6420, 6603, 6605, 6615, 6617, 7210, 7410, 7510, 7220, 7320, 7405, 7420, 7505, 7520, 7720, 7820	Engine Oil Pump	AMRE504914	\$ 175.00	
6030, 7520, 8630, 8640, Forage Harvesters: 5200, 5400, 5460	Reman Engine Oil Pump Camshaft Driven Replaces AR68312	AMAR76543R	\$ 735.00	\$ 200.00
7700, 7800, (8100, 8200, 8300 BSN 009999), 8570, Combines: 9500, 9600 ASN 500000, Forage Harvester: 6610 - All w/ Late 6076 Engine	Engine Oil Pump 1-Piece Cast Iron Housing w/ Cover, Crankshaft Driven Does Not Include Oil Pump Intake (Sump)	AMRE507074	\$ 290.00	

John Deere®—Tractor

Application	Description	Part Number	Retail Price	Core
8130, (8225R, 8320R SN 000101-053099), (8235R, 8260R, 8285R, 8360R SN 016001-090000), (8245R, 8270R, 8295R, 8345R ASN 000101), 8295RT SN 900101-907100, (8310R, 8335RT, 8360RT SN 902501-912000), 8320RT ASN 016001, (8345RT, 8370R ASN 090001), 8370RT ASN 912001, 8430, 9230, 9370R ASN 015000, Combines: 9670STS, 9770STS, C670, S650 SN 765000-785000, (S660, S670 ASN 745100), T560, T660, T670, Cotton Picker: 7760, Forage Harvesters: 7180, 7250, (8100, 8200 ASN 513822), Sprayers: 4930, 4940	Engine Oil Pump	AMRE543187	\$ 295.00	
Combines: 6600, 6620, 7700, 7720, 8820	Reman Engine Oil Pump Camshaft Driven	AMAR77491R	\$ 735.00	\$ 200.00
Combines: 6620, 7720, 8820 - w/ 466 Diesel Engine	Reman Engine Oil Pump Crankshaft Driven	AMAR103695R	\$ 735.00	\$ 200.00
Utility: 790, 990, 2720, 3032E, 3033R, 3320, 3520, 3720, 4005, 4044R, 4049M, 4049R, 4105, 4300, 4310, 4400, 4410, 4700, 4710	Engine Oil Pump	AMAM878778	\$ 133.00	
5076E, 5076EL, 5083E, 5083EN, 5090E, 5090EH, 5090EL, 5090M, 5093E, 5093EN, 5101E, 5101EN, 5425, 5425N, 5525, 5525N, 5603, 5625, 5725N, 6100D, (6110, 6110L, 6210, 6210L, 6310, 6310L, 6310S, 6405, 6410, 6410L, 6410S, 6510L, 6510S ASN 550949), 6110D, 6115D, 6120, 6120L, 6125D, 6130D, 6140D, 6140J, 6155J, 6215, 6220, 6220L, 6320, 6320L, 6415, 6420, 6420L, 6520, 6520L, (6605, 6810, 6910 ASN 557343), 6615, 6715, 7220, 7320, 7405, 7420, 7505, 7520	Engine Oil Dipstick 12.677" Long	AMRE502740	\$ 14.53	
5076E, 5076EF, 5076EL, 5082E, 5090E, 5090EH, 5090EL, 5090EN, 5320N, 5410, 5415, 5415H, 5420, 5420N, 5425N, 5510, 5520, 5520N, 5605, 5615, 5705, 5715, 5715HC, 5725N, 6403, 6603, 7210, 7410, 7610, 7630, 7710, 7720, 7730, 7810, 7820, 7830, 7920, 7930, Combines: 9400, 9410, 9450, 9550, 9550SH, 9560, 9560SH, 9560STS, 9570STS, S550, Cotton Pickers: 9935, 9970, Cotton Stripper: 7460, Sprayers: 4700, 4710, 4720, 4730, 4830, 6700 SN 046261-822168, Swathers: 4890, 4895, 4990, 4995, R450	Engine Oil Dipstick	AMRE69243	\$ 8.44	
3020, 4000, 4010, 4020, 4230, 4240, 4250, 4320, 4430, 4440, 4520, 4620, 4630, (4640, 4840 BSN 116896), 5010, 5020, 6030, 7020, 7520, (8430, 8440 BSN 161921), 8560, 8570, 8770, 8870, Cotton Pickers: 9940, 9950, 9960, 9965, 9970, Forage Harvesters: 5200, 5400, 5440, 5460, 5720, 5730, 6610, 6710	Oil Pan Drain Plug 1 1/4" Diameter Use w/ A4827R Washer Replaces R26727	AMR51944	\$ 17.70	

John Deere®—Tractor

Application	Description	Part Number	Retail Price	Core
1020 BSN 248001, 1520, 1530, 2020, 2030, 2140, 2150, 2255, 2350, 2355, 2355N, 2440, 2510, 2520, 2550, 2555, 2630, 2640, 2750, 2755, 2840, 2855N, 2940, 2950, 2955, 3055, 3150, 3155, 3255, 4030, 4050, 6200, 6200L, 6300, 6300L, 6400, 6400L, 6500, 6500L, 7200, 7400, 7600, Utility: 820, 830, 2040, 2155, 2240, Combines: 3300, 4400, 4420, 6600, 9400 BSN 701276, Cotton Pickers: 484, 9900, 9910, 9920, 9930, Cotton Strippers: 7440, 7445, 7450, Sprayers: 6000, 6100, 6500, 6600, Swathers: 2270, 2280, 2360, 2420, 3430, 3830	Oil Pump Drive Gear 33 Tooth, 0.55" ID, 3.625" OD	AMT20298	\$ 160.56	
7200, 7210, 7400, 7410, 7510, 7600, 7700, 7710, 7800, 7810, Cotton Pickers: 9976, 9986, Sprayers: 4700, 4710	Engine Oil Pressure Switch 0.125" Thread Size	AMRE55145	\$ 65.45	

Oil Pump Components



Application	Description	Part Number	Retail Price	Core
3010, 3020, 4000, 4010, 4020 - w/ 4-270D or 404D BSN 335845 Diesel Engine	Oil Pump Drive Gear Oil Pump Drive Gear w/ Shaft	AMR32428 AMR45134	\$ 90.00 \$ 200.00	
3010, 3020, 4010, 4020 Early	Oil Pump Drive Gear w/ Shaft	AMAR30012	\$ 265.00	
4040, 4050, 4230, 4640, 4840, 8430, 8440 - w/ 404D ASN 335846, 404T ASN 280001, 466 BSN 169336, and 466T BSN 253372 Diesel Engines	Oil Pump Drive Gear w/ Shaft	AMR64568	\$ 110.00	

Oil Coolers, Engine



Application	Description	Part Number	Retail Price	Core
1630, 1640, 2030, 2040, 2040S, 2130, (2150, 2255 Engine BSN 704045), 2350, 2355, 2550, 2555, 2750, 2755, 2855N, 2940, 2950, 2955, 3150, 3155, 4030, 4050, Utility: 2240 Engine BSN 794193	Oil Cooler	AMRE31929	\$ 129.79	
2030, 2150 ASN 704046, 2255 ASN 704046, 2355, 2355N, 2555, 2940 ASN 794194, 2955 BSN 765516, 3055, 3255, 5205, 5210, 5300, 5310, 5310N, 5320N, 5400, 5400N, 5500, 5500N, Utility: 2155	Oil Cooler w/ Gasket	AMRE61767	\$ 212.91	
2630, 2640, 7400, 7500, 7600, Combine: 9400	Oil Cooler Core Diameter: 2.375" Replaces AR65812	AMRE31089	\$ 469.58	
2555, 2755, 2855N, 3155, 4050, 6200, 6200L, 6300, 6330L, 6400, 6400L, 6500, 6500L	Oil Cooler w/ Gasket	AMRE61769	\$ 236.15	
4050, (4050E, 4250, 4450, 4650, 4850 - w/ Engine BSN 336699), 4440, 4630, 4640, 4840, 7020 w/ Engine ASN 335846, 8430, 8440, 8450, Combine: 8820 w/ Engine BSN 336699, Cotton Pickers: 9940, 9950 w/ Engine BSN 336699, Forage Harvesters: (5200, 5400 - w/ Engine ASN 335846), 5440, 5460, (5720, 5730 - w/ Engine BSN 336699), 5820, Engines: 6-404A, (6-466A, 6-466T BSN 336699), 6076 A, H or T w/ BSN 100665	Oil Cooler, 12-Plate	AMAT25038	\$ 188.51	
4040, 4050, 4055, 4230, 4240, 4250, 4255, 4430, 4450, 4455, 4555, 4560, 4650, 4755, 4760, 4850, 4955, 4960, 7710, 7810, (8100, 8100T, 8120, 8200, 8200T, 8210, 8210T, 8300, 8300T - w/ 8.1L Engine), 8220, 8220T, 8310, 8310T, 8320, 8320T, 8400, 8400T, 8410, 8410T, 8420, 8420T, 8520, 8520T, 8560 BSN 499999, 8760, 8960, 9100, 9120, 9200, 9300, 9400, Combines: 6600, 6620, 6622, 7700, 7720, 8820, 9500, 9500SH, 9510, 9510SH, 9600, 9610, 9650CTS, 9650STS, 9660, 9660CTS, 9750STS, CTS II, Cotton Pickers: 9950, 9960, 9970, 9976, 9986, Engines: 6-404D, 6-404T, (6-466A, 6-466T ASN 336699), 6-466D, 6076 A, H or T A w/ SN 100665-547545, 6081 PowerTech™	Oil Cooler, 8-Plate	AMAR55394	\$ 200.00	

Prices Subject to Change without Prior Notice. The use of original equipment manufacturer (OEM) part numbers or trademarks, e.g. Case® and John Deere®, are for reference purposes only and for indicating product use and compatibility. Our company and the listed replacement parts contained herein are not sponsored, approved or manufactured by the OEM. All parts are New unless designated Reman in the description.

John Deere®—Tractor

Application	Description	Part Number	Retail Price	Core
5065M, 5075M, 5225, 5325, 5325N, Utility: 4120, 4320, 4520, 4720	Oil Cooler, 9-Plate	AMRE515469	\$ 188.95	
6110, 6110L, 6120, 6120L, 6210, 6210L, 6215, 6220, 6220L, 6310, 6310L, 6310S, 6320, 6320L, 6403, 6405, 6410, 6410L, 6410S, 6415, 6420, 6420L, 6420S, 6510L, 6510S, 6520, 6520L, 6525, 6530, 6603, 6605, 6615, 6620, 6630, 6715, 6830, 6930, 7130, 7210, 7220, 7230, 7320, 7330, 7405, 7410, 7420, 7500, 7510, 7520, 7610, 7630, 7730, 7815, 7830, 7930, Premium Models: 7130, 7230, 7330, 7430, Combines: 1165, 1170, 1175, 1175H, 9400, 9410, 9450, 9550, 9550SH, 9560, 9560SH, 9560STS, 9570STS, Cotton Pickers: 9935, 9970, Cotton Strippers: 7455, 7460, Sprayers: 4700, 4710, 4720, Swathers: 4990, 4995	Oil Cooler, 9-Plate Replaces RE560754	AMRE59298	\$ 175.00	
7700, 8100, 8200, 8300, 8560 Engine ASN 500000, 8570, Combines: 9500 w/ 6076 Engine ASN 500000, 9500SH, 9600, CTS w/ 6076-HH030 Engine, Cotton Pickers: 9960 ASN 4001, 9965, 9970 w/ 6076-AN031 Engine, Forage Harvester: 6610	Oil Cooler w/ Gaskets	AMRE36367	\$ 420.34	
1040, 1140, 1630, 1840, (2030, 2130 ASN 062675), 2040, 2040S, 2140, (2150, 2255 BSN 704045), 2350, 2550, 2750, 2940, 2950, 2955, 3040, 3140, 4030, 4040S BSN 599666, (2250, 2355, 2450, 2555, 2650, 3050, 3150, 3340 BSN 794193), Ind: 401D, Utility: 2240, Combines: 3300, 4400, 4420, 6600, Cotton Pickers: 9900, 9910, 9920, Cotton Strippers: 484, 7440, Sprayer: 6000 Hi-Cycle, Swathers: 2270, 2280, 2360, 2420, 3430	Oil Cooler Hose 0.63" ID, 1.319" Long	AMR55127	\$ 10.15	
1520 w/ Hi-Lo Shift or Reverser, 1830, 2020, 2030, 2120, 2130, 2355, 2355N, (2440, 2630, 2640 w/ 23-CM3 or 39-CM3 Pump), 2555, 2755, 2840, 2855N, 3020 BSN 122999 w/ Engine ASN 115367, 3030, 3130, 4020 ASN 165210, 4040S, 4240, 4240S, 4350, 4440, 4455, 4640 w/ Quad-Range™ or Powershift, 4840 w/ Powershift, 7200, 7400, 7600, Ind: 300B, 301A, (302, 401B - w/ Power Steering), 302A w/o Reverser, 401 w/ 11-CM3, 23-CM3 or 50-CM3 Pump, 401C, 401D w/ 23-CM3 or 50-CM3 Pump, Utility: 2155, 2240 BSN 349999 w/ Hi-Lo Shift	Oil Cooler Hose 0.75", ID, 22" Overall TY22423, Also Replaces L35843, R109884, R109885 when cut to proper length	AMTY22423	\$ 11.05	
5065M, 5075M, 5225, 5325, 5325N	Oil Cooler Hose	AMR516071	\$ 12.44	



Radiators and Components

Application	Description	Part Number	Retail Price	Core
Ind Tractor: 401D	Radiator Core: 13 3/4" x 20 1/8" x 2 5/8"	AMAT32527	\$ 480.00	
(920, 1120 ASN 075430), 1020 ASN 075430 or w/ Hi-Lo Shift or Reverser, 1030, 1130, 1530, 1630, 2040 BSN 349999, Utility: 820 ASN 075430, 830, 2240 BSN 349999	Radiator w/ Oil Cooler/Partition Core: 14 3/8" x 25" x 2 7/8"	AMAT20849	\$ 210.00	
(920, 1020, 1120 BSN 075429), Utility: 820 BSN 075429 - All w/o Reverser or Hi-Lo Shift	Radiator	AMAT20797	\$ 325.00	
940, 1040, 1140, 2040 ASN 350000, 2150, 2255, Utility: 2155 BSN 621999, 2240 ASN 350000	Radiator Core: 14 1/4" x 13 1/4" x 2 7/8" Replaces AL31503	AMAL39290	\$ 245.00	
1520 w/ Hi-Lo Shift or Reverser, 2020, 2030, (2440, 2640 BSN 341000), 2630, Ind: 300B, 301A, 302, 302A, 401B, 401C, 400, 401	Radiator w/o Side Mount Oil Cooler Replaces AT20847, AT28810	AMAR65715	\$ 235.00	
1640, 1840, 2040, 2040S, 2140, 2350, 2550, 2750	Radiator w/o Oil Cooler/Partition Core: 18 1/2" x 20 11/16" 4 Rows of Tubes Replaces AL31237	AMAL37568	\$ 390.00	
(2250, 2355, 2450, 2555, 2650, 2650N 2755, 2850, 2855N BSN 669788)	Radiator Overall: 19 3/4" x 28" Core: 19" x 20 3/4" x 2 11/16" 4 Rows, 9 Fins per Inch	AMAL56372	\$ 485.00	

John Deere®—Tractor

Application	Description	Part Number	Retail Price	Core
(2440, 2640 ASN 341000)	Radiator Overall: 14 1/4" x 26 5/8" Core: 13 1/4" x 20" x 2 7/8" 4 Rows, 9 Fins per Inch	AMAR90945	\$ 250.00	
2510, 2520	Radiator Overall: 18 7/8" x 26 7/8" Core: 18 1/4" x 20 1/16" x 2 1/4" 3 Row, 10 Fins per Inch	AMAR38551	\$ 360.00	
2840, 3030, 3120, 3130	Radiator Core: 16.00" x 23 3/8" x 2 3/4" 4 Rows, 10 Fins per Inch	AMAT26474	\$ 465.00	
2940, 2950, 3040, 3140	Radiator Overall: 19 11/16" x 31 3/8** Core: 19 1/16" x 24 7/16" 4 Rows, 10 Fins per Inch *Height Measurement Does Not Include Filler Neck	AMAL37566	\$ 425.00	
2955, 3050, 3055, 3155, 3255, 3355, 3650 - w/ Coolant Tank	Radiator Overall: 19 5/8" x 27 1/2" Core: 19" x 23 3/4" 4 Rows, 10 Fins per Inch	AMAL66766	\$ 495.00	
2955, 3050, 3350 - w/o Coolant Tank	Radiator Overall: 20 3/4" x 31 1/2** Core: 18 1/2" x 24 1/4" 4 Rows, 8 Fins per Inch *Height Measurement Does Not Include Filler Neck	AMAL56375	\$ 495.00	
3010 Gas or Diesel	Radiator Overall: 18 7/8" x 29 1/2" Core: 18" x 22 5/8" x 2" 3 Rows, 9 Fins per Inch	AMAR46437	\$ 325.00	
3020 Gas, LPG or Diesel	Radiator Overall: 19 1/2" x 29 1/2" Core: 18" x 22 1/4" x 2" 3 Rows, 8 Fins per Inch Does Not Have Holes Through Upper Tank for LPG Fuel Lines	AMAR46016	\$ 350.00	
4000, 4010, 4020 - LPG	Radiator Overall: 20 5/8" x 31 1/4" Core: 19 1/2" x 24 1/4" x 2 3/4" 5 Rows, 9 Fins per Inch	AMAR49454-LP	\$ 715.00	
4000, 4020 - Diesel	Radiator Overall: 20 5/8" x 31 1/4" Core: 19 1/2" x 24 3/8" x 2 7/8" 4 Rows, 10 Fins per Inch	AMAR49454	\$ 425.00	
4010	Radiator Overall: 20 1/2" x 31 1/2" Core: 19 1/4" x 24 1/2" x 2 3/8" 4 Rows, 9 Fins per Inch Does Not Have Holes Through Upper Tank for LPG Fuel Lines	AMAR46438	\$ 425.00	
4030	Radiator Overall: 20 1/2" x 32 1/2" Core: 19 3/8" x 24 3/8" x 2 1/4" 4 Rows, 9 Fins per Inch	AMAR61881	\$ 580.00	
4040	Radiator Overall: 20 3/8" x 32 1/2" Core: 19 1/2" x 25 1/2" x 2 3/8" 4 Rows, 8 Fins per Inch Replaces AR79450	AMRE21894	\$ 750.00	

John Deere®—Tractor

Application	Description	Part Number	Retail Price	Core
4050 ASN 005511, 4055, 4250, 4255, 4450, 4455	Radiator Overall: 22 1/2" x 37 1/4" Core: 21 3/4" x 29 1/8" x 3 1/4" 6 Rows, 8 Fins per Inch Replaces RE21893	AMRE38664	\$ 860.00	
4230 w/ A/C	Radiator Overall: 20 1/2" x 32 3/4" Core: 19 1/4" x 25 1/2" x 3 3/4" 5 Rows, 10 Fins per Inch Replaces AR63663	AMAR61883	\$ 575.00	
4230 w/o A/C; Stationary Engines w/ John Deere® Engine Models: 4276, 4276D Turbo, 6114D, 6114T w/ Code 2701 Radiator	Radiator	AMAR61880	\$ 485.00	
4240	Radiator Overall: 22 1/2" x 34 3/4" Core: 21 3/4" x 27 1/4" x 2 3/4" 5 Rows, 8 Fins per Inch	AMRE21898	\$ 685.00	
4320	Radiator Overall: 22 1/2" x 32 1/4" Core: 22 1/2" x 25" x 2 7/8" 4 Rows, 9 Fins per Inch	AMAR48735	\$ 520.00	
4430	Radiator Overall: 23" x 34 3/4" Core: 21 3/4" x 27" x 3 3/8" 5 Rows, 9 Fins per Inch	AMAR61879	\$ 595.00	
4440	Radiator Overall: 22 1/2" x 37" Core: 21 3/4" x 29" x 2 3/4" 4 Rows, 8 Fins per Inch	AMRE21897	\$ 540.00	
4520, 4620 - w/ 6-466A, 6-466D and 6-466T PowerTech™ Stationary Engines	Radiator Replaces AR43945, AR43190, AR43947	AMAR43945	\$ 995.00	
(4555, 4755, 4955 BSN 010000), 4650*, 4850* *Requires RE24897 10 PSI Cap and eliminates AR85932 Valve	Radiator Overall: 27" x 37 3/4" Core: 26 1/8" x 29" x 3 1/2" 6 Rows, 8 Fins per Inch	AMRE38666	\$ 875.00	
4560, (4755, 4955 ASN 010001), 4760, 4960	Radiator Core: 25 1/2" x 28 5/8" 5 Rows, 8 Fins per Inch	AMRE46314	\$ 925.00	
4630 BSN 10647 w/ A/C	Radiator Overall: 22 1/2" x 37" Core: 21 5/8" x 29 1/8" x 3 5/8" 6 Rows, 11 Fins per Inch	AMAR61884	\$ 1045.00	
4630 ASN 10647 w/ A/C	Radiator Overall: 22 1/2" x 37" Core: 22" x 29" x 3 3/4" 6 Rows, 10 Fins per Inch	AMAR68872	\$ 780.00	
4640	Radiator Overall: 27" x 38" Core: 26 1/4" x 30" x 3 1/2" 6 Rows, 8 Fins per Inch Replaces AR79456, AR90741	AMRE21896	\$ 795.00	
4840	Radiator Core: 26 1/4" x 30" x 3" 5 Rows, 8 Fins per Inch Replaces AR79458, AR90472	AMRE21895	\$ 925.00	
5039D, 5045D, 5045E, 5055D, 5055E, 5065E, 5075E, (5103, 5203 ASN 003224), 5303 ASN 003304, 5403	Radiator	AMRE212667	\$ 335.00	
5083E, 5093E, 5093EN, 5101E, 5101EN, 5415, 5425, 5425N, 5525, 5525N, 5603, 5615, 5625, 5715, 5725, 5725N	Radiator	AMRE212289	\$ 645.00	

John Deere®—Tractor

Application	Description	Part Number	Retail Price	Core
5085E, 5085M, 5100E, 5100M, 5100MH, 5100ML, 5115M, 5115ML	Radiator Overall: 29" x 23 1/4" x 4"	AMSJ11171	\$ 769.00	
5103 BSN 006839, 5203 BSN 003223, 5210, 5220, 5303 BSN 003303, 5310, 5310N, 5320, 5320N - w/o Cab	Radiator Core: 19" x 15 3/4" 3 Rows of Tubes	AMRE70733	\$ 365.00	
5105, 5205	Radiator Core: 19.29" x 14.57" Replaces RE73306	AMRE71796	\$ 342.00	
5200, 5300, 5300N, 5400, 5400N	Radiator Brass / Copper Construction, Replaces JD Plastic and Aluminum Radiator Overall: 20 9/16" x 20 3/4"* Core: 19 3/4" x 15 13/16" 4 Rows, 8 Fins per Inch *Height Measurement Does Not Include Filler Neck	AMRE66029	\$ 350.00	
5210, 5220, 5310, 5310N, 5320 - w/ Cab	Radiator	AMRE70673	\$ 320.00	
5410, 5420, 5420N, 5510, 5510N, 5520, 5520N	Radiator Core: 20 7/8" x 17" 4 Rows, 8 Fins per Inch	AMRE70236	\$ 390.00	
5500, 5500N	Radiator Brass / Copper Construction, Replaces JD Plastic and Aluminum Radiator Core: 19 9/16" x 17 7/16" 4 Rows, 8 Fins per Inch	AMRE62841	\$ 480.00	
6010, 6100, 6110, 6110L, 6200, 6200L, 6210, 6210L, 6300, 6300L, 6310, 6310L, 6400, 6400L, 6410, 6410L, 6410S, 6500, 6500L, 6510, 6510L, 6510S, SE6010, SE6110, SE6210, SE6310, SE6410	Radiator Overall: 20 3/4" x 23 7/8" x 2 1/2"	AMAL110865	\$ 460.00	
6110, 6110L, 6200 ASN 192066, 6210, 6210L, (6300, 6300L, 6400, 6400L, 6500, 6500L ASN 192066), 6310, 6310L, 6310S, 6405, 6410, 6410L, 6410S, 6510S	Radiator Overall: 20 3/4" x 23 3/4" Core: 20 1/4" x 20" 4 Rows of Tubes 8 Fins per Inch Replaces AL115732	AMAL116668	\$ 415.00	
(6120, 6120L, 6215, 6220, 6220L, 6320, 6320L, 6415, 6420, 6420L, 6520L ASN 425337), 6140J, 6155J	Radiator w/ Reservoir Overall: 22 1/2" x 24 1/8" x 5 1/4" Replaces AL164554, AL168726, AL176361	AMAL169733	\$ 1315.00	
6020, 6120, 6120L, 6215, 6220, 6220L, 6320, 6320L, 6415, 6420, 6420L, 6425	Radiator Core: 21 3/8" x 22 1/2" x 5 1/4" 13 Fins per Inch Replaces AL164554, AL169733, AL176361	AMAL171542	\$ 1440.00	
7200, 7210, 7400 - w/o Cab	Radiator Overall: 20 13/16" x 30 1/4" Core: 20 1/2" x 22 3/4" x 2 3/16" 4 Rows, 10 Fins per Inch	AMRE67333	\$ 687.76	
7200, 7210, 7400, 7410, 7510	Radiator Overall: 20 7/8" x 30 3/8" Core: 20 1/16" x 22 11/16" x 3" 4 Rows, 8 Fins per Inch Brass / Copper Construction Replaces JD Plastic and Aluminum Radiator Replaces RE49167	AMRE165030	\$ 485.00	
7200R, 7215R, 7230R, 7260R, 7280R - w/ Tier II or I-Tier IV Engine	Radiator	AMRE287861	\$ 1350.00	
(7210R, 7270R, 7290R, 7310R - w/o Baffle), (7230R ASN 080000 w/o Baffle or ASN 094099 w/ Baffle w/ FT4 Engine), (7250R w/o Baffle or ASN 094099 w/ Baffle w/ FT4 Engine)	Radiator	AMRE560281	\$ 1535.00	

John Deere®—Tractor

Application	Description	Part Number	Retail Price	Core
7600, 7610, 7700, 7710 BSN 089999, 7800, 7810 BSN 089999	Radiator Overall: 22 1/4" x 33 7/8" Core: 22" x 28 1/8" x 3 1/2" 5 Rows, 8 Fins per Inch	AMRE63188	\$ 750.00	
7630, 7730, 7830, 7930	Radiator Overall: 26" x 33" Core: 26" x 25 3/8" x 3 1/4" 4 Rows, 10 Fins per Inch	AMRE226366	\$ 980.00	
7720, 7820, 7920, Sprayer: 4720	Radiator Core: 16" x 25.50" x 3.30" Replaces RE181893	AMRE245236	\$ 1112.00	
8100, 8100T, 8110T, 8200, 8200T, 8210, 8210T, 8300 BSN 025859, 8300T, 8310, 8310T, 8400, 8410, 8410T	Radiator Core: 15 3/4" x 30 1/8" 5 Rows Replaces RE159541, RE61305, RE69136	AMRE69135	\$ 795.00	
8130, 8225R, 8230, 8230T, 8245R, 8270R, 8295R, 8295RT, 8320R, 8330, 8330T, 8345R, 8345RT, 8430, 8430T, 8530	Radiator Core: 27 7/8" x 35.00" x 4 1/8" 5 Rows, 10 Fins per Inch Replaces RE242251	AMRE242256	\$ 1630.00	
(8235R, 8285R, 8310R, 8335R, 8360R SN 016001- 090000), (8310RT, 8335RT, 8360RT SN 902501-912000) - All w/ Tier 2 Engine	Radiator Overall: 21 1/2" x 46 3/8" Core: 21 1/4" x 38" x 5 1/4" 4 Rows, 10 Fins per Inch	AMRE297780	\$ 1200.00	
(8235R, 8285R, 8310R, 8335R, 8360R SN 016001- 090000), (8310RT, 8335RT, 8360RT SN 902501-912000) - All w/ Tier 4 Engine	Radiator Overall: 21 5/8" x 46 1/2" Core: 21 1/2" x 38" x 5 3/16" 5 Rows, 10 Fins per Inch	AMRE330645	\$ 1545.00	
8420, 8420T, 8520, 8520T	Radiator Core: 16" x 32 1/8" x 3.30"	AMRE245227	\$ 1140.00	
8430, 8440, 8630	Radiator Replaces RE21561	AMAR76838	\$ 1480.00	
8450	Radiator Core: 26 7/8" x 34 1/2" Replaces AR93889	AMRE21557	\$ 1400.00	
8450, 8650	Radiator 28 3/4" x 49 1/8" x 3 7/8" 7 Rows, 6 Fins per Inch Replaces AR93356, RE21559	AMRE24732	\$ 2560.00	
8560 ASN 003101, 8570, 8760 ASN 005101, 8770, 8870	Radiator Replaces RE50741	AMRE47602	\$ 2010.00	
8640	Radiator Bolt-Together Overall: 28 1/4" x 49 3/8" Core: 27 1/8" x 41 3/16" x 4" 7 Rows, 9 Fins per Inch	AMRE21560	\$ 2610.00	
8850	Radiator Bolt-Together Core: 33 1/8" x 49 3/4" x 4" 7 Rows, 8 Fins per Inch	AMRE21558	\$ 3275.00	
(9100, 9200 ASN 020920), 9120, 9220	Radiator Replaces RE159210	AMRE169280	\$ 2390.00	
9230, 9330, 9430, 9430T, 9530, 9530T, 9630, 9630T	Radiator Overall: 40 1/2" x 56 1/2" Core: 40 1/2" x 45" x 3 1/4" 2 Rows, 7 Fins per Inch, Non-Louvered	AMRE231507	\$ 3932.00	

John Deere®—Tractor

Application	Description	Part Number	Retail Price	Core
(9300, 9400 BSN 020890)	Radiator Overall: 37 3/8" x 47 3/8" x 3 1/2" 5 Rows, 10 Fins per Inch Includes (4) Brackets and (4) Bolts Mounts onto the Top Tank, Must Use Original Steel Side Channels For use w/ 4-Bracket Version Only Replaces RE61794, RE592732	AMRE152483	\$ 2500.00	
(9300, 9400 ASN 020892), 9320, 9320T, 9420, 9420T, 9520, 9520T, 9620, 9620T	Radiator Overall: 46" x 36 3/8" x 4 1/4" Replaces RE159211	AMRE169273	\$ 2600.00	
Ind: 500C, 510	Radiator Core: 18 7/8" x 22 7/16" x 2 5/8"	AMAT58449	\$ 688.47	
Utility: 790, 2305, 2320, 3005	Radiator Aluminum Core: 16.25" x 17.75" 4 Rows Replaces AM881422	AMLVA802036	\$ 525.00	
Utility: 3120, 3203, 3320, 3520, 3720, 4105	Radiator Core: 18.50" x 16.73" x 3.11"	AMLVA12636	\$ 225.00	
Utility: 4010, 4110, 4115	Radiator Aluminum Core: 15.25" x 11.81" 2 Rows	AMLVA800889	\$ 675.00	
Utility: 4200, 4210, 4300, 4310, 4400	Radiator Overall: 18.27" x 23.35" x 2.40" 4 Rows	AMLVA12158	\$ 294.00	
Utility: 4400, 4410, 4500, 4510	Radiator	AMAM122480	\$ 295.00	
Utility: 4510, 4600, 4610, 4700, 4710	Radiator Overall: 18.15" x 25.20" x 2.40" 4 Rows Replaces LVA12320	AMAM125285	\$ 294.00	
7210R, 7230R, 7250R, 7270R, 7290R, 7310R	Radiator Support, Lower	AMRE560273	\$ 460.00	
	Radiator Mount Bracket, Lower	AMRE560278	\$ 365.00	
	Radiator Mount Bracket, Right Hand	AMRE560275	\$ 367.00	
	Radiator Mount Bracket, Left Hand	AMRE560272	\$ 374.00	



Radiator Hoses and Thermostats

Application	Description	Part Number	Retail Price	Core
840, 940, 1040, 1140, 1350, (1550, 1750, 1850 BSN 621999), 1640, 2040, 2150, 2255, Utility: 2155, 2240 ASN 350000	Radiator Hose, Upper 1.50" ID	AML34920	\$ 9.00	
1020 Gas	Radiator Hose, Upper 1.50" ID	AMT22501	\$ 21.01	
(1520, 2020, 2030 - Diesel), 1830, 2120, 2130 BSN 131024, 2440 BSN 305414, Ind: (300B, 301A, 302, 302A BSN 345266 w/ Diesel Engine), (400, 401 - Diesel), (401B, 401C BSN 305414 w/ Diesel Engine)	Radiator Hose, Upper 1.50" ID	AMT23533	\$ 13.17	
1520, 2020, 2030, Ind: 300B, 301A, 302, 302A, 400, 401, 401B, 401C - All w/ Gas	Radiator Hose, Upper 1.50" ID	AMT22496	\$ 12.00	
1640, 1840 BSN 429999, 2040 European ASN 430000, 2040S, 2140, 2350, 2550, 2750	Radiator Hose, Upper 1.50" ID	AML34898	\$ 11.00	
Utility: 2155 SN 622000-719999	Radiator Hose, Upper 1.50" & 2" ID	AML58814	\$ 17.85	
2355 ASN 621999, Utility: 2155 ASN 719999	Radiator Hose, Upper 1.50" & 2" ID	AML58801	\$ 16.57	
2240 BSN 350000, Utility: 2040 BSN 350000	Radiator Hose, Upper 1.50" ID	AMT23534	\$ 9.48	

John Deere®—Tractor

Application	Description	Part Number	Retail Price	Core
(2355, 2555, 2755, 2855N BSN 669789)	Radiator Hose, Upper 1.50" ID	AML56296	\$ 14.02	
(2355, 2555, 2755, 2855N ASN 669789)	Radiator Hose, Upper 1.50" & 2" ID	AML61990	\$ 10.12	
	Radiator Hose, Upper 1.50" ID	AML61991	\$ 12.56	
2440 ASN 305415, 2510, 2520	Radiator Hose, Upper 1.50" ID	AMTY22409	\$ 8.94	
2510, 2520 Diesel	Radiator Hose, Upper 1.50" ID	AMR38312	\$ 11.28	
2630 Early	Radiator Hose, Upper 2" ID For use w/ Thermostat Housing marked R54808	AMR55262	\$ 22.81	
2630* Late, 2640 *For use w/ Thermostat Housing marked R59051	Radiator Hose, Upper 1.56" ID	AMR59053	\$ 17.92	
2840, (3030, 3130 ASN 189677)	Radiator Hose, Upper 2" & 2.125" ID	AML31795	\$ 20.70	
2940, 2950, 3040, 3140, 3150, 3640, 4040, 4040S	Radiator Hose, Upper 2" & 2.125" ID	AML32456	\$ 22.00	
2955, 3055, 3155 ASN 664559, 3255	Radiator Hose, Upper 2" ID	AML62211	\$ 15.08	
	Radiator Hose, Upper 2" & 2.20" ID	AML62214	\$ 17.39	
2955 BSN 664559 w/ Cab and BSN 660812 w/o Cab, 3155 BSN 664559 w/ Cab	Radiator Hose, Upper 2" & 2.125" ID	AML56304	\$ 16.41	
3010, 3020, 4000, 4010, 4020 w/o A/C, 4020 ASN 20100 w/ A/C, Ind: 500, 510, 600	Radiator Hose, Upper 2" ID	AMR26475	\$ 13.19	
4030	Radiator Hose, Upper 2.12" ID Replaces R53549, R53551	AMTY22430	\$ 8.95	
4040 w/ or w/o A/C, 4230 Diesel w/ or w/o A/C, 4230 Gas, 5020, 6030, Ind: 700A	Radiator Hose, Upper 2" ID	AMR53231	\$ 17.00	
4050 w/ 6359TR Engine ASN 006509	Radiator Hose, Upper 2.062" & 2.125" ID	AMR82973	\$ 24.25	
4050, 4055, 4250, 4255, 4450, 4455	Radiator Hose, Upper 2" & 2.50" ID	AMR88354	\$ 12.00	
4050 BSN 005510, 4240 w/ or w/o A/C, 4240S, 4350	Radiator Hose, Upper 2" & 2.50" ID	AMR61435	\$ 9.00	
4050, 4250, 4440, 4450, 4630	Radiator Hose, Upper 2" & 2.50" ID	AMR53407	\$ 9.37	
4320 w/ or w/o A/C	Radiator Hose, Upper 2" & 2.50" ID	AMT41901	\$ 13.00	
4430	Radiator Hose, Upper 2" & 2.50" ID	AMR52426	\$ 9.90	
4520 BSN 303518 w/o A/C	Radiator Hose, Upper 2" & 2.50" ID	AMR43582	\$ 17.22	
4520 ASN 303518, 4620	Radiator Hose, Upper 2" & 2.25" ID	AMR46521	\$ 16.86	
(4555, 4755, 4955 BSN 010001), 4650 Engine BSN 324216, 4850 Engine BSN 322747	Radiator Hose, Upper	AMR88353	\$ 12.45	
4560, (4755, 4955 ASN 010000), 4760, 4960	Radiator Hose, Upper 2.25" & 2.50" ID	AMR109502	\$ 17.03	
4640, 4650, 4840, 4850, Cotton Pickers: 9940, 9950	Radiator Hose, Upper 2.25" & 2.50" ID	AMR79346	\$ 12.09	

John Deere®—Tractor

Application	Description	Part Number	Retail Price	Core
5103 BSN 006840, 5200 ASN 421066, (5203, 5303 BSN 003304), 5210, 5220, 5310, 5310N, 5320, 5320N	Radiator Hose, Upper	AMR126605	\$ 8.30	
5200 BSN 421066, 5300 BSN 431920, 5400 BSN 441687	Radiator Hose, Upper 1.50" ID	AMR105074	\$ 7.91	
6200, 6200L, 6300, 6300L, 6400, 6400L, 6500, 6500L	Radiator Hose, Upper 2.375" ID	AML100593	\$ 17.00	
7200, 7400	Radiator Hose, Upper 2.375" ID	AMR113176	\$ 24.76	
7210, 7410, 7510	Radiator Hose, Upper 2.375" ID	AMR133844	\$ 25.30	
7600	Radiator Hose, Upper 2" & 2.375" ID	AMR95018	\$ 28.37	
7610	Radiator Hose, Upper 2" & 2.375" ID	AMR130571	\$ 32.15	
8120, 8120T, 8220, 8220T, 8320, 8320T, 8420, 8420T, 8520, 8520T	Radiator Hose, Upper 2.50" ID	AMR164844	\$ 30.55	
8430, 8440, 8450	Radiator Hose, Upper 2.25" ID Replaces R57393	AMR62286	\$ 10.83	
8430 1974-81, 8440, 8450, 8960, 8970	Radiator Hose, Upper 2.25" & 2.50" ID	AMR57388	\$ 10.95	
8640	Radiator Hose, Upper 2.25" ID	AMR61826	\$ 7.68	
8650	Radiator Hose, Upper 2.25" & 2.75" ID	AMR73645	\$ 34.67	
8760 ASN 005100, 8770, 8870	Radiator Hose, Upper 2.375" ID	AMR110670	\$ 62.75	
Utility: 850, 950 BSN 020000, 1050	Radiator Hose, Upper 1.125" ID	AMCH13960	\$ 10.12	
Utility: 950 BSN 10859	Radiator Hose, Upper 1.125" ID	AMCH11789	\$ 9.48	
(1010, 1020, 2020 - Diesel), 1030, 1040, 1120, 1130, 1140, 1350, 1520 Gas or Diesel, 1530, 1550, 1630, 1750, 1830, 1850, Ind: 300B, Ind: 300, 301, 302, 302A, 400, 401, 401B, 401C, 401D	Radiator Hose, Lower 1.875" ID	AMT22500	\$ 9.00	
1020, 2020, 2030, Ind: 300, 300B, 301, 301A, 400, 401 - All w/ Gas	Radiator Hose, Lower 1.875" ID	AMT22497	\$ 16.53	
1640, 1840 BSN 429999, 2040 European ASN 430000, 2040S, 2140, 2350, 2550, 2750	Radiator Hose, Lower 1.875" ID	AML34921	\$ 9.00	
Utility: 2155 SN 622000-719999	Radiator Hose, Lower 1.90" & 2" ID	AML58815	\$ 19.11	
2355N ASN 621999, Utility: 2155 ASN 719999	Radiator Hose, Lower 1.90" & 2" ID	AML58793	\$ 25.11	
(2355, 2555, 2755, 2855N BSN 669789)	Radiator Hose, Lower 1.90" & 2" ID	AML56295	\$ 14.67	
(2355, 2555, 2755, 2855N ASN 669789)	Radiator Hose, Lower 1.90" & 2" ID	AML61988	\$ 21.03	
2510 Gas	Radiator Hose, Lower 1.875" ID	AMR38311	\$ 22.62	
2510 Diesel, 2520	Radiator Hose, Lower 1.875" ID	AMR38313	\$ 17.57	
2840, 3030, 3130, Utility: 3120	Radiator Hose, Lower 2.156" & 2.312" ID	AMT28426	\$ 19.37	
2940, 2950, (3040, 3140 ASN 429999), 3150	Radiator Hose, Lower 1.937" & 2.375" ID Replaces T34922	AML34922	\$ 25.96	

John Deere®—Tractor

Application	Description	Part Number	Retail Price	Core
2955 BSN 765517 w/ Cab & BSN 660812 w/o Cab, 3155 BSN 664560 w/ Cab	Radiator Hose, Lower 2" & 2.312" ID	AML56305	\$ 28.82	
2955, 3055, 3155 ASN 664559, 3255	Radiator Hose, Lower 2" & 2.312" ID	AML61989	\$ 27.97	
3010, 3020, 4000, 4010, 4020 w/o A/C, Ind: 500, 510, 600	Radiator Hose, Lower 1.937" and 2.187" ID	AMR26472	\$ 11.18	
(4000, 4020 ASN 200999 w/ A/C)	Radiator Hose, Lower 2" & 2.125" ID	AMR45982	\$ 27.30	
4030	Radiator Hose, Lower 1.875" & 2.375" ID	AMR53550	\$ 15.36	
4040, 4230 Diesel - w/ A/C	Radiator Hose, Lower 2" & 2.312" ID	AMR53142	\$ 14.00	
4040, 4230 Diesel w/o A/C	Radiator Hose, Lower 1.87" & 2.37" ID	AMR53141	\$ 16.00	
4050, 4055, 4250, 4255, 4450, 4455	Radiator Hose, Lower 2.50" ID	AMR72742	\$ 6.00	
4230 Gas	Radiator Hose, Lower 2" ID	AMR54534	\$ 16.00	
(4240, 4440 - w/ A/C), 4350	Radiator Hose, Lower 2.50" ID	AMR61433	\$ 19.50	
4240, 4440 - w/o A/C	Radiator Hose, Lower 2.375" & 2.437" ID	AMR61434	\$ 18.36	
4320, 4520 ASN 308518 - w/o A/C	Radiator Hose, Lower 2.281" ID	AMR48427	\$ 22.00	
4320, 4520, 4620 - w/ A/C	Radiator Hose, Lower 2.281" ID	AMR46453	\$ 23.00	
4430 w/o A/C	Radiator Hose, Lower 2.312" & 2.437" ID	AMR52429	\$ 13.00	
4430, 4630 - w/ A/C	Radiator Hose, Lower 2.281" & 2.437" ID	AMR58618	\$ 20.37	
4520 Engine BSN 303519 w/o A/C	Radiator Hose, Lower 1.12" & 2.437" ID	AMR43581	\$ 36.48	
4560, 4755, 4760, 4955, 4960	Radiator Hose, Lower 2.50" ID	AMR76371	\$ 8.28	
4640, 4840, Cotton Picker: 9940	Radiator Hose, Lower 2.25" & 2.50" ID	AMR62327	\$ 20.00	
5103 BSN 6840, 5105, 5200, 5203 BSN 3224, 5205, 5210, 5220, 5300, 5303 BSN 3304, 5310, 5310N, 5320, 5320N, 5400, 5400N, 5500, 5500N	Radiator Hose, Lower Replaces R105075, R137780	AMR126013	\$ 8.24	
5403, 5410, 5415N, 5420, 5420N, 5510, 5510N, 5520, 5520N, 5605, 5705	Radiator Hose, Lower 1.75" & 2" ID	AMR135250	\$ 13.30	
6200, 6200L, 6300, 6300L, 6400, 6400L, 6500, 6500L	Radiator Hose, Lower 2.40" ID	AML111275	\$ 32.00	
7210, 7410, 7510	Radiator Hose, Lower 2" & 2.375" ID	AMR128231	\$ 18.23	
7610	Radiator Hose, Lower 2" ID	AMR128002	\$ 20.64	
(7710, 7810 BSN 090000)	Radiator Hose, Lower 2" ID	AMR133960	\$ 27.71	
8110T, 8210T, 8310T, 8410T, 9120, 9220, 9230, 9320, 9320T, 9330, 9420, 9420T, 9430, 9430T, 9520T, 9530, 9530T, 9620, 9620T, 9630, 9630T, (9360R, 9370R - Tier 4), (9410R, 9420RX, 9460R, 9460RT, 9470RX, 9510R, 9510RT, 9520, 9520RX, 9560R, 9560RT - Tier 2), (9420R, 9470R, 9470RT*, 9520RT** - Tier 2 and 3), (9570R, 9570RT, 9570RX - Tier 2 and FT4), 9620RX FT4 *All Tier 2 or ASN 920000 Tier 3 **All Tier 2 or ASN 905999 Tier 3	Radiator Hose, Upper Replaces R122290, R154242	AMR545233	\$ 13.25	

John Deere®—Tractor

Application	Description	Part Number	Retail Price	Core
8430, 8440, 8450, 8560 BSN 003101, 8960, 8970	Radiator Hose, Lower 2.50" & 2.75" ID Replaces R57628	AMR63696	\$ 10.36	
8630 ASN 003224, 8640, 8650	Radiator Hose, Lower 2.75" ID Replaces R63322	AMR63697	\$ 21.76	
8630, 8640, 8760 BSN 005101	Radiator Hose, Lower 2.75" & 3.032" ID Replaces R57630	AMR62892	\$ 12.26	
8650	Radiator Hose, Lower 2.75" & 2.875" ID	AMR85365	\$ 13.85	
8850	Radiator Hose, Lower 3" & 3.50" ID Replaces RE12492	AMRE14364	\$ 18.42	
	Radiator Hose, Lower 3" ID	AMR68934	\$ 14.77	
Utility: 850	Radiator Hose, Lower 1.125" ID	AMCH11774	\$ 9.92	
Utility: 950 BSN 10859	Radiator Hose, Lower 1.125" ID	AMCH10310	\$ 11.69	
Utility: 1050	Radiator Hose, Lower 1.125" ID	AMCH13961	\$ 12.50	
2150, 2255, 2350, 2355, 2550, 2555, 2650, 2650N, 2750, 2755, 2850, 2855, Utility: 2040 ASN 350000, 2155, 2240 ASN 350000	Bypass Hose	AMR70737	\$ 11.09	
8430 1974-81, 8440	Bypass Hose 2.375" ID, 5.562" Long Replaces R62891	AMTY22437	\$ 4.92	
2520, 6110, 6210, 6230, 6310, 6320, 6330, 6405 BSN 580410, 6410, 6420, 6430, 6605 BSN 578920, 7130, 7200, 7210, 7220, 7230, 7320, 7330, 7400, 7410, 7420, 7430, 7505, 7510, 7520, 7530, 7600, 7630, (7710, 7810 Engine BSN 145553), 7730, 7830, 7930, 9120, 9200, 9220, 9300, 9300T, 9320, 9320T, 9400, 9400T, 9420, 9420T, 9520, 9520T, 9620, 9620T	Thermostat, 180° Replaces AT22961	AMRE33705	\$ 5.96	
2630, 2640, 2840, 2940, 2950, (3030, 3130 ASN 235169), 3040, 3140, 3150, 4050, 4055, 4240, 4250, 4255, 4320, 4430, 4440, 4450, 4520 ASN 303518, 4555 BSN 165527, 4560, 4620, 4630, 4640, 4650, 4755, 4760, 4840, 4850, 4955, 4960, 6030, 6110, 6210, 6310, 6405, 6410, 6605, 7020, 7210, 7220, 7320, 7410, 7420, 7505, 7510, 7520 w/ MFWD, 7600, 7610, 7700, 7710, 7720, 7800, 7810, 7820, 7920, 8100T, 8110, 8110T, 8120, 8120T, 8200T, 8210, 8210T, 8220, 8220T, 8300T, 8310, 8310T, 8320, 8320T, 8400T, 8410, 8410T, 8420, 8420T, 8430, 8440, 8450, 8520, 8520T, 8560, 8570, 8630, 8640, 8650, 8760, 8770, 8850, 8970, 9100, 4WD: 7520	Thermostat, 180° Replaces RE524562	AMAR48675	\$ 4.61	
4030	Thermostat, 195° Replaces AR70601	AMAR77411	\$ 72.32	
5075M, 5083E, 5083E Limited, 5083EN w/ 4045TLV53 Engine, 5093E, 5093E Limited, 5093EN, (5101E, 5101EN, 5101E Limited - w/ 4045TLV56 Engine), 5103, 5105, 5203, 5205, 5210, 5220, 5303, 5310, 5310N, 5320, 5320N, 5403, 5410, 5420, 5420N, 5425, 5425N, 5510, 5510N, 5520, 5520N, 5525, 5525N	Thermostat, 182°F / 83°C	AMRE501052	\$ 3.91	
5085E, 5085M, 5090M, 5090R, 5100E, 5100M, 5100MH, 5100ML, 5100R, 5115M, 5115ML, 5115R, 5125R, 6105D, 6105E, 6115D, 6120E, 6130D, 6135E, 6140D, 7195J, 7210J, 7225J, 7630, 7730, 7830, 7930, Premium Models: 6230, 6330, 6430, 6530, 6534, 6630, 6830, 6930, 7130, 7230, 7330, 7430, 7430E, 7530, 7530E, Ind: 210K, 210L	Thermostat Replaces RE538806	AMRE538289	\$ 15.50	

John Deere®—Tractor

Application	Description	Part Number	Retail Price	Core
6090MC, 6100MC, 6100RC, 6105M, 6105R, 6110M, 6110MC, 6110R, 6110RC, 6115M, 6115R, 6120R, 6125M, 6125R, 6130M, 6130R, 6135M, 6140M, 6140R, 6145R, 6150M, 6150R, 6150RH, 6155M, 6155R, 6155RH, 6170M, 6170R, 6175M, 6175R, 6190R, 6195M, 6195R, 6210R, 6215R, 6250R, 7210R, 7230R, 7250R, 7270R, 7290R, 7310R, 8120, 8220, 8235R, 8245R, 8260R, 8270R, 8285R, 8295R, 8310R, 8320, 8320R, 8320RT, 8335R, 8345R, 8345RT, 8370R, 8370RT, 8400R, 8420, 8520, 9370R, 9410R, 9420R, 9420RX, 9460R, 9470R, 9470RT, 9470RX, 9520R, 9520RT, 9520RX, 9570R, 9570RT, 9570RX	Thermostat Replaces RE540379	AMRE554015	\$ 19.62	
8130, 8225R, 8230, 8230T, 8245R, 8270R, 8295R, 8295RT, 8320R, 8320RT, 8330, 8330T, 8345R, 8345RT, 8430 2006-09, 8430T, 8530, 9230, 9370R, Ind: 210K, 210L	Thermostat, 180° 2.125" OD Replaces RE540550	AMDZ100553	\$ 16.56	
(3010, 3020 Engine ASN 066499), 4000, 4010, 4020, 4040, 4230, 5010, (5020, 6030 - w/ 531D Engine)	Thermostat Housing Marked R39690, R41853 or R42644 Replaces R26470, R36814, AR39598	AMAR44840	\$ 76.40	
1020, 1030, 1120, 1130, 1520, 1530, 2020, 2030, 2040 BSN 349999, 2120, 2355N, 2510 Gas, Ind: (300, 301, 400, 401, 401B BSN 468294 - Diesel), 301A w/ Gas Engine BSN 345267, (302, 302A - w/ Diesel Engine BSN 345266), (401C BSN 305414, 401D - Gas), Utility: 2155, 2240 BSN 349999	Thermostat Housing Hose 0.50" ID	AMT20277	\$ 9.68	
(4050, 4250 BSN 001014), 4450 BSN 001027, 4650 BSN 324214, 4850 BSN 322745, 8450 ASN 001620, 8650, 8850	Coolant Temperature Sensor Replaces RE12184, RE37086	AMRE47793	\$ 60.91	
4055, 4255, 4455, 4560 BSN 003112, 4755 BSN 010703, 4760 BSN 002754, 4955 BSN 010297, 4960 BSN 004261, 8560 BSN 002330, 8760 BSN 004321, 8960 BSN 004100	Coolant Temperature Sensor Replaces RE33699	AMRE47785	\$ 56.18	
7720, 7820, 7920, Sprayer: 4720	Rubber Coupling, Upper Radiator Hose 2" & 2.50" ID Replaces R188811	AMR189038	\$ 9.75	
5075M Excluding iT4 Model, (5085E, 5085M, 5100E, 5100ML, 5115M, 5115ML, 6115D, 6130D, 6140D - iT4), 5100M, 6105D, 6105E, 6120E, 6135E, 8120, 8120T, 8220, 8220T, 8320, 8320T, 8420, 8420T, 8520, 8520T, Sprayer: 4920	Rubber Coupling, Lower or Right Hand Radiator Hose 2" & 2.50" ID Replaces R188811	AMR189038	\$ 9.75	



Flywheels and Components

Application	Description	Part Number	Retail Price	Core
2155, 2355, 2555, 2755, 2840, 2855, 2940, 2955	Flywheel, 13"	AMRE18678	\$ 595.93	
3010, 3020, 4000, 4010, 4020 Diesel	Flywheel For units w/ syncro transmissions and square pin hole style flywheels Replaces Cast # - R40727	AMAR40565	\$ 350.00	
4320	Flywheel Replaces Cast # - R46045	AMAR48294	\$ 540.00	
920, 930, 1030, 1130, 1630, 2040 ASN 349999, (2150, 2255 - w/ Dual Stage Clutch), Utility: 820, 830, 2155 w/ Continuous PTO, 2240 ASN 349999	Flywheel w/ Ring Gear 142 Tooth Marked R70488, R80867 or T24126 Replaces, AT21382	AMAR92506	\$ 780.57	
(2030 ASN 187301, 2630 - w/ Independent PTO w/o Reverser), (2440, 2640 - w/ Independent PTO w/o Reverser or w/ Hi/Lo)	Flywheel w/ Ring Gear 142 Tooth Marked R56355	AMAR66781	\$ 927.59	
2350 ASN 463068, 2355 w/ 4239DL007 Engine and Collar Shift Transmission, 2555 w/ 4239DL008 or 010 Engine and Syncro Transmission, 2940 Engine ASN 415943	Flywheel w/ Ring Gear Marked R76352 or R80986 Replaces 1409-5001	AMAR103749	\$ 477.00	

John Deere®—Tractor

Application	Description	Part Number	Retail Price	Core
3055, 3155, 3255	Flywheel w/ Ring Gear 142 Tooth, 1.10" Flywheel Step	AMRE31572	\$ 672.01	
4520, 4620, 7020	Flywheel w/ Ring Gear 129 Tooth Replaces AR43013	AMAR56075	\$ 989.36	
4555, 4560, 4640 Engine ASN 179344, 4650, 4755, 4760, 4955	Flywheel w/ Ring Gear 129 Tooth Marked R61380 Replaces AR74523	AMAR97317	\$ 1396.64	
5076E, 5076EF, 5076EL, 5082E, 5090E, 5090EH, 5090EL, 5310, 5310N, 5320N, 5415, 5415N, 5415H, 5420, 5420N, 5425N, 5510, 5510N, 5520, 5520N, 5615, 5715, 5715HC, 5725N	Flywheel w/ Ring Gear 142 Tooth Replaces DZ112913, R501536	AMRE502964	\$ 739.46	
(1020, 1030 - w/ 3152 Engine), 2355, 2555, 2755, 2840, 2855N, 2940, 2955, Utility: (820, 830 - w/ 3152 Engine)	Flywheel Ring Gear 142 Tooth, 14.33" OD, 13.37" ID Used on RE18678 Flywheels	AMR114282	\$ 25.00	
3010, 3020, 4000, 4010 Syncro, 4020, 4030, 4040, 4050, 4055, 4230, 4240, 4250, 4255, 4320, 4350, 4430, 4440, 4450, 4455, 4520, 4555, 4560, 4620, 4630, 4640, 4650, 4755, 4760, 4840, 4850, 4955, 4960, 6403, 6603, 6605, 6615, 6715, 7020, 7200, 7210, 7220, 7320, 7400, 7405, 7410, 7420, 7505, 7510, 7515, 7520, 7600, 7610, 7700, 7710, 7720, 7800, 7810, 7815, 7820, 7920, 8100, 8100T, 8110, 8110T, 8120, 8120T, 8200, 8200T, 8210, 8210T, 8220, 8220T, 8300, 8300T, 8310, 8310T, 8320, 8320T, 8400, 8400T, 8410, 8410T, 8420, 8420T, 8430, 8440, 8450, 8520, 8520T, 8560, 8570, 9100, 9120	Flywheel Ring Gear Diesel Engines 129 Tooth, 16.35" OD, 15.17" ID, Used on AR40565 and AR48294 Flywheels	AMR28811	\$ 33.00	
3010, 3020, 4000, 4010, 4020, 4030, 4230, Ind: 500, 510, 600 - All w/ Gas Engine	Flywheel Ring Gear 165 Tooth, 15.54" ID, 16.678" OD	AMR26054	\$ 124.79	
5020, 6030, 7520, 8630, 8640, 8650, 8760, 8770, 8870, 9200, 9220, 9300, 9320, 9320T, 9400, 9420, 9420T, 9520, 9520T, 9620, 9620T, Forage Harvesters: 5200, 5400, 5460, 5820, 5830, 6750, 6850, 7400, 7500	Flywheel Ring Gear Marked R76000	AMAR103044	\$ 215.56	
4010, 4020	Throw-Out Bearing Tube	AMR27303	\$ 132.00	

Water Pumps and Components

The remanufactured water pumps we supply have an extra step added to the remanufacturing process to ensure quality. Since the bearing and seal assembly are critical in performance, we ensure air-tight seals by vacuum testing our water pumps prior to packaging. This guarantees no leakage will occur after your water pump has been installed.



Application	Description	Part Number	Retail Price	Core
8130, 8225R, 8230, 8230T, 8235R, 8245R, 8260R, 8270R, 8285R, 8295R, 8295RT, 8310R, 8310RT, 8320R, 8320RT, 8330, 8330T, 8335R, 8335RT, 8345R, 8345RT, 8360R, 8360RT, 8370R, 8370RT, 8430 (2006-09), 8430T, 8530, 9230, 9370R, Combines: 9660STS, 9670STS, 9770STS, 9780CTS, C670, S650, S660, S670, T560, T660, T670, W650, W660, Cotton Picker: 7660, Forage Harvesters: 7180, 7250, Sprayers: 4930, 4940, R4038 - All w/ PowerTech™ 6090 9.0L Tier 2 or 3 Engine	Water Pump Kit 14 Tooth Gear Replaces RE523828, SE51228	AMRE530194	\$ 160.00	
60, 620, 630, A, AO, AR - w/ By-Pass Cooling System	Water Pump Cast # - R5318R	AMAA6327R	\$ 128.50	
70	Reman Water Pump	AMR1052	\$ 90.00	\$ 20.00
720, 730 - w/ By-Pass Cooling System	Water Pump	AMAF2368R	\$ 128.50	
920, 930, 1020, 1030, 1120, 1130, 1520, 1530, 1630, 1830, 2020, 2030, 2040, 2120, 2130, 2440, 5200, 5300, 5400, Ind: 300, 300B, 301, 301A, 302, 302A, 400, 401, Utility: 820, 830, 2155, 2240 - All w/ 300 Series Diesel Engine	Reman Water Pump Cast # - R51039 Replaces RE19949	AMR51039	\$ 120.00	\$ 30.00

John Deere®—Tractor

Application	Description	Part Number	Retail Price	Core
820, 830, 920, 930, 1020, 1120, 2020, 2120, 2240 BSN 349999 - Diesel	Reman Water Pump Cast # - R48997, T28992	AMR48997	\$ 165.00	\$ 30.00
940, 2040	Reman Water Pump Cast # - R70434	AMR70434-R	\$ 140.00	\$ 50.00
1140, 1640, 1840, 2040, 2040S, 2140, 2150, 2255, 2350, 2355, 2550, 2555, 2750, 2755, 2855, 2855N, 5500, 5500N, Utility: 2155, 2240 - All w/o A/C	Water Pump Cast # - R70437	AMRE546935	\$ 191.00	
1520, 2020, 2030, 2040, 2440, Utility: 2320, 2240, Sprayer: 6000 Hi Cycle	Water Pump Cast # - R55758	AMRE19944	\$ 126.00	
1630, 2030	Reman Water Pump Cast # - R73604	AMR73604	\$ 145.00	\$ 50.00
	Water Pump	AMAR97708	\$ 151.50	
2010	Reman Water Pump	AMT12712T	\$ 120.00	\$ 30.00
2030, 2510 Gas or Diesel, 2520 Diesel, 2630, Ind: 401B	Reman Water Pump Cast # - T29521	AMT29521	\$ 132.00	\$ 50.00
2030, 2520 - Diesel	Reman Water Pump Cast # - R54805	AMR54805-R	\$ 125.00	\$ 50.00
2040 Diesel w/ Oil Cooler, 2150, 2240 Diesel, 2255, 2350, 2550, 2750 Diesel	Reman Water Pump w/o Pulley Cast # - R70437	AMR70437	\$ 165.00	\$ 25.00
2150	Reman Water Pump Cast # - R78286	AMR78286	\$ 180.00	\$ 30.00
2940, 2950, 3040, 3140	Water Pump w/ Pulley	AMAR92641	\$ 295.00	
2355, Utility: 955	Water Pump	AMAM880905	\$ 111.88	
2510 Gas	Reman Water Pump Cast # - R23629	AMR23629	\$ 130.00	\$ 50.00
2510 Diesel	Reman Water Pump Cast # - R29520	AMR29520-R	\$ 180.00	\$ 50.00
	Reman Water Pump Cast # - T23630	AMT23630T	\$ 165.00	\$ 50.00
2630	Reman Water Pump Cast # - R55164	AMR55164	\$ 120.00	\$ 30.00
2640 Diesel	Reman Water Pump Cast # - R59049	AMR59049	\$ 120.00	\$ 30.00
2955 w/o Viscous Drive, 3055, 3155, 3255, 3650	Water Pump Cast # - R70612 Replaces AR92641, AR92642, R90738	AMRE31600	\$ 255.00	
2955, 3155, 4050	Reman Water Pump Cast # - R90783	AMR90783	\$ 280.00	\$ 50.00
3010, 3020, 4000, 4010, 4020 Diesel	Water Pump	AMAR45332	\$ 119.00	
3010, 3020, 4010, 4020, 4230 Gas	Water Pump Requires AMR52833 Spacer on Stamped Steel Pulleys Replaces R44116, R44119, SE500920	AMAR45330	\$ 95.00	
3020, 4010, 4020	Reman Water Pump w/ Hub Includes Backplate Gasket and Mounting Gasket Backplate Not Included	AMR34977	\$ 115.00	\$ 40.00
3010, 3020, 4010, 4020, 4230 Gas	Spacer Use w/ Stamped Steel Pulleys	AMR52833	\$ 12.86	
4010, 4020 Gas	Reman Water Pump Cast # - R34976	AMR34976	\$ 95.00	\$ 75.00
4030 Gas or Diesel	Reman Water Pump Cast # - R52009	AMR52009	\$ 200.00	\$ 50.00
4040, 4230	Water Pump Replaces Cast # - R51683	AMAR98549	\$ 145.00	

John Deere®—Tractor

Application	Description	Part Number	Retail Price	Core
4045, 4890, 4895, 4990, 4995, 5403, 5410, 5420, 5420N, 5510, 5520, 5520N, 5425, 5525, 5605, 5.8 PowerTech™, 6700, 7455, 7460, Gen Sets: 6068	Water Pump Standard Flow	AMRE505981	\$ 80.00	
4050	Reman Water Pump Cast # - R78287	AMR78287-R	\$ 320.00	\$ 50.00
4050, 4055, 4250, 4255, 4450, 4455, 4555, 4560, 4650, 4755, 4760, 4850, 4955, 4960, 8450, Combines: 9500, 9600, Cotton Pickers: 9950, 9960 - All w/ 6076 BSN 499999, 6466D, AASN 67685 and T Engines Code HH0003	Water Pump Cast # - R83561 Replaces AR93517, RE23291, RE43131, SE500912	AMRE55985	\$ 195.00	
4240, 4440, 4455 Mexico, 4640*, 4840*, 8430, 8440, Cotton Picker: 9940, Forage Harvesters: 5720, 5730 *Requires 6-Bolt Hub	Water Pump w/ 4-Bolt Hub Cast # - R58713, R61439	AMRE20022	\$ 202.00	
4320, 4520, 4620	Reman Water Pump Cast # - R46561	AMR46561	\$ 145.00	\$ 50.00
4420, 6600, Utility: 4400 - All w/ Diesel	Reman Water Pump Cast # - R62902	AMR62902-R	\$ 120.00	\$ 50.00
4430, 4630, 7020 ASN 335846, Forage Harvesters: 5200, 5440	Water Pump	AMRE20023	\$ 150.00	
4520	Reman Water Pump Cast # - R43114	AMR43114	\$ 130.00	\$ 50.00
5010, 5020, 6030	Reman Water Pump Cast # - R36812	AMR36812	\$ 130.00	\$ 50.00
(5065M, 5075M - w/ 5030HLV11 Tier 3 Engine), 5225, 5325, 5325N	Water Pump Replaces RE507604	AMRE545573	\$ 170.00	
5103, 5105, 5203, 5205, 5210, 5303, 5310, 5410, 5510	Water Pump Cast # - R67188	AMRE67037	\$ 195.00	
5103, (5105, 5205 - w/ PE3029DLV52 Engine), 5220, (5300, 5400 ASN 248700), 5310, 5310N, 5320, 5320N, 5400N ASN 248699, 5420N, 5520N	Water Pump Cast # - R73601	AMRE67185	\$ 235.00	
5200, 5300, 5400, 5400N - w/ Oil Cooler and Engine BSN 104418	Water Pump Tractors w/ extremely early engine serial numbers may require a hub change to install pulley Cast # - R110541, R110542 Replaces RE46813, RE51893	AMRE51892	\$ 305.00	
(5200, 5300, 5400, 5500 - w/o Oil Cooler, Engine SN 202232-248699), 5400N Engine ASN 202232	Water Pump Cast # - R73604	AMRE61715	\$ 235.00	
6030, Chopper: 5400	Reman Water Pump Cast # - R48818	AMR48818	\$ 160.00	\$ 50.00
6090MC, 6090RC, 6100MC, 6100RC, 6105M, 6105R, 6110MC, 6110RC, 6115M, 6115R, 6125M, 6125R, 6130M, 6130R, 6140M, 7630, 7730, 7830, 7930, Premium Models: 6230, 6330, 6430, 6530, 6630, 6830, 6930, 7130, 7230, 7330, 7430, 7530, Combines: 9560STS, 9570STS, S550, T550, W540, Sprayers: 4730, 4830	Water Pump Replaces RE509813, RE523169	AMRE546918	\$ 130.00	
6110, 6110L, 6210, 6210L, 6310, 6310L, 6310S, 6405, 6410, 6410L, 6410S, 6510, 6510L, 6510S, 6605, 6615, 6715, 7210, 7220, 7320, 7405, 7410, 7420, 7505, 7510, 7515, 7520, 7610, 7820, 7920 - w/ 6.8L Engine	Water Pump	AMRE505980	\$ 75.00	
6145R, 6155M, 6155R, 6155RH, 6175M, 6175R, 6195M, 6195R, 6215R, 6230R, 6250R, 7210R, 7230R, 7250R, 7270R, Sprayer: R4030	Water Pump	AMRE557899	\$ 85.00	

Prices Subject to Change without Prior Notice. The use of original equipment manufacturer (OEM) part numbers or trademarks, e.g. Case® and John Deere®, are for reference purposes only and for indicating product use and compatibility. Our company and the listed replacement parts contained herein are not sponsored, approved or manufactured by the OEM. All parts are New unless designated Reman in the description.

John Deere®—Tractor

Application	Description	Part Number	Retail Price	Core
6610, 6650, 7200, 7710, 7810, 7820, 7920, 8100, 8110, 8120, 8200, 8210, 8220, 8300, 8320, 8400, 8420, 8520, 4WD: 9100, 9120, Combines: 9550, 9610, 9650, 9660 - All w/ PowerTech™ 6081 Diesel Engine	Water Pump 15 Tooth	AMRE521503	\$ 175.00	
6100, 6200, 6200L, 6300, 6300L, 6400, 6400L, 6400SP, 6500, 6500L, 6506, 6800, 6900, 7200, 7220, 7320, 7400, 7500, 7600, SE6100, SE6200, SE6300, SE6400	Water Pump Replaces RE41157, RE57722	AMRE53757	\$ 163.50	
7230R, 7250R, 7260R, 7270R, 7280R, 7290R, 7310R, 8120, 8220, 8235R, 8245R, 8260R, 8270R, 8285R, 8295R, 8310R, 8310RT, 8320R, 8320RT, 8335R, 8335RT, 8345R, 8345RT, 8360R, 8360RT, 8370R, 8370RT, 8400R, 8420, 8520, 9360R, 9370R, Combines: S650, S660, S670, S670HM, S760, S770, T560, T660, T670, Forage Harvesters: 8100, 8200, Sprayers: 4940, R4038, R4044, R4045, R4060	Water Pump	AMDZ102107	\$ 419.00	
7700, 7800, (8100, 8200, 8300 - w/ 6076 Engine)	Water Pump Cast # - RE49540W/X, RE500514W/X Replaces RE49540, RE68229, RG28370	AMRE500214	\$ 231.00	
7700, 7800, 8560, 8570, Combines: 9500, 9600, Cotton Pickers: 9965, 9970, Forage Harvester: 6610	Water Pump	AMRE68230	\$ 145.00	
7710, 7810, 7820, 7920, 8100, 8100T, 8110, 8110T, 8120, 8120T, 8200, 8200T, 8210, 8210T, 8220, 8220T, 8300, 8300T, 8310, 8310T, 8320, 8320T, 8400, 8400T, 8410, 8410T, 8420, 8420T, 8520, 8520T, 9100, 9120, Combines: 9550, 9560STS, 9610, 9650, 9650CTS, 9650STS, 9660, 9660CTS, 9660STS, 9750STS, 9760STS, CTS II, Cotton Picker: 9970, Sprayer: 4920	Water Pump 16 Tooth Gear, Low Flow	AMRE521502	\$ 145.00	
8630	Reman Water Pump Cast # - R58705	AMR58705-R	\$ 150.00	\$ 50.00
8630, 8640, 8650	Reman Water Pump Cast # - R74445	AMR74445	\$ 165.00	\$ 125.00
8640	Reman Water Pump Cast # - R67350	AMR67350-R	\$ 148.00	\$ 50.00
8650 w/ Engine BSN 499999, Combines: 9500, 9600 - All w/ Engine BSN 499999 Codes TH001, HH001, HH004	Reman Water Pump Wide Gear, Cast # - R87634 Replaces R83561, RE28368, RE55986	AMSE500911	\$ 290.00	\$ 30.00
8760, 8770, 8870	Reman Water Pump Cast # - R98303	AMR98303-R	\$ 225.00	\$ 50.00
9120, 9220, 9320, 9320T, 9420, 9420T, 9520, 9520T, 9620T, Combine: 9860STS	Water Pump	AMRE549153	\$ 525.00	
9330, (9420R, 9470R, 9520R, 9570R ASN 015000), 9420RX, 9430, 9430T, (9460R, 9510R, 9560R SN 000101-014999), (9460RT, 9510RT, 9560RT SN 900101-905999), (9470RT, 9520RT, 9570RT ASN 906000), 9470RX, 9520RX, 9530, 9530T, 9570RX, 9630, 9630T, Combines: 9870STS, (S680, S690 ASN 745100), S680HM BSN 765000, S690HM SN 745101-765000, S780, S790, Cotton Pickers: 7760, CP690, Forage Harvesters: 7350, 7380, 7450, 7480, 7550, 7580, 7750, 7780, (8300, 8400, 8500 SN 513822-620999)	Water Pump	AMRE549117	\$ 525.00	
Combines: 4400 BSN 377112, 6600 BSN 377179	Water Pump Replaces AR67818	AMR56787	\$ 150.00	\$ 50.00
Combines: 6600, 6620, 7700, 7720, 8820	Reman Water Pump Cast # - R54955	AMR54955	\$ 115.00	\$ 25.00

John Deere®—Tractor

Application	Description	Part Number	Retail Price	Core
Combine: 9400 w/ 6068 Engine SN 337246-701245	Water Pump Replaces AR74110	AMR90784	\$ 313.85	
Combine: 9400	Reman Water Pump w/o Pulley Includes Mounting Gasket Casting # - R90784 Replaces AR77142	AMR90784-R	\$ 280.00	\$ 25.00
Cotton Picker: 9900, Cotton Stripper: 484	Water Pump Cast # - R48998 Replaces AR52451, RE19937	AMAR52399	\$ 390.51	
Utility: 790, 855, 4115, 4200, 4210	Water Pump Housing Marked 801078 Replaces AM878192	AMMIA880036	\$ 145.00	
Utility: 990, 3120, 3203, 3320, 3520, 3720, 4005, 4105	Water Pump Includes Mounting Gasket	AMAM881943	\$ 120.00	
Utility: 1025R, 1026R, 2025R, 2026R, 2305, Gator™ Utility Vehicle: Pro 2030A	Water Pump Includes Mounting Gasket Replaces MIA880091, MIA882091	AMMIA885095	\$ 94.00	
Utility: 4120, 4320, 4520, 4720	Water Pump Includes Mounting Gasket Replaces RE518520, SE502115	AMRE545572	\$ 180.00	
2955, 3055, 3155, 3255, 6200, 6200L, 6300, 6300L, 6400, 6400L, 6500, 6500L, 7200, 7400, 7600, 7700, 7800	Water Pump Hub	AMR91403	\$ 84.40	
1640, 2040, 2140 ASN 429999 w/o A/C, 2350, 2550, 2750 w/o A/C	Water Pump Pulley	AMR70442	\$ 126.08	
2150, 2255, Utility: (2040, 2240 ASN 349999)	Water Pump Pulley	AMR70435	\$ 131.21	
2630	Water Pump Pulley	AMT26850	\$ 54.53	
2940, 2950, (3040, 3140 ASN 429999)	Water Pump Pulley	AMR70444	\$ 225.23	
4030	Water Pump Pulley	AMR52011	\$ 172.07	
4240, 4430, 4440, 4630, 7020, Forage Harvesters: (5200, 5400 ASN 335845), 5440 - All w/ A/C	Water Pump Pulley 8.375" OD	AMR52592	\$ 66.83	
4320 Diesel w/o A/C	Water Pump w/ Pulley Marked R46561	AMAR51063	\$ 391.79	
4320, 4520 - w/o A/C	Water Pump Pulley 6.675" OD, 4 Mounting Holes	AMR47847	\$ 183.88	
4320, 4520, 4620, 7020 - w/ A/C	Water Pump Pulley	AMR47126	\$ 189.05	
4640, 4840, Cotton Picker: 9940, Forage Harvesters: 5720, 5730	Water Pump Pulley Use w/ AMRE20022 Water Pump w/ Hub	AMR61436	\$ 197.61	

John Deere®—Tractor

Application	Description	Part Number	Retail Price	Core
5070M, 5080M, 5080R, 5085E, 5085M, 5090M, 5090R, 5090RN, 5100E, 5100M, 5100MH, 5100ML, 5100R, 5100RN, 5115M, 5115ML, 5115R, 5125R, 6020, 6090MC, 6090RC, 6100B, 6100D, 6100MC, 6100RC, 6105D, 6105E, 6105M, 6105R, 6110, 6110B, 6110D, 6110E, 6110J, 6110L, 6110M, 6110MC, 6110R, 6110RC, 6115D, 6115M, 6115R, 6120, 6120E, 6120L, 6120M, 6120R, 6125D, 6125E, 6125J, 6125M, 6125R, 6130, 6130D, 6130M, 6130R, 6135E, 6135M, 6140D, 6140J, 6140M, 6145M, 6150M, 6155J, 6155M, 6165J, 6170M, 6175M, 6180J, 6195M, 6205, 6210, 6210L, 6215, 6220, 6220L, 6225, 6230, 6310, 6310L, 6310S, 6320, 6320L, 6325, 6330, 6400, 6403, 6405, 6410, 6410L, 6410S, 6415, 6420, 6420L, 6425, 6430, 6510L, 6510S, 6520, 6520L, 6525, 6530, 6534, 6603, 6605, 6615, 6630, 6715, 6820, 6830, 6930, 7130, 7185J, 7195J, 7205J, 7210, 7210J, 7220, 7225J, 7230, 7320, 7330, 7405, 7410, 7420, 7425, 7510, 7515, 7520, 7525, 7630, 7715, 7720, 7730, 7815, 7820, 7830, 7920, 7930, SE6010, SE6020, SE6320, SE6510, SE6920, Premium Models: 7330, 7430, 7530, Ind: 210LJ, Combines: 1165, 1170, 1175, 1550, 2254, 9400, 9410, 9450, 9550, 9550SH, 9560, 9560SH, S540, S550, T550, Cotton Pickers: 9935, 9970, Cotton Strippers: 7455, 7460, Sprayers: 4630, 4700, 4710, 4720, 4730, 4830, R4023, Swathers: 4990, A400, D450, R450 - All w/ 3029, 4036, 4045 or 6068 Engine	Water Pump Pulley 94 mm Diameter	AMR115250	\$ 41.67	
(4055, 4255, 4455, 4555, 4560, 4650 ASN 324215, 4755, 4760, 4850 ASN 322745, 4955 - w/ 60706TRW06-08 Engine), (4555, 4755, 4955 - w/ 60706TRW06-08, ARW01, 02 or 06 Engine)	Fan Drive Pulley	AMR90332	\$ 161.17	
4250, 4450	Fan Drive Pulley	AMR90331	\$ 168.45	
5065M, 5075M, Utility: 4120, 4320, 4520, 4720	Fan Idler Pulley	AMRE537940	\$ 20.64	
4050, 4055, 4250, 4255, 4450, 4455, 4555, 4560, 4650, 4755, 4760, 4850, 4955, 4960, 6110, 6110L, 6120, 6120L, 6210, 6210L, 6215, 6220, 6220L, 6310, 6310L, 6310S, 6320, 6320L, 6403, 6410, 6410L, 6410S, 6415, 6420, 6420L, 6605, 6615, 6715, 7210, 7220, 7320, 7405, 7410, 7420, 7505, 7510, 7515, 7520, 7700, 7710, 7800, 7810, 8850, Combines: 8820, 9510, 9510SH, 9550, 9550SH, 9610, 9650, 9650CTS, 9660CTS, CTS II, Cotton Pickers: 9950, 9960, 9965, 9970, Sprayers: 4700, 4710, 4720	Fan Drive Bearing 1.875" OD, 1" Shaft Diameter, 4.862" Shaft Length, 2.756" Wide Race	AMJD10058	\$ 27.84	

John Deere®—Tractor

Application	Description	Part Number	Retail Price	Core
5076E, 5076EL, 5082E, 5083EN, 5085E, 5085M, 5090E, 5090EH, 5090EL, 5090M, 5093EN, 5095M, 5095MH, 5100M, 5100R, 5100RN, 5101EN, 5320N, 5403, 5410, 5415, 5415H, 5420, 5420N, 5425, 5425N, 5510, 5510N, 5520, 5520N, 5525, 5525N, 5603, 5605, 5615, 5625, 5715, 5715HC, 5725, 5725N, 6105M, 6110, 6110J, 6110L, 6110M, 6115M, 6115R, 6120M, 6120R, 6125E, 6125J, 6125M, 6125R, 6130, 6130J, 6130M, 6130R, 6135M, 6140J, 6140M, 6140R, 6145M, 6145R, 6150M, 6150R, 6155J, 6155M, 6165J, 6180J, 6210, 6210L, 6230, 6310, 6310L, 6310S, 6325, 6330, 6400, 6405, 6410, 6410L, 6410S, 6415, 6425, 6430, 6510L, 6510S, 6530, 6605, 6615, 6630, 6820, 6830, 6930, 7230, 7320, 7330, 7405, 7420, 7425, 7520, 7525, 7710, 7720, 7810, 7820, 7920, 8120, 8120T, 8220, 8220T, 8320, 8320T, 8420, 8420T, 8520, 8520T, SE6510, SE6920, Premium Models: 7330, 7430, 7530, Ind: 210LE, Engines: 3029, 4039, 4045, 6068, Combines: 1170, 2254, 9550, 9550SH, 9560, 9560SH, T550, Sprayers: 4920, R4023	Fan Drive Pulley	AMR128660	\$ 84.94	
1020, 1120, 1520, 1530, 2020, 2030, 2040, BSN 350000, 2440, 2510, 2520, 2640, 2840, 3020 BSN 123000, 4020 BSN 201000, 4040, 4230, 4240 BSN 211154, 4430, (4440, 4640, 4840 BSN 211132), 4520, 4620, 4630, 5010, 5020 BSN 025000, 5103, 5105, 5200, 5205, 5210, 5220, 5310, 5310N, 5320, 5320N, 5400, 5420N, 5520N, 6030, 7020 BSN 335846, 8440, Utility: 2240 BSN 350000, Combines: 3300, 4400, 6600, Cotton Picker: 9940 BSN 211132, Forage Harvesters: 5440, 5460, 5720, 5730 BSN 211132, Sprayers: 6000, 6100, 6500, 6600	Water Pump Shaft Bearing 5.75" Long, 2.125" Wide, 1.50" OD, 0.746" Shaft Size	AMJD9257	\$ 18.40	
3020, 4000, 4010, 4020, 4030, Combines: 6600, 6620, 7700, 7720, 8820	Water Pump Seal Kit 1-Piece Unitized Seal and Installation Tool Replaces Early 3-Piece Seal Replaces AR40698, AR41691, R32622	AMAR62933	\$ 9.86	
4240, 4440, 4640, 4840, 6030, 7520, 8430, 8440, 8630, 8640, 8650	Water Outlet Manifold Hose 90° Bend 1" ID, 12.25" Overall Length Will Replaces R49474 When Cut To Length	AMTY22404	\$ 6.40	
6110, 6110L, 6210, 6210L, 6310S, 6410, 6410L, 6410S, 6510, 6510L, 6510S, 6405, 6415, 6645, 6605, 7505, 7515	Belt Tensioner Assembly	AMAL112300	\$ 100.00	
8100, 8100T, 8110, 8110T, 8200, 8200T, 8210, 8210T, 8300, 8300T, 8310, 8310T, 8400, 8400T, 8410, 8410T, Forage Harvester: 7200	Belt Tensioner Assembly	AMRE57498	\$ 65.00	
Combines: 9750STS, 9860STS, 9880STS, Forage Harvester: 7700	Belt Tensioner Assembly	AMRE506352	\$ 95.00	
6120, 6120L, 6215, 6220, 6220L, 6230, 6320, 6320L, 6330, 6415, 6420, 6420L, 6430, 6520L, 6615, 6715, 7130, 7220, 7230, 7320, 7330, 7420, 7520, Premium Models: 6230, 6330, 6430, 7130, 7230, 7330, 7430, 7530, Sprayer: 4630	Belt Tensioner	AMAL156090	\$ 99.50	
7200, 7210, 7400, 7410, 7510, 7610, (7710, 7810 BSN 090000)	Belt Tensioner Replaces RE37981	AMRE52490	\$ 118.71	

John Deere®—Tractor

Application	Description	Part Number	Retail Price	Core
(7200R, 7215R, 7230R, 7260R, 7280R BSN 080000), 8130, (8225R, 8245R, 8270R, 8295R, 8320R, 8345R SN 000101-053099), 8230, 8230T, (8235R, 8260R, 8285R, 8310R, 8335R, 8360R SN 016001-090000), (8295RT, 8320RT, 8345RT SN 900101-907100), (8310RT, 8335RT, 8360RT SN 902501-912000), 8330, 8330T, 8430, 8430T, 8530T, (9410R, 9460R, 9510R, 9560R SN 000101-014999), 9420RX, (9460RT, 9510RT, 9560RT SN 900101-905999), (9470R, 9520R, 9570R ASN 015000), (9470RT, 9520RT, 9570RT ASN 906000), 9470RX, 9520RX, 9570RX, Combine: T550, Cotton Pickers: 7760, CP690, Forage Harvesters: 7280, 7380, 7480, 7580, 7780, Sprayers: 4930, 4940	Belt Tensioner Replaces DZ10469	AMRE243199	\$ 104.00	
7600, 7700, (7710, 7810 BSN 090000) 7800, 9100 Engine BSN 087143, Combines: 9510, 9510SH, 9550, 9550SH, 9610, 9650, 9650CTS, 9660, 9660CTS, CTS II, Cotton Pickers: 9970 Early, 9976 ASN 4000 w/ 6081HN003 Engine, 9986, Sprayers: 4700, 4710	Belt Tensioner Replaces RE37981, 86013886	AMRE68715	\$ 68.00	
7720, 7820, 7920, 8120, 8120T, 8220, 8220T, 8320, 8320T, 8420, 8420T, 8520, 8520T, 9220, 9300T, 9320, 9320T, 9400T, 9420, 9420T, 9520, 9520T, 9620, 9620T, Cotton Picker: 9970	Belt Tensioner, Accessory Drive	AMRE170084	\$ 99.40	
8120, 8220, 8320, 8420, 8520	Belt Tensioner	AMRE184034	\$ 70.00	
8120, 8220, 8420, 8520, Sprayer: 4920	Belt Tensioner Replaces RE164876	AMRE193648	\$ 89.00	
9100, 9120, 9200, 9220, 9300, 9300T, 9320, 9320T, 9400, 9400T, 9420, 9420T, 9520, 9520T, 9620, 9620T, Combines: 9860STS, 9870STS, Cotton Picker: 7760, Forage Harvesters: 6650, 6750, 6850, 6950, 7350, 7380, 7450, 7480, 7550, 7580, 7780	Belt Tensioner Replaces RE170083	AMRE249801	\$ 204.00	
9330, 9360R, 9370R, 9430, 9430T, 9530, 9530T, 9630, 9630T, Combines: S660, S670	Belt Tensioner	AMRE243154	\$ 78.50	
6110, 6110L, 6120, 6120L, 6200, 6200L, 6210, 6210L, 6215, 6220, 6220L, 6300, 6300L, 6310, 6310L, 6310S, 6320, 6320L, 6400, 6400L, 6405, 6410, 6410L, 6410S, 6415, 6420, 6500, 6500L, 6510L, 6510S, 6520L	Tensioner Isolator	AMAL81953	\$ 17.50	

Fan Clutches

Application	Description	Part Number	Retail Price	Core
2955 BSN 767516, 3055	Fan Clutch Assembly Replaces AL66911, RE26919	AMAL69177	\$ 330.00	
3155, 3255, (6200, 6300, 6400 BSN 125189)	Fan Clutch Assembly Replaces AL66912, RE29482	AMAL69178	\$ 310.00	
4050, 4055, 4250, 4255, 4450, 4455, (8100, 8200, 8300, 8400 BSN 025869), (8100T, 8200T, 8300T, 8400T BSN 904191)	Fan Clutch Assembly Replaces AR96822, RE37443, RE188987	AMRE274870	\$ 635.00	
4555, 4560, 4650, 4755, 4760, 4850, 4955, 4960	Fan Clutch Assembly Replaces AR96825, RE37444	AMRE50225	\$ 585.00	
6110, 6110L, 6210, 6210L, 6310, 6310L, 6310S, 6405, 6410, 6410L, 6410S, 6510S, 6605	Fan Clutch Assembly	AMAL118091	\$ 265.00	
6110D, 6115D, 6125D, 6130D, 6140D	Fan Clutch Assembly	AMRE284596	\$ 465.00	
6120, 6120L, 6215, 6220, 6220L, 6320, 6320L, 6415, 6420, 6420L, 6520L	Fan Clutch Assembly Replaces AL167769	AMAL155873	\$ 395.00	

John Deere®—Tractor

Application	Description	Part Number	Retail Price	Core
6200, 6200L, 6300, 6300L, 6400, 6400L, 6500, 6500L	Fan Clutch Assembly	AMAL81448	\$ 460.00	
6430 ASN 634684, 7130, 7230, 7330	Fan Clutch Assembly	AMAL167987	\$ 375.00	
6615, 6715, 7220, 7320, 7420, 7520	Fan Clutch Assembly Replaces AL167770	AMAL155874	\$ 395.00	
7210, 7405, 7410, 7510	Fan Clutch Assembly Replaces RE165218	AMRE64271	\$ 425.00	
7710, 7810	Fan Clutch Assembly Replaces RE65834	AMRE70548	\$ 400.00	
7820, 7920	Fan Clutch Assembly	AMRE181927	\$ 475.00	
8110, 8110T, 8210, 8210T, 8310, 8310T, 8410, 8410T	Fan Clutch Assembly Replaces RE166013	AMRE187516	\$ 945.00	
8120, 8120T, 8220, 8220T, 8320, 8320T	Fan Clutch Assembly	AMRE164619	\$ 550.00	
8420 BSN 015166, 8420T BSN 902387	Fan Clutch Assembly	AMRE184071	\$ 835.00	
(8420, 8420T ASN 015167)	Fan Clutch Assembly Replaces RE220071	AMRE274876	\$ 550.00	
9120, 9220	Fan Clutch Assembly Replaces RE190791	AMRE274874	\$ 650.00	
2030 Gas, 3010, 3020	Fan, 5 Blade 18" Diameter, 1.50" Pilot Hole 8 Mounting Holes on 1" Centers 4 Mounting Holes on 2.875" Centers 4 Mounting Holes on 2.50" Centers Replaces AR26422	AMAR34450	\$ 169.26	
2510, 2520	Fan, 6 Blade 16" Diameter, 1.50" Pilot Hole 4 Mounting Holes on 1.75" Centers Replaces T23419	AMAR38790	\$ 96.13	
2940, 2950, 3150, 4030, 4040, 4230, Swathers: 3830, 4890	Fan, 6 Blade 21" Diameter, 1.50" Pilot Hole 8 Mounting Holes on 1.0625" Centers	AMAR64075	\$ 106.62	
4000, 4010, 4020, 4230 Diesel w/o A/C	Fan, 5 Blade 21" Diameter, 1.50" Pilot Hole 8 Mounting Holes on 1" Centers Replaces AR32172	AMAR34451	\$ 144.20	
4050, 4055, 4250, 4255, 4450, 4455	Fan, 8 Blade 24.50" Diameter, 5" Pilot Hole 6 Mounting Holes on 3" Centers	AMAR94950	\$ 129.04	
4320, 4520 Engine ASN 303518, 4620, 7020, Forage Harvesters: 5200, 5400, 5440	Fan, 6 Blade 23" Diameter, 1.50" Pilot Hole 4 Mounting Holes on 2" Centers	AMAR48871	\$ 116.19	
4430, 4630	Fan, 6 Blade 24" Diameter, 1.50" Pilot Hole 4 Mounting Holes with 2" Centers	AMAR60401	\$ 199.36	
4640, 4840, Cotton Picker: 9940	Fan, 8 Blade 26" Diameter, 2" Pilot Hole 6 Mounting Holes on 1.75" Centers	AMAR85893	\$ 175.27	
6105R, 6110, 6110L, 6110R BSN 856625 Non MY18, 6115R, 6125R, 6200, 6200L, 6210, 6210L, 6230, 6300, 6300L, 6310, 6310L, 6310S, 6330, 6400, 6400L, 6405, 6410, 6410L, 6410S, 6430, 6500 w/ Viscous Fan Drive, 6500L, 6510S, 6605, 7200, 7210, 7400, 7410, 7510, Premium: 6230, 6330, 6430	Fan, 7 Blade 21" Diameter, 3.50" Pilot Hole 4 Mounting Holes on 2.6875" Centers	AML79028	\$ 143.96	
4055, 4255, 4455, 4555, 4755, 4955, 4960	Fan Drive Pulley 2-Groove	AMR98586	\$ 147.49	
5065M, 5075M, 5225, Utility: 4120, 4320, 4520, 4720	Fan Drive Hub w/ Bearing	AMRE505621	\$ 85.95	

John Deere®—Tractor

Belts

Application	Description	Part Number	Retail Price	Core
1640, 2040, 2140, 2350, 2550, 2750	A/C Compressor Belt	AML41331	\$ 14.28	
2030 Gas	Fan Belt	AMT24473	\$ 20.00	
930, 1020, 1030, 1120, 1130, 1520 Gas or Diesel, 1530 w/ Motorola Alternator, 1630, 1830, 2020, 2030 Diesel, (2040, 2440 BSN 350000), 2120, 2130, Ind: 300B Gas or Diesel, Utility: 820 ASN 075345, 830, 2240 BSN 350000	Fan Belt Replaces T20334	AMR97758	\$ 13.00	
2040 ASN 350000	Fan Belt	AMR73784	\$ 20.00	
2940	Fan Belt	AMR73785	\$ 16.62	
	A/C Compressor Belt	AML41330	\$ 12.00	
(2150, 2255 ASN 350000) Utility: 2240 ASN 350000	Fan Belt	AMR73784	\$ 20.00	
3010 Gas or LPG	Fan Belt, Alt / Gen Belt	AMR41627	\$ 10.54	
3010 Diesel	Fan Belt	AMR41681	\$ 8.25	
	Alt / Gen Belt	AMR71459	\$ 14.27	
4000 Diesel ASN 201000 w/o A/C	Fan Belt, Alt / Gen Belt, Water Pump	AMR71459	\$ 14.27	
4000, 4020 - w/ Diesel ASN 257272 w/ A/C	Fan Belt, Alt / Gen Belt, Water Pump	AMR52507	\$ 12.69	
4030 BSN 7170	Fan Belt, Alt / Gen Belt	AMR46113	\$ 14.00	
	A/C Compressor Belt	AMR53258	\$ 19.76	
4030 ASN 7171	Fan Belt, Alt / Gen Belt	AMR46113	\$ 14.00	
	A/C Compressor Belt	AMR56858	\$ 19.53	
4230 Gas	Fan Belt, Alt / Gen Belt	AMR41681	\$ 8.25	
	A/C Compressor Belt	AMR71603	\$ 5.45	
4230 Diesel	Fan Belt, Alt / Gen Belt	AMR70871	\$ 7.19	
	A/C Compressor Belt	AMR71603	\$ 5.45	
4320	Fan Belt w/o A/C	AMAR43219	\$ 25.60	
	Fan Belt w/ A/C	AMAR56638	\$ 17.33	
	A/C Compressor Belt	AMR71603	\$ 5.45	
4430	Fan Belt, Alt / Gen Belt	AMAR57266	\$ 13.12	
	A/C Compressor Belt	AMR71603	\$ 5.45	
4630 w/o Cooling Kit Installed	Fan Belt, Alt / Gen Belt	AMAR57266	\$ 13.12	
	A/C Compressor Belt	AMR71603	\$ 5.45	
4630 w/ Cooling Kit Installed	Fan Belt, Alt / Gen Belt	AMAR54592	\$ 14.50	
	A/C Compressor Belt	AMR71603	\$ 5.45	
4040	Fan Belt, Alt / Gen Belt	AMR70871	\$ 7.19	
	A/C Compressor Belt	AMR71603	\$ 5.45	
4520 ASN 303519	Fan Belt, Alt / Gen Belt	AMAR51059	\$ 31.23	
	A/C Compressor Belt	AMAR56638	\$ 17.33	
4050 w/ 6466 Engine	Fan Belt, Alt / Gen Belt	AMRE29018	\$ 14.50	
	A/C Compressor Belt	AMR73189	\$ 5.70	
4050 w/ 6359 Engine ASN 6510	Fan Belt, Alt / Gen Belt	AMRE29018	\$ 14.50	
	A/C Compressor Belt	AMB2893R	\$ 8.39	
4055	Fan Belt, Alt / Gen Belt	AMRE41942	\$ 13.48	
	A/C Compressor Belt	AMR73189	\$ 5.70	
4255, 4455, 4555	Fan Belt, Alt / Gen Belt	AMRE41942	\$ 13.48	
	A/C Compressor Belt	AMR73189	\$ 5.70	
6030 w/ 6531A Engine	Fan Belt, Alt / Gen Belt	AMAR53099	\$ 30.50	
7200, 7400 - w/o Cab	Fan Belt, Alt / Gen Belt	AMR118317	\$ 35.93	
7200, 7400 - w/ Cab	Fan Belt, Alt / Gen Belt	AMR115614	\$ 46.69	

John Deere®—Tractor

Application	Description	Part Number	Retail Price	Core
(7210R, 7230R SN 080001-110100), (7R 210, 7R 230 ASN 110101)	Fan Belt	AMR540112	\$ 59.45	
7600	Fan Belt	AMR95917	\$ 26.93	
7700, 7800 - w/ Cab	Fan Belt	AMR106120	\$ 24.44	
7700, 7800 - w/o Cab	Fan Belt	AMR106122	\$ 29.27	
7820, 7920	Fan Belt 8 Rib For 8.1 Liter Engine w/ Viscous Fan Drive Replaces R181918	AMR269531	\$ 58.00	
8630 BSN 44788	Fan Belt, Alt / Gen Belt	AMAR86496	\$ 15.38	
	A/C Compressor Belt	AMR71602	\$ 6.86	
8630 ASN 44789	Fan Belt, Alt / Gen Belt	AMRE12086	\$ 27.79	
8640	Fan Belt, Alt / Gen Belt	AMAR87671	\$ 24.88	
	A/C Compressor Belt	AMR71602	\$ 6.86	
8450 BSN 5185	Fan Belt	AMAR57266	\$ 13.12	
	Alt / Gen Belt	AMR71603	\$ 5.45	
	A/C Compressor Belt	AMR73189	\$ 5.70	
8650 BSN 7313	Fan Belt Set of 3	AMRE10219	\$ 63.28	
	Alt / Gen Belt	AMR76835	\$ 9.37	
	A/C Compressor Belt	AMR73189	\$ 5.70	
8560 BSN 3100	Fan Belt, Alt / Gen Belt	AMAT58166	\$ 40.75	
	A/C Compressor Belt	AMR73189	\$ 5.70	
8650 ASN 7314	Fan Belt Set of 2	AMRE10219	\$ 63.28	
	Alt / Gen Belt	AMR82009	\$ 8.69	
	A/C Compressor Belt	AMR73189	\$ 5.70	
8560 (ASN 3101 or Engine ASN 500000)	Fan Belt, Alt / Gen Belt	AMRE50215	\$ 14.82	
	A/C Compressor Belt	AMR73189	\$ 5.70	
8850 (Idler Pulley AP98042)	Fan Belt, Alt / Gen Belt	AMR81271	\$ 8.54	
	A/C Compressor Belt	AMR69393	\$ 9.96	
8760 BSN 5100	Fan Belt	AMRE37311	\$ 31.35	
	Alt / Gen Belt	AMRE37851	\$ 21.23	
	A/C Compressor Belt	AMR73189	\$ 5.70	
8760 ASN 5101	Fan Belt Set of 2	AMRE50216	\$ 32.03	
	Alt / Gen Belt	AMRE37851	\$ 21.23	
	A/C Compressor Belt	AMR73189	\$ 5.70	
8960	Fan Belt, Alt / Gen Belt	AMR101069	\$ 44.00	
	A/C Compressor Belt	AMR73189	\$ 5.70	
8970	Fan Belt	AMR111090	\$ 30.04	
	Alt / Gen Belt	AMRE49979	\$ 19.52	
	A/C Compressor Belt	AMR116308	\$ 8.95	
(8120, 8220, 8320, 8420, 8520 BSN 023919), (8120T, 8220T, 8320T, 8420T, 8520T BSN 903263), Sprayer: 4920 BSN 0151	Belt Tensioner	AMAH155348	\$ 75.00	



Carburetors

Application	Description	Part Number	Retail Price	Core
320, 330, 420, 430, 1020, 2010, 2020, 2030, 2510	Carburetor	AMX82007	\$ 550.00	
3010, 3020	Carburetor Cast Housing	AMAR34242C-N4	\$ 662.00	\$ 100.00
3010, 3020, 4010, 4020	Reman Carburetor Aluminum Housing	AMAR34242	\$ 295.00	\$ 100.00
3010, 3020, 4010, 4020	Reman Carburetor Cast Housing	AMAR34242C	\$ 400.00	\$ 100.00
4010, 4020	Carburetor Cast Housing	AMAR34242C-N6	\$ 662.00	\$ 100.00
4030	Reman Carburetor Replaces RE39188	AMAR59986	\$ 375.00	\$ 100.00
1020, 1520	Choke Cable 34 1/2" Long	AMAT21466	\$ 38.20	
2020, 2030, 2520	Choke Cable 37" Long	AMAT20781	\$ 39.93	
2510, 4010, 4020 BSN 200999	Choke Cable 44" Long	AMAR27301	\$ 65.49	
3010 BSN 049999, 3020 BSN 122999, 4000, 4020	Choke Cable 40" Long	AMAR50707	\$ 27.82	
3020 ASN 123000	Choke Cable 33" Long	AMAR45735	\$ 57.25	



Fuel Lift Pumps

Application	Description	Part Number	Retail Price	Core
2355, 2355N, 2555, 2755, 2855N, 2955, 3055, 3155, 3255, Utility: 2155	Fuel Lift Pump	AMRE38009	\$ 54.50	
3010, 4010	Fuel Lift Pump Replaces RE53567	AMRE43273	\$ 32.66	
4055, 4250, 4255, 4440, 4450, 4640 w/ Engine ASN 069689, 4650, 4755 w/ Engine BSN 165527, 4760, 4850, 8440, 8450, Combines: 6620, 7720, 8820, Cotton Picker: 9950, Forage Harvesters: 5440 w/ Engine ASN 557082, 5720	Fuel Lift Pump Use w/ Robert Bosch Injection Pump Replaces AR89956, RE12386, RE27848	AMRE20042	\$ 165.16	
5082E, 5083E, 5083E Limited, 5083EN, 5090E, 5093E, 5093E Limited, 5101E, 5101E Limited, 5101EN, 6110M, 6110R, 6115M, 6115R, (6120, 6120L, 6215, 6220, 6220L, 6320, 6320L, 6415, 6420, 6420L - w/ Tier 2 Engine ASN 443675), 6120M, 6120R, 6125M, 6125R, 6130M, 6130R, 6140J, 6140M, 6140R, 6145M, 6145R, 6150M, 6150R, 6155J, 6155M, 6155R, 6170M, 6175M, 6195M, 6230, 6330, 6430, 6520L, (6615, 6715 ASN 443618), 7130, (7220, 7230, 7420, 7520 - w/ Tier 2 Engine), 7320, Premium Models: 6230, 6330, 6430, 7130, 7230, 7330, 7430, 7530	Fuel Lift Pump	AMAL168483	\$ 99.50	
6110, 6110L, 6120, 6200, 6200L, 6210, 6215, 6220, 6300, 6300L, 6310, 6310L, 6310S, 6320, 6400, 6410, 6410L, 6410S, 6420, 6500L, 6506, 6510, 6510L, 6510S, 6520, 6600, 6605, 6610, 6620, 6800, 6810, 6820, 6910, 6910S, 6920, 6920S, 7220	Fuel Lift Pump Tank Mount Replaces AL81173, AL113125	AMAL78405	\$ 57.50	
(6120, 6120L, 6215, 6220, 6220L, 6320, 6320L, 6415, 6420, 6420L, 6520L - w/ Tier 2 Engine BSN 443676), (6615, 6715 BSN 443619), (7220, 7320, 7420, 7520 - w/ Tier 2 Engine SN 012451-034662)	Fuel Lift Pump	AMAL155607	\$ 83.00	

John Deere®—Tractor

Application	Description	Part Number	Retail Price	Core
6310, 6320, 6410, 6420, 6420L, 7220, 7320, 7420, 7520	Fuel Lift Pump, 12 Volt Stanadyne®, 59.97 GPH Flow Rate	AMRE509530	\$ 201.50	
7210, 7405, 7410, 7500, 7510, (7610, 7710, 7810 BSN 089999), Combines: 1165, 1170	Fuel Lift Pump	AMRE68345	\$ 50.00	
7210, 7410, 7510, 7720, 7820, Combines: 9400 w/ Engine ASN 701275, 9410, 9450, Cotton Picker: 9935, Cotton Strippers: 7455, 7460, Sprayers: 4700 w/ Engine SN 704808-804312, 4720, Swathers: 4890, 4895, 4990, 4995	Fuel Lift Pump	AMRE66153	\$ 39.00	
Utility: 4120, 4320, 4520, 4720	Fuel Lift Pump Replaces RE515953, RE525102	AMRE532211	\$ 62.50	
4040, 4050, 4230, Combines: 6600, 6620, 7700	Fuel Transfer Pump	AMAR57264	\$ 54.89	
4320, 4520, 4620, 7020	Fuel Transfer Pump Replaces RE43272	AMAR49771	\$ 78.93	
Ind: 210L	Fuel Transfer Pump	AMAT318139	\$ 71.00	
Engines, Gas or Diesel: 3.152D, 3.164D, 3.179D, 3.179T, 4.202, 4.219, 4.239D, 4.239T, 4.276D, 4039D, 4039T, 4045D, 4045T, 6.303, 6.329, 6.359D, 6.359T, 6059D, 6059T, 6068T	Fuel Transfer Pump Replaces RE27667, RE42211	AMAR52159	\$ 43.00	
320, 330, 420, 430, 1010	Fuel Strainer Assembly Use w/ 3/8" Standard Pipe Thread Replaces 70237944, AT326991	AMAM3100T	\$ 18.00	

Injection Pumps

All of our injection pumps are disassembled, thoroughly cleaned and inspected. All worn out parts are replaced and the pumps are reassembled with new gaskets. Pumps are tested for leaks and fuel delivery at low idle, high idle, full load, part load and at start up. Any pumps with an automatic advance system has the advance set. As an additional quality check, all pumps are tested with a special oil that will not varnish inside the pump.



Application	Description	Part Number	Retail Price	Core
414 Power Unit	Reman Injection Pump	AMP414-DM	\$ 1250.00	\$ 200.00
1530	Reman Injection Pump CAV, Mfg # - 3432-440	AMP1530-DPA	\$ 1075.00	\$ 200.00
2010	Reman Injection Pump Roosa Master, Mfg # - DBGVC429-2DH	AMP2010-DBGVC	\$ 975.00	\$ 300.00
2020	Reman Injection Pump Roosa Master, Mfg # - JDB431-2731	AMP2020-JDB	\$ 995.00	\$ 300.00
2030	Reman Injection Pump Roosa Master, Mfg # - JDB435-2860	AMP2030-JDB	\$ 995.00	\$ 300.00
2510	Reman Injection Pump Roosa Master, Mfg # - JDB421-2DH	AMP2510-JDB	\$ 995.00	\$ 300.00
2520	Reman Injection Pump Roosa Master, Mfg # - JDB431LL2473	AMP2520-JDB	\$ 995.00	\$ 300.00
2630	Reman Injection Pump Roosa Master, Mfg # - JDB435 3795	AMP2630-JDB	\$ 995.00	\$ 300.00
2640	Reman Injection Pump Bosch, Mfg # - JDB435MB2811, JDB435MD2688	AMP2640	\$ 835.00	\$ 200.00
2840	Reman Injection Pump CAV, Mfg # - 3462F520, F640	AMP2840F520	\$ 950.00	\$ 200.00
2940	Reman Injection Pump CAV, Mfg # - 3462F640	AMP2940-DPA	\$ 1075.00	\$ 200.00
3010	Reman Injection Pump Roosa Master, Mfg # - DBGVC429-4AF, 5AF, 8AJ	AMP3010-DBGVC	\$ 975.00	\$ 300.00

John Deere®—Tractor

Application	Description	Part Number	Retail Price	Core
3020	Reman Injection Pump Roosa Master, Mfg # - CBC431-1AL, 7AL, 8AL	AMP3020-CBC	\$ 1100.00	\$ 300.00
	Reman Injection Pump Roosa Master, Mfg # - DBGVC431-1AJ, 3AJ	AMP3020-DBGVC	\$ 975.00	\$ 300.00
	Reman Injection Pump Roosa Master, Mfg # - JDB431AL2401	AMP3020-JDB	\$ 995.00	\$ 300.00
3150, 3155	Reman Injection Pump Roosa Master, Mfg # - DB2-635-4378	AMP3640-DB2	\$ 1050.00	\$ 300.00
3300	Reman Injection Pump Roosa Master, Mfg # - JDB431-2800	AMP3300-JDB	\$ 995.00	\$ 300.00
4010	Reman Injection Pump Roosa Master, Mfg # - DBGVC631-1AJ, 4AF, 11AF	AMP4010-DBGVC	\$ 975.00	\$ 300.00
4020	Reman Injection Pump Roosa Master, Mfg # - CBC633-1AL, 18AL	AMP4020E-CBC	\$ 1100.00	\$ 300.00
	Reman Injection Pump Roosa Master, Mfg # - CBC633-28AL	AMP4020P-CBC	\$ 1175.00	\$ 300.00
	Reman Injection Pump Roosa Master, Mfg # - CBC633-24AL	AMP4020S-CBC	\$ 1175.00	\$ 300.00
	Reman Injection Pump Roosa Master, Mfg # - DBGVC633-1AJ, 3AJ, 5AJ	AMP4020-DBGVC	\$ 975.00	\$ 300.00
	Reman Injection Pump Roosa Master, Mfg # - JDB633AL2402, AL2404	AMP4020-JDB	\$ 995.00	\$ 300.00
	Injection Pump Drive Shaft For AMP4020-JDB Roosa Master Pump	AMR32408	\$ 95.00	
4030	Reman Injection Pump Roosa Master, Mfg # - JDB633AJ2594, MB2594	AMP4030-JDB	\$ 995.00	\$ 200.00
4040	Reman Injection Pump Roosa Master, Mfg # - DM4629-3143	AMP4040-DM4	\$ 1250.00	\$ 200.00
4050 Early	Reman Injection Pump Roosa Master, Mfg # - DM46294098	AMP4050-DM4629	\$ 1250.00	\$ 300.00
4050 w/ 6359T Engine	Reman Injection Pump Roosa Master, Mfg # - DM46274543	AMP4050-DM4627	\$ 1250.00	\$ 300.00
4050 Late	Reman Injection Pump Bosch, Mfg # - ES6A95D410RS2522 Pump # - 9400 230 118	AMP4050-PES	\$ 1425.00	\$ 300.00
4055	Reman Injection Pump Bosch, Mfg # - PES6A100410RS2754 Pump # - 0400 876 398	AMP4055-PES	\$ 1425.00	\$ 200.00
4230	Reman Injection Pump Roosa Master, Mfg # - DM4629-2982, 3805	AMP4230-DM4	\$ 1250.00	\$ 200.00
	Reman Injection Pump Roosa Master, Mfg # - DM2633-JM2580, ME2870	AMP4230-DM2	\$ 1250.00	\$ 200.00
4240	Reman Injection Pump Roosa Master, Mfg # - DM4629-3147	AMP4240-DM4	\$ 1250.00	\$ 200.00
4250 Early	Reman Injection Pump Roosa Master, Mfg # - DM4629-4316	AMP4250-DM4	\$ 1250.00	\$ 200.00
4250 Late	Reman Injection Pump Bosch, Mfg # - PES6A95D410RS2522 Pump # - 9400 230 045	AMP4250-PES	\$ 1425.00	\$ 300.00
4255	Reman Injection Pump Bosch, Mfg # - PES6A100410RS2754 Pump # - 0400 876 399	AMP4255-PES	\$ 1425.00	\$ 200.00
4320	Reman Injection Pump Roosa Master, Mfg # - JDB633JT2400	AMP4320-JDB	\$ 995.00	\$ 300.00

John Deere®—Tractor

Application	Description	Part Number	Retail Price	Core
4400	Reman Injection Pump Roosa Master, Mfg # - JDB635-2558	AMP4400-JDB635	\$ 995.00	\$ 300.00
	Reman Injection Pump Roosa Master, Mfg # - JDB431-2409	AMP4400-JDB431	\$ 995.00	\$ 200.00
	Reman Injection Pump Roosa Master, Mfg # - JDB435-2442, 2802	AMP4400-JDB435	\$ 995.00	\$ 300.00
4430 Early	Reman Injection Pump Bosch (Mech), Mfg # - PES6A95D410RS2380	AMP4430E-PES	\$ 1425.00	\$ 200.00
4430 Late	Reman Injection Pump Bosch (Hyd), Mfg # - PES6A95D410RS2479	AMP4430L-PES	\$ 1425.00	\$ 200.00
4440	Reman Injection Pump Bosch, Mfg # - PES6A95D410RS2522, RS2536	AMP4440-PES	\$ 1425.00	\$ 200.00
4450	Reman Injection Pump Nippondenso, Mfg # - PES6190000-698	AMP4450-NIP	\$ 1875.00	\$ 700.00
	Reman Injection Pump Bosch, Mfg # - PES6A100P4/10RS2676 Pump # - 940023044, 9300230066	AMP4450-PES	\$ 1425.00	\$ 200.00
4455	Reman Injection Pump Bosch, Mfg # - PES6A100410RS2754 Pump # - 0400 876 360	AMP4455-PES	\$ 1425.00	\$ 200.00
4520	Reman Injection Pump Roosa Master, Mfg # - CBC633-38AL	AMP4520-CBC	\$ 1175.00	\$ 300.00
	Reman Injection Pump Roosa Master, Mfg # - JDB633AL2718	AMP4520-JDB	\$ 995.00	\$ 400.00
4620	Reman Injection Pump Roosa Master, Mfg # - JDC625-JT2398	AMP4620-JDC	\$ 1050.00	\$ 400.00
4630 Early	Reman Injection Pump Bosch (Mech), Mfg # - PES6A100D410RS3020	AMP4630E-PES	\$ 1425.00	\$ 200.00
4630 Late	Reman Injection Pump Bosch (Hyd), Mfg # - PES6A100D410RS3025	AMP4630L-PES	\$ 1425.00	\$ 200.00
4640	Reman Injection Pump Bosch, Mfg # - PESGA100D410RS3028, RS3029	AMP4640-PES	\$ 1535.00	\$ 200.00
4650	Reman Injection Pump Bosch, Mfg # - PES6A100D410RS2676 Pump # - 9400230067	AMP4650-PES	\$ 1425.00	\$ 200.00
4755	Reman Injection Pump Bosch, Mfg # - PES6A100D410RS2762	AMP4755-PESB	\$ 1425.00	\$ 200.00
	Reman Injection Pump Nippondenso, Mfg # - PES6A100D410RS2672 Pump # - 0400 876 360	AMP4755-PESN	\$ 1425.00	\$ 200.00
4760	Reman Injection Pump Nippondenso, Mfg # - PES6A1001410RND929	AMP4760-PES	\$ 1425.00	\$ 200.00
4840	Reman Injection Pump Bosch, Mfg # - PES6P110A720RS361	AMP4840-PES	\$ 1875.00	\$ 200.00
4850	Reman Injection Pump Bosch, Mfg # - PES6P110A720RS3083 Pump # - 9400 231 084	AMP4850-PES	\$ 1785.00	\$ 200.00
	Reman Injection Pump Nippondenso, Mfg # - PES6P110A410RND596 Pump # - 190 000 596	AMP4850-PES-NIP	\$ 1875.00	\$ 200.00
4955	Reman Injection Pump Nippondenso, Mfg # - PES6NB120C720RND501 Pump # - 191000-501	AMP4955-PES	\$ 2000.00	\$ 700.00
4960	Reman Injection Pump Nippondenso, Mfg # - PES6NB120C720RND931 Pump # - 191000-931	AMP4960-PES	\$ 2000.00	\$ 700.00

John Deere®—Tractor

Application	Description	Part Number	Retail Price	Core
5010	Reman Injection Pump Roosa Master, Mfg # - DBGFC633-1AJ	AMP5010-DBGFC	\$ 975.00	\$ 200.00
5020	Reman Injection Pump Roosa Master, Mfg # - DBGFC637-50AJ	AMP5020-DBGFC	\$ 975.00	\$ 300.00
5030	Reman Injection Pump Roosa Master, Mfg # - DBGFC637-91AL	AMP5030-DBGFC	\$ 975.00	\$ 300.00
5200	Reman Injection Pump CAV, Mfg # - 3239F200W Replaces RE45524, SE501555	AMP3239F200W	\$ 975.00	\$ 350.00
5210	Reman Injection Pump Stanadyne®, Mfg # - DB4327-5360 Replaces RE500441	AMP5210-DB4	\$ 1150.00	\$ 450.00
5310	Reman Injection Pump Stanadyne®, Mfg # - DB4327-5366 (5562) Replaces RE500442, SE500875	AMP5310-DB4	\$ 1150.00	\$ 450.00
5410	Reman Injection Pump Stanadyne®, Mfg # - DB2435-5354 Replaces RE70452, SE500754	AMP5410-DB2	\$ 1150.00	\$ 450.00
5510	Reman Injection Pump Stanadyne®, Mfg # - DB4429-5371 Replaces DB45371, RE70453, SE500679	AMP5510-DB4	\$ 1150.00	\$ 450.00
5520	Reman Injection Pump Stanadyne®, Mfg # - DB4-5585 Replaces RE502792, SE500770	AMP5520-DB4	\$ 1150.00	\$ 450.00
6030	Reman Injection Pump Bosch, Mfg # - PES6P100A720RS1010	AMP6030-PES	\$ 1750.00	\$ 200.00
6100	Reman Injection Pump CAV, Mfg # - 3349F080	AMP3349F080	\$ 975.00	\$ 350.00
6300	Reman Injection Pump Lucas, Mfg # - 3349F140 Replaces RE57671	AMP6300-PES	\$ 995.00	\$ 350.00
6200	Reman Injection Pump CAV, Mfg # - 3349F090 Replaces RE47706, SE501558	AMP6200-DPA	\$ 1075.00	\$ 350.00
6500	Reman Injection Pump Lucas, Mfg # - DP201-8920A110W, 111W Replaces RE61947	AMP6500-DB4	\$ 1150.00	\$ 450.00
6600	Reman Injection Pump Roosa Master, Mfg # - JDB633-2415, JDB635-2446	AMP6600-JDB	\$ 995.00	\$ 300.00
	Reman Injection Pump Roosa Master, Mfg # - DM2633-2608, 2870	AMP6600-DM2	\$ 1250.00	\$ 200.00
	Reman Injection Pump Roosa Master, Mfg # - DM4629-3276	AMP6600-DM4-76	\$ 1250.00	\$ 200.00
	Reman Injection Pump Roosa Master, Mfg # - DM4629-2990	AMP6600-DM4-90	\$ 1250.00	\$ 200.00
6620	Reman Injection Pump Bosch, Mfg # - PES6A95D410RS2561	AMP6620-PES	\$ 1350.00	\$ 200.00
7020	Reman Injection Pump Roosa Master, Mfg # - JDC625JT2399	AMP7020-JDC	\$ 1150.00	\$ 300.00
7210	Reman Injection Pump Stanadyne®, Mfg # - DB4-5528	AMP7210-DB4	\$ 1150.00	\$ 450.00
7410	Reman Injection Pump Roosa Master, Mfg # - DB4629-5404 Replaces RE502825	AMP7410-DB4	\$ 1100.00	\$ 400.00
7510	Reman Injection Pump Stanadyne®, Mfg # - DB4 629 5530	AMP7510-DB4	\$ 1150.00	\$ 450.00

John Deere®—Tractor

Application	Description	Part Number	Retail Price	Core
7520	Reman Injection Pump Bosch, Mfg # - PES6P100A720RS1010	AMP7520-PES	\$ 1750.00	\$ 200.00
7600	Reman Injection Pump Stanadyne®, Mfg # - DB4 4993	AMP7600-DB4	\$ 1150.00	\$ 450.00
7610	Reman Injection Pump Roosa Master, Mfg # - DB4629-5530	AMP7610-DB4	\$ 1050.00	\$ 300.00
7700	Reman Injection Pump Roosa Master, Mfg # - CBC633-26AL	AMP7700-CBC	\$ 1150.00	\$ 300.00
	Reman Injection Pump Roosa Master, Mfg # - JDB633-2403, 2720	AMP7700-JDB	\$ 995.00	\$ 400.00
	Reman Injection Pump Roosa Master, Mfg # - DM2633-2871	AMP7700-DM2	\$ 1250.00	\$ 200.00
	Reman Injection Pump Roosa Master, Mfg # - DM4629-2983	AMP7700-DM4	\$ 1250.00	\$ 200.00
	Reman Injection Pump Bosch, Mfg # - PES6A95D410RS2380, RS2500	AMP7700-PES-00	\$ 1425.00	\$ 200.00
	Reman Injection Pump Bosch, Mfg # - PES6A95D410RS2479, RS2561, RS3033	AMP7700-PES-33	\$ 1425.00	\$ 200.00
	Reman Injection Pump Stanadyne®, Mfg # - DB4629-5044	AMP7700-DB4	\$ 1150.00	\$ 450.00
7710	Reman Injection Pump Bosch, Mfg # - 0 402 796 828 PES6P 7458	AMP7710-PES	\$ 1850.00	\$ 450.00
7720	Reman Injection Pump Bosch, Mfg # - PES6A95D410RS22561	AMP7720-PES	\$ 1425.00	\$ 200.00
7800	Reman Injection Pump Bosch, Mfg # - PES6A100D410RS2762-1 Replaces RE62035, SE500440	AMP7800-PES	\$ 1395.00	\$ 550.00
8100, 8200, 8300, 8300T, 8400, 8400T, Combines: 9510, 9610	Reman Injector Pump PES6P120A720RS7356 w/ Bosch # 0402796813 & Pigtail	AMP8100-PES-2	\$ 2900.00	\$ 400.00
8100, 8200, 8300, Combines: 9500, 9600	Reman Injection Pumps PES6P120A720RS3184 w/ Bosch # 0402196703 or 705 & Pigtail	AMP8100-PES-1	\$ 2900.00	\$ 400.00
8430 Early	Reman Injection Pump Bosch (Mech), Mfg # - PES6P110A720RS305	AMP8430E-PES	\$ 1750.00	\$ 300.00
8430 Late	Reman Injection Pump Bosch (Hyd), Mfg # - PES6P110A720RS305	AMP8430L-PES	\$ 1750.00	\$ 300.00
8440	Reman Injection Pump Bosch, Mfg # - PES6P110A720RS361	AMP8440-PES	\$ 1875.00	\$ 300.00
8450, Chopper: 5720	Reman Injection Pump Bosch, Mfg # - PES6P110A720RS3083 Pump # - 9400 231 175, 176, 082	AMP8450-PES	\$ 1875.00	\$ 300.00
8630 Early	Reman Injection Pump Bosch (Mech), Mfg # - PES6P110A720RS296	AMP8630E-PES	\$ 1750.00	\$ 300.00
8630 Late	Reman Injection Pump Bosch (Hyd), Mfg # - PES6P110A720RS296	AMP8630L-PES	\$ 1750.00	\$ 300.00
8640	Reman Injection Pump Bosch, Mfg # - PES6P110A720RS370	AMP8640-PES	\$ 1750.00	\$ 300.00
8650	Reman Injection Pump Bosch, Mfg # - PES6P110A720RS3144 Pump # - 9400 231 204	AMP8650-PES	\$ 1875.00	\$ 300.00
	Reman Injection Pump Nippondenso, Mfg # - 190000-5890/0030 Replaces AR86835, AR99856, AR99857, AR99858, RE13055, RE19740, RE19805, RE23749, RE23756, RE23931, RE29159, SE500117, SE500450	AMP8650-NIP	\$ 1875.00	\$ 300.00

John Deere®—Tractor

Application	Description	Part Number	Retail Price	Core
8820	Reman Injection Pump Bosch, Mfg # - PES6P110A720RS361	AMP8820-PES	\$ 1750.00	\$ 200.00
9400	Reman Injection Pump Roosa Master, Mfg # - DM4-4719	AMP9400-DM4	\$ 1250.00	\$ 400.00
	Reman Injection Pump 6359 Engine BSN 337245 use Mfg # - DM4627-4719 6068 Engine SN 337246-701245 use Mfg # - DM4629-4966 6068 Engine ASN 701246 use Mfg # - DB4629-5311	AMP9400-DB4	\$ 1100.00	\$ 400.00
Combine: 4400	Reman Injection Pump Roosa Master, Mfg # - JDB635MD3055	AMP4420-JDB	\$ 895.00	\$ 300.00
Combine: 7700	Reman Injection Pump Bosch, Mfg # - PES6A95D410RS2380	AMP7700-PES	\$ 995.00	\$ 200.00
Combines: 9500, 9600	Reman Injection Pump PES6P120A720RS3184 w/ Bosch # 0402196700 or 702 & 7-Pin Plug-in	AMP9500-PES	\$ 2900.00	\$ 400.00
Sprayer: 6000	Reman Injection Pump Roosa Master, Mfg # - JDB431MD2800	AMP6000-JDB	\$ 995.00	\$ 300.00
2150, 2255, 5400N, 5500N, 6110, 6200, 6200L, 6205, 6210, 6210L, 6215, 6300, 6300L, 6310, 6310L, 6310S, 6320, 6320L, 6400, 6400L, 6410, 6410L, 6410S, 6420, 6420L, 6500, 6500L, 6505, 6510, 6510L, 6515, 6520L, 7200, 7210, 7400, 7405, 7410, 7500, 7505, 7510, 7610, 7710, 7810, Sprayer: 4700, Swather: 4890	Fuel Stop Solenoid	AMRE54064	\$ 12.50	
4000 w/ Engine ASN 280001, 4020 ASN 201000, 4520 w/ Engine SN 245535-303518, Ind: 600 w/ Engine ASN 215000	Injection Line, 1 Cylinder For Engines w/ Roosa Master Injection Pumps and Pencil Injectors	AMAR51194	\$ 26.84	
	Injection Line, 2 Cylinder For Engines w/ Roosa Master Injection Pumps and Pencil Injectors	AMAR51195	\$ 27.96	
	Injection Line, 3 Cylinder For Engines w/ Roosa Master Injection Pumps and Pencil Injectors	AMAR51196	\$ 31.31	
	Injection Line, 4 Cylinder For Engines w/ Roosa Master Injection Pumps and Pencil Injectors	AMAR51197	\$ 30.20	
	Injection Line, 5 Cylinder For Engines w/ Roosa Master Injection Pumps and Pencil Injectors	AMAR51198	\$ 30.20	
	Injection Line, 6 Cylinder For Engines w/ Roosa Master Injection Pumps and Pencil Injectors	AMAR51199	\$ 30.20	
4000, 4020, Ind: 600 Engine ASN 215000	Injection Line, Fuel Filter to Injection Pump	AMAR31553	\$ 33.79	
4430 w/ Engine ASN 445569, 4440, 4630 w/ Engine ASN 445947, 4640, Combines: 6600, 6620, 7700 w/ Engine ASN 445569, 7720, 8820 w/ 6466AH01 Engine, Forage Harvesters: (5200, 5400 - w/ Engine ASN 445947), 5440	Injection Line, 1 Cylinder Replaces AR69446	AMAR96857	\$ 41.85	
	Injection Line, 2 Cylinder Replaces AR69447	AMAR96858	\$ 41.85	
	Injection Line, 3 Cylinder Replaces AR96448	AMAR96859	\$ 47.97	
	Injection Line, 4 Cylinder Replaces AR69449	AMAR96860	\$ 41.85	
	Injection Line, 5 Cylinder Replaces AR69450	AMAR96861	\$ 41.85	
	Injection Line, 6 Cylinder Replaces AR69451	AMAR96862	\$ 41.85	

John Deere®—Tractor

Application	Description	Part Number	Retail Price	Core
4000 Engine ASN 280001, 4020 Engine ASN 091000, 4520 Engine SN 245535-303518, Ind: 600 Engine SN 091000-214999	Return Fuel Line	AMAR34807	\$ 39.47	
3010, 4010 Diesel	Fuel Shutoff Cable 27" Long	AMAR26785	\$ 48.84	
3150, 3155 w/ Stanadyne® Pump	Fuel Shutoff Cable 82" Long	AMAL41325	\$ 31.16	
4040, 4050, 4055, 4240, 4250, 4255, 4430 Engine ASN 445570, 4440, 4450, 4455, 4555, 4630 Engine ASN 445948, 4640, 4650, 4755, 4850, 4955	Fuel Shutoff Cable 54" Long	AMAR77678	\$ 65.30	
4050 w/ 6359TR Diesel Engine	Fuel Shutoff Cable 74" Long	AMRE27897	\$ 36.19	
4230 w/ Engine BSN 013000	Fuel Shutoff Cable 66" Long	AMAR61973	\$ 59.50	
4030, 4050 ASN 006510	Throttle Cable 86" Long	AMAR93684	\$ 100.60	
(4040, 4240 4440 - w/ Cab), 4050, 4055, 4230, 4250, 4255, 4430, 4450, 4455, 4555, 4560, 4630, 4640, 4650, 4755, 4760, 4840, 4850, 4955, 8430, 8440, 8450, 8630, 8640, 8650	Throttle Cable 25 1/2" Long	AMAR56685	\$ 42.51	

Injectors

Our remanufactured injectors are disassembled and thoroughly cleaned. The internal components are lapped to ensure there is no leakage. All tips are inspected for hole erosion and opening pressure; and the spray pattern is tested using OEM specifications.



Application	Description	Part Number	Retail Price	Core
(1640, 2040, 2040S, 3040, 3140 ASN 430000), 2020, 2030, 2150, 2350, 2440 ASN 341000, 2520, 2555, 2940, 2955, 3055, 3150, 3155, 3255, 4030, Ind: 300, 300B, 301, 301A, 302, 302A, 401B, 401C, 401D, Utility: 830, 2155, 2240 ASN 350000, Combines: 4400, 6600, Cotton Pickers: 9900, 9910, 9920, Cotton Stripper: 484, Sprayer: 6000, Swathers: 2250, 2270, 2280, 2320, 2360, 2420, 3430, 3830	Injector 3-152, 3-164, 3-179, 4-202, 4-219, 4-239, 6-303, 6-329, 3029, 4039 Turbo & Non-Turbo Engines Pencil # - 17427, 17511, 18457, 18717, 18742, 19762, 20500, 20631, 22042, 22202, 22203, 27333, 27334, 28481	AMAR89564	\$ 45.00	
2140, 2355N, 2555, 2630, 2750, 2755 (GPT), 2855N, 3255, 3830, 4050, Combines: 4435 Hydro, 9400, Cotton Pickers: 9920, 9930	Injector	AMRE37503	\$ 45.00	
2955, 3155, 3155TSS, 3255, 5500, 5700, 6100, 6200, 6210, 6300, 6310, 6500	Injector 4039T and 6059D Engines	AMRE36935	\$ 45.00	
3010, 4010, 4020 Early	Reman Injector Bendix, Holder # - HB-100 Valve # - 10-278777	NHB-100BEN	\$ 105.00	\$ 75.00
	Reman Injector Holder # - AKL-102 Valve # - VA7811A	NHB-100	\$ 105.00	\$ 75.00
3020 Early, 4000, 4020, 4230, 4520, Combines: 6600, 7700	Injector Pencil # - 17705	AMAR50781	\$ 33.00	
4040, 4230 Early	Injector	AMAR79686	\$ 50.00	
	Reman Injector Holder # - KDEL 65S 1/13 Valve # - DLLA155S729	NKDEL-155S729	\$ 45.00	\$ 35.00
4040, 4230, 4240, Combines: 6600, 6620, 7700	Injector Replaces SE500106	AMAR85541	\$ 55.00	

John Deere®—Tractor

Application	Description	Part Number	Retail Price	Core
4050, 4250, 4430 ASN 445570, 4440	Injector Holder # - KDEL 65S 1/13 Valve # - DLLA155S713 Replaces SE500103	AMAR74665	\$ 60.00	
4050 w/ 466D Engine, 4250 Early, 4430 Late, 4440, 4450	Reman Injector Holder # - KDEL 65S 1/13 Valve # - DLLA155S713	NKDEL-155S713	\$ 45.00	\$ 35.00
4230 Late, 4240	Reman Injector Holder # - KDEL 65S 1/13 Valve # - DLLA158S766	NKDEL-158S766	\$ 45.00	\$ 35.00
4250 Late	Reman Injector Holder # - KDEL 65S 1/13 Valve # - DLLA158S920	NKDEL-158S920	\$ 45.00	\$ 35.00
4320, 4430 Early, 4520, 4620	Reman Injector Holder # - KDL 65S 27/4 Valve # - DLLA155S574 Replaces AR53091	NKDL-155S574	\$ 45.00	\$ 35.00
4450, 4630, 4640, 4650, Combines: 6620, 8820 BSN 227599, Forage Harvester: 5200 ASN 445948	Injector Replaces R85335, RE25185	AMAR74664	\$ 80.00	
4520	Injector Replaces SE501166	AMAR52014	\$ 61.67	
4555, 4560, 4755, 4760, 4955, 4960, 7800 BSN 517601, 8100 BSN 100000, 8200, 8560 BSN 142256, Combines: (9500, 9550SH BSN 142256), 9600 - w/ TH001 or HH003 Engine, Cotton Pickers: 9960 Engine BSN 129468, 9965, 9970	Reman Injector Replaces RE30159, SE501135	AMRE52109	\$ 80.00	\$ 35.00
4555, 4755, 4960, 7800, 8100, 8200, 8560, (9500, 9600 - w/ Engine BSN 142255), 9960 Engine BSN 129467, 9965, 9970	Reman Injector, Denso	NKDAL-LLA158P46	\$ 55.00	\$ 35.00
4630 Early	Reman Injector Holder # - KDL 65S 27/4 Valve # - DLLA155S593	NKDL-155S593	\$ 45.00	\$ 35.00
4840 Late, 4850, 8640 Late, 8650	Reman Injector w/ New Tip Holder # - KDEL 65S 1/13 Valve # - DLLA155S681	NKDEL-155S681RC	\$ 85.00	\$ 35.00
4840 Late	Injector	AMAR73847	\$ 50.00	
4840 Late, 4850, 8650	Reman Injector Holder # - KDEL 65S 1/13 Valve # - DLLA155S681	NKDEL-155S681	\$ 45.00	\$ 35.00
4840 Early, 8440, 8450, 8640 Early, 8850	Injector Reman Injector Holder # - KDEL 65S 1/13 Valve # - DLLA155S695	AMAR73100 NKDEL-155S695	\$ 50.00 \$ 65.00	 \$ 35.00
(5020, 6030 - w/ 6.531D 6 Cylinder Engine), Ind: 700A w/ 6.531D 6 Cylinder Engine	Injector Replaces SE501164	AMAR50782	\$ 61.67	
5045D, 5045E, 5055D, 5055E, 5065E, 5075E, 5103, 5203, 5303, 5403, 5503, Ind: 210LE	Injector Replaces SE501177	AMRE515684	\$ 64.03	
5103, 5105, 5203, 5205, 5210, 5220, 5303, 5310, 5310N, 5320, 5403, 5410, 5510	Injector Replaces SE501173	AMRE50833	\$ 75.28	
5210, 5310, 5410, 5510	Injector	AMRE531437	\$ 64.85	

John Deere®—Tractor

Application	Description	Part Number	Retail Price	Core
5310, 5310N, 5320, 5320N, 5425, 5425N, 5510, 5510N, 5520, 5520N, 5525, 5525N, 5625, 5705, 5715, 5715HC, 5725N, 6110, 6110L, 6120, 6120L, 6210, 6210L, 6215, 6220, 6220L, 6310, 6310L, 6310S, 6320, 6320L, 6403, 6405, 6410, 6410L, 6410S, 6415, 6420, 6420L, 6420S, 6510, 6510L, 6510S, 6520L, 6603, 6605, 6615, 6715, 7210, 7220, 7320, 7405, 7410, 7420, 7500, 7505, 7510, 7515, 7520, 7600, 7610, 7815	Injector Marked 29229 Turbo Engines	AMRE48786	\$ 60.00	
5400, 5400N, 5500 Engine ASN 308582, 6200, 6200L, 6300, 6300L, 6400, 6400L, 6500, 6500L, 7200, 7400, Cotton Picker: 9930 ASN 6000 w/ 6059TN002 Engine ASN 299999, Cotton Strippers: 7445 ASN 8000 w/ 6059TN002 Engine ASN 299999, 7450, 7455, Forage Harvesters: 7200, 7400, 7500, Sprayers: 6100, 6500, 6600	Injector Replaces RE38087, Stanadyne® 28484	AMRE36939	\$ 37.55	
5403, 5410, 5415N, 5420, 5420N, 5605, 5615, Ind: 210LE	Injector Marked 32262 Non-Turbo Engines	AMRE60062	\$ 35.00	
6030, 7520	Reman Injector Holder # - KDL 65S 27/4 Valve # - DLLA155S568	NKDL-155S568	\$ 45.00	\$ 35.00
6120, 6120L, 6215, 6220, 6220L, 6320, 6320L, 6415, 6420, 6420L, 6520L, 6615, 6715, 7220, 7320, 7405, 7420, 7520, 7610, 7710, 7810	Pencil Injector Note: Please verify Engine and Serial Number information before ordering Replaces RE507766	AMRE531436	\$ 74.61	
6200, 6200L, 6300, 6300L, 6400L, 6500, 6500L, 7200, 7400, OEM Engines: 4039, 4045, 6059, 6068	Pencil Injector	AMRE38087	\$ 33.00	
8110, 8200 ASN 009999, 8200T, 8210, 8400, 8400T, 8410, 9100	Injector Replaces RE62615	AMRE61593	\$ 94.05	
8430, 8630 - Early	Reman Injector Holder # - KDL 65S 27/4 Valve # - DLLA155S723	NKDL-155S723	\$ 45.00	\$ 35.00
8430, 8630 - w/ Midrange SN 466	Reman Injector Holder # - KDEL 89S 6/13 Valve # - DLLA150S767	NKDEL-150S767	\$ 45.00	\$ 35.00
9100, 9120, 9200, 9220, 9300, 9300T, 9320, 9320T, 9400, 9400T, 9420, 9420T, 9520, 9520T, 9620, 9620T - w/ Engine SN 30000-34167, Combines: 9750STS, 9860STS - w/ Engine SN 30000-34167, Forage Harvesters: 7200, 7300, 7400, 7500 - w/ Engine SN 30000-34167	Reman Injector, Low Power Replaces RE505430, RG33966, SE54956	AMRG30742	\$ 450.00	\$ 200.00
9100, 9120, 9200, 9220, 9300, 9300T, 9320, 9320T, 9400, 9400T, 9420, 9420T, 9520, 9520T, 9620, 9620T - w/ Engine ASN 34168, Combine: 9880STS w/ Engine ASN 34168, Forage Harvesters: 7200, 7300, 7400, 7500 - w/ Engine ASN 34168	Reman Injector, Mid Power Replaces RE505207, RE508490, RE517659, RE517662, RE566225, RG33967, SE501957	AMRG31717	\$ 450.00	\$ 200.00

John Deere®—Tractor

Application	Description	Part Number	Retail Price	Core
9330, (9410R, 9460R, 9460RT, 9510R, 9510RT, 9560R, 9560RT - w/ 6135RW201 Engine), (9420R, 9470R, 9470RT, 9520R, 9520RX, 9570R, 9570RT, 9570RX - w/ 6135RW203 or 303 Engine), 9420RX w/ 6135RW203 Engine, 9430, 9430T, 9530, 9530T, 9630, 9630T, Combines: (S680, S680HM, S690, S690HM, S780 ASN H0S780XXX805001 & ASN 1Z0S780XXX100001, S790 ASN 1H0S790XXX805001 & ASN 1Z0S790XXX100001 - w/ 6135HH004 Engine), S780 ASN 1H0S780XXX800001 w/ 6135HH004 or 009 Engine, S790 ASN 1H0S790XXX800001 w/ 6135HH004 or 010 Engine, Cotton Pickers: 7760 BSN N07760X039001 or ASN N07760X039000 w/ 6135HN004HN001 or 003 Engine, CP690 w/ 6135HN004 or 006 Engine, Forage Harvesters: (7350, 7450, 7480, 7550, 7580, 7750, 8300, 8400, 8500 - w/ 6135HZ012 or 017 Engine), (7380, 7580, 7780 - w/ 6135HZ006, 007 or 009 Engine)	Reman Injector Marked RE533501 or RE522250 Replaces SE501959	AMRE533608	\$ 795.00	\$ 250.00
Utility: 790, 990, 4300, 4310, 4400, 4410, 4500, 4510, 4600, 4610, 4700, 4710	Injector	AMAT110293	\$ 92.00	
1020, 2020, 2510, 3020, 4020, 4230, 4430, 4520, 4630, 5020, 6030, 7520, 8630, Combines: 6600, 7700, Forage Harvesters: (5200, 5400 ASN 282943), 5460 BSN 027970	Fuel Line Boot Clamp	AMR34766	\$ 0.92	
1020, 1030, 1040, 1120, 1130, 1140, 1520, 1530, 1550, 1630, 1640, 1750, 1830, 1840, 1850, 1850N, 2020, 2030, 2040, 2040S, 2120, 2130, 2140, 2150, 2155, 2255, 2350, 2355, 2440, 2510, 2520, 2550, 2555, 2630, 2640, 2650, 2650N, 2750, 2755, 2840, 2850, 2855N, 2940, 2950, 2955, 3020, 3030, 3040, 3055, 3120, 3130, 3140, 3150, 3155, 3255, 4000, 4020, 4030, 4040, 4050, 4230, 4320, 4520, 4620, 5020, 5105, 5200, 5205, 5210, 5220, 5300, 5300N, 5310, 5310N, 6030, 7020, Ind: 300, 300B, 301, 301A, 302, 400, 401, 401B, 500, 510, 600, 700A, Utility: 820, 830, 2240, Combines: 55, 95, 95H, 105, 3300, 4400, 4420, 4425, 4435, 4435 Hydro, 6600, 6602, 7700, 9400, Cotton Pickers: 499, 699, 9900, 9910, 9920, 9930, Cotton Strippers: 482, 484, 7440, 7445, Forage Harvester: 5200, Sprayers: 700, 734, 600, 6000, Sawthers: 880, 2270, 2280, 2360, 2420, 3430, 3830	Pencil Injector Washer For Lower Injector 0.381" ID, 0.562" OD, 0.120" Thick Replaces 64355A, 499210, A41403	AMR60746	\$ 0.58	
5082E, 5090E, 5090EH, 5090EL, 5090EN, 5103, 5105, 5203, 5205, 5210, 5220, 5303, 5310, 5310N, 5320, 5320N, 5400, 5400N, 5403, 5415, 5420N, 5425N, 5500 ASN 308583, 5510, 5510N, 5520, 5615, 5625, 5715, 5725N, 6110, 6110L, 6120, 6120L, 6200, 6200L, 6210, 6210L, 6215, 6220, 6220L, 6300, 6300L, 6310, 6310L, 6310S, 6320, 6320L, 6400, 6400L, 6405, 6410, 6410L, 6410S, 6420, 6420L, 6500, 6500L, 6510L, 6510S, 6520L, 6605, 6715, 7220, 7320, 7420, 7505, 7520	Injector O-Ring Kit Replaces R48000, R79605, R92352	AMRE64292	\$ 5.45	

John Deere®—Tractor

Application	Description	Part Number	Retail Price	Core
5045D, 5045E, 5055D, 5055E, 5065E, 5075E, 5082E, 5090E, 5090EH, 5090EL, 5090EN, 5101E, 5101EN, 5200, 5203, 5210, 5220, 5300, 5303, 5310, 5320, 5320N, 5400, 5400N, 5403, 5410, 5415, 5415H, 5415N, 5420, 5420N, 5425N, 5500N, 5510, 5510N, 5520, 5520N, 5603, 5615, 5625, 5715, 5715HC, 5725N, 6110, 6110L, 6120, 6120L, 6140J, 6155J, 6200, 6200L, 6210, 6210L, 6215, 6220, 6220L, 6300, 6300L, 6310, 6310L, 6310S, 6320, 6320L, 6400, 6400L, 6405, 6410, 6410L, 6410S, 6415, 6420, 6420L, 6500, 6500L, 6510L, 6510S, 6520, 6520L, 6605, 6715, 7200, 7220, 7320, 7400, 7500, 7505, Combine: 9400, Cotton Picker: 9935, Cotton Strippers: 7450, 7455, 7460, Sprayers: 4710, 6700, Swather: 4990	Injector T Fitting	AMR71963	\$ 7.14	
2510, 4040, 4230, 4240, 4430, 4440, 4630, 4640, 4840, 8430, 8630, Combines: 6600, 6620, 7700, 7720, Forage Harvesters: 5200, 5400, 5440, 5460	Injection Line T Boot Sold Individually	AMT23425	\$ 9.75	
2030, 2140, 2150, 2250, 2350, 2355, 2355N, 2440 ASN 508310, 2550, 2555, 2750, 2755, 2855N, 2950, 2955 BSN 767517, 3030, 3040, 3055, 3130, 3140, 3150, 3155, 3255, 4030, 4040, 4050, 4055, 4240, 4250, 4440, 4450, 4455, 4555 BSN 165527, 4560, 4640, 4650, 4755, 4760, 4840, 4850, 4960, 6403, 6603, 7210, 7220, 7320, 7405, 7410, 7420, 7500, 7510, 7520, 7610 Early, 7700, (7710, 7810, 8100T, 8200T, 8300T, 9100 BSN 087550), 7800, 8100, 8200, 8300, 8400 BSN 087560, 8440, 8450, 8560, 8760, 8770, 8970, Combines: 4400, 4420, (6620, 7720 Engine ASN 256207), 8820 Engine ASN 286641, 9400, 9410, 9450, 9500, 9500SH, 9510, 9510SH, (9600, CTS Engine ASN 499999), 9610, CTS II, Cotton Pickers: 9930, 9940, 9950, 9960, 9965, 9970, 9976, Cotton Stripper: 7445, Sprayers: 4700, 6100, 6500, 6600, Utility: 2155	Injector T Fitting	AMR79606	\$ 7.91	
4040, 4230, 4240, 4250, 4320, 4430, 4440, 4450, 4520, 4620, 4630, 4640, 4650, 4840, 4850, 6030, 7020, 7520, 8430, 8440, 8450, 8640, 8650, 8630, 8760, 8770 Engine BSN 500229, Combines: 6600, 6620, 7700, 7720, 8820, Cotton Pickers: 9940, 9950, Forage Harvesters: 5200, 5400, 5440, 5460, 5720, 5730, 5820, 5830	Injector Washer 0.365" ID, 0.715" OD, 0.079" Thick Sold in Multiples of 6, Priced Individually Replaces R59104	AMR64840	\$ 0.92	



Turbochargers and Components

Application	Description	Part Number	Retail Price	Core
Engines: 6059T, 6068T, 6359T, 6414T	Turbocharger Replaces 465593-9001, 466980-9001, RE65096	AMRE25625	\$ 425.00	
1830, 2130, 2140 Engine ASN 0687811, (2555, 2750 Engine ASN 0687811, 2755, 2855 - w/ 239 Engine), 2850, 2855N, 3255, Combine: 4435 Hydro	Turbocharger Replaces RE32203, RE32204, RE71498	AM466334-5004	\$ 585.00	
4020	Turbocharger T04B8069, AiResearch	AM600591-9004	\$ 795.00	\$ 200.00

John Deere®—Tractor

Application	Description	Part Number	Retail Price	Core
4050E, 4250, 4440, 4450, (4640, 4840 Engine BSN 282880), 4650, 4850 Engine BSN 310102, 7820, 7920, 8430, 8440 Engine SN 0027605-282880, 8450, Combines: 6620, 6622, 7720, 8820, Forage Harvesters: 5720	Turbocharger T04B23, TB4129, AiResearch Replaces RE19785, RE24594, RE519925	AM466608	\$ 345.00	
4020	Reman Turbocharger Rayjay Replacement	AM600588-8069	\$ 945.00	\$ 100.00
4055, 4255, 4455, 4555, 4560, 4755, 4760, 4955, 4960, 9960, Combines: 9500, 9600, CTS	Turbocharger Replaces RE38345, RE38346, RE66554	AMRE29310	\$ 475.00	
4320, 4430 Engine BSN 512306, 4520, 4620, 7020 Engine BSN 335846, 7800, Combine: 7700 Engine BSN 512305, Forage Harvesters: 5200, 5400 - w/ 404T Engine BSN 335845	Turbocharger 2 1/8" OD on Intake Side T04B15, AiResearch Replaces AR52020, AR63698, RE68138	AM409250	\$ 365.00	
4320, 4520, 4620	Turbocharger 3LD-208 Replaces AR68137, AR68141	AM157253	\$ 420.00	\$ 200.00
4430 Engine ASN 512306, 4630, 7020 Engine ASN 335846, Forage Harvesters: (5200, 5400 - w/ 404T Engine ASN 335846)	Turbocharger 2 3/16" ID on Intake Side T04B11, AiResearch Replaces AR63699, AR68140, RE19783	AM466608-5001	\$ 345.00	
5045E, 5055E, 5065E, 5075E, 5075M	Reman Turbocharger Customer rebuildable core is required and must be sent in	AMDZ109510	\$ 1275.00	\$ 350.00
5065M, 5075M	Reman Turbocharger Customer rebuildable core is required and must be sent in	AMRE538476	\$ 1200.00	\$ 350.00
5310, 5320	Turbocharger S1B Replaces RE500784	AMRE500455	\$ 945.00	
5425, 5425N, 5510, 5510N, 5520, 5520N, 5525, 5525N, 5605, 5705, 5715	Reman Turbocharger S1B	AMRE71550	\$ 760.00	\$ 300.00
5500, 5500N, 6110, 6210, 6310, 6400, 6400L, 6405, 6410, 6410S, 6500, 6500L	Reman Turbocharger Replaces RE61594, SE500287	AM454041-9001	\$ 785.00	\$ 150.00
6030, 7520, Forage Harvester: 5400 - All w/ 531T Engine	Reman Turbocharger 3LM299, Schwitzer Replaces AR58298, AR81387	AM180729R	\$ 895.00	\$ 250.00
(6059, 6068 BSN 699999)	Turbocharger Replaces 466201-9001, RE44801, RE44802	AMRE64742	\$ 550.00	
6100D, 6110D, 6110E, 6115D, 6115E, 6125D, 6125E, 6130D, 6130E, 6140D, 6330, 6425, 6430, Premium Model: 6330	Turbocharger Replaces RE528771	AMRE548726	\$ 765.00	
6110, 6120, 6205, 6210, 6215, 6220, 6310, 6320, 6405, 6410, 6410L, 6410S, 6415, 6420, 6510, 6520, SE6110, SE6120, SE6210, SE6220, SE6320, SE6410, SE6420	Turbocharger Replaces 462268-0001	AMRE506261	\$ 485.00	
6605, 7210, (7220, 7320 - w/ 6068 Engine), (7410, 7510 - w/ Engine BSN 867431), 7610, Combine: 9410, Sprayer: 4700 Engine SN 704808-804312	Reman Turbocharger Replaces SE502167	AMRE60077	\$ 610.00	\$ 300.00
7130, 7230, 7330, 7430, 7530	Reman Turbocharger S300 BV, Borg-Warner®: 478737 Replaces RE535680, RE535689, SE502330	AMDZ108144	\$ 1650.00	\$ 350.00
7290R, 7310R, 8245R, 8270R, 8295R, 8320RT, 8345RT, 8370RT	Turbocharger Replaces 466619-9001	AMRE56386	\$ 575.00	
(7700, 7800 - w/ 6076TRW30 or 31 Engine), Combine: 9400 w/ 6068HH01 Engine ASN 337245	Turbocharger Marked RE42682 or RE47828 Replaces 466007-0002, 466007-9001	AMRE42740	\$ 444.00	

John Deere®—Tractor

Application	Description	Part Number	Retail Price	Core
7830, 7930, Sprayers: 4730, 4830	Reman Turbocharger S300 BV, Borg-Warner®: 478751 Replaces RE534530, RE534565, SE502340	AMDZ108142	\$ 1750.00	\$ 350.00
8100, 8100T, 8110, 8110T, 8200, 8200T, 8210, 8210T, 8300, 8300T, 8310, 8310T, 8400, 8400T, 8410, 8410T	Turbocharger Schwitzer®/Borg-Warner®: 167288, 167484, 167734, 168678, 168683, 168685, 170263, 173382, 173383 Replaces RE64936, SE500279, SE500429	AMRE54979	\$ 650.00	
8130, 8225R, 8230, 8230T, 8235R, 8245R, 8260R, 8270R, 8285R, 8295R, 8295RT, 8310R, 8310RT, 8320R, 8320RT, 8330, 8330T, 8335R, 8335RT, 8345R, 8345RT, 8360R, 8360RT, 8430, 8430T, 8530, Combines: 9670STS, 9770STS, S650, S660, S670, S670HM, Cotton Picker: 7660, Forage Harvesters: 7180, 7250, 8100, 8200, Sprayers: 4930, 4940, R4038	Turbocharger Replaces DZ107131, RE531469, SE502374	AMRE531288	\$ 781.50	
8560	Reman Turbocharger HT3B	AMRE36037	\$ 700.00	\$ 200.00
8630 Engine ASN 048543, 8640, 8650 w/ 619T Engine, Forage Harvesters: 5820, 5830	Turbocharger TV6102, AiResearch Replaces AR101536, RE11952, RE22640	AM465320	\$ 885.00	
8760	Reman Turbocharger Replaces RE38182, RE51682	AMRE48018	\$ 1385.00	\$ 300.00
8770, 8870, 9100	Reman Turbocharger S3A Replaces RE66731, RE502515, SE500414	AMRE53399	\$ 935.00	\$ 300.00
8850	Reman Turbocharger TV71	AMAR104052	\$ 1250.00	\$ 300.00
9100	Reman Turbocharger S300	AMRE502515	\$ 910.00	\$ 300.00
Combines: (9500, 9600, CTS Engine BSN 565536)	Turbocharger Replaces RE36285	AM465637-9001	\$ 685.00	
Combines: 9510, 9510SH, 9550, 9610, 9650	Reman Turbocharger S300	AMRE66351	\$ 760.00	\$ 300.00
Combines: 9650STS, 9750STS	Reman Turbocharger Schwitzer®/Borg-Warner®: 169647, 170028, 173312, 173601	AMX36268	\$ 775.00	\$ 100.00
Combines: 9660STS, 9670STS, 9760STS, 9770STS, S660 ASN 765172, S670 ASN 785001 - w/ 6090 9.0 Liter Tier 3 PowerTech™ Engine, Cotton Picker: 7660 w/ 6090 9.0 Liter Tier 3 PowerTech™ Engine	Turbocharger Replaces RE523007, RE534562, RE534642, RE536613, SE502421	AMDZ108118	\$ 3100.00	
Combine: 9870STS, Cotton Picker: 7760 - All w/ 6135HH001 Engine	Reman Turbocharger 13.5 Liter Replaces RE535842	AMSE502335	\$ 2025.00	\$ 300.00
Cotton Picker: 9930, Cotton Stripper: 7445	Turbocharger Replaces RE26291	AMRE62773	\$ 600.00	
Utility: 4120, 4320, 5045D, 5045E, 5055D, 5055E, 5065E, 5075E, 5103, 5203, 5225, 5303, 5325, 5325N, 5403	Turbocharger Replaces SE501678	AMRE518228	\$ 475.00	
Utility: 3036E, 3038E, 3038R, 3520, Mowers: 7400, 7400A, 7500, 7500A, 7500E, 7700, 7700A, 8000, 8000A, 8000E, 8400, 8500, 8500E	Turbocharger	AMM811665	\$ 525.00	
Utility: 4520, 4720, 5103, 5203, 5210, 5310, 5410, 5510, 5320N, 5420N, 5520N	Reman Turbocharger	AMRE70036	\$ 525.00	\$ 145.00
Utility: 4120, 4320	Turbocharger	AMRE532400	\$ 865.00	
Utility: 4520, 4720	Turbocharger	AMRE533601	\$ 865.00	

Prices Subject to Change without Prior Notice. The use of original equipment manufacturer (OEM) part numbers or trademarks, e.g. Case® and John Deere®, are for reference purposes only and for indicating product use and compatibility. Our company and the listed replacement parts contained herein are not sponsored, approved or manufactured by the OEM. All parts are New unless designated Reman in the description.

John Deere®—Tractor

Application	Description	Part Number	Retail Price	Core
Sprayer: 6700, Swather: 4890	Turbocharger Replaces RE60099, RE505047, RE508876	AM471049-9001	\$ 575.00	
Cotton Picker: 9930, Cotton Stripper: 7445	Reman Turbocharger Replaces RE32204	AMRE26291	\$ 525.00	\$ 200.00
4050, 4250, 4320, 4430, 4440, 4450, 4520, 4620, 4630, 4650, 4840, 4850, 7020, 8430, 8440, Combines: 6600, 6602, 6620, 6622, 7700, 7720, 8820, Cotton Pickers: 9940, 9950, Swather: 3830, Forage Harvesters: 5200, 5440, 5720, 5730, 7400 - All w/ 239T, 276T, 359, 414T, 466T, 6059 or 6068 Engine	Exhaust Sleeve	AMR43724	\$ 45.00	
(4250, 4440 ASN 299711), 4430, 4450, Combines: 6620, 7720	Turbocharger Coupling Use w/ R50406 O-Ring Replaces R63129	AMR81928	\$ 16.92	
6100B, 6100D, 6110B, 6110D, 6115D, 6125D, 6130D, 6140D, 6320, 6403, 6420, 6603, 6630, 6930, 7220, 7230, 7320, 7330, 7420, 7520, 7630, 7715, 7730, 7815, 7830, 7930, Premium Models: 7330, 7430, 7530, Ind: 210LJ, Combines: 1165, 1170, 1175, 1175H, 1550, 9560, 9560SH, S540, S690, Cotton Picker: 9970, Cotton Stripper: 7460, Sprayers: 4700, 4720, 4730, 4830, Swather: 4990	Turbocharger Drain Hose	AMR120013	\$ 33.92	
6100D, 6110B, 6110D, 6115D, 6125D, 6130D, 6140D, 6320, 6403, 6420, 6603, Ind: 210LE, Combines: 1170, 9410, 9450, Cotton Picker: 9935, Cotton Stripper: 7455, Swathers: 4890, 4895, 4990	Turbocharger Oil Inlet Hose	AMRE501260	\$ 43.00	



Manifolds and Components

Application	Description	Part Number	Retail Price	Core
40, 420, M, MT	Intake and Exhaust Manifold	AMM3956T	\$ 110.00	
	Manifold Gasket Replaces M39094T	AMX36258	\$ 18.00	
50	Intake and Exhaust Manifold	AMB3211-K	\$ 285.00	
	Manifold Gasket Set	AMX36259	\$ 31.00	
520, 530	Intake and Exhaust Manifold	AMB3641-K	\$ 275.00	
	Manifold Gasket Set	AMX36259	\$ 31.00	
50, 520, 530	Heat Exchanger	AMB3213R	\$ 13.00	
60, 620, 630 - Gas	Intake and Exhaust Manifold	AMA5751-K	\$ 235.00	
	Manifold Gasket Set	AMX36260	\$ 29.00	
60, 70, 620, 630, 720, 730	Heat Exchanger	AMA4644R	\$ 25.00	
70 Gas	Intake and Exhaust Manifold	AMF1421-K	\$ 284.00	
	Manifold Gasket Set	AMX36261	\$ 30.00	
720, 730	Intake and Exhaust Manifold	AMF3034-K	\$ 253.00	
	Manifold Gasket Set	AMX36261	\$ 30.00	
920, 930, 940, 1020, 1030, 1040, 1120, 1130, 1140, 1520, 1530, 1630, 2040, Ind: 300B, Utility: 820, 830, 2240 - All w/ 3 Cylinder Diesel Engine and Vertical Exhaust	Exhaust Manifold	AMT20252	\$ 110.00	
920, 930, 940, 1020, 1030, 1040, 1120, 1130, 1140, 1520, 1530, 1630, 2040, Ind: 300B, Utility: 820, 830, 2240 - All w/ 3-Cylinder Diesel Engine	Manifold Gasket Set, Set of 3 Replaces R90658	AMX36262	\$ 1.26	
1010 Gas	Intake and Exhaust Manifold	AMT19981	\$ 390.00	

John Deere®—Tractor

Application	Description	Part Number	Retail Price	Core
1020, 1520, Ind: 300, 301, 301A, 302, 302A - All w/ Gas Engine	Intake and Exhaust Manifold	AMT20251	\$ 300.00	
2010 Gas or LPG ASN 42001	Intake and Exhaust Manifold	AMT13384	\$ 185.00	
	Manifold Gasket Replaces RE38560	AMX36263	\$ 18.50	
1830, 2020, 2030, 2120, 2130, 2440, 2510, 2520, 2630, 2640, Utility: 2320, Swathers: 2280 Hydro, 2420, 3430, OEM Engines: (4039, 4045, 4219DF, 4239, 4239D, 4276 - Code 2803 w/o Turbo)	Exhaust Manifold	AMT20249	\$ 110.00	
	Manifold Gasket Set	AMX36264	\$ 15.00	
2020, 2030, 2510, 2520 - Gas, Vertical Exhaust	Exhaust Manifold	AMT20247	\$ 288.00	
3010, 3020 - Gas	Exhaust Manifold	AMR27404	\$ 125.00	
	Exhaust Manifold Gasket Set Replaces R83020, R83021	AMX36266	\$ 40.00	
4000, 4010, 4020, 4230 - Gas	Exhaust Manifold	AMAR28061	\$ 235.00	
	Exhaust Manifold Gasket Set Replaces R83020, R83021	AMX36266	\$ 40.00	
	Intake Manifold	AMAR28062	\$ 190.00	
	Intake Manifold Gasket	AMX36265	\$ 25.00	
4000, 4010, 4020, 4040 (w/ 6404 or 6466 Engine), (4050, 4240 w/ 6466 Engine BSN 294597) - Diesel	Exhaust Manifold	AMR26362	\$ 217.00	
4000, 4010, 4020, 4040 w/ 6404 or 6466 Engine, (4050, 4240 w/ 6466 Engine BSN 294597) - Diesel	Exhaust Manifold Gasket Set Replaces R83020, R83021	AMX36266	\$ 40.00	
4055, 4255, 4455, 4555, 4755, 4955, 8560, 8570, 9100, 9120	Exhaust Manifold - Front Section Turbo Mounting	AMR86029	\$ 205.00	
4050 w/ 6466DR Engine SN 294598- 306869, (4050 Early, 4250, 4440, 4450 - w/ 6466TR Engine), 4430, 4455, 4630, 4640, (4650, 4850, 8430, 8440, 8450 - w/ 6466AR Engine), 4840, 7020 Engine ASN 33584, OEM Engines: (6466A, 6466D, 6466T ASN 67685)	Exhaust Manifold - Front Section Replaces AR54563, R50391	AMR56995	\$ 145.00	
	Exhaust Manifold - Rear Section	AMR46472	\$ 140.00	
	Exhaust Manifold Gasket Set Replaces R83020, R83021	AMX36266	\$ 40.00	
4050 w/ 6466DR Engine SN 294598- 306869, (4050 Early, 4440, 4450 - w/ 6466TR Engine), 4250, 4430, 4455, 4630 ASN 401567, (4640, 4650, 4840, 4850 - w/ 6466AR Engine), 7020 Engine ASN 335846, OEM Engines: (6466A, 6466D, 6466T ASN 67685)	Exhaust Elbow Replaces R53514, R50392	AMR56994	\$ 105.00	
4055, 4255, 4455, 4555, 4755, 4955, OEM Engine: 6076 BSN 499999	Exhaust Elbow	AMR87733	\$ 145.00	
4320	Exhaust Manifold - Front Section	AMR46471	\$ 242.00	
	Exhaust Manifold Gasket Set Replaces R83020, R83021	AMX36266	\$ 40.00	
	Exhaust Elbow	AMR46473	\$ 98.00	
4560, 4755 ASN 165528, 4955 ASN 165528, 4960, 7710, 7810, OEM Engines: 6076 BSN 499999, 6076AF, 6466T ASN 067685	Exhaust Manifold - Front Section	AMR69936	\$ 200.00	
6030, 7520, 8630, 8640, 8650, 8760, 8770, 8870, Forage Harvesters: 5200, 5400, 5460, 5820, 5830, 6710	Exhaust Manifold	AMR120571	\$ 138.00	
(8630, 8640, 8650 Engine ASN 060160)	Exhaust Manifold - Front Section	AMR71678	\$ 185.00	

Prices Subject to Change without Prior Notice. The use of original equipment manufacturer (OEM) part numbers or trademarks, e.g. Case® and John Deere®, are for reference purposes only and for indicating product use and compatibility. Our company and the listed replacement parts contained herein are not sponsored, approved or manufactured by the OEM. All parts are New unless designated Reman in the description.

John Deere®—Tractor

Application	Description	Part Number	Retail Price	Core
4560, 4755 BSN 165527, 4760, 4955 BSN 165527, 4960, (7710, 7810 ASN 090000), OEM Engines: 6076 BSN 499999, 6076AF, 6076HF, 6076FT, 6076AFN-30	Exhaust Manifold - Rear Section Turbo Mounting	AMR109693	\$ 140.00	

Mufflers and Exhaust

Our mufflers are manufactured by experienced craftsmen here in the United States. All mufflers have welded seams. Aluminized steel is used for critical components. These features ensure that our products resist the corrosive effects of air, heat and the by-products of combustion that work to shorten muffler life. Additionally, they are painted either silver or black to cosmetically match its OEM counterpart, as well as provide further protection from the elements.

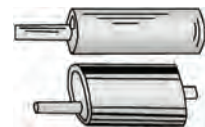

Application	Description	Part Number	Retail Price	Core
2150, 2350, 2355, 2550, 2555 Non-Turbo, 4239D Engine w/ Diesel, Utility: 2155 Non-Turbo, 3-179 Engine w/ Diesel	Muffler Conversion Kit Muffler and Pipe Kit converts under-hood muffler to above-hood muffler and vertical exhaust. Kit contains manifold-to-muffler pipe (2-bolt flanged inlet), muffler, above-hood pipe, clamps and rain cap. Painted black.	AMDR-2150K	\$ 147.50	
2840 Late, 2940, 2950, 2955, 3055, 3150, 3155 Non-Turbo - Diesel	Muffler Conversion Kit Muffler and Pipe Kit converts under-hood muffler to above-hood muffler and vertical exhaust. Kit contains manifold-to-muffler pipe (flared inlet), muffler, above-hood pipe, clamps and rain cap. Painted black.	AMDR-2950K	\$ 260.00	
Universal Tractors	Exhaust Pipe Black Finish, Straight Pipe 4" ID, Overall Length 47.50"	AM400SP	\$ 59.00	
	Exhaust Pipe Diameter 3.50", Length 48"	AMS312X48	\$ 57.00	
40, 320, 330	Muffler Vertical Round, Inlet ID 1 3/4", Length 21" Replaces AM364T	AMAM625T	\$ 31.00	
50, 520, 530	Muffler Vertical Oval, Inlet 4-Hole Base Plate, Length 22.75"	AMAR20449	\$ 56.00	
60, 70 Gas or Diesel, 620, 630 Gas, (720, 730 - Gas or Diesel)	Muffler Oval, Length 21"	AMAR20450R	\$ 47.50	
60*, 70*, 620*, 720*, (A, AN, AR, AW, AWH - 1933-52), (G, GH, GN, GW ASN 410000, 1938-53) *This is the original equipment standard muffler for these models	Muffler Vertical Round, Length 24 1/2"	AMAA2214R	\$ 32.00	
80, Utility: 820, 830	Muffler Vertical Oval, Inlet 3 3/8", Length 19"	AMAR21805R	\$ 77.00	
80 1954-56, R 1949-54, Utility: 820 1956-58 - All w/ Diesel Engine	Muffler Vertical Round, Inlet 3-Hole Base Plate, Length 20"	AMAR327R	\$ 46.00	
320, 330, 420 ASN 135025, 430, 435 ASN 442886, 1010	Muffler Vertical Round, Inlet ID 2", Length 17 1/2"	AMAT10646	\$ 29.00	
650, 750	Muffler Inlet 4-Hole Base Plate, Length 20"	AMCH15910	\$ 86.50	
920, 930, 1020, 1030, 1120, 1130, 1520, 1530, 1630, 1830, 2030, 2040, BSN 349999, 2130, 2440 BSN 340999, 2630, Utility: 820, 830, 2240 BSN 349999	Muffler Horizontal, Inlet 2.015", Length 35.50"	AMAT21795	\$ 246.31	
920, 1020, 1030, 1120, 1130, 1630, Utility: 820	Muffler Vertical Oval	AMAL27388	\$ 106.00	

John Deere®—Tractor

Application	Description	Part Number	Retail Price	Core
840, 940, 1040, 1140, 1350, 1550, 1640, 1750, 1840, 1850, 2040, 2140, 2150, 2250, 2255, 2350, 2355, 2450, 2550, 2555, 2650, 2750 ASN 488482, 2755, 2850, 2855, 2940, 2950, 2955, 3040, 3050, 3055, 3140, 3150, 3155, 3350, 3640, Utility: 2155	Exhaust Pipe Length 41.33"	AMAL34694	\$ 80.00	
840, 940, 1040, 1140, 1850, 1950, 2150, 2255, 2355N, Utility: 2155	Muffler Inlet ID 2 1/4" Replaces 1417-3807, 113488	AMAL31552	\$ 235.54	
950, Utility: 850, 1050	Muffler Inlet 4-Hole Base Plate, Length 21 1/2"	AMM802472	\$ 90.00	
1010	Muffler Horizontal Round, Inlet 2 1/8", Length 20"	AMAT16829	\$ 45.00	
1010 BSN 031000, 2010 BSN 029000	Muffler Vertical Round, Inlet ID 2 3/16", Length 26"	AMAT13310T	\$ 34.50	
1010, 2010	Muffler Vertical Round, Inlet Flared, Length 24"	AMAT16380	\$ 54.00	
1020, 1520, 1530, 2030, 2040, 2630, 2640 ASN 341000 - Gas or Diesel	Muffler Oval, Inlet Flared, Length 30"	AMAT21689	\$ 63.00	
	Rain Cap	RC-2	\$ 13.00	
1640, 1840, 2040, 2040S, 2250, 2350, 2355, 2450, 2550, 2555	Muffler	AMAL31492	\$ 146.00	
(1640, 2040, 2040S, 2140, 3040, 3140 ASN 430000), 2350, 2550, 2555, 2750, 2755, 2855N, 2940, 2950, 2955, 3150, 3155	Exhaust Pipe Length 47.25"	AMAL31863	\$ 80.00	
1830, 2020, 2030, 2120, 2130	Muffler Vertical, Inlet 2 1/2", Length 32 3/4"	AMAL27389	\$ 101.50	
2010 Gas, LPG or Diesel	Muffler Oval, Inlet 2 1/2", Length 33 1/2"	AMAT21690	\$ 53.50	
	Rain Cap	RC-2	\$ 13.00	
2140 ASN 412723, 2555, 2650, 2650N, 2750 ASN 488482, 2755, 2855	Muffler Fits Turbo Tractors w/ Vertical Exhaust	AMAL35753	\$ 165.00	
(2440, 2640 ASN 341000 - w/ Horizontal Exhaust)	Muffler	AMAR92359	\$ 207.59	
2510 Gas or Diesel	Muffler Round, Inlet Flared, Length 34"	AMAR38383R	\$ 60.00	
	Rain Cap	RC-3	\$ 14.50	
2520	Muffler Vertical Oval, Flared Inlet ID 2 1/2", Length 33 1/4"	AMAR38537	\$ 87.00	
	Rain Cap	RC-2	\$ 13.00	
2940, 2950, 2955, 3040 ASN 452123, 3055, 3140 ASN 452123, 3150, 3155, 3350, 3640	Muffler	AMAL37167	\$ 250.00	
(2940, 3040, 3140 BSN 452123)	Muffler	AMAL30338	\$ 428.00	
(3010, 3020, 4000, 4010, 4020 - Gas or LPG), 3010 Diesel BSN 1T 6643, 4010 Diesel BSN 2T 7026	Muffler Round, Inlet 2 15/16", Length 26"	AMAR26640	\$ 44.50	
	Inlet Clamp	CL-300	\$ 6.00	
(3020, 4000, 4020 - ASN 201000 w/ Gas), 4230 Gas	Muffler Oval, Straight Inlet, Inlet 2 15/16", Length 27"	AMAR41172	\$ 52.50	
	Rain Cap, 2 1/4"	RC-5	\$ 14.00	
3020 Diesel BSN 122999, 4010 Diesel ASN 2T 7027, 4020 Diesel BSN 200999	Muffler Round, Inlet Flared, Length 26"	AMAR30189	\$ 47.50	
	Clamp, Muffler - Donut Type	DR-300	\$ 14.00	
	Rain Cap	RC-7	\$ 14.50	

John Deere®—Tractor

Application	Description	Part Number	Retail Price	Core
3020 Diesel ASN 123000, (4000, 4020 Diesel ASN 201000), 4030, 4040, 4230	Muffler Oval, Inlet Flared, Length 27"	AMAR86595	\$ 61.73	
	Clamp, Muffler - Donut Type	DR-300	\$ 14.00	
	Rain Cap	RC-5	\$ 14.00	
3140 ASN 430000, 3255	Muffler, Underhood	AMAL32652	\$ 278.00	
(4050, 4640 ASN 005511), (4250, 4450 ASN 001000), 4320, 4430, 4440, 4630	Muffler Oval, Straight Inlet, Length 37" Clamp Not Included	AMAR86599	\$ 141.00	
	Inlet Clamp	DR-400A	\$ 25.00	
	Rain Cap	RC-8	\$ 16.50	
4050 BSN 005510, 4240	Muffler Oval, Straight Inlet, Replaces Flared Inlet, Length 38"	AMAR86597	\$ 103.00	
	Clamp, Band Type	DR-300A	\$ 24.00	
	Rain Cap	RC-7	\$ 14.50	
4520, 4620, 7020, Diesel Non-Tractor Applications: 641D, 641DT, 4276D, ENG-400, ENG-500	Muffler Oval, Inlet Flared, Length 34"	AMAR44418	\$ 171.00	
	Clamp, Muffler - Donut Type	DR-400	\$ 14.50	
	Rain Cap	RC-9	\$ 18.00	
4555, 4650, 4755, 4840, 4850, 4955	Muffler Oval, Straight Inlet, Length 38"	AMAR86602	\$ 168.50	
	Inlet Clamp	DR-400A	\$ 25.00	
	Rain Cap	RC-9	\$ 18.00	
4560, 4755, 4760, 4955, 4960	Muffler, Underhood	AMRE52086	\$ 458.48	
5010, 5020, 6030, Diesel non-tractor applications: ENG-400, ENG-500, 6531D	Muffler Oval, Inlet Flared, Length 37"	AMR35637	\$ 113.00	
	Clamp, Muffler - Donut Type	DR-400	\$ 14.50	
	Rain Cap	RC-8	\$ 16.50	
6100, 6110, 6110L, 6200, 6200L, 6205, 6210, 6210L, 6300, 6300L, 6310, 6310L, 6400, 6405, 6410, 6410L, 6500L, 6510L	Exhaust Pipe Replaces L78811	AMAL111094	\$ 248.34	
6110, 6110L, 6200, 6200L, 6210, 6210L, 6300, 6300L, 6310, 6310L, 6310S, 6400, 6400L, 6410, 6410L, 6500, 6500L, 6510S	Muffler Oval, Inlet 1 1/2", Length 2"	AMAL82411	\$ 246.07	
6110, 6110L, 6200, 6200L, 6210, 6210L, 6300, 6300L, 6310, 6310L, 6400, 6400L, 6410, 6410L, 6500, 6500L, 6510L	Muffler, Underhood Width 11", Height 9.50" Replaces 1417-3806, AL78267	AMAL113991	\$ 171.00	
(6110, 6210, 6210L, 6310, 6310L, 6310S, 6410, 6410L, 6410S, 6510L, 6510S ASN 244529), 6120, 6120L, 6215, 6220, 6220L, 6320, 6320L, 6415, 6420, 6420L, 6520L	Muffler, Underhood Right Hand	AMAL117294	\$ 198.50	
(6110, 6210, 6310, 6410 ASN 244528)	Exhaust Pipe	AMAL116902	\$ 188.41	
6506, 6600, 6800, 6900	Muffler Vertical Oval, Inlet Flange 4 1/8, Length 18"	AMAL117925	\$ 187.00	
6605, 7405, 7500	Muffler, Underhood Horizontal Oval, Inlet Flange 3 5/16", Length 9 3/4"	AMAL117923	\$ 113.00	
7130, 7230, 7330, Premium Models: 7130, 7230, 7330, 7430, 7530	Muffler	AMAL172375	\$ 390.00	
7220, 7320, 7420, 7520	Muffler	AMAL155806	\$ 365.00	
(7220, 7320 BSN 012450), (7420, 7520 BSN 012453)	Muffler For Models w/ Deluxe Exhaust	AMAL153972	\$ 295.00	
(7220, 7320 BSN 012450), (7420, 7520 BSN 004516)	Exhaust Pipe For Models w/ Deluxe Exhaust	AMAL151148	\$ 95.00	

John Deere®—Tractor

Application	Description	Part Number	Retail Price	Core
7600, 7610, 7700, 7710, 7800, 7810	Exhaust Pipe Replaces RE49143, RE173973, RE217832	AMRE214149	\$ 261.00	
7600 BSN 006966, 7610, 7700 BSN 008174, 7710, 7800 BSN 012411, 7810	Exhaust Pipe Replaces RE64030, RE163548	AMRE175775	\$ 450.00	
8100, 8110, 8200, 8210, 8300, 8310, 8400, 8410	Exhaust Pipe, Lower Replaces RE61175, RE64215, RE151728	AMRE161847	\$ 496.00	
8100, 8100T, 8110, 8110T, 8200, 8200T, 8210, 8210T, 8300, 8300T, 8310, 8310T, 8400, 8400T, 8410, 8410T	Muffler Vertical Oval, Inlet 5", Length 66"	AMRE44716	\$ 350.00	
	Exhaust Flex Tube	AMRE44784	\$ 235.00	
8120, 8130, 8220, 8230, 8230T, 8330, 8330T, 8430T, Sprayers: 4920, 4930	Muffler Vertical Oval, Inlet 5", Length 66" Replaces RE164819, RE195069	AMRE210829	\$ 491.50	
8430, 8630	Muffler Oval, Inlet 3 15/16", Length 38" w/ Straight 1 1/4" OD Aspirator Tube	AMAR86604	\$ 293.00	
	Rain Cap	RC-11	\$ 23.50	
	Clamp, Muffler - Donut Type	DR-400	\$ 14.50	
8440, 8640	Muffler Oval, Inlet 3 15/16", Length 38" w/ Curved 1 1/2" OD Aspirator Tube	AMAR89594	\$ 345.00	
	Rain Cap	RC-11	\$ 23.50	
	Clamp, Muffler - Donut Type	DR-400	\$ 14.50	
8450	Muffler Vertical Round, Inlet 4", Length 56"	AMAR95608	\$ 495.00	
8570, 8770, 8870	Muffler Vertical Round, Inlet 5", Length 46" Replaces RE52167, RE58231	AMRE58615	\$ 654.00	
8650, 8960 BSN 004100	Muffler Vertical Oval, Inlet 5", Length 56" Replaces AR95833, RE41891	AMRE25444	\$ 467.00	
8970	Muffler Vertical Round, Inlet 6", Length 56" Replaces RE58233, RE58616	AMRE52169	\$ 688.00	
	Inlet Clamp	CL-200	\$ 4.00	
9100, 9120, 9200, 9220, 9300, 9320, 9400, 9420, 9520	Muffler Vertical Round, Inlet 5", Length 55 1/2" Replaces RE71295	AMRE229262	\$ 650.00	
9330, 9430, 9430T, 9530, 9530T, 9630, 9630T	Muffler Lead Pipe	AMRE230504	\$ 184.00	
(A, AN, ANH AR, AW ASN 410000)	Muffler Round, Inlet - Plate, Length 21"	AMR21826	\$ 28.25	
Combines: 4400 Gas or Diesel w/ 329 CID Engine, 6600 Gas w/ 303 CID Engine	Muffler Oval, Inlet 2 3/4", Length 28"	AMAR75694	\$ 116.00	
	Inlet Clamp	CL-314	\$ 6.00	
Combines: 6620, 7700, 7720 - Turbocharged	Muffler Horizontal Round, Inlet 3 1/2", Length 22 3/4"	AMAH87288	\$ 115.00	
	Inlet Clamp	CL-312	\$ 6.50	

John Deere®—Tractor

Starters

All of our remanufactured starters are disassembled, cleaned and inspected. Almost all units receive new field coils. If it meets OEM specifications the armature is test turned and under cut, otherwise it is replaced with a quality factory remanufactured or new part. Starters with factory solenoids have the solenoids replaced with new parts. The drive is carefully inspected and if it does not meet specifications it is replaced with new or quality factory remanufactured drives.



Application	Description	Part Number	Retail Price	Core
840, 920, 930, 940, 970, 1030, 1040, 1055, 1120, 1130, 1140, 1530, 1630, 1640, 1830, 1840, 1850, 1950, 2020, 2030, 2040, 2120, 2130, 2140, 2150, 2250, 2255, 2350, 2355, 2555, 2650, 2755, 2840, 2850, 2940, 2950, 3030, 3040, 3050, 3120, 3140, 3155, 3255, 3350, 3640, 6010, 6100, 6110, 6200, 6210, 6300, 6310, 6400, 6405, 6410, Utility: 820, 830, 955, 2155, 2240	Starter, 12 Volt Bosch, Replaces Bosch Units	AMAR70436	\$ 150.00	
840, 920, 930, 940, 970, 1020 Diesel, 1030, 1040, 1055, 1120, 1130, 1140, 1520, 1530, 1550, 1630, 1640, 1750, 1830, 1840, 1850, 1950, 2020, 2030, 2040, 2120, 2130, 2140, 2150, 2250, 2255, 2350, 2355, 2440, 2510, 2520, 2555, 2630, 2640, 2650, 2755, 2840, 2850, 2940, 2950, 3030, 3040, 3050, 3140, 3155, 3255, 3350, 3500, 3640, 5200, 5300, 5400, 5400N, 5500, 5500N, 6010, 6100, 6110, 6200, 6210, 6300, 6310, 6400, 6405, 6410, Ind: 300, 300B, 301, 301A, 302, 302A, 400, 401, 401B, 401C, Utility: 820, 830, 955, 2155, 2240, 3120, 3300, Combines: 3300 Diesel, 4400 Gas, 6600 Gas or Diesel, Cotton Pickers: (9900, 9910, 9930, 9950 - Diesel), Cotton Strippers: 484, 7440, 7445, Swathers: (2270, 2280, 2320, 2360, 2420, 3430, 3830 - Diesel)	Starter, 12 Volt Delco, 28MT, Gear Reduction, 10 Tooth Replaces AL110597, AL70850, RE59588, RE62916, RE417418, SE501428, TY1458, TY6702, TY24305	AMRE239087	\$ 160.00	
840D, Utility: 830 - All w/ Gas	Reman Starter, 12 Volt Delco 30MT	AM1107155	\$ 304.00	\$ 100.00
(2020, 2030, 2510, 2520 - Gas or LPG), Combine: 3300 w/ 219 Gas Engine, 6600 w/ 303 Gas Engine	Reman Starter, 12 Volt Delco 10MT	AM1108319	\$ 240.00	\$ 200.00
(3010, 3020, 4010, 4020 - w/ 12 Volt Systems), 4000, 4030, 4040, 4050, 4055, 4230, 4240, 4250, 4255, 4320, 4430, 4440, 4450, 4455, 4520, 4555, 4560, 4620, 4630, 4640, 4650, 4755, 4760, 4840, 4850, 4955, 4960, 7020, 7700, 7800, 8430, 8440, 8450, 8560, Ind: 500, 510, Combines: 6620, 7700, 7720, 8820, 9500, 9600, Cotton Picker: 9950, Forage Harvesters: 5200, 5440, 5720, 6610, 6650 - All Diesel	Starter, 12 Volt HD Planetary Gear Reduction, 10 Tooth Steel Pinions, Steel Ring Gear, 4kW, CW Rotation For Diesel Engines Replaces 1113391, 1113672	AMX34112	\$ 285.00	
	Solenoid Use w/ AMX34112 Starter	AMX34113	\$ 60.00	
3010, 3020, 4010, 4020, 7700 - Gas	Reman Starter, 12 Volt Delco 10MT	AM1107350	\$ 242.00	\$ 100.00
3010, 3020, 4010, 4020, 4030, 4040, 4230, 4240, 4430, 4440, 4520, 4620, 4630, 4640, 4840, 7020, 8430, 8440, Combines: 6620, 7720, 8820	Starter, 12 Volt Nippondenso	AMRE41875	\$ 285.00	
4000, 4010, 4020, 4230, 4320, 4430, 4620, 4630, 7020, Combines: 6600, 6602, 7700 - All w/ Diesel	Reman Starter, 12 Volt Delco 35MT Replaces 1113402, R213518, TY6710	AM1113672	\$ 275.00	\$ 100.00
5010, 5020	Reman Starter, 24 Volt Delco 40MT	AM5120024	\$ 350.00	\$ 100.00
5020 w/ 12 Volt System, 6030, 7520, 8630, 8650, 8770, 8870, 9100, 9120, 9200, 9220, 9300, 9300T, 9320, 9320T, 9400, 9400T, 9420, 9420T, 9520, 9520T, 9620, 9620T, Combines: 9750STS, 9860STS, Forage Harvesters: 5200, 5400, 5720, 5820, 7200, 7300, 7400, 7500	Starter, 12 Volt Gear Reduction Replaces 1114191	AMX34108	\$ 425.00	

John Deere®—Tractor

Application	Description	Part Number	Retail Price	Core
5065M, 5075M, 5225, 5325, 5325N, Utility: 4120, 4320, 4520, 4720	Starter, 12 Volt Bosch, Planetary Magnet Gear Reduction, 9 Tooth, 2.20kW, CW Rotation, 2-Ear Mount	AMRE508922	\$ 99.00	
5075E, 5075M, 5085E, 5090E, 5105, 5200, 5205, 5210, 5300, 5310, 5310N, 5320, 5400, 5400N, 5403, 5410, 5420, 5500, 5500N, 5510, 5510N, 5520, 5605, 5615, 5705, 5715, 5725 MFWD, 6110E, 6110J, 6125E, 6125J, 6415, 6615, Cotton Pickers: 9900, 9910, 9920, 9930, Cotton Strippers: 7440, 7445, 7450	Starter, 12 Volt Gear Reduction, 10 Tooth, 3.20kW, Noseless Version 32 mm Pinion OD Replaces RE68470, SE501402	AMRE540300	\$ 290.00	
(5076E, 5076EF, 5076EL - w/ 4045TP079 Engine), 5082E w/ 4045TP080 Engine, 5090E w/ 4045TP066 Engine, (5090EH, 5090EL - w/ 4045TP081 Engine), 5410, 5420, 5420N, 5510, 5510N, 5520, 5520N	Starter, 12 Volt 10 Tooth, CW Rotation Iskra Mfg # - 11131063 Marked RE502156 or RE505746 Replaces SE501852	AMRE516157	\$ 373.30	
5076EN, (5082E, 5090EH, 5090EL - w/ 4045TP072 or TP073 Engine), 5083E, 5083E Limited, (5083EN w/ HLV58 Engine BSN 841652 or All w/ 40405HLV56 or TLV53 Engine), 5085E, (5085M w/ 4045HLV53 Engine BSN 0179457 & ASN 182981 or All w/ 4045HLV54, HLV68, HLV70, HLV72 or HLV75 Engine), (5090E w/ 4045HLV76, TP072 or TP073 Engine), 5090EN, 5090M, 5090R, 5093E, (5093EN w/ 4045HLV62 Engine BSN 842043 or All w/ 4045HLV60 or TLV54 Engine), (5095M w/ 4045HLV52 Engine BSN 180088 & ASN 181962 or All w/ 4045HLV55 Engine), (5095MH w/ 4045HLV52 Engine BSN 180088 & ASN 181962), 5100E, 5100M, 5100MH, 5100ML, 5100R, 5101E, 5101E Limited, (5101EN w/ 4045HLV64 Engine BSN 845830 & ASN 845873, w/ 4045HLV66 Engine BSN 834477 or All w/ 4045TLV56 Engine), (5105ML w/ 4045HLV50 Engine BSN 180833 & ASN 182936), 5115M, 5115ML, 5115R, 5125ML, 5125R, 5425, 5425N w/ 4045DP060 or TP068 Engine, 5525, 5525N, 5725N, 6105D, 6105E, (6115D, 6130D, 6140D - iT4 Only), 6120E	Starter, 12 Volt Gear Reduction, 10 Tooth, 3.20kW, Noseless Version Replaces RE521488, RE551446, SE502913	AMRE543483	\$ 300.00	
(5105, 5205 BSN 216687), (5200, 5300, 5400 ASN 239491), 5210, (5220, 5320, 5320N BSN 223072), 5310, 5310N w/ Valeo Starter	Starter, 12 Volt Gear Reduction, 10 Tooth, 3.20kW Marked RE501680 or RE502156 Will Not Replace Bosch or Iskra Starters Replaces RE501693, RE502196, SE501861	AMRE501680	\$ 258.00	
5045D, 5045E, 5055D, 5055E, 5065E, 5075E, 5103, 5203, 5303, 5403	Starter, 12 Volt Bosch, 10 Tooth, 2.5kW, CW Rotation Replaces RE533976	AMRE553507	\$ 376.26	
5415N, 6120, 6120L, 6215, 6220, 6220L, 6320, 6320L, 6415, 6420, 6420L, 6520L	Starter, 12 Volt 11 Tooth, CW Rotation Marked R506589 Replaces RE506589, SE501854	AMRE519975	\$ 298.00	
6090, 6135, 9410R, 9460R, 9460RT, 9510R, 9510RT, 9560R, 9560RT, Combines: S680, S680 HillMaster, S690, S690 HillMaster	Starter, 24 Volt Gear Reduction, 12 Tooth, 6.50kW Note: Special Order Item	AMRE540886	\$ 625.00	
6105M, 6105R, 6115M, 6115R, 6125M, 6125R, 6130M, 6130R, 6140M, 6140R, 6150M, 6150R, 6150RH, 6170M, 6170R, 6190R, 6210R, 6230, 6330, 6430, 6605, 6615, 6715, 7130, 7230, 7330, 7420, 7520, Premium Models: 6230, 6330, 6430, 7130, 7230, 7330, 7430, 7530	Starter, 12 Volt Bosch, 4.00kW, 2-Bolt Mount Replaces RE501157, RE503226, RE526375, SE501868	AMRE527400	\$ 195.00	

John Deere®—Tractor

Application	Description	Part Number	Retail Price	Core
7710, 7810, 7920, 8100, 8110, 8120, 8200, 8210, 8220, 8300, 8310, 8320, 8330, 8400, 8410, 8420, 8520, 9100, 9120, Combines: 9400, 9410, 9450, 9510, 9550, 9550SH, 9560, 9560SH, 9560STS, 9610, 9650, 9650CTS, 9650STS, 9660, 9660CTS, 9660STS, 9750STS, 9760STS	Starter, 12 Volt Denso, Gear Reduction All Marked RE69704	AMRE70957	\$ 205.00	
8960, 8970, Forage Harvesters: 6810, 6910, 6950	Starter, 12 Volt Delco 42MT, 11 Tooth, CW Rotation	AMRE53695	\$ 295.00	
9330, 9430, 9430T, 9530T, 9630, 9630T	Starter, 12 Volt Denso, 11 Tooth, 5kW, CW Rotation, 3-Ear Mount	AMRE525468	\$ 390.00	
Sprayer: 6700	Starter, 12 Volt Gear Reduction, 10 Tooth, 4.20kW Replaces RE509856, RE523501, SE502632	AMRE523502	\$ 275.00	
(1020, 1520, 2020, 2030 ASN 117500), 1030, 1120 ASN 126363, 1130, 1530, 1630, (1830, 2130 ASN 152400), 2040, 2150, 2255, 2355N, 2440, 2520, 2550, 2555, 2630, 2640, 2750, 2840, 2855N, 2940, 2950, 2955, 3020 ASN 123000, (3030, 3130 ASN 162948), 3055, 3150, 3155, 3255, (4000, 4020 ASN 201000), 4030, 4040, 4050, 4055, 4230, 4240, 4250, 4255, 4320, 4430, 4440, 4450, 4455, 4520, 4555, 4560, 4620, 4630, 4640, 4650, 4755, 4760, 4840, 4850, 4955, 4960, 5020, 6030, 7020, 7520, 8440, 8450, 8560, 8570, 8630, 8640, 8650, 8760, 8770, 8850, 8870, 8960, 8970, Ind: (300, 400 ASN 117906), 300B, 301, 301A, 302A, 401, 401B, 401C, 401D, Utility: 2155, 2240	Ignition Switch Replaces AR47458, AR47459, AR53452	AMAR58126	\$ 19.97	
2010 BSN 055381, 3010, 3020 BSN 068000, 4010, 4020 BSN 091000 - Gas or LPG	Ignition Switch 6 Spade Terminals Includes 2 Keys Replaces AT21418	AMAR26528	\$ 47.50	
(2510, 3020, 4020, 5010, 5020 - Gas), (2510, 3020 SN 068000-122999, 4020 SN 091000-200999, 5010 ASN 007999, 5020 BSN 025000 - Diesel)	Ignition Switch 6 Spade Terminals Includes 2 Keys	AMAR39505	\$ 35.34	
(3010, (3020, 5010 BSN 008000), 4010, 4020 BSN 090100 - Diesel	Ignition Switch 3-Position Switch (Off-On-Start), 6 Spade Terminals Includes 2 Keys	AMAR26557	\$ 51.00	
2010, 3010, 4010, Cotton Pickers: 299, 699	Neutral Starting Switch Replaces 121629C3, 83954C91, AH98872	AMX34147	\$ 30.00	



Starter Conversion Kits

Application	Description	Part Number	Retail Price	Core
3010*, 3020*, 4010, 4020 - Diesel *Some 3010 and 3020 tractors will require a different fuel filter assembly for clearance	24 to 12 Volt Conversion Kit Includes internally regulated 10 volt alternator w/ pulley, alternator mounting bracket, planetary gear reduction starter, safety relay and installation instructions	12V3010-N	\$ 495.00	
5010, 5020	24 Volt to 12 Volt Conversion Kit Includes internally regulated 12 volt alternator w/ pulley, alternator mounting bracket, gear reduction starter and installation instructions	12V5010-GR	\$ 525.00	
	Double Pulley Use w/ 24 to 12 volt conversion kits that require a double pulley on generator	AM24-1107	\$ 14.00	

John Deere®—Tractor

Air Cleaner Components

Application	Description	Part Number	Retail Price	Core
70, 420, 430, 520, 530, 720, 730, 920, 930, 1010, 1020, 1120, 1640, 2010, 2020, 2030, 2040, 2120, 2150, 2250, 2355N, 2440, 2510, 2520, 2630, 2640, 2840, 3010, 3020, 4000, 4010, 4020, Utility: 820, 830, 2155, 2240, Combines: 3300, 4400 Replaces R28794	Small Precleaner Bowl 7" Diameter	AMP02-0227	\$ 10.00	
2020, 2030, 2040, 2120, 2130, 2140, 4020, 4030, 4040, 4050 w/ 466 Engine, 4055, 4230, 4240	Air Intake Stack Boot	AMR57119	\$ 17.66	
2750, 3150, 3155, 4000, 4010, 4020, 5010, 5020, 6030, Combines: 4400, 4420, 6600, 7700, Cotton Pickers: 9900, 9910, Swathers: 4890, 4895, 4990, 4995 Replaces R28795	Large Precleaner Bowl 10.50" Diameter	AMP01-6330	\$ 12.00	
(4000, 4020 SN 201000-250000)	Air Cleaner Suction Hose	AMR42959	\$ 53.35	
920, 930, 1020, 1030, 1120, 1130, 1530, 1630, (1830, 2030, 2130 SN 115792-292145), (2040, 2240 BSN 349999), Utility: (820, 830 - w/ 3 Cylinder Engine), 2240 BSN 349999	Air Cleaner Hose 2" ID & 2.75" ID	AML29373	\$ 23.94	
930, 1020, 1030, 1120, 1130, 1530, 2040, Utility: (820, 830 - w/ 3 Cylinder Engine)	Air Cleaner Hose 2.25" & 2.437" ID	AML29374	\$ 27.47	
1640, 2040, 2040S, 2150, 2255, 2350, 2550, Utility: 2155 BSN 621999, 2240 ASN 350000	Air Cleaner Hose 2.25" & 2.50" ID	AML34646	\$ 19.81	
1640, 2040, 2040S, 2350, 2355, 2550, 2555	Air Cleaner Hose 2.375" & 2.75" ID	AML34918	\$ 31.38	
1640, 2040, 2040S, 2350, 2550	Air Cleaner Hose 2.437" ID	AML34652	\$ 38.70	
4000 ASN 200999, 4020 ASN 119000 - Diesel w/ Pre-Cleaner	Upper Air Cleaner Hose	AMR39710	\$ 56.86	
5045D, 5045E, 5055D, 5055E, 5065E, 5075E, 5076E, 5076EF, 5076EL, 5076EN, 5082E, 5083E, 5083E Limited, 5083EN, 5085E, 5090E, 5090EH, 5090EL, 5090EN, 5093E, 5093EN, 5101E, 5101E Limited, 5101EN, 5103, 5200, 5203, 5210, 5220, 5300, 5303, 5310, 5310N, 5320, 5320N, 5400, 5400N, 5403, 5410, 5410N, 5415, 5420N, 5500, 5503, 5510, 5510N, 5520N, 5615, 5620, 5625, 5715, 5720, 5820, 6010, 6020, 6100B, 6100D, 6100E, 6110, 6110B, 6110D, 6110E, 6110L, 6115D, 6120, 6120L, 6125D, 6125E, 6125J, 6130D, 6130J, 6140D, 6140J, 6155J, 6210L, 6215, 6220, 6220L, 6310, 6310L, 6310S, 6400, 6400SP, 6403, 6405, 6410, 6410L, 6410S, 6415, 6425, 6505, 6510, 6510L, 6510S, 6515, 6520, 6603, 6605, 6610, 6615, 6620, 6715, 6810, 6910, 6910S, 7210, 7220, 7320, 7405, 7410, 7420, 7425, 7505, 7510, 7515, 7520, 7525, 7610, 7710, 7810, Ind: 210LE, Combine: 9400, Cotton Picker: 9935, Cotton Strippers: 7455, 7460, Sprayers: 4700, 4710, 6500, 6700, Swathers: 4890, 4895, 4990, 4995	Air Intake Hose 3.15" Long	AMR500596	\$ 7.06	

Tachometers, Gauges and Instrument Clusters

Red needle: early tractors; white needle: late tractors, has provisions for back light and fiber optics.



Application	Description	Part Number	Retail Price	Core
50, 520, 530	Tachometer	AMAB5132R	\$ 125.00	
1020, 1520, 1530, 2020, 2030, (2440, 2640 BSN 340999), 2630, Ind: (300, 400 BSN 131260), 300B, 301, 301A, 302, 302A, 401, 401A, 401B, 401C, Utility: 2240 BSN 349999	Tachometer Replaces AR50954, AT20641, AT159296, T22409	AMAR65445	\$ 25.00	
2510, 2520, 3020 - Gas, LP or Diesel w/ Syncro Range Transmission	Tachometer	Red Needle	AMAR32838	\$ 85.00
		White Needle	AMRE206853	\$ 205.00
2510, 2520, 3020, 4020 VASN 2500001 - Gas, LP or Diesel w/ Powershift Transmission	Tachometer	Red Needle	AMAR32830	\$ 85.00
		White Needle	AMRE206854	\$ 205.00
3010, 4010, 4020, 4320, 4520, 4620, 5010, 5020 - Gas, LP or Diesel w/ Syncro Range Transmission	Tachometer	Red Needle	AMAR32833	\$ 85.00

John Deere®—Tractor

Application	Description	Part Number	Retail Price	Core
3010, 4010, 4020, 4320, 4520, 4620, 5010, 5020 - Gas, LP or Diesel w/ Syncro Range Transmission	Tachometer White Needle	AMRE206855	\$ 206.00	
4020 BSN 250000, 4520, 4620 - Gas or Diesel w/ Powershift Transmission	Tachometer Red Needle	AMAR32827	\$ 85.00	
	White Needle	AMRE206857	\$ 85.00	
4040, 4230, 4240, 4430, 4440, 4630, 4640, 4840 - w/ Power Shift Transmission	Tachometer Replaces AR60514, AR80826, RE152798	AMRE206861	\$ 215.00	
80, Utility: (820, 830 - w/ 2 Cylinder Engine)	Tachometer Cable 81" Long	AMAR1318R	\$ 69.54	
420, 430, 8440, 8630, 8640	Tachometer Cable 56" Long Replaces AR70112	AMAM3131T	\$ 42.15	
820, 830, 920, 930, 1020, 1030, 1120, 1130, 1630, Utility: 820, 830	Tachometer Cable 23" Long Replaces AT19905	AMAL23837	\$ 19.75	
1520, 1830, 2020, 2030, (2040, 2440, 2640 BSN 34999), 2120, 2130, 2630, Ind: 300B, 301A, 302, 302A, 400, 401, 401B, 401C, Utility: 2240 BSN 34999	Tachometer Cable 25.19" Long Replaces AT19904	AMAL23838	\$ 16.00	
2510, 2520	Tachometer Cable 22" Long	AMAR38341	\$ 19.96	
2840, 3030, 3120, 3130	Tachometer Cable 27" Long	AMAT27372	\$ 29.07	
3010, 3020, 4000, 4010, 4020, 4320, 4520, 4620, Ind: 500, 600, Combines: 3300, 4400, 4420, 6600	Tachometer Cable 33.50" Long, Steel Outer Sheath, Restoration Quality Replaces AR28589	AMAR26721	\$ 29.50	
4030	Tachometer Cable 30" Long	AMAR60877	\$ 27.34	
4040, 4240, 4430, 4440, 4630, 4640, 4840, 8430, Combines: 6600, 7700	Tachometer Cable 40" Long	AMAR21085	\$ 36.98	
(940, 1040, 1140 BSN 507734), 1640, 2140 SN 043000-507734, (2355, 2755, 2855 - w/ Collar Shift Transmission), 2350, 2550, 2640 ASN 341000, 2750, 2940 w/o Sound-Gard™ Body, 2950, (3040, 3140 BSN 470000), Utility: 2155 w/ Collar Shift Transmission, 2240 ASN 350000	Gauge Cluster 19 MPH	AMAL31829	\$ 319.00	
(1010, 2010 BSN 042001), 2510, 3010, 3020 ASN 123000, 4010, 4020 BSN 065000, 5010 BSN 008000, 5020 BSN 024999, Combines: 3300, 6600, 6602, 7700	Fuel Gauge Replaces AR46271, R34262, RE54427	AMAR26716	\$ 46.00	
Tractors: 2520, 3020 ASN 123000, 4020 ASN 201000, 4320, 4520, 4620, 5020 ASN 025000, 6030, 7020, 7520, Combines: 3300, 4400, 4420, 6600, 6602, 7700	Fuel Gauge For 12 Volt Negative Ground Systems w/ 2" Opening OD, 1 1/2" Thick Gauge Housing, 30 to 250 OHM Rating Note: Some applications may require external ground (not included) Replaces AT375294, AR45436	AMAR45436	\$ 46.50	
(4000, 4020 ASN 201000)	Fuel Gauge	AMR160776	\$ 140.00	

John Deere®—Tractor

Application	Description	Part Number	Retail Price	Core
2040, 2140, 2150, 2255, 2350, 2355, 2355N, 2550, 2555, 2640, 2755, 2840, 2855N, 2940, 2950, 2955, 3040, 3055, 3140, 3150, 3155, 3255, 5039D, 5045D, 5045E, 5055D, 5055E, 5065E, 5075E, 5103, 5105, 5200, 5203, 5205, 5210, 5220, 5300, 5303, 5310, 5310N, 5320N, 5400, 5403, 5420N, 5500, 5520N, 6110, 6110L, 6200, 6200L, 6210, 6210L, 6215, 6300, 6300L, 6310, 6310L, 6400, 6400L, 6405, 6410, 6410L, 6415, 6500, 6500L, 6510L, 6605, 6615, 6715, 7405, 7500, Utility: 820, 2155, 2240	Water Temperature Sensor Replaces AR24527	AMRE51774	\$ 20.45	
(2510, 3020 BSN 122999, 4020 BSN 200999, 5010 - Gas or Diesel), 5020 BSN 024999 w/ Diesel	Water Temperature Gauge 100°F Minimum to 250°F Maximum, 26" Lead, 0.95" Thick, 2.045" Housing OD, 2.324" Bezel OD No provision for fiber optic light Replaces R34263	AMAR36383	\$ 45.00	
2520, 3020 Engine ASN 123000, 4020 Engine ASN 201000, 4320, 4520, 4620, 7020, Ind: 510, Combines: 3300, 4400, 4420, 6600, 6602, 7700	Water Temperature Gauge 100°F Minimum to 247°F Maximum, 26" Lead, 0.95" Thick, 2.045" Housing OD, 2.324" Bezel OD No provision for fiber optic light Replaces AR45435	AMAR48640	\$ 46.00	



Pony Motor Coils

Application	Description	Part Number	Retail Price	Core
(70, 720, 730 - Diesel), 80, Utility: 820, 830	Pony Motor Coil Fits Pony Motor w/ Wico Magneto (2) Required per Engine	AMSM5193	\$ 52.00	



Alternators

Application	Description	Part Number	Retail Price	Core
400 Series, 2150, 2255, 3010, 3020, 4010, 4020, 4030, 4230, 4240, 4320, 4430, 4440, 4620, 4630, 4640, 4650, 4840, 4850, 5400, 6030, 7020, 7520, 8430, 8630	Alternator 12 Volt, 72 Amps, IR/EF, CW Rotation, Plug at 12 o'clock Position, 3-Pin	AMTY6600	\$ 137.86	
4040, 4050, 4240, 4440, 4450, 4640, 4650, 4840, 4850, 5720, 5730, 5820, 5830, 8440, 8630, 8640	Alternator w/o Pulley 80 Amps Replaces AR87205, AR93448, AT103789	AMTY26050	\$ 170.00	
1010, 1640, 2010, 2040, 2040S, 2140, 2250, 2650, 2650N, 2850, 3040, 3050, 3055, 3140, 3350, 3430, 3640, 3830, 6500	Alternator w/o pulley 12 Volt, I/R 95 Amps Bosch style w/ B+ thru D+ terminals, w/ spade terminal	AMAL81437	\$ 102.00	
2030, 2040, 2120, 2130, 2140, 2150, 2250, 2255, 2355, 2355N, 2440, 2550, 2555, 2750, 2755, 2840, 2940, 2950, 2955, 3140, 3150, 3155, 6200L, 6300, 6300L, 6400, 6400L, 6500, 6500L, Utility: 2155, 2240	Alternator w/ Pulley 12 Volt, 55 Amps Single Groove Pulley Replaces TY6669, TY6791, TY25953	AMAL207585	\$ 150.00	
2030, 2840, 3030, 3120, 3130, Utility: 830, 2040, 2240	Alternator 12 Volt Replaces AL36100, AR62401	AMAL36391	\$ 90.00	

John Deere®—Tractor

Application	Description	Part Number	Retail Price	Core
4055, 4255, 4455, 4555, 4560, 4755, 4760, 4955, 4960, 7210, 7410, 7510, 8560, 8570, 8760, 8770, 8870, 8960, 8970	Alternator w/ Pulley 12 Volt, 120 Amps, CW, Negative Ground, 2-Groove Pulley Replaces RE36246, RE37201, RE42123, RE44140, RE51921, SE501371, Denso: 100211-6030, 100211-6031, 100211-6050, 100211-6051	AMTY6684	\$ 144.00	
(5065M, 5075M, 5083E, (5083EN, 5093EN, 5101EN ASN 360001), 5085M, 5093E, 5095M, 5095MH, 5105M, 5105ML, 5225, 5325, 5325N, 5425, 5525, 5625, 5725, 6110D, 6115D, 6125D, 6130D, 6140D - w/ Cab), (5415, 5415H, 5425N, 5525N, 5615, 5715, 5715HC - w/o Cab)	Alternator Bosch, 12 Volt, 70 Amps Replaces SE501831	AMRE529377	\$ 311.00	
5620, 5720, 5820, 6120, 6120L, 6215, 6220, 6220L, 6230, 69320, 6320L, 6330, 6415, 6420, 6420L, 6430, 6520L, 6615, 6715, 7130, 7220, 7230, 7320, 7330, 7420, 7430, 7520, 7530	Alternator w/o Pulley Bosch	AMAL166646	\$ 177.00	
5075M Excluding IT4, 5085E, 5085M Tier 4, 5090E, 5090EL, 5090M, (5100E, 6115D, 6130D, 6140D - North American Models Only), 5100M, 5100MH, 5100ML, 5115M, 5115ML, 5125ML, 6100E, 6105D, 6105E, 6110E, 6115E, 6120E, 6125E, 6130E, 6135E	Alternator 14 Volt, 90 Amps	AMRE544809	\$ 240.00	
6020, 6120, 6120L, 6210L, 6215, 6220, 6220L, 6320, 6320L, 6415, 6420, 6420L 6420S, 6520, 6520L, 6615, 6620, 6715, 6820, 6920, 6920S, 7220, 7320, 7420, 7520, SE6020, SE6120, SE6220, SE6320, SE6420, SE6520, SE6620	Alternator Bosch Type, 12 Volt, 150 Amps Replaces AL166647, AL166836, SE501830	AMAL171541	\$ 362.00	
6090MC, 6090RC, 6100MC, 6100RC, 6105M, 6105R, 6110MC, 6110RC, 6115M, 6115R, 6125M, 6125R, 6130M, 6130R, 6140M, 6140R, 6150M, 6150R, 6170M, 6170R, 6190R, 6210R, Premium Models: 6530, 6534, 6630, 6830, 6930, 7130, 7230, 7330, 7430, 7530	Alternator 14 Volt, 200 Amps Note: Special Order Item	AMAL170947	\$ 300.00	
6100B, 6110B, 6403, 6603 Replaces A187623, AH137883, AT220394, RE36267, RE505895, SE501342, TY6750	Alternator, w/o Pulley Bosch, 12 Volt, 95 Amps, IR/EF, CW Rotation	AMA187623	\$ 105.00	
6105M, 6115M, 6120, 6120L, 6125M, 6140J, 6140M, 6155J, 6170M, 6215, 6220, 6220L, 6230, 6320, 6320L, 6330, 6415, 6420, 6420L, 6430, 6615, 6715, 7130, 7220, 7230, 7320, 7330, 7520	Alternator Bosch Type, 12 Volt, 90 Amps, IR/IF Replaces AL111675, SE501829	AMAL166645	\$ 343.66	
(7200, 7210, 7400, 7410, 7510 - w/ Cab), 7600, 7610, 7700, 7710, 7800, 7810, 8100, 8100T, 8110, 8110T, 8200, 8200T, 8210, 8210T, 8300, 8300T, 8310, 8310T, 8400, 8400T, 8410, 8410T, 9100, (9120, 9220, 9320, 9420, 9520, 9620 BSN 011174), 9200, 9300, 9300T, (9320T, 9420T, 9520T, 9620T BSN 902185), 9400, 9400T	Alternator w/ Pulley Denso, 12 Volt, 140 Amps, IR/IF, CW Rotation, 8-Groove Pulley	AMRE46608	\$ 162.00	
(7200R, 7215R, 7230R, 7260R, 7280R BSN 080000), 7630, 7730, 7830, 7930, 8130, (8225R, 8245R, 8270R, 8295R, 8320R, 8345R SN 000101-053099), 8230, 8230T, (8235R, 8260R, 8285R, 8310R, 8360R SN 016001-090000), (8295RT, 8345RT SN 900101- 907100), 8330, 8330T, 8335R BSN 016001, (8335RT, 8360RT SN 902501-912000), 8430, 8430T, 8530, 9330, 9430, 9430T, 9530, 9530T, 9630, 9630T	Alternator w/ Pulley Bosch, 12 Volt, 200 Amps, IR/IF, Uses B+ and D+ post Can be used to replace AH229090, but may require change of pulley Replaces RE555751	AMRE210793	\$ 275.00	
7720, 7820, 7920, 9120 ASN 011283, (9220, 9320, 9420 ASN 011175), 9320T, (9420T, 9520T, 9620T ASN 902186), 9520 ASN 011284, 9620	Alternator Denso Type, 12 Volt, 150 Amps, IR/IF Replaces RE186320, SE501837, Nippondenso 104210-3920, 104210-3921	AMRE257541	\$ 438.00	
8120, 8120T, 8220, 8220T, 8320, 8320T, 8420, 8420T, 8520, 8520T	Alternator Bosch Type, 12 Volt, 150 Amps, IR/IF Replaces RE185213, SE501825	AMRE218703	\$ 375.50	

John Deere®—Tractor

Application	Description	Part Number	Retail Price	Core
Utility: 655, 755, 855, 955, 3005, 4005, 4010	Alternator 12 Volt, 40 Amps Replaces AM100808	AMAM877740	\$ 100.00	
Utility: 1023E, 1025R, 1026R, 2025R, 3032E, 3036E, 3038E, 3120, 3203, 3320, 3520, 3720, 4105, 4200, 4210, 4300, 4310, 4400, 4410, 4500, 4510, 4600, 4610, 4700, 4710	Alternator 12 Volt, 40 Amps Replaces AM879908	AMLVA12357	\$ 110.00	
Utility: 1025R, 1026R, 2025R, 3025D, 3035D, 3043D, 4200, 4210, 4300, 4310, 4400, 4410, 4500, 4510, 4600, 4610, 4700, 4710, Gator™ Utility Vehicles: 2030A Pro, 2030A GPS Pro	Alternator 12 Volt, 55 Amps Replaces LVA12467, M809216	AMMIA884643	\$ 110.00	
2520, Utility: 2025R, 2720	Alternator 12 Volt, 55 Amps Replaces MIU800942	AMMIA884638	\$ 108.00	
Utility: 3203, (3320, 3520, 3720 - w/ Factory Installed Cab)	Alternator 12 Volt, 70 Amps	AMMIA10222	\$ 180.00	
5070M, 5080M, 5080R, 5080RN, 5090M, 5090R, 5090RN, 5100M, 5100R, 5620, 5720, 5820, 6020, 6090MC, 6090RC, 6100MC, 6100RC, 6105M, 6105R, 6110RC, 6115M, 6115R, 6120, 6120L, 6125M, 6125R, 6130, 6130M, 6140R, 6150M, 6150R, 6150RH, 6165J, 6170M, 6170R, 6190R, 6210R, 6215, 6220, 6220L, 6225, 6230, 6230 Premium, 6320L, 6325, 6330, 6415, 6420, 6420L, 6420S, 6425, 6430, 6515, 6520, 6520L, 6525, 6530, 6534, 6615, 6620, 6630, 6820, 6830, 6920, 6920S, 6930, 7130, 7220, 7230, 7320, 7330, 7420, 7430, 7520, 7530, SE6020, SE6120, SE6220, SE6320, SE6420, SE6520, SE6620, SE6920	Alternator Pulley Replaces AL157595, AL161112	AMAL166836	\$ 47.58	
6120, 6120L, 6215, 6220, 6220L, 6320, 6320L, 6415, 6420, 6420L, 6420S, 6515, 6520, 6615, 6620, 6715, 6820, 6920, 6920S, 7220, 7320, 7420, 7520, SE6020, SE6120, SE6220, SE6320, SE6420, SE6520, SE6620	Alternator Pulley	AMAL166835	\$ 53.61	
5082E, 5083E, 5083EN, 5085E, 5085M, 5090E, 5090EH, 5090EL, 5090EN, 5090R, 5093E, 5093EN, 5095M, 5095MH, 5100E, 5100M, 5100MH, 5100ML, 5100R, 5101E, 5101EN, 5105M, 5105ML, 5115M, 5115ML, 5115R, 5125ML, 5125R, 6105E, 6120E, 6135E	Belt Tensioner, Alternator 200 PSI Spring Pressure Replaces RE70535, RE70536, RE548027	AMRE518097	\$ 101.00	
5070M, 5080M, 5080R, 5080RN, 5090M, 5090R, 5090RN, 5100M, 5620, 5720, 5820, 6010, 6020, 6110, 6110E, 6110J, 6110L, 6120, 6125E, 6125J, 6165J, 6205, 6210, 6210L, 6215, 6220, 6230, 6310, 6310L, 6310S, 6320, 6320L, 6330, 6405, 6410, 6410L, 6410S, 6415, 6420, 6420L, 6420S, 6425, 6430, 6505, 6510, 6510L, 6510S, 6515, 6520, 6520L, 6530, 6534, 6610, 6615, 6620, 6630, 6715, 6810, 6820, 6830, 6910, 6910S, 6920, 6920S, 6930, 7130, 7230, 7330, 7420, 7430, 7520, 7530	Tensioner Pulley	AMAL157593	\$ 32.00	
(6100, 6200, 6200L, 6300, 6300L, 6400, 6400L, 6500, 6500L, 6506, 6600, 6800, 6900 - w/ BSN 159438)	Tensioner Pulley	AMAL77334	\$ 41.00	
(6100, 6200, 6200L, 6300, 6300L, 6400, 6400L, 6500, 6500L, 6506, 6600, 6800, 6900 - w/ ASN 159439)	Tensioner Pulley	AMAL116368	\$ 55.00	

John Deere®—Tractor

Sensors

Application	Description	Part Number	Retail Price	Core
4520, 4560, 4760, 4960, 5045D, 5045E, 5055D, 5055E, 5065E, 5065M, 5075E, 5075M, 5076E, 5076EF, 5076EL, 5082E, 5083E, 5083EN, 5085M, 5090E, 5090EH, 5090EL, 5093E, 5093EN, 5095M, 5095MH, 5100M, 5100MH, 5101E, 5101EN, 5103, 5105, 5105M, 5105ML, 5115M, 5115ML, 5200, 5203, 5205, 5210, 5220, 5225, 5300, 5303, 5310, 5310N, 5320, 5320N, 5325, 5325N, 5400, 5400N, 5403, 5410, 5415, 5420, 5420N, 5425, 5425N, 5500, 5500N, 5510, 5510N, 5520, 5520N, 5525, 5525N, 5605, 5615, 5625, 5705, 5715, 5725, 6100D, 6110, 6110D, 6110L, 6115D, 6120, 6120L, 6125D, 6130D, 6140D, 6140J, 6150M, 6155J, 6170M, 6200, 6200L, 6210, 6210L, 6215, 6220, 6220L, 6230, 6300, 6300L, 6310, 6310L, 6310S, 6320, 6320L, 6330, 6400, 6400L, 6403, 6405, 6410, 6410L, 6410S, 6415, 6420, 6420L, 6430, 6500, 6500L, 6510L, 6510S, 6520L, 6603, 6605, 6615, 6715, 7130, 7200, 7210, 7220, 7230, 7320, 7330, 7400, 7405, 7410, 7420, 7505, 7510, 7520, 7600, 7610, 7630, 7700, 7710, 7720, 7730, 7800, 7810, 7820, 7830, 7920, 7930, 8120, 8120T, 8130, 8220, 8220T, 8225R, 8230, 8230T, 8235R, 8245R, 8260R, 8270R, 8285R, 8295R, 8295RT, 8310R, 8310RT, 8320, 8320R, 8320RT, 8320T, 8330, 8330T, 8335R, 8335RT, 8345R, 8345RT, 8360R, 8360RT, 8420, 8420T, 8430, 8430T, 8520, 8520T, 8530, 8560, 8570, 8760, 8770, 8870, 8960, 8970, 9100, 9120, 9200, 9220, 9230, 9300, 9300T, 9320, 9320T, 9330, 9400, 9400T, 9410R, 9420, 9420T, 9430, 9430T, 9460R, 9460RT, 9510R, 9510RT, 9520, 9520T, 9530, 9530T, 9560R, 9560RT, 9620, 9620T, 9630, 9630T, Premium Models: 6230, 6330, 6430, 7130, 7230, 7330, 7430, 7530, Ind: 210LE, 210LJ, Utility: 4720	Engine Speed Sensor	AMRE519144	\$ 20.00	
5045E Stage IIIB or Stage IV, (5055E, 5065E - Stage III, Stage IV or iT4), (5075E, 5085E, 5100E - FT4 or iT4), 5076E, 5076EL, 5076EN, 5082E, 5083E, 5083E Limited, 5083EN, (5090E PIN ASN 1LV5090E*JK100001 & ASN 1J05090ETJ0011836), 5090EH, 5090EL, 5090EN, 5093E, 5093E Limited, 5093EN, 5101E, 5101E Limited, 5101EN, 5225, 5325, 5325N, 5425N, 5525, 5525N, 5603, 5625, 6105D, (6110R, 6130R - FT4 Prior to MY18), (6115D, 6130D, 6140D - iT4), 6120R, 6140R, 6145R, 6150R, 6150RH, 6155R, 6155RH, 6170R, 6175R, 6190R, 6195R, 6210R, 6215R, (7200R, 7215R, 7230R BSN 080001 - w/ CommandQuad™ or PowerQuad™ w/o Torque Sensor), (8130, 8230, 8330, 8430, 8530 - w/ IVT™ Transmission), (8225R, 8245R, 8270R, 8295R, 8320R, 8345R BSN 053100 w/ IVT™ Transmission), 8235R, 8260R, 8285R, 8295RT, 8310R, 8310RT, (8320RT, 8345RT BSN 907101 w/ IVT™ Transmission), 8335R BSN 090001, 8335RT, 8360R, 8360RT	Wheel Speed Sensor Replaces RE204888, RE558874	AMRE295929	\$ 85.00	
5076EN, 5083EN, 5090EN, 5093EN, 5101EN, 5225, 5325, 5325N, 5425, 5525, 5525N, 5625, 7200, 7210, 7400, 7410, 7510, 7600, 7610, 7700, 7710, 7800, 7810, 7815, 8100, 8110T, 8120, 8120T, 8200, 8210T, 8220, 8220T, 8300, 8310T, 8320, 8320T, 8400, 8410T, 8420, 8420T, 8520, 8520T, Ind: 210LE	Potentiometer Sensor	AMRE261354	\$ 100.00	
5065M, 5075M, 5080R, 5080RN, 5090R, 5090RN, 5100R, 5100RN, 5105M, 6100D, 6105M, 6110D, 6110M, 6115D, 6125D, 6125J, 6125M, 6130, 6130D, 6140D, 6140M, 6150M, 6155M, 6170M, 6175M, 6195M, 6225, 6230, 6325, 6330, 6425, 6430, 6525, 6530, 6534, 6830, 6930, 7130, 7230, 7330, 7630, 7730, 7830, 7930, 8130, 8225R, 8230, 8230T, 8245R, 8270R, 8295R, 8295RT, 8320R, 8320RT, 8330, 8330T, 8335R, 8345R, 8345RT, 8370R, 8400R, 8430 2006-09, 8430T, 8530, 9330, 9420R, 9430, 9430T, 9470R, 9520R, 9530, 9530T, 9570R, 9630, 9630T, Premium Models: 6230, 6330, 6430, 6530, 6534, 6630, 6830, 6930, 7130, 7230, 7430, 7430E, 7530, 7530E, Utility: 4520, 4720	Air Temperature Sensor Replaces 72102514	AMRE525016	\$ 19.25	
7930, 8130, 8225R, 8230, 8230T, 8235R, 8245R, 8260R, 8270R, 8285R, 8295R, 8295RT, 8310R, 8310RT, 8320R, 8320RT, 8330, 8330T, 8335R, 8335RT, 8345R, 8345RT, 8360R, 8360RT, 8370R, 8370RT, 8430, 8430T, 8530, 9230, 9370R, Premium Models: 7330, 7430	Air Temperature Sensor	AMRE522823	\$ 45.00	
7200R, 7210R, 7215R, 7230R, (7250R, 7260R, 7280R, 7290R, 7310R, 7R 210, 7R 230, 7R 250, 7R 270, 7R 290, 7R 310, 7R 330, 7R 350 - w/ TLS), 8225R BSN 053100	Front Axle Position Sensor Replaces RE232603	AMRE334232	\$ 68.00	
7200R, 7215R, 7230R BSN 080001, 7260R, 7280R, 8130, (8225R, 8245R, 8270R, 8320R, 8345R BSN 053100), 8230, 8230T, 8235R, 8260R, 8285R, 8295R, 8295RT, 8310R, 8310RT, 8320RT, 8330, 8330T, 8335R BSN 090001, 8335RT, 8345RT BSN 907101, 8360R, 8360RT, 8430, 8430T, 8530, 9360R, 9410R, 9460R, 9460RT, 9510R, 9510RT, 9560R	Rockshaft/Hitch Position Sensor Replaces RE232603	AMRE334232	\$ 68.00	

John Deere®—Tractor

Application	Description	Part Number	Retail Price	Core
8100, 8110, 8120, 8130, 8200, 8210, 8220, 8230, (8225R, 8245R, 8270R, 8295R, 8320R, 8345R SN 000101-053099), (8235R, 8260R, 8285R, 8310R, 8335R, 8360R SN 016001-090000), 8300, 8320, 8330, 8400, 8410, 8420, 8430, 8520, 8530, 9100, 9120, 9200, 9220, 9230, 9300, 9300T, 9310, 9320, 9320T, 9330, 9400, 9400T, 9420, 9420T, 9430, 9430T, 9520, 9520T, 9530, 9530T, 9620, 9620T, 9630, 9630T	Fluid Level Switch Replaces 0361337560	AMRE55516	\$ 65.00	
8100T, 8110T, 8120T, 8200T, 8210T, 8220T, 8230T, 8295RT, 8300T, 8310RT, 8310T, 8320RT, 8320T, 8330T, 8335RT, 8345RT, 8360RT, 8400T, 8410T, 8420T, 8430T, 8520T, 9300T, 9320T, 9400T, 9420T, 9430T, 9460RT, 9510RT, 9520T, 9530T, 9560RT, 9620T, 9630T	Steering Position Sensor	AMRE69108	\$ 950.00	
8120, 8130, 8220, 8225R, 8230, 8235R, 8245R, 8260R, 8270R, 8285R, 8295R, 8310R, 8320, 8320R, 8330, 8335R, 8345R, 8360R, 8420, 8430, 8520, 8530	Wheel Speed Sensor Replaces RE191389, RE214147, RE241785	AMRE257113	\$ 120.00	
8120, 8130, 8220, 8225R, 8230, 8230T, 8245R, 8270R, 8295R, 8295RT, 8320, 8320R, 8320RT, 8330, 8330T, 8345R, 8345RT, 8420, 8430, 8430T, 8520, 8530, 9120, 9220, 9230, 9320, 9320T, 9330, 9410R, 9420, 9420R, 9420T, 9430, 9430T, 9460R, 9460RT, 9470R, 9510R, 9510RT, 9520, 9520T, 9530, 9530T, 9560R, 9560RT, 9620, 9620T, 9630, 9630T	Fuel Filter Moisture Sensor Replaces RE532949	AMRE503590	\$ 60.00	
8295RT, 8310RT, 8320RT ASN 912001, (8335RT, 8360RT ASN 907100), 8345RT, 8370RT, 8RT 310, 8RT 340, 8RT 370, 8RT 410, 9430T, 9460RT, 9470RT, 9510RT, 9520RT, 9530T, 9560RT, 9570RT, 9630T	Track Drive Suspension Position Sensor Replaces RE232603	AMRE334232	\$ 68.00	
Utility: 670, 770, 790, 870, 970, 990, 1023E, 1025R, 1026R, 1070, 2025R ASN 100000, 2026R, 3005, 3033R BSN 100000, 3036E, 3038R, 3045R, 3120, 3203, 3320, 3520, 3720, 4005, 4049R, 4105, 4200, 4210, 4300, 4310, 4400, 4410, 4500, 4510, 4600, 4610, 4700, 4710, Gator™ Utility Vehicles: 2020A Diesel BSN 060000, 2030A	Water Temperature Sender Switch	AMT110736	\$ 31.90	







Wide Front Ends

Application	Description	Part Number	Retail Price	Core
2510, 2520, 3010, 3020, 4010, 4020, 4320	Wide Front End Replaces AR44331	WF4020-N	\$ 2475.00	
	Reman Adjustable Wide Front End Replaces AR44331	WF4020-R	\$ 1450.00	\$ 500.00
	Reman Adjustable Wide Front End, 6-Bolt Hubs HD, Converted from John Deere® 4430	WF4020-HD	\$ 2050.00	\$ 500.00
	Reman Adjustable Wide Front End, 8-Bolt Hubs Extra HD, Converted from John Deere® 4630	WF4020-XHD	\$ 2250.00	\$ 500.00
	Reman Adjustable Wide Front End, 8-Bolt Hubs HD, Converted from John Deere® 4430	WF4020-HD8	\$ 2150.00	\$ 500.00
4030, 4040, 4050, 4055, 4230, 4240, 4250, 4255, 4430, 4440, 4450, 4455	Rebuilt Wide Front End For early tractor this is an upgrade to a larger spindle and requires an upgrade on wheel bearings AMR49841 8-Bolt Hub Requires WBK-JD-7 AMR49839 6-Bolt Hub Requires WBK-JD-8	WF4440-R	\$ 1775.00	\$ 500.00

Mechanical Front Wheel Drive Parts

MFWD Hubs and Housings













	Application	Description	Part Number	Retail Price	Core
	5045E, 5055E, 5065E, 5075E, 5076E, 5082E, 5083E, 5085E, 5090E, 5090EH Hi-Clearance, 5093E, 5100E, 5101E, 5103 ASN 013640, 5203 ASN 005569, 5225, 5303 ASN 007751, 5325, 5403 ASN 001357, 5415, 5415H, 5425, 5525, 5603, 5615, 5625, 5715, 5715HC, 5725 ASN 005048	Axle Housing	AMR271389	\$ 1150.00	
	6120, 6120L, 6215, 6220, 6220L, 6230, 6320, 6320L, 6330, 6415, 6420, 6420L, 6430, 6520L	Axle Housing, Right Hand Long w/ Bushings Replaces AL166356	AMAL161316	\$ 1750.00	
	6120, 6120L, 6215, 6220, 6220L, 6320, 6320L, 6420, 6420L, 6520L	Axle Housing, Left Hand Replaces AL161318, AL161284, AL174523	AMAL171828	\$ 1495.00	
	6140J, 6155J, 7330, 7420, 7520, Premium Model: 7330	Axle Housing, Left Hand Replaces AL160136	AMAL167052	\$ 3250.00	
	6615, 6715, 7130, 7220, 7230, 7320	Axle Housing, Right Hand Long w/ Bushings Use w/ AL173216 and AL173218 Front Axles	AMAL175040	\$ 1875.00	
	6615, 6715, (7220, 7320 ASN 002761) - w/ APL740 Axle w/o TLS™	Axle Housing, Right Hand Long w/ Bushings Use w/ AL171555 or AL171556 Axle	AMAL160547	\$ 3250.00	
	7330, Premium Model: 7330 - All w/ 750 Axle w/o TLS	Axle Housing, Right Hand Replaces AL171836	AMAL177037	\$ 1585.00	
	Utility: 4044M, 4044R, 4049M, 4049R, 4052M, 4052R, 4066M, 4066R	Axle Housing, Right Hand Front Axle	AMLVU27453	\$ 750.00	
		Axle Housing, Left Hand Front Axle	AMLVU27452	\$ 750.00	
	5045E, 5055D, 5055E, 5065E, 5065M, 5075E, 5075M, 5076E, 5076EL, 5082E, 5083E, 5085E, 5085M, 5090E, 5090EH, 5090EL, 5093E, 5095M, 5100E, 5100M, 5100MH, 5100ML, 5101E, 5103, 5105M, 5105ML, 5115M, 5115ML, 5125ML, 5203, 5225, 5303, 5325, 5403, 5415, 5415H, 5425, 5525, 5603, 5615, 5625, 5715, 6100D, 6105D, 6110D, 6115D, 6120E, 6125D, 6130D, 6135E, 6140D, 6140J, 6155J, 6170M, 6195M, 6320L, 6403, 6415, 6420L, 6520L, 6603, 7320, 7420, 7520, 7720	Driveshaft Housing Seal	AML156857	\$ 35.00	
	5045E, 5055E, 5065E, 5075E, 5076E, 5082E, 5083E, 5085E, 5090E, 5090EH Hi-Clearance, 5093E, 5100E, 5101E, 5103 ASN 013640, 5203 ASN 005569, 5225, 5303 ASN 007751, 5325, 5403 ASN 001357, 5415, 5415H, 5425, 5525, 5603, 5605 SN 080729-090475, 5615, 5625, 5705 ASN 080729, 5715, 5715HC, 5725 ASN 005048	Front Axle Support, Front	AMR271464	\$ 200.00	
	5065M, 5075M, 5085M, 5090M, 5090R, 5095M, 5095MH, 5100M, 5100MH, 5100ML, 5100R, 5105M, 5105ML, 5115M, 5115ML, 5115R, 5125R	Front Axle Support, Front	AMSU302445	\$ 350.00	
	5045E, 5055E, 5065E, 5075E, 5093E, 5103 ASN 013640, 5203 ASN 005569, 5303 ASN 007751, 5403 ASN 001357, 5415, 5415H, 5615, 5715, 5715HC	Front Axle Support, Rear	AMR271459	\$ 250.00	

Mechanical Front Wheel Drive Parts

John Deere®—Tractor

John Deere®—Tractor









Mechanical Front Wheel Drive Parts

Application	Description	Part Number	Retail Price	Core
 5076E, 5082E, 5083E, 5085E, 5090E, 5090EH Hi-Clearance, 5093E, 5100E, 5101E, 5225, 5325, 5415, 5415H, 5425, 5525, 5603, 5615, 5625, 5715, 5725 ASN 005048	Front Axle Support, Rear	AMR274621	\$ 425.00	
8100 ASN 001491, 8110, 8120, 8130, 8200 ASN 001461, 8210, 8220, 8300 ASN 002511, 8310, 8310R w/o ILS™ Axle, 8320, 8330, 8400 ASN 001121, 8410, 8420, 8520, 8530, (8225R, 8230, 8235R, 8245R, 8270R, 8295R, 8335R BSN 090001, 8360R, 8430 - w/ 1300 Axle)	Front Axle Support, Rear	AMRE62205	\$ 131.50	
 7210, 7410, 7420, 7510, 7520, 7610, 7710, 7810, 7815, 7630, 7720, 7730, 7820, 7830, 7920, 7930, Premium Model: 7330	Front Axle Pin	AMR131840	\$ 275.00	
(6120, 6220, 6320, 6420 ASN 494915), 7220, 7320	Suspension Rod Replaces AL157453, AL160479	AMAL171754	\$ 166.50	
7630, 7720, 7730, 7820, 7830, 7920, 7930 - w/ Triple Link Suspension	Suspension Rod Replaces RE182881	AMRE288103	\$ 166.00	
 6110, 6120, 6210, 6220, 6310, 6320, 6410, 6420, 7220, 7320, 7420, 7520, 7610, 7710, 7810	Shear Pin 92.60 mm Long, 25 mm Diameter	AML114112	\$ 25.00	
 6110, 6120, 6210, 6220, 6310, 6320, 6410, 6420, 7220, 7320, 7420, 7520, 7610, 7710, 7810	Shear Pin 95 mm Long, 30 mm Diameter	AML154263	\$ 30.00	
 6110, 6120, 6210, 6220, 6310, 6320, 6410, 6420, 7220, 7320, 7420, 7520, 7610, 7710, 7810	Shear Pin 104 mm Long, 25 mm Diameter	AML114113	\$ 30.00	
 6110, 6120, 6210, 6220, 6310, 6320, 6410, 6420, 7220, 7320, 7420, 7520, 7610, 7710, 7810	Shear Pin 107.60 mm Long, 30 mm Diameter	AML114111	\$ 30.00	
 5045E, 5055D, 5055E, 5065E, 5075E, 5103, 5203, 5215, 5225, 5315, 5325, 5403, 5415, 5425, 5503, 5525, 5603, 5605, 5615, 5625, 5705, 5715 - w/ DANA® MFWD	Hub Assembly w/ Knuckle, Right Hand Includes AMX41131 Hub Assembly, AMR271409 Right Hand Steering Knuckle and King Pins	AMX41132	\$ 2950.00	
	Hub Assembly w/ Knuckle, Left Hand Includes AMX41131 Hub Assembly, AMR271410 Left Hand Steering Knuckle and King Pins	AMX41133	\$ 2950.00	
 5045E, 5055D, 5055E, 5065E, 5075E, 5103, 5203, 5215, 5225, 5315, 5325, 5403, 5415, 5425, 5503, 5525, 5603, 5605, 5615, 5625, 5705, 5715 - w/ MFWD	Hub Assembly	AMX41131	\$ 2000.00	
 5045E, 5055E, 5065E, 5065M, 5075E, 5075M, 5076E, 5082E, 5083E, 5085E, 5085M, 5090E, 5090EH Hi-Clearance, 5093E, 5095M, 5095MH, 5100E, 5100M, 5100MH, 5100ML, 5101E, 5103 ASN 10340, 5105M, 5105ML, 5115M, 5115ML, 5203 ASN 005569, 5225, 5303 ASN 007751, 5325, 5403 ASN 001357, 5415, 5415H, 5425, 5525, 5603, 5605 SN 080729-090475, 5615, 5625, 5705 ASN 080729, 5715, 5715HC, 5725 ASN 005048	Hub Assembly	AMRE271425	\$ 440.00	
 (8100, 8200, 8300, 8400 Axle BSN 022786)	Hub Assembly w/ Fine Thread Nut	AMX41128	\$ 3450.00	
 (8100, 8200, 8300, 8400 Axle SN 035804-77515)	Hub Assembly w/ Coarse Thread Nut	AMX41127	\$ 3450.00	
 (8100, 8200, 8300, 8400 Axle ASN 800001), 8110, 8210, 8310, 8410	Hub Assembly	AMX41126	\$ 3450.00	
 940, 1040, 1140, 1640, 1840, 2040 BSN 429999, 2150, Utility: 2240 ASN 350000	Steering Knuckle, Right Hand	AML35604	\$ 270.00	
	Steering Knuckle, Left Hand	AML35603	\$ 270.00	

Prices Subject to Change without Prior Notice. The use of original equipment manufacturer (OEM) part numbers or trademarks, e.g. Case® and John Deere®, are for reference purposes only and for indicating product use and compatibility. Our company and the listed replacement parts contained herein are not sponsored, approved or manufactured by the OEM. All parts are New unless designated Reman in the description.









John Deere®—Tractor

Mechanical Front Wheel Drive Parts





Application	Description	Part Number	Retail Price	Core
1640, 2040, 2350, 2355, 2550, 2555 - w/ APL325 Axles	Steering Knuckle, Right Hand Replaces L40269	AML61202	\$ 756.00	
	Steering Knuckle, Left Hand Replaces L40268	AML61201	\$ 756.00	
 2750 w/ APL345 Axle ASN 024905, 2950 w/ Axle ASN 026316, 3055, 3155, 3255	Steering Knuckle, Right Hand	AML41926	\$ 575.00	
	Steering Knuckle, Left Hand	AML41927	\$ 575.00	
 5045E, 5055E, 5065E, 5065M, 5075E, 5075M, 5076E, 5082E, 5083E, 5085E, 5085M, 5090E, 5090EH Hi-Clearance, 5093E, 5095M, 5095MH, 5100E, 5100M, 5100MH, 5100ML, 5101E, 5103 ASN 013640, 5105M, 5105ML, 5115M, 5115ML, 5203 ASN 005569, 5225, 5303 ASN 007751, 5325, 5403 ASN 001357, 5415, 5415H, 5425, 5525, 5603, 5605 SN 080729-090475, 5615, 5625, 5705 ASN 080729, 5715, 5715HC, 5725 ASN 005048	Steering Knuckle, Right Hand	AMR271409	\$ 600.00	
	Steering Knuckle, Left Hand	AMR271410	\$ 600.00	
6100D, 6105D, 6105E, 6110D, 6115D, 6120, 6120E, 6120L, 6125D, 6130D, 6135E, 6140D, 6215, 6220, 6220L, 6230, 6320, 6320L, 6330, 6403, 6415, 6420, 6420L, 6430, 6603	Steering Knuckle, Right Hand Replaces L157614	AML157636	\$ 1000.00	
	Steering Knuckle, Left Hand Replaces L157615	AML157637	\$ 1000.00	
6105M, 6105R, 6110M, 6110R, 6115M, 6115R, 6120M, 6120R, 6125M, 6125R, 6130M, 6130R	Steering Knuckle, Right Hand w/o Front Wheel Brakes Replaces L209643	AML212745	\$ 1100.00	
	Steering Knuckle, Left Hand w/o Front Wheel Brakes Replaces L209642	AML212744	\$ 1100.00	
6105M, 6105R, 6110M, 6110R, 6115M, 6115R, 6120M, 6120R, 6125M, 6125R, 6130M, 6130R, 6140M	Steering Knuckle, Right Hand w/ Front Wheel Brake	AML212747	\$ 1100.00	
	Steering Knuckle, Left Hand w/ Front Wheel Brake Replaces L212746	AML220665	\$ 1100.00	
 6110, 6110L, 6120, 6120L, 6200, 6200L, 6210, 6210L, 6215, 6220, 6220L, 6300, 6300L, 6310, 6310L, 6310S, 6320, 6320L, 6400, 6400L, 6405, 6410, 6410L, 6410S, 6415, 6420, 6420L, 6500, 6500L, 6510L, 6510S, 6520L	Steering Knuckle, Right Hand Replaces L100235	AML114786	\$ 1650.00	
	Steering Knuckle, Left Hand	AML114787	\$ 1650.00	
 6110L, 6200, 6200L, 6300, 6300L, 6310L, 6400, 6400L, 6410L, 6500, 6500L, 6510L	Steering Knuckle, Right Hand	AML100233	\$ 1125.00	
	Steering Knuckle, Left Hand	AML100234	\$ 1125.00	
 6140R, 6145R, 6150M, 6150R, 6150RH, 6155R, 6155RH, 6170M, 6170R, 6175R, 6615, 6715, 7220, 7320, 7330, 7420, 7515, 7520	Steering Knuckle, Right Hand	AML157366	\$ 375.00	
	Steering Knuckle, Left Hand	AML157368	\$ 375.00	
 6140J, 6155J, 6605, 6615, 7210, 7220, 7320, 7410, 7510	Steering Knuckle, Right Hand	AML110474	\$ 1125.00	
	Steering Knuckle, Left Hand	AML110473	\$ 1125.00	
 6615, 6715, 7130, 7220, 7230, 7320, Premium Models: 6630, 7130, 7230	Steering Knuckle, Right Hand	AML171449	\$ 1250.00	
	Steering Knuckle, Left Hand	AML171448	\$ 1250.00	
 7430, 7530	Steering Knuckle, Right Hand	AML171988	\$ 1750.00	
	Steering Knuckle, Left Hand	AML171987	\$ 1000.00	

John Deere®—Tractor



Mechanical Front Wheel Drive Parts

Application	Description	Part Number	Retail Price	Core
 Utility: 3120, 3203, 3320, 3520, 3720, 4105 BSN 710091, (4120, 4320, 4520, 4720 - w/ LVA10679 Wheel End Assembly), (4200, 4300, 4400 - w/ Axle Marked S20BZ107-1), 4210, 4310, 4410, (4500, 4600, 4700 - w/ Axle Marked S20BZ108-1 or S20BZ112-1), 4510 w/ PowrReverser™ Transmission, (4610 w/ Hydro or PowrReverser™ Transmission and w/ Axle Marked S20BZ107-1), 4710	Steering Knuckle, Right Hand	AMLVA10672	\$ 575.00	
	Steering Knuckle, Left Hand	AMLVA10671	\$ 750.00	
Utility: 4044M, 4044R, 4049M, 4049R, 4052M, 4052R, 4066M, 4066R	Steering Knuckle, Right Hand	AMLVU30596	\$ 2400.00	
	Steering Knuckle, Left Hand	AMLVU30595	\$ 2400.00	
 4050, 4250, 4450	ZF Steering Knuckle, Right Hand	AMR83520	\$ 900.00	
 4050, 4250, 4450	ZF Steering Knuckle, Left Hand	AMR83521	\$ 900.00	
 6140R, 6145M, 6145R, 6150M, 6150R, 6155M, 6155R, 6155RH, 6170M, 6170R, 6175M, 6175R, 6190R, 6195M, 6195R, 6210R, 6215R, 6615, 6715, 7130, 7220, 7230, 7320, 7330, 7420, 7430, 7520, 7530	Knuckle Driveshaft Seal	AMAL160535	\$ 26.00	
 6050M, 6140R, 6145M, 6145R, 6150R, 6150RH, 6155R, 6155RH, 6170M, 6170R, 6175M, 6175R, 6190R, 6195M, 6210R, 6215R, 6615, 6715, 7220, 7320, 7330, 7420, 7430, 7520, 7530 - w/ AL173216 and AL173218 Front Axle	Trunnion Assembly	AMAL172488	\$ 100.00	
6100D, 6105D, 6105E, 6105M, 6105R, 6110D, 6110M, 6110R, 6115D, 6115M, 6155R, 6120E, 6120M, 6120R, 6125D, 6125M, 6125R, 6130D, 6130M, 6130R, 6135E, 6140D, 6140M	Trunnion Assembly Use w/ AL210982, AL210985, AL210986, AL213670 and AL213671 Front Axles	AMAL209993	\$ 75.00	
 5045E, 5055E, 5065E, 5065M, 5075E, 5075M, 5076E, 5082E, 5083E, 5085M, 5090E, 5090EH Hi-Clearance, 5093E, 5095M, 5095MH, 5100E, 5100M, 5100MH, 5100ML, 5101E, 5103 ASN 013640, 5105M, 5105ML, 5115M, 5115ML, 5203 ASN 005569, 5225, (5303, 5403 ASN 001357), 5325, 5415, 5415H, 5525, 5603, 5615, 5625, 5715, 5715HC, 5725 ASN 005048	Trunnion, Upper	AMR271394	\$ 70.00	
 5045E, 5055E, 5065E, 5065M, 5075E, 5075M, 5076E, 5082E, 5083E, 5085M, 5090E, 5090EH Hi-Clearance, 5093E, 5095M, 5095MH, 5100E, 5100M, 5100MH, 5100ML, 5101E, 5103 ASN 013640, 5105M, 5105ML, 5115M, 5115ML, 5203 ASN 005569, 5225, (5303, 5403 ASN 001357), 5325, 5415, 5415H, 5525, 5603, 5615, 5625, 5715, 5715HC, 5725 ASN 005048	Trunnion, Lower	AMR271408	\$ 50.00	
5065M, 5075M, 5085M, 5095M, 5225, 5325, 5425, 5525, 5605, 5625, 5705	Trunnion, Upper	AMR282358	\$ 82.50	
	Trunnion, Lower	AMR282359	\$ 95.50	
 940, 1040, 1140, 1640, 1840, 2040, 2150, Utility: 2240 ASN 350000 - All w/ ZF Axle	Trunnion	AML35606	\$ 30.00	
6110, 6120L, 6120, 6200, 6200L, 6205, 6210, 6215, 6220, 6220L, 6300, 6300L, 6310, 6320L, 6400, 6400L, 6405, 6410, 6415, 6420L, 6500, 6500L, 6505, 6520L	Trunnion Replaces L100237, T188397	AMT151074	\$ 45.00	

John Deere®—Tractor







Application	Description	Part Number	Retail Price	Core
 6140R, 6145M, 6145R, 6150M, 6150R, 6150RH, 6155M, 6155R, 6155RH, 6170M, 6170R, 6175M, 6175R, 6190R, 6195M, 6195R, 6210R, 6215R, 6230R, 6250R, 6615, 6715, 7220, 7320, 7330, 7420, 7430, 7520, 7530, Premium Models: 7330, 7430, 7530	Trunnion Replaces L218739	AMAL160525	\$ 225.00	
 6150R, 6150RH, 6155R, 6155RH, 6175M, 6175R, 6190R, 6195M, 6195R, 6210R, 6215R, 7430, 7530	Trunnion	AMAL175786	\$ 220.00	
 6505, 6506, 6510, 6515, 6520, 6600, 6605, 6610, 6615, 6620, 6715, 6800, 6810, 6820, 7210, 7220, 7320, 7405, 7410, 7420, 7425, 7500, 7520, 7525, SE6510, SE6520, SE6610	Trunnion	AML112110	\$ 45.00	
7210, 7410, (7420, 7520 - w/ Hi-Crop), 7510, 7610 w/ Axle SN 000001-000999 & ASN 800000, (7710, 7810 BSN 090000 w/ Axle SN 000001-000999 & ASN 800000 or ASN 089999 w/ Any Axle), 7720, 7820, 7920	Trunnion, Upper Trunnion, Lower	AMRE71096 AMRE67161	\$ 127.75 \$ 119.19	
7600, 7610, 7700, 7710, 7800, 7810, 8100, 8200, 8300, 8400	Trunnion w/ Bearing Replaces R106674, R126390	AMRE63382	\$ 99.91	
 6110, 6110L, 6120, 6120L, 6140J, 6155J, 6200, 6200L, 6210, 6210L, (6215, 6415 - w/ AS2025/AS2035 Front Axle), 6220, 6220L, 6300, 6300L, 6310, 6310L, 6310S, 6320, 6320L, 6400, 6400L, 6403, 6405, 6410, 6410L, 6410S, 6420, 6420L, 6500, 6510S, 6520L, 6603, 6605, (6615, 6715 - w/ AS2045 Front Axle), (7210, 7410 ASN 052869 w/o Hi-Crop), (7220, 7320 BSN 002761), 7405 w/ APL2045 Front Axle	Trunnion Bearing Replaces AH65358	AMAL79901	\$ 16.92	

MFWD Hub Components

Application	Description	Part Number	Retail Price	Core
6100D, 6100M, 6105D, 6105E, 6105M, 6105R, 6110D, 6110R, 6115D, 6115R, 6120, 6120E, 6120L, 6120R, 6125D, 6125M, 6125R, 6130D, 6130M, 6130R, 6135E, 6140D, 6155M, 6215, 6220, 6220L, 6230, 6320, 6320L, 6330, 6403, 6415, 6420, 6420L, 6430, 6603	Hub	AML157622	\$ 205.00	
 6110, 6110L, 6120, 6120L, 6200, 6200L, 6210, 6210L, 6220, 6220L, 6300, 6300L, 6303, 6310, 6310L, 6310S, 6320, 6320L, 6400, 6400L, 6403, 6405, 6410, 6410L, 6410S, 6420, 6420L, 6500, 6500L, 6510L, 6510S, 6520L	Hub	AML100238	\$ 530.00	
 6140R, 6145R, 6150M, 6150R, 6150RH, 6155R, 6155RH, 6170M, 6170R, 6175R, 6195R, 6615, 6715, 7130, 7220, 7230, 7320, 7330, 7420, 7520	Hub	AML166396	\$ 595.00	
 (1640, 2040, 2040S, 2140, 3040, 3140 ASN 430000), 2350, 2355, 2355N, 2550, 2555, 2750, 2755, 2950, 2988 BSN 767516, 3055, 3150, 3155, 3255, 6110, 6110L, 6120, 6120L, 6200, 6200L, 6210, 6210L, 6215, 6220, 6220L, 6300L, 6310L, 6320L, 6400L, 6403, 6405, 6410L, 6415, 6420L, 6510L, 6603, Utility: 2155	Cylindrical Roller Bearing Replaces VPJ2550	AMJD10250	\$ 45.00	









John Deere®—Tractor

Mechanical Front Wheel Drive Parts

Application	Description	Part Number	Retail Price	Core
5103 BSN 013640, 5105 ASN 411494, 5203 BSN 005569, 5205 ASN 421397, 5220 ASN 420010 w/ Collar Shift Transmission, (5225, 5325 w/ CA148777 Axle), 5303 BSN 007752, 5320 ASN 430008, 5403 BSN 001357, 5420 ASN 440014 w/ Collar Shift Transmission w/o Hi-Crop, 5425 w/o Hi-Crop, 5520 ASN 450004 w/ Collar Shift Transmission w/o Hi-Crop, 5525 w/ CA148777 Axle or w/ CA148518 Axle w/o Hi-Crop, 5603 - All w/ Carraro™ Front Axle	Wheel Hub Seal	AMRE204870	\$ 57.14	
(4050, 4250, 4450 - w/ John Deere® Axle), 4055, 4255, 4455, 7600, 7610, 7810 w/ Axle SN 001001-07523, 7700, 7710 ASN 089999 or BSN 090000 w/ Axle SN 001001-075235, 7720, 7800, 7820, 7920	Final Drive Hub	AMR88213	\$ 261.60	
5045E, 5055E, 5065E, 5065M, 5075E, 5075M, 5076E, 5082E, 5083E, 5085E, 5085M, 5090E, 5090EH Hi-Clearance, 5093E, 5095M, 5095MH, 5100E, 5100M, 5100MH, 5100ML, 5101E, 5103 ASN 10340, 5105M, 5105ML, 5115M, 5115ML, 5203 ASN 005569, 5225, 5303 ASN 007751, 5325, 5403 ASN 001357, 5415, 5415H, 5425, 5525, 5603, 5605 SN 080729-090475, 5615, 5625, 5705 ASN 080729, 5715, 5715HC, 5725 ASN 005048, 6100D, 6105D, 6105E, 6105M, 6105R, 6110D, 6110M, 6110R, 6115D, 6115M, 6115R, 6120, 6120E, 6120L, 6120M, 6120R, 6125D, 6125M, 6125R, 6130D, 6130M, 6130R, 6135E, 6140D, 6140M, 6220, 6220L, 6230, 6320, 6320L, 6330, 6403, 6420, 6420L, 6430, 6520L, 6603	Final Drive Hub Replaces L157618, L157638, R271414	AML174121	\$ 260.00	
 7210, 7330 Premium, 7410, 7420, 7510, 7520, 7610, 7710, 7720, 7810, 7820, 7920, 8100, 8110, 8200, 8210, 8300, 8310, 8400, 8410	Final Drive Hub	AMR99499	\$ 325.00	
2750, 2755 - w/ APL 735 Axle	Final Drive Pinion Replaces T116830	AML60111	\$ 204.00	
 7200R, 7210, 7210R, 7215R, 7230R, 7250R, 7260R, 7270R, 7280R, 7330 Premium, 7410, 7420, 7510, 7610, 7630, 7710, 7720, 7730, 7810, 7815, 7820, 7830, 7920, 7930, 8100, 8110, 8120, 8130, 8200, 8210, 8220, 8225R, 8230, 8235R, 8245R, 8260R, 8270R, 8285R, 8300, 8310, 8320, 8330, 8400, 8410	Final Drive Pinion	AMR121282	\$ 170.00	
 7200R, 7210, 7215R, 7280R, 7410, 7420, 7510, 7610, 7710, 7720, 7810, 7820, 7920, 8100, 8110, 8120, 8200, 8210, 8220, 8225R, 8235R, 8245R, 8260R, 8270R, 8285R, 8300, 8310, 8320, 8400, 8410	Final Drive Pinion Replaces R104755	AMR130078	\$ 140.00	
 6140J, 6155J, 7505, 7510	Final Drive Ring Gear	AML116103	\$ 395.00	
 6140R, 6145R, 6150M, 6150R, 6170M, 7130, 7230, 7330	Final Drive Ring Gear	AML204842	\$ 375.00	
6605, (6615, 6715, 7220, 7320, 7405, 7500 - w/ AS2045 Front Axle), (7210, 7410 - w/ 52869 Front Axle)	Final Drive Ring Gear 80 & 55 Spline	AML101724	\$ 413.00	
 8100, 8110, 8200, 8210, 8300, 8310, 8400, 8410	Final Drive Ring Gear	AMR156869	\$ 295.00	











John Deere®—Tractor

Mechanical Front Wheel Drive Parts













	Application	Description	Part Number	Retail Price	Core
	(8100, 8200, 8300, 8400 BSN 077515)	Final Drive Shaft Replaces R100246	AMR131740	\$ 150.00	
	940, 1040, 1140, 1640, 1840, 2040 BSN 429999, 2150, Utility: 2240 ASN 350000	Front Axle	AMAL33349	\$ 200.00	
	7210R, 7215R, 7230R, 7250R, 7260R, 7270R, 7280R, 7290R, (8100, 8200, 8300, 8400 ASN 80001), 8110, 8120, 8210, 8220, 8225R, 8235R, 8245R, 8260R, 8270R, 8285R, 8295R, 8310, 8320, 8410, 8420, 8520	Flange Assembly	AMR135866	\$ 530.00	
	7430, 7530	Flange Assembly	AML171991	\$ 200.00	
	5045D, 5045E, 5055D, 5055E, 5065E, 5065M, 5075E, 5075M, 5085E, 5085M, 5090E, 5090EL, 5090M, 5090R, 5100E, 5100M, 5100MH, 5100ML, 5100R, 5103, 5105M, 5105ML, 5115ML, 5115R, 5125ML, 5125R, 5203, 5303, 5403, 6105D, 6105M, 6105R, 6110M, 6110R, 6115D, 6115M, 6115R, 6120, 6120L, 6120M, 6120R, 6125M, 6125R, 6130D, 6130M, 6130R, 6140D, 6140J, 6140M, 6140R, 6145M, 6145R, 6150M, 6150R, 6150RH, 6155J, 6155M, 6155R, 6155RH, 6170M, 6170R, 6175R, 6195R, 6215, 6220, 6220L, 6230, 6320, 6320L, 6330, 6403, 6415, 6420, 6420L, 6430, 6520L, 6603, 6615, 6715, 7130, 7230, 7330	Seal 0.03" Wide, 5.90" ID, 7.08" OD	AMAL159594	\$ 40.00	
	5045E, 5055E, 5065E, 5065M, 5075E, 5075M, 5076E, 5082E, 5083E, 5085E, 5085M, 5090E, 5090EH Hi-Clearance, 5093E, 5095M, 5095MH, 5100E, 5100M, 5100MH, 5100ML, 5101E, 5103 ASN 013640, 5105M, 5105ML, 5115M, 5115ML, 5203 ASN 005569, 5225, 5303 ASN 007751, 5325, 5403 ASN 001357, 5415, 5415H, 5425, 5525, 5603, 5605 SN 080729-090475, 5615, 5625, 5705 ASN 080729, 5715, 5715HC, 5725 ASN 005048	Planetary Pinion Includes Bearing and Snap Ring	AMRE271426	\$ 150.00	
	6100D, 6105D, 6105E, 6105M, 6105R, 6110D, 6110R, 6115D, 6115M, 6120, 6120E, 6120L, 6120R, 6125D, 6130D, 6135E, 6140D, 6215, 6220, 6220L, 6230, 6320, 6320L, 6330, 6415, 6420, 6420L, 6430, 6520L, 7200, 7250, 7280, 7300, 7350, 7380, 7400, 7450, 7480, 7500, 7550, 7580, 7700, 7750, 7780, 7800, 7850, 7950, 7980, 8100, 8200, 8300, 8400, 8500, 8600, Forage Harvester: 7180	Planetary Pinion Includes Bearing and Snap Ring Replaces AL209977	AMAL163468	\$ 120.00	
	5045E, 5055E, 5065E, 5065M, 5075E, 5075M, 5076E, 5082E, 5083E, 5085E, 5090E, 5090EH Hi-Clearance, 5093E, 5095M, 5095MH, 5100E, 5100M, 5100MH, 5100ML, 5101E, 5103 ASN 013640, 5105M, 5105ML, 5115ML, 5203 ASN 005569, 5225, 5303 ASN 007751, 5325, 5403 ASN 001357, 5415, 5415H, 5425, 5525, 5603, 5605 SN 080729-090475, 5615, 5625, 5705 ASN 080729, 5715, 5715HC, 5725 ASN 005048	Carrier Flange Assembly w/ Planetary Gears	AMRE271421	\$ 950.00	

John Deere®—Tractor

Mechanical Front Wheel Drive Parts









Application	Description	Part Number	Retail Price	Core
5045E, 5055E, 5065E, 5065M, 5075E, 5075M, 5076E, 5082E, 5083E, 5085E, 5085M, 5090E, 5090EH Hi-Clearance, 5093E, 5095M, 5095MH, 5100E, 5100M, 5100MH, 5100ML, 5101E, 5103 ASN 013640, 5105M, 5105ML, 5115M, 5115ML, 5203 ASN 005569, 5225, 5303 ASN 007751, 5325, 5403 ASN 001357, 5415, 5415H, 5425, 5525, 5603, 5605 SN 080729-090475, 5615, 5625, 5705 ASN 080729, 5715, 5715HC, 5725 ASN 005048	Planetary Pinion Carrier	AMR271422	\$ 340.00	
 5200, 5210, 5220, 5300, 5310, 5320, 5400, 5410, 5420, 5500, 5510, 5520, 5615, 5715	Planetary Pinion Carrier Replaces 81879351	AMRE45942	\$ 531.62	
6100D, 6105D, 6110D, 6115D, 6120, 6120E, 6120L, 6125D, 6130D, 6140D, 6215, 6220, 6220L, 6230, 6320, 6320L, 6330, 6403, 6415, 6420, 6420L, 6430, 6520L, 6603, 7250, 7280, 7350, 7380, 7450, 7480, 7550, 7580, 7750, 7780, 7850, 7980, 8100, 8200, 8300, 8400, 8500, 8600, Forage Harvester: 7180	Planetary Pinion Carrier	AML166299	\$ 335.00	
6110R, 6120R, 6125R, 6130R, 6230L, 6320, 6320L, 6330, 6420, 6420L, 6430, 6520L	Planetary Pinion Carrier	AML166474	\$ 415.00	
 6140R, 6145R, 6150M, 6150R, 6150RH, 6155R, 6155RH, 6170M, 6615, 6715, 7130, 7220, 7230, 7320, 7330, 7420	Planetary Pinion Carrier	AML156890	\$ 420.00	
 6140R, 6145R, 6150M, 6150R, 6150RH, 6155R, 6155RH, 6170M, 7130, 7230, 7330	Planetary Pinion Carrier Replaces L156883	AML173479	\$ 130.00	
 6150R, 6150RH, 6155R, 6155RH, 6190R, 6195R, 6210R, 6215R, 7430, 7530	Planetary Pinion Carrier	AML171994	\$ 1310.00	
 6150R, 6150RH, 6155R, 6155RH, 6170M, 6175R, 6190R, 6195R, 6210R, 6215R, Premium Models: 7430, 7530 - w/ Planetary Drive MFWD Axle w/o Front Wheel Brake	Planetary Pinion Carrier	AML171993	\$ 250.00	
 6110, 6110L, 6120, 6120L, 6200, 6200L, 6210, 6210L, 6215, 6220, 6220L, 6300, 6300L, 6310, 6320L, 6400, 6400L, 6405, 6410, 6410L, 6415, 6420L, 6500, 6500L, 6510L, 6520L	Planetary Pinion Carrier	AML100168	\$ 885.00	
 7420, 7520, Premium Model: 7330	Planetary Pinion Carrier	AML166666	\$ 2250.00	
 7210, 7330 Premium, 7410, 7420, 7510, 7610, 7710, 7720, 7810, 7820, 7920, 8100, 8110, 8120, 8200, 8210, 8220, 8300, 8310, 8320, 8400, 8410	Planetary Pinion Carrier Replaces R104755, R183792, RE556204	AMR296945	\$ 740.00	
 2140 ASN 4300000, 2750, 2950, 2955, 3040, 3055, 3140 ASN 4300000, 3150, 3155, 3255	Planetary Pinion Gear	AML39994	\$ 140.00	
2040 ASN 349999, 2150, Utility: 2240 ASN 349999	Planetary Pinion Gear 26 Tooth Replaces 3230261R1, L35588	AMZP1927562	\$ 157.70	
 2350, 2355, 2550, 2555, 2650, 2855, Utility: 2155	Planetary Pinion Gear	AML40028	\$ 125.00	
 6605, 6615, 6715, 7210, 7220, 7320, 7410, 7510, Utility: 3320	Planetary Pinion Gear 30 Tooth	AML114784	\$ 185.00	

John Deere®—Tractor







	Application	Description	Part Number	Retail Price	Core
	6120L, 6220L, 6300, 6320, 6400, 6400L, 6403, 6420, 6500, 6500L, 6603	Planetary Pinion Gear	AML100241	\$ 120.00	
	6140R, 6145M, 6145R, 6150M, 6150R, 6150RH, 6155M, 6155R, 6155RH, 6170M, 7130, 7230, 7420, 7520	Planetary Pinion Gear Replaces L156865	AML166395	\$ 200.00	
	6150R, 6150RH, 6155R, 6155RH, 6170M, 6170R, 6175R, 6190R, 6195R, 6210R, 7430, 7530 - w/ Planetary Drive MFWD Axle w/o Front Wheel Brake	Planetary Pinion Gear	AML171989	\$ 260.00	
	(4050, 4250, 4450 - w/ John Deere® Axle), 4055, 4255, 4455, 7200, (7210, 7410, 7610 - w/ Axle SN 001001-075235), 7400, 7600, 7700, (7710, 7810 ASN 089000 or BSN 090000 w/ Axle SN 001001-075235), 7720, 7800, 7820, 7920	Planetary Pinion Gear 24 Tooth, 2.35" ID, 3.592" Major OD, 3.008" Minor OD Replaces R88210	AMR100249	\$ 125.00	
	6100, 6110, 6110L, 6120, 6120L, 6200, 6200L, 6205, 6210, 6210L, 6215, 6220, 6220L, 6300L, 6310L, 6320L, 6400L, 6410L, 6415, 6420L - w/ APL2025 Front Axle	Planetary Pinion Gear	AML110237	\$ 95.00	
	7210, 7410, 7510, 7610, 7710, 7720, 7810, 7820, 7920	Planetary Pinion Gear	AMR169917	\$ 120.00	
	Utility: 4044M, 4044R, 4049M, 4049R, 4052M, 4052R, 4066M, 4066R	Driveshaft Assembly, Right Hand	AMLVU27457	\$ 125.00	
		Driveshaft Assembly, Left Hand	AMLVU27456	\$ 125.00	
	2140 ASN 4300000, 2750, 2950, 2955, 3040, 3055, 3140 ASN 4300000, 3150, 3155, 3255 - w/ APL345 or APL350 Front Axle	Planetary Pinion Shaft	AML41123	\$ 75.00	
	2350, 2355, 2550, 2555, 2650, 2855, Utility: 2155 - All w/ ZF Axle	Planetary Pinion Shaft	AML40029	\$ 95.00	
	6100, 6100L, 6110, 6110L, 6120, 6120L, 6200, 6200L, 6205, 6210, 6210L, 6215, 6215, 6220, 6220L, 6300, 6300L, 6310, 6310L, 6320L, 6400, 6400L, 6405, 6410, 6410L, 6415, 6420L, 6500, 6500L, 6510L, 6520L - w/ APL2025 Front Axle	Planetary Pinion Shaft	AML110236	\$ 95.00	
	(4050, 4250, 4450 - w/ John Deere® Axle), 4055, 4255, 4455, 7610 SN 001001-075235, 7700, (7710, 7810 BSN 090000 w/ Axle SN 001001-075235 or All ASN 089999), 7800	Planetary Pinion Shaft	AMR124091	\$ 195.00	
	6140J, 6155J, 7505, 7510, 7610, 7710, 7810	Planetary Pinion Shaft	AML116104	\$ 285.00	
	(7210, 7410, 7510 - w/ Axle SN 000001-000999 & 800001-820944), 7610, 7810	Planetary Pinion Shaft	AMR130077	\$ 190.00	
	6605, (6615, 6715 - w/ Axle AS2045), (7210, 7410 ASN 052868, ZF Axle w/o Hi-Crop), (7220 7320 BSN 002762)	Bearing, Planetary Pinion Shaft	AMVPH4213	\$ 20.42	
	4555, 4560, 4650, 4755, 4760, 4850, 4955, 4960, 6140J, 6155J, 7200R, 7210, 7210R, 7215R, 7230R, 7250R, 7260R, 7270R, 7290R, 7330P, 7410, 7420, 7510, 7520, 7610, 7710, 7720, 7810, 7820, 7920, 8100, 8110, 8120, 8200, 8210, 8220, 8225R, 8235R, 8245R, 8260R, 8270R, 8285R, 8295R, 8300, 8310, 8320, 8400, 8410, 8420, 8520	Retainer	AMR92871	\$ 31.00	

John Deere®—Tractor



Mechanical Front Wheel Drive Parts

Application	Description	Part Number	Retail Price	Core
 6140J, 6155J, 7330P, 8120, 8220, 8320, 8420, 8520	Retainer Replaces R124404, R543207	AMR171858	\$ 90.00	
 5045E, 5055E, 5065E, 5065M, 5075E, 5075M, 5076E, 5082E, 5083E, 5085E, 5085M, 5090E, 5090EH Hi-Clearance, 5093E, 5095M, 5095MH, 5100E, 5100M, 5100MH, 5100ML, 5101E, 5103 ASN 010340, 5105M, 5105ML, 5115M, 5115ML, 5203 ASN 005569, 5225, 5303 ASN 007751, 5325, 5403 ASN 001357, 5415, 5415H, 5425, 5525, 5603, 5605 SN 080729-090475, 5615, 5625, 5705 ASN 080729, 5715, 5715HC, 5725 ASN 005048	Ring Gear Kit Includes Hub, Ring Gear and Snap Ring	AMRE271423	\$ 450.00	
2140 ASN 430000, 2750, 2755 - w/ APL 745 Axle	Ring Gear 48 & 88 Tooth Replaces 4472363001, F168302020400, VPJ7911	AML60105	\$ 496.00	
 (2140, 3140 ASN 430000), 2750, 2950, 2955, 3040, 3055, 3150, 3155, 3255	Ring Gear 90 Tooth	AML40010	\$ 420.00	
 2350, 2355, 2550, 2555, 2650, 2855, Utility: 2155	Ring Gear	AML40043	\$ 395.00	
 (4050, 4250, 4450 - w/ John Deere® Axle), 4055, 4255, 4455, 7600, 7610 w/ Axle SN 001001-075235, 7700, (7710, 7810 BSN 090000 w/ Axle SN 001001-075235 or ASN 089999 w/o Standard or Hi-Crop), 7800	Ring Gear	AMR88212	\$ 325.00	
5200, 5210, (5220 BSN 420011, 5320 BSN 430009, 5420 BSN 440015, 5520 BSN 450005 - w/ Collar Shift Transmission), 5300, 5310, 5400, 5410, 5500, 5510	Ring Gear 60 Tooth	AMR113991	\$ 385.42	
 5045E, 5055E, 5065E, 5065M, 5075E, 5075M, 506E, 5082E, 5083E, 5085E, 5085M, 5090E, 5090EH Hi-Clearance, 5093E, 5095M, 5100E, 5100M, 5100MH, 5101E, 5103 ASN 013640, 5105M, 5105ML, 5115M, 5115ML, 5203 ASN 005569, 5225, 5303 ASN 007751, 5325, 5403 ASN 001357, 5415, 5415H, 5425, 5525, 5603, 5605 ASN 080729-090475, 5615, 5625, 5705 ASN 080729, 5715, 5715HC, 5725 ASN 005048, 6105M, 6105R, 6110M, 6110R, 6115M, 6115R, 6120M, 6120R, 6125M, 6125R, 6130M, 6130R	Ring Gear	AMR271413	\$ 425.00	
 6010, 6020, 6110, 6110L, 6120, 6120L, 6210, 6210L, 6220, 6220L, 6300, 6300L, 6310, 6310L, 6310S, 6320, 6400, 6400L, 6400SP, 6403, 6405, 6410, 6410L, 6410S, 6420, 6500, 6500L, 6510L, 6510S, 6603, SE6010, SE6020, SE6110, SE6120, SE6210, SE6220, SE6310, SE6320, SE6410, SE6420	Ring Gear	AML79729	\$ 425.00	
 6100, 6200 BSN 124984	Ring Gear	AML100166	\$ 450.00	
 6100D, 6100R, 6105E, 6110D, 6110M, 6115D, 6120E, 6120M, 6120R, 6125D, 6130D, 6130M, 6130R, 6135E, 6230, 6330, 6430, 7280, 7380, 7480, 7580, 7780, 7980, 8100, 8200, 8300, 8400, 8500, 8600, Forage Harvester: 7180	Ring Gear Replaces L157619, L174120	AML204840	\$ 250.00	

John Deere®—Tractor

Application	Description	Part Number	Retail Price	Core
 6110, 6120L, 6120, 6200, 6200L, 6205, 6210, 6215, 6220, 6220L, 6300, 6300L, 6310, 6320L, 6400, 6400L, 6405, 6410, 6415, 6420L, 6500, 6500L, 6505, 6520L	Ring Gear	AML110235	\$ 395.00	
 6150R, 6150RH, 6155R, 6155RH, 6170M, 6170R, 6175M, 6175R, 6190R, 6195M, 6195R, 6210R, 6215R, 7430, 7530 - w/ Planetary Drive MFWD Axle w/o Front Wheel Brake	Ring Gear	AML204844	\$ 320.00	
 7210, 7410, 7510, 7710, 7720, 7810, 7820, 7920	Ring Gear	AMR130071	\$ 445.00	
 6110, 6120L, 6220L, (6300, 6400, 6500 ASN 124984), 6300L, 6310L, 6310S, 6400L, 6403, 6405, 6410, 6410L, 6410S, 6500L, 6510L, 6510S, 6603	Sun Gear 22 Tooth, 16 Spline	AML110240	\$ 165.00	
 6200, 6300, 6400, 6500	Sun Gear	AML100167	\$ 115.00	
 6605, 6615, 6715, 7210, 7220, 7320, 7410, 7510 - w/ APL2045 Front Axle	Sun Gear 24 Tooth, 16 Spline	AML101650	\$ 85.00	



MFWD Differentials and Components

Application	Description	Part Number	Retail Price	Core
 5045E, 5055D, 5055E, 5065E, 5075E, 5103, 5203, 5215, 5225, 5315, 5325, 5403, 5415, 5425, 5503, 5525, 5603, 5605, 5615, 5625, 5705, 5715 - w/ MFWD	Complete 3rd Member Includes AMRE271380 Ring Gear and Pinion, AMRE271388 Differential Carrier and AMR271381 Differential Housing	AMX41134	\$ 1950.00	
Utility: 4044M, 4044R, 4049M, 4049R, 4052M, 4052R, 4066M, 4066R	Differential Carrier Assembly	AMLVA21270	\$ 2950.00	
 5045E, 5055E, 5065E, 5065M, 5075E, 5075M, 5076E, 5082E, 5083E, 5085E, 5085M, 5090E, 5090EH Hi-Clearance, 5093E, 5095M, 5100E, 5100M, 5100MH, 5100ML, 5101E, 5103 ASN 013640, 5105M, 5105ML, 5115M, 5115ML, 5203 ASN 005569, 5225, 5303 ASN 007752, 5403 ASN 001357, 5415, 5415H, 5425, 5525, 5603, 5605 SN 080729-090475, 5615, 5625, 5705 ASN 080729, 5715, 5715HC, 5725 ASN 005048	Differential Kit	AMRE271384	\$ 270.00	
5045E, 5055E, 5065E, 5065M, 5075E, 5075M, 5076E, 5082E, 5083E, 5085E, 5085M, 5090E, 5090EH Hi-Clearance, 5093E, 5095M, 5100E, 5100M, 5100MH, 5100ML, 5101E, 5103 ASN 013640, 5105M, 5105ML, 5115M, 5115ML, 5203 ASN 005569, 5225, 5303 ASN 007752, 5403 ASN 001357, 5415, 5415H, 5425, 5525, 5603, 5605 SN 080729-090475, 5615, 5625, 5705 ASN 080729, 5715, 5715HC, 5725 ASN 005048	Differential Housing	AMR271381	\$ 250.00	
5045E, 5055E, 5065E, 5065M, 5075E, 5075M, 5076E, 5082E, 5083E, 5085E, 5085M, 5090E, 5090EH Hi-Clearance, 5093E, 5095M, 5095MH, 5100E, 5100M, 5100MH, 5100ML, 5101E, 5103 ASN 013640, 5105M, 5105ML, 5115M, 5115ML, 5203 ASN 005569, 5225, 5303 ASN 007752, 5325, 5403 ASN 001357, 5415, 5415H, 5425, 5525, 5603, 5605, 5615, 5625, 5705 ASN 080729, 5715, 5715HC, 5725 ASN 005048	Differential Carrier	AMRE271388	\$ 500.00	

Mechanical Front Wheel Drive Parts





John Deere®—Tractor

Mechanical Front Wheel Drive Parts

Application	Description	Part Number	Retail Price	Core
5045E, 5055E, 5065E, 5065M, 5075E, 5075M, 5076E, 5082E, 5083E, 5085E, 5085M, 5090E, 5090EH Hi-Clearance, 5093E, 5095M, 5095MH, 5100E, 5100M, 5100MH, 5100ML, 5101E, 5103 ASN 103640, 5105M, 5105ML, 5115ML, 5203 ASN 005569, 5225, 5303 ASN 007752, 5325, 5403 ASN 001357, 5415, 5415H, 5425, 5525, 5603, 5605, 5615, 5625, 5705, 5715, 5715HC, 5725 ASN 005048	Differential Cover	AMR271387	\$ 100.00	
 5045E, 5055E, 5065E, 5065M, 5075E, 5075M, 5076E, 5082E, 5083E, 5085E, 5090E, 5090EH Hi-Clearance, 5093E, 5095M, 5095MH, 5100E, 5100M, 5100MH, 5100ML, 5101E, 5103 ASN 013640, 5105M, 5105ML, 5115M, 5115ML, 5203 ASN 005569, 5225, 5303 ASN 007752, 5325, 5403 ASN 001357, 5415, 5415H, 5425, 5525, 5603, 5605, 5615, 5625, 5705 ASN 08079, 5715, 5715HC, 5725 ASN 005048	Differential Disc Kit Includes Friction Discs and Separator Discs	AMRE271382	\$ 110.00	
2040, 2040S, 2355N, 2550, 2755, 2855N, Utility: 2155	Bevel Gear Set, Differential Replaces 4472251076, AL38089	AMAL71025	\$ 782.00	
 5045E, 5055E, 5065E, 5075E, 5076E, 5082E, 5083E, 5085E, 5090E, 5090EH Hi-Clearance, 5093E, 5100E, 5101E, 5103 ASN 013640, 5203 ASN 005569, 5225, 5303 ASN 007752, 5325, 5403 ASN 001357, 5415, 5415H, 5425, 5525, 5603, 5605, 5615, 5625, 5705, 5715, 5715HC, 5725 ASN 005048	Bevel Gear Set, Differential	AMRE271380	\$ 445.00	
6100D, 6105D, 6105E, 6110D, 6115D, 6120E, 6125D, 6130D, 6140D, 6403, 6603	Bevel Gear Set, Differential	AMRE282665	\$ 1500.00	
 6110, 6120, 6120L, (6200, 6300, 6400, 6500 ASN 124984), 6200L, 6210, 6210L, 6220, 6220L, 6300L, 6310, 6310L, 6310S, 6320, 6320L, 6400L, 6410, 6410L, 6410S, 6420, 6420L, 6420S, 6500L, 6510L, 6520L	Bevel Gear Set, Differential 19 & 35 Tooth, 13.13 Ratio	AMAL110347	\$ 775.00	
6140J, 6140R, 6145R, 6150M, 6155J, 6155M, 6155R, 6155RH, 7330, 7420, 7520	Bevel Gear Set, Differential 13.286 Ratio	AMAL160170	\$ 850.00	
6140J, 6145R, 6150M, 6150R, 6155J, 6155M, 6155R, 6155RH, 6170M, 7330, 7420, 7520	Bevel Gear Set, Differential 13.846 Ratio	AMAL160116	\$ 810.00	
6140M, 6615, 6715, 7130, 7230	Bevel Gear Set, Differential 15.692 Ratio Replaces AL160177	AMAL174435	\$ 580.00	
7430, 7530	Bevel Gear Set, Differential 13.1597 Ratio	AMAL175762	\$ 2150.00	
(6140J, 6155J - Hi-Crop HD), 6165J, 6180J, 7185J, 7195J, 7200R, 7205J, 7210, 7210J, 7210R, 7215R, 7225J, 7230R, 7250R, 7260R, 7270R, 7280R, 7290R, 7310R, 7330 Premium (Hi-Crop HD), 7410, (7420, 7815 - Hi-Crop), 7510, 7610, 7630, 7710, 7715, 7720, 7730, 7810, 7820, 7830, 7930, 8100, 8110, 8120, 8130, 8200, 8210, 8220, 8225R, 8230, 8235R, 8245R, 8260R, 8270R, 8285R, 8295R, 8300, 8310, 8320, 8330, 8400, 8410, 8420, 8430, 8520	Bevel Gear, Differential Replaces R133149	AMR237713	\$ 228.19	
(6140J, 6155J - Hi-Crop), 7200R, 7210R, 7215R, 7230R, 7250R, 7260R, 7270R, 7280R, 7290R, 7310R, 7630, 7720, 7730, 7820, 7830, 7920, 7930, 8120, 8130, 8220, 8225R, 8230, 8235R, 8245R (SN 000101-053099), 8260R, 8270R, (8285R, 8310R SN 016001-090000), 8295R, 8320, (8320R, 8335R SN 000101-053099 & ASN 090000 w/ 1500 or ILS™ Axle w/ 6.1 Ratio Final Drives), 8330, 8345R, 8360R, 8370R, 8400R, 8420, 8430, 8520, 8530, Premium Model: 7330 Hi-Crop	Bevel Gear, Differential Replaces R135875	AMR237709	\$ 92.03	
8100, 8110, 8200, 8210, 8300, 8310, 8400, 8410	Driveshaft Gear, Differential	AMR130894	\$ 458.97	

John Deere®—Tractor



















Mechanical Front Wheel Drive Parts

Application	Description	Part Number	Retail Price	Core
4055, 4255, 4455, 4555, 4560, 4650, 4755, 4760, 4850, 4955, 4960, (6140J, 6155J, 7420 w/ Hi-Crop), (7200R, 7210R, 7215R, 7230R, 7250R, 7260R, 7270R, 7280R, 7290R, 7310R, 7630, 7730, 7830, 7930 - w/ Limited Slip or Non-Locking Differential), 7210, 7410, 7510, 7600, 7610, 7700, 7710, 7720, 7800, 7810, 7820, 7920, 8100, 8110, 8120, (8130, 8230, 8330, 8430 w/ Standard MFWD Axle), 8200, 8210, 8220, 8300, 8310, 8320, 8400, 8410, 8420, 8520, (8225R, 8235R, 8245R, 8260R, 8270R, 8285R, 8295R - w/ 1300 MFWD Axle), Premium Model: 7330 w/ Hi-Crop,	Clutch Disc, Differential 25 Tooth, 2.195" Major ID, 2.008" Minor ID, 3.70" OD, 0.13" Thick Replaces RE22337, RE43059	AMRE294014	\$ 19.12	
 6100D, 6105D, 6105E, 6105M, 6105R, 6110, 6110D, 6110L, 6110M, 6115D, 6115M, 6115R, 6120, 6120E, 6120L, 6120M, 6120R, 6125D, 6125M, 6125R, 6130D, 6130M, 6130R, 6135E, 6140D, 6140J, 6140M, 6140R, 6145M, 6145R, 6150M, 6150R, 6150RH, 6155J, 6155M, 6155R, 6170M, 6200, 6200L, 6210, 6210L, 6215, 6220, 6220L, 6230, 6300, 6300L, 6310, 6310L, 6310S, 6320, 6320L, 6330, 6400, 6400L, 6403, 6405, 6410, 6410L, 6410S, 6415, 6420, 6430, 6500, 6500L, 6510L, 6510S, 6520L, 6603, 6605, 6615, 6715, 7130, 7210, 7220, 7230, 7320, 7330, 7410, 7430, 7510, 7530	Bushing 2.057" Long, 2.028" ID, 2.224" OD	AML76471	\$ 17.00	
 (4050, 4250, 4450, 4650, 4850 - w/ John Deere® Axle), 4055, 4255, 4455, 4555, 4560, 4755, 4760, 4955, 4960, (7610, 7710, 7810 - All Axles Excluding Models w/ 2 Pinion Standard Differential Axle), 7700, 7720, 7800, 7820, 7920 HD Differential, 7930, (8100, 8200, 8300, 8400 - w/ Axle BSN 077516), (7200R, 7210R, 7215R, 7230R, 7250R, 7260R, 7270R, 7280R, 7290R, 7310R - w/ Limited Slip 4.0 Ratio Axle), (7630, 7730, 7830 - w/ Non-Locking Differential)	Clutch Disc, Differential 25 Tooth, 2.195" Major ID, 2.008" Minor ID, 3.70" OD, 0.216" Thick Replaces RE22336, RE43058	AMRE294013	\$ 21.40	
 5045E, 5055E, 5065E, 5065M, 5075E, 5075M, 5076E, 5082E, 5083E, 5085E, 5085M, 5090E, 5090EH Hi-Clearance, 5093E, 5095M, 5095MH, 5100E, 5100M, 5100MH, 5101E, 5103 ASN 0013640, 5105M, 5105ML, 5115M, 5115ML, 5203 ASN 005569, 5225, (5303, 5403 ASN 001357), 5325, 5415, 5415H, 5425, 5525, 5603, 5615, 5625, 5715, 5715HC, 5725 ASN 005048	Axle Assembly	AMRE271427	\$ 655.00	
6120E, 6125D, 6130D, 6135E, 6230, 6320, 6330, 6420, 6430	Axle Shaft 30 mm OD	AMAL181509	\$ 1275.00	
 6140R, 6145R, 6150M, 6155, 6615, 6715, 7130, 7230	Axle Shaft Replaces AL177178	AMAL160131	\$ 800.00	
6230, 6320, 6330, 6420, 6430	Axle Shaft	AMAL161351	\$ 940.00	
7330	Axle Shaft Use w/ AL167149, AL167150, AL167151, AL171567, AL173483, AL174836 and AL174837 Front Axles	AMAL175645	\$ 1250.00	
 2030, 2040, 2140, 2150, 2255, 2350, 2355, 2355N, 2550, 2555, 2750, 2755, 2840, 2855N, 2940, 2950, 2955, 3055, 3150, 3155, 3255, Utility: 2155, 2240	Differential Cross Shaft Replaces L29228	AML29226	\$ 48.92	
8100, 8110, 8120, (8130, 8230, 8330, 8430 - w/ Standard Axle), 8200, 8210, 8220, 8225R, (8235R, 8245R, 8260R, 8270R, 8285R, 8295R - w/ 1300 Axle), 8300, 8310, 8320, 8400, 8410, 8420, 8520 ASN 020532	Pivot Bushing	AMR107719	\$ 93.00	

John Deere®—Tractor

John Deere®—Tractor





MFWD Driveshafts

Application	Description	Part Number	Retail Price	Core
 940, 1040, 1140, 1640, 1840, 2040 BSN 429999, 2150, Utility: 2240 ASN 350000	Driveshaft Assembly, Short 21 Tooth	AMAL32883	\$ 150.00	
 940, 1040, 1140, 1640, 1840, 2040 BSN 429999, 2150, Utility: 2240 ASN 350000	Driveshaft Assembly, Long 21 Tooth	AMAL32884	\$ 295.00	
 4050, 4055, 4250, 4255, 4450, 4455	Driveshaft	AMRE36872	\$ 460.00	
 4050, 4250, 4450	Driveshaft	AMRE15544	\$ 550.00	
 4050, 4250, 4450, 4650, 4850	Driveshaft	AMRE15547	\$ 500.00	
 4555, 4560, 4650, 4755, 4760, 4850, 4955, 4960	Driveshaft	AMRE36873	\$ 425.00	
 6140R, 6145R, 6150M, 6155R, 6155RH, 6615, 6715, 7130, 7230, 7330	Driveshaft Use w/ AL161013 Universal Driveshaft Replaces AL160165	AML174432	\$ 345.00	
 7200, 7210, 7400, 7410, 7510	Driveshaft	AMRE48152	\$ 450.00	
 7210, 7410, 7420, 7510	Driveshaft	AMRE67769	\$ 475.00	
 7600, (7610, 7710, 7810 BSN 089999), 7700, 7800 - w/ PowerQuad™ Transmissions	Driveshaft	AMRE34125	\$ 555.00	
 7600, (7610, 7710, 7810 BSN 089999), 7700, 7800 - w/ Powershift Transmission	Driveshaft	AMRE34126	\$ 550.00	
 7610 BSN 075325, (7710, 7810 BSN 075325 & ASN 090000)	Driveshaft	AMRE67768	\$ 380.00	
 7610 SN 000001-000999 & ASN 800001, (7710, 7810 SN 000001-000999 & ASN 090000) - w/ Powershift or IVT™ Transmission	Driveshaft	AMRE151563	\$ 380.00	
 (7610, 7710, 7810 BSN 089999)	Driveshaft	AMRE67767	\$ 450.00	
 7610, 7710, 7810 - w/ Powershift or IVT™ Transmission	Driveshaft	AMRE150207	\$ 390.00	
 7610, 7710, 7810, 7330 Premium - w/ PowerQuad™ Transmission	Driveshaft	AMRE151562	\$ 380.00	
 7610 European, 7710 European, 7810 European - w/ PowerQuad™ Transmission	Driveshaft	AMRE150204	\$ 395.00	
2040 ASN 349999, 2150, Utility: 2240 ASN 349999	Driveshaft U-Joint 27 mm x 82 mm	AMAL32885	\$ 45.39	
 2350, 2355, 2550, 2555, (2750 BSN 583919 w/ APL 345 Axle BSN 055484 or ASN 583918 w/ APL 735 Axle ASN 000257), 2755, 2855N, 2940, 2950, 2955, 3055, 3150, 3155, 3255, 6140J, (6150R, 6150RH, 6170R, 6175M, 6190R, 6195M, 6195R, 6210R, 6215R - w/ Hi-Crop w/ PowerQuad™ Transmission w/o TLS™), 6155J, (6155R, 6155RH, 6175R - w/ Hi-Crop), 6170M, 6170R, 6175R, 6190R, 6195R, 6215R, (7210, 7410 - w/ ZF Axle ASN 052868), 7330, 7420, 7510 w/ ZF Axle ASN 053664, 7520, Premium Models: 7330, 7430, 7530	Driveshaft U-Joint 35 mm x 97 mm Replaces AL116666	AMAL37069	\$ 93.45	
2350, 2550	Driveshaft U-Joint 27 mm x 71 mm Marked 0501-205-345	AMAL55943	\$ 56.78	
(2350, 2550 SN 038265-048738) 2755 ASN 629299 w/ APL 735 Axle	Driveshaft U-Joint 27 mm x 70 mm Replaces AL64255, AL65195	AMAL71316	\$ 89.64	

Mechanical Front Wheel Drive Parts

John Deere®—Tractor

Mechanical Front Wheel Drive Parts





Application	Description	Part Number	Retail Price	Core
2750, 2755 BSN 629300 - w/ APL 735 Axle	Driveshaft U-Joint 28 mm x 71.50 mm	AMAL62452	\$ 79.41	
(2750, 2950 SN 021975-024760 w/ APL 345 Axle), 3150 BSN 014586	Driveshaft U-Joint 30.27 mm x 92.10 mm Marked 0501-205-344	AMAL55941	\$ 61.42	
 4050, 4055, 4250, 4255, 4450, 4455, 4555, 4560, 4755, 4760, 4955, 4960, (6140J, 6155J, 7420 - w/ Hi-Crop), 7200R, 7210, 7210R, 7215R, 7230R, 7250R, 7260R, 7270R, 7280R, 7290R, 7310R, 7410, 7510, 7600*, 7610 w/ All MFWD Axles Excluding TLS™ w/o Hi-Crop, 7700*, (7710, 7810 BSN 090000 w/ All MFWD Axles Excluding TLS™ Axle w/o Hi-Crop or ASN 089999 w/o TLS™ Axle), (7720, 7730, 7820, 7830, 7920, 7930 - w/ Heavy Duty MFWD), 7800*, 8100, 8110, 8120, 8130, 8200, 8210, 8220, (8225R, 8235R, 8245R, 8260R, 8270R, 8285R, 8295R - w/ 1300 Axle), 8230, 8300, 8310, 8320, 8330 w/ Standard MFWD, 8400, 8410, 8420, 8520 ASN 020532, Premium Model: 7330 w/ Hi-Crop *Will fit models ASN 011049 when used w/ RE65603 Assembly or all models when used w/ RE70738 Assembly	Driveshaft U-Joint 97 mm x 97 mm Replaces RE47758	AMRE65621	\$ 47.50	
 4050, 4250, 4450 - w/ ZF Front Axle	Driveshaft U-Joint 35 mm x 87 mm Replaces AL38516, AL38517, RE23190	AMRE23191	\$ 174.67	
 (6100D, 6110D, 6115D, 6125D, 6130D BSN 050001 w/ DANA® MFWD Axle), (6140D, 6403, 6603, 6105D - w/ DANA® MFWD Axle), (6140M, 6615, 6715, 7130, 7230 - w/ APL 740 Axle), (6215, 6320L, 6415, 6420L, 6520L - w/ Cab and AutoTrac™ w/o Front Wheel Brake), (6330, 6430 - w/ APL 730 or 733 Axle), 7330 w/ APL 745 Axle, Premium Models: (6230, 6320, 6330, 6420, 6430 - w/ APL 733 Axle), (7130, 7230 - w/ APL 740 Axle)	Driveshaft U-Joint 30 mm x 83.50 mm	AMAL161324	\$ 98.01	
6140J, 6155J, 7330 Premium Model: 7520 - All w/ MFWD 750 Axle	Driveshaft U-Joint 34.90 mm x 93.40 mm	AMAL160144	\$ 172.22	
6150R, 6150RH, 6155R, 6155RH, 6170M, 6170R, 6175R, 6190R, 6195R, 6210R, 6215R, 7420, 7520, Premium Models: 7330, 7430, 7530	Driveshaft U-Joint 35 mm x 97 mm	AMAL177214	\$ 155.00	
7630, 7720, 7730, 7820, 7830, 7920, 7930	Driveshaft U-Joint 34.59 mm x 97 mm	AMRE208960	\$ 78.24	
 4050, 4055, 4250, 4255, 4450, 4455, 4555, 4560, 4650, 4755, 4760, 4850, 4955, 4960	Clutch Shaft, MFWD Replaces R70852	AMR82499	\$ 469.00	
4050, 4250, 4450, 4650, 4850	Driveshaft Bushing Replaces R75847	AMR82201	\$ 16.76	
2350, 2355, 2355N, 2550, 2555, Utility: 2155	Outer Bushing, Half Shaft 1.445 ID, 1.618 OD, 1.264 Wide Replaces L40017, L60747	AMVPJ2663	\$ 11.93	
2350, 2355, 2355N, 2550, 2555, 2855N w/ APL 325N Axle, Utility: 2155	Seal, Half Shaft Replaces AL38096, AL39466, AL63351	AMVPJ2912	\$ 22.81	

John Deere®—Tractor















Axle Assemblies

Application	Description	Part Number	Retail Price	Core
5045E, 5055D, 5055E, 5065E, 5075E, 5103, 5203, 5215, 5225, 5315, 5325, 5403, 5415, 5425, 5503, 5525, 5603, 5605, 5615, 5625, 5705, 5715 - w/ MFWD	Complete Axle Assembly DANA® Mfg # - 725-123, 725-150 Replaces RE266990, RE266993	AMRE258981	\$ 5500.00	
6140J	Complete Axle Assembly DANA® Mfg # - 745/750 Ratio - 13:286	AMAL171564	\$ 9500.00	
6155J, Premium Model: 7330 - All w/o TLS™	Complete Axle Assembly DANA® Mfg # - 745/750 Ratio - 13:286	AMAL171567	\$ 9500.00	
6615, 6715, 7130, 7220, 7230, 7320, Premium Models: 7130, 7230	Complete Axle Assembly DANA® Mfg # - 740 Ratio - 15:692 Replaces AL158127, AL171555, AL174884	AMAL173216	\$ 6250.00	
6615, 6715, Premium Models: 7130, 7230, (7230, 7320 - Hi-Crop) - All w/o TLS™	Complete Axle Assembly DANA® Mfg # - 740/145 Ratio - 17:500 Replaces AL158465, AL171561	AMAL173218	\$ 9500.00	
7330	Complete Axle Assembly DANA® Mfg # - 755 Ratio - 13:286	AMAL178620	\$ 9500.00	
Premium Model: 7330 - w/ TLS™ and w/o Front Wheel Brakes	Complete Axle Assembly DANA® Mfg # - 750 Ratio - 13:286	AMAL167149	\$ 9500.00	
7420 - w/ AutoTrac™ and w/o TLS™	Complete Axle Assembly DANA® Mfg # - 745/750 Ratio - 13:286	AMAL162872	\$ 9500.00	
Premium Models: 7430, 7530 - w/ TLS™ and w/o Front Wheel Brakes	Complete Axle Assembly DANA® Mfg # - 755 Ratio - 13:1597	AMAL170962	\$ 9500.00	
Premium Models: 7430, 7530 - w/ MFWD and w/o TLS™ or AutoTrac™	Complete Axle Assembly Ratio - 13:1597	AMAL172323	\$ 10500.00	
7520 - w/ AutoTrac™ and w/o TLS™	Complete Axle Assembly DANA® Mfg # - 745/750 Ratio - 13:286	AMAL162875	\$ 9500.00	
Utility: 4120, 4320, 4520, 4720	Complete Axle Assembly	AMLVA18457	\$ 4750.00	











Tie Rods and Components

Application	Description	Part Number	Retail Price	Core
 920, 930, 940, 1020, 1030, 1040, 1120, 1130, 1140, 1520, 1530, 1630, 1640, 1840, 2020, 2030, 2040, 2120, 2150, 2255, 2440, 2630, 2640, Ind: 300, 301, 301A, 302, 400, 401, 401B, Utility: 820, 830, 2240	Inner Tie Rod 5.875" Long, 1.125" Diameter 12 Internal Thread Replaces AL39020	AMAT27130	\$ 35.00	
 420, 430, 1010 BSN 011000	Drag Link End 3.375" Long, 0.687" Diameter 18 Left Hand Thread	AMAM497T	\$ 12.00	
 520, 530, 620, 630, 720, 730	Tie Rod 3.35" Long, 0.687" Diameter 18 Right Hand Thread	AMAR21944	\$ 11.00	
 520, 530, 620, 630, 720, 730	Tie Rod 3.35" Long, 0.687" Diameter 18 Left Hand Thread	AMAR21945	\$ 18.00	





John Deere®—Tractor

Application	Description	Part Number	Retail Price	Core
 (920, 930, 940, 1020, 1030, 1120, 1130, 1530, 1630, 2020, 2120, 2355, 2555, 2755 - w/ Straight Front Axle), (1040, 1140, 2150 - w/ Straight Front Axle and Swept Front Axle), (2255, 2355N, 2855N - w/ Swept Front Axle), (2350, 2550 - w/ Power Steering w/o MFWD and w/ Straight Front Axle), Utility: (820, 830, 2155 - w/ Straight or Swept Front Axle)	Tie Rod End 5" Long, 1.125" ID Thread	AMAL39020	\$ 50.00	
 920, 930, 1030, 1020, 1040, 1530, 2040, 2150, 2440, 2640, 2020*, 2030**, 2630** - w/ Swept Adjustable Axle), Utility: 820, 830, 2240 - w/ Swept Adjustable Axle *48"-79" **49"-79"	Outer Tie Rod 12.25" Long, 0.781" Diameter, 11 Notches	AMAT23885	\$ 26.00	
 1020, 1520, 1530, 2040, Utility: 820, 830, 2240	Drag Link Assembly 35.781" Long	AMAR68818	\$ 85.00	
920, 1030, 1120, 2150, 2255, 2355N, 2855N, Utility: 820, 2155	Outer Tie Rod 12.25" Long, 0.781" Diameter 11 Notches on Bottom	AMAL39022	\$ 32.50	
 840, 940, 1020, 1030, 1040, 1120, 1130, 1140, 1350, 1520, 1530, 1550, 1630, 1640, 1750, 1850, 1950, 2020 w/ Swept-Back Axle, 2030, 2120, 2150, 2250, 2350, 2355, 2550, 2555, 2630, 2640, 2755, Ind: 301, 401, Utility: 2155, 2240	Tie Rod Tube 12.218" Long, 0.812" ID, 1.125" OD 12 Thread	AMT29109	\$ 29.93	
 920, 1020, 1030, (1040, 1140, 1530, 2040 - w/ Swept Axle), 1120, 1630, (2020, 2030 - w/ Adjustable Axle, 44"-66"), (2150, 2255 - Low Version w/ Swept Axle), 2120, 2440, 2630M 2640M, Utility: 820, 830, 2240	Outer Tie Rod 9.25" Long, 0.781" Diameter, 8 Notches	AMAT27131	\$ 45.00	
 940, 1020, 1030, 1040, 1120, 1130, 1140, 1520, 1530, 1630, 1640, 2020 w/ Adjustable Axle, 48"-80", 2030 w/ Adjustable Axle, 49"-81", 2120, 2440, 2630, 2640, Utility: 2240	Outer Tie Rod 14.51" Long, 0.781" Diameter, 13 Notches	AMAT27134	\$ 25.00	
1010 ASN 042001, 2010	Tie Rod 3.22" Long, 0.687" Diameter 18 Right Hand Thread	AMAT13971	\$ 69.95	
 1020, 1030, 1040, 1120, 1140, 1350, 1530, 1550, 1750, 1950N, 2020, 2030, 2040, 2150, Ind: 300 ASN 118105, 301, 302, 400, 401, 401B	Tie Rod Tube 11.156" Long, 0.812" ID, 1.125" OD	AMT25901	\$ 18.00	
 (1020, 1520, 1530, 2020, 2030, 2440, 2630, 2640, Utility: 2240 - All w/ Straight Adjustable Axle)	Outer Tie Rod 17.25" Long, 0.75" Diameter, 15 Grooves	AMAT23583	\$ 25.00	
 1020, 1520, 1530, 2020, 2030, 2440, 2630, 2640, Utility: 2240	Tie Rod Tube 17.14" Long, 0.75" ID, 1" OD 16 Thread	AMT22952	\$ 60.00	
 1020, 1520, 1530 Straight Front Axle w/ 38" Rear Tires, (2020, 2030 Straight Front Axle 60"-88" & 58"-92 1/2"), 2440 Straight Front Axle, 2630 Straight Front Axle 60"-88", 2640 Straight Front Axle 60"-88" and 60"-93", Ind: 300, 400, Utility: 2240	Inner Tie Rod 5" Long, 1" ID Internal Thread	AMAT23886	\$ 28.00	
 1020, 1520, 2020 - w/ Swept Back Adjustable Axles 48-78"	Tie Rod 12.50" Long, 0.75" Diameter, 11 Grooves	AMAT20943	\$ 35.00	
1020, 1520, 2020	Tie Rod Tube 12.69" Long, 0.76" ID 16 Right Hand Thread	AMT22947	\$ 51.16	
 1530, 2020, 2030, 2440, 2630, 2640, Utility: 2240	Outer Tie Rod 14.50" Long, 0.781" Diameter, 13 Notches	AMAL39027	\$ 49.50	
 1550, (1640, 2040, 2040S ASN 430000), 1750, 1850, 1950, 2140, 2250, 2350, 2355, 2450, 2550, 2555, 2650, 2750, 2755, 2850	Tie Rod 11.25" Long M18x1.50" Right Hand Thread	AMAL39319	\$ 40.00	
 1550, 1640, 2040, 2140, 2350, 2355, 2550, 2555, 2650, 2750, 2755, 2850	Ball Joint, Right Hand	AMAL39320	\$ 52.00	







John Deere®—Tractor

Application	Description	Part Number	Retail Price	Core
 1640, 1830, (1840, 2140 BSN 429999), 2030, 2040, 2130, 2250, 2350, 2355, 2550, 2555, 2650, 2755, 2850	Tie Rod Tube 13.94" Long, 0.888" ID M24x1.50" Right Hand Thread	AML32308	\$ 38.24	
 1640, 1830, 2030, 2040, 2130, 2140, (2350, 2550 - w/ Power Steering), 2355, 2555, 2755	Outer Tie Rod 12.62" Long, 0.865" Diameter 6 Notches Replaces AL27533, AL82825	AMAL37505	\$ 40.00	
 1640, 1840, 2040, 2040S, 2140, 2350, 2550, 2650, 2650N, 2850, 2355, 2555, 2755, 2855N	Drag Link Assembly Replaces AL38638	AMAL82836	\$ 110.00	
 1640, 2040, 2040S, 2140, 2350, 2355, 2550, 2555, 2750, 2755, 2940, 2950, 2955, 3040, 3055, 3140, 6110, 6110L, 6120, 6120L, 6200, 6200L, 6210	Tie Rod End 3.88" Long M24x2.00" Right Hand Thread	AMAL37193	\$ 66.45	
(1640, 2040, 2040S, 2140 ASN 430000), (2350, 2550 - 2WD w/ Power Steering), 2355, 2555, 2755	Tie Rod 3.88" Long 24 mmx1.50" Thread Replaces AL37504	AMAL82826	\$ 33.50	
 2020, 2030, 2630, 2440 BSN 308805, 2640 BSN 308805	Drag Link Assembly 40.75" Long	AMAR91711	\$ 60.00	
 (2140, 2750, 2950, 3040, 3050, 3140, 3350 - w/ MFWD), 610C	Ball Joint 8.25" Long M22x1.50" and M24x1.50" Right Hand Threads Replaces N14377	AMAL60161	\$ 65.00	
 (2140, 2750 - w/ Axle ASN 024905), (2950, 3040, 3140 - w/ Axle ASN 026316)	Tie Rod End, Right Hand 11.75" Long M24x1.50" Right Hand Thread Replaces AL168706	AMAL58014	\$ 90.00	
 (2140, 2750 - w/ Axle ASN 024905), (2950, 3040, 3140 - w/ Axle ASN 026316)	Tie Rod End, Left Hand 11.75" Long M24x1.50" Right Hand Thread Replaces AL168705	AMAL58013	\$ 90.00	
2150, 2255, Utility: 2155 BSN 720980	Drag Link Assembly 35.87" Long, 1.105" Diameter Replaces AL34934	AMAL39036	\$ 163.18	
2150, 2350, 2355, 2355N, 2550, 2555, 2755, 2855N, Utility: 2155	Inner Tie Rod 4.25" Long M24x1.50" Right Hand Thread	AMAL110074	\$ 53.39	
2150, (2350, 2550 - Low Version w/ Power Steering), 2355 Middle Version, 2555 Middle Version, 2755 Middle Version, Utility: 2155 - All w/ Straight Axle	Tie Rod Assembly	AMAL39023	\$ 154.65	
(2040 w/ 16.10" Rear Tires BSN 350000, 2150 Low Version, 2255, 2355N - w/ Swept-Back Axle), Utility: (2155, 2240 w/ 16.10" Rear Tires BSN 350000 - w/ Swept-Back Axle), 2240 Narrow Version ASN 349999	Tie Rod Tube 7.92" Long, 0.812" ID 1.125"x12 External Thread	AMT29106	\$ 16.98	
 2150, 2840, 3030, 3120, 3130, Utility: 2155	Inner Tie Rod 4.06" Long M24x1.25" Thread	AMAL38645	\$ 40.00	
 (2150, 2250 - Low Version), 2355N, Utility: 2155 - All w/ Swept-Back Axle	Tie Rod 9.25" Long, 0.781" OD, 8 Notches on Bottom	AMAL39019	\$ 26.50	
Utility: 2155 ASN 621999 w/ MFWD	Inner Tie Rod 4.06" Long M28x1.50" External Thread	AMAL63612	\$ 68.73	
2350, 2355, 2550, 2555, (2750, 2755 - w/ APL 735 Axle)	Tie Rod Assembly Includes Ball Joint	AMAL38097	\$ 144.41	
(2350, 2550 - w/ Power Steering), 2355, 2555, 2755	Tie Rod Assembly	AMAL82828	\$ 154.90	















John Deere®—Tractor

Application	Description	Part Number	Retail Price	Core
(2350, 2550 - w/ Hydrostatic Steering), 2355, 2555, 2750, 2755, 2950, 2955 - All w/ Wide Axle	Tie Rod Tube 50.38" Long, 1.285" ID M24x2.00" Right Hand Internal Thread	AML64252	\$ 142.83	
(2350, 2550 - w/ Hydrostatic Steering), 2355, 2555, 2750, 2755, (6110L, 6120L, 6200, 6200L, 6210L, 6220L, (6230, 6330, 6430 BSN 647869), 6300, 6300L, 6310L, 6310S, 6320L, 6400, 6400L, 6410L, 6410S, 6420L, 6500, 6500L, 6510L, 6510S, 6520L - w/ Low Version Front Axle)	Tie Rod Tube 32.75" Long, 1.285" ID	AML39324	\$ 176.92	
(2350, 2550, 2950, 2955 - w/ Wide Axle and Hydrostatic Steering), 2355, 2555, 2750 w/ Wide Axle, 2755	Tie Rod 30.25" Long, 1.25" OD, 14 Notches on Top	AMAL68726	\$ 315.12	
 (2350, 2550 - w/ Hydrostatic Steering), (2355, 2555, 2755 - w/o MFWD), 2750, (6110L, 6120L, 6200, 6200L, 6210L, 6220L, 6300, 6300L, 6310L, 6310S, 6320L, 6400, 6400L, 6410L, 6410S, 6420L, 6500, 6500L, 6510L, 6510S, 6520L - w/ Low Version Front Axle)	Outer Tie Rod 18.75" Long, 1.25" OD, 6 Notches on Top	AMAL37204	\$ 68.00	
2355, 2555, 2755, 2955 - w/ 60"-88" Tread Axles	Tie Rod Tube 42.625" Long, 1.282" ID M24x2.00" Right Hand Internal Thread	AML64253	\$ 96.26	
 2355GP, 2555GP, 2750GP, 2755GP, (5010, 5020, 6030 - w/ Row Crop, Standard or Fixed Axles)	Tie Rod 3.75" Long, 1" Diameter 16 Right Hand Thread	AMAR74131	\$ 40.00	
 2355GP, 2555GP, 2755GP, (5020, 6030 - w/ Fixed Axle)	Tie Rod 3.75" Long, 1" Diameter 16 Left Hand Thread	AMAR74132	\$ 50.00	
 2510, 2520, 3010, 3020, 4000, 4010, 4020, 4230 Low Profile, 4320	Tie Rod Assembly Components: Tie Rod, Long 1 Tie Rod, Short 1 Inner Tube 1 Outer Tube 1 Clamp 1 Wedge 1	AMAR44332 AMAR51584 AMAR27351 AMR28022 AMR28021 AMR28023 AMR28024	\$ 90.00 \$ 25.00 \$ 15.00 \$ 20.00 \$ 30.00 \$ 5.00 \$ 2.00	
 2510, 2520, 3010, 3020, 4000, 4010, 4020, 4230, 4320 - Wheatland Axle or Front End	Inner Tie Rod 3.84" Long, 0.875" Diameter Left Hand Thread	AMAR27430	\$ 20.00	
2510, 2520, (3010, 3020 ASN 129999 or BSN 123000, 4010, 4020 - w/ Long Wheel Base), 4320 - w/ 88" Adjustable Axle	Inner Tie Rod Tube 15.50" Long	AMR31573	\$ 106.84	
2750 BSN 024906 w/ APL 345 Axle, 2950 BSN 026317	Tie Rod Assembly, Left Hand Includes Ball Joint	AMAL38013	\$ 193.03	
2750 ASN 024905 w/ APL 345 Axle, 2950 ASN 026316	Tie Rod Assembly, Left Hand Includes Ball Joint	AMAL56439	\$ 279.19	
2750 BSN 024906 w/ APL 345 Axle, 2950 BSN 026317	Tie Rod Assembly, Right Hand Includes Ball Joint	AMAL38014	\$ 183.63	
2750 ASN 024905 w/ APL 345 Axle, 2950 ASN 026316	Tie Rod Assembly, Right Hand Includes Ball Joint	AMAL56440	\$ 277.57	
2750 BSN 024906, 2950 BSN 026317	Tie Rod End, Left Hand 12.50" Long M24x1.50" Right Hand Thread	AMAL39315	\$ 115.06	
2840	Tie Rod Assembly 56.25" Long Replaces AL32999	AMAL37259	\$ 312.44	







John Deere®—Tractor

Application	Description	Part Number	Retail Price	Core
2840	Tie Rod 13.62" Long, 0.865" OD, 6 Notches on Top Replaces AL27534, AL110130, AL177948	AMAL38646	\$ 31.00	
 2950, 2955, 3040, 3050, 3140, 3150, 3350, 6010, 6020, 6100, 6110, 6120, 6130, 6200, 6210, 6220, 6230, 6300, 6310, 6320, 6330, 6400, 6403, 6405	Tie Rod 26.25" Long, 1.25" Diameter	AMAL68724	\$ 210.00	
(2950, 2955 - w/ Standard Adjustable Axle / Hydro Steering), 3040, 3050, 3140, 3350, 6010, 6100, 6110, 6110L, 6120, 6120L, 6200, 6200L, 6210, 6210L, 6220, 6220L, 6300, 6300L, 6310, 6310L, 6310S, 6320, 6320L, 6400, 6400L, 6400SP, 6403, 6405, 6410, 6410L, 6410S, 6420, 6420L, 6500, 6500L, 6510, 6510L, 6510S, 6520, 6520L, 6605, 6610, 6620, 7405	Tie Rod Tube 38.25" Long, 1.282" ID M24x2.00" Right Hand Thread	AML64250	\$ 170.67	
 2955 BSN 767517, (3040, 3140 ASN 430000), 3055, 3150, 3155, 3255 - w/ MFWD	Tie Rod, Left Hand 10.75" Long M28x1.50" Right Hand Thread Not for Use on Heavy Duty Axles Replaces AL55432, AL68255, AL168701	AMAL68254	\$ 57.00	
 2955, 3040, 3050, 3055, 3140, 3150, 3155, 3255, 3350, 3640, 3650 - w/ MFWD	Tie Rod 10.75" Long M28x1.50" Right Hand Thread	AMAL68255	\$ 65.00	
 2955, 3040, 3050, 3055, 3140, 3150, 3155, 3255, 3350, 3640, 3650, 6900, 6910, 6920, 7405, 7420, 7500, 7505, 7510, 7520 - w/ MFWD	Ball Joint For European Models Only 9" Long M24x1.50" and M28x1.50" Right Hand Threads	AMAL177977	\$ 120.00	
2955, 3055, 3255	Tie Rod Assembly, Left Hand Reinforced Version Includes Ball Joint	AMAL69818	\$ 306.62	
2955, 3055, 3255	Tie Rod Assembly, Right Hand Reinforced Version Includes Ball Joint	AMAL69819	\$ 132.92	
3010, 3020 w/ Short Wheel Base, 4000 Low Profile, 4010, 4020, 4230 Low Profile - w/ Fixed Tread Front Axle	Tie Rod Tube, Left Hand 19.375" Long 7/8"x18 Right Hand/Left Hand Internal Thread	AMR28115	\$ 24.50	
3010, 3020, 4000, 4010, 4020, 4230, 4320 - w/ Fixed Tread Front Axle	Tie Rod Tube, Right Hand 16.50" Long 7/8"x18 Right Hand and Left Hand Internal Threads	AMR28114	\$ 91.87	
 4030, 4040, 4050, 4055, 4230, 4240, 4250, 4255, 4430, 4440, 4450, 4455 - w/ Narrow Wide Front	Tie Rod 14.25" Long, 0.995" Diameter, 7 Cross Holes	AMAR63591	\$ 45.00	
 4030, 4040, 4050, 4055, 4230, 4240, 4250, 4255, 4430, 4440, 4450, 4455 - w/ Regular Wide Front Axles	Tie Rod Tube 17.50" Long	AMR54963	\$ 22.00	
 4030, 4040, 4050, 4055, 4230, 4240, 4250, 4255, 4430, 4440, 4450, 4455 - w/ Extra Wide Front Axles	Tie Rod Assembly Also Includes (3) Cap Screws, (3) Nuts and (3) Washers	AMAR44337	\$ 160.64	
Components:				
	Tie Rod	1	AMAR63593	\$ 40.00
	Inner Tie Rod	1	AMAR63588	\$ 20.00
	Tie Rod Tube	1	AMR54965	\$ 55.00
	Clamp	1	AMR28023	\$ 5.00











John Deere®—Tractor

	Application	Description	Part Number	Retail Price	Core
	4030, 4040, 4050, 4055, 4230, 4240, 4250, 4255, 4430, 4440, 4450	Tie Rod Assembly Components: Inner Tie Rod 1 Outer Tie Rod 1 Tube 1 Clamp 1	AMAR44336 AMAR63588 AMAR63592 AMR54963 AMR28023	\$ 75.00 \$ 20.00 \$ 35.00 \$ 22.00 \$ 5.00	
	4030, 4040, 4050, 4055, 4230, 4240, 4250, 4255, 4430, 4440, 4450, 4455, 4630	Inner Tie Rod 3.812" Long, 0.875" Diameter Right Hand Thread	AMAR63588	\$ 20.00	
	4030, 4040, 4050, 4055, 4230, 4240, 4250, 4255, 4430, 4440, 4450, 4455 - w/ Extra Wide Front Axle	Tie Rod Tube 20.50" Long	AMR54965	\$ 55.00	
	4030, 4040, 4050, 4055, 4230, 4240, 4250, 4255, 4430, 4440, 4450, 4455 - w/ Narrow Spaced Wide Front End	Tie Rod Tube 15.375" Long, 1.015" ID 18 Right Hand Thread	AMR54964	\$ 16.00	
	4030, 4040, 4050, 4055, 4230, 4240, 4250, 4255, 4430, 4440, 4450, 4455, 4630 - w/ Wide Front Axle	Tie Rod 18.75" Long, 0.99" Diameter, 9 Cross Holes	AMAR63593	\$ 40.00	
	4030, 4040, 4050, 4230, 4240, 4250, 4430, 4440, 4450	Outer Tie Rod 16" Long, 0.99" Diameter, 8 Holes	AMAR63592	\$ 35.00	
	(4040, 4230, 4240, 4250, 4430, 4440, 4640 BSN 002436, 7200, 7210, 7400, 7410, 7510, 7600, 7700, 7710, 7800, 7810 - w/ MFWD), (4555, 4560, 4630, 4640, 4650, 4755, 4760 - w/ Extra Wide Front Axle)	Tie Rod 4.187" Long, 1.125" Diameter 16 Thread	AMAR63590	\$ 15.00	
	4040, 4230, 4240, 4430, 4440, 4630, 4640 BSN 002430 - w/ MFWD	Tie Rod 22.50" Long, 1.116" Diameter, 8 Cross Holes	AMAR63587	\$ 30.00	
	4040, 4230, 4240, 4430, 4440, 4630, 4640 BSN 002436 - w/ MFWD	Tie Rod Tube 17.375" Long	AMR55075	\$ 25.00	
	(4040, 4230, 4250, 4430, 4440 - w/ Power Front Axles), 4555, 4560, 4630, 4640, 4650, 4755, 4760, 4955, 4960, 5010, 5020, 6030, 7200, 7210, 7220, 7320, 7400, 7410, 7420, 7510, 7600, 7610, 7700, 7710, 7800, 7810, Ind: 401D, 500, 510, 600, 700A, Combines: (6620, 7720 - w/ Adjustable Rear Axle), 8820, Cotton Pickers: 9940, 9950, 9965	Tie Rod Clamp	AMM2301T	\$ 6.00	
	4040, 4230, 4250, 4430, 4440, 4640 BSN 002437 - w/ PFWD	Tie Rod Assembly	AMAR44339	\$ 195.50	
	(4040, 4240, 4440 - w/ MFWD Axle), (4555, 4560, 4630, 4640, 4650, 4755, 4760 - w/ Wide Axle)	Tie Rod 19.50" Long, 1.116" Diameter, 9 Cross Holes	AMAR63595	\$ 78.00	
	4050, 4055, 4250, 4255, 4450, 4455, 4555, 4560, 4650, 4755, 4760, 4850, 4955, 4960 - w/ MFWD Axle	Tie Rod Tube 19.50" Long 1.125"x12 Right Hand/Left Hand Internal Thread	AMR78024	\$ 26.50	
	4050, 4055, 4250, 4255, 4450, 4455, 4555, 4560, 4650, 4755, 4760, 4850, 4955, 4960, 7600 BSN 036466, 7700 BSN 036466, 7800 BSN 036466 - w/ MFWD	Inner Tie Rod 5.875" Long, 1.125" Diameter Right Hand Thread	AMRE12325	\$ 50.00	
	4050, 4055, 4250, 4255, 4450, 4455, 4555, 4560, 4650, 4755, 4760, 4850, 4955, 4960, 7600 BSN 036466, 7700 BSN 036466, 7800 BSN 036466 - w/ MFWD	Outer Tie Rod 5.875" Long, 1.125" Diameter Left Hand Thread	AMRE12326	\$ 55.00	
	4555, 4560, 4630, 4640, 4650, 4755, 4760 - w/ Regular Wide Front Axle	Inner Tie Rod 3.437" Long, 1" Diameter Right Hand Thread	AMAR63589	\$ 30.00	
	4555, 4560, 4630, 4640, 4650, 4755, 4760	Tie Rod Assembly	AMAR44340	\$ 102.50	









John Deere®—Tractor

Application	Description	Part Number	Retail Price	Core
4555, 4560, 4630, 4640, 4650, 4755, 4760 - w/ Extra Wide Front Axles	Tie Rod Assembly	AMAR44341	\$ 190.93	
 4555, 4560, 4630, 4640, 4650, 4755, 4760	Outer Tie Rod 16.25" Long, 1.116" Diameter, 8 Cross Holes	AMAR63833	\$ 45.00	
4555, 4560, 4630, 4640, 4650, 4755, 4760 - w/ Wide Adjustable Tread Front Axle	Tie Rod Tube 19.8125" Long, 1.143" ID 1.00"x16 Internal Thread	AMR54968	\$ 120.84	
4640 ASN 002436	Tie Rod Assembly	AMAR44342	\$ 186.86	
4640 ASN 002436 w/ PFWD	Tie Rod Tube 1.125"x12 Internal Thread 19.75" Long, 1.215" ID	AMR66303	\$ 68.00	
 4640 ASN 002437 w/ MFWD	Tie Rod 21" Long, 1.18" Diameter, 8 Cross Holes	AMAR85947	\$ 45.00	
 4640 ASN 002437 w/ MFWD, (4840, 4850, 4955, 4960 - w/ Wide Axle)	Tie Rod 4.871" Long, 1.125" Diameter 12 Thread	AMAR85943	\$ 23.00	
4840, 4850, 4955, 4960 - w/ Regular Wide Front Axle	Tie Rod Assembly	AMAR44343	\$ 100.00	
 4840, 4850, 4955, 4960 - w/ Regular Wide Front Axle	Inner Tie Rod 3.875" Long, 1.125" Diameter 12 Right Hand Thread	AMAR85945	\$ 29.00	
 4840, 4850, 4955, 4960 - w/ Regular Wide Front Axle	Outer Tie Rod 15.875" Long, 1.187" Diameter, 8 Holes	AMAR85946	\$ 45.00	
4840, 4850, 4955, 4960 - w/ Regular Wide Front Axle	Tie Rod Tube 17" Long, 1.215" ID 12 Thread	AMR66305	\$ 116.97	
4840, 4850, 4955, 4960 - w/ Extra Wide Front Axles	Tie Rod Assembly	AMAR44344	\$ 171.00	
4840, 4850, 4955, 4960 - w/ Wide Adjustable Axle	Tie Rod 18.50" Long, 1.186" OD, 9 Cross Holes	AMAR85944	\$ 68.69	
4840, 4850, 4955, 4960 - w/ Wide Adjustable Tread Axle	Tie Rod Tube 20.75" Long, 1.215" ID 1.125"x12 Internal Thread	AMR66304	\$ 41.00	
 5045E, 5055E, 5065E, 5065M, 5075E, 5075M, 5076E, 5082E, 5083E, 5085E, 5085M, 5090E, 5090EH Hi-Clearance, 5093E, 5095M, 5095MH, 5100E, 5100M, 5100MH, 5100ML, 5101E, 5103 ASN 013640, 5105M, 5115M, 5115ML, 5203 ASN 005569, 5225, 5303 ASN 007752, 5325, 5403 ASN 001357, 5415, 5415H, 5425, 5525, 5603, (5605, 5705 ASN 080729), 5615, 5625, 5715, 5715HC, 5725 ASN 005048 - w/ MFWD	Tie Rod End	AMRE271441	\$ 103.00	
 5045E, 5055E, 5065E, 5065M, 5075E, 5075M, 5076E, 5082E, 5083E, 5085E, 5085M, 5090E, 5090EH Hi-Clearance, 5093E, 5095M, 5100E, 5100M, 5100MH, 5100ML, 5101E, 5103 ASN 013640, 5105M, 5105ML, 5115M, 5115ML, 5203 ASN 005569, 5225, 5303 ASN 007752, 5325, 5403 ASN 001357, 5415, 5415H, 5425, 5525, 5603, (5605, 5705 ASN 080729), 5615, 5625, 5715, 5715HC, 5725 ASN 005048 - w/ MFWD	Ball Joint	AMRE271440	\$ 120.00	
5075M, 5076E, 5076EL, 5085M, 5090M, 5095M, 5100M, 5100ML, 5103, 5105, 5105M, 5105ML, 5115ML, 5200, 5203, 5205, 5210, 5220, 5300, 5303, 5310, 5320, 5325, 5400, 5403, 5410, 5420 w/ SyncShuttle™ Transmission BSN 443960, 5425, 5500, 5510, 5520 w/ SyncShuttle™ Transmission BSN 453301, 5525, 5625	Tie Rod End 7.75" Long, 1.50" ID	AMRE217819	\$ 128.51	













John Deere®—Tractor

Application	Description	Part Number	Retail Price	Core
5080R, 5080RN, 5090R, 5090RN, 5100R, 5100RN, 5620, 5720, 5820	Tie Rod, Long Replaces RE212814	AMAL178288	\$ 82.65	
 5082E, 5090E, 5090EH, 5103 BSN 013639, 5105 ASN 411495, 5203 BSN 005568, 5205 ASN 421398, 5220 ASN 420011, 5225, 5303 BSN 007751, 5320 ASN 430009, 5325, 5403 BSN 001356, 5415 ASN 005886, 5420 ASN 440015, 5425, 5520 ASN 450005, 5525, 5603, 5615 ASN 004120, 5625, 5715 ASN 008634	Tie Rod Assembly Also Includes Jam Nut	AMRE204877	\$ 182.50	
 5090E, 5090EH Hi-Clearance, 5103, 5105, 5203, 5205, 5220, 5225, 5303, 5320, 5325, 5403, 5415 ASN 005886, 5420, 5425, 5520, 5525, 5603, 5615 ASN 004120, 5625, 5715 ASN 008634, 5725 ASN 005048 - w/ MFWD	Tie Rod End	AMRE204878	\$ 70.00	
 5090E, 5090EH Hi-Clearance, 5103 BSN 103639, 5105 BSN 411494, 5200, 5203 BSN 005568, 5205 BSN 421397, 5210, 5220, 5225, 5300, 5303 BSN 007751, 5310, 5320, 5325, 5400, 5403 BSN 001356, 5410, 5415 ASN 005886, 5420, 5425, 5500, 5510, 5520, 5525, 5603, 5615 ASN 004120, 5625, 5715 ASN 008634, 5725 ASN 005048 - w/ MFWD	Tie Rod End	AMRE204879	\$ 59.00	
 5103 BSN 001433, (5200, 5300, 5400, 5500 ASN 008158), 5203 BSN 001134, 5210, 5220, 5303 BSN 001080, 5310, 5320, 5410, 5415 BSN 005672, 5420, 5510, 5520, 5615 BSN 004136, 5715 BSN 008654 - 2WD	Ball Joint 6.375" Long M18x1.50" and M20x1.50" Right Hand Thread	AMRE45997	\$ 60.00	
5105, 5200, 5205, 5210, 5220 BSN 420010, 5300, 5310, 5320 BSN 430008, 5400, 5410, 5415 BSN 005885, 5420 BSN 440014, 5500, 5510, 5520 BSN 450004, 5615 BSN 004119, 5615HC, 5715 BSN 008633, 5715HC	Tie Rod Assembly, Right Hand Includes Tie Rod, Ball Joint and Jam Nut	AMRE55066	\$ 103.50	
 5105 BSN 411494, 5200, 5205 BSN 421397, 5210, 5220, 5300, 5310, 5320, 5400, 5420, 5410, 5415 BSN 005885, 5425 ASN 002632, 5500, 5510, 5520, 5615 BSN 004119, 5625 ASN 001689, 5715 BSN 008633, 5715HC, 5725 ASN 005048 - w/ MFWD	Tie Rod Assembly 6.75" Long M18x1.50" Right Hand Thread	AMRE54957	\$ 50.00	
 5105, 5205 - w/ Adjustable Steering Cylinder	Tie Rod End, Left Hand 3.75" Long M22x1.50" Left Hand Internal Thread	AMR206539	\$ 104.78	
 5130 BSN 001433, 5200, 5203 BSN 001134, 5210, 5220, 5300, 5303 BSN 001080, 5310, 5320, 5400, 5403, 5410, 5415 BSN 005672, 5420 BSN 443959, 5500, 5510, 5520 BSN 453300, 5615 BSN 004136, 5715 BSN 008654	Tie Rod End 8" Long, 1.50" Diameter Replaces SJ16769	AMRE46000	\$ 73.50	
 6010, 6110, 6110L, 6120, 6120L, 6210, 6210L, 6215, 6220, 6220L, 6300, 6300L, 6310, 6310L, 6310S, 6320, 6320L, 6400, 6400L, 6403	Tie Rod, Right Hand 10" Long M24x1.50" Right Hand Internal Thread	AMAL168709	\$ 160.00	
 6010, 6110, 6110L, 6120, 6120L, 6210, 6210L, 6215, 6220, 6220L, 6300, 6300L, 6310, 6310L, 6310S, 6320, 6320L, 6400, 6400L, 6403	Tie Rod, Left Hand 10" Long M24x1.50" Right Hand Internal Thread	AMAL168708	\$ 160.00	
 6010, 6110, 6110L, 6120, 6120L, 6210, 6210L, 6215, 6220, 6220L, 6300, 6300L, 6310, 6310L, 6310S, 6320, 6320L, 6400, 6400L, 6403 - w/ MFWD	Ball Joint 8.20" Long M22x1.50" and M24x1.50" Right Hand Threads	AMAL168711	\$ 95.00	
 6010 w/ APL2025/AS2025 Front Axle, (6110, 6110L, 6210, 6210L, 6300, 6310, 6310L, 6400 - w/ APL2025/APL2035 or AS2025/AS2035 Front Axle), (6120, 6120L, 6220, 6220L - w/ AS2025 Front Axle), 6215 w/ AS2025/AS2035 Front Axle, (6300L, 6400L - w/ APL2035/AS2035 Front Axle), (6310S, 6320L, 7220, 7320 - w/ MFWD), (6320, 6403 - w/ AS2035 Front Axle), (6800, 6810 - APL2045/AS2045 Front Axle), (7210, 7410 - w/ ZF Front Axle ASN 052869 Excludes Hi-Crop)	Tie Rod, Right Hand	AMAL116559	\$ 270.00	





John Deere®—Tractor

Application	Description	Part Number	Retail Price	Core
 6010 w/ APL2025/AS2025 Front Axle, (6110, 6110L, 6210, 6210L, 6300, 6310, 6310L, 6400 - w/ APL2025/APL2035 or AS2025/AS2035 Front Axle), (6120, 6120L, 6220, 6220L - w/ AS2025 Front Axle), 6215 w/ AS2025/AS2035 Front Axle, (6300L, 6400L - w/ APL2035/AS2035 Front Axle), (6310S, 6320L, 7220, 7320 - w/ MFWD), (6320, 6403 - w/ AS2035 Front Axle), (6800, 6810 - APL2045/AS2045 Front Axle), (7210, 7410 - w/ ZF Front Axle ASN 052869 Excludes Hi-Crop)	Tie Rod, Left Hand	AMAL116558	\$ 270.00	
 6020, 6100D, 6110D, 6115D, 6120, 6125D, 6130, 6130D, 6140D, 6215, 6220, 6225, 6320, 6330, 6403, 6415, 6420, 6425, 6430, 6515, 6520, 6603, SE6020, SE6120, SE6220, SE6320, SE6420, SE6520, SE6620	Outer Tie Rod 6.75" Long M24x1.50" Right Hand Thread	AMAL161338	\$ 95.00	
6105M, 6105R, 6110M, 6110R, 6115M, 6115R, 6120M, 6120R, 6125M, 6125R, 6130M, 6130R	Tie Rod End Replaces AL211652	AMAL222371	\$ 143.85	
 6105M, 6105R, 6110M, 6110R, 6115M, 6115R, 6120M, 6120R, 6125M, 6125R, 6130M, 6130R, 6140M	Tie Rod Assembly Replaces AL209979	AMAL222370	\$ 183.19	
 (6120, 6120L, 6215, 6220, 6220L, 6320, 6320L, 6415, 6420, 6420L - w/ 733 Axle), (6403, 6603 - w/ DANA® Axle), Premium Models: (6230, 6330, 6430 - w/ 733 Axle)	Ball Joint Assembly	AMAL161341	\$ 95.00	
 (6120, 6120L, 6220, 6220L - w/ 730/733 Axle w/ or w/o TLS™), (6215, 6415 - w/ 733 Axle), (6230 w/ 730/733 Axle w/o TLS™), (6320, 6420 - w/ 733 Axle w/ or w/o TLS™), 6320L, 6420L, 6520L w/ Cab, (6330, 6430 - w/ 730/733 Axle), Premium Models: (6230 w/ 730/733 Axle w/ or w/o TLS™), (6330, 6430 - w/ 733 Axle)	Ball Joint Use w/ AL204774 Tie Rod Assembly	AMAL204777	\$ 140.72	
 (6120, 6220, 6320L, 6420L, 6520L - w/ 730 Axle) 6215, 6220L, 6415, Premium Model: 6230 w/ TLS™ Suspension	Ball Joint 8.20" Long M22x1.50" Right Hand Thread M24x1.50" Right Hand Thread	AMAL161302	\$ 110.00	
(6140J, 6155J, 7210**, 7410**, 7420, 7510**, 7520 - w/ Hi-Crop w/ MFWD), (7210*, 7410*, 7510* - w/ MFWD), (7610, 7630, 7710, 7720, 7730, 7810, 7820, 7830, 7920, 7930 - w/ MFWD and TLS™), Premium Model: 7330 w/ Hi-Crop w/ MFWD *w/ Axle SN 000001-000999 & SN 800001-820944 **w/ Axle SN 000001-000999 & ASN 800000	Tie Rod End, Right Hand 10" Long, 1.625" OD 1.25"x12 UNF Right Hand Internal Thread Replaces RE214057, RE261925	AMRE161021	\$ 197.00	
(6140J, 6155J, 7210**, 7330, 7420, 7510**, 7520 - w/ Hi-Crop w/ MFWD), (7210*, 7410*, 7510* - w/ MFWD), (7610, 7630, 7710, 7720, 7730, 7810, 7820, 7830, 7920, 7930 - w/ MFWD and TLS™), Premium, 7410** w/ Hi-Crop w/ MFWD *w/ Axle SN 000001-000999 & SN 800001-820944 **w/ Axle SN 000001-000999 & ASN 800000	Tie Rod End, Left Hand 10" Long, 1.625" OD 1.25"x12 UNF Left Hand Internal Thread Replaces RE214058, RE261923, RE261926	AMRE161022	\$ 199.55	
(6140J, 6155J, 7210*, 7410*, 7420, 7510*, 7520 - w/ Hi-Crop w/ MFWD), (7210*, 7410*, 7510* - w/ MFWD), (7610, 7630, 7710, 7720, 7730, 7810, 7820, 7830, 7920, 7930 - w/ MFWD and TLS™), Premium Model: 7330 w/ Hi-Crop w/ MFWD *w/ Axle SN 000001-000999 & SN 800001-820944	Tie Rod Assembly, Right Hand Replaces RE161182, RE214053, RE261923	AMRE161019	\$ 267.62	
 6140J, 6155J, (7210, 7410, 7510 BSN 001000 and SN 080001-082944), 7330 Premium, (7610, 7710, 7810 BSN 001000 and ASN 080000), 7630, 7715, 7720, 7730, 7815, 7820, 7830, 7920, 7930	Ball Joint, Right Hand 9.625" Long 12UNFx1.00" and 12UNFx1.25" Right Hand Threads Replaces RE150906	AMRE214055	\$ 95.00	
 (6140J, 6155J MFWD - w/ Hi-Crop), (7210, 7410, 7510, 7610, 7710, 7810 Axle ASN 813698), 7330 Premium w/ Hi-Crop, 7630, 7720, 7730, 7820, 7830, 7920, 7930	Ball Joint, Left Hand 9.625" Long 12UNFx1.25" Left Hand Threads 12UNFx1.00" Right Hand Threads Replaces RE161023	AMRE214056	\$ 95.00	

John Deere®—Tractor

	Application	Description	Part Number	Retail Price	Core
	6140J, 6155J, 7420, 7520 - w/ MFWD	Tie Rod Assembly	AMAL160111	\$ 225.00	
	6140M, 6140R, (6145R, 6155R, 6155RH BSN 027000), 6150M, 6150R, 6150RH, 6170M, 6170R, 6175R, 6615, 6715, 7130, 7230, 7330, 7420, 7430, 7520, 7530	Tie Rod End 8.50" Long M28x1.50" Right Hand Thread Replaces AL160542, AL209601	AMAL160203	\$ 113.61	
	6140M, 6615, 6715, 7130, (7220, 7320 Axle ASN 002762), 7230 - w/ MFWD	Ball Joint 9.50" Long M26x1.50" Right Hand Thread, Short Threads M28x1.50" Right Hand Thread, Long Threads Replaces AL160543	AMAL209420	\$ 128.57	
	6200, 6200L, 6300L, 6400L	Tie Rod, Right Hand	AMAL110343	\$ 195.00	
	6200, 6200L, 6300L, 6400L	Tie Rod, Left Hand	AMAL110342	\$ 205.00	
	6200, 6200L, 6300L, 6400L	Ball Joint	AMAL177964	\$ 70.00	
	6200, 6200L, 6300L, 6400L, 6500L - w/ MFWD	Tie Rod, Right Hand 11.25" Long M20x1.50" Right Hand Thread Replaces AL80538	AMAL110956	\$ 75.00	
	6200, 6200L, 6300L, 6400L, 6500L - w/ MFWD	Tie Rod, Left Hand 11.25" Long M22x1.50" Right Hand Thread Replaces AL80537	AMAL110957	\$ 75.00	
	6215, 6230, 6330, 6415, 6430, 6615, 6715, 7130, 7230, 7330	Tie Rod M22x1.50" Right Hand Thread	AMAL178283	\$ 105.00	
	6215, 6230, 6330, 6415, 6430, 6615, 6715, 7130, 7230, 7330	Ball Joint 9.50" Long M22x1.50" and M24x1.50" Right Hand Thread	AMAL178284	\$ 74.00	
	6620 BSN 502550, 7720 BSN 507350, 8820 BSN 513950 - w/ Heavy Duty Axle	Tie Rod End 4.875" Long, 1" Diameter 16 Right Hand Thread	AMAH101185	\$ 69.47	
	6900, 6910, 6920, 7405, 7420, 7500, 7505, 7510, 7520	Tie Rod	AMAL119215	\$ 175.00	
	7130, 7220, 7230 ASN 002762 - w/ MFWD	Tie Rod Assembly	AMAL160539	\$ 315.00	
	7200, 7210, 7400, 7410, 7510, 7600, 7610, 7700, 7710, 7800, 7810 - w/ MFWD	Tie Rod Assembly	AMRE66620	\$ 324.69	
	(7200, 7400 ASN 006400), 7210, 7410, 7510, (7600, 7700, 7800 ASN 036467), 7610, 7710, 7810 - All w/ MFWD	Tie Rod 5.50" Long, 1 1/8" Diameter 12 UNF Right Hand Thread	AMRE66622	\$ 80.69	
	(7200, 7400 ASN 006400), 7210, 7410, 7510, (7600, 7700, 7800 ASN 036467), 7610, 7710, 7810 - All w/ MFWD	Tie Rod 5.50" Long, 1 1/8" Diameter 12 UNF Left Hand Thread	AMRE66623	\$ 82.89	
	7200, 7210, 7400, 7410, 7510, (7600, 7800 ASN 036467), 7610, 7710, 7810 - w/ MFWD	Tie Rod Tube 46.19" Long, 1 1/8" ID 12 UNF Right and Left Hand Internal Thread	AMR131288	\$ 243.57	
	7210, 7330, 7410, 7420, 7510, 7520, 7610, 7630, 7710, 7720, 7730, 7810, 7820, 7920, 7930	Tie Rod Assembly, Left Hand Replaces RE155929, RE161020, RE214054	AMRE261924	\$ 353.14	

John Deere®—Tractor



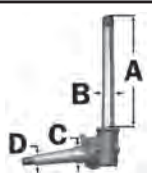
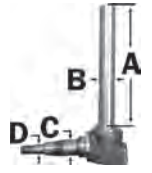
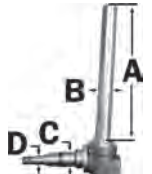
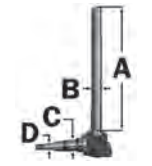

Application	Description	Part Number	Retail Price	Core
 8100, 8110, 8120, 8200, 8210, 8220, 8300, 8310, 8320, 8400, 8410, 8420	Tie Rod, Right Hand 1.25" Diameter 12 Right Hand Thread	AMRE173540	\$ 112.00	
 8100, 8110, 8120, 8200, 8210, 8220, 8300, 8310, 8320, 8400, 8410, 8420	Tie Rod, Left Hand 1.25" Diameter 12 Left Hand Thread	AMRE173541	\$ 123.99	
 Utility: 3033R, 3039R, 3046R, 3120, 3203, 3320, 3520, 3720, 4044M, 4044R, 4052M, 4052R, 4066M, 4066R, 4105, (4120, 4320, 4520, 4720 ASN 470001), 4200, 4210, (4300, 4400 - w/ S20BZ107-1 Axle), 4310, 4410, 4500, 4600, 4700 w/ S20BZ108-1 or S20BZ112-1 Axle	Tie Rod, Right Hand 0.86" Tapered Length M24x1.50" Right Hand Thread	AMLVA14959	\$ 55.00	
 Utility: 3033R, 3039R, 3046R, 3120, 3203, 3320, 3520, 3720, 4044M, 4044R, 4052M, 4052R, 4066M, 4066R, 4105, (4120, 4320, 4520, 4720 ASN 470001), 4200, 4210, (4300, 4400 - w/ S20BZ107-1 Axle), 4310, 4410, 4500, 4600, 4700 w/ S20BZ108-1 or S20BZ112-1 Axle	Tie Rod, Left Hand 0.86" Tapered Length M24x1.50" Left Hand Thread	AMLVA14960	\$ 55.00	
Utility: 3120, 3320, 3520, 3720, 4120, 4200, 4300, 4400, 4500, 4510, 4520, 4600, 4610, 4700, 4710, 4720	Tie Rod 4" Long, 1" Diameter 16 Right Hand Thread	AMLVA10728	\$ 72.95	
Utility: 4200, 4210, 4300, 4310, 4400	Tie Rod 3.50" Long, 1/2" Diameter 20 UNF Right Hand Thread Replaces 1404-1070	AMLVU14549	\$ 70.37	
Utility: 4200, 4210, 4300, 4310, 4400	Tie Rod End	AMLVU14531	\$ 61.50	

Spindles

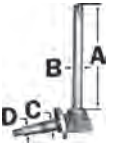
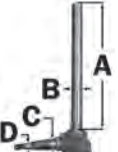
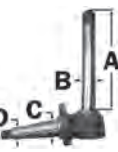
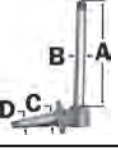

Spindles are forged from high grades of alloy steel, machined and assembled to exact specifications.

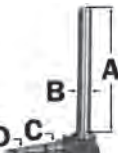
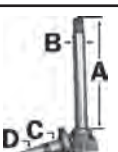
Application	Description	Part Number	Retail Price	Core
 50, 60, 70, 520, 530, 620, 630, 720, 730, A, AO, AR, B, G, GH - Row Crop Tractors, Factory Wide Fronts Only	Spindle A - 14.375 B - 1.50 C - 1.625 D - 1.312	Right or Left Hand Wheel Bearing Kit AMAA5789R WBK-JD-1	\$ 332.18 \$ 85.00	
 820, 820U, 830, 1020, 1520, 1530, 2020, 2030, 2040, 2240	Spindle Replaces AR52862, AR58608 A - 9.875 B - 1.375 C - 1.375 D - 0.842	Right or Left Hand Wheel Bearing Kit AMAR103473 WBK-JD-3	\$ 146.50 \$ 31.00	
 920, 930, 1020, 1030, 1120, 1130, 1630, 1640, 2020, 2150, 2255, 2350, 2355, 2555, 2755, Utility: 820, 830, 2155	Spindle Replaces AR49589, AT23636 A - 11.875 B - 1.375 C - 1.375 D - 0.842	Right or Left Hand Wheel Bearing Kit AMAR58606 WBK-JD-2	\$ 135.00 \$ 30.00	
 (940, 1020, 1030, 1040 European), 1120, 1130, 1140, 1550, 1630, 1750, 1850, 2020, Utility: 2155 w/ Hi-Straight Axle	Spindle A - 15.312 B - 1.375 C - 1.375 D - 0.842	Right or Left Hand Wheel Bearing Kit AMAR58607 WBK-JD-2	\$ 140.00 \$ 30.00	



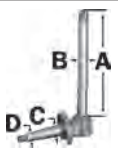
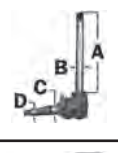
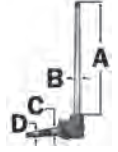

John Deere®—Tractor

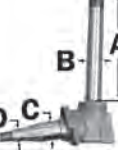
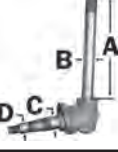
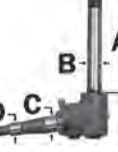
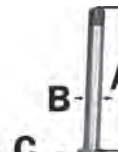
	Application	Description		Part Number	Retail Price	Core
	1020, 1120, 1130, 1520, 1630 BSN 242099, 1830, 2020, 2030 BSN 242099, 2120, 3030, 3120, 3130 BSN 186269	Spindle	Right or Left Hand	AMAL19730	\$ 160.00	
		A - 14.875 B - 1.50 C - 1.687 D - 1.312	Wheel Bearing Kit	WBK-JD-6	\$ 38.00	
	(1020, 1520, 1530, 2020, 2630 - w/ Straight Axle), 2030, 2440 Early, 2640 Early, Utility: 2240	Spindle	Right or Left Hand	AMAR103471	\$ 171.62	
		A - 15.312 B - 1.375 C - 1.375 D - 0.842	Wheel Bearing Kit	WBK-JD-3	\$ 31.00	
	1020, 1520, 2020, 2030, 2630, 2440, 2640 BSN 340999 - w/ Medium Knee	Spindle	Right or Left Hand	AMAR67417	\$ 426.55	
		A - 11.50 B - 1.50 C - 1.795 D - 1.312	Wheel Bearing Kit	WBK-JD-7	\$ 40.00	
	1020 Heavy Duty, 1520, 2020, 2030, 2630, 2440, 2640 BSN 34099 - w/ High Knee	Spindle	Right or Left Hand	AMAR67416	\$ 470.18	
		A - 14.875 B - 1.50 C - 1.795 D - 1.312	Wheel Bearing Kit	WBK-JD-7	\$ 40.00	
	1130, 1630, 1640, 1830, 2040, 2140, 2350, 2550, 2355, 2555, 2755	Spindle	Right or Left Hand	AMAL28222	\$ 160.00	
		High Knee Replaces AR67416 A - 14.875 B - 1.50 C - 1.795 D - 1.312	Wheel Bearing Kit	WBK-JD-7	\$ 40.00	
	1020, 1520, 1530, 2030, 2040, 2630, 2640, 2440 BSN 340999, 2020, Utility: 820, 830, 2240 - All w/ Swept-Back	Spindle	Right or Left Hand	AMAR103472	\$ 164.00	
		Replaces AR52861 A - 11.875 B - 1.375 C - 1.375 D - 0.842	Wheel Bearing Kit	WBK-JD-3	\$ 31.00	
	(2140 ASN 430000, 2350, 2550, 2355, 2555, 2755 - w/ HD Axles), 2840, 2940, 2750, 2950, (3030, 3130 ASN 186270)	Spindle	Right or Left Hand	AMAR74606	\$ 185.00	
		A - 14.75 B - 1.75 C - 1.795 D - 1.312	Wheel Bearing Kit	WBK-JD-7	\$ 40.00	
			Thrust Washer	AMR49838	\$ 2.50	
	2150, 2255, 2350, 2355, 2550, 2555, 2750, 2755, 6110L, 6120L, 6200, 6200L, 6210L, 6220L, (6230, 6330, 6430 BSN 647868), 6300, 6300L, 6310L, 6310S, 6320L, 6400, 6400L, 6410L, 6410S, 6420L, 6500, 6500L, 6510L, 6510S, 6520L, Utility: 2155	Spindle	Right or Left Hand	AMAL38381	\$ 140.00	
		A - 9.25 B - 1.50 C - 1.795 D - 1.312				
	2355, 2555, 2755	Spindle Mid Knee A - 12.00 B - 1.50 C - 1.795 D - 1.312	Right or Left Hand	AMAL57578	\$ 519.50	



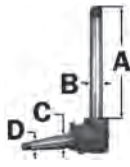
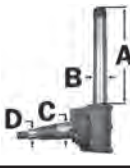

John Deere®—Tractor

	Application	Description		Part Number	Retail Price	Core
	2440, 2640 ASN 331510 - w/ Hi-Knee	Spindle A - 14.875 B - 1.50 C - 1.625 D - 1.25	Right or Left Hand	AMAR76933	\$ 320.69	
	2440, 2640 ASN 341000 - w/ Straight Axle	Spindle A - 15.312 B - 1.375 C - 1.625 D - 1.25	Right or Left Hand	AMAR91150	\$ 370.24	
	2510, 2520 ASN 022001, 3010, 3020, 4000, 4010, 4020, 4320, Cotton Picker: 9900 - All w/ Row Crop Front Axle	Spindle A - 15.125 B - 1.50 C - 1.687 D - 1.312	Right or Left Hand Wheel Bearing Kit	AMAR55160 WBK-JD-6	\$ 140.00 \$ 38.00	
	2510, 2520, 3020, 4000, 4010, 4020	Hi-Crop Spindle A - 27.375 B - 1.50 C - 1.687 D - 1.312	Left or Right Hand Wheel Bearing Kit	AMAR50981 WBK-JD-6	\$ 255.00 \$ 38.00	
	2640 ASN 341000 w/ Straight Non-Adjustable Axle, Inc: (300, 400 ASN 136912), 300B, 301A, 302, 302A, 401, 401B, 401C	Spindle A - 10.125 B - 1.75 C - 1.795 D - 1.312	Right or Left Hand	AMAT33636	\$ 557.85	
	2955, 3055, 6110, 6110L, 6120, 6200, 6200L, 6210, 6210L, 6215, 6220, 6300, 6300L, 6310, 6310L, 6310S, 6320, 6400, 6400L, 6403, 6405, 6410, 6410L, 6415, 6420, 6500, 6500L, 6510, 6510L, 6510S, 6603, 6605, 6615, 6715	Spindle A - 12.25 B - 1.75 C - 1.968 D - 1.312	Right or Left Hand Wheel Bearing Kit	AMAL57855 WBK-JD-8	\$ 637.35 \$ 35.00	
	3010, 3020, 4000, 4010, 4020, 4320 - w/ Standard Fixed Front Axle	Spindle A - 12.75 B - 1.50 C - 1.687 D - 1.312	Right or Left Hand Wheel Bearing Kit	AMAR55179 WBK-JD-6	\$ 140.00 \$ 38.00	
	3010, 3020, 4000, 4020 - Row Crop Utility Tractors	Spindle A - 10.75 B - 1.50 C - 1.687 D - 1.312	Right or Left Hand Wheel Bearing Kit	AMAR50983 WBK-JD-6	\$ 215.00 \$ 38.00	
	4030	Spindle A - 14.75 B - 1.50 C - 1.795 D - 1.312	Right or Left Hand	AMAR53850	\$ 545.16	
	4030 Wide or Narrow, 4040, 4050, 4055, 4230, 4240, 4250, 4255, 4430, 4440, 4450, 4455, 7200 Hi-Crop, 7210 BSN 010920, 7400 Hi-Crop, 7410 BSN 011540, 7510, 7600, 7700, 7800, Cotton Pickers: 9910, 9920, 9930	Spindle Replaces RE57643 A - 14.687 B - 1.75 C - 1.968 D - 1.312	Right or Left Hand Wheel Bearing Kit	AMAR81954 WBK-JD-8	\$ 205.00 \$ 35.00	

John Deere®—Tractor

Application	Description	Part Number	Retail Price	Core
 4030 w/ Regular Front Axle, 4230, 4430	Spindle	Right or Left Hand	AMAR69323	\$ 215.00
	A - 14.687 B - 1.75 C - 1.795 D - 1.312	Wheel Bearing Kit	WBK-JD-7	\$ 40.00
4050, 4240, 4250, 4255, 4430, 4440	Hi-Crop Spindle	Right or Left Hand	AMAR82754	\$ 549.36
	A - 28.625 B - 1.75 C - 1.968 D - 1.312			
 4555, 4560, 4630, 4640, 4650, 4755, 4760, 4840, 4850, 4955, 4960, Cotton Pickers: 9940, 9950, 9960, 9965	Spindle	Right or Left Hand	AMAR53880	\$ 290.00
	Replaces RE57644	Wheel Bearing Kit	WBK-JD-10	\$ 76.00
	A - 14.75 B - 2.00 C - 2.25 D - 1.437			
 5103, 5200, 5203, 5210, 5220, 5300, 5303, 5310, 5320, 5400, 5403, 5410, 5415	Spindle	Right Hand	AMRE208805	\$ 350.00
	Requires AMRE208806	Left Hand	AMRE208804	\$ 350.00
	Outer Bearing if Replacing RE45882 Right Hand or RE45883 Left Hand Spindle	Bearing	AMRE208806	\$ 42.00
	A - 9.625 B - 1.377 C - 1.771 D - 1.181			
5105, 5205	Spindle	Right or Left Hand	AMRE73022	\$ 461.63
	A - 10.00 B - 1.378 C - 1.378 D - 0.984			
6140R, 6145M, 6145R, 6150M, 6150R, 6155M, 6155R, 6170M, 7210 ASN 010921, 7220, 7320, 7410 ASN 011541, 7420, 7510 ASN 030000, 7610, 7710, 7810, Premium Model: 7130	Spindle	Right or Left Hand	AMRE71278	\$ 361.32
	A - 12.937 B - 1.745 C - 1.967 D - 1.312			
 7200, 7210 BSN 010920, 7400, 7410 BSN 011540, 7510 BSN 030000	Spindle	Right or Left Hand	AMRE57642	\$ 250.00
	A - 12.937 B - 1.745 C - 1.967 D - 1.312			
7210 ASN 010922, 7410 ASN 011542, 7510 ASN 030001, 7610 ASN 010665, 7710 ASN 011301, 7810 ASN 013024	Hi-Crop Spindle	Right or Left Hand	AMRE71277	\$ 363.11
	A - 14.687 B - 1.745 C - 1.967 D - 1.312			
8100, 8200, 8300	Spindle Kit Includes AMAR53880 Spindle and Nut		AMAN277398	\$ 270.00
	A - 14.75 B - 2.00 C - 2.25 D - 1.437			
 Ind: 401D	Spindle	Right or Left Hand	AMAT76758	\$ 703.37
	A - 9.313 B - 1.747 C - 1.795 D - 1.312			

John Deere®—Tractor

Application	Description	Part Number	Retail Price	Core
40 ASN 69404 w/ Standard Axles, (320, 330, 420, 430 - w/ Standard Axles), 940, 1010 SN 010001-042000 Single Row Crop, 1020, 1030, 1040, 1120, 1130, 1140, 1520, 1530, 1550, 1630, 1750, 1850, 1950, 2020, 2030, 2040, 2120, 2150, 2250, 2255 w/ Swept-Back Axle, 2350 Low Profile, (2355, 2555, 2755 - w/ Mid-High Axle), 2440, 2630, 2640, Utility: (820, 830 - w/ 3 Cylinder Engine), 2155	Thrust Washer	AMM2283T	\$ 2.08	
	(50, 60, 70, 520, 530, 620, 630, 720, 730, A, AO, AR, B, G, GH - w/ Factory Wide Fronts), 2510, 2520, 3010, 3020, 4000, 4010, 4020, 4230, 4320	Thrust Washer 1.50" ID, 2.75" OD (2) Required Per Spindle	AMA890R	\$ 6.00
	2955, 3055, 4030, 4040, 4050, 4055, 4230, 4240, 4250, 4255, 4430, 4440, 4450, 4455, 6100, 6110, 6120, 6200, 6210, 6220, 6300, 6310, 6320, 6400, 6410, 6420, 6510, 6520, 6605, 6610, 6620, 7200, 7210 BSN 010920, 7400, 7410 BSN 011540, 7510, 7600, 7610, 7700, 7710, 7800, 7810	Thrust Washer (2) Required Per Spindle	AMR49838	\$ 2.50
	4555, 4560, 4630, 4640, 4650, 4755, 4760, 4840, 4850, 4955, 4960, 5020, 6030, 8100, 8110, 8120, 8200, 8210, 8220, 8300, 8310, 8320, 8400, 8410, 8420, 8520	Thrust Washer (2) Required Per Spindle	AMR30398	\$ 11.69
	1020, 1030, 1120, 1130, 1520, 1630, 1640, 1830, 2020, 2030, 2040, 2120, 2130, 2140, 2150, 2350, 2355, 2440, 2550, 2555, 2630, 2640, 2650, 2750, 2755, 2855, 3030, 3120, 3130, 6110, 6120, 6200, 6210, 6220, 6300, 6310, 6320, 6400, 6410, 6420, 6500, 6510, 6520, Utility: 2155	Bushing Use on Spindles: AL19730, AL28222, AL38381, AL57578, AR67416, AR67417, AR76932, AR76933, AT34973, AT35227, AT35277, AT39457	AMT21553	\$ 9.00

John Deere®—Tractor

Application	Description	Part Number	Retail Price	Core
5045D, 5045E, 5055D, 5065E, 5065M, 5075E, 5075M, 5076E, 5076EL, 5082E, 5085M, 5090M, 5095M, 5100M, 5103 ASN 001483, (5105, 5205 - w/ Fixed Steering Cylinder), 5105M, 5105ML, 5115ML, 5203 ASN 001134, 5303 ASN 001080, 5325, 5403, 5415, 5420 w/ SyncShuttle™ Transmission ASN 443959, 5520 w/ SyncShuttle™ Transmission ASN 453300, 5615, 5715	Spindle Bushing 1.752" ID, 1.971" OD	AMR217605	\$ 25.99	



Wheel Hubs and Components

Application	Description	Part Number	Retail Price	Core
820 ASN 042925, 830 Non-Utility, 920 ASN 042925, 940, 1020 ASN 042925, 1030*, 1040, 1120 ASN 042925, 1130*, 1140, 1630*, 1640 Low Type, 2020 ASN 042925, 2040 ASN 350000, 2120 ASN 042925, 2150 Non-General Purpose, 2155, 2255, 2355N, 2240, 2350 Low Type, 2355*, 2550 Low Type, 2555*, 2755*, 2855N*	Wheel Hub, 6-Bolt Uses Press-In Style Hub Cap AMT12688 *w/ Standard Front Axle	AMR47076	\$ 95.00	
	Wheel Hub Cap Press In-Style Wheel Hub Cap For Use w/ AMR47076 Hub *w/ Standard Front Axle	AMT12688	\$ 5.00	
1020, 1120, 1520, 1530, 2010, 2020, 2030, 2040, 2120, 2440 (BSN 340999), 2630, 2640, Utility: 820, 830, 2240	Wheel Hub, 6-Bolt	AMT25809	\$ 45.00	
(1020 HU, RU w/ Heavy Duty Models and/or Axles), (1120, 1130, 1630, 1830, 2020, 2030 BSN 187301, 2130 - w/ Heavy Duty Models and/or Axles), 1040, 1140, 1520, (1640, 1840, 2040, 2040S, 2120 BSN 429999), 2140 ASN 430000, 2150GP, 2255GP, 2350, 2355GP, 2510, 2520, 2550, 2555GP, (2650, 2850 - w/ Syncro-Range Transmission), 2750, 2755, 2840, 2940, 2950, 2955, 3010, 3020, 3030, 3040, 3120, 3130, 3140, 4000, 4010, 4020, (4030, 4040, 4230, 4320, 4430 - w/ Double Knuckle), 6110L, 6200L, 6210L, 6300, 6300L, 6310L, 6310S, 6400, 6400L, 6410L, 6410S, 6500, 6500L, 6510L, 6510S, Utility: 2155	Wheel Hub, 6-Bolt Use AMA1555R 3-Bolt Style Hub Cap	AMT21545	\$ 60.00	
	Wheel Hub Cap, 3-Bolt	AMA1555R	\$ 9.50	
1020, 1520, 2020, 2030	Wheel Hub, 6-Bolt	AMT21543	\$ 42.00	
1020* (Heavy Duty-HU, RU), 2030 HD ASN 187301, 2150GP, 2155, 2350*, 2355*, 2355N, 2440 BSN 340999, 2440 Orchard ASN 341000, 2510, 2550*, 2555*, 2630 (Heavy Duty), 2640 BSN 331509, 2640 Orchard ASN 341000, 2750*, 2855N, 2840*, (4000, 4020 Row Crop or Standard Axle ASN 263457), 4030, 4230, 4430 - w/ Adjustable Axle), 4040, 4240, 7405 *Replaces T21545 on these applications	Wheel Hub, 6-Bolt Uses Press-On Hub Cap R509922	AMR49839	\$ 55.00	
1520, 2510, 2520, 3010, 3020, 4000, 4010, 4020, (4030, 4040, 4230, 4320, 4430 - w/ Double Knuckle)	Wheel Hub, 6-Bolt Use AMA1555R 3-Bolt Style Hub Cap When replacing R26631 Hub, new Wheel Bolts are required	AMR48763	\$ 45.00	
	Wheel Hub Cap, 3 Bolt	AMA1555R	\$ 9.50	





John Deere®—Tractor

Application	Description	Part Number	Retail Price	Core
5103 BSN 001434, 5200, 5203 BSN 001135, 5220, 5300, 5303 BSN 001081, 5310, 5320, 5400, 5410, (5420 BSN 443960, 5520 BSN 453301 w/ SyncShuttle™ Transmission), 5500	Wheel Hub, 6-Bolt	AMR109453	\$ 167.97	
2355GP, 2555GP, 2750GP, 2755GP, 4520, 4555, 4560, 4620, 4630, 4640, 4650, 4755, 4760, 4840, 4850, 4955, 4960, 5020, 6030	Wheel Hub, 8-Bolt	AMR63556	\$ 100.00	
(2440, 2640 ASN 331510)	Wheel Hub, HD 6-Bolt	AMR62436	\$ 184.83	
2955, 3055, 4030, 4040, 4050, (4055, 4255 BSN 010000), (4230, 4430 - w/ Adjustable Axle), 4240, 4250, 4440, 4450, 4455 BSN 020000, 6110, 6110L, 6120, 6200, 6200L, 6210, 6210L, 6220, 6300, 6300L, 6310, 6310L, 6310S, 6320, 6400, 6400L, 6405, 6410, 6410L, 6410S, 6420, 6500, 6500L, 6510L, 6510S, 6603, 6605, 7405	Wheel Hub, 8-Bolt Use w/ R50992 Press-On Hub Cap	AMR49841	\$ 85.00	
(4055, 4255 ASN 010001), 4455 ASN 020001, 7200, 7210, 7400, 7410, 7510, 7600, 7610, 7700, 7710, 7800, 7810	Wheel Hub, 8-Bolt Use w/ R50992 Press-On Style Hub Cap	AMR112915	\$ 110.00	
4555, 4560, 4650, 4755, 4760, 4850, 4955, 4960, 6170R, 6190R, 7200R, 7630, 7720, 7730, 7820, 7830, 7930, 8100, 8110, 8120, 8200, 8210, 8220, 8300, 8400	Wheel Hub, 8-Bolt For Front Axle	AMR113716	\$ 328.07	
Cotton Strippers: 7440, 7445, 7460	Wheel Hub, 8-Bolt For Rear Axle	AMR113716	\$ 328.07	
1040, 1120, 1130, 1140, 1520, 1630, 1640, 1830, 1840, 2020, 2030, 2040, 2040S, 2120, 2130, 2140, 2150, 2155, 2250, 2350, 2355, 2440, 2450, 2510, 2520, 2550, 2555, 2630, 2640, 2650, 2750, 2755, 2840, 2850, 2855, 2940, 2950, 2955, 3010, 3020, 3030, 3040, 3055, 3130 ASN 186270, 3140, 3150, 3255, 3350, 4000, 4010, 4020, 4030, 4040, 4050, 4055, 4230, 4240, 4250, 4255, 4320, 4430, 4440, 4450, 4455, 4555, 4560, 5010, 6700, 7200, 7210, 7400, 7410, 7510, 7600, 7610, 7710, 7800, 7810	Wear Sleeve	AMR26632	\$ 4.00	
For John Deere® Hubs	Lug Bolt 9/16"-18 x 1 1/8"	AMJD16	\$ 1.44	

Wheel Bearing Kits

Application	Description	Part Number	Retail Price	Core
 Row Crops: 50, 60, 70, 520, 530, 620, 630, 720, 730, A, AO, AR, B, G, GH - w/ Factory Wide Fronts	Wheel Bearing Kit Sleeves are not included	WBK-JD-1	\$ 85.00	
	Components:			
	Inner Cone	1 3383	\$ 14.50	
	Inner Cup	1 AM3320	\$ 23.00	
	Outer Cone	1 2785	\$ 26.50	
	Outer Cup	1 2720	\$ 5.00	
	Seal	1 AP19670	\$ 4.00	

John Deere®—Tractor

Application	Description	Part Number	Retail Price	Core
 920, 930, 940, 1020, 1030, 1040, 1120, 1130, 1140, 1550, 1630, 1750, 1850, 2020, 2120, 2150, 2255, 2350, 2355, 2550, 2555, 2755, Utility: 820, 830, 2155	Wheel Bearing Kit Sleeves are not included	WBK-JD-2	\$ 30.00	
	Components:			
	Inner Cone	1 LM48548	\$ 6.00	
	Inner Cup	1 LM48510	\$ 4.00	
	Outer Cone	1 M12649	\$ 4.50	
	Outer Cup	1 M12610	\$ 2.00	
	Seal	1 AP19495	\$ 7.00	
 820, 830, 920, 1020, 1120, 1520, 1530, 2010 ASN 420001, 2020, 2030, 2040, 2120, 2440, 2630, 2640 BSN 340999 - w/ T25809 Hub	Wheel Bearing Kit Sleeves are not included	WBK-JD-3	\$ 31.00	
	Components:			
	Inner Cone	1 LM48548	\$ 6.00	
	Inner Cup	1 LM48510	\$ 4.00	
	Outer Cone	1 M12649	\$ 4.50	
	Outer Cup	1 M12610	\$ 2.00	
	Seal	1 AP19575	\$ 6.80	
 1020, 1520, 2030, 2440, 2510, 2520, 2630, 2640, 3010, 3020, 4000, 4010, 4020, 4030, 4040, 4320	Wheel Bearing Kit	WBK-JD-6	\$ 38.00	
	Components:			
	Inner Cone	1 25577	\$ 14.00	
	Inner Cup	1 25521	\$ 7.50	
	Outer Cone	1 M88048	\$ 11.00	
	Outer Cup	1 M88010	\$ 7.00	
	Seal	1 AP19495	\$ 7.00	
Sleeve	1 AP19700	\$ 3.00		
 2030, 2840, 4030, 4230, 4430 - w/ R49839 or R49841 Hub	Wheel Bearing Kit	WBK-JD-7	\$ 40.00	
	Components:			
	Inner Cone	1 25590	\$ 11.00	
	Inner Cup	1 25520	\$ 4.00	
	Outer Cone	1 M88048	\$ 11.00	
	Outer Cup	1 M88010	\$ 7.00	
	Seal	1 AP19495	\$ 7.00	
Sleeve	1 AP19700	\$ 3.00		
 2955, 3055, 3255, 4040, 4050, 4055, 4230, 4240, 4250, 4255, 4430, 4440, 4450, 4455	Wheel Bearing Kit	WBK-JD-8	\$ 35.00	
	Components:			
	Inner Cone	1 JLM104948	\$ 13.00	
	Inner Cup	1 LM104912	\$ 6.00	
	Outer Cone	1 M88048	\$ 11.00	
	Outer Cup	1 M88010	\$ 7.00	
	Seal	1 AP19495	\$ 7.00	
Sleeve	1 AP19700	\$ 3.00		

John Deere®—Tractor

Application	Description	Part Number	Retail Price	Core	
 4520, 4555, 4560, 4620, 4630, 4640, 4650, 4755, 4760, 4850, 4955, 4960, 5020, 6030 - w/ R63556 Hub	Wheel Bearing Kit Sleeves are not included	WBK-JD-10	\$ 76.00		
	Components:				
	Inner Cone	1 469		\$ 11.50	
	Inner Cup	1 453X		\$ 13.00	
	Outer Cone	1 2794		\$ 23.00	
	Outer Cup	1 2720		\$ 5.00	
	Seal	1 AP19480	\$ 11.50		

Steering Arms



Application	Description	Part Number	Retail Price	Core
520, 530, 620, 630, 720, 730	Steering Arm 6 Spline, 1.50" Diameter	Right Hand AMF3174R Left Hand AMF3175R	\$ 195.93 \$ 175.25	
(2040 BSN 350000, 2440* BSN 308804, 2630 - w/ Swept-Back Adjustable Axle), 1530 - w/ Straight or Swept-Back Adjustable Axle, (1020, 2020 - w/ 44"-66" or 48"-78" Swept-Back Adjustable Axle), 1520 - w/ 48"-78" Swept-Back Adjustable Axle, 2640* BSN 308804 - w/ 49"-79" Swept-Back Adjustable Axle, Utility: (820, 830, 2240 BSN 350000 - w/ Swept-Back Adjustable Axle)	Steering Arm Marked R70764	Center AMAR92944	\$ 367.21	
(920, 1530, 2030 BSN 187300 - w/ Swept-Back Adjustable Axle), (1020, 2020 - w/ 44"-66" or 48"-78" Swept-Back Adjustable Axle), (1520 w/ 48"-78" Swept-Back Adjustable Axle), (2440, 2640 - BSN 308804 w/ Swept-Back Adjustable Axle), (2630 w/ 49"-79" Swept-Back Adjustable Axle), Utility: (820 w/ Swept-Back Adjustable Axle for 16.10" Rear Tire), (830 w/ Swept-Back Adjustable Axle for 24" and 28" Rear Tires), (820, 2040, 2240 BSN 350000 - w/ Swept-Back Adjustable Axle)	Steering Arm Marked T21504	Center AMAT19794	\$ 406.52	
930, 1030, 2040, (2150, 2255 - w/ Swept-Back Axle), Utility: 830, 2155, 2240	Steering Arm Replaces AL31089	Center AMAL55150	\$ 194.04	
(1020, 1520, 2030 - w/ Fixed Tread Front Axle)	Steering Arm Replaces AT19797	Center AMAT52868	\$ 338.05	
(1020, 2020 - w/ 48"-80", 60"-88" or 58"-92.50" Heavy Duty Straight Adjustable Axle), (1120, 1530 - w/ Straight Adjustable Axle), (1520 w/ 48"-80" or 60"-88" Heavy Duty Straight Adjustable Axle), (2020, 2120 - w/ Straight Adjustable Axle), (2030 BSN 187301 w/ 49"-81", 60"-88" or 58"-92.50" Straight Adjustable Axle), 2240 BSN 350000, (2630 w/ 49"-81", 60"-88" or 53"-76" Straight Adjustable Axle), (2640 SN 308804 w/ 53"-76" or 60"-88" Straight Adjustable Axle), Utility: 2440 BSN 308804 w/ Straight Adjustable Axle	Steering Arm Marked T21502	Center AMAT19793	\$ 312.57	

John Deere®—Tractor

Application	Description	Part Number	Retail Price	Core
(1020, 2020 - w/ 48"-80", 60"-88" or 58"-98.50" Straight Adjustable Axle), (1520 w/ 48"-80" or 60"-88" Straight Adjustable Axle), (1530, 2240 BSN 350000 - w/ Extra Wide Adjustable Axle), (2440*, 2640* - BSN 308804 w/ 60"-88" Standard or 53"-76" Heavy Duty Straight Adjustable Axle), (2630 w/ 60"-80" Straight Adjustable Axle), Utility: (2240 ASN 349999 w/ 58"-76" or 60"-88" Straight Adjustable Axle) *Used w/ Replacement Axle	Steering Arm Marked R70764	Center AMAR92945	\$ 241.76	
(1640, 2040, 2140 ASN 430000), 2040S, (2350, 2355, 2550, 2555, 2755 - w/o Hydrostatic Steering)	Steering Arm	Center AMAL55149	\$ 189.82	
(1640, 2040, 2140, 3040, 3140 ASN 430000), 2350, 2355, 2550, 2750, 2755, 2940, 2950, 6110L, 6120L, 6200L, 6210L, 6220, 6220L, 6300, 6300L, 6310L, 6310S, 6320L, 6400, 6400L, 6410L, 6410S, 6420L, 6500, 6500L, 6510L, 6510S, 6520L	Steering Arm	Right Hand AML34366	\$ 189.38	
	4 Tooth Tapered Spline	Left Hand AML36442	\$ 186.20	
1640 Low Version ASN 430000, 2350 Low Version w/o Hydrostatic Steering, (2355, 2555, 2755 - Middle/High Version w/o Hydrostatic Steering)	Steering Arm	Center AMAL55151	\$ 158.61	
2150 Low Version, Utility: 2155	Steering Arm	Center AMAL55148	\$ 184.76	
2355N, 2855N - w/ Swept-Back Axle	Steering Arm	Center AMAL58215	\$ 151.72	
(2440, 2640 SN 308805-340999 w/ Straight Adjustable Axle)	Steering Arm Marked R71082 Replaces AR86116	Center AMAR93359	\$ 331.31	
(2440, 2640 SN 308805-340999 w/ 49"-79" Swept-Back Adjustable Axle)	Steering Arm	Center AMAR93358	\$ 298.04	
(2440, 2640 ASN 308805 w/ Swept-Back Adjustable Axle)	Steering Arm Marked R70230	Center AMAR91811	\$ 329.57	
2510, 2520, 3010, 3020, 4000, 4010, 4020, 4320	Steering Arm 6 Spline, 1.50" Diameter	Center AMR27808	\$ 100.00	
		Right Hand AMR47765	\$ 45.00	
		Left Hand AMR47766	\$ 45.00	
2640 ASN 340999 w/ Straight Non-Adjustable Axle	Steering Arm	Center AMAT52867	\$ 363.03	
2940	Steering Arm 4 Tooth Tapered Spline For Tractors w/ Single Steering Cylinder	Left Hand AML35960	\$ 157.89	
2955 BSN 765516, 3055, 6110, 6110L, 6120, 6120L, 6200, 6200L, 6210, 6210L, 6220, 6220L, 6300, 6300L, 6310, 6310L, 6310S, 6320, 6320L, 6400, 6400L, 6403 BSN 002144, 6405, 6410, 6410L, 6410S, 6420, 6420L, 6500, 6500L, 6510S, 6520L, 6603 BSN 001955, 6605, 7405	Steering Arm 6 Spline	Right Hand AML57016	\$ 202.81	
		Left Hand AML57015	\$ 209.67	
4030, 4040, 4230, Cotton Pickers: 9910, 9920	Steering Arm 6 Spline, 9.12" Long, 1.75" Diameter Replaces R49827	Right Hand AMR61156	\$ 111.22	
		Left Hand AMR61157	\$ 121.36	
4050, 4055, 4240, 4250, 4430, 4440, 4450, 4455	Steering Arm 6 Spline, 1.75" Diameter	Right Hand AMR61152	\$ 109.54	
		Left Hand AMR61153	\$ 119.53	

John Deere®—Tractor

Application	Description	Part Number	Retail Price	Core
4555, 4560, 4630, 4640, 4650, 4755, 4760	Steering Arm 6 Spline, 1.75" Diameter	Right Hand AMR49849	\$ 207.84	
	Steering Arm 6 Spline, 1.75" Diameter	Left Hand AMR49851	\$ 208.42	
(4555, 4560, 4755, 4760 - w/o MFWD), 4630, 4640, 4650, Cotton Pickers: 9940, 9950	Steering Arm 6 Spline	Center AMR51121	\$ 210.23	
4840, 4850, 4955, 4960	Steering Arm 6 Spline, 2" Diameter	Right Hand AMR66128	\$ 153.42	
		Left Hand AMR66129	\$ 125.60	
5020, 6030	Steering Arm 6 Spline, 2" Diameter Replaces R40203	Right Hand AMR52838	\$ 236.13	
	Steering Arm 6 Spline, 2" Diameter	Left Hand AMR52839	\$ 298.43	
7200, 7210, 7220, 7320, 7400, 7410, 7420, 7510	Steering Arm 6 Spline, Tapered	Right Hand AMR115658	\$ 222.59	
		Left Hand AMR115659	\$ 227.99	
(7200, 7210, 7400, 7410, 7510 - Hi-Crop), 7600, 7610, 7710, 7800, 7810	Steering Arm 6 Spline, Tapered	Right Hand AML75846	\$ 291.56	
		Left Hand AML75847	\$ 304.00	
8100, 8110, 8120, 8200, 8210, 8220, 8300, 8310, 8410	Steering Arm 6 Spline	Left Hand AMR125164	\$ 306.80	

Axle Center Tubes and Beams



Application	Description	Part Number	Retail Price	Core
2510, 2520, 3010, 3020, 4000, 4010, 4020, 4320	Center Tube	AMAR50865	\$ 1328.61	
	Center Tube Bolt	AMB2694R	\$ 25.03	

Axle Knee Extensions

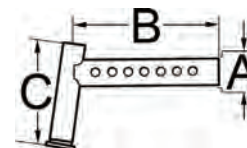

Application	Description	Part Number	Retail Price	Core
2510, 2520, 3010, 3020, 4000, 4010, 4020, 4320	Knee w/ Bushings Use w/ AMAR55180 Spindle A - 3.25", B - 18", C - 12.75"	AMAR50962	\$ 235.00	
	Knee w/ Bushings Long Knee for Extra Wide Rows Use w/ AMAR55180 Spindle A - 3.25", B - 24", C - 12.75"	AMAR50963	\$ 255.00	
5103, 5200, 5203, 5210, 5220, 5300, 5310, 5320, 5400, 5403, 5410, 5415 BSN 005672, 5420, 5500, 5510, 5520, 5615 BSN 004136, 5715 BSN 008654	Knee, Right Hand Replaces R109455	AMRE58492	\$ 1350.00	
2510, 2520, 3020, 4000, 4010, 4020	Hi-Crop Knee	AMAR27927	\$ 275.00	
(2355, 2555, 2750, 2755 - w/ Extra HD Fixed Axle), 4520, 4555, 4560, 4620, 4630, 4640, 4650, 4755, 4760, 4840, 4850, 4955, 4960, 5020, 6030, 7720, 7820, 7920, 8100, 8110, 8120, 8200, 8210, 8220, 8300, 8310, 8320, 8400, 8410, 8420, 8520, Cotton Pickers: 9935, 9940, 9950, 9960, 9965, 9970, 9976, 9986, Cotton Strippers: 7455, 7460, Forage Harvester: 7450	Knee Bushing	AMR52188	\$ 10.00	

John Deere®—Tractor

Application	Description	Part Number	Retail Price	Core
2510, 2520, 3010, 3020, 4000, 4010, 4020, 4320	Knee Bushing Replacement bushing for AMAR50962 and AMAR50963 Knee Extension (2) Required per Knee	AMA877R	\$ 9.50	
2955, 3055, 3255, 4030, 4040, 4050, 4055, 4230, 4240, 4250, 4255, 4430, 4440, 4450, 4455, 6110, 6110L, 6120, 6120L, 6200, 6200L, 6210, 6210L, 6215, 6220, 6220L, 6300, 6300L, 6310, 6310L, 6310S, 6320, 6320L, 6400, 6400L, 6405, 6410, 6410L, 6410S, 6415, 6420, 6420L, 6500, 6500L, 6510L, 6510S, 6520L, 6605, 6615, 6715, 7200, 7210, 7400, 7410, 7510, 7600, 7610, 7700, 7710, 7800, 7810	Knee Bushing	AMR49835	\$ 7.00	
4050, 4230, 4250, 4430, 4440, 4450	Knee, Right Hand Marked R49607, R53221 or R64387 Replaces AR59194	AMAR80192	\$ 701.93	
	Knee, Left Hand Marked R49608 or R64388 Replaces AR59195	AMAR80193	\$ 660.01	
5103 BSN 001433, 5105, 5200, 5203 BSN 001134, 5205, 5210, 5220, 5300, 5303 BSN 001080, 5310, 5310N, 5320, 5320N, 5325N, 5400, 5400N, 5410, 5415 BSN 005672, 5420 BSN 443959, 5420N, 5425N, 5500, 5500N, 5510, 5510N, 5520 BSN 453300, 5520N, 5525N, 5615 BSN 004136, 5715 BSN 008654	Knee Bushing 1.38" ID, 1.541" OD	AMR109452	\$ 17.89	



Axle Pivot Assembly and Pins

Application	Description	Part Number	Retail Price	Core
50, 60, 70, 520, 530, 620, 630, 720, 730, A, B	Pivot Bolster	AMAA5765R	\$ 553.68	
2510, 2520, 3010, 3020, 4000, 4010, 4020, 4320, Cotton Pickers: 9900	Pivot Bolster	AMAR69836	\$ 490.00	
2510, 2520, 3010, 3020, 4010, 4020, 4320	Pivot Bolster w/ Arm To install 4430 Axle on 4020	AMX41117	\$ 750.00	
	Pivot Bolster w/ Arm To install 4630 Axle on 4020	AMX41118	\$ 685.00	
2510, 2520, 3010, 3020, 4000, 4010, 4020, 4320, Cotton Picker: 9900	Pivot Pin Front and Rear 4.375" Long, 1.50" Diameter	AMR27817	\$ 39.00	
840, 920, 930, 940, 1020, 1030, 1040, 1120, 1130, 1520, 1530, 1630, 1640, 1830, 1840, 1850, 2020, 2030, 2040, 2150, 2255, 2350, 2355, 2440, 2550, 2555, 2630, 2640, 2650, 2750, 2755, 2850, 2855, Ind: 300, 300B, 301, 301A, 302, 302A, 400, 401, 401B, 401C, 401D, Utility: 820, 830, 2155, 2240	Pivot Pin, Front 3.521" Long, 1.25" Diameter	AMT21669	\$ 12.00	
(2840, 2940, 2590, 2955, 4030, 4040, 4050, 4055, 4230, 4240, 4430, 4440 - 2WD), Cotton Pickers: 9910, 9920, 9930, Cotton Strippers: 7445	Pivot Pin, Front 4.25" Long, 1.50" Diameter	AMT29205	\$ 21.00	
(4050, 4055, 4250, 4255, 4450, 4455, 4555, 4560, 4630, 4640, 4650, 4755, 4760, 4840, 4850, 4955, 4960 - w/ MFWD), Cotton Pickers: 9960, 9965, 9970	Pivot Pin, Front 4.29" Long, 2" Diameter	AMR79996	\$ 55.77	
1020, 1520, 1530, 2020, 2030, 2440, 2630, 2640, Ind: 300, 300B, 301, 301A, 302, 302A, 400, 401, 401B, 401C, 401D, Utility: (820, 830 - w/ 3 Cylinder Engine), 2240	Pivot Pin, Rear 4.10" Long, 1.5727" OD	AMR54195	\$ 47.88	
4030, 4040, 4050, 4055, 4230, 4240, 4250, 4430, 4440, 4450, 4455 - w/ MFWD	Pivot Pin, Rear 4.843" Long, 1.495" Diameter	AMR51798	\$ 27.62	

John Deere®—Tractor

Application	Description	Part Number	Retail Price	Core
4050, 4055, 4250, 4255, 4450, 4455, 4555, 4560, 4630, 4640, 4650, 4755, 4760, 4840, 4850, 8100, 8110, 8120, 8200, 8210, 8220, 8300, 8310, 8410 - w/ MFWD), Cotton Pickers: 9935, 9960, 9965, 9970, 9976, 9986 Cotton Strippers: 7455, 7460	Pivot Pin, Rear 4.847" Long, 2" Diameter	AMR73635	\$ 33.50	
1020, 1120, 1520, 1530, 2020, 2030, 2040, 2120, 2440, 2630, 2640, Utility: 2155, 2240	Pivot Pin Bushing, Front	AMT23118	\$ 10.00	
4050, 4055, 4250, 4255, 4450, 4455, 4555, 4560, 4630, 4640, 4650, 4755, 4760, 4840, 4850, 4955, 4960	Pivot Pin Bushing, Front	AMR109808	\$ 7.50	
2955, 3055, 3140, 3150, 3155, 3255	Pivot Pin Bushing, Rear 1.97" Long, 2" OD Replaces, L58229, L62838	AML63510	\$ 20.32	
4040, 4050, 4055, 4230, 4240, 4250, 4255, 4430, 4440, 4450, 4455	Pivot Pin Bushing, Rear	AMR65827	\$ 11.00	
6140M, 6140R, 6145M, 6145R, 6150M, 6150R, 6150RH, 6155M, 6155R, 6155RH, 6170M, 7200, 7210, 7220, 7320, 7330, 7400, Premium Models: 7130, 7330, 7230	Front Axle Pivot Bushing Front and Rear 2.029" ID, 2.225" OD, 2" Long	AMR117258	\$ 16.69	
7200, 7210, 7400, 7410, 7510, 7600, 7610, 7700, 7710, 7800, 7810, 8110, 8120, 8130, 8210, 8220, 8225R, 8230, 8235R, 8245R, 8260R, 8270R, 8285R, 8295R, 8310, 8310R, 8320, 8320R, 8330, 8335R, 8345R, 8360R, 8370R, 8400R, 8410, 8420, 8430, 8530, Cotton Picker: 9986, Cotton Stripper: 7460	Pivot Bushing 2" Long, 3.005" ID, 3.188" OD	AMR125974	\$ 23.91	
2510, 2520, 3010, 3020, 4000, 4010, 4020	Mounting Plate Wedge For Front Axle	AMR49098	\$ 36.88	



Hydraulic Oil Coolers

Application	Description	Part Number	Retail Price	Core
3010, 3020, 4010, 4020 - w/ Syncro-Range Transmission	Hydraulic Oil Cooler Conversion Kit Replaces 1 pc Reservoir/Cooler Assembly used on early model tractors Includes AMAR44283 Oil Cooler, AMAR50592 Oil Reservoir and AMAR53119 Hose Kit	AMX47108	\$ 775.00	
3020, 4020 - w/ Powershift Transmission	Hydraulic Oil Cooler Kit This kit has no reservoir and is primarily for powershift tractors Includes AMAR44283 Oil Cooler and AMR41731 Bracket	AMX47110	\$ 650.00	
930, 940, 1020, 1030, 1040, 1120, 1130, 1140, 1520, 1530, 1550, 1630, 1750, 1830, 1850, 2020, 2030, 2120, 2150, 2255, 2355N, 2440, 2630, 2640, Ind: 300, 301, 301A, 302, 302A, 400, 401, 401B, 401C, 401D, Utility: 830, 2155, 2240	Hydraulic Oil Cooler Replaces AR69398, AT77459, AT169229	AMAT165535	\$ 355.00	
3010, 3020, 4000, 4020	Hydraulic Oil Cooler Replacement for units w/ separate oil coolers	AMAR44283	\$ 495.00	
4040, 4040S - w/o A/C	Hydraulic Oil Cooler	AMAR86211	\$ 1442.00	
4050 ASN 005511, 4055, (4250, 4450 ASN 001000), 4255, 4455, 4555, 4560, 4755, 4760, 4850, 4955, 4960 - w/o A/C	Hydraulic Oil Cooler	AMAR96902	\$ 445.00	
4120, 4320, 4520, 4720 - Utility	Hydraulic Oil Cooler	AMLVA15102	\$ 335.00	
4240, 4440, 4640 - w/o A/C	Hydraulic Oil Cooler	AMAR80128	\$ 1175.00	
5076EN, (5083EN, 5093EN, 5101EN BSN 360000), 5090EN, 5225, 5325, 5325N, 5425, 5425N, 5525, 5525N, 5625	Hydraulic Oil Cooler	AMRE212290	\$ 345.00	
5085E, 5085M, 5100E, 5100M, 5100MH, 5100ML, 5115M, 5115ML, 6100D, 6110D, 6115D, 6125D, 6130E, 6140D	Hydraulic Oil Cooler Replaces SJ11173	AMSJ26167	\$ 360.00	

Prices Subject to Change without Prior Notice. The use of original equipment manufacturer (OEM) part numbers or trademarks, e.g. Case® and John Deere®, are for reference purposes only and for indicating product use and compatibility. Our company and the listed replacement parts contained herein are not sponsored, approved or manufactured by the OEM. All parts are New unless designated Reman in the description.

John Deere®—Tractor

Application	Description	Part Number	Retail Price	Core
7200, 7210, 7400, 7410, 7510 - w/o A/C	Hydraulic Oil Cooler w/ Fuel Cooler	AMRE50295	\$ 1085.00	
(7200R, 7215R, 7230R, 7260R, 7280R BSN 080000)	Hydraulic Oil Cooler 19 Rows Replaces RE566094	AMRE332816	\$ 790.00	
	Hydraulic Oil Cooler 24 Rows	AMRE566107	\$ 930.00	
(7210R, 7230R ASN 080000, 7250R, 7270R, 7290R, 7310R - w/o Baffle), (7230R, 7250R ASN 094099 w/ FT4 Engine w/ Baffle)	Hydraulic Oil Cooler	AMRE560274	\$ 1325.00	
7600, (7610, 7710, 7810 BSN 089999), 7700, 7800 - w/o A/C	Hydraulic Oil Cooler	AMRE34853	\$ 1077.00	
7710, 7810	Hydraulic Oil Cooler	AMRE201108	\$ 314.00	
7720, 7820, 7920	Hydraulic Oil Cooler Core: 12.75" x 21.50" x 3"	AMRE566108	\$ 1510.00	
(8120, 8220, 8320, 8420, 8520 BSN 014425), (8120T, 8220T, 8320T, 8420T, 8520T BSN 902343)	Hydraulic Oil Cooler Replaces RE183330	AMRE221652	\$ 1250.00	
8560, 8570, 8760, 8770, 8870	Hydraulic Oil Cooler	AMRE53816	\$ 2297.00	
8560, 8760	Hydraulic Oil Cooler	AMRE28762	\$ 1893.00	
8560, 8760, 8960	Hydraulic Oil Cooler w/ Fuel Cooler	AMRE41760	\$ 975.00	
8960 ASN 004101, 8970	Hydraulic Oil Cooler w/ Transmission Cooler	AMRE47767	\$ 1998.00	
8960	Hydraulic Oil Cooler Core: 38" x 24" x 3" Replaces RE502191	AMRE41761	\$ 2466.00	
9230, 9330, 9430, 9430T, 9530, 9530T, 9630, 9630T	Hydraulic Oil Cooler Replaces RE231516	AMRE566106	\$ 1519.00	
9300, 9400 - w/ Powershift Transmission	Hydraulic Oil Cooler	AMRE70870	\$ 2549.00	
9300, 9400	Hydraulic Oil Cooler	AMRE61923	\$ 2225.00	
9300T, 9400T	Hydraulic Oil Cooler	AMRE162977	\$ 1225.00	
(9300T, 9400T BSN 902087)	Hydraulic Oil Cooler	AMRE162979	\$ 2595.00	
(9300T, 9400T ASN 902088)	Hydraulic Oil Cooler	AMRE167950	\$ 3469.00	
9320, (9320T, 9420T BSN 009999), 9420	Hydraulic Oil Cooler	AMRE172500	\$ 3244.00	
9320, 9320T, 9420, 9420T, 9520, 9520T, 9620, 9620T - w/ Powershift Transmission	Hydraulic Oil Cooler	AMRE172499	\$ 2800.00	
(9360R, 9410R, 9460R, 9510R, 9560R SN 000101-014999), (9370R, 9420R, 9470R, 9520R, 9570R ASN 015000), 9420RX, (9460RT, 9510RT, 9560RT SN 900101-905999), (9470RT, 9520RT, 9570RT ASN 906000), 9470RX, 9520RX, 9570RX	Hydraulic Oil Cooler w/ Fuel Cooler	AMRE566087	\$ 1421.00	
9200, 9300, 9400	Axle Oil Cooler	AMRE68972	\$ 795.00	
4050, 4055, 4250, 4255, 4450, 4455, 4555, 4560, 4650, 4755, 4760	Condenser w/ Oil Cooler	AMAR112965	\$ 455.00	
4230, 4430, 4630, 4040	Condenser w/ Oil Cooler	AMAR61885	\$ 222.95	
4240, 4440, 4640	Condenser w/ Oil Cooler	AMAR96767	\$ 365.00	
4850, 4955, 4960	Condenser w/ Oil Cooler	AMAR112966	\$ 550.00	
5076E, 5076EN, 5082E, (5083E, 5093E, 5101E BSN 340000), (5083EN, 5093EN, 5101EN BSN 370000), 5090E, 5090EH, 5090EN, 5225, 5325, 5325N, 5425, 5425N, 5525, 5525N, 5603, 5625	Condenser w/ Oil Cooler	AMRE229585	\$ 436.00	
7200, 7210, 7400, 7410, 7510	Condenser w/ Oil Cooler	AMRE55139	\$ 615.00	
(8100, 8200, 8300, 8400 ASN 010000), 8100T, 8110, 8110T, 8200T, 8210, 8210T, 8300T, 8310, 8310T, 8400T, 8410, 8410T	Condenser w/ Fuel and Oil Cooler	AMRE66573	\$ 575.00	
8440	Condenser w/ Oil Cooler Replaces AR75968	AMAR78958	\$ 1642.00	

John Deere®—Tractor

Application	Description	Part Number	Retail Price	Core
9100, 9200	Condenser w/ Oil Cooler	AMRE63881	\$ 2900.00	
9120, 9220 - w/ Powershift Transmission	Condenser w/ Oil Cooler	AMRE172495	\$ 3425.00	
9200	Condenser w/ Oil Cooler Core: 28" x 36" x 3.80"	AMRE70871	\$ 3300.00	
3020, 4000, 4020 - w/ Syncro-Range Transmission	Hydraulic Oil Cooler Reservoir Kit This reservoir is a later replacement and requires this hose kit to convert to the latest relief valve, Oil Cooler Not Included Includes AMAR50592 Oil Cooler Reservoir and AMAR53119 Hose Kit	AMX47111	\$ 625.00	
3010, 3020, 4000, 4020, 5010	Hydraulic Oil Cooler Reservoir Replacement for units w/ separate oil coolers	AMAR50592	\$ 400.00	

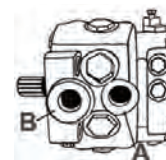

Hydraulic Pumps

All pumps are assembled in our climate-controlled rebuild facility. Pumps are test ran and flow checked on the pump stand, where pressures are set using OEM specifications.

Application	Description	Part Number	Retail Price	Core
7630, 7720, 7730, 7820, 7830, 7920, 7930	Hydraulic Axial Piston Pump 45 cc Replaces PG200868	AMRE198342	\$ 2190.21	
(8120, 8220, 8320, 8420, 8520 ASN 016169)	Hydraulic Axial Piston Pump	AMRE214405	\$ 2852.85	
(3020, 4000, 4020, 4030, 4040, 4230, 4240, 4320, 4430, 4440, 4520, 4620, 4630, 4640, 4840 - w/ MFWD), 4000, 4555, 4650, 4755, 4850, 4955, 8430, 8440, 8450, 8630, 8640, 8650	Hydraulic Pump Reman Hydraulic Pump, Serialized A: 1.0625", B: 1.0625"	4 cu. in. AMX4861 AMX4861-R	\$ 1025.00 \$ 925.00	\$ 200.00 \$ 200.00
(3020, 4000, 4020, 4030, 4040, 4230, 4240, 4320, 4430, 4440, 4520, 4620, 4630, 4640, 4840 - w/ MFWD), 8430, 8440, 8630, 8640	Hydraulic Pump Reman Hydraulic Pump, Non-Serialized A: 0.875", B: 1.0625"	4 cu. in. AMRE11213 AMX4860-R	\$ 1142.00 \$ 925.00	\$ 200.00 \$ 200.00
870, 970, Utility: 770, 790, 990, 1070, 3005, 4005	Hydraulic Pump 12 Spline	AMAM876753	\$ 382.50	
920, 930 BSN 258365, 2040 BSN 349999, Utility: 820, 830 BSN 258365 - All w/ Power Steering	Hydraulic Pump, Dual 3.93" Port Spacing	AMAR55346	\$ 300.00	
1020, 1520, 1530, 2020, 2030, 2040, 2150, 2255, 2350, 2355N, 2440, 2550, 2555, 2630, 2640, 2750, 2755, 3030, 3130, Utility: 2155, 2240	Hydraulic Pump Keyed Input Shaft - 8 Pistons	AMAR103033	\$ 475.00	
2030, 2510, 2520, 3020, 4000, 4020, 4040, 4230, 4240, 4320, 4430, 4440, 4520, 4620, 4630, 4640, 5020, 6030, 7020, 7520	Hydraulic Pump Reman Hydraulic Pump A: 0.875"	3 cu. in. AMX4830 AMX4820-R	\$ 1025.00 \$ 825.00	\$ 200.00 \$ 200.00
2030, 2440, 2630, 2640, 2840, 2940, 3020, 4020, 4030, 4040, 4230, 4240, 4430, 4440, 4520, 4620, 4630, 4640, 4840	Reman Hydraulic Pump A: 0.875", B: 1.0625"	3 cu. in. AMX4840-R	\$ 825.00	\$ 200.00
2350, 2355N, 2550, 2555, 2750, 2755, 2855N, 2950, 2955, 3150, 3155, 4050, 4055, 4250, 4255, 4455, 4450	Reman Hydraulic Pump, Serialized A: 1.0625", B: 1.0625"	3 cu. in. AMX4850-R	\$ 825.00	\$ 200.00
2350, 2550, 2750, 2950, 2355N, 2555, 2755, 2855N, 2955, 3150, 3155, 4050, 4250, 4450, 4055, 4255, 4455	Hydraulic Pump Reman Hydraulic Pump, Serialized A: 1.0625", B: 1.625"	3 cu. in. AMX4855 AMX4855-R	\$ 1025.00 \$ 825.00	\$ 200.00 \$ 200.00
2510, 2520, 2030, 2630, 2440, 2640, 2840, 2940, 3020, 4000, 4020, 4030, 4230, 4430, 4630, 4040, 4240, 4640, 4840, 4520, 4620	Hydraulic Pump Reman Hydraulic Pump A: 0.875", B: 1.625"	3 cu. in. AMX4830 AMX4830-R	\$ 1025.00 \$ 825.00	\$ 200.00 \$ 200.00

John Deere®—Tractor

Application	Description	Part Number	Retail Price	Core
3010, 4010, 5010	Reman Hydraulic Pump, Non-Relief A: 0.875"	2.4 cu. in. AMX4810-R	\$ 825.00	\$ 200.00
	Reman Hydraulic Pump, Relief A: 0.875"	2.4 cu. in. AMX4811-R	\$ 825.00	\$ 200.00
5039D, 5045D, 5045E, 5055D, 5055E, 5065E, 5103, 5203, 5303, 5403, 6075E	Hydraulic Pump	AMRE223233	\$ 825.00	
5075M, 5085M, 5090M, 5095M ASN 170168, 5095MH, 5100M, 5100MH, 5100ML, 5105M, 5105ML, 5115M, 5115ML	Hydraulic Pump 28 cc Replaces SJ13339	AMSJ22726	\$ 875.00	
5076E, 5082E, 5090E, (5410, 5510 ASN 243687), 5415, 5510N ASN 357006, 5603, 5605, 5615, 5705, 5715	Hydraulic Pump Replaces RE72058	AMRE73947	\$ 825.00	
5103 BSN 0101072, 5105, 5200 ASN 111724, 5203 BSN 000882, 5205, 5210, 5220, 5300 ASN 121907, 5310, 5310N, 5320, 5320N, 5400 ASN 131838, 5400N, 5500N	Hydraulic Pump, Tandem Replaces RE57445, RE68886	AMRE197623	\$ 400.00	
5225, 5325, 5325N	Hydraulic Pump	AMRE197207	\$ 820.00	
6105M, 6105R, 6110M, 6110R, 6115M, 6115R, 6120M, 6120R, 6125M, 6125R, 6130M, 6130R, 6140J, 6140M, 6140R, 6145M, 6145R, 6150M, 6150R, 6155J, 6155M, 6155R, 6155RH, 6170M, 6170R, 6175M, 6175R, 6190R, 6195M, 6195R, 6210R, 6215R, 6230, 6330, 6430, 7130, 7230, 7330, Premium Models: 6230, 6330, 6430, 7230, 7330, 7430, 7530	Hydraulic Pump 45 cc	AMAL166639	\$ 1774.60	
6105M, 6115M, 6125M, 6140M, 6215, 6230, 6330, 6405, 6415, 6430, 6605, 6615, 6715, 7130, 7230, 7330	Hydraulic Pump 28 cm3 Replaces AL156335	AMAL200830	\$ 385.00	
6105R, 6115R, 6125R, 6140R, 6150R, 6150RH	Hydraulic Pump 35 cc	AMAL200635	\$ 1774.60	
6110, 6110L, 6120, 6120L, 6200, 6200L, 6210, 6210L, 6220, 6220L, 6300, 6310, 6310L, 6310S, 6320, 6320L, 6400, 6400L, 6410, 6410L, 6410S, 6420, 6420L, 6500, 6500L, 6510L, 6510S, 6520L, 7200, 7210, 7400, 7410, 7510	Hydraulic Pump 25 cc Replaces AL151514, AL157201	AMAL161041	\$ 856.00	
6110, 6110L, 6120, 6120L, 6200, 6200L, 6210, 6210L, 6220, 6220L, 6300, 6310, 6310L, 6310S, 6320, 6320L, 6400, 6400L, 6410, 6410L, 6410S, 6420, 6420L, 6500L, 6510L, 6510S, 6520L, 7200, 7210, 7400, 7410, 7420, 7510, 7520, 7600, 7610, 7700, 7710, 7800, 7810	Hydraulic Pump 41 cc Replaces AL151513, AL157203, AL213995	AMAL161043	\$ 1817.35	
(6145R, 6155R, 6155RH - FT4 MY18), 6170R, 6175R, 6190R, 6195R, 6210R, 6215R	Hydraulic Pump 60 cc	AMAL209259	\$ 2475.70	
7200, 7210, 7400, 7410, 7505, 7510, 7600, 7610	Reman Hydraulic Pump 40 cm3 A: M33x2.00" Metric Threads B: M42x2.00" Metric Threads	2.4 cu. in. AMAL75305-R	\$ 1781.92	\$ 363.00
7200R, 7210R, 7215R, 7230R, 7250R, 7260R, 7270R, 7280R, 7290R, 7310R	Hydraulic Pump 63 cc Replaces RE322340, RE563593	AMRE587657	\$ 2975.00	
7200R, 7210R, 7215R, 7230R, 7250R, 7260R, 7270R, 7290R, 7310R	Hydraulic Pump 45 cc Replaces RE322339, RE563592	AMRE587725	\$ 2728.40	
7200R, 7210R, 7215R, 7230R, 7250R, 7260R, 7270R, 7280R, 7290R, 7310R, 8225R ASN 119999, 8245R, (8270R, 8295R, 8320R, 8335R, 8345R ASN 090000), 8370R, 8400R	Hydraulic Pump 85 cc Replaces RE322341, RE556815, RE563594	AMRE587646	\$ 3957.70	
7220, 7320, 7420, 7520	Hydraulic Pump 45 cc Replaces AL157204	AMAL161044	\$ 2053.90	

John Deere®—Tractor

Application	Description	Part Number	Retail Price	Core
7630, 7730, 7830, 7930	Hydraulic Pump 63 cc Replaces PG200869	AMRE240475	\$ 3371.55	
8130, (8225R, 8235R, 8245R, 8295R BSN 054000), 8230, 8260R, 8270R, 8285R, 8295RT, 8310R, 8310RT, 8320R, (8320RT, 8345RT BSN 907101), 8330, 8335R BSN 090001, 8335RT, 8360R, 8360RT, 8430, 8530	Hydraulic Pump 63 cc Replaces PG204250, RE210847, RE258467, RE275747	AMRE565038	\$ 3371.55	
8130, (8225R, 8245R, 8270R, 8295R, 8320R, 8345R BSN 054000), 8230, 8235R, 8260R, 8285R, 8295RT, 8310R, 8310RT, 8320RT, 8330, 8335R BSN 900001, 8335RT, 8345RT, 8360R, 8360RT, 8370RT, 8430, 8530, 8RT 310, 8RT 340, 8RT 370, 8RT 410	Hydraulic Pump 85 cc Replaces PG204251, RE250831, RE258468, RE289097	AMRE563717	\$ 4575.00	
8560, 8570, 8670, 8770, 8870, 8960, 8970	Reman Hydraulic Pump	AMRE33467R	\$ 2250.00	\$ 650.00
8560 BSN 003100, 8760 BSN 005100, 8960 BSN 004100	Hydraulic Pump, Tandem	AMRE37755	\$ 697.00	
Utility: (1023E, 1026R (ASN 310000), 1025R ASN 110000	Hydraulic Pump	AMLVA19035	\$ 245.00	
Utility: 2032R, 2038R, 3025E, 3032E, 3036E, 3038E	Hydraulic Pump 8 cc x 6 cc Tandem Pump	AMLVA15511	\$ 550.00	
Utility: 3033R, 3039R, 3046R, 4044M, 4044R, 4049M, 4049R, 4052M, 4052R, 4066M, 4066R	Hydraulic Pump 10 cc	AMLVA19072	\$ 245.00	
Utility: 3203, 4200, 4210	Hydraulic Pump 11.90 cc	AMLVA10328	\$ 280.00	
Utility: 3120, 3320, 3520, 3720, 4105, 4310, 4410	Hydraulic Pump 14.60 cc	AMLVA11453	\$ 525.00	
Utility: 4120, 4320, 4520, 4720	Hydraulic Pump	AMLVA12934	\$ 675.00	
3010, 4010, 5010	Line Kit Note: Required when replacing a Non-Relief Style Pump w/ a Relief Style Pump	AMAR39810	\$ 100.00	
840, 940, 1040, 1140, 1840, 2040 ASN 350000, 2140, 2150, 2255, 2350, 2355, 2355N, 2550, 2555, 2750, 2755, 2840 ASN 311079, 2855N, 2940, 2950, 3030, 3040, 3055, 3130, 3140, 3150, 3155, 3255, 4040, 4055, 4250, 4255, 4450, 4455, 4555, 4560, 4650, 4755, 4760, 4850, 4955, 4960, 8450, Ind: 300B SN 267583-268350 & ASN 270055, 301A ASN 700420, 302A SN 267583-268350 & ASN 269525, 401B ASN 700324), 401C SN 267583-268531 & ASN 269525, 401D, 510 ASN 283547, Utility: 2155, 2240 ASN 350000	Hydraulic Pump Drive Coupler Replaces T58195	AML34569	\$ 14.50	
1020, 1030, 1120, 1130, 1520, 1530, 1630, 1830, 2020, 2030, 2040 BSN 349999, 2130, (2440, 2640 BSN 340999) 2510, 2520, 2630, 3030, 3120, 3130, Utility: 2240 BSN 349999	Hydraulic Pump Drive Coupler	AMR38348	\$ 14.75	
2030, (2440, 2640 BSN 340999), 2630, Ind: 300B BSN 197259, 302A, 401	Hydraulic Pump Drive Coupler 14 Spline, 4.37" Long	AMT22915	\$ 132.00	
2840, 3020, 3030, 4000, 4040, 4430, 4440, 4455, 4620, 4630, 4840, 5010, 5020, 6030, 7020, 7520, 8430	Hydraulic Pump Drive Coupler Half, External	AMR34362	\$ 16.00	
2840 BSN 311078, 3030, 3130, 4040, 4230	Hydraulic Pump Drive Coupler	AMT31093	\$ 147.62	
3020, 4000, 4020, 5010, 5020, Ind: 500, 600	Hydraulic Pump Drive Coupler 14 Spline, 4.37" Long	AMR34359	\$ 55.49	
4040, 4230, 4320, 4520, 4620, 7020	Hydraulic Pump Drive Coupler 14 Spline, 5.50" Long	AMR43075	\$ 140.95	
4240, 4430, 4440, 4630	Hydraulic Pump Drive Coupler 14 Spline, 8.25" Long	AMR50215	\$ 103.00	

Prices Subject to Change without Prior Notice. The use of original equipment manufacturer (OEM) part numbers or trademarks, e.g. Case® and John Deere®, are for reference purposes only and for indicating product use and compatibility. Our company and the listed replacement parts contained herein are not sponsored, approved or manufactured by the OEM. All parts are New unless designated Reman in the description.

John Deere®—Tractor

Application	Description	Part Number	Retail Price	Core
2955, 3055, 3155, 3255	Hydraulic Pump Drive Shaft	AML42188	\$ 225.00	
4555, 4560, 4650, 4755, 4760, 4850, 4955, 4960	Hydraulic Pump Drive Shaft	AMR71612	\$ 225.00	
4050, 4055, 4250, 4255, 4450, 4455, 4555, 4560, 4755, 4760, 4955, 4960, 8450, 8650, 8850, Cotton Pickers: 9950, 9960, 9965, 9970 BSN 016001	Hydraulic Pump Drive Shaft Coupling	AMR72739	\$ 22.49	
1020, 1116, 1520, 1830, 2030, 2130, 2440, 2510, 2520, 3030, 3130, 4000, 4020, 4030, 4040, 4240, 4320, 4430, 4440, 4620, 4630, 4640, 4840, 5010, 5020, 7020, 7520, 8440, 8630, 8640, 9940, Utility: 2240	Hydraulic Pump Drive Bushing	AMR45822	\$ 1.50	
2020, 2840, 3020, 3030, 3130, 4000, 4020, 4030, 4040, 4230, 4240, 4320, 4430, 4440, 4520, 4620, 4630, 6030, 7020	Drive Pin For Hydraulic Pump Drive	AMR46345	\$ 6.80	
1020, 1030, 1120, 1130, 1520, 1530, 1630, 1830, 2020, 2030, 2040 BSN 349999, 2130, (2440, 2640 BSN 340999), 2510, 2520, 2630, 2840 BSN 311078, 3020, 3030, 3120, 3130, 4000 ASN 250001, 4020, 4030, 4040, 4230, 4240, 4320, 4430, 4440, 4520, 4620, 4630, 4640, 4840, 5010, 5020, 6030, 7020, 7520, 8430, 8440, 8630, 8640, Utility: 2240 BSN 349999	Drive Pin Screw For Hydraulic Pump Support	AMR34360	\$ 1.79	
(1640, 2040, 2040S, 2140, 3040, 3140 ASN 430000), 2150, 2155, 2255, 2350, 2355, 2355N, 2550, 2555, 2750, 2855N, 2940, 2950, 2955 BSN 767516, 3055, 3150, 3155, 3255, 4040, 4040S, 4050 BSN 002366, 4055, 4240, 4240S, 4250 BSN 002798, 4255, 4350, 4440, 4450 BSN 005958, 4455, 4555, 4560, 4640, 4755, 4760, 4850 ASN 003116, 4955, 4960, 8450 ASN 002522, 8850 ASN 004184, Utility: 2155	Hydraulic Pump Drive Cushion	AMR78202	\$ 7.50	

Hydraulic Pump Components

Application	Description	Part Number	Retail Price	Core
2350, 2355, 2440, 2550, 2555, Utility: 2155	Housing, Stroke Control Valve Marked R77714	AMRE12470	\$ 450.00	
2.4 cu. in. Non-Serialized	Hydraulic Pump Shaft Used in 39 cc pumps, 4-6 cylinder engines	AMR39843	\$ 70.00	
3.3 cu. in. Main Hydraulic Pumps, Non-Serialized	Hydraulic Pump Shaft Used in 49 cc pumps, 6 cylinder engines	AMR34348	\$ 70.00	
3.3 cu. in. Serialized	Hydraulic Pump Shaft Used in 50 cc pumps, 6 cylinder engines	AMR79152	\$ 75.00	
4.3 cu. in. Serialized	Hydraulic Pump Shaft Used in 65 cc pumps, 6 cylinder engines	AMR79154	\$ 75.00	
840, 940, 1020, 1030, 1040, 1120, 1130, 1140, 1350, 1520, 1530, 1550, 1630, 1640, 1750, 1830, 1850, 1950, 1950N, 2020, 2030, 2040, 2040S, 2120 ASN 023000, 2130, 2140, 2150, 2250, 2255, 2350, 2355, 2355N, 2440, 2450, 2550, 2555, 2630, 2640, 2650, 2650N, 2750, 2755, 2850, 2855, 2855N, 3030, 3130, Ind: 300, 301, 302, 400, 401, 401B, 401D, Utility: 830 w/ 3 Cylinder Engine, 2155, 2240, Cotton Pickers: 9920, 9930, 9940, 9950, Cotton Strippers: 7440, 7445	Hydraulic Pump Shaft Used in 23 cc (1.38 cu. in.) pumps	AMR39319	\$ 72.50	
1020, (1120, 2120 BSN 22999), 1520, 2020, Ind: 300 BSN 077953, 400	Hydraulic Pump Shaft Used in 23 cc (1.38 cu. in.) pumps	AMR39177	\$ 235.37	

John Deere®—Tractor

Application	Description	Part Number	Retail Price	Core
1550, (1640, 2040, 2040S, 2140 ASN 430000), 1750, 1840, 1850, 1950, 2250, 2350, 2355, 2450, 2550, 2555, 2650, 2650N, 2750, 2755, 2850, 2855N, Utility: 2155	Hydraulic Pump Shaft 14 Spline, 7.37" Long	AML34573	\$ 110.00	
(2030, 2350, 2510, 2520, 2550, 2630, 2840, 2940, 2950, 3020, 3040, 3140, 4010, 4030, 5010 - w/ Hydraulic Pump ASN 014818), 2355, 2440, 2555, 2640, 2750, 2755, 2855N, 2955, 3010, 3055, 3155, 3255, Utility: 2155	Hydraulic Pump Shaft Use in 40 cm ³ Pumps	AMR79150	\$ 99.50	
3140, 4000, 4020, 4040, 4230, 4240, 4320, 4430, 4440, 4520, 4620, 4630, 4640, 4840, 8430, 8440, 8630, 8640	Hydraulic Pump Shaft 14 Spline For 66 cc (4.3 cu. in.) Pumps	AMR79156	\$ 82.00	
3 cu. in. Serialized	Seal Kit	AMRE29107	\$ 55.00	
3 cu. in. Non-Serialized	Seal Kit	AMRE29103	\$ 50.00	
4 cu. in. Serialized	Seal Kit	AMRE29109	\$ 70.00	
3 cu. in. Non-Serialized & Serialized	Piston, Standard	AMR27150	\$ 12.00	
	Piston, Oversized	AMR55988	\$ 10.48	
4 cu. in. Serialized	Piston	AMR70976	\$ 16.00	
3 cu. in. Non-Serialized & Serialized	Piston Plug	AMR45438	\$ 4.00	
3 cu. in. Non-Serialized & Serialized, 4 cu. in. Serialized	Plug 1 1/8" Diameter	AMR78293	\$ 4.00	
4 cu. in. Serialized	Piston Plug	AMR70648	\$ 6.50	
2.4 cu. in. Serialized & Non-Serialized, 3 cu. in. Serialized & Non-Serialized, 4 cu. in. Serialized & Non-Serialized	Inlet Valve	AMAR53301	\$ 30.00	
3 cu. in. Non-Serialized	Crankcase Outlet Valve	AMR27172	\$ 19.00	
3 cu. in. Serialized, 4 cu. in. Serialized	Crankcase Outlet Valve	AMR70867	\$ 15.00	
3 cu. in. Non-Serialized	Sleeve Valve	AMR70351	\$ 11.50	
3 cu. in. Non-Serialized & Serialized, 4 cu. in. Serialized	Valve Assembly	AMRE23382	\$ 5.00	
	Pressure Compensator Valve Assembly	AMRE10712	\$ 35.00	
	Valve Seat	AMR105583	\$ 4.75	
3 cu. in. Non-Serialized	Spring	AMR27159	\$ 3.25	
3 cu. in. Non-Serialized & Serialized	Spring Kit, 8 pieces	AMAR76762	\$ 18.00	
3 cu. in. Serialized, 4 cu. in. Serialized	Spring	AMR70868	\$ 2.00	
4 cu. in. Serialized	Spring Kit, 16 pieces	AMAR96408	\$ 40.00	
3 cu. in. Non-Serialized & Serialized, 4 cu. in. Serialized	Inner Washer	AMR34349	\$ 5.00	
3 cu. in. Non-Serialized	Thrust Washer	AMR60732	\$ 6.25	
	Cam Bearing Race	AMR45874	\$ 32.00	
3 cu. in. Serialized, 4 cu. in. Serialized	Cam Bearing Race	AMR80558	\$ 55.00	
3 cu. in. Non-Serialized & Serialized, 4 cu. in. Serialized	Bearing Cup	3820	\$ 7.00	
	Bearing Cone	3872	\$ 14.00	
2030, 2140 ASN 429999, 2350, 2355, 2440, 2510, 2520, 2550, 2555, 2630, 2640, 2750, 2755, 2840, 2855N, 2940, 2950, 2955, 3010, 3020, 3055, 3255, 4010, 4020, 4030, 4040, 4050, 4055, 4230, 4240, 4250, 4255, 4320, 4430, 4440, 4450, 4455, 4520, 4555, 4560, 4620, 4640, 4755, 4760, 4840, 4955, 4960, 5010, 5020, 7520, 8430, 8440, 8450, 8560, 8630, 8640, 8650, 8760, 8850, 8960, Utility: 2155, Cotton Pickers: 9950, 9960, 9965	Bearing Cone and Cup Set Includes one of each For Hydraulic Pump Shaft	AMBR1683	\$ 37.30	
3 cu. in. Serialized, 4 cu. in. Serialized	Needle Roller 1/4" Diameter	AMR116712	\$ 0.50	

Prices Subject to Change without Prior Notice. The use of original equipment manufacturer (OEM) part numbers or trademarks, e.g. Case® and John Deere®, are for reference purposes only and for indicating product use and compatibility. Our company and the listed replacement parts contained herein are not sponsored, approved or manufactured by the OEM. All parts are New unless designated Reman in the description.

John Deere®—Tractor

Application	Description	Part Number	Retail Price	Core
3 cu. in. Non-Serialized	Needle Roller 3/16" Diameter	AMR27145	\$ 0.40	
3 cu. in. Non-Serialized & Serialized, 4 cu. in. Serialized	Disc	AMR49297	\$ 1.00	
	Adjuster	AMAR52254	\$ 10.50	
	Adjuster Nut	AM14H1021	\$ 1.50	
3 cu. in. Serialized, 4 cu. in. Serialized	Pin	AMR75564	\$ 1.88	
2.4 cu. in. Non-Serialized, 3 cu. in. Non-Serialized, 4 cu. in. Non-Serialized	Filter	AMR27173	\$ 6.75	
(1640, 2040, 3040, 3140 ASN 429999), 2140, 2150, 2255, 2350, 2355, 2355N, 2550, 2555, 2750, 2755, 2855N, 2940, 2955 BSN 767515, 3055, 3150, 3255, Utility: 2155, 2240 ASN 349999	Front Coupling For Hydraulic Pump Drive Shaft	AML34432	\$ 16.00	
7210R, 7230R, 7250R, 7270R, 7290R, 7310R, 8245R, 8270R, 8295R, 8320R, 8335R, 8345R, 8370R, 8400R, 9370R, 9420R, 9420RX, 9470R, 9470RT, 9470RX, 9520R, 9520RT, 9520RX, 9570R, 9570RT, 9570RX, 9620R, 9620RX	Hydraulic Quick Coupler, Female	AMRE345116	\$ 63.44	
Utility: 1023E, 1025R, 1026R, 2025R, 2026R, 2032R, 2038R, 3025E, 3032E, 3033R, 3036E, 3038E, 3038R, 3039R, 3045R, 3046R, 3120, 3203, 3320, 3520, 3720, 4044M, 4044R, 4049M, 4049R, 4052M, 4052R, 4066M, 4066R, 4105, 4120, 4210, 4310, 4320, 4410, 4510, 4520, 4610, 4710, 4720	Hydraulic Quick Coupler 2.64" Long	AMLVA13231	\$ 23.79	
1350, 1550, (1640, 2040, 2040S, 2140, 3040, 3140 - w/ Increased Lifting Capacity), 1750, 1850, 1950, 1950N, 2150, 2155, 2250, 2350, 2355, 2355N, 2450, 2550, 2555, 2650, 2650N, 2750, 2755, 2850, 2855N, 2950, 2955, 3050, 3055, 3155, 3255, 3350, 3640, 3640S, 3650	Hydraulic Quick Coupler Socket Replaces AL41599	AMAL172304	\$ 17.45	
5065M, 5070M, 5075M, 5076E, 5076EF, 5076EL, 5076EN, 5080M, 5082E, 5083E, 5083EN, 5085E, 5085M, 5090E, 5090EH, 5090EL, 5090EN, 5090M, 5090R, 5093E, 5093EN, 5095M, 5095MH, 5100E, 5100M, 5100MH, 5100ML, 5100R, 5101E, 5101EN, 5105, 5105M, 5105ML, 5115M, 5115ML, 5115R, 5125R, 5205, 5220, 5225, 5320, 5325, 5325N, 5415, 5420, 5425, 5425N, 5520, 5525, 5525N, 5615, 5625, 5715, 5725, 6100D, 6105D, 6105E, 6110D, 6115D, 6120E, 6125D, 6130D, 6135E, 6140D, 6403, 6603	Hydraulic Quick Coupler Socket	AMRE255758	\$ 63.69	
8130, 8225R, 8230, 8230T, 8235R, 8245R, 8260R, 8270R, 8285R, 8295R, 8295RT, 8310R, 8310RT, 8320R, 8320RT, 8330, 8330T, 8335R, 8335RT, 8345R, 8345RT, 8360R, 8360RT, 8370R, 8400R, 8430, 8430T, 8530, 9360R, 9410R, 9420RX, 9510R, 9510RT, 9520RX	Pressure Relief Valve	AMAE38448	\$ 6.00	

Power Steering Pump

Application	Description	Part Number	Retail Price	Core
Utility: 4510, 4610, 4710	Power Steering Pump 18 cc	AMLVA11452	\$ 450.00	

John Deere®—Tractor

Power Steering Cylinders and Components

Application	Description	Part Number	Retail Price	Core
(1640, 2040, 2040S, 2140, 3040, 3140 ASN 429999 w/ Hydrostatic Steering), (2250, 2350, 2355, 2550, 2555, 2750, 2755, 2940, 2950, 2955, 3050, 3055, 6100, 6110, 6110L, 6120, 6120L, 6200, 6200L, 6210, 6210L, 6220, 6220L, 6230, 6300, 6300L, 6310, 6310L, 6310S, 6320, 6320L, 6330, 6400, 6400L, 6403, 6405, 6410, 6410L, 6410S, 6420, 6420L, 6420S, 6430, 6510L, 6510S, 6520L, 6603, 6605, 7130, 7405, Premium Models: 6230, 6330, 6430 - w/ Hydrostatic Steering)	Power Steering Cylinder Pin 3.120" Long, 0.984" OD	AML36085	\$ 11.06	
2140 ASN 430000, 2350, 2355, 2550, 2555, 2750, 2755, 2950, 3140 BSN 449999, 6500, 6200L, 6300L, 6400L, 6500L	Power Steering Cylinder Replaces AL34542, AL36565, AL112919	AMAL61553	\$ 240.00	
4050, 4250, 4450, 4650, 4850, 5010, 5020, 6030, Ind: 500, 600, 700A	Power Steering Cylinder Pin Replaces R30917	AMR76513	\$ 15.82	
5045E, 5055E, 5065E, 5065M, 5075E, 5075M, 5076E, 5082E, 5083E, 5085E, 5085M, 5090E, 5090E Hi-Clearance, 5093E, 5095M, 5095MH, 5100E, 5100M, 5100MH, 5101E, 5103 ASN 013640, 5105M, 5105ML, 5115M, 5115ML, 5203 ASN 005569, 5225, 5303 ASN 007752, 5325, 5403 ASN 001357, 5415, 5415H, 5425, 5525, 5603, (5605, 5705 ASN 080729), 5615, 5625, 5715, 5715HC, 5725 ASN 005048	Power Steering Cylinder	AMRE271434	\$ 650.00	
(6100D, 6110D, 6115D, 6125D, 6130D, 6140D BSN 050000), 6105E, 6120E, 6135E, 6403, 6603 - w/ MFWD	Power Steering Cylinder	AMRE282742	\$ 1000.00	
7200, (7210, 7410 Axle SN 068187-75235), 7400 - w/ MFWD	Power Steering Cylinder Pin 4.665" Long, 0.982" OD	AMR153159	\$ 68.37	
7200, (7210, 7410 Axle SN 068187-75235), 7400, 7600, (7610, 7710, 7810 BSN 090000 Axle SN 068187-75235), 7700, 7800, (8100, 8200, 8300, 8400 Axle BSN 077516) - All w/ MFWD	Power Steering Cylinder Pin 5.02" Long, 0.98" OD	AMR116206	\$ 20.00	
7200, (7210, 7410, 7610, 7710, 7810 Axle SN 001001-075235), 7400, 7600, 7700, 7800, (8100, 8200, 8300, 8400 Axle BSN 029260)	Power Steering Cylinder Seal Kit Replaces RE49789, RE58695, RE60326	AMRE61543	\$ 55.38	
7200R, 7210R, 7215R, 7230R, 7250R, 7260R, 7270R, 7280R, 7290R, 7310R, 8100, 8110, 8120, (8130, 8230, 8330, 8430 ASN 001000), 8200, 8210, 8220, 8225R, 8235R, 8245R, 8260R, 8270R, 8285R, 8295R, 8300, 8310, 8310R, 8320, 8335R BSN 090001, 8400, 8410, 8420, 8520	Hydraulic Cylinder Seal Kit, Steering Cylinder Replaces AH231937	AMAH164325	\$ 18.29	
7200R, 7210R, 7215R, 7230R, 7250R, 7260R, 7270R, 7280R, 7290R, 7310R, 8100, 8110, 8120, 8130, 8200, 8210, 8220, 8225R, 8230, 8235R, 8245R, 8260R, 8270R, 8285R, 8295R, 8300, 8310, 8310R, 8320, 8330, 8335R, 8400, 8410, 8420, 8430 2006-09, 8520, 8530	Steering Cylinder Pin	AMR133564	\$ 32.75	
7330, 7430, 7530, Premium Models: 7330, 7430, 7530	Power Steering Cylinder	AMAL175594	\$ 950.00	
7600, (7610, 7710, 7810 BSN 090000 Axle SN 068187-075235), 7700, 7800, (8100, 8200, 8300, 8400 Axle SN 068187-075515)	Power Steering Cylinder Pin 4.803" Long, 0.982" OD Replaces R95117	AMR153160	\$ 21.00	
9100, 9120, 9200, 9220, 9300, 9320, 9400, 9420, 9520, 9620	Power Steering Cylinder Pin, Greaseable 5.591" Long, 2.081" OD	AMR211866	\$ 87.55	
Utility: 4044M, 4044R, 4049M, 4049R, 4052M, 4052R, 4066M, 4066R - w/ MFWD	Power Steering Cylinder	AMLVA19445	\$ 500.00	
8560, 8570, 8760, 8770, 8870, 8960, 8970, 9100, 9120, 9200, 9220, 9300, 9320, 9400, 9420, 9520, 9620	Power Steering Cylinder Pin	AMR112154	\$ 68.57	
9230, 9330, 9360R, 9370R, 9410R, 9420R, 9420RX, 9430, 9460R, 9470R, 9470RX, 9510R, 9520R, 9520RX, 9530, 9560R, 9570R, 9570RX, 9620R, 9620RX, 9630	Power Steering Cylinder Front Pin, Greaseable	AMR343193	\$ 87.19	
9230, 9330, 9360R, 9370R, 9410R, 9420R, 9420RX, 9430, 9460R, 9470R, 9470RX, 9510R, 9520R, 9520RX, 9530, 9560R, 9570R, 9570RX, 9620R, 9620RX, 9630	Power Steering Cylinder Rear Pin, Greaseable Replaces R247734	AMR343194	\$ 91.11	

Prices Subject to Change without Prior Notice. The use of original equipment manufacturer (OEM) part numbers or trademarks, e.g. Case® and John Deere®, are for reference purposes only and for indicating product use and compatibility. Our company and the listed replacement parts contained herein are not sponsored, approved or manufactured by the OEM. All parts are New unless designated Reman in the description.

John Deere®—Tractor

Application	Description	Part Number	Retail Price	Core
9230, 9330, 9360R, 9370R, 9410R, 9420R, 9420RX, 9430, 9460R, 9470R, 9470RX, 9510R, 9520R, 9520RX, 9530, 9560R, 9570R, 9570RX, 9620R, 9620RX, 9630	Steering Cylinder Bushing, Greaseable	AMR247733	\$ 20.22	



Power Steering Orbit Motor

Application	Description	Part Number	Retail Price	Core
2355, 2555, 2755, 2855, 2955, 3055, 3255 - w/ MFWD	Power Steering Orbit Motor Mfg # - 262-1002-073 Replaces AL41634	AMAL69803	\$ 855.00	
2750, 2950, 2755, 2955, 3040, 3140 - Early w/o FWA	Power Steering Orbit Motor Mfg # - 212-1002-001, 212-1002-002 Valve Block Required	AMAT61108	\$ 675.00	
2750, 2950, 2755 - Late w/o FWA	Power Steering Orbit Motor Mfg # - 262-1001-073, 262-1006-272, 262-1001-074	AMAL41633	\$ 1095.00	
2750, 2755, 2950, 2955, 3040, 3140 - Early w/ FWA	Power Steering Orbit Motor Mfg # - 262-1004-001, 212-1004-002 Valve Block Required	AMAT61110	\$ 775.00	
2750, 2755, 2940, 2950, 2955, 3040, 3140 - Late w/ FWA	Power Steering Orbit Motor Mfg # - 200-0476-002, 262-1003-073, 262-1003-74	AMAL41635	\$ 975.00	



Steering Columns and Valves

Application	Description	Part Number	Retail Price	Core
940, 1040, 1140, 1550, 1640, 1750, 1850, 2040, 2150, 2350, 2550, 2255, 2355N - w/o Cab w/ Closed Centers, Utility: 2155, 2240 - w/o Cab w/ Closed Centers	Steering Column Assembly 15 1/2" Tall Housing	AMAL31262	\$ 775.00	
3010, 4010	Reman Steering Column Assembly	SV4010-R	\$ 995.00	\$ 250.00
(3020, 4020 Early)	Reman Steering Column Assembly	SV4020E-R	\$ 995.00	\$ 250.00
3020 Late, 4020 Late, 4320, 4520, 4620, 6030 - All units w/ Side Console Hydraulics ONLY	Reman Steering Column Assembly	SV4020L-R	\$ 995.00	\$ 250.00
4030, 4230, 4430, 4630	Steering Column Assembly Conversion to Hydrostatic Steering Uses all Original Hoses, Steel Lines and Fittings Features Direct Replacement for Original Steering Valve, 7075T 6-Billet Aluminum Hydrostatic Manifolds, Chromoly Steering Column and Shaft, Self-Lubricating Bronze Bushings and Stainless Steel Hardware Replaces AR43089, AR56007	SV4430-N	\$ 1295.00	
4230 Early, 4430-4630 - w/ Steering Valve Like 4020	Reman Steering Column Assembly	SV4430-R	\$ 995.00	\$ 250.00
7020, 7520	Reman Steering Column Assembly	SV7520-R	\$ 995.00	\$ 250.00
4030, 4040, 4240, 4440, 4050, 4250, 4450, 4230, 4430, 4630, 4640, 4840, 4650, 4850	Reman Steering Metering Pump	AMAR89199-R	\$ 995.00	\$ 100.00
8560, 8570, 8760, 8770, 8870, 8960, 8970	Reman Steering Metering Pump	AMRE25231	\$ 775.00	\$ 250.00
2510, 2520, 3010, 3020, 4010, 4020, 4320, 4520, 4620	Steering Valve Conversion to Hydrostatic Steering Uses all Original Hoses, Steel Lines and Fittings	SV4020-N	\$ 1225.00	

John Deere®—Tractor

Application	Description	Part Number	Retail Price	Core
4030, 4040, 4050, 4055, 4240, 4250, 4255, 4430, 4440, 4450, 4455, 4555, 4560, 4630, 4640, 4755, 4760, 4840, 4955, 4960, Cotton Pickers: 9940, 9950	Steering Valve Marked R57120, R110470 w/o MFWD or PFWD Replaces AR68411, AR90611, RE48066	AMRE247520	\$ 625.00	
4230 ASN 19559, 4430 ASN 27635, 4630 ASN 10647 - 2WD	Reman Steering Valve Replaces AR72338, AR90611, RE48066	AMAR68411	\$ 545.00	\$ 100.00
8430, 8450, 8630, 8440, 8560, 8570, 8640, 8650, 8760, 8770, 8870, 8960, 8970	Reman Steering Valve	AMAR77223	\$ 975.00	\$ 100.00
1020, 1520, 1530, 2020, 2030, 2440, 2630, 2640, 2840	Power Steering Seal Kit O-Ring and Seal Kit Only Bushings, Housings and Sleeves Not Included Use w/ AMAL31262	AMAT26188	\$ 66.33	



Remote Valve Kits

Application	Description	Part Number	Retail Price	Core
2520, (3020, 4000, 4020 - w/ Side Console Hydraulics), 4320, 4520, 4620	Reman Second Valve Kit	RVK4020L-2	\$ 1375.00	
3010	Reman Second Valve Kit	RVK3010	\$ 1375.00	
3020 BSN 122999 w/ Hydraulics on Dash	Reman Second Valve Kit	RVK3020	\$ 1375.00	
4010	Reman Second Valve Kit	RVK4010	\$ 1375.00	
4020 BSN 200999 w/ Hydraulics on Dash	Reman Second Valve Kit	RVK4020	\$ 1375.00	
(3020, 4000, 4020 - w/ Side Console Hydraulics), 4320, 4520, 4620	Reman Third Valve Kit	RVK4020L-3	\$ 1675.00	
4030, 4230, 4430, 4630	Reman Third Valve Kit	RVK4630	\$ 1675.00	
4040, 4240, 4440, 4640, 4840	Reman Third Valve Kit	RVK4640	\$ 1675.00	
4050, 4250, 4450, 4650, 4850	Reman Third Valve Kit	RVK4650	\$ 1950.00	
4030, 4050, 4055, 4230, 4240, 4250, 4255, 4430, 4440, 4450, 4455, 4555, 4560, 4630, 4640, 4650, 4755, 4760, 4840, 4850, 4955, 4960, 8440, 8450, 8560, 8570, 8630, 8640, 8650, 8760, 8770, 8850, 8870, 8960, 8970	Power Beyond Block Kit Includes Manifold, 90° Fitting, Elbow Fitting, 90° Elbow Fitting, Rod, 3.20 mm x 20 mm Cotter Pin, Pin Fastener, (2) Packing, (2) Back-Up Rings, (3) O-Rings and (4) 7/16" x 2 3/4" Cap Screws	AMAR71331	\$ 202.45	
6105M, 6110M, 6115M, 6120M, 6125M, 6130M, 6140M, 6145M, 6150M, 6155M, 6170M, 6175M, 6195M, 7330, Premium Model: 7330	Hydraulic Quick Coupler Socket	AMAL221083	\$ 72.54	



Selective Control Valves and Couplers

Application	Description	Part Number	Retail Price	Core
1020, 1030, 1130, 1520, 1530, 1630, 1640, 1830, 2020, 2030, 2040, 2130, 2140, 2440, 2520, 2630, 2640, 2840, 2940, 3020, 3030, 3040, 3130, 3140, 4000, 4020, 4030, 4040, 4230, 4240, 4320, 4430, 4440, 4520, 4620, 4630, 4640, 4840, 5020, 6030, 7020, 7520, 8430, 1974-81, 8440, 8630, 8640, Utility: 2240	ISO Coupler Assembly Set of 2 Converts John Deere® Remote Couplers to ISO/Pioneer Couplers Replaces RE206778	AMRE12121	\$ 177.00	
1020, 1520, 1530, 2020, 2030, 2040, 2440, 2640, 2630, Utility: 2240	Reman Remote Valve - Inside	AMV2440-1	\$ 850.00	\$ 200.00

John Deere®—Tractor

Application	Description	Part Number	Retail Price	Core
2010, 3010, 4010, 5010	Reman Remote Valve - 1st	AMV25031	\$ 775.00	\$ 200.00
	Reman Remote Valve - 2nd	AMV25031-2	\$ 775.00	\$ 200.00
	Reman Remote Coupler	AMC25310	\$ 495.00	\$ 125.00
2510, 3020 BSN 122999, 4020 BSN 200999	Reman Remote Valve - 1st	AMV25032	\$ 775.00	\$ 200.00
	Reman Remote Valve - 2nd	AMV25032-2	\$ 775.00	\$ 200.00
	Reman Remote Coupler	AMC25320	\$ 495.00	\$ 125.00
1250, 1450, 1650, 4050, 4055, 4250, 4255, 4450, 4455, 4555, 4560, 4650, 4760, 4850, 4960, 8450, 8650, 8850	Reman Selective Control Valve - 1st & 2nd Core charge includes similar core or upgrade for an additional \$250.00	AMSCV50650-RC	\$ 1395.00	\$ 350.00
	Reman Selective Control Valve - 3rd 1-Piece Unit Core charge includes similar core or upgrade for an additional \$250.00	AMSCV50650-R-3	\$ 1395.00	\$ 350.00
2150, 2350, 2355, 2355N, 2555, 2755, 2950, 2955, 3055, 3155, 3255, Utility: 2155	Selective Control Valve Spool Type Valve Replaces AL26989, AL30397, AT31246	AMAL34593	\$ 261.00	
2520, 3020 ASN 123000, 4000, 4020 ASN 201000, 4030, 4040, 4230, 4240, 4320, 4430, 4440, 4520, 4620, 4630, 4640, 4840, 8430, 8440, 8630, 8640	Reman Selective Control Valve - 1-Piece	AMSCV40640-RC	\$ 1025.00	\$ 200.00
	Reman Selective Control Valve - 1-Piece w/ ISO Coupler	AMSCV40640-ISO	\$ 1125.00	\$ 200.00
4030, 4040, 4230, 4240, 4320, 4430, 4440, 4520, 4620, 4630, 4640, 4840, 8430, 8440, 8630, 8640	Reman Selective Control Valve - 3rd 1-Piece Unit	AMSCV40640-RC-3	\$ 1025.00	\$ 200.00
	Reman Selective Control Valve w/ ISO, 3rd Valve	AMSCV40640-ISO-3	\$ 1125.00	\$ 200.00
1010, 1020, 1030, 1130, 1520, 1530, 1630, (1640, 2040S, 2140, 3040, 3140 ASN 430000), 1830, 2010, 2020, 2040, 2130, 2440, 2510, 2520, 2630, 2640 ASN 341000, 2840, 2940, 3020, 3030, 3130, 3640 BSN 340999, (4000, 4020 ASN 201000), 4030, 4040, 4240, 4320, 4430, 4440, 4520, 4620, 4630, 4640, 4840, 5010, 5020, 6030, 7020, 7520, 8430, 8440, 8630, 8640, Ind: 300, 301, 400, 401, 500, 600, Utility: 2240	Outlet Socket, Selective Control Valve Coupler	AMR34397	\$ 52.50	
6110, 6110L, 6120, 6120L, 6200, 6200L, 6210, 6210L, 6220, 6220L, 6300, 6300L, 6310, 6310L, 6310S, 6320, 6320L, 6400, 6400L, 6410, 6410L, 6410S, 6420, 6420L, 6500, 6500L, 6510L, 6510S, 6520L, 7200, 7400	Reman Selective Control Valve 2 Detent Valve, 200 Series	AMAL171118	\$ 875.00	\$ 250.00
6110, 6110L, 6120, 6120L, 6200, 6200L, 6210, 6210L, 6220, 6220L, 6300, 6300L, 6310, 6310L, 6310S, 6320, 6320L, 6400, 6400L, 6410, 6410L, 6410S, 6420, 6420L, 6500, 6500L, 6510L, 6510S, 6520L, (7210, 7410, 7510, 7610, 7710, 7810 ASN 033914), 7220, 7320, 7420, 7505, 7520, 7630, 7720, 7730, 7820, 7830, 7930	Reman Selective Control Valve 3 Detent Valve - Late, 300 Series Core Valve Must be Complete w/ Plungers to Receive Core Credit	AMRE239127	\$ 925.00	\$ 250.00
7200, (7210, 7410, 7510 BSN 033913), 7400, 7600, (7610, 7710, 7810 BSN 033918), 7700, 7800	Reman Selective Control Valve 3 Detent Valve - Early, 300 Series Controlled by Linkage Core Valve Must be Complete w/ Plungers to Receive Core Credit	AMRE246372	\$ 825.00	\$ 250.00
8100, 8100T, 8110, 8110T, 8200, 8200T, 8210, 8210T, 8300, 8300T, 8310, 8310T, 8400, 8400T, 8410, 8410T, 9100, 9200, 9300, 9300T, 9400T	Reman Selective Control Valve Core Valve Must be Complete w/ Plungers to Receive Core Credit Replaces RE61121	AMRE60892	\$ 1550.00	\$ 350.00

John Deere®—Tractor

Application	Description	Part Number	Retail Price	Core
8120, 8120T, 8220, 8220T, 8320, 8320T, 8420, 8420T, 8520, 8520T, 9120, 9220, 9320, 9320T, 9420, 9420T, 9520, 9520T, 9620, 9620T	Reman Selective Control Valve Core Valve Must be Complete w/ Plungers to Receive Core Credit	AMRE262576	\$ 2500.00	\$ 500.00
(8130, 8230, 8330, 8430, 8530 BSN 904999), (8230T, 8330T, 8430T BSN 039999), (9230, 9330, 9430, 9530, 9630 BSN 012999), (9430T, 9530T, 9630T BSN 910999)	Reman Selective Control Valve Core Valve Must be Complete w/ Plungers to Receive Core Credit	AMRE262092	\$ 1975.00	\$ 500.00
2520, 3020 ASN 123000, (4000, 4020 ASN 201000), 4030 BSN 12617, 4230 BSN 27854, 4320, 4430 BSN 44904, 4630 BSN 16902, 8430 BSN 001740, 8630 BSN 002452	Second Valve Plate	AMAR71188	\$ 120.00	
4030, 4040, 4040S, 4230, 4240, 4240S, 4350, 4430, 4440, 4630, 4640, 4840, 8430, 8440, 8630, 8640	Third Valve Plate Includes Plugs and Spool Valve Replaces R60395, R65146	AMAR73897	\$ 595.00	
2520, 3020 ASN 123000, (4000, 4020 ASN 201000), 4030, 4230, 4320, 4430, 4630, 8430, 8630	Third Valve Plate Replaces R41448, R50067, R59084	AMAR71189	\$ 365.00	
2520, 3020 ASN 123000, (4000, 4020 ASN 201000), 4030, 4040, 4050, 4055, 4240, 4250, 4255, 4440, 4450, 4455, 4640, 4650, 4755, 4760, 4840, 4850, 4960, 8430, 8440, 8450, 8630, 8640, 8650, 8760, 8770, 8850, 8870, 8960, 8970	Hydraulic Cover Automatic Closing	AMSS2102	\$ 54.00	
2510, 3010, 3020 BSN 123000, 4010, 4020 BSN 201000, 5010, 5020, 7020, 7520 - 1965-68	Hydraulic Cover Automatic Closing	AMSS2103	\$ 66.00	
2520, 3020 ASN 123000, (4000, 4020 ASN 201000), 4030, 4040, 4050, 4055, 4240, 4250, 4255, 4440, 4450, 4455, 4640, 4650, 4755, 4760, 4840, 4850, 4960, 8430, 8440, 8450, 8630, 8640, 8650, 8760, 8770, 8850, 8870, 8960, 8970 1969 and Later	Hydraulic Port Lever Push/Pull Lever Releases Port for Easy Hookup and Unhooking	AMSS2004	\$ 36.00	
940, 1020, 1030, 1040, 1130, 1140, 1630, 1520, 1530, 1550, 1640, 1750, 1830, 1840, 1850, 1850M, 2020, 2030, 2040, 2130, 2140, 2150, 2250, 2255, 2350, 2355, 2520, 2555, 2630, 2640, 2650, 2750, 2755, 2840, 2850, 2855, 2940, 2950, 2955, 3020 Late, 3030, 3040, 3055, 3130, 3140, 3150, 3155, 3255, 4000, 4020 Late, 4030, 4040, 4050, 4055, 4230, 4240, 4250, 4255, 4320, 4430, 4440, 4450, 4455, 4520, 4555, 4560, 4620, 4630, 4640, 4650, 4755, 4760, 4840, 4850, 4955, 4960, 5020, 6030, 7020, 7520, 8430, 8440, 8450, 8560, 8570, 8630, 8640, 8650, 8760, 8770, 8870, 8960, Utility: 2155, 2240	Valve Spool	AMAR86535	\$ 25.00	
1020, 1030, 1130, 1630, 1520, 1530, 1640, 1830, 2020, 2030, 2040, 2130, 2140, 2440, 2630, 2640, 2840, 2940, 3030, 3130, 3040, 3140, Utility: 2240	Reman Breakaway Coupler Right Hand Reman Breakaway Coupler Left Hand	AMAR52621 AMAR52622	\$ 525.00 \$ 525.00	\$ 75.00 \$ 75.00
(1640, 2040, 2040S, 2140, 3040, 3140 ASN 430000), 2150, 2255, 2350, 2550, 2355, 2555, 2750, 2755, 2950, 2955 BSN 765516, 3055, 3255, 3150, 3155, Utility: 2155	Reman Breakaway Coupler Removable Metal Brackets Not Included	AMRE22586	\$ 525.00	\$ 125.00

John Deere®—Tractor

Application	Description	Part Number	Retail Price	Core
1640, 2040, 2140, 2150, 2255, 2750, 2950, 3040, 3140	Reman Breakaway Coupler Right Hand	AMR73116	\$ 475.00	\$ 75.00
	Reman Breakaway Coupler Left Hand	AMR73117	\$ 475.00	\$ 75.00
6100, 6110, 6110L, 6120, 6120L, 6200, 6200L, 6210, 6210L, 6220, 6220L, 6300, 6300L, 6310, 6310L, 6310S, 6320, 6320L, 6400, 6400L, 6410, 6410L, 6410S, 6420, 6420L, 6420S, 6500, 6500L, 6506, 6510L, 6510S, 6520, 6600, 6610, 6620, 6820, 7220, 7320, 7420, 7520	Breakaway Coupler Sold in Multiples of 2, Priced Individually Replaces AL169645, AL178989, AL202351	AMAL210588	\$ 75.52	
7200, 7200R, 7210, 7210R, 7215R, 7230R, 7260R, 7270R, 7280R, 7290R, 7310R, 7400, 7410, 7510, 7600, 7610, 7630, 7710, 7720, 7730, 7800, 7810, 7820, 7830, 7920, 7930, 8120, 8120T, 8130, 8220, 8220T, 8225R, 8230, 8230T, 8235R, 8245R, 8260R, 8270R, 8285R, 8295R, 8295RT, 8310R, 8310RT, 8320, 8320R, 8320RT, 8320T, 8330, 8330T, 8335R, 8335RT, 8345R, 8345RT, 8360R, 8360RT, 8370R, 8370RT, 8420, 8420T, 8430, 8430T, 8520, 8520T, 8530, 9120, 9220, 9230, 9320, 9320T, 9330, 9360R, 9370R, 9410R, 9420, 9420R, 9420T, 9430, 9430T, 9460R, 9460RT, 9470R, 9470RT, 9510R, 9510RT, 9520, 9520R, 9520RT, 9520T, 9530, 9530T, 9560R, 9560RT, 9570R, 9570RT, 9620, 9620R, 9620T, 9630T	Hydraulic Breakaway Coupler Cartridge Recommended to purchase in quantities of two (pressure and return) Replaces RE203206, RE226728, RE577560	AMRE256693	\$ 93.00	
8100, 8100T, 8110, 8110T, 8200, 8200T, 8210, 8210T, 8300, 8300T, 8310, 8310T, 8400, 8400T, 8410, 8410T, 9100, 9200, 9300, 9300T, 9400, 9400T	Breakaway Coupler, Selective Control Valve Recommended to purchase in quantities of two (pressure and return)	AMR52981	\$ 139.00	
6100, 6110, 6110L, 6120, 6120L, 6200, 6200L, 6210, 6210L, 6220, 6220L, 6300, 6300L, 6310, 6310L, 6310S, 6320, 6320L, 6400, 6400L, 6410, 6410L, 6410S, 6420, 6420L, 6420S, 6500, 6500L, 6506, 6510L, 6510S, 6520, 6600, 6610, 6620, 6820, 7220, 7320, 7420, 7520	Internal Female Coupler 3.858" (98 mm) Long Replaces AL169646, AL178990, AL202352	AMAL210586	\$ 62.75	
6105M, 6105R, 6115M, 6115R, 6125M, 6125R, 6140J, 6140M, 6140R, 6150M, 6150R, 6155J, 6170M, 6170R, 6190R, 6210R, 7230, 7330, 7405, 7500, Premium Models: 6230, 6330, 6430, 7430, 7530, 7130	Internal Female Coupler	AMAL210587	\$ 72.60	
4050, 4055, 4250, 4255, 4450, 4455, 4555, 4560, 4650, 4755, 4850, 4955, 4960, 8450, 8560, 8570, 8650, 8760, 8770, 8850, 8870, 8960, 8970	Breakaway Coupler Seal Kit Replaces RE38130, RE57221	AMRE66985	\$ 30.50	
1020, 1520, 1530, 1640, 2010, 2040, 2140, 2440, 2510, 2520, 2630, 2640, 2840, 2940, 3010, 3020, 3040, 3140, 4000, 4010, 4020, 4030, 4040, 4230, 4240, 4320, 4430, 4440, 4520, 4620, 4630, 4640, 4840, 5010, 5020, 6030, 7020, 7520, 8430, 8440, 8630, 8640, Utility: 2240	Coupler Seal Kit	AMAR82570	\$ 26.00	

John Deere®—Tractor

Application	Description	Part Number	Retail Price	Core
1020, 1520, 1640 ASN 430000, 2020, 2030, 2040 ASN 430000, 2040S ASN 430000, 2140 ASN 430000, 2150, 2350, 2255, 2355, 2355N, 2440, 2520, 2550, 2555, 2630, 2640, 2750, 2755 (GPT), 2840, 2855N, 2940, 2950, 2955, 3020, 3040 ASN 430000, 3055, 3140 ASN 430000, 3150, 3155, 3255, 4000, 4020, 4030, 4040, 4050, 4055, 4230, 4240, 4250, 4255, 4320, 4430, 4440, 4450, 4455, 4520, 4555, 4560, 4620, 4630, 4640, 4650, 4755, 4760, 4840, 4850, 4955, 4960, 5020, 6030, 7020, 7520, 8430, 8440, 8450, 8560, 8570, 8630, 8640, 8650, 8760, 8770, 8850, 8870, 8960, 8970, Ind: 300B, Utility: 2155, 2240	Selective Valve Seal Kit	AMRE10924	\$ 29.00	
5200, 5210, 5300, 5310, 5400, 5410, 5500, 5510	Push/Pull Cable, Selective Control Valve 32.20" Overall Length, 1" Travel Length Replaces RE45616	AMRE70355	\$ 49.83	
8430, 8630, 8850	Selective Control Valve Cable Replaces AR69797	AMAR103305	\$ 99.50	



Hydraulic Covers and Parts

Application	Description	Part Number	Retail Price	Core
2510, 3010, 3020 BSN 122999, 4010, 4020 BSN 200999	Hydraulic Cover w/o Tool Box	Right Hand	AMR27543	\$ 145.00
		Left Hand	AMR27544	\$ 145.00
3020 Late, 4000, 4020 Late, 4320	Hydraulic Cover Kit Includes (1) AMAR40817, (1) AMAR41599 and (1) AMR41231	AMR4020RCK	\$ 295.00	
	Hydraulic Cover w/o Tool Box	Left Hand	AMAR40817	\$ 145.00
3020 ASN 123000, 4000, 4020 ASN 201000, 4320	Hydraulic Cover	Right Hand	AMAR41599	\$ 145.00
		Center	AMR41231	\$ 60.00
7200, 7210, 7400, 7405, 7410, 7500, 7505, 7510, 7600, 7610 BSN 89999, 7630, 7700, 7710, 7720, 7730, 7800, 7810, 7820, 7830, 7920, 8100, 8100T, 8110, 8110T, 8120, 8120T, 8130, 8200, 8200T, 8210, 8210T, 8220, 8220T, 8225R, 8230, 8230T, 8245R, 8270R, 8295R, 8295RT, 8300, 8300T, 8310, 8310T, 8320, 8320R, 8320RT, 8320T, 8330, 8330T, 8345R, 8345RT, 8400, 8400T, 8410, 8410T, 8420, 8420T, 8430 (2006-09), 8430T, 8520, 8520T, 8530	Deck Plate Indicator Shaft	AMR111692	\$ 30.27	

Topshafts

Each unit is carefully disassembled, cleaned and inspected. All bearings, races, bushings, seals, etc. are replaced with quality new parts. All hard parts such as carriers, gears, drums, hubs and shafts are inspected, recleaned and inspected again. If these parts do not meet specifications they are replaced with updated new parts or quality used parts that meet OEM specifications.



Application	Description	Part Number	Retail Price	Core
2510, 2520	Reman Topshaft	Syncro-Range	AME3020STS	\$ 1500.00 \$ 250.00
3010 Early w/ Countershaft # R26243	Reman Topshaft	Syncro-Range	AME3010STS	\$ 1500.00 \$ 500.00
3010 Late w/ Countershaft # R31588	Reman Topshaft	Syncro-Range	AML3010STS	\$ 1500.00 \$ 500.00
3020	Reman Topshaft	Syncro-Range	AM3020STS	\$ 1500.00 \$ 500.00

John Deere®—Tractor

Application	Description	Part Number	Retail Price	Core
4010 Early w/ Countershaft # R26581	Reman Topshaft	Syncro-Range AME4010STS	\$ 1500.00	\$ 500.00
4010 Late w/ Countershaft # R31533	Reman Topshaft	Syncro-Range AML4010STS	\$ 1500.00	\$ 500.00
4000, 4020	Reman Topshaft	Syncro-Range AM4020STS	\$ 1500.00	\$ 500.00
4000, 4020	Reman Topshaft w/ New Shaft	Syncro-Range AM4020STS-NS	\$ 1625.00	\$ 500.00
4030	Reman Topshaft	Syncro-Range AM4030STS	\$ 1500.00	\$ 500.00
4030	Reman Topshaft	Quad-Range™ AM4030QTS	\$ 1500.00	\$ 500.00
4040	Reman Topshaft	Syncro-Range AM4040STS	\$ 1500.00	\$ 500.00
4040	Reman Topshaft	Quad-Range™ AM4040QTS	\$ 1500.00	\$ 500.00
4050, 4055	Reman Topshaft	Quad-Range™ AM4050QTS	\$ 1525.00	\$ 500.00
4230 Early	Reman Topshaft	Syncro-Range AME4230STS	\$ 1500.00	\$ 500.00
4230 Late	Reman Topshaft	Syncro-Range AML4230STS	\$ 1500.00	\$ 500.00
4230 Early	Reman Topshaft	Quad-Range™ AME4230QTS	\$ 1500.00	\$ 500.00
4230 Late	Reman Topshaft	Quad-Range™ AML4230QTS	\$ 1500.00	\$ 500.00
4240	Reman Topshaft	Syncro-Range AM4240STS	\$ 1500.00	\$ 500.00
4240	Reman Topshaft	Quad-Range™ AM4240QTS	\$ 1500.00	\$ 500.00
4250, 4255	Reman Topshaft	Quad-Range™ AM4250QTS	\$ 1525.00	\$ 500.00
4320	Reman Topshaft	Syncro-Range AM4320STS	\$ 1500.00	\$ 500.00
4430 Early w/ Hi-Lo Clutch Drum # R31026	Reman Topshaft	Syncro-Range AME4430STS	\$ 1500.00	\$ 500.00
4430 Late w/ Hi-Lo Clutch Drum # R63072, R63073	Reman Topshaft	Syncro-Range AML4430STS	\$ 1500.00	\$ 500.00
4430 Early w/ Hi-Lo Clutch Drum # R31026	Reman Topshaft	Quad-Range™ AME4430QTS	\$ 1500.00	\$ 500.00
4430 Late w/ Hi-Lo Clutch Drum # R63072, R63073	Reman Topshaft	Quad-Range™ AML4430QTS	\$ 1500.00	\$ 500.00
4440	Reman Topshaft	Quad-Range™ AM4440QTS	\$ 1500.00	\$ 500.00
4450, 4455	Reman Topshaft	Quad-Range™ AM4450QTS	\$ 1525.00	\$ 500.00
4520	Reman Topshaft	Syncro-Range AM4520STS	\$ 3000.00	\$ 1000.00
4620	Reman Topshaft	Syncro-Range AM4620STS	\$ 3000.00	\$ 1000.00
4630	Reman Topshaft	Syncro-Range AM4630STS	\$ 2500.00	\$ 500.00
4630	Reman Topshaft	Quad-Range™ AM4630QTS	\$ 2500.00	\$ 500.00
4640	Reman Topshaft	Quad-Range™ AM4640QTS	\$ 2500.00	\$ 500.00
4650	Reman Topshaft	Quad-Range™ AM4650QTS	\$ 2500.00	\$ 500.00
7020 Early	Reman Topshaft	Syncro-Range AME7020STS	\$ 2500.00	\$ 500.00
7020 Late	Reman Topshaft	Syncro-Range AML7020STS	\$ 2500.00	\$ 500.00
7520	Reman Topshaft	Syncro-Range AM7520STS	\$ 2500.00	\$ 500.00
8430, 8630	Reman Topshaft	Quad-Range™ (4x6) AM8630QTS	\$ 2500.00	\$ 500.00
8440, 8640	Reman Topshaft	Quad-Range™ (4x6) AM8640QTS	\$ 2500.00	\$ 500.00
8450, 8650	Reman Topshaft	Quad-Range™ (4x6) AM8650QTS	\$ 2500.00	\$ 500.00
8850	Reman Topshaft	Quad-Range™ (4x6) AM8850QTS	\$ 2500.00	\$ 500.00



Topshaft Components

Application	Description	Part Number	Retail Price	Core
4000, 4020	Top Shaft	AMR33384	\$ 395.00	

John Deere®—Tractor

Application	Description		Part Number	Retail Price	Core
4000, 4020, 4230	Pinion	Low Range	AMR59641	\$ 120.00	
		High Range	AMR41218	\$ 225.00	
		Reverse Range	AMR65342	\$ 120.00	
2510, 2520, 3010, 3020, 4000, 4010, 4020, 4030, 4230	Shift Collar		AMR33383	\$ 85.00	
4000, 4020	Shift Collar		AMR33382	\$ 85.00	
4010	Shift Collar	1.50" ID	AMR26075	\$ 163.96	
2010, 2510, 2520, 3010, 3020, 4000, 4010, 4020	Drum		AMR52499	\$ 95.00	
2010, 2510, 2520, 3010, 3020, 4000, 4010, 4020, 4030, 4230, 4320, 4430	Drum		AMR31026	\$ 110.00	
2510, 2520, 3020, 4000 ASN 201000, 4020, 4030, 4040, 4040S, 4050, 4055, 4230, 4240, 4240S, 4250, 4255, 4320, 4350, 4430, 4440, 4450, 4455	Drum	Low Range	AMR63073	\$ 200.00	
		High Range	AMR63072	\$ 185.00	
2010, 2520, 3020, 4000, 4010, 4020, 4030, 4230, 4320, 4430, 7520	Topshaft Clutch Kit	3 Discs & 2 Plates	AMRE37119	\$ 44.00	
4520, 4620, 4630, 5010, 5020, 6030, 7520, 8430, 8630	Topshaft Clutch Kit	4 Discs & 3 Plates	AMRE37120	\$ 87.00	
4555, 4560, 4640, 4650, 4755, 4760, 8430, 8440, 8450, 8630, 8640, 8650, 8850	Topshaft Clutch Kit	10 Discs & 10 Plates	AMRE234257	\$ 325.16	
2010 ASN 42001, 2510, 2520, 3010, 3020, 4010, 4020, 4230, 4430	Synchronizer		AMR31028	\$ 115.00	
2510, 2520, 3020	Shift Collar		AMR33480	\$ 101.50	
2510, 2520, 3020, Ind: 500	Transmission Drive Shaft		AMR33512	\$ 602.39	

Quad-Range™ Packs and Components

Each unit is carefully disassembled, cleaned and inspected. All bearings, races, bushings, seals, etc. are replaced with quality new parts. All hard parts such as carriers, gears, drums, hubs and shafts are inspected, re-cleaned and inspected again. If these parts do not meet OEM specifications they are replaced with updated new parts or high-quality used parts.



Application	Description		Part Number	Retail Price	Core
2750, 2940, 2950	Reman Quad-Range™ Pack		AMAL40808	\$ 2100.00	\$ 500.00
4030 BSN 015081, 4230 BSN 034663, 4430 BSN 060941	Reman Quad-Range™ Pack		AMAR67978	\$ 2250.00	\$ 1000.00
4030 ASN 015082	Reman Quad-Range™ Pack		AMAR83262	\$ 2100.00	\$ 500.00
4040, 4050, 4055, 4230 ASN 039806, 4240, 4250, 4255, 4430 ASN 060942	Reman Quad-Range™ Pack		AMAR105732	\$ 2100.00	\$ 500.00
4440, 4450, 4455	Reman Quad-Range™ Pack		AMAR105733	\$ 2100.00	\$ 500.00
4555, 4650, 4755	Reman Quad-Range™ Pack		AMAR105791	\$ 3000.00	\$ 1000.00
4630 BSN 025360	Reman Quad-Range™ Pack		AMAR82382	\$ 2100.00	\$ 1000.00
4630 ASN 025361	Reman Quad-Range™ Pack		AMAR82381	\$ 2100.00	\$ 1000.00
4640	Reman Quad-Range™ Pack		AMAR83088	\$ 2600.00	\$ 1000.00
8430, 8440, 8550, 8630, 8640, 8650	Reman Quad-Range™ Pack		AMRE12772	\$ 2750.00	\$ 1000.00
8850	Reman Quad-Range™ Pack		AMRE12774	\$ 4000.00	\$ 1000.00
8560, 8570, 8760, 8770, 8870, 8960, 9100, 9120, 9200, 9220, 9230, 9300, 9300T, 9320, 9320T, 9330, 9400, 9400T, 9420, 9420T, 9430	Reman Hi-Lo Clutch		AMRE226188	\$ 3250.00	\$ 1000.00

John Deere®—Tractor



Front Power Shift Packs and Components

Each unit is carefully disassembled, cleaned and inspected. All bearings, races, bushings, seals, etc. are replaced with new parts. All hard parts such as carriers, gears, drums, hubs and shafts are inspected, re-cleaned and inspected again. If these parts do not meet specifications they are replaced with updated new parts or quality used parts that meet OEM specifications.

Application	Description	Part Number	Retail Price	Core
3020 Early	Reman Power Shift Pack, Front w/ PTO	AMAR53210	\$ 2500.00	\$ 500.00
3020 Late	Reman Power Shift Pack, Front w/ PTO	AMAR91600	\$ 2500.00	\$ 500.00
4000, 4020 Late	Reman Power Shift Pack, Front w/ PTO	AMAR53206	\$ 2750.00	\$ 500.00
4020 Early	Reman Power Shift Pack, Front w/ PTO	AMAR53205	\$ 2750.00	\$ 500.00
4040	Reman Power Shift Pack, Front	AMAR82503	\$ 2500.00	\$ 750.00
4050 BSN 008767, 4250 BSN 014989, 4450 BSN 029226	Reman Power Shift Pack, Front	AMAR103421	\$ 2000.00	\$ 350.00
4050 ASN 8768, 004055, 4250 ASN 014990, 4255, 4450 ASN 029227, 4455	Reman Power Shift Pack, Front	AMRE27193	\$ 2250.00	\$ 750.00
4230	Reman Power Shift Pack, Front	AMAR59237	\$ 2950.00	\$ 500.00
4240	Reman Power Shift Pack, Front	AMRE19052	\$ 2950.00	\$ 750.00
4430	Reman Power Shift Pack, Front	AMRE19053	\$ 2950.00	\$ 750.00
4440	Reman Power Shift Pack, Front	AMRE20138	\$ 2750.00	\$ 750.00
4520, 4620	Reman Power Shift Pack, Front w/ PTO	AMAR90515	\$ 3750.00	\$ 1000.00
4555, 4560, 4650 ASN 016911, 4755, 4760, 4850 ASN 013638, 4955, 4960	Reman Power Shift Pack, Front	AMRE27194	\$ 2500.00	\$ 750.00
4630	Reman Power Shift Pack, Front Replaces AR59511, RE228011	AMAR90517	\$ 3000.00	\$ 750.00
4640, 4840	Reman Power Shift Pack, Front	AMRE20139	\$ 3000.00	\$ 750.00
4650 BSN 016910, 4850 BSN 013638	Reman Power Shift Pack, Front	AMRE25701	\$ 2000.00	\$ 750.00
4030, 4040, 4240, 4430, 4440, 4520, 4555, 4560, 4620, 4630, 4640, 4650, 4755, 4760, 4840, 4850, 4955, 4960	Return Spring, Transmission Clutch Pack Replaces R43382	AMR70027	\$ 13.61	
4630, 4640, 4840	Front Clutch Housing Drum	AMR52471	\$ 713.35	
4555, 4560, 4650, 4755, 4760, 4850, 4955, 4960	High Range Clutch Hub	AMRE16825	\$ 195.00	

Rear Power Shift Packs and Components

Each unit is carefully disassembled, cleaned and inspected. All bearings, races, bushings, seals, etc. are replaced with quality new parts. All hard parts such as carriers, gears, drums, hubs and shafts are inspected, re-cleaned and inspected again. If these parts do not meet specifications they are replaced with updated new parts or quality used parts that meet OEM specifications.



Application	Description	Part Number	Retail Price	Core
3020 Early	Reman Power Shift Pack, Rear	AMAR53211	\$ 2250.00	\$ 500.00
3020 Late	Reman Power Shift Pack, Rear	AMAR89854	\$ 2500.00	\$ 750.00
4000, 4020 Late, 4230	Reman Power Shift Pack, Rear	AMAR89858	\$ 2500.00	\$ 750.00
4020 BSN 200999	Reman Power Shift Pack, Rear	AMAR95767	\$ 2500.00	\$ 500.00
4040 BSN 005685	Reman Power Shift Pack, Rear	AMAR73167	\$ 3000.00	\$ 750.00
4040 ASN 005686	Reman Power Shift Pack, Rear	AMRE17364	\$ 3000.00	\$ 750.00
4050, 4055, 4250, 4255	Reman Power Shift Pack, Rear	AMRE19050	\$ 4750.00	\$ 1000.00
4050 European, 4250 European, 4450, 4455	Reman Power Shift Pack, Rear	AMRE17687	\$ 6500.00	\$ 2500.00
4240	Reman Power Shift Pack, Rear	AMRE17363	\$ 3000.00	\$ 750.00
4430, 4440	Reman Power Shift Pack, Rear	AMAR89861	\$ 3000.00	\$ 750.00
4520, 4620, 4630	Reman Power Shift Pack, Rear	AMAR49426	\$ 4000.00	\$ 1000.00
4555, 4560, 4650, 4755, 4760, 4850, 4955, 4960	Reman Power Shift Pack, Rear Replaces AR100694, RE237934	AMRE20932	\$ 6500.00	\$ 2500.00
4640, 4840	Reman Power Shift Pack, Rear	AMAR89863	\$ 4500.00	\$ 750.00

John Deere®—Tractor

Application	Description	Part Number	Retail Price	Core
4030, 4040, 4240, 4430, 4440, 4520, 4555, 4560, 4620, 4630, 4640, 4650, 4755, 4760, 4840, 4850, 4955, 4960	Return Spring, Transmission Clutch Pack Replaces R43382	AMR70027	\$ 13.61	
4450, 4455	Output Planetary Clutch Drum Marked R78966, R81654 or R99488 Replaces RE14123, RE20118	AMRE38367	\$ 1620.00	
4555, 4560, 4650, 4755, 4760, 4850, 4955, 4960	Output Planetary Clutch Drum Replaces RE20933	AMRE50019	\$ 875.00	
4555, 4560, 4755, 4760, 4955, 4960	1st Planetary Ring Gear	AMR112073	\$ 285.00	
4555, 4560, 4650, 4755, 4760, 4850, 4955, 4960	2nd Planetary Ring Gear	AMR71753	\$ 350.00	
	3rd Planetary Ring Gear	AMR71754	\$ 385.00	
	Planetary Clutch Hub	AMRE40456	\$ 140.00	
	1st & 2nd Planetary Brake Housing	AMR72043	\$ 575.00	
	3rd & 4th Planetary Brake Housing	AMR72044	\$ 425.00	
	4555, 4560, 4755, 4760, 4850, 4955, 4960	Pinion Gear Marked R71579	AMAR94153	\$ 195.00
Pinion Gear		AMR71578	\$ 90.00	
Pinion Gear Marked R71577		AMAR94152	\$ 200.00	
Pinion Gear Marked R71573		AMRE51473	\$ 110.00	
Pinion Gear		AMR71581	\$ 55.00	
Pinion Gear		AMR71582	\$ 75.00	
Pinion Gear		AMR112072	\$ 110.00	
Spacer		AMR71757	\$ 6.00	
4555, 4560, 4650 ASN 007194, 4755, 4760, 4850 ASN 007615, 4955, 4960	Output Planetary Pinion Shaft	AMRE17692	\$ 43.00	
	Planetary Carrier, Bare	AMRE17691	\$ 950.00	
	Complete Outer Planetary Carrier Assembly	AMX58001	\$ 2800.00	
	Planetary Bushing	AMR71750	\$ 15.00	
	Planetary Bushing	AMT26321	\$ 5.75	
2510, 2520, 3010, 3020, 4010, 4020, 4040, 4050, 4055, 4240, 4250, 4255, 4320, 4440, 4450, 4455, 4555, 4560, 4650, 4755, 4760, 4850, 4955, 4960, 8560, 8570, 8760, 8770, 8870, 8960, 8970, 9100, 9120, 9200, 9220, 9230, 9300, 9300T, 9320T, 9330, (9360R, 9410R, 9460R SN 000101-014999), 9400T, 9420T, 9430	Clutch Pack Return Spring	AMR67840	\$ 9.13	

Transmissions

Transmission cores must be assembled. A \$300 pallet fee for PowerQuad™ Transmissions and a \$500 fee for Powershift Transmissions is required.

Application	Description	Part Number	Retail Price	Core
6110	Reman PowerQuad™ Transmission	Mechanical Reverse AMT6110M	\$ 9900.00	\$ 2000.00
6120, 6220, 6320, 6420	Reman PowerQuad™ Transmission Electrical Shift 3 Solenoid	Electrical Reverse Internal Input Splines AMPG203495	\$ 9900.00	\$ 2000.00
6110	Reman PowerQuad™ Transmission	Electrical Reverse AMT6110E	\$ 9900.00	\$ 2000.00
6200	Reman PowerQuad™ Transmission	Mechanical Reverse AMT6200M	\$ 9900.00	\$ 2000.00
		Electrical Reverse AMT6200E	\$ 9900.00	\$ 2000.00
6210	Reman PowerQuad™ Transmission	Mechanical Reverse AMT6210M	\$ 9900.00	\$ 2000.00
		Electrical Reverse AMT6210E	\$ 9900.00	\$ 2000.00

John Deere®—Tractor

Application	Description		Part Number	Retail Price	Core	
6300	Reman PowerQuad™ Transmission	Mechanical Reverse	AMT6300M	\$ 9900.00	\$ 2000.00	
		Electrical Reverse	AMT6300E	\$ 9900.00	\$ 2000.00	
6310	Reman PowerQuad™ Transmission	Mechanical Reverse	AMT6310M	\$ 9900.00	\$ 2000.00	
		Electrical Reverse	AMT6310E	\$ 9900.00	\$ 2000.00	
6320	Reman PowerQuad™ Transmission	Mechanical Reverse	AMT6320M	\$ 9900.00	\$ 2000.00	
		Electrical Reverse	AMT6320E	\$ 9900.00	\$ 2000.00	
	Reman PowerQuad™ Transmission Mechanical Shift	Mechanical Reverse External Input Splines	AMPG203502	\$ 9900.00	\$ 2000.00	
		Mechanical Reverse Internal Input Splines	AMPG203497	\$ 9900.00	\$ 2000.00	
	Reman PowerQuad™ Transmission Electrical Shift 2 Solenoid	Electrical Reverse External Input Splines	AMPG204154	\$ 9900.00	\$ 2000.00	
		Electrical Reverse Internal Input Splines	AMPG203496	\$ 9900.00	\$ 2000.00	
6400	Reman PowerQuad™ Transmission	Mechanical Reverse	AMT6400M	\$ 9900.00	\$ 2000.00	
		Electrical Reverse	AMT6400E	\$ 9900.00	\$ 2000.00	
6410	Reman PowerQuad™ Transmission	Mechanical Reverse	AMT6410M	\$ 9900.00	\$ 2000.00	
		Electrical Reverse	AMT6410E	\$ 9900.00	\$ 2000.00	
6420	Reman PowerQuad™ Transmission	Mechanical Reverse	AMT6420M	\$ 9900.00	\$ 2000.00	
		Electrical Reverse	AMT6420E	\$ 9900.00	\$ 2000.00	
	Reman PowerQuad™ Transmission Mechanical Shift	Mechanical Reverse External Input Splines	AMPG203503	\$ 9900.00	\$ 2000.00	
		Reman PowerQuad™ Transmission Electrical Shift 2 Solenoid	Electrical Reverse External Input Splines	AMPG204155	\$ 9900.00	\$ 2000.00
	6420, 7720		Reman PowerQuad™ Transmission Mechanical Shift	Mechanical Reverse Internal Input Splines	AMPG200906	\$ 9900.00
		Electrical Reverse Internal Input Splines		AMPG200904	\$ 9900.00	\$ 2000.00
Reman PowerQuad™ Transmission Electrical Shift 3 Solenoid		Electrical Reverse Internal Input Splines	AMPG200905	\$ 9900.00	\$ 2000.00	
6500	Reman PowerQuad™ Transmission	Mechanical Reverse	AMT6500M	\$ 9900.00	\$ 2000.00	
		Electrical Reverse	AMT6500E	\$ 9900.00	\$ 2000.00	
7200	Reman PowerQuad™ Transmission Small Frame	Mechanical Reverse	AMT7200M	\$ 9900.00	\$ 2000.00	
		Electrical Reverse	AMT7200E	\$ 9900.00	\$ 2000.00	
7210	Reman PowerQuad™ Transmission Small Frame	Mechanical Reverse	AMT7210M	\$ 9900.00	\$ 2000.00	
		Electrical Reverse	AMT7210E	\$ 9900.00	\$ 2000.00	

John Deere®—Tractor

Application	Description		Part Number	Retail Price	Core
7220, 7320	Reman PowerQuad™ Transmission	External Input Splines	AMPG200779	\$ 9900.00	\$ 2000.00
	Mechanical Control	Internal Input Splines	AMPG200907	\$ 9900.00	\$ 2000.00
	4 Clutch Discs				
	Reman PowerQuad™ Transmission	External Input Splines	AMPG200901	\$ 9900.00	\$ 2000.00
	Late Design				
	Electrical Control				
	4 Clutch Discs				
	2 Solenoid				
	Cast # - AR217578				
	Reman PowerQuad™ Transmission	Internal Input Splines	AMPG200902	\$ 9900.00	\$ 2000.00
	Electrical Control				
	4 Clutch Discs				
	2 Solenoid				
	Reman PowerQuad™ Transmission	Internal Input Splines	AMPG200903	\$ 9900.00	\$ 2000.00
	Electrical Control				
	4 Clutch Discs				
	3 Solenoid				
	Cast # - AR198873				
7400	Reman PowerQuad™ Transmission	Mechanical Reverse	AMT7400M	\$ 9900.00	\$ 2000.00
	Small Frame	Electrical Reverse	AMT7400E	\$ 9900.00	\$ 2000.00
7410	Reman PowerQuad™ Transmission	Mechanical Reverse	AMT7410M	\$ 9900.00	\$ 2000.00
	Small Frame	Electrical Reverse	AMT7410E	\$ 9900.00	\$ 2000.00
7420	Reman PowerQuad™ Transmission	External Input Splines	AMPG202153	\$ 9900.00	\$ 2000.00
	Early Design				
	Electrical Shift				
	2 Solenoid				
	Cast # - AR217577				
	Reman PowerQuad™ Transmission	External Input Splines	AMPG202156	\$ 9900.00	\$ 2000.00
	Late Design				
	Mechanical Shift				
	Reman PowerQuad™ Transmission	Internal Input Splines	AMPG202157	\$ 9900.00	\$ 2000.00
	Early Design				
	Mechanical Shift				
	Reman PowerQuad™ Transmission	Internal Input Splines	AMPG202154	\$ 9900.00	\$ 2000.00
	Late Design				
	Electrical Shift				
	2 Solenoid				
	Cast # - AR217577				
	Reman PowerQuad™ Transmission	Internal Input Splines	AMPG202155	\$ 9900.00	\$ 2000.00
	Electrical Shift				
	3 Solenoid				
	Cast # - AR198872				
7500	Reman PowerQuad™ Transmission	Mechanical Reverse	AMT7500M	\$ 9900.00	\$ 2000.00
	Small Frame	Electrical Reverse	AMT7500E	\$ 9900.00	\$ 2000.00
7510	Reman PowerQuad™ Transmission	Mechanical Reverse	AMT7510M	\$ 9900.00	\$ 2000.00
	Small Frame	Electrical Reverse	AMT7510E	\$ 9900.00	\$ 2000.00
7520	Reman PowerQuad™ Transmission		AMPG200729	\$ 9900.00	\$ 2000.00
	Mechanical Shift				
	Cast # - RE281108				
	Reman PowerQuad™ Transmission		AMPG200908	\$ 9900.00	\$ 2000.00
	Electrical Shift				
	2 Solenoid				
	Cast # - AR217576				
	Reman PowerQuad™ Transmission		AMPG202152	\$ 9900.00	\$ 2000.00
	Electrical Shift				
	3 Solenoid				
	Cast # - AR198871				

John Deere®—Tractor

Application	Description		Part Number	Retail Price	Core
7600	Reman PowerQuad™ Transmission Large Frame	Mechanical Reverse	AMT7600M	\$ 9900.00	\$ 2000.00
		Electrical Reverse	AMT7600E	\$ 9900.00	\$ 2000.00
7610	Reman PowerQuad™ Transmission Large Frame	Mechanical Reverse	AMT7610M	\$ 9900.00	\$ 2000.00
		Electrical Reverse	AMT7610E	\$ 9900.00	\$ 2000.00
7700	Reman PowerQuad™ Transmission Large Frame	Mechanical Reverse	AMT7700M	\$ 9900.00	\$ 2000.00
		Electrical Reverse	AMT7700E	\$ 9900.00	\$ 2000.00
7710	Reman PowerQuad™ Transmission Large Frame	Mechanical Reverse	AMT7710M	\$ 9900.00	\$ 2000.00
		Electrical Reverse	AMT7710E	\$ 9900.00	\$ 2000.00
7720, 7820, 7920	Reman PowerQuad™ Transmission 2 Solenoid Cast # - AR223047		AMPG200899	\$ 9900.00	\$ 2000.00
	Reman PowerQuad™ Transmission 3 Solenoid Cast # - AR185370		AMPG200900	\$ 9900.00	\$ 2000.00
7800	Reman PowerQuad™ Transmission Large Frame	Mechanical Reverse	AMT7800M	\$ 9900.00	\$ 2000.00
		Electrical Reverse	AMT7800E	\$ 9900.00	\$ 2000.00
7810	Reman PowerQuad™ Transmission Large Frame	Mechanical Reverse	AMT7810M	\$ 9900.00	\$ 2000.00
		Electrical Reverse	AMT7810E	\$ 9900.00	\$ 2000.00
(7600, 7700, 7800 Transmission BSN 010422)	Reman Powershift Transmission		AMT7800PS	\$ 16250.00	\$ 5000.00
(7600, 7700, 7800 Transmission ASN 010423)	Reman Powershift Transmission		AMT7800PS-L	\$ 16250.00	\$ 5000.00
(7610, 7710, 7810 Transmission BSN 020452)	Reman Powershift Transmission		AMT7810PS	\$ 16250.00	\$ 5000.00
(7610, 7710, 7810 Transmission ASN 020453)	Reman Powershift Transmission		AMT7810PS-L	\$ 16250.00	\$ 5000.00
(8100, 8200, 8300, 8400 ASN 020000)	Reman Powershift Transmission	w/ MFWD	AMRE162649	\$ 15500.00	\$ 5000.00
		w/o MFWD	AMRE162650	\$ 15500.00	\$ 5000.00
(8100, 8200, 8300, 8400 BSN 19999)	Reman Powershift Transmission	w/ MFWD	AMRE151986	\$ 15500.00	\$ 5000.00
		w/o MFWD	AMRE153022	\$ 15500.00	\$ 5000.00
8100T, 8200T, 8300T, 8400T	Reman Powershift Transmission	Track	AMRE162651	\$ 15500.00	\$ 5000.00
8110, 8210, 8310, 8410	Reman Powershift Transmission	w/ MFWD	AMRE198811	\$ 15500.00	\$ 5000.00
		w/o MFWD	AMRE198812	\$ 15500.00	\$ 5000.00
8110T, 8210T, 8310T, 8410T	Reman Powershift Transmission	Track	AMRE198813	\$ 15500.00	\$ 5000.00
8120, 8220, 8320, 8420, 8520	Reman Powershift Transmission	w/ MFWD w/o ILS™ Front Axle	AMRE257325	\$ 15500.00	\$ 5000.00
8120T, 8220T, 8320T, 8420T, 8520T	Reman Powershift Transmission		AMRE257328	\$ 15500.00	\$ 5000.00
6105R, 6115R, 6125R	Reman Transmission, IVT™		AMPG202092	\$ 21900.00	\$ 5000.00
6140R, 6150R	Reman Transmission, IVT™		AMPG202094	\$ 21900.00	\$ 5000.00
6170R, 6190R	Reman Transmission, IVT™		AMPG202095	\$ 21900.00	\$ 5000.00
6210R	Reman Transmission, IVT™		AMPG202096	\$ 21900.00	\$ 5000.00
6215R	Reman Transmission, IVT™		AMPG202097	\$ 21900.00	\$ 5000.00
6230, 6330, 6430	Reman Transmission, IVT™		AMAL174816	\$ 21900.00	\$ 5000.00
6320, 6420 SN 322932-364388	Reman Transmission, IVT™		AMAL172806	\$ 21900.00	\$ 5000.00
6320, 6420 SN 364444-402455	Reman Transmission, IVT™		AMAL172809	\$ 21900.00	\$ 5000.00
6320, 6420 ASN 402501	Reman Transmission, IVT™		AMAL172812	\$ 21900.00	\$ 5000.00
6520, 6620 SN 012451-019020, 7220	Reman Transmission, IVT™		AMAL172810	\$ 21900.00	\$ 5000.00
6520, 6620 BSN 001746, 7320	Reman Transmission, IVT™		AMAL172807	\$ 21900.00	\$ 5000.00

John Deere®—Tractor

Application	Description	Part Number	Retail Price	Core
6820, 6920, 7220 ASN 019021, 7320 ASN 018798	Reman Transmission, IVT™	AMAL172813	\$ 21900.00	\$ 5000.00
6820, 6920, 7420 BSN 001838, 7520 BSN 001793	Reman Transmission, IVT™	AMAL172808	\$ 21900.00	\$ 5000.00
6820, 6920, 7420 SN 001839- 004240, 7520 SN 001794-004213	Reman Transmission, IVT™	AMAL172811	\$ 21900.00	\$ 5000.00
6820, 6920, 7420 ASN 004241, 7520 ASN 004214	Reman Transmission, IVT™	AMAL172814	\$ 21900.00	\$ 5000.00
6820, 6930, 7330	Reman Transmission, IVT™	AMAL174819	\$ 21900.00	\$ 5000.00
7130, 7230	Reman Transmission, IVT™	AMAL174818	\$ 21900.00	\$ 5000.00
7430, 7530	Reman Transmission, IVT™	AMAL174820	\$ 21900.00	\$ 5000.00

Transmission Components

Application	Description	Part Number	Retail Price	Core
(920, 2440 - w/ Collar Shift Transmission), (2040, 2240 ASN 349999 - w/ Collar Shift Transmission), 2030, 2630, 2640, Ind: 300 w/o Independent PTO, 300B, 301, 301A, 302, 302A, 400, 401, 401B, 401C, 401D, Utility: 820, 830	3rd and 7th Gear on Differential Driveshaft 31 & 20 Tooth, 1.375" ID, 4.75" OD Marked T31080 Replaces T21978	AMAT30053	\$ 232.45	
1020, 1520, 1530, 2020, 2030, 2040*, 2150*, (2355*, 2555* BSN 756484), 2255*, 2350*, 2440, 2550*, Ind: 300B, 301, 301A, 302, 302A, 400, 401, 401B, 401D, Utility: 820*, 830, 2155*, 2240 BSN 349999 and ASN 350000* *w/ Collar Shift Transmission	4th & 8th Gear, Differential Drive Shaft 20 & 27 Tooth, 1.875" ID, 4.075" OD	AMT21977	\$ 178.80	
2130, 2630, 2640	4th and 8th Gear on Differential Driveshaft 27 & 20 Tooth	AML28665	\$ 151.37	
2440 w/ Hi-Lo SN 340999-378264, 2630, 2640	Transmission Countershaft Pinion Gear 12 & 13 Tooth, 16" ID, 4" Long Replaces L28660, R65574	AMR67340	\$ 250.23	
1020, 1520, 1530, (1640 ASN 429999, 2040, 2150, 2255, 2350 BSN 756484, 2355N BSN 756484 w/ Continuous PTO w/ Reverser, 2550 - w/ Collar Shift Transmission), 2020, 2030, 2130, 2440, 2555 BSN 756483 w/ Continuous PTO w/ Reverser, Utility: 2155 BSN 756484, 2240	Countershaft Pinion Gear, Low Range 20 & 22 Tooth, 1.90" ID, 3.425" OD Replaces T21978	AMT30065	\$ 157.80	
(2040S*, 2140* ASN 429999), 2130, 2355* ASN 756483, 2355N, 2555, 2630, 2640, 2750*, 2755*, Utility: 2155 ASN 756486	Pinion Gear, Differential Driveshaft 36 & 20 Tooth	AML28664	\$ 150.40	
1520, 1530, 2020, 2030 - w/ 540 PTO, Ind: 300, 301, 400, 401	Power Shaft Gear 73 Tooth, 6.50" ID, 10.50" OD	AMT30755	\$ 399.11	
5200, 5210, 5300, 5310, 5400, 5410, 5415, 5425N, 5500 BSN 550009, 5510, 5605 BSN 060183, 5615, 5705 BSN 060436, 5715, 5725N	Gear, Differential Drive Shaft 43 Tooth, 20 Spline Replaces R113839, R134393	AMR134998	\$ 345.00	
1530, 2150*, 2255*, 2350*, 2355* BSN 756484 for Reverser Only, 2550*, 2555* BSN 756484 w/ Continuous PTO w/ Reverser, 2355N* BSN 756484, Utility: 2155* BSN 756484 *w/ Collar Shift Transmission	Transmission Countershaft Pinion Gear 16, 12 & 12 Tooth, 4.02" Long Replaces R67341	AMT24728	\$ 286.29	
6100, 6110, 6110L, (6120, 6120L, 6215, 6220, 6220L, 6320, 6320L, 6415, 6420, 6420L, 6520L, 6615, 6715 BSN 517598), 6140J, 6155J, 6200, 6200L, 6210, 6210L, 6300, 6300L, 6310, 6310S, 6400, 6400L, 6410, 6410S, 6500, 6500L, 6510L, 6510S, 7500, 7505 BSN 456513	Planetary Pinion Replaces R101174, R227060	AMR150457	\$ 395.00	

John Deere®—Tractor

Application	Description	Part Number	Retail Price	Core
6110, 6110L, 6120, 6120L, 6140J, 6155J, 6200, 6200L, 6210, 6210L, 6215, 6220, 6220L, 6300, 6300L, 6310, 6310L, 6310S, 6320, 6320L, 6400, 6400L, 6410, 6410L, 6410S, 6415, 6420, 6420L, 6500, 6500L, 6510L, 6510S, 6520L, 6615, 6715, (7200, 7210, 7220, 7320, 7400, 7410, 7420, 7510, 7520, 7600, 7610, 7700, 7710, 7720, 7800, 7810, 7820 BSN 375196), 7405, 7500, 7505	Sun Gear, PowerQuad™	AMRE41265	\$ 260.00	
6105M, 6105R, 6115M, 6115R, 6120, 6120L, 6125M, 6125R, 6140M, 6140R, 6150M, 6150R, 6170M, 6170R, 6190R, 6215, 6220, 6220L, 6230, 6320, 6320L, 6330, 6415, 6420, 6420L, 6430, 6520L, 6615, 6715, 7130, 7200, 7200R, 7210, 7210R, 7215R, 7220, 7230, 7230R, 7320, 7330, 7400, 7410, 7420, 7510, 7520, 7530, 7600, 7610, 7630, 7700, 7710, 7720, 7730, 7800, 7810, 7820, 7830, 7920, 7930, Premium Models: 6230, 6330, 6430, 6530, 6630, 6830, 6930, 7130, 7230, 7330, 7430, 7530	Gear, PowerQuad™ 4.312" Diameter	AMR227060	\$ 410.00	
	Gear, PowerQuad™ 120 Tooth, 54 Spline, 11.80" Diameter	AMR245934	\$ 705.00	
	Pinion Carrier, PowerQuad™ 30 Spline, 4" Wide, 8.425" Diameter	AMR228266	\$ 555.00	
4640 ASN 007637, 4840 ASN 004387	1st Planetary Brake Gear Replaces R43033	AMR68707	\$ 578.49	
4640, 4840 - w/ Powershift Transmission	3rd Planetary Brake Gear	AMR59135	\$ 517.52	
2140, 2350, 2355, 2355N, 2550, 2555, 2750, 2755, 2950, 2955, 3040, 3055, 3140, 3150, 3155, 3255, Utility: 2155	Relief Valve	AMAL31925	\$ 185.00	
2140 w/ Collar Shift Transmission, 2150, 2355N, 2255, 2350, 2355, 2550, 2555, 2750, 2755, 2855N, 2950, 2955, Utility: 2155 BSN 731150	Transmission Oil Pump Use w/ Sintered Inner Rotor Replaces AL28923, AL39355, AL41639, AL64139, AL69761	AMAL120106	\$ 444.00	
2355, 2450, 2555, 2650, 2755, 2850, 2955, 3055, 3150, 3155, 3255, 3350	Transmission Oil Pump	AMAL68091	\$ 392.00	
2355, 2555, 2755, 2855N, 2955, 3150, 3155	Transmission Oil Pump Replaces AL57680, AL69762	AMAL120107	\$ 416.00	
2355, 2355N, 2555, 2755, 2955, Utility: 2155	Transmission Oil Pump	AMAL68094	\$ 469.00	
(4000, 4020 ASN 201000), Ind: 600	Transmission Oil Pump Housing Includes Cover Plate and Gear Set	AMAR41949	\$ 255.57	
4040, 4040S, 4050, 4055, 4240, 4240S, 4250, 4255, 4350, 4440, 4450, 4455	Transmission Oil Pump Housing Replaces RE20918	AMAR93313	\$ 711.69	
	Transmission Oil Pump Assembly	AMRE20918	\$ 275.00	
820, 830, 920, 930, 1020, 1030, 1120, 1130, 1350, 1520, 1530, 1630, 1830, 2020, 2030, 2130, 2150, 2155, 2240 BSN 349999, 2255, 2350, 2355, 2355N, 2440, 2550, 2555, 2630, 2640, Ind: 300, 300B, 301, 302, 302A, 400, 401, 401B, 401C, 401D	Transmission Pump Adapter Replaces AR39093	AMAR69659	\$ 220.00	
6105M, 6105R, 6110, 6110L, 6110M, 6110R, 6115M, 6115R, 6120, 6120L, 6120M, 6120R, 6125M, 6200, 6200L, 6210, 6210L, 6215, 6220, 6220L, 6230, 6300, 6300L, 6310, 6310L, 6310S, 6320, 6320L, 6330, 6400, 6400L, 6405, 6410, 6410L, 6410S, 6415, 6420, 6420L, 6430, 6500, 6500L, 6510S, 6520L, 6605, 6615, 7130, 7200, 7200R, (7210, 7405, 7410, 7500 BSN 145909), 7210R, 7215R, 7220 BSN 012450, 7230, 7230R, 7400, Premium Models: 6230, 6330, 6430	Drive Gear, Transmission Oil Pump 12 mm Wide	AMR108927	\$ 48.38	
6105M, 6105R, 6110, 6110M, 6110R, 6115M, 6115R, 6120, 6120M, 6120R, 6125M, 6200, 6200L, 6210, 6210L, 6215, 6220, 6230, 6300, 6300L, 6310, 6310L, 6310S, 6320, 6320L, 6330, 6400, 6405, 6410, 6410L, 6410S, 6415, 6420, 6420L, 6430, 6500, 6500L, 6510L, 6510S, 6520L, 6605, 6615, 6715, 7130, 7200, 7200R, 7210, 7210R, 7215R, 7220 BSN 012450, 7230, 7230R, 7400, 7405, 7410, 7500, 7510, 7600, 7610, 7800, 7810, Premium Models: 6230, 6330, 6430	Drive Gear, Transmission Oil Pump 12 mm Wide Replaces RE163759	AMR108925	\$ 41.48	
6800, 6810, 6900, 6910, 7200, (7210, 7410 - w/ Transmission BSN 150027), (7220, 7320 SN 012451-049425), 7400, 7405, 7420 BSN 049425, 7500 - All w/ PowerQuad™ Transmission	Charge Pump Shaft Marked R115492, R161737 or R250401 Replaces RE52284	AMRE162140	\$ 398.45	







John Deere®—Tractor

Application	Description	Part Number	Retail Price	Core
6110M, 6120M, 6130M, 6140J, 6140R, 6145M, 6145R, 6150R, 6150RH, 6155J, (6155M, 6175M - w/ CommandQuad™ Transmission), 6155R, 6155RH, 6170R, 6175R, 6190R, 6195M, 6195R, 6210R, 6215R, 7200R, 7215R, 7230R, 7330, 7420, 7520, 7600, 7610, 7630, 7700, 7710, 7720, 7730, 7800, 7810, 7820, 7830, 7930	Gear Ring, Transmission Oil Pump 19.50 mm Wide	AMR108928	\$ 60.03	
(6110M, 6120M, 6130M, 6140M, 6145M, 6155M, 6175M - w/ CommandQuad™ Transmission), 6140J, 6140R, 6145R, 6150R, 6150RH, 6155J, 6155R, 6155RH, 6170R, 6175R, 6190R, 6195M, 6195R, 6210R, 6215R, 7200R, 7215R, 7230R, 7330, 7420, 7505, 7520 2003-07, 7600, 7610, 7630, 7700, 7710, 7720, 7730, 7800, 7810, 7820, 7830, 7930	Drive Gear, Transmission Oil Pump 19.50 mm Wide	AMR108926	\$ 51.65	
6110, 6110L, 6200, 6200L, 6210, 6210L, 6300, 6300L, 6310, 6310L, 6310S, 6400, 6400L, 6410, 6410L, 6410S, 6500, 6500L, 6510L, 6510S, 7210, 7405, 7410, 7500, 7510, 7610 BSN 089999, 7710, 7810	Clutch Manifold	AMRE155061	\$ 860.00	
2840, 3020 ASN 123000, 4000, 4020 ASN 201000, 4030, 4040, 4050, 4055, 4230, 4240, 4250, 4255, 4320 w/ Syncro-Range Transmission, 4430, 4440, 4450, 4455	PTO Drive Gear	AMR42014	\$ 277.00	
4010, 4020, lnd: 600	Support, Release Bearing Sleeve Replaces R26664	AMAR26485	\$ 157.00	
4030, 4040, 4230, 4240, 4430, 4440, (4050, 4055, 4250, 4255, 4450, 4455 - w/ Quad-Range™ Transmission)	PTO Clutch Hub 35 Internal Spline, 48 External Spline Replaces R50123	AMR56854	\$ 272.47	
4030, 4230, 4430, (4040, 4240, 4440 - w/ Quad-Range™ or Syncro-Range Transmission), (4050, 4055, 4250, 4255, 4450, 4455 - w/ Quad-Range™ Transmission)	PTO Clutch Hub 19 Internal Spline, 48 External Spline	AMR50346	\$ 258.39	
2030, (2150, 2255, 2350, 2355 BSN 756484, 2550 - w/ Collar Shift Transmission), 2240 BSN 350000, 2440 BSN 341000, (2355N, 2555 BSN 756484 - w/ Collar Shift Transmission w/ Continuous PTO w/ Reverser), Utility: 2040 BSN 350000 or ASN 349999 w/ Collar Shift Transmission, 2155 BSN 756484, 2240	Transmission Drive Shaft	AMT21980	\$ 572.10	
2440, 2630, 2640, 2750 - w/ Collar Shift Transmission	Countershaft 11.69" Long	AML28671	\$ 500.37	
2140, 2150, 2255, 2350, 2550, 2750, 2950, 3040, 3055, 3140, 3150, 3155, 3255	Main Shaft Drive	AMAL66410	\$ 725.00	
(5076E, 5082E, 5090E - w/o PowrReverser™), 5200 ASN 522128, 5210, 5220, 5300 ASN 532865, 5310, 5320, 5400 ASN 543669, 5410, 5420, 5500 ASN 561889, 5510, 5520	Transmission Drive Shaft Replaces R133074	AMR136338	\$ 195.84	
7200R, 7210R, 7215R, 7230R, 8245R, 8270R, 8295R, 8320R, 8335R, 8345R, 8370R, 8400R, 9100, 9120, 9200, 9220, 9230, 9300, 9300T, 9320, 9320T, 9330, 9400, 9400T, 9420, 9420T, 9430, 9430T, 9520, 9520T, 9530, 9530T, 9620, 9620T, 9630, 9630T	Universal Joint	AMRE307561	\$ 100.00	
(4040, 4230 ASN 016358, 4240, 4430 ASN 022372, 4440, 4630 ASN 009454, 4640, 4840 - w/ Powershift Transmission)	Torsional Damper Plate 3 Outside Tangs, 9.63" ID, 0.375" Thick Replaces R56720	AMR76731	\$ 83.50	
4040, 4230, 4240, 4430, 4440, 4640, 4840	Control Cable 52" Long	AMAR55702	\$ 124.13	
4630, 4640, 4840	Transmission Control Valve Cable	AMAR54618	\$ 102.23	
6110, (6200, 6300, 6400 ASN 117749), 6200L, 6210, 6300L, 6310, 6310S, 6400L, 6410, 6410S, 6500L, 6510S - w/ PowerQuad™ Transmission	Clutch Operating Cable 40.5469" Long Replaces AL112642	AMAL117196	\$ 79.62	
6100J, 6105J, 6105M, 6110E, 6110J, 6110M, 6115J, 6115M, 6120, 6120M, 6125E, 6125J, 6125M, 6130, 6130J, 6130M, 6135J, 6135M, 6140J, 6140M, 6145M, 6155J, 6155M, 6165J, 6180J, 6215, 6220, 6225, 6230, 6320, 6320L, 6325, 6330, 6415, 6420, 6420L, 6425, 6430, 6515, 6520, 6520L, 6525, 6530, 6534, 6615, 6620, 6630, 6715, 7130, 7220, 7230, 7320, 7330, 7420, 7425, 7505, 7515, 7520 2003-07, 7525	Clutch Operating Cable 0.236" Threaded Ends 44.488" Long (2.165" Travel)	AMAL151612	\$ 62.10	



John Deere®—Tractor

Application	Description	Part Number	Retail Price	Core
4040, 4050, 4055, 4230 ASN 034663, 4240, 4250, 4255, 4430 ASN 060635, 4440, 4450, 4455 - w/ Quad-Range™ or Syncro-Range Transmission	Shifter Cam Support	AMR61985	\$ 154.04	
8100, 8100T, 8110, 8110T, 8120, 8120T, 8200, 8200T, 8210, 8210T, 8220, 8220T, 8225R, 8230, 8230T, 8235R, 8245R, 8260R, 8270R, 8285R, 8295R, 8295RT, 8300, 8300T, 8310, 8310R, 8310RT, 8310T, 8320, 8320R BSN 907101, 8320T, 8330, 8330T, 8335R, 8335R, 8360R, 8360RT, 8400, 8400T, 8410, 8410T, 8420, 8420T, 8430, 8430T, 8520, 8520T, 8R 230, 8R 250, 8R 280, 8R 310, 8R 340	Bearing Set, Horizontal Unloading Auger Gearbox	AMAH94661	\$ 39.00	



Transmission Discs

Description	Part Number	Retail Price	Core
 Transmission Disc, 6.608" ID, 7.56" OD	AMAL38238	\$ 25.00	
 Transmission Disc, 19 Internal Splines, 4.324" OD	AMAL55075	\$ 19.00	
 Transmission Disc, 42 Internal Splines, 7.76" OD	AMRE28023	\$ 44.00	
Transmission Disc, 42 Internal Splines, 7.76" OD Replaces AR94517, RE234261	AMRE23286	\$ 22.00	
Transmission Disc, 45 Internal Splines, 5.25" OD	AMAL69560	\$ 7.00	
Transmission Disc, 45 Internal Splines, 5.25" OD Replaces RE227812, RE228008	AMAR39128	\$ 12.00	
Transmission Disc, 45 Internal Splines, 5.256" OD	AMRE29816	\$ 10.00	
Transmission Disc, 45 Internal Splines, 5.52" OD	AMAL69559	\$ 12.00	
Transmission Disc, 54 Internal Splines, 6.75" OD	AMRE326609	\$ 19.00	
 Transmission Disc, 48 Internal Splines, 11.01" OD, 6.17" ID	AMAR94519	\$ 50.00	
Transmission Disc, 48 Internal Splines, 11.037" OD, 7.01" ID	AMAR95827	\$ 54.00	
Transmission Disc, 48 Internal Splines, 12.00" OD	AMRE17420	\$ 54.00	
Transmission Disc, 54 Internal Splines, 7.005" OD	AMRE27995	\$ 25.00	
Transmission Disc, 60 Tooth, 5.51" ID, 8.85" OD Replaces RE35512	AMRE321692	\$ 58.52	
Transmission Disc	AMRE294016	\$ 37.00	
 Transmission Disc, 95 Internal Splines, 11.625" OD, 9.452" ID	AMRE17162	\$ 35.00	
Transmission Disc, 55 Internal Splines, 4.327" OD	AMRE36170	\$ 14.00	
Transmission Disc, 105 Tooth	AMRE62897	\$ 35.00	
Transmission Disc	AMRE238864	\$ 36.00	
 Transmission Disc, 7.77" OD, 6.75" ID	AMRE29815	\$ 24.00	
Transmission Disc, 9.53" OD, 8.43" ID	AMRE33706	\$ 42.00	
Transmission Disc	AMRE294020	\$ 29.00	











John Deere®—Tractor

Description	Part Number	Retail Price	Core
	Transmission Disc, 45 Internal Splines, 5.25" OD	AMAR108105	\$ 12.00
	Transmission Disc, 45 Internal Splines, 4.25" OD	AMRE37011	\$ 6.00
	Transmission Disc, 20 Tooth, 5.25" OD, 2.25" ID	AML78682	\$ 21.00
	Transmission Disc, 14.50" OD, 10.50" ID	AMR135537	\$ 36.00
	Transmission Disc, 8.875" OD, 6.625" ID	AMR96830	\$ 16.00
	Transmission Disc, 87 Tooth, 11.50" OD, 8.75" ID	AMRE151059	\$ 37.00
	Transmission Disc	AMRE155958	\$ 28.00
	Transmission Disc, 87 Tooth, 11.50" OD, 8.75" ID	AMRE34784	\$ 32.00
	Transmission Disc, 54 Tooth, 11.25" OD, 4.62" ID Replaces RE273492	AMRE34786	\$ 43.00
	Transmission Disc, 60 Tooth, 8.385" OD, 5.51" ID	AMRE35512	\$ 29.00
	Transmission Disc, 110 Tooth - External, 9.23" OD, 7.38" ID	AMRE35517	\$ 27.00
	Transmission Disc, 95 Tooth, 11.618" Diameter Replaces RE321696	AMRE48092	\$ 31.00
	Transmission Disc, 47 Tooth, 9.00" OD, 5.875" ID	AMRE53823	\$ 35.00
	Transmission Disc, 39 Tooth, 7.00" OD, 2.57" ID	AMRE62896	\$ 31.00
	Transmission Disc, 39 Tooth, 7.00" OD, 2.545" ID	AMRE65324	\$ 37.00
	Transmission Disc, 0.115" Thick, 9.094" OD	AMRE67457	\$ 36.00
	Transmission Disc	AMRE67458	\$ 26.00
	Transmission Clutch Disc	AMRE63332	\$ 41.00
		Clutch Plate	AMR216291
Planetary Brake Clutch Plate 9.36" ID, 11.865" OD, 0.195" Thick, 13.133" Tang OD Replaces R101160, R209938		AMR337522	\$ 48.64

Transmission Separator Plates



Description	Part Number	Retail Price	Core
	Transmission Separator Plate, 5.20" OD, 3.903" ID	AML33563	\$ 22.00
	Transmission Separator Plate, 5.20" OD, 3.903" ID	AML64752	\$ 12.00
	Transmission Separator Plate, 4.334" OD, 3.388" ID	AML33125	\$ 9.00
	Transmission Separator Plate, 7.55" OD, 6.625" ID	AML33163	\$ 15.00

John Deere®—Tractor

	Description	Part Number	Retail Price	Core
	Transmission Separator Plate, 5.26" OD, 3.91" ID	AMR39259	\$ 6.00	
	Transmission Separator Plate, 7.032" OD, 4.752" ID	AMR46391	\$ 20.00	
	Transmission Separator Plate, 7.77" OD, 5.435" ID Replaces R819252	AMR46418	\$ 18.00	
	Transmission Separator Plate, 7.775" OD, 5.43" ID	AMR46419	\$ 18.00	
	Transmission Separator Plate, 7.02" OD, 4.758" ID	AMR56547	\$ 25.00	
	Transmission Separator Plate, 7.77" OD, 5.44" ID	AMR56548	\$ 22.00	
	Transmission Separator Plate, 6.93" OD, 4.75" ID	AMR57345	\$ 18.00	
	Transmission Separator Plate, 5.25" OD, 3.903" ID	AMR64197	\$ 10.00	
	Transmission Separator Plate, 5.75" OD, 3.897" ID	AMR70856	\$ 21.00	
	Transmission Separator Plate, 5.192" OD, 3.938" ID	AMR71035	\$ 9.00	
	Transmission Separator Plate, 7.77" OD, 5.44" ID	AMR77663	\$ 16.00	
	Transmission Separator Plate, 6.93" OD, 4.75" ID	AMR77671	\$ 11.00	
	Transmission Separator Plate, 6 Outside Tangs	AMR127466	\$ 30.75	
	Transmission Separator Plate, 12.712" OD, 10.60" ID	AMR46417	\$ 55.00	
	Transmission Separator Plate, 11.60" OD, 9.71" ID	AMR48235	\$ 48.00	
	Transmission Separator Plate, 12.70" OD, 10.59" ID	AMR46416	\$ 44.00	
	Transmission Separator Plate, 11.62" OD, 9.70" ID	AMR48236	\$ 48.00	
	Transmission Separator Plate, 6.74" ID	AMR50152	\$ 17.00	
	Transmission Separator Plate, 4.325" OD, 3.605" ID	AMR63069	\$ 7.00	
	Transmission Separator Plate, 10.995" OD, 6.90" ID	AMR85626	\$ 66.00	
	Transmission Separator Plate, 12.17" OD, 8.67" ID	AMR112385	\$ 119.00	
	Transmission Separator Plate, 5.185" OD, 3.895" ID	AMT28664	\$ 9.00	
	Transmission Separator Plate, 4.917" OD, 3.903" ID	AMT28665	\$ 44.00	
	Transmission Separator Plate, 10.82" OD, 8.437" ID	AMR71162	\$ 28.45	

John Deere®—Tractor

John Deere®—Tractor

Description	Part Number	Retail Price	Core
 Transmission Separator Plate, 6.94" ID	AMR61066	\$ 87.00	
 Transmission Separator Plate, 12.10" OD, 6.94" ID	AMR59690	\$ 96.00	
Transmission Separator Plate, 13.00" OD, 9.25" ID Replaces R114215	AMR216292	\$ 65.42	
Transmission Separator Plate, 11.614" OD, 4.37" ID	AMR101158	\$ 31.00	
Transmission Separator Plate, 7.625" OD, 4.50" ID	AMR107264	\$ 18.00	
Transmission Separator Plate, 10.25" OD, 8.50" ID	AMR108481	\$ 20.00	
Transmission Separator Plate, 7.677" OD, 4.724" ID	AMR108507	\$ 22.00	
Transmission Separator Plate, 8 Outside Tangs, 9.843" OD, 5.669" ID	AMR108509	\$ 39.00	
Transmission Separator Plate, 7.677" OD, 4.724" ID	AMR108530	\$ 60.00	
Transmission Separator Plate, 13.00" OD, 9.25" ID	AMR114215	\$ 39.00	
Transmission Separator Plate, 8.375" OD, 4.625" ID Replaces R216294	AMR116894	\$ 22.00	
Transmission Separator Plate, 14.00" OD, 10.625" ID	AMR86308	\$ 36.00	
Transmission Separator Plate, 9.25" OD, 4.50" ID	AMR95211	\$ 16.00	
Transmission Separator Plate, 13.00" OD, 9.25" ID	AMR95313	\$ 37.00	
Transmission Separator Plate, 0.20" Thick, 11.625" OD, 9.70" ID	AMR95378	\$ 35.00	
Transmission Separator Plate, 13.63" OD, 9.724" ID	AMR95422	\$ 38.00	
Transmission Separator Plate, 12.00" OD, 8.25" ID	AMR96791	\$ 33.00	
Transmission Separator Plate, 9.75" OD, 5.50" ID	AMR96805	\$ 33.00	
Transmission Separator Plate, 1.875" OD, 5.25" ID	AMR96806	\$ 40.00	
Transmission Separator Plate, 13.465" OD, 9.37" ID	AMR101160	\$ 55.00	
Transmission Separator Plate, 7.67" OD, 4.74" ID	AMR163994	\$ 23.91	

PTO Shafts



Application	Description	Part Number	Retail Price	Core
920, 1020, 1030, 1120, 1130, 1520, 2020, 2030, 2120, 2440 BSN 340999, Ind: 300, 301, 302, 400, 401, Utility: 820	PTO Shaft, 1000 RPM 5.29" Long, 21 Spline	AMAT20095	\$ 210.26	
920, 1020, 1120, 1130, 1520, 2020, 2030, 2120, 2440, Utility: 820	PTO Shaft, 540 RPM 6.875" Long, 6 Spline	AMAT20094	\$ 274.53	
840, 930, 940, 1020, 1030, 1120, 1130, 1140, 1520, 1640, 1830, 1840, 2020, 2030, 2040, 2040S BSN 429999, 2130, 2140, 2355N, 2440, 2550, 2555, 2630, 2640, (2650, 2650N, 2850 w/ Syncro Transmission), 2750, 2755, 2855N, Utility: 830 - All w/ Independent PTO	PTO Shaft, 1000 RPM 9.781" Long, 21 Spline	AMT30803	\$ 266.56	
840, 940, 1020, 1030, 1040, 1120, 1130, 1140, 1350, 1520, 1550, 1640, 1830, 1840, 1850N, 1950, 1950N, 2020, 2030, 2040, 2040S, 2120, 2130, 2140, 2250, 2355N, 2440, 2450, 2550, 2555, 2630, 2640, 2650, 2650N, 2750, 2755, 2850, 2855N, Ind: 300, 301, 400, 401	PTO Shaft, 540 RPM 9.203" Long, 6 Spline	AMAT29707	\$ 173.00	
2040 ASN 350000, 2150, 2255, 2350, 2355, 2550, 2555, 2750, 2755, 2855, Utility: 2155, 2240 ASN 350000	PTO Shaft, 540 RPM 31.25" Long, 6 Spline	AML38806	\$ 386.02	

Prices Subject to Change without Prior Notice. The use of original equipment manufacturer (OEM) part numbers or trademarks, e.g. Case® and John Deere®, are for reference purposes only and for indicating product use and compatibility. Our company and the listed replacement parts contained herein are not sponsored, approved or manufactured by the OEM. All parts are New unless designated Reman in the description.

John Deere®—Tractor

Application	Description	Part Number	Retail Price	Core
2150, 2255, 2350, 2355, 2550, 2555, 2750, 2755, Utility; 2155	PTO Shaft, 540 RPM 40.00" Long, 6 Spline	AML39949	\$ 518.89	
2510, 3020 BSN 122999, 4020 BSN 200999	PTO Shaft, 540 RPM 10.687" Long, 6 Spline	AMAR41753	\$ 135.00	
	PTO Shaft, 1000 RPM 10.875" Long, 21 Spline	AMR33342	\$ 186.86	
2510, 2520, 3020 ASN 123000, 4000, 4020 ASN 201000, 4030, 4040, 4230, 4240, 4250, 4320, 4430, 4440, 4450, 4055, 4455	PTO Shaft, 1000 RPM 10.875" Long, 21 Spline	AMR38224	\$ 90.00	
2510, 2520, 2840, 3020 ASN 123000, 4000, 4020 ASN 201000, 4030, 4040, 4050, 4055, 4230, 4240, 4250, 4255, 4320, 4430, 4440, 4450, 4455	PTO Shaft, 540 RPM 10.687" Long, 6 Spline Replaces R38223	AMAR41752	\$ 105.00	
2840, 2940, 2950, 2955, 3030, 3040, 3055, 3120, 3130, 3140, 3150, 3155	PTO Shaft, 540 RPM 10.687" Long, 6 Spline	AMR41756	\$ 90.00	
2840, 2940, 2950, 2955, 3055, 3150, 3155, 3255	PTO Shaft, 1000 RPM 11.414" Long, 21 Spline	AMT28672	\$ 132.00	
3010	PTO Shaft Internal PTO Shaft (Long Shaft) Replaces R27623, R31560	AMR32608	\$ 1140.53	
3010, 4010	PTO Shaft, 540 RPM Bolt-on style w/ dowels, 5.31" Long, 6 Spline	AMAR28572	\$ 95.00	
	PTO Shaft, 1000 RPM Bolt-on style w/ dowels, 4.275" Long, 21 Spline	AMAR28573	\$ 95.00	
4010	PTO Shaft Internal PTO Shaft (Long Shaft) Replaces R27339	AMR32609	\$ 1258.28	
4555, 4560, 4650, 4755, 4760, 4850, 4955, 4960 - w/ Power Shift Transmission	PTO Shaft, 1000 RPM w/o MFWD	AMR80884	\$ 516.00	
	PTO Shaft, 1000 RPM w/ MFWD	AMR80881	\$ 496.00	
4630 w/ Power Shift Transmission	PTO Shaft, 1000 RPM 54.812" Long	AMR50300	\$ 1035.02	
4630 w/ Syncro Range Transmission BSN 6999	PTO Shaft, 1000 RPM 54.187" Long	AMR51100	\$ 844.15	
4630 w/ Quad and Syncro Range Transmission ASN 7000	PTO Shaft, 1000 RPM 62.375" Long	AMR54545	\$ 882.67	
4640 w/ Quad Transmission	PTO Shaft, 1000 RPM 60.375" Long Replaces R65365	AMR59063	\$ 975.76	
4640, 4840 w/ Power Shift Transmission	PTO Shaft, 1000 RPM 52.531" Long Note: When replacing R58001, additional parts from John Deere® are required	AMR72447	\$ 650.34	
5603, 5065M, 5075M, 5085M, 6010, 6100B, 6100D, 6110, 6110B, 6110D, 6110L, 6115D, 6120, 6125D, 6130D, 6140D, 6200, 6200L, 6205, 6210, 6210L, 6300, 6300L, 6310, 6310L, 6310S, 6400, 6400L, 6403, 6405, 6410, 6410L, 6410S, 6500, 6500L, 6505, 6510, 6510L, 6510S, 6603, 6605, 6610, 6810, 6820, 6910, 6910S, 6920, 6920S, 7185J, 7200, 7205J, 7210, 7225J, 7400, 7405, 7410, 7420, 7500, 7510, 7515, 7520, 7600, 7610, 7700, 7710, 7715, 7720, 7800, 7810, 7815, 7820, 7920, SE6010, SE6110, SE6210, SE6310, SE6410, SE6510, SE6610	PTO Shaft, 540/1000 RPM 6/21 Reversible Spline, 9.20" Long Replaces L110178, L151598, R125087, R161794	AML156976	\$ 95.00	

John Deere®—Tractor

Application	Description	Part Number	Retail Price	Core
6105E, 6120E, 6135E, 6140R, 6145R, 6150M, 6150R, 6150RH, 6155M, 6155R, 6155RH, 6165J, 6170M, 6170R, 6175M, 6175R, 6180J, 6190R, 6195M, 6195R, 6210R, 6215R, 6830, 6930, 7185J, (7200R, 7215R, 7260R, 7280R BSN 080000), 7205J, (7210R, 7250R, 7270R, 7290R, 7310R ASN 080001), 7225J, 7230R, 7330, 7430, 7515, 7530, 7630, 7730	PTO Shaft, 540/1000 RPM 6/21 Reversible Spline	AML173283	\$ 167.00	
6105M, 6105R, 6110M, 6110R, 6115M, 6115R, 6120M, 6120R, 6125M, 6125R, 6130M, 6130R, 6140M, 6145M, 6230, 6330, 6430, 7130, 7230, Premium Models: 6230, 6330, 7130	PTO Shaft, 540/1000 RPM	AML173241	\$ 145.00	
6110, 6110L, 6120, 6120L, 6200, 6200L, 6210, 6210L, 6220, 6220L, 6300, 6300L, 6310, 6310L, 6310S, 6320, 6320L, 6405, 6420	PTO Shaft, 540 RPM 14.11" Long, 25 & 6 Spline	AML76496	\$ 291.02	
6120, 6120L, 6215, 6220, 6220L, 6230, 6320, 6320L, 6330, 6415, 6420, 6420L, 6430, 6520L, 6615, 6715	PTO Shaft, 540/1000 RPM 6 Tooth, 21/15/6 Spline, 9.26" Long Replaces L155266, L156978, L173284	AML173284	\$ 140.00	
2755, 2855N, 2955	PTO Shaft, Output Drive 32 & 16 Tooth	AMAL64060	\$ 625.00	
6110, 6110L, (6200, 6300, 6400, 6500 BSN 137287), (6200L, 6300L, 6500L ASN 137288), 6210, 6210L, 6310, 6310L, 6310S, 6400L ASN 138288, 6405, 6410, 6410L, 6410S, 6510L, 6510S, 6605	PTO Shaft, Output Drive	AML102682	\$ 359.00	
6140J, 6155J, 7610, 7710, 7810	PTO Shaft, Output Drive	AMR129768	\$ 665.00	
(6200, 6200L, 6300, 6300L, 6400, 6400L, 6500, 6500L BSN 137287)	PTO Shaft, Output Drive	AML101763	\$ 360.00	
7210, 7405, 7410, 7420, 7500, 7505, 7510, 7520, 7610 BSN 089999, 7710, 7810	PTO Shaft, Output Drive	AMR133086	\$ 339.00	
7610 BSN 089999, 7710, 7810	PTO Shaft, Output Drive European Version	AMR129763	\$ 308.00	
5045E, 5055E, 5065E, 5075E, 5076E, 5076EL, 5076EN, 5083E, 5083EN, 5085E, 5090E, 5090EH, 5090EL, 5090EN, 5093E, 5093EN, 5100E, 5101E, 5101EN	PTO Output Shaft, 540 RPM	AMSU303720	\$ 259.34	
7630, 7720, 7730, 7820	PTO Output Shaft Replaces R183232	AMR230860	\$ 360.00	
8100, 8110, 8120, 8130, 8200, 8210, 8220, 8225R, 8230, 8235R, 8245R, 8260R, 8270R, 8285R, 8295R, 8300, 8310, 8310R, 8320, 8320R, 8330, 8335R, 8345R, 8360R, 8400, 8410, 8420, 8430, 8520, 8530	PTO Output Shaft Replaces R266971	AMR122908	\$ 278.00	
4050, 4055, 4250, 4255, 4450, 4455	PTO Clutch Drum Replaces R71230	AMAR95784	\$ 830.00	
4555, 4560, 4650, 4755, 4760, 4850, 4955, 4960	PTO Clutch Drum Replaces R71231	AMAR95409	\$ 678.00	

John Deere®—Tractor

Application	Description	Part Number	Retail Price	Core
6105M, 6105R, 6110, 6110L, 6110M, 6110R, 6115M, 6115R, 6120, 6120L, 6120M, 6120R, 6125M, 6125R, 6130M, 6130R, 6140J, 6140M, 6140R, 6145M, 6145R, 6150M, 6150R, 6155J, 6155M, 6155R, 6170M, 6170R, 6175M, 6175R, 6190R, 6195M, 6195R, 6200, 6200L, 6210, 6210L, 6210R, 6215, 6215R, 6220, 6220L, 6230, 6300, 6300L, 6310, 6310L, 6310S, 6320, 6320L, 6330, 6400, 6400L, 6410, 6410L, 6410S, 6415, 6420, 6420L, 6430, 6500, 6500L, 6510S, 6520L, 6605, 6615, 6715, 7130, 7200, 7210, 7220, 7320, 7330, 7400, 7410, 7420, 7510, 7520, 7600, 7610, 7630, 7700, 7710, 7720, 7730, 7800, 7810, 7820, 7830, 7920, 7930, Premium Models: 6230, 6330, 6430, 7130, 7330, 7430, 7530	PTO Clutch Plate 6 Outside Tangs, 0.12" Thick, 5.443" ID, 8.031" OD	AMR95110	\$ 24.95	
8430, 8440, 8450, 8630, 8640, 8650, 8850	PTO Clutch Plate, Wavy 6 Outside Tangs, 0.09" Thick	AMR51676	\$ 25.45	
2840, 3020, 3030, 3120, 3130, 4000, 4020, 4030, 4040, 4050, 4055, 4230, 4240, 4250, 4255, 4320, 4430, 4440, 4450, 4455, Ind: 500, 600	PTO Gear	AMR33339	\$ 204.00	
840, 940, 1020, 1030, 1040, 1120, 1130, 1140, 1350, 1520, 1550, 1640, 1830, 1840, 1850N, 1950, 1950N, 2020, 2030, 2040, 2120, 2130, 2140, 2250, 2355N, 2440, 2450, 2510, 2520, 2550, 2555, 2630, 2640, 2650, 2650N, 2750, 2755, 2840, 2850, 2855N, 2940, 2950, 2955, 3020, 3030, 3040, 3050, 3055, 3130, 3140, 3150, 3155, 3255, 3350, 3650, 4000, 4020, 4030, 4040, 4050, 4055, 4230, 4240, 4250, 4255, 4320, 4350, 4430, 4440, 4450	Drive Sleeve, PTO Output Shaft Replaces R38220, R70960, R72046	AMR45126	\$ 81.50	
(3020, 4020 BSN 130000), Ind: 500, 600 BSN 201000	Drive Sleeve, PTO Output Shaft For Syncro-Range or Powershift Transmission	AMR33855	\$ 57.50	
1020, 1520, 1640, 1830, 2020, 2030, 2040, 2130, 2140, 2155, 2355, 2355N, 2440*, 2510, 2520, (2550, 2555, 2750, 2755 - w/ Synchroniozed Transmission), 2630*, 2840, 2855N, 2940, 2950, 2955, 3020, 3030, 3040 ASN 429999, 3120, 3130, (3140, 4020 ASN 200999), 3150, 4000, 4030, 4040, 4230, 4240, 4320 Syncro Range, 4430, 4440	Housing Seal, PTO Bearing Replaces AL68619, AT167936, RE13181	AMAT16431	\$ 10.08	

*Excluding Single 540 RPM

PTO Adapters

Application	Description	Part Number	Retail Price	Core
Tractors up to 70HP	PTO Adapter Small 540 to 1000 Spline Changes PTO from 1 3/8" x 6 spline to 1 3/8 x 21 spline and extends the PTO shaft 4 1/8"	AMX59112	\$ 40.00	
Tractors up to 70HP	PTO Adapter Small 1000 to 540 Spline, 6 3/8" Overall Length Reduces PTO from 1 3/8" x 21 spline to 1 3/8" x 6 spline and extends the PTO shaft 4 1/8"	AMX59108	\$ 40.00	
Tractors up to 100HP	PTO Adapter Large 1000 to 540 Spline, 7 1/2" Overall Length Reduces PTO from 1 3/4" x 20 spline to 1 3/8" x 6 spline and extends the PTO shaft 4 5/8"	AMX59109	\$ 70.00	
Tractors up to 100HP	PTO Adapter Large 1000 to Small 1000 Spline, 7" Overall Length Changes PTO from 1 3/4" x 20 Spline to 1 3/8" x 21 Spline and extends the PTO shaft 4 5/8"	AMX59110	\$ 70.00	



PTO Shields

Shields come painted with primer coat unless otherwise noted.

Application	Description	Part Number	Retail Price	Core
2150, (2350, 2550, 2750, 2950 - w/ Hinged Guard), 2255, 2440 ASN 340999, 2640, 4040, 4050, 4055, 4240, 4250, 4255, 4440, 4450, 4455, Utility: 2240 ASN 349999	PTO Shield Replaces R63608	AMR69628	\$ 100.00	
2510, 2520, 3020, 4000, 4020, 4030, 4230, 4320, 4430, 4455 Mexico	PTO Shield	AMR33348	\$ 38.37	
3010, 4010, 4520, 4620, 4630, 5010, 5020, 6030, 7020, 7520	PTO Shield	AMR27562	\$ 44.50	
8130, 8225R, 8230, 8230T, 8235R, 8245R, 8260R, 8270R, 8285R, 8295R, 8295RT, 8310R, 8310RT, 8320R, 8320RT, 8330, 8330T, 8335R, 8335RT, 8345R, 8345RT, 8360R, 8360RT, 8370RT, 8430, 8430T, 8530	PTO Shield	AMRE217737	\$ 89.00	
8130, 8225R, 8230, 8230T, 8235R, 8245R, 8260R, 8270R, 8285R, 8295R, 8295RT, 8310R, 8310RT, 8320R, 8320RT, 8330, 8330T, 8335R, 8335RT, 8345R, 8345RT, 8360R, 8360RT, 8370RT, 8430, 8430T, 8530	PTO Top Support Plate	AMR217741	\$ 78.50	

Ring Gears and Pinions



Application	Description	Part Number	Retail Price	Core
4630 Late	Ring Gear and Pinion Set For Quad & Syncro Transmissions	AMAR62693	\$ 650.00	
5045D, 5045E, 5055D, 5055E, 5065E, 5075E, 5076E, 5076EF, 5076EL, 5085E, 5090E, 5090EH, 5090EL, 5103, 5203, 5303, 5403, 5415, 5425 BSN 001689, 5615, 5715, 5725 BSN 005048, 5725N	Ring Gear and Pinion Set	AMRE73620	\$ 1055.00	
5076E, 5076EL, 5103, 5203, 5303, 5403, 5415, 5615, 5715	Ring Gear and Pinion Set	AMRE71832	\$ 1295.00	

Differentials and Components



Application	Description	Part Number	Retail Price	Core
1020, 1030, 1120, 1130, 1530, 1630, 1830, 2020, 2030, 2040, 2120, 2130, 2150, 2255, 2350, 2355, 2550, 2555, Utility: 820, 830, 2155, 2240	Differential Kit 1/2" Rivet Holes Kit Includes R51500 Housing, T30253 Housing, (2) T29394 Bevel Gears, (2) L29226 Shafts and (4) L29227 Gears	AMR69916-K	\$ 525.00	
840, 920, 930, 940, 1020, 1030, 1040, 1120, 1130, 1140, 1530, 1630, 1640 (BSN 41063), 1830, 1840 (BSN 41063), 2020, 2030, 2040, 2120, 2130, 2150, 2255, 2350, 2355, 2550, 2555, Utility: 820, 830, 2155, 2240	Differential Housing, Left Hand	AMR51500	\$ 372.50	
2750, 2840, 2940, 2950, 3030, 3120, 3130, 3140, 3150, 3155, 3255, 3350, 3640, 3650, 6010, 6100, 6110, 6120, 6200, 6205, 6210, 6220, 6300, 6310, 6320, 6400, 6403, 6405, 6420, 6500, 6505, 6510, 6520, 6605, 6610, 6620	Differential Pinion Gear 18 Tooth	AML28376	\$ 102.56	
4000, 4010, 4020, 4040, 4050, 4055, 4230, 4240, 4250, 4255, 4320, 4430, 4440, 4450, 4455, 7520, 7600, 7610, 7700, 7710, 7800, 7810, 8430, 8440, 8450, 8630	Differential Pinion Gear 24 Tooth, 15 Spline	AMR63477	\$ 125.00	
4000, 4010, 4020, 4040, 4230, 4240, 4320, 4430, 4440, 7520, 8430, 8440, 8630	Differential Pinion Gear 13 Tooth	AMR42444	\$ 65.00	

John Deere®—Tractor

Application	Description	Part Number	Retail Price	Core
(5083E, 5083E Limited, 5093E, 5093E Limited, 5101E, 5101E Limited, 5603 BSN 440000), (5083EN, 5093EN, 5101EN BSN 461000 w/ Yanmar w/ PowrReverser™), 5200, 5210, 5220, 5225, 5300, 5310, 5320, 5320N, 5325, 5325N, 5400, 5400N, 5410, 5420, 5420N, 5425, (5425N, 5725N - w/ NM, NM05, NP or NP05 SyncShuttle™ Transmission), 5500, 5500N, 5510, 5520, 5520N, 5625	Differential Pinion Gear	AMR113897	\$ 81.98	
5200, 5210, 5220, 5300, 5310, 5310N, 5320, 5320N, 5400, 5400N, 5410, 5420, 5420N, 5500, 5510, 5510N, 5520, 5520N	Differential Pinion Gear	AMR113899	\$ 41.52	
920, 1020, 1030, 1120, 1130, 1520, 1530, 1630, 1640 ASN 430000, 1830, 2020, 2030, 2040, 2130, 2150, 2255, 2350, 2440 BSN 340999, 2550, 2630, 2640 ASN 341000, Utility: 820, 830, 2155, 2240 ASN 350000	Bevel Gear, Differential 18 Tooth Replaces T21971	AMT29394	\$ 95.49	



Rear Axle Components

Application	Description	Part Number	Retail Price	Core
8100T, 8120T, 8200T, 8220T, 8230T, 8295RT, 8300T, 8320T, 8330T, 8400T, 8420T, 9330, 9360R, 9410R, 9430, 9460R	Rear Axle Planetary Gear Replaces R224672, R554198, R560122	AMR198700	\$ 392.00	
8110, 8120, 8130, 8210, 8220, 8225R, 8230, 8235R, 8260R, 8285R, 8310, 8320, 8330, 8410, 8420, 8520, 9100, 9120, 9200, 9220, 9300, 9400	Rear Axle Planetary Gear 30 Tooth, 3 3/4" ID, 7 1/8" OD	AMR157059	\$ 308.00	
(4000, 4020 - w/ Row Crop & Standard), 4040, 4050, 4230, 4240, 4250, 4320, 4430, 4440, 4455 Mexico, 7020, 7405 w/ 18.40" x 38" Tires, 7520, (4040, 4050 ASN 2875, 4240, 4250 ASN 3914, 4320, 4430, 4440 - w/ 9-Bolt Hubs)	Axle Half Sleeve, Keyed For 86 mm Axle Use w/ Cast Rear Wheels R33450, R34680, R48954, R48955, R52160, R70309	AMR33532	\$ 100.00	
4040, 4050, 4240, 4250, 4430, 7020, 7520	Axle Half Sleeve, Keyed For 86 mm Axle, Includes Dowels Use w/ Cast Rear Wheel R35300	AMAR83355	\$ 175.00	
4430, 4440, 4520, 4620, 5010, 5020, 6030, 8430, 8630	Axle Half Sleeve, Keyed For 92 mm Axle, Includes Dowels	AMAR83354	\$ 135.00	



Brakes and Components

Application	Description	Part Number	Retail Price	Core
(1640, 2040, 2140 ASN 429999 w/ SG2 Cab), 2350, 2550, 2750, 2940, 2950, 3040, 3140	Clutch Master Cylinder	AMAL34743	\$ 132.10	
(2355, 2555, 2755, 2955 ASN 620387), 3055, 3155, 3255	Clutch Master Cylinder Replaces AL57864	AMAL66874	\$ 177.19	
(40, 420, 430 - Hi-Crop), 320, 330, 1010 Single Row Crop	Brake Disc 25 Spline, 5" OD, 0.5625" Thick Replaces AT13068	AMAM1967T	\$ 33.00	
920, 930, 1020, 1030, 1120, 1130, 1520, 1530, 1630, 1830, 2020, 2030, 2040 BSN 305839, 2120, 2130, 2440 BSN 340999, Ind: 300B, Utility: 820, 830, 2240 BSN 305313	Brake Disc 12 Spline, 12" OD Replaces AT22034	AMAT63106	\$ 120.00	

John Deere®—Tractor

Application	Description	Part Number	Retail Price	Core
930, 940, 1030 ASN 300750, 1040, 1130 ASN 300750, 1140, 1630 ASN 300750, 1640, 1830 ASN 301446, 1840, 2030 ASN 301746, 2040, 2150, 2255, 2350, 2355 BSN 672619, 2550, 2555 BSN 672619, Utility: 830, 2155 BSN 672619, 2240	Brake Disc 12 Spline, 12" OD Replaces AL29645	AMAL38234	\$ 80.00	
930, (1030, 1130, 1630 ASN 300749 or w/ Heavy Duty Final Drive), (1640, 2040 ASN 370492 w/ Heavy Duty Final Drive), 1830 ASN 301445, 2030 ASN 301745, 2140 ASN 370492, Utility: 830	Brake Disc 12 Spline, 12" OD Replaces AL38236	AMAZ40478	\$ 94.00	
940, 1040, 1140, 1640, 1840, 2040, 2150, (2355, 2555 ASN 672620), 2255, 2350, 2550, Utility: 2155 ASN 672620	Brake Disc 12 Spline, 12" OD	AMAL65872	\$ 107.00	
(1640, 2040 ASN 370493 w/ HD Final Drive), (2040S, 2140 ASN 370493), 2130 w/ HD Final Drive, 2250, (2355N, 2555, 2755, 2855N BSN 668664), 2650, 2840 ASN 305025, 2850, 2940, (2955, 3155 BSN 669173), 3030, 3040, 3130, 3140, 3150	Brake Disc 15 Spline, 12" OD Replaces AL30095	AMAL38235	\$ 95.00	
2010 ASN 042001	Brake Disc 21 Spline, 5.64" OD, 1.385" Spline Diameter	AMAT12312	\$ 21.00	
2440 ASN 341000, 2630, 2640	Brake Disc 11 Spline, 12" OD	AMRE43390	\$ 100.00	
2650, 2650N, 2850, 2950, 3040, 3055, 3140 ASN 430000, 3255, (2355, 2555, 2755, 2855 ASN 668665), (2955, 3155 ASN 669174)	Brake Disc 15 Spline, 12" OD	AMAL65871	\$ 105.00	
2955 BSN 765517, 3055, 3155, 3255	Brake Disc 8.66" ID, 12.12" OD, 1.89" Wide Replaces L60889, L63946	AML65164	\$ 262.58	
4000, 4020, 4040, 4050, 4230, 4240, 4250, 4430, 4440, 4450	Brake Disc	AMAR66749	\$ 279.36	
4450 Powershift ASN 028980 or Quad-Range™ ASN 015485, 4555	Brake Disc 2.551" ID, 15.118" OD, 0.278" Thick	AMR97800	\$ 188.86	
5039D, 5045D, 5055D, 5105, 5205	Brake Disc	AML116596	\$ 37.92	
5045D, 5055D	Brake Disc 1.414" ID, 9.764" OD, 0.183" Thick Replaces AL119874	AMSJ18395	\$ 73.58	
5093E w/ PE4045HP059 Engine, 5415, 5415H, 5425 BSN 002631, 5615, 5625 BSN 001688, 5715, 5715HC, 5725 BSN 005047	Brake Disc 0.492" ID, 12.047" OD, 0.492" Thick Replaces AL162808, SJ7870	AMAL76887	\$ 85.00	
5200, 5210, 5220, 5300, 5310, 5310N, 5320, 5320N, 5400, 5400N, 5403, 5410, 5415N, (5420, 5520 - w/o Hi-Crop), 5420N, 5500, 5500N, 5510, 5510N, 5520N, 5605, 5705	Brake Disc 14 Tooth, 12" Diameter Replaces AL76887	AMAL162808	\$ 147.55	
5200 BSN 620188, 5300 BSN 630345, 5400 BSN 640542, 5400N, 5500 BSN 650438, 5500N	Brake Disc 6 Spline, 9.506" ID, 12.213" OD, 0.234" Thick	AML77359	\$ 62.17	
6010, 6020, (6100, 6200, 6300, 6300L, 6400, 6400L, 6500, 6500L, 6506, 6600 ASN 195232), 6110, 6110E, 6110J, 6110L, 6120, 6120L, 6125E, 6125J, 6130, 6205, 6210, 6210L, 6215, 6220, 6220L, 6225, 6230, 6310, 6310L, 6310S, 6320, 6320L, 6325, 6330, 6405, 6410, 6410L, 6410S, 6415, 6420, 6420L, 6420S, 6425, 6430, 6505, 6510, 6510L, 6510S, 6515, 6520, 6520L, 6525, 6530, 6534, 6605, 6610, 6615, 6620, 6630, 6715, 7130, 7220, 7230, 7320, SE6010, SE6020, (SE6100, SE6200, SE6300, SE6400 ASN 195232), SE6110, SE6120, SE6210, SE6220, SE6310, SE6320, SE6410, SE6420, SE6510, SE6520, SE6610, SE6620, Premium Models: 6230, 6330, 6430, 6530, 6534, 6630, 7130, 7230	Brake Disc Actuating, 22 mm Thick Replaces L75651	AML114053	\$ 200.00	

John Deere®—Tractor

Application	Description	Part Number	Retail Price	Core
6110, 6110L, 6120, 6200, 6200L, 6210, 6210L, 6220, 6300, 6300L, 6310, 6310L, 6310S, 6320, 6400, 6400L, 6405, 6410, 6410L, 6410S, 6420, 6500, 6500L, 6505, 6510L, 6510S	Brake Disc 14 Spline, 12.25" OD Replaces AL75434	AMAL111498	\$ 110.00	
6110, 6110L, 6120, 6200, 6200L, 6210, 6210L, 6220, 6300, 6300L, 6310, 6310L, 6310S, 6320, 6400, 6400L, 6410, 6410L, 6410S, 6420, 6500, 6500L, 6510L, 6510S	Brake Disc, Heavy Duty 14 Spline, 12.25" OD	AMAL112982	\$ 89.00	
6800, 6810, 6900, 6910, 6910S, 7200, 7210, 7400, 7405, 7410, 7510	Brake Disc Replaces RE47082, RE64006, RE70175, RE160072	AMRE186966	\$ 65.00	
7610 SN 007411-089999, (7710, 7810 ASN 007411), 7800, Premium Models: 7430, 7530	Brake Disc 15 Tooth, 15.268" OD Replaces RE65197	AMRE186965	\$ 134.46	
8120, 8220, 8320, 8420, 8520	Brake Disc 14 Spline, 3.698" Major ID, 2.93" Minor ID, 16.845" OD, 0.41" Thick	AMRE204407	\$ 129.80	
820, 830, 920, 1020, 1030, 1120, 1130, 1520, 1530, 1630, 1830, 2020, 2030, (2040, 2240 BSN 349999), 2130, Ind: 300, 301, 400, 401	Brake Plate 8.663" ID, 12.044" OD Replaces T28177, T38063, T46728	AML31016	\$ 98.00	
(1030, 1130, 1630 ASN 300749), (1640, 3040, 3140 ASN 429999), 1830 ASN 301445, 2030 ASN 301745, 2040 ASN 305839, 2140 ASN 429999 w/ Syncro w/ Increased Lift, 2150, 2255, 2350, 2355N, 2550, (2755, 2855N BSN 668665), 2950, 2955 BSN 713797, 3155 BSN 715796, Utility: 2155, 2240 ASN 305313	Brake Plate 8.335" ID, 12.17" OD Replaces L56247	AML33497	\$ 103.59	
2355N ASN 713945, 2550 w/ Heavy Duty Final Drive, 2555, 2750, 2755, 2840, 2855N, 2940, 2950, 2955 ASN 713797, 3055, 3155 ASN 715796, 3255	Brake Plate Actuating, 8.67" ID, 12.17" OD Replaces VPJ8144	AML55004	\$ 117.41	
2840 ASN 305025, 2940, 2950 BSN 481283, 3030 ASN 301275, 3130	Brake Plate Actuating, 8.663" ID, 12.111" OD	AML33909	\$ 221.11	
3010	Brake Plate 18 Tooth, 13.25" OD	AMR26971	\$ 69.00	
3020, 4030	Brake Plate 16 Tooth, 13.25" OD Use w/ R49427 Brake Shaft	AMR33816	\$ 69.00	
4000, 4020, 4040, 4050, 4230, 4240, 4250, 4320, 4430	Brake Plate 15 Tooth, 15" OD Use w/ R56731, R59928, R62685 or R67198 Brake Shaft Replaces R85029	AMR62686	\$ 69.00	
4000, 4020, 4230, 4320, 4430	Brake Plate 15 Tooth, 15" OD Use w/ R33431 or R45779 Brake Shaft	AMR78430	\$ 89.00	
4010	Brake Plate 18 Tooth, 15" OD	AMR26767	\$ 102.00	
4040, 4240, 4440	Brake Plate 14 Tooth, 15" OD Use w/ R59698 Brake Shaft	AMR58758	\$ 69.00	
4520, 4620, 4630, 7020, 7520	Brake Plate 13 Tooth, 17" OD Use w/ R43016 Brake Shaft	AMR48864	\$ 69.00	
4520, 4620, 4630, 4640, 4650, 4840, 4850, 7020, 7520, 8440, 8630, 8640	Brake Plate 14 Tooth, 17" OD Use w/ R57614 or R63911 Brake Shaft	AMR61712	\$ 119.30	
4840, 4850, 8650	Brake Plate 14 Tooth, 17" OD Use w/ R61421 or R74072 Brake Shaft	AMR61140	\$ 75.00	

John Deere®—Tractor

Application	Description	Part Number	Retail Price	Core
5045D, 5045E, 5055D, 5055E, 5065E, 5075E, 5076E, 5076EF, 5076EL, 5082E, 5083EN, 5085E, 5090E, 5090EH, 5090EL, 5100E, 5101EN, 5103, 5203, 5303, 5403, 5415, 5425 BSN 002632, 5425N, 5615, 5625 BSN 001689, 5715, 5725 BSN 005048, 5725N	Brake Plate 9.528" ID, 13.642" OD, 0.234" Thick	AML77358	\$ 49.00	
6140J, 6155J, 7405, 7500, 7505	Brake Plate	AMR125128	\$ 155.00	
6170M, Premium Models: 7430, 7530	Brake Plate Replaces R240743	AMR331779	\$ 90.00	
(6200, 6200L SN 116380-182760), (6300, 6300L SN 182761-795231), (6400, 6400L, 6500, 6500L BSN 195232)	Brake Plate Actuating, 21.50 mm Thick Replaces L75651, L112757	AML114091	\$ 165.00	
5103, 5203, 5210, 5220, 5303, 5310, 5310N, 5320, 5320N, 5325, 5325N, 5403, 5410, 5420, 5420N, 5425N, 5500 ASN 650437, 5510, 5510N, 5520, 5520N, 5525, 5525N	Brake Piston 9.529" ID, 13.976" OD, 1.38" Thick Replaces L101856	AML158505	\$ 169.22	
6010, 6020, (6100, 6200, 6200L, 6300, 6300L, 6400, 6400L, 6500, 6500L, 6506, 6600 ASN 165096), 6110, 6110E, 6110J, 6110L, 6120, 6120L, 6125E, 6125J, 6130, 6205, 6210, 6210L, 6215, 6220, 6220L, 6225, 6230, 6310, 6310L, 6310S, 6320, 6320L, 6325, 6330, 6400SP, 6405, 6410, 6410L, 6410S, 6415, 6420, 6420L, 6420S, 6425, 6430, 6505, 6510, 6510L, 6510S, 6515, 6520, 6520L, 6525, 6530, 6534, 6605, 6610, 6615, 6620, 6630, 6715, 7130, 7220, 7230, 7320, SE6010, SE6100, SE6110, SE6200, SE6210, SE6300, SE6310, SE6320, SE6400, SE6410, SE6420, SE6510, SE6520, SE6610, SE6620, Premium Models: 6230, 6330, 6430, 6530, 6534, 6630, 7130, 7230	Brake Piston	AML111978	\$ 235.00	
(6110M, 6120M, 6130M, 6140M, 6145M, 6155M - FT MY20 w/ PowerFill™ Brake and w/o Transmission Oil Evacuation), 6170M, 6175M, 6195M, Premium Models: 7430, 7530	Brake Piston Marked R331403	AMR331403	\$ 125.00	
6140J, 6155J, 7405, 7500, 7505	Brake Piston	AMR125127	\$ 175.00	
6140J, 6155J, 7200, 7210, 7400, 7410, 7420, 7510, 7520	Brake Piston Replaces R125127	AMR333928	\$ 239.43	
5076E, 5076EL, 5082E, 5083E, 5090E, 5090EH, 5090EL, 5093E, 5310N, 5320N, 5400N, 5415, 5420N, 5425, 5510N, 5520N, 5615, 5625, 5715, 5725	Brake Band	AMRE62481	\$ 193.50	
2510, 2520, 3010, 3020, 4000, 4020, 4030, 4040, 4050, 4230, 4240, 4320, 4440	Brake Pad 2.50" x 6.50" (6) Pads Required per Side, (12) Total for Tractor Mounting Rivets Not Included Replaces R26969, R90085	AMAR28487	\$ 15.00	
2510, 2520, 3010, 4000, 4020, 4040, 4050, 4230, 4240, 4250, 4320, 4430, 4440, 4450, 4455	Brake Pad 2.50" x 6.50" New Style Metal Backing Plate Mounting Rivets Not Included (6) Pads Required Per Side, (12) Total for Tractor	AMR111122	\$ 14.00	
4010, 4020, 4040, 4050, 4230, 4240, 4250, 4320, 4430, 4440, 4450, 4455, 4520, 4620, 5010, 5020, 6030, 7020, 7520, 8430, 8440, 8450, 8630, 8640, 8650, 8850	Brake Pad 3" x 7", New Style Metal Backing Plate Mounting Rivets Not Included (6) Pads Required per Side, (12) Total for Tractor	AMR110464	\$ 14.00	
4010, 4450, 4520, 4620, 4640, 4650, 4840, 4850, 5010, 5020, 6030, 7020, 7520, 8430, 8440, 8450, 8630, 8640, 8650, 8850	Brake Pad 3" x 7" Mounting Rivets Not Included (6) Pads Required per Side, (12) Total for Tractor	AMAR28488	\$ 18.00	
2510, 2520, 3010, 3020, 4000, 4010, 4020, 4030, 4040, 4050, 4230, 4240, 4250, 4320, 4430, 4440, 4450, 4520, 4620, 4630, 4640, 4650, 4840, 4850, 5010, 5020, 6030, 7020, 7520, 8430, 8440, 8450, 8630, 8640, 8650, 8850	Brake Pad Rivets 0.135" x 0.203", Includes 36 Rivets Mounting Rivets Not Included (6) Required per pad	AMD1761	\$ 8.44	

Prices Subject to Change without Prior Notice. The use of original equipment manufacturer (OEM) part numbers or trademarks, e.g. Case® and John Deere®, are for reference purposes only and for indicating product use and compatibility. Our company and the listed replacement parts contained herein are not sponsored, approved or manufactured by the OEM. All parts are New unless designated Reman in the description.

John Deere®—Tractor

Application	Description	Part Number	Retail Price	Core
2510, 2520, 3020, 4000, 4020, 4030, 4040, 4050, 4230, 4240, 4250, 4320, 4430, 4440, 4450, 4520, 4620, 4630, 4640, 4650, 4840, 4850, 7020, 7520, 8430, 8440, 8450, 8630, 8640, 8650, 8850	Brake Pad Rivets 0.135" x 1.171", Includes 18 Rivets (6) Required per pad	AMR708	\$ 8.70	
3010, 4000, 4010, 4020, 4230, 4430	Brake Pad Rivets 0.135" x 1.343" Includes 18 Rivets (6) Required per pad	AMR26301	\$ 6.59	
3010, (4000, 4020 Hi-Crop), 4010, 4040, 4050, 4230, 4240, 4250, 4320, 4430, 4440, 4450, 5010, 5020, 6030	Brake Pad Rivets 0.135" x 0.671" Includes (18) Rivets (6) Required per pad	AMD2593	\$ 6.07	

Brake Pinion Shaft and Gears



Application	Description	Part Number	Retail Price	Core
4000, 4020, (4050 Powershift Transmission ASN 002725 or Quad-Range™ Transmission ASN 006644), (4055, 4255 - w/ 86 mm Axle), 4230 ASN 026189, 4250 ASN 001000, 4320, 4430 ASN 040771	Brake Pinion Shaft 9.78" Long, 15 Tooth, 18 Spline Replaces R59928	AMR62685	\$ 245.00	
(4000, 4020, 4230 BSN 015452), 4320, 4430 BSN 021269, 7520 Front Axle Only, Ind: 600	Brake Pinion Shaft 9.39" Long, 15 Tooth, 18 Spline Replaces R33431	AMR45779	\$ 450.93	
4020, 4230 BSN 015452, 4320, 4430 BSN 021269, 7520 Front Axle Only, Combines: (7720, 8820 - w/ planetary final drives)	Brake Pinion Gear 21 Tooth, Use w/ AMR45779 Brake Pinion Shaft	AMR33004	\$ 80.00	
4040, (4050 w/ Powershift Transmission BSN 002724 or Quad-Range™ Transmission BSN 006643), 4230 SN 015453-026188, 4240, 4430 SN 021270-040770 - w/ 86 mm Gear	Brake Pinion Gear 21 Tooth, 1.515" Wide Use w/ AMR67198 Brake Shaft	AMR56732	\$ 160.00	
(4040, 4240 - w/ 86 mm Gear), (4050 Powershift Transmission BSN 002724 or Quad-Range™ Transmission BSN 006643), 4230 SN 015453-026188, 4430 SN 021270-040770	Brake Pinion Shaft 9.38" Long, 15 Tooth, 18 Spline Replaces R56731	AMR67198	\$ 175.00	
4255, 4350, 4440, (8440, 8450, 8630 ASN 7843 - Front Axle Only)	Brake Pinion Shaft 10.58" Long, 14 Tooth, 18 Spline	AMR59698	\$ 406.53	
4255, 4440 BSN 010329 w/ 86 mm or 92 mm Axle, (8440, 8450 - Front Axle), 8630 ASN 007843 Front Axle	Brake Pinion Gear 31 Tooth, 2.755" Wide	AMR59696	\$ 209.71	
4520, 4620, 4630 BSN 012839, (7020, 7520 - Rear Axle Only)	Brake Pinion Shaft 10.73" Long, 13 Tooth, 22 Spline Replaces R43016	AMR113732	\$ 600.07	
	Brake Pinion Gear 20 Tooth, 2" Wide Use w/ AMR113732 Brake Shaft	AMR43014	\$ 215.00	
4520, 4620, 4630 ASN 012840, (7020, 7520, 8430, 8630 BSN 007842 - Rear Axle Only)	Brake Pinion Shaft 10.73" Long, 14 Tooth, 22 Spline Replaces R57614	AMR61711	\$ 125.00	
	Brake Pinion Gear 22 Tooth, 2" Wide Use w/ AMR61711 Brake Shaft	AMR57615	\$ 185.00	

John Deere®—Tractor

Application	Description	Part Number	Retail Price	Core
4555, 4640, 4650, 4755, 4760, (8440, 8450, 8630 ASN 007843 - Rear Axle Only)	Brake Pinion Shaft 11.09" Long, 14 Tooth, 22 Spline Replaces R63911	AMR112834	\$ 210.00	
	Brake Pinion Gear 22 Tooth, 2.56" Wide Use w/ AMR112834 Shaft Replaces R64324	AMR92335	\$ 85.00	
4840, 4850, 4955, 4960, 8560, 8570, 8640, 8650, 8760, 8770, 8970	Brake Pinion Gear Replaces R61423	AMR120848	\$ 379.41	
4840, 4850, 4955, (8640, 8650 - Front or Rear Axles)	Brake Pinion Shaft 12" Long, 14 Tooth, 22 Spline Replaces R61421, R74072	AMR112836	\$ 165.00	
8100, 8110, 8120, 8130, 8200, 8210, 8220, 8225R, 8230, 8235R, 8260R, 8285R, 8300, 8310, 8320, 8330, 8410, 8420, 8560, 8570, 8760, 8770, 8870, 8970, 9100, 9120, 9200, 9220, 9230, 9300, 9320, 9330, 9360R, 9370R, 9400, 9410R, 9420, 9420R, 9430, 9460R, 9470R, 9520, 9620	Brake Pinion Shaft Replaces R157058, R328178	AMR328178	\$ 287.00	
8430, 8630 BSN 007842 - Front Axle Only	Brake Pinion Shaft 10.09" Long, 14 Tooth, 18 Spline Replaces R57401	AMR67199	\$ 423.98	
	Brake Pinion Gear 31 Tooth, 2.25" Wide Use w/ AMR67199 Shaft Replaces R57402	AMR65635	\$ 85.00	

Drawbars and Components

All of our drawbars are cut, drilled and heat-treated to exact specifications.



Application	Description	Part Number	Retail Price	Core
1020, 1520, 1530, 2020, 2030, 2040, 2350, 2355, 2440, 2550, 2555, 2630, 2640, 2750, 2755, 2850, 2855, Utility: 820, 830, 2240	Drawbar, Offset 2.50 x 1.375" x 36.75" w/ 2.375" Offset, (3) 0.781" Diameter Holes: 1.125", 2.75" & 8.578" from Front	AML29020	\$ 120.00	
1020, 1520, 1530, 2020, 2030, 2040, 2350, 2355, 2440, 2550, 2555, 2630, 2640, 2750, 2755, 2850, 2855, Ind: (300B, 301A, 302, 302A, 401B, 401C ASN 249301), 401D, Utility: 820, 830, 2240	Drawbar, Straight, Standard Duty 2.50" x 1.25" x 36.75", (3) 0.781" Diameter Holes: 1.125", 2.75" & 8.578" from Front	AMR61126	\$ 95.00	
2150, 2255, 2355N, Utility: 820, 2155	Drawbar 2" x 1.25" x 36.75", (3) .781" Diameter Holes: 1.125", 2.75" & 8.578" from Front	AMT29898	\$ 85.00	
(2510, 2520 - Row-Crop), 3010	Drawbar, Offset 2" x 1.25" x 45" w/ 1.875" Offset, (4) 0.765" Diameter Holes: 4.44", 2.44", 7.44" & 12.69" from Front	AMR27692	\$ 190.31	
(2510, 2520, 4000, 4020, 4030 - HD Hi-Crop), (3020, 4010 - Standard Wide Swing, HD Row-Crop, HD Hi-Crop)	Drawbar, Offset, Heavy Duty 2.50" x 1.25" x 44.75" w/ 2.50" Offset and w/o Hammer Strap Holes, (6) 1.01" diameter holes: 1.06", 2.31", 4.36", 7.05", 9.05" & 12.30" from front	AMR81576	\$ 135.00	
2510 Row-Crop Wide Swing, Hi-Crop, (2520, 3010 - Row-Crop, Wide Swing), 3020 Row-Crop, Standard, Row-Crop Utility, Orchard, (4000, 4020 - Hi-Crop), 4010 Row-Crop Standard, Row-Crop and Standard Wide Swing, Hi-Crop, 4030 Row-Crop	Drawbar, Offset 2.50" x 1.25" x 44.75" w/ Offset - 2.50" w/ Hammer Strap Holes, (6) 1.01" Diameter Holes at 1.06", 2.31", 4.36", 7.05", 9.05", & 12.30" from Front	AMRE20662	\$ 129.00	
2840, 2940, 2950, 2955, 3150	Drawbar, Offset, Standard Duty 2.50" x 1.375" x 40.875" w/ 2.125" Offset (4) 1.016" Diameter Holes at 1.062", 2.687", 6.187", 7.812" from Front	AMT28014	\$ 140.00	

John Deere®—Tractor

Application	Description	Part Number	Retail Price	Core
(2955, 3055, 3155, 3255 ASN 632322)	Drawbar, Offset 2.50" x 1.375" x 49.25" w/ 2.50" Offset, (5) 1.01" Diameter Holes: 1.42", 3.79, 9.41", 11.22" & 15.60 from Front	AML61510	\$ 225.00	
4000, 4020, 4030, 4040, 4320, 4430	Drawbar, Straight, Standard Duty 2.50" x 1.375" x 45", (6) 1.015" Diameter at 1.375", 2.625", 4.687", 7.345", 9.325", 12.59" from Front	AMR80842SPL	\$ 130.00	
4000, 4020, 4030, 4040, 4320, 4430	Drawbar, Offset, Standard Duty 2.50" x 1.375" x 45" w/ 2" Offset, (6) 1.015" Diameter Holes @ 1.375", 2.625", 4.687", 7.345", 9.325", 12.59" from Front Replaces R34448	AMRE20663	\$ 165.00	
4000, 4020, 4030, 4040, 4320, 4430	Drawbar, Offset, Heavy Duty 2.50" x 1.375" x 45" w/ 2" Offset w/o Hammer Strap Holes, (6) 1.015" Diameter at 1.375", 2.625", 4.687", 7.345", 9.325", 12.59" from Front	AMRE20663HD	\$ 195.00	
4050, 4055 w/ Cat II Hitch, 4240, 4250, 4255 w/ Cat III Hitch, 4440, 4450, 4455	Drawbar, Offset For Wide Swing Drawbar Applications 3" x 1.50" x 45.625" w/ 2" Offset, (4) 1.031" Diameter Holes: 1.656", 2.963", 5.532" & 8.581" from Front	AMR61184	\$ 240.00	
4555, 4560, 4755, 4760, 4955, 4960, (4640, 4650, 4840, 4850 - Regular and Wide Swing)	Drawbar, Offset 3" x 1.75" x 65.375" w/ Offset 1.75", (2) 1.312" Diameter Holes at 1.812" and 4.312" from Front	AMR62081	\$ 215.00	
4520, 4620, 4630, 5010, 5020, 6030, 7020, 7520	Drawbar, Offset 3" x 1.75" x 63.25" w/ 1.87" Offset, (2) 1.312" Diameter Holes: 2.73" & 4.54" from Front	AMR50984	\$ 225.00	
4520, 4620, 4630, 5010, 5020, 6030, 7020, 7520	Drawbar, Offset 3" x 1.50" x 63.25" w/ 2.25" Offset, (2) 1.312" Diameter Holes: 2.13" & 5.38" from Front	AMR36608	\$ 365.00	
5076E, 5076EL, 5082E, (5083E, 5093E BSN 440000), 5083EN, 5090E, 5090EH, 5090EL, 5093EN, 5105, 5200, 5205, 5210, 5220, 5225, 5300, 5310, 5310N, 5320, 5320N, 5325, 5325N, 5400, 5400N, 5410, 5415, 5420, 5425N, 5500, 5510N, 5520, 5520N, 5525, 5525N, 5603, 5615, 5625, 5715, 5725, 5725N	Drawbar 2.50" x 1.25" x 22.62", (1) 1.25" Diameter Hole at 1.125" from Front, (2) 11.6875" Diameter Holes at 5.125" & 9.375" from Front, (3) 0.75" Diameter Holes at 11.125", 17.6875" & 19.375" from Front	AMR105240	\$ 120.00	
5105, 5200, 5205, 5210, 5220, 5300, 5310, 5310N, 5320, 5320N, 5400, 5400N, 5410, 5420, 5420N, 5500, 5500N, 5510, 5510N, 5520, 5520N	Drawbar, Offset 2.50" x 1.25" x 29.50" w/ 2" Offset, (1) 1.25" Diameter Hole at 1.375" from Front, (2) 0.625" Diameter Hole at 5.375" & 5.50" from Front, (3) 0.75" Diameter Hole at 17.50", 19.50" & 25.75" from Front	AMR133359	\$ 175.00	
6010, 6020, 6090MC, 6090RC, 6100, 6100MC, 6100RC, 6105M, 6105R, 6110, 6110E, 6110J, 6110L, 6110M, 6110MC, 6110R, 6110RC, 6115M, 6115R, 6120, 6120L, 6120M, 6120R, 6125E, 6125J, 6125M, 6125R, 6130J, 6130M, 6130R, 6140M, 6145M, 6150M, 6200, 6200L, 6205, 6210, 6210L, 6215, 6220, 6220L, 6230, 6300, 6300L, 6310, 6310L, 6310S, 6320, 6320L, 6330, 6400, 6400L, 6405, 6410, 6410L, 6410S, 6415, 6420, 6420L, 6420S, 6430, 6500, 6500L, 6505, 6506, 6510, 6510L, 6510S, 6515, 6520, 6520L, 6530, 6600, 6605, 6610, 6615, 6620, 6630, 6715, 7130, 7230, SE6010, SE6020, SE6100, SE6110, SE6120, SE6200, SE6210, SE6220, SE6300, SE6310, SE6320, SE6400, SE6410, SE6420, SE6510, SE6520, SE6610, SE6620, Premium Models: 6230, 6330, 6430, 6530, 6534, 6630, 7130, 7230	Drawbar 39.173" Long	AML203949	\$ 260.29	

John Deere®—Tractor

Application	Description	Part Number	Retail Price	Core
6110, 6110L, 6120, 6120L, 6200, 6200L, 6210, 6210L, 6215, 6220, 6220L, 6230, 6300, 6300L, 6310, 6310L, 6310S, 6320, 6320L, 6330, 6400, 6400L, 6405, 6410, 6410L, 6410S, 6415, 6420, 6420L, 6430, 6500, 6500L, 6510L, 6510S, 6520L, 6605, 6615, 6715, 7130, 7220, 7230, 7320	Drawbar 2.50" x 1.50" x 45" w/ 1.50" Offset	AML114953	\$ 271.00	
7200, 7210, 7400, 7405, 7410, 7505, 7515, 7600, 7610, 7700, 7710, 7800, 7810	Drawbar 3" x 1.50" x 43.81" w/ 1.26" Offset	AML76093	\$ 256.00	
(8100, 8200, 8300, 8400 BSN 009999)	Drawbar Assembly, Reversible Also Includes (4) Metric Bolts	AMRE69232	\$ 717.55	
8100, 8110, 8120, 8200, 8210, 8220, 8300, 8310, 8320, 8330, 8400, 8410, 8420	Drawbar Reinforcement Not for Track or Row Crop Tractors w/ HD Drawbars	AMSS1451	\$ 533.00	
8100, 8110, 8120, 8200, 8210, 8220, 8300, 8310, 8320, 8400	Drawbar, Regular 3" x 2" x 57.75" w/ 1.78" offset	AMR130638	\$ 260.00	
8100, 8100T, 8110, 8110T, 8120, 8120T, 8130, 8200, 8200T, 8210, 8210T, 8220, 8220T, 8225R, 8230, 8230T, 8235R, 8245R, 8260R, 8270R, 8285R, 8295R, 8295RT, 8300, 8300T, 8310, 8310R, 8310RT, 8310T, 8320, 8320R, 8320RT, 8320T, 8330, 8330T, 8335R, 8335RT, 8345R, 8345RT, 8360R, 8360RT, 8370RT, 8400, 8400T, 8410, 8410T, 8420, 8420T, 8430, 8430T, 8520, 8520T, 8530	Drawbar, Offset, Heavy Duty Cat IV, 4" x 2" x 58" w/ 2.50" offset	AMR171367	\$ 630.54	
8760, 8770, 8870, 8960, 8970, 9100, 9120, 9200, 9220, 9300, 9320, 9400, 9420, 9430, 9520, 9620	Drawbar 4" x 3" x 71.5625", (1) Hole at 2.1875" from Front Replaces R115193	AMR270799	\$ 675.00	
3010, 3020, 4000, 4010, 4020, 4030 ASN 007442, 4040, 4050 All Row Crop and SN 001000-006509 w/ Hi-Crop, 4055, 4230 ASN 015452, 4240, 4250 All Row Crop and ASN 001000 w/ Hi-Crop, 4255 All Row Crop and Hi-Crop, 4320, 4430 ASN 021269, 4440, 4450, 4455	Drawbar Pin, Front	AMR56728	\$ 20.16	
4520, 4555, 4560, 4620, 4630, 4640, 4650, 4755, 4760, 4840, 4850, 4955, 4960, 5010, 5020 ASN 024038, 6030, 7020, 7520, 8430, 8440, 8450, 8630, 8640, 8650	Drawbar Pin, Front Replaces R43320	AMR62760	\$ 19.21	
5076E, 5076EF, 5076EL, 5076EN, 5082E, 5083E, 5090E, 5090EH, 5090EL, 5090EN, 5093E, 5415, 5425N, 6090M, 6100, 6100D, 6105M, 6105R, 6110, 6110D, 6110L, 6110M, 6110R, 6115D, 6115M, 6115R, 6120, 6120L, 6120M, 6120R, 6125D, 6125M, 6125R, 6130D, 6130M, 6130R, 6140D, 6140J, 6140M, 6140R, 6145M, 6145R, 6150M, 6150R, 6150RH, 6155J, 6155M, 6155R, 6155RH, 6170M, 6170R, 6175M, 6175R, 6195M, 6195R, 6200, 6200L, 6215, 6215R, 6220, 6220L, 6230, 6300, 6300L, 6310, 6310L, 6310S, 6320, 6320L, 6330, 6400, 6400L, 6403, 6405, 6410, 6410L, 6410S, 6415, 6420, 6420L, 6430, 6500, 6500L, 6505, 6510, 6510L, 6510S, 6520L, 6603, 6605, 6615, 6715, 7130, 7220, 7230, 7420, Premium Models: 6230, 6330, 6430, 7130, 7230, 7430, 7530	Drawbar Pin 1.24" Diameter, 6.87" Long Replaces AL152687	AMAL180110	\$ 38.10	
9230, 9330, 9360R, 9370R, 9410R, 9420R, 9420RX, 9430, 9430T, 9460R, 9460RT, 9470R, 9470RT, 9470RX, 9510R, 9510RT, 9520, 9520RT, 9520RX, 9530, 9530T, 9560R, 9560RT, 9570R, 9570RT, 9570RX, 9620R, 9620RX, 9630, 9630T	Drawbar Pin Cat V 2.756" Diameter, 9.953" Overall Length, 8.504" Useable Length	AMRE228327	\$ 114.15	

Prices Subject to Change without Prior Notice. The use of original equipment manufacturer (OEM) part numbers or trademarks, e.g. Case® and John Deere®, are for reference purposes only and for indicating product use and compatibility. Our company and the listed replacement parts contained herein are not sponsored, approved or manufactured by the OEM. All parts are New unless designated Reman in the description.



Drawbar Supports

Application	Description	Part Number	Retail Price	Core
920, 930, 940, 1020, 1030, 1040, 1120, 1130, 1140, 1520, 1530, 1630, 2020, 2030, 2040, 2120, 2150, 2255, 2355N, 2440, 2630, 2640, 2750, 2755, 2855N, Ind: 300B, Utility: 820, 830, 2155, 2240	Lower/Rear Drawbar Support Replaces T31725	AMT21677	\$ 72.64	
(4000, 4020 ASN 201000), 4040, 4230 ASN 040172, 4320 ASN 016080, 4430 ASN 072068	Front Drawbar Support w/o Bushings	AMAR83603	\$ 1164.64	
4000, 4020, 4040, 4040S, 4230, 4320, 4430, 4455 Mexico - w/ Standard Drawbar	Drawbar Support	AMAR33911	\$ 217.24	
4040, 4050, 4055, 4240, 4250, 4255, 4440, 4450, 4455	Rear Drawbar Support Pin	AMR65530	\$ 9.90	
(4050, 4055, 4240, 4250, 4255 - w/ Regular Drawbar)	Drawbar Support	AMAR74165	\$ 230.00	
(4050E, 4055, 4250E, 4255, 4440 - w/ Regular Drawbar), (4250, 4255, 4450, 4455 - w/ Cat III Narrow Drawbar)	Lower Drawbar Support Plate 3/4" Thick	AMR64751	\$ 62.00	
	Upper Drawbar Support Plate 1/2" Thick	AMR64752	\$ 85.00	
	Drawbar Support Spacer (2) Required per Drawbar Support	AMR64753	\$ 28.52	
4055, 4250 BSN 011451 w/ QRT or BSN 016714 w/ PST, 4255, 4450 BSN 011451 w/ QRT or BSN 016579 w/ PST, 4455	Front Drawbar Support Marked R82338 or R82339	AMRE21317	\$ 886.00	
4240, 4440	Front Drawbar Support w/o Bushings Marked R61183 or R61942	AMAR76096	\$ 1697.45	
4250, 4255, 4440, 4450, 4455	Drawbar Support Bracket, Right Hand Includes Pins Replaces R64750	AMAR96599	\$ 189.00	
	Drawbar Support Bracket, Left Hand Includes Pins Replaces R64749	AMAR96600	\$ 195.87	
5045E, 5055E, 5065E, 5075E, 5200, 5210, 5220, 5300, 5310, 5320, 5400, 5410, 5420, 5500, 5510, 5520	Drawbar Support Replaces R105240, R133359, RE42507	AMRE178644	\$ 620.00	
6800, 6810, 6820, 6900, 6910, 6910S, 6920, 6920S, 7200, 7210, 7400, 7405, 7410, 7420, 7510, 7515, 7520, 7600, 7610, 7700, 7710, 7800, 7810	Front Drawbar Support	AML76088	\$ 147.06	
7200, 7210, 7400, 7410, 7420, 7505, 7510, 7515, 7520, 7600, 7610, 7700, 7710, 7800, 7810	Rear Drawbar Support	AML76091	\$ 91.06	
7200, 7210, 7400, 7410, 7510, 7600, 7610, 7700, 7710, 7800, 7810	Drawbar Support Spacer	AML76092	\$ 36.72	
8130, (8225R, 8270R, 8295R, 8320R, 8345R BSN 053100), 8230, 8230T, 8235R, 8245R BSN 054100, 8260R, 8285R, 8295RT, 8310R, 8310RT, (8320RT, 8345RT BSN 907101), 8330, 8330T, 8335R BSN 090001, 8335RT, 8360R, 8360RT, 8430, 8430T, 8530	Upper Drawbar Strap Use w/ Regular or Cat III Drawbar	AMR218780	\$ 87.85	
8130, (8225R, 8245R, 8270R, 8295R, 8320R, 8345R BSN 053100), 8230, 8230T, 8235R, 8260R, 8285R, 8295RT, 8310R, 8310RT, (8320RT, 8345RT BSN 907101), 8330, 8330T, 8335R BSN 090001, 8335RT, 8360R, 8360RT, 8430, 8430T, 8530	Lower Drawbar Strap Use w/ Regular or Cat III Drawbar	AMR218781	\$ 148.59	
8130, 8230, 8230T, 8330, 8330T, 8430, 8430T, 8530	Drawbar Spacer	AMR218786	\$ 22.89	



Weights

Application	Description	Part Number	Retail Price	Core
4055, 4255, 4455, 4555, 4560, 4755, 4760, 4955, 4960, 6140D, 6140J, 6140M, 6140R, 6150M, 6150R, 6155J, 6165J, 6170M, 6170R, 6180J, 6190R, 6210, 6210R, 7130, 7185J, 7200, 7200R, 7205J, 7210, 7215R, 7220, 7225J, 7230, 7230R, 7260R, 7280R, 7320, 7330, 7400, 7410, 7420, 7430, 7510, 7520, 7525, 7530, 7600, 7610, 7630, 7700, 7710, 7715, 7720, 7730, 7800, 7810, 7815, 7820, 7830, 7920, 7930, 8100, 8110, 8120, 8130, 8200, 8210, 8220, 8225R, 8230, 8235R, 8245R, 8260R, 8270R, 8285R, 8295R, 8300, 8310, 8310R, 8320, 8330, 8335R, 8345R, 8360R, 8400, 8410, 8420, 8430, 8520, 8530, 8570, 8770, 8870, 8970, 9100, 9120, 9200, 9220, 9230, 9300, 9320, 9330, 9360R, 9400, 9410, 9410R, 9420, 9430, 9430T, 9460R, 9460RT, 9510R, 9520, 9530, 9530T, 9560R, 9560RT, 9620, 9630, 9630T	Wheel Weight, 165 lbs	AMR167153	\$ 225.00	
3055, 3150, 3155, 3255, 4050, 4055, 4250, 4255, 4450, 4455, 4555, 4560, 4650, 4755, 4760, 4850, 4955, 4960, 6200, 6200L, 6300, 6300L, 6400, 6400L, 6500, 6500L, 7200, 7400	Front Suitcase Weight, 100 lbs	AMR58823	\$ 105.00	
6110, 6120, 6210, 6220, 6310, 6320, 6410, 6420, 7200, 7210, 7220, 7320, 7400, 7410, 7420, 7510, 7520, 7600, 7610, 7700, 7710, 7720, 7800, 7810, 8100(T), 8110(T), 8120(T), 8200(T), 8220(T), 8300(T), 8310(T), 8320(T), 8400(T), 8410(T), 8420(T), 8520(T), 9100, 9120, 9200, 9220, 9300, 9320, 9400, 9420, 9520	Front Suitcase Weight, 100 lbs	AMR127764	\$ 125.00	
4250, 4255, 4440, 4450, 4455, 4555, 4560, 4640, 4650, 4755, 4760, 4840, 4850, 4955, 4960, 5225, 5325, 5325N, 5425, 5425N, 5525, 5525N, 6110(L), 6120(L), 6210(L), 6220(L), 6310(L)(S), 6320(L), 6410(L)(S), 6420(L), 6510S, 6520L, 7200, 7210, 7220, 7320, 7400, 7410, 7420, 7510, 7520, 7600, 7610, 7700, 7710, 7720, 7800, 7810, 7820, 7920, 8100(T), 8110(T), 8120(T), 8200(T), 8210(T), 8220(T), 8300(T), 8320(T), 8400(T), 8420(T), 8520(T), 9100, 9120, 9200, 9220, 9300(T), 9320(T), 9400(T), 9420(T), 9520(T), 9620	Rear Weight, 495 lbs	AMR167152	\$ 595.00	

Hammer Straps

Application	Description	Part Number	Retail Price	Core
1530, 2010, 2020, 2030, 2150, 2155, 2240, 2255, 2350, 2355, 2355N, 2440, 2550, 2555, 2630, 2640, 2755, 2855N, 5045D, 5045E, 5055D, 5055E, 5065E, 5075E, 5083E, 5083E Limited, 5083EN, 5085E, 5090E, 5093E, 5093E Limited, 5093EN, 5100E, 5101E, 5101E Limited, 5101EN, 5105, 5200, 5205, 5210, 5220, 5225, 5300, 5310, 5320, 5320N, 5325, 5325N, 5400, 5410, 5420, 5420N, 5425, 5500, 5510, 5520, 5520N, 5525, 5525N, 5603, 5625, Utility: 2040	Hammer Strap 0.75" Thick	AMT29899	\$ 74.43	
2510, 2520, 3010, 3020, 4010, 4020, 4030, 4040, 4230, 4320, 4430	Hammer Strap 1 5/32" Hole	AMR26584	\$ 88.00	
2840, 2940, 2955, 3040, 3140 ASN 430000, 3150, 3155	Hammer Strap 1 9/32" Hole	AMR78387	\$ 85.00	
4050, (4050, 4250 - Hi Crop), 4250, 4450, 4555, 4560, 4620, 4630, 4640, 4650, 4755, 4760, 4840, 4850, 4955, 4960, 5010, 5020 ASN 025000, 6030, 7020, 7520, 8430, 8630	Hammer Strap 1 7/16" Hole, 3 1/2" Offset, 3 1/2" Drawbar Opening	AMR80447	\$ 165.00	
4055, 4240, 4255, 4440, 4455, 4520, 4620, 4630, 5010, 5020, 6030, 7020, 7520	Hammer Strap 1 9/32" Hole, 2" Offset	AMR78214	\$ 150.00	
4520, 4620, 4630, 4640, 4650, 4840, 4850, 5020 ASN 025000, 6030, 7520, 8430, 8630	Hammer Strap 1 7/16" Hole, 2 1/2" Offset	AMRE19377	\$ 265.00	

John Deere®—Tractor

Application	Description	Part Number	Retail Price	Core
6105M, 6105R, 6110, (6110M, 6120M, 6130M, 6145M - MY18 w/ 38 mm Offset Drawbar), 6110R, 6115M, 6120, 6120L, 6125M, 6125R, 6130R, 6140M, 6200, 6200L, 6210, 6215, 6220, 6220L, 6230, 6300, 6300L, 6310, 6310L, 6310S, 6320, 6320L, 6330, 6400, 6400L, 6410, 6410L, 6410S, 6415, 6420, 6420L, 6430, 6500, 6510S, 6520L, 6615, 6715, 7130, 7220, 7230, 7320, Premium Models: 6230, 6330, 6430, 7130, 7230	Hammer Strap Spacer 4.75" Long, 1.50" Wide, 1.75" Tall	AML79895	\$ 54.26	
6110, 6120, 6200, 6210, 6215, 6220, 6300, 6310, 6320, 6400, 6405, 6410, 6415, 6420, 6500, 6605, 6615, 6715, 7220, 7320	Hammer Strap	AML78501	\$ 60.03	
6800, 6810, 6900, 6910, 6910S, 7200, 7210, 7330, 7400, 7405, 7410, 7420, 7510, 7520, 7600, 7610, 7630, 7700, 7710, 7720, 7730, 7800, 7810, 7815, 7820, 7830, 7920, 7930, 8100, 8100T, 8110, 8110T, 8120, 8120T, 8130, 8200, 8200T, 8210, 8210T, 8220, 8225R, 8230, 8245R, 8270R, 8295R, 8295RT, 8300, 8300T, 8310, 8310T, 8320, 8320R, 8320RT, 8320T, 8330T, 8345R, 8345RT, 8400, 8400T, 8410, 8410T, 8420, 8420T, 8430 (2006-09), 8430T, 8520, 8520T, 8530, Premium Models: 7330, 7430, 7530	Hammer Strap	AMR88665	\$ 99.50	
7630, 7720, 7730, 7820, 7830, 7920, 7930, 8110, 8110T, 8120, 8120T, 8130, 8210, 8210T, 8220, 8220T, 8225R, 8230, 8230T, 8245R, 8270R, 8295R, 8295RT, 8310, 8310T, 8320, 8320R, 8320RT, 8320T, 8330, 8330T, 8345R, 8345RT, 8400, 8410T, 8420, 8420T, 8430T	Hammer Strap	AMR132544	\$ 115.00	
8570, 8770, 8870, 8960, 8970, 9100, 9120, 9200, 9220, 9300(T), 9320(T), 9400(T), 9420(T), 9520(T), 9620(T)	Hammer Strap	AMR110306	\$ 155.00	
7200R, 7210R, 7215R, 7230R, 7250R, 7260R, 7270R, 7280R, 7290R, 7310R, 7630, 7720, 7730, 7815, 7820, 7830, 7920, 7930, 8100, 8110, 8110T, 8120, 8120T, 8130, 8200, 8210, 8210T, 8220, 8220T, 8225R, 8230, 8230T, 8245R, 8270R, 8295R, 8295RT, 8300, 8310, 8310T, 8320, 8320R, 8320RT, 8320T, 8330, 8330T, 8345R, 8345RT, 8400, 8410T, 8420, 8420T, 8430T	Clevis Assembly Includes R156615 Retainer and Hardware Replaces RE159503	AMRE575227	\$ 264.50	
7630, 7720, 7730, 7820, 7830, 7920, 7930, 8100, 8110, 8110T, 8120, 8120T, 8220, 8220T, 8225T, 8230, 8230T, 8245R, 8270R, 8295T, 8295RT, 8300, 8310, 8310T, 8320, 8320R, 8320RT, 8320T, 8330, 8330T, 8345R, 8345RT, 8400, 8410T, 8420, 8420T, 8430T	Retainer Use w/ AMR132544 Hammer Strap	AMR156615	\$ 65.08	

Rockshafts and Components

Application	Description	Part Number	Retail Price	Core
5045D, 5045E, 5055D, 5055E, 5065E, 5075E, 5076E, 5076EF, 5076EL, 5082E, 5083EN, 5085E, 5090E, 5090EH, 5090EL, 5093EN, 5103, 5203, 5403, 5415, 5425 BSN 002632, 5425N, 5615, 5625 BSN 001689, 5715, 5725 BSN 005048, 5725N, 6100E, 6100EN	Rockshaft	AMR105156	\$ 860.00	
6110, 6110L, 6120, 6120L, 6140J, 6155J, 6210, 6210L, 6215L, 6220, 6220L, 6310, 6310L, 6310S, 6320, 6320L, 6405, 6410, 6410L, 6410S, 6415L, 6420, 6420L, 6510L, 6510S, 6520L, 6605, 6615, 6715	Rockshaft Replaces L168344	AML154161	\$ 795.00	
6110, 6110L, 6200, 6200L, 6210, 6210L, 6300, 6300L, 6310, 6310L, 6310S, 6400, 6400L, 6405, 6410, 6410S, 6500, 6500L, 6510L, 6510S, 6605	Rockshaft	AML152475	\$ 340.00	

John Deere®—Tractor

Application	Description	Part Number	Retail Price	Core
6200, 6200L, 6300, 6300L, 6400, 6400L, 6500, 6500L	Rockshaft	AML76099	\$ 550.00	
7200, 7210, 7400, 7410, 7510	Rockshaft Replaces R126709, R134097	AMR111550	\$ 790.00	
(7600, 7800 ASN 006444), 7610 BSN 089999, 7700 ASN 007549, 7710, 7810	Rockshaft	AMR117816	\$ 550.00	
5075M, 5080R, 5080RN, 5090M, 5090R, 5090RN, 5100M, 5100MH, 5100ML, 5100R, 5100RN, 5115M, 5115ML, 5115R, 5125R, 6090MC, 6090RC, 6100, 6100D, 6100E, 6100J, 6100MC, 6100RC, 6105D, 6105E, 6105J, 6105M, 6105MC, 6105R, 6105RC, 6110, 6110B, 6110D, 6110E, 6110J, 6110L, 6110M, 6110MC, 6110R, 6110RC, 6115D, 6115J, 6115M, 6115MC, 6115R, 6115RC, 6120, 6120B, 6120E, 6120L, 6120M, 6120R, 6125D, 6125E, 6125J, 6125M, 6125R, 6130, 6130D, 6130J, 6130M, 6130R, 6135E, 6135J, 6135M, 6135R, 6140D, 6140J, 6140JH, 6140M, 6145M, 6150M, 6155J, 6155JH, 6200, 6200L, 6205, 6210, 6210L, 6215, 6220, 6220L, 6230, 6300, 6300L, 6310, 6310L, 6310S, 6320, 6320L, 6330, 6400, 6400L, 6405, 6410, 6410L, 6410S, 6415, 6420, 6420L, 6420S, 6430, 6500, 6500L, 6505, 6506, 6510, 6510L, 6510S, 6515, 6520, 6520L, 6605, 6610, 6615, 6715, 7130, 7220, 7230, 7320, 7330, 7420, 7515, 7520, Premium Models: 6230, 6330, 6430, 7130, 7230, 7330	Rockshaft Bushing 3.091" Long, 2.572" ID, 2.764" OD 2.933" Flange Diameter, 0.138" Flange Height	AML79234	\$ 44.38	
(6110, 6110L, 6210, 6210L, 6310, 6310L, 6310S, 6405, 6410, 6410L, 6410S, 6505, 6510L, 6510S BSN 291142), (6200, 6200L, 6300, 6300L, 6400, 6400L, 6500, 6500L ASN 187952)	Rockshaft Lift Arm, Upper	Right Hand Left Hand	AML114582 AML114581	\$ 135.00 \$ 135.00
(6110, 6110L, 6210, 6210L, 6310, 6310L, 6310S, 6405, 6410, 6410L, 6410S, 6510L, 6510S, 6605 ASN 291143), (6120, 6120L, 6215, 6220, 6220L, 6320, 6320L, 6420, 6420L, 6520L, 6615, 6715 BSN 402759), 6415, 7220, 7320	Rockshaft Lift Arm, Upper	Right Hand Left Hand	AML116616 AML116615	\$ 135.00 \$ 135.00
6150M, 7330, 7420, 7520	Rockshaft Lift Arm, Upper Replaces L116397	Right Hand	AML166977	\$ 445.00
	Rockshaft Lift Arm, Upper Replaces L116396	Left Hand	AML166976	\$ 445.00
(6200, 6200L, 6300, 6300L, 6400, 6400L, 6500, 6500L BSN 187951)	Rockshaft Lift Arm, Upper	Right Hand Left Hand	AML77719 AML77718	\$ 200.00 \$ 200.00
6320, 6420	Rockshaft Lift Arm, Cat III Replaces L156595, L157535	Right Hand	AML157537	\$ 415.00
	Rockshaft Lift Arm, Cat III Replaces L156596, L157536	Left Hand	AML157538	\$ 415.00
(6410, 6410L, 6510L BSN 291307)	Rockshaft Lift Arm, Cat III Replaces L79947	Right Hand	AML114584	\$ 135.00
	Rockshaft Lift Arm, Cat III Replaces L79946	Left Hand	AML114583	\$ 135.00
7405, 7500	Rockshaft Lift Arm, Upper	Right Hand	AMR126713	\$ 465.00
(7600, 7800 ASN 006444), 7610 BSN 089999, 7700 ASN 007549, 7710, 7810	Rockshaft Lift Arm, Upper	Right Hand	AMR117819	\$ 350.00
	Rockshaft Lift Arm, Upper	Left Hand	AMR117818	\$ 350.00

John Deere®—Tractor

Application	Description	Part Number	Retail Price	Core
7200R, 7210R, 7215R, 7230R, 7250R, 7260R, 7270R, 7280R, 7290R, 7310R, 7R 210, 7R 230, 7R 250, 7R 270, 7R 290, 7R 310, 7R 330, 7R 350, 8130, 8225R, 8230, 8230T, 8235R, 8245R, 8260R, 8270R, 8285R, 8295R, 8310R, 8310RT, 8320R, 8320RT, 8330, 8330T, 8335R, 8335RT, 8345R, 8345RT, 8360R, 8360RT, 8430, 8430T, 8530, 8R 230, 8R 250, 8R 280, 8R 310, 8R 340, 8R 370, 8R 410, 8RT 310, 8RT 340, 8RT 370, 8RT 410, 8RX 310, 8RX 340, 8RX 370, 8RX 410	Rockshaft Lift Arm Rockshaft Lift Arm	Right Hand Left Hand	AMR218918 AMR218917	\$ 550.00 \$ 550.00
6120, 6120L, 6200, 6200L, 6220, 6220L, 6300, 6300L, 6320, 6320L, 6400, 6400L, 6405, 6420, 6420L, 6420S, 6500, 6500L, 6520L, 6605, 7220, 7320, 7420, 7520	Rockshaft Control Valve		AMAL110266	\$ 950.00
6120, 6120L, 6200, 6200L, 6215, 6220, 6220L, 6300, 6300L, 6320, 6320L, 6400, 6400L, 6415, 6420, 6420L, 6500, 6500L, 6520, 6520L, 6615, 6715, 7220, 7320, 7420, 7520	Rockshaft Control Valve Spacer		AMAL161388	\$ 312.32
2510, 3010, 3020 BSN 123000	Rockshaft Control Cable		AMAR26810	\$ 91.99
4010, 4020 BSN 201000	Rockshaft Control Cable 57.50" Long		AMAR26712	\$ 92.89
7200, 7210, 7400, 7410, 7510, 7600 ASN 006378, 7610, 7700, 7710, 7800 ASN 010901, 7810	Hydraulic Lift Cylinder Seal Kit For 70 mm Lift Cylinder		AMAH136332	\$ 47.46



Lift Link Assemblies and Components

Application	Description	Part Number	Retail Price	Core
520, 530, 620, 630, 720, 730	Adjustable Upright Lift Link Assembly	AM2CYLLL	\$ 275.00	
1020, 1520, 1530, 2020, 2030, 2040, 2255, 2350, 2355, 2440, 2550, 2555, 2630, 2640, 2750, 2755, 2840, 2855, Utility: 820, 830, 2155, 2240	Non-Adjustable Lift Link, Left Hand Use w/ Telescoping 3-Point Pull Arms Components:	AMAR44556	\$ 75.00	
	Lift Link Rod, 19 1/4"	1 AMT24909	\$ 80.00	
	Lower Lift Yoke	1 AMR48595	\$ 40.00	
1020, 1520, 1530, 2020, 2030, 2040, 2255, 2350, 2355, 2440, 2550, 2555, 2630, 2640, 2750, 2755, 2840, 2855, Utility: 820, 830, 2155, 2240	Adjustable Lift Link w/ Yoke, Right Hand Use w/ Telescoping 3-Point Pull Arms Components:	AMAR44552	\$ 125.00	
	Upper Assembly	1 AML28374-15	\$ 140.00	
	Lower Lift Yoke	1 AMR48595	\$ 40.00	
1020, 1520, 1530, 2020, 2030, 2040, 2255, 2350, 2355, 2440, 2550, 2555, 2630, 2640, 2750, 2755, 2840, 2855, Utility: 820, 830, 2155, 2240	Adjustable Lift Link w/o Yoke, Right Hand Use w/ Telescoping 3-Point Pull Arms Components:	AML28374-15	\$ 140.00	
	Upper Housing	1 AML33535	\$ 35.00	
	Housing Shaft	1 AMT21558	\$ 6.00	
	Lift Link Rod, 15"	1 AMT24908	\$ 21.00	
	Lift Linkage Handle	1 AMT21559	\$ 12.00	
	Ball, Pivot	1 AMT22399	\$ 18.00	
	Lift Rod Ball, Upper	1 AMT21901	\$ 8.50	
	Adapter Nut	1 AMT21758	\$ 9.50	

John Deere®—Tractor

Application	Description	Part Number	Retail Price	Core
1020, 1520, 1530, 2020, 2030, 2040, 2255, 2350, 2355, 2440, 2550, 2555, 2630, 2640, 2750, 2755, 2840, 2855, Utility: 820, 830, 2155, 2240	Non-Adjustable Lift Link, Left Hand Use w/ Non-Telescoping 3-Point Pull Arms Components:	AMAR44554	\$ 145.00	
	Lift Link Rod, 21 3/4"	1 AMT25836	\$ 107.93	
	Lower Lift Yoke	1 AMR48595	\$ 40.00	
1020, 1520, 1530, 2020, 2030, 2040, 2255, 2350, 2355, 2440, 2550, 2555, 2630, 2640, 2750, 2755, 2840, 2855, Utility: 820, 830, 2155, 2240	Adjustable Lift Link w/ Yoke, Right Hand Use w/ Non-Telescoping 3-Point Pull Arms Components:	AMAR44551	\$ 132.00	
	Upper Assembly	1 AML28374-17	\$ 140.00	
	Lower Lift Yoke	1 AMR48595	\$ 40.00	
1020, 1520, 1530, 2020, 2030, 2040, 2255, 2350, 2355, 2440, 2550, 2555, 2630, 2640, 2750, 2755, 2840, 2855, Utility: 820, 830, 2155, 2240	Adjustable Lift Link w/o Yoke, Right Hand 17.50" Long, Use w/ Non-Telescoping 3-Point Pull Arms Components:	AML28374-17	\$ 140.00	
	Upper Housing	1 AML33535	\$ 35.00	
	Housing Shaft	1 AMT21558	\$ 6.00	
	Lift Link Rod, 17 1/2"	1 AMT25835	\$ 20.00	
	Lift Linkage Handle	1 AMT21559	\$ 12.00	
	Lift Rod Ball, Upper	1 AMT21901	\$ 8.50	
	Ball, Pivot	1 AMT22399	\$ 18.00	
	Adapter Nut	1 AMT21758	\$ 9.50	
5065M, (5075M, 5100M - iT4), 5085M Tier 3 and iT4, 5095MH, 5100MH, (5100ML, 5115ML FT4), 5105ML, 5115M	Adjustable Lift Link, Right Hand Heavy Duty	AMRE245477	\$ 135.00	
6105M, 6115M, 6125M, 6140M (iT4), 7130, 7230, Premium Models: 6230, 6330, 6430	Adjustable Lift Link, Left Hand - Cat III Replaces AL221504	AMAL200842	\$ 145.00	
6170R, 6175M (Prior to MY20), (6175R, 6195R, 6215R - Final Tier 4 and MY18 Final Tier 4 BSN 034091), 6190R, 6210R	Adjustable Lift Link Right or Left Hand Replaces AL229259	AMAL218721	\$ 225.00	
2510, 3010, 3020, 4010, 4020 BSN 200999	Adjustable Lift Link Assembly Replaces Right or Left Hand Components:	AMAR44555	\$ 275.00	
	Upper Yoke	1 AMR26613	\$ 100.00	
	Lower Lift Yoke	1 AMR26615	\$ 90.00	
	Knuckle	1 AMAR26691	\$ 62.89	
	Lift Link Rod	1 AMR26611	\$ 43.00	
	Adjusting Handle	1 AMT13858	\$ 17.00	
	Adjusting Shaft	1 AMT13859	\$ 52.88	
4030, 4040, 4230	Adjustable Lift Link Assembly Replaces Right Hand or Left Hand Components:	AMX7410101	\$ 165.00	
	Eyebolt	1 AMAR81096	\$ 176.15	
	Arrester	1 AMR51897	\$ 8.81	
	Link Body	1 AMRE49601	\$ 65.00	
	Lift Link Rod, 12 1/8"	1 AMR52353	\$ 90.00	
	Yoke	1 AMR109981	\$ 100.00	

John Deere®—Tractor

Application	Description	Part Number	Retail Price	Core
4050, 4055, 4240, 4250, 4255	Lift Link Assembly 1" Pin Hole Diameter	AMAR44558	\$ 259.66	
	Components:			
	Eyebolt	1 AMAR69831	\$ 97.79	
	Arrester	1 AMR51897	\$ 8.81	
	Link Body	1 AMRE49601	\$ 65.00	
	Lift Link Rod, 14 5/8"	1 AMR109978	\$ 77.86	
	Yoke	1 AMR109981	\$ 100.00	
4430	Adjustable Lift Link Assembly Replaces Right Hand or Left Hand	AMX7410102	\$ 165.00	
	Components:			
	Eyebolt	1 AMAR81096	\$ 176.15	
	Arrester	1 AMR51897	\$ 8.81	
	Link Body	1 AMRE49601	\$ 65.00	
	Lift Link Rod, 14 5/8"	1 AMR109978	\$ 77.86	
	Yoke	1 AMR109981	\$ 100.00	
4240, 4050, 4250, 4055, 4255	Adjustable Lift Link Assembly Replaces Right Hand or Left Hand	AMX7410103	\$ 165.00	
	Components:			
	Eyebolt	1 AMAR69831	\$ 97.79	
	Arrester	1 AMR51897	\$ 8.81	
	Link Body	1 AMRE49601	\$ 65.00	
	Lift Link Rod, 14 5/8"	1 AMR109978	\$ 77.86	
	Yoke	1 AMR109981	\$ 100.00	
6105M, 6105R, 6110M, 6110R, 6115M, 6115R, 6120M, 6120R, 6125M, 6125R, 6130M, 6130R, 6140M, 6145M, 6145R, 6155M, 6155R, 6155RH, 6175M, 6175R, 6195M, 6195R, 6215R, 6230, 6330, 6430, 7130, 7230	Stabilizer Link	AMAL227513	\$ 245.00	
2510, (3020, 4020 Early)	Lift Link Rod 38 5/16"	AMR34476	\$ 60.00	



Quick Hitches and Components

Application	Description	Part Number	Retail Price	Core
Cat II	Quick Hitch, 4" x 6" Beam 36" Wide, Includes 1 1/8" Mounting Pins and Adapter Bushings	AMX741020	\$ 565.00	
Cat III	Quick Hitch, 4" x 6" Beam 38" Wide, Includes 1 7/16" Mounting Pins	AMX741022	\$ 565.00	
Cat III	Quick Hitch, 4" x 6" Beam 44" Wide, Includes 1 7/16" Mounting Pins	AMX741021	\$ 565.00	
4250, 4255, 4440, 4450, 4455, 4520, 4555, 4620, 4630 ASN 013121, 4640, 4650, 4755, 4760, 4840, 4850, 4955, 4960, 5010, 5020, 6030, 7020, 7520, 7700, (7710, 7810 BSN 089999), 7800, 8100, 8100T, 8200, 8200T, (8210, 8310, 8410 BSN 015383), (8210T, 8310T, 8410T BSN 902643), 8300, 8300T, 8400, 8400T, 8430, 8440, 8450, 8630, 8640, 8650	Shield For Quick Hitch	AMR58617	\$ 25.00	

John Deere®—Tractor

Application	Description	Part Number	Retail Price	Core
4555, 4560, 4650, 4755, 4760, 4850, 4955, 4960, 6140R, 6145R, 6150R, 6150RH, 6155R, 6155RH, 6170R, 6175R, 6190R, 6195R, 6210R, 6215R, (7200R, 7215R, 7260R, 7280R BSN 080000), (7210R, 7250R, 7270R, 7290R, 7310R ASN 080001), 7230R, 7430, 7530, 7600, 7610 BSN 089999, 7630, 7700, 7710, 7720, 7730, 7800, 7810, 7820, 7830, 7920, 7930, 8100, 8100T, 8110, 8110T, 8120, 8120T, 8130, 8200, 8200T, 8210, 8210T, 8220, 8220T, (8225R, 8245R, 8270R, 8310R, 8320R SN 000101-053099), 8230, 8230T, (8235R, 8260R, 8285, 8335R, 8360R SN 016001-090000), 8295R SN 000101-053099 and ASN 090001, (8295RT, 8320RT, 8345RT SN 900101-907100), 8300, 8300T, 8310, (8310RT, 8335RT, 8360RT SN 902501-912000), 8310T, 8320, 8320T, 8330, 8330T, 8370RT ASN 912001, 8400, 8400T, 8410T, 8420, 8420T, 8430, 8430T, 8520, 8520T, 8530, 8630	Shield For Quick Hitch	AMR161319	\$ 35.00	

Lower Lift Links



Application	Description	Part Number	Retail Price	Core
520, 530, 620, 630, 720, 730	Inner Pull Arm, Front Telescoping Style	Right Hand	AMAF2714R	\$ 195.00
		Left Hand	AMAF2715R	\$ 195.00
	Outer Pull Arm, Rear Telescoping Style Use w/ AMAF2714R or AMAF2715R Inner Pull Arm to Complete Assembly	Right or Left Hand	AMAF2716R	\$ 85.00
1020, 1520, 2020, 2030, 2040, 2630, 2640, Ind: 300B BSN 362024, Utility: 820, 2240	Inner Pull Arm, Front Telescoping Style	Right Hand	AMAT30150	\$ 370.48
		Left Hand	AMAT30151	\$ 358.21
1020, 1520, 2020, 2030, 2040, 2350, 2355, 2510, 2520, 2550, 2555, 2630, 2640, 2750, 2755, 2855, 3010, 3020, 4030, Ind: 300B, Utility: 820, 2240	Outer Pull Arm, Rear Telescoping Style Use w/ AMAL26678, AMAL26679, AMAR32547, AMAR32548, AMAT30150 or AMAT30151 Pull Arm to Complete Assembly	Right or Left Hand	AMAR28570	\$ 185.00
820, 830, 1020, 1520, 1530, 2020, 2030, 2040, 2155, 2240, 2255, 2350, 2355, 2550, 2555, 2630, 2640, 2750, 2755, 2855, Ind: 300B, 301, 301A, 302, 302A, 400, 401B, 401C, 401D	Pull Arm, Cat II, HD Non-Telescoping Flat Style 33.50" Long (Center-to-Center)	Right or Left Hand	AMAR77530	\$ 290.00
940, 1040, 1120, 1130, 1140, (1640, 1840, 2040, 2040S BSN 429999), 2030, 2130, 2140, (2440, 2640 ASN 341000), 2350, 2355, 2550, 2555, 2650, 2750, 2755, 2855, Ind: 300B ASN 362025, Utility: 2240 ASN 341000	Inner Pull Arm, Front Telescoping Style	Right Hand	AMAL26679	\$ 318.24
940, 1040, 1120, 1130, 1140, (1640, 1840, 2040, 2040S BSN 429999), 2030, 2130, 2140, (2240, 2440, 2640 ASN 341000), 2350, 2355, 2550, 2555, 2650, 2750, 2755, 2855, Ind: 300B ASN 362025	Inner Pull Arm, Front Telescoping Style	Left Hand	AMAL26678	\$ 325.36
2510, 2520, 3010, 3020, 4030	Inner Pull Arm, Front Telescoping Style	Right Hand	AMAR32547	\$ 270.00
		Left Hand	AMAR32548	\$ 270.00
2840, 4000, 4010, 4020, 4040, 4050, 4230, 4240, 4250, 4320, 4430	Pull Arm End, Cat II	Right Hand	AMRE44093	\$ 145.00
		Left Hand	AMRE44094	\$ 145.00

John Deere®—Tractor

Application	Description	Part Number	Retail Price	Core
2510, 2520, 2840, 2940, 2950, 2955 BSN 767516, 3020, (3030, 3130 ASN 166430), (3040, 3140 ASN 430000), 3055, 3120, 4000 ASN 201000, 4020, 4040, 4040S, 4240S (BSN 347554), 4050, 4055, 4230, 4240, 4250, 4255, 4430	Pull Arm Latch Replaces AR30288, AR69317	AMAR90082	\$ 50.87	
6105M, 6105R, 6110M, (6110R, 6120R, 6130R, 6145R, 6155R, 6155RH, 6195R, 6215R - FT4 MY18), 6115M, 6115R, (6120M, 6130M, 6145M, 6155M - FT4 MY15 and Later), 6125R, 6140J, 6140M, 6155J, 6170R, (6175M, 6195M - FT4 MY18 and Later), 6175R, 6190R, 6210R, 6250R, 6320, 6330, 6420, 6430, 7130, 7200R, 7210R, 7215R, 7230, 7230R, 7250R, 7260R, 7270R, 7280R, 7290R, 7310R, 7330, 7630, 7720, 7730, 7820, 7830, 7920, 7930, 8120, 8220, 8225R ASN 119999, 8235R, (8245R, 8270R, 8320R, 8345R ASN 090000), 8260R, 8285R, 8295R, 8310R, 8320, (8320RT, 8345RT ASN 912000), 8335R, 8360R, 8370R, 8370RT, 8400R, 8420, 8520, 7R 210, 7R 230, 7R 250, 7R 270, 7R 290, 7R 310, 7R 330, 8R 230, 8R 250, 8R 280, 8R 310, 8R 340, 8R 370, 8R 410, 8RT 310, 8RT 340, 8RT 370, 8RT 410, 8RX 310, 8RX 340, 8RX 370, 8RX 410, Premium Models: 6330, 6430, 7130, 7230, 7330, 7430, 7530	Pull Arm Latch, CAT III For Flat/Hook Style Pull Arm Replaces 3903314M91, 86017137, CH167802	Right or Left Hand AMAL117727	\$ 60.00	
6105M, 6110M, 6110R, 6115M, 6120, (6120R, 6130M, 6130R FT4 MY15 - 6120M), 6120L, 6125M, 6220, 6220L, 6230, 6320m 6320L, 6330, 6420, 6420L, 6430, 6520L, Premium Models: 6230, 6330, 6430	Pull Arm Latch, Cat II For Flat/Hook Style Pull Arm Replaces 3904032M91, 33471600	Right or Left Hand AMAL117720	\$ 55.00	
(6100D, 6115D, 6130D BSN 050000), 6105M, 6115M, 6120, 6120L, 6125M, 6220, 6220L, 6230, 6320, 6320L, 6330, 6420, 6420L, 6430, 6520L	Draft Link Hook-Style	Right Hand Left Hand AMAL163906 AMAL163905	\$ 191.00 \$ 191.00	
2510, 2520, 3010, 3020, 4020	Draft Link Support, Hi-Crop	AMAR33952	\$ 250.00	
2955, 3055, 3150, 3155, 3255, 4250, 4255, 4450, 4455, 7200, 7210, 7330, 7330, 7405, 7410, 7420, 7505, 7510, 7520, 7600, 7610, 7700, 7710, 7800, 7810, Premium Models: 7400, 7430, 7530	Rear Draft Link Lock Replaces AR74179, AR90084	AMRE11578	\$ 54.64	

Load Sensing Shafts

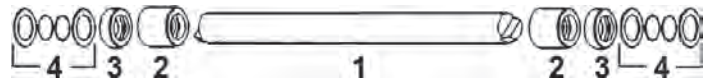

Application	Img Ref #	Description	Part Number	Retail Price	Core
(1640, 2040, 2040S, 2140, 2350, 2550, 2750 ASN 529512), 1830, 2030	NI	Load Control Shaft Kit Includes (1) Load Control Shaft, (2) Bushings with O-Rings, (2) Sealing Rings (4) Load Control Washers, (2) Load Sensing Bushings, (2) Draft Link Bushing Pins and (2) Spring Clamps	AMAL40976	\$ 110.00	

John Deere®—Tractor

Application	Img Ref #	Description	Part Number	Retail Price	Core
840, 940, 1020, 1030, 1040, 1120 ASN 42624, 1130, 1140, (1350, 1550, 1750, 1850, BSN 651779), 1530, 1650, 2040, 2150, 2255, Ind: (300, 301 ASN 135288), 300B, 301A BSN 715670, Utility: 2155 BSN 651779, 2240	1	Load Sensing Shaft 19.69" Long, 0.815" Diameter Replaces T26598	AML26932	\$ 57.50	
1020, (1520, 1530 SN 178601- 179600), 2010, 2020, 2030, 2440	2	Load Control Bushing	AMR47061	\$ 15.43	
(1520, 1530 SN 178601-179600), 2020, 2030, 2120, 2440	NI	Load Control Bushing, Outer Replaces L26939	AMT22096	\$ 9.04	
1520, 1530 SN 178601-179600, 2020, 2030, 2120, 2440, Ind: 400, 401, 401B, 401C, 401D BSN 715640	NI	Load Control Seal Washer Use w/ AML26937 Load Control Shaft	AMT22095	\$ 2.62	
1520, 1530, 2020, 2030, 2120, 2440, Ind: 400, 401 ASN 134706, (401B, 401D BSN 715670), 401C	1	Load Control Shaft 19.46" Long, 0.877" OD	AML26937	\$ 112.00	
2140, 2650, 2840, 2850, 2940, (2950, 3140, 3040 ASN 531762), 2955, 3030, 3050, 3055, 3130, 3255, 3350	1	Load Control Shaft, 22.75" Long, 1.102" Diameter	AML41819	\$ 96.00	
	2	Bushing w/ O-Ring	AML41196	\$ 15.69	
	3	Sealing Ring	AML55844	\$ 4.12	
	NI	Load Control Washer	AML41154	\$ 1.42	
	NI	Bushings, Load Sensing	AML41788	\$ 13.00	
2510, 2520, 3010, 3020, 4030, Ind: 500	1	Load Sensing Shaft, 20.937" Long, 1" Diameter	AMR33883	\$ 93.55	
	2	Bushing, w/ O-Ring	AMR27018	\$ 16.48	
	3	Load Control Seal	AMAR27371	\$ 6.05	
	4	Load Control Shims	AMR66425	\$ 18.10	
2630, 2640	1	Load Control Shaft 19.44" Long, 0.93" Diameter	AMR54217	\$ 231.05	
	2	Bushing w/ O-Ring	AMR54220	\$ 24.22	
(4000, 4020 BSN 250000), 4010, Ind: 600	1	Load Sensing Shaft, 21.62" Long, 1.124" Diameter	AMR33826	\$ 96.36	
(4000, 4020 BSN 250000), 4010, Ind: 600	2	Bushing w/o O-Ring - 2 Required	AMR26505	\$ 17.54	
	3	Load Control Seal - 2 Required	AMAR84792	\$ 6.05	
(4000, 4020 BSN 250000), 4010, 5020, Ind: 700A	4	Shim Kit Use w/ AMR33826 and AMR46513 Load Sensing Shafts Includes (2) F2674R Washers, (1) R47568 Washer, (1) R47567 Washer and (2) R47566 Washers	AMX741036	\$ 16.66	
(4000, 4020 ASN 250001), 4040, 4230, 4240, 4320, 4430, 4440	1	Load Sensing Shaft, 21.187" Long, 1.124" Diameter	AMR46513	\$ 57.73	
	2	Bushing w/ O-Ring Includes R53177 Back Up Ring and R53180 O-Ring	AMAR54481	\$ 32.00	
4000, 4020 ASN 200999, 4040, 4230, 4240, 4320, 4430, 4440	2	Load Control Bushing Replaces R41084	AMR71476	\$ 23.24	
4040S, 4050, 4055, 4240S, 4250, 4255, 4350, 4450, 4455	1	Load Sensing Shaft 24.25" Long, 1.186" Diameter	AMR71375	\$ 131.44	
4450, 4455	NI	Bushing Support, Load Sensing Shaft	AMAR104003	\$ 202.15	

John Deere®—Tractor

Application	Img Ref #	Description	Part Number	Retail Price	Core
4520, 4620, 7020 BSN 002699, 7520 BSN 001571	1	Load Control Shaft 20.06" Long, 1.30" OD	AMR43318	\$ 293.77	
	2	Load Control Bushing For use w/ R46680 or R46960 Transmission Case	AMR43315	\$ 17.39	
	3	Load Control Seal Replaces AR43103, AR78339	AMAR84793	\$ 33.68	
4620, 4630, 7520	2	Bushing w/ O-Ring	AMAR56769	\$ 82.40	
4630, 7020, 7520	1	Load Sensing Shaft 20" Long, 1.30" Diameter	AMR52185	\$ 106.99	

Toplink Assemblies and Components



Application	Description	Part Number	Retail Price	Core
520, 530, 620, 630, 720, 730	Toplink Assembly, Cat I w/ Hook, Looks like original	AM2CYLTPL	\$ 275.00	
1530, 1640, 1840, 2040, 2140, 2150, 2255, 2350, 2355, 2550, 2555, 2750, 2755, Utility: 820, 2155, 2240	Toplink Assembly, Cat II	AMAL39170	\$ 70.00	
2510, 2520, 3020, 4020, 4030, 4230	Toplink Assembly, Cat II	AMAR34208	\$ 175.00	
	Components:			
	Front Toplink End	1 AMAR32531	\$ 100.56	
	Hook End	1 AMAR46298	\$ 100.00	
	Body	1 AMR47524	\$ 85.00	
	Center Link Pivot Pin	1 AMAR67880	\$ 16.00	
4040, 4050, 4230, 4240, 4250, 4320, 4430	Toplink Assembly, Cat II	AMX7410107	\$ 185.00	
	Components:			
	Front Toplink End	1 AMAR50643	\$ 90.00	
	Hook End	1 AMAR61659	\$ 145.00	
	Body	1 AMR80051	\$ 45.00	
4555, 4560, 4630, 4640, 4650, 4755, 4760, 4840, 4850, 4955, 4960, 8100, 8200, 8300, 8400, 8430, 8440, 8450, 8560, 8570, 8630, 8640, 8650, 8760, 8770, 8870, 8970, 9100, 9200, 9300, 9400	Toplink Assembly, Cat III	AMRE44558	\$ 230.00	
	Components:			
	Front Toplink End	1 AMRE44559	\$ 128.50	
	Rear Toplink End	1 AMRE44561	\$ 203.28	
	Toplink Body	1 AMRE50533	\$ 70.00	
	Handle	1 AMR64084	\$ 10.00	
5103, 5105, 5200, 5203, 5205, 5210, 5220, 5225, 5300, 5303, 5310, 5310N, 5320, 5320N, 5325, 5325N, 5400, 5400N, 5403, 5410, 5415N, 5420, 5420N, 5425, 5425N, 5500, 5500N, 5510, 5510N, 5520, 5520N, 5525, 5525N	Toplink Assembly, Cat II 19.882"-27.559" Adjustable Length, 1" Holes Replaces RE45631	AMRE243206	\$ 131.50	
(6100D, 6115D, 6130D BSN 050000), 6105M, 6115M, 6120, 6120L, 6125M, 6220, 6220L, 6320, 6320L, 6330, 6400, 6410, 6410S, 6420, 6420L, 6430, 6500, 6510S, 6520L, Premium Models: 6330, 6430, 7130, 7230	Toplink Assembly, Cat II w/ Hook, 20.866"-28.543" Adjustable Length Replaces AL159871	AMAL176473	\$ 255.63	
6105M, 6115M, 6125M, 6140M, 6150M, 6320, 6330, 6420, 6430, 7130, 7230, Premium Models: 6330, 6430, 7130, 7230	Toplink Assembly, Cat III w/ Hook, 20.866"-28.543" Adjustable Length	AMAL176469	\$ 288.66	

John Deere®—Tractor

Application	Description	Part Number	Retail Price	Core
6110, 6120, 6200, 6210, 6215, 6220, 6300, 6310, 6320, 6400, 6403, 6405, 6410, 6415, 6420, 6510, 6603, 6605, 6615, 6715, 7220, 7320	Toplink Assembly, Cat II 1" Holes Replaces AL78064	AMAL159873	\$ 209.35	
6140J, 6150M, 6155J, 7330, Premium Model: 7330	Toplink Assembly, Cat III w/ Hook, 23.11"-30.787" Adjustable Length	AMAL176465	\$ 281.67	
6170M, Premium Models: 7430, 7530	Toplink Assembly, Cat III 24.094"-31.772" Adjustable Length	AMAL167751	\$ 274.24	
6320, 6330, 6420, 6430, 7130, 7220, 7230, 7320, Premium Models: 6330, 7130, 7230	Toplink Assembly, Cat III 20.866"-28.543" Adjustable Length Replaces AL159869	AMAL176471	\$ 233.92	
7200, 7210, 7330, 7400, 7410, 7420, 7510, 7600, 7610, 7700, 7710, 7800, 7810, Premium Models: 7330, 7430, 7530	Toplink Assembly, Cat III Replaces RE96274, RE96276, R96294, R117618	AMRE43703	\$ 245.00	
7330	Toplink Assembly, Cat III 23.11"-30.787" Adjustable Length	AMAL176467	\$ 243.05	
6100D, 6105M, 6105R, (6110M, 6110R, 6130M, 6130R - Non MY18), 6115D, 6115M, 6115R, 6120, 6120L, 6120M, 6120R, 6125M, 6125R, 6130D, 6140R, 6150R, 6150RH, 6220, 6220L, 6320, 6320L, 6330, 6400, 6410, 6410S, 6420, 6420L, 6430, 6510S, 6520L, Premium Models: 6230, 6330, 6430, 7130, 7230	Toplink End, Cat II 12.48" Long M33x3.00" Right Hand Thread Replaces AL78069	AMAL159973	\$ 171.56	
(6100D, 6110D, 6115D, 6125D, 6130D, 6140D BSN 050000), 6105M, 6110, 6110L, 6115M, 6210, 6210L, 6215, 6230, 6310, 6310L, 6320, 6320L, 6330, 6403 BSN 003630, 6405, 6410, 6410L, 6410S, 6415, 6420, 6420L, 6430, 6510L, 6510S, 6520L, 6603 BSN 003001, 6605, 6615, 6715, 7130, 7220, 7230, 7320, Premium Models: 6230, 6330, 6430, 7130, 7230	Toplink End, Cat II 8.386" Long M33x3.00" Left Hand Thread Replaces AL78068	AMAL159971	\$ 118.24	
(6100D, 6110D, 6115D, 6125D, 6130D BSN 050000), 6105M, 6110, 6110L, 6115M, 6120, 6120L, 6125M, 6200, 6200L, 6210, 6210L, 6215, 6220, 6220L, 6230, 6300, 6300L, 6310, 6310L, 6310S, 6320, 6320L, 6330, 6400, 6400L, 6403 BSN 003630, 6405, 6410, 6410L, 6410S, 6415, 6420, 6420L, 6430, 6500, 6510S, 6520L, 6603 BSN 003001, 6605, 6615, 6715, 7130, 7220, 7230, Premium Models: 6230, 6330, 6430, 7130, 7230	Toplink End, Cat II 12.48" Long M33x4.00" Right Hand Thread Replaces AL78072	AMAL159972	\$ 161.90	
6105M, 6115M, 6125M, 6140M, 6150M, 6320, 6330, 6420, 6430, 7130, 7220, 7230, 7320, Premium Models: 6330, 6430, 7130, 7230	Toplink End, Cat II 8.386" Long M36x4.00" Thread Left Hand	AMAL159969	\$ 97.92	
6105M, 6105R, 6115M, 6115R, 6125M, 6125R, 6140M, 6140R, 6150M, 6150R, 6150RH, 6170M, 6170R, (6175M, 6195M BSN 866041), 6190R, 6210R, 6320, 6330, 6420, 6430, 7130, 7230, 7330, 7430, 7505, Premium Models: 6330, 6430, 7130, 7230, 7330, 7430, 7530	Toplink End, Cat III 12.48" Long M36x4.00" Right Hand Thread	AMAL159964	\$ 171.87	
6115M, 6125M Non MY18, 6140M, 6150M, 6170M, 6320, 6330, 6420, 6430, 7130, 7220, 7230, 7320, 7330, Premium Models: 6330, 6430, 7130, 7230	Toplink End, Cat III 12.48" Long M36x4.00" Right Hand Thread	AMAL159963	\$ 108.54	
6150M, 7330, Premium Model: 7330	Toplink End, Cat III 10.63" Long M36x4.00" Left Hand Thread	AMAL159962	\$ 89.64	
6170M, Premium Models: 7430, 7530	Toplink End, Cat III M36x4.00" Left Hand Thread	AMAL167756	\$ 83.87	

Prices Subject to Change without Prior Notice. The use of original equipment manufacturer (OEM) part numbers or trademarks, e.g. Case® and John Deere®, are for reference purposes only and for indicating product use and compatibility. Our company and the listed replacement parts contained herein are not sponsored, approved or manufactured by the OEM. All parts are New unless designated Reman in the description.

John Deere®—Tractor

Application	Description	Part Number	Retail Price	Core
7720, 7820, 7920, 8100, 8100T, 8110, 8110T, 8120, 8120T, 8200, 8200T, 8210, 8210T, 8220, 8220T, 8300, 8300T, 8310, 8310T, 8320, 8320T, 8400, 8400T, 8410, 8410T, 8420, 8420T, 8520, 8520T	Toplink End, Cat III Replaces RE154432	AMRE171278	\$ 171.16	
4040, 4050, 4230, 4240, 4250, 4320, 4430	Toplink Body, Cat II Use w/ AMAR50643 Front Toplink End and AMAR61659 Rear Toplink Hook	AMR80051	\$ 45.00	
7720, 7820, 7920, 8100, 8100T, 8110, 8110T, 8120, 8120T, 8200, 8200T, 8210, 8210T, 8220, 8220T, 8300, 8300T, 8310, 8310T, 8320, 8320T, 8400, 8400T, 8410, 8410T, 8420, 8420T, 8520, 8520T	Toplink Body	AMR154440	\$ 139.81	
2510, 2520, 3010 BSN 050000, 3020, 4010, 4020, 4030, 4040, 4050 ASN 001000, 4055, 4230, 4240, 4250 SN 006136-009272, 4255, 4320, 4430, 4440, 4450 BSN 018906	Center Link Hook	AMR53762	\$ 6.07	
2010, 2510, 2520, 3010, 3020, 4000 ASN 201000, 4010, 4020, 4030, 4040, 4230, 4240, 4320, 4430, 4440, 4520, 4620, 4630, 5010, 5020, 6030, 7020, 7520, Ind: 500, 600, 700A	Center Link Handle Replaces R27007	AMR42495	\$ 11.00	
920, 1020, 1030, 1120, 1130, 1520, 1530, 1630, (1640, 2040S ASN 430000), 1830, 2020, 2030, 2040, 2150, 2255, 2350, 2355, 2355N, 2440, 2550, 2555, 2630, 2640, 2750, 2855N, Utility: 820, 830, 2155, 2240	Toplink Bracket	AMT21685	\$ 99.46	
3010, 4010	Toplink Bracket	AMR27803	\$ 85.00	
5075M, 5090M, 5090R, 5100M, 5100MH, 5100ML, 5100R, 5115M, 5115ML, 5115R, 5125R, 6100E, 6105M, 6105R, 6110, 6110D, 6110E, 6110L, 6110M, 6110R, 6115D, 6115M, 6115R, 6120L, 6120M, 6120R, 6125D, 6125E, 6125M, 6125R, 6130D, 6130M, 6130R, 6135R, 6140D, 6140M, 6140R, 6145M, 6145R, 6150M, 6150R, 6150RH, 6155M, 6155R, 6155RH, 6170M, 6170R, 6175R, 6190R, 6195M, 6195R, 6200, 6200L, 6205, 6210, 6210L, 6210R, 6215, 6215R, 6220, 6220L, 6230, 6230R, 6250R, 6300, 6300L, 6310, 6310L, 6320, 6320L, 6330, 6400, 6400L, 6405, 6410, 6410L, 6420, 6420L, 6430, 6500, 6500L, 6510, 6510L, 6520, 6520L, 7130, 7220, 7230, 7320, 7330, 7600, 7610, 7700, 7710, 7800, 7810, Premium Models: 6230, 6330, 6430, 7130, 7230, 7330, 7430, 7530	Toplink Pin 0.984" Diameter, 4.567" Overall, 4.252" Useable Length	AML158185	\$ 10.87	

Sway Blocks



Application	Description	Part Number	Retail Price	Core
940, 1020, 1030, 1040, 1120, 1130, 1140, 1350, 1520, 1530, 1550, 1630, 1640, 1750, 1830, 1850, 1950, 2020, 2030, 2040, 2040S, 2120, 2130, 2150, 2250, 2255, 2350, 2355, 2450, 2550, 2555, 2630, 2640, 2650, 2650N, 2750, 2755, 2850, Ind: 300B, Utility: 820, 830, 2155	Sway Block	Right Hand Left Hand	AMT30276 AMT30277	\$ 40.00 \$ 40.00
520, 530, 620, 720, 730	Sway Block	Right Hand Left Hand	AMR21717 AMR21718	\$ 41.00 \$ 41.00
2510, 2520, 3020, 4000, 4020, 4030, 4040, 4050, 4055, 4230, 4240, 4250, 4320, 4430	Sway Block	Right Hand Left Hand	AMR39512 AMR39513	\$ 55.00 \$ 55.00

John Deere®—Tractor

Application	Description	Part Number	Retail Price	Core
3010	Sway Block	Right Hand AMR27710	\$ 119.49	
		Left Hand AMR27711	\$ 127.38	
4010	Sway Block	Right Hand AMAR31560	\$ 65.00	
		Left Hand AMAR31561	\$ 65.00	
4050, 4250, 4255, 4440, 4455	Sway Block	Right Hand AMR104901	\$ 75.00	
		Left Hand AMR104902	\$ 143.19	
4520, 4620, 4630, 5020, 6030, 7020, 7520	Sway Block	Right Hand AMR48815	\$ 84.00	
		Left Hand AMR48816	\$ 84.00	
4455, 4560, 4640 ASN 012685, 4650, 4755, 4760, 4840 ASN 007012, 4850, 4955, 4960	Sway Block	Right Hand AMR64706	\$ 90.00	
		Left Hand AMR64707	\$ 90.00	
(6100D, 6115D, 6130D BSN 050000), 6105M, 6115M, 6120, 6120L, 6125M, 6220, 6220L, 6320, 6320L, 6330, 6400, 6410, 6410S, 6420, 6420L, 6430, 6500, 6510S, 6520L, Premium Models: 6330, 6430, 7130, 7230	Sway Block Short, Upper	Right Hand AML100868	\$ 45.00	
6010, 6020, 6090MC, 6090RC, 6100, 6100MC, 6100RC, 6105M, 6105R, 6110, 6110L, 6110MC, 6110RC, 6115M, 6115R, 6120, 6120L, 6125M, 6125R, 6130, 6130M, 6130R, 6140M, 6150M, 6200, 6200L, 6210, 6210L, 6220, 6220L, 6225, 6230, 6300, 6300L, 6310, 6310L, 6310S, 6320, 6320L, 6325, 6330, 6400, 6400L, 6400SP, 6405, 6410, 6410L, 6410S, 6415, 6420, 6420L, 6420S, 6425, 6430, 6500, 6500L, 6506, 6510, 6510L, 6510S, 6515, 6520, 6520L, 6525, 6530, 6534, 6605, 6610, 6620, 6630, 7130, 7220, 7230, 7320, SE6010, SE6020, SE6100, SE6110, SE6120, SE6200, SE6210, SE6220, SE6300, SE6310, SE6320, SE6400, SE6410, SE6420, SE6510, SE6520, SE6610, SE6620, Premium Models: 6230, 6330, 6430, 6530, 6534, 6630, 7130, 7230	Sway Block Short, Upper	Left Hand AML100867	\$ 45.00	
6110(L), 6120(L), 6200(L), 6210(L), 6220(L), 6300(L), 6310(L), 6310S, 6320(L), 6400(L), 6405, 6410(L), 6410S, 6420(L), 6500(L), 6510S, 6520(L), 6605, 7220, 7320	Sway Block Long, Lower	Right Hand AML100866	\$ 79.00	
		Left Hand AML100865	\$ 79.00	
6010, 6020, 6090MC, 6090RC, 6100, 6100MC, 6100RC, 6105M, 6105MC, 6105R, 6105RC, 6110, 6110L, 6110M, 6110MC, 6110R, 6110RC, 6115M, 6115MC, 6115R, 6115RC, 6120, 6120L, 6120M, 6120R, 6125M, 6125R, 6130, 6130M, 6130R, 6135M, 6135R, 6140M, 6145M, 6200, 6200L, 6210, 6210L, 6220, 6220L, 6230, 6300, 6300L, 6310, 6310L, 6310S, 6320, 6320L, 6330, 6400, 6400L, 6400SP, 6405, 6410, 6410L, 6410S, 6420, 6420L, 6420S, 6430, 6500, 6500L, 6506, 6510, 6510L, 6510S, 6520, 6520L, 6530, 6534, 6600, 6605, 6610, 6620, 6630, 7130, 7220, 7230, 7320, SE6010, SE6020, SE6100, SE6110, SE6120, SE6200, SE6210, SE6220, SE6300, SE6310, SE6320, SE6400, SE6410, SE6420, SE6510, SE6520, SE6610, SE6620, Premium Models: 6230, 6330, 6430, 6530, 6534, 6630, 7130, 7230	Sway Block Mounting Pin 0.630" Diameter, 4.31" Overall Length Use w/ AML100866 or AML100865 Sway Block	AML77502	\$ 10.70	
6140J, 6140R, 6145R, 6150M, 6150R, 6155M, 6155R, 6155RH, 6170M, 6170R, 6175M, 6190R, 6195M, 6210R, 7330, 7405, 7420, 7430, 7500, 7520, 7530	Sway Block	Right or Left Hand AML101655	\$ 89.47	
6140J, 6140R, 6145R, 6150M, 6150R, 6150RH, 6155J, 6155M, 6155R, 6155RH, 6170M, 6170R, 6175M, 6175R, 6190R, 6195M, 6195R, 6210R, 6215R, 6800, 6810, 6820, 6830, 6900, 6910, 6910S, 6920, 6920S, 6930, 7330, 7405, 7420, 7425, 7500, 7520 2003-07, 7525, 7810, Premium Models: 6830, 6930, 7330, 7430, 7530	Sway Block Mounting Pin 0.630" Diameter, 5.90" Overall Length Use w/ AML101655	AMR117937	\$ 12.62	
8100, 8100T, 8110, 8110T, 8200, 8200T, 8210, 8210T, 8300, 8300T, 8310, 8310T, 8400, 8400T, 8410, 8410T	Sway Block	Right Hand AMR122794	\$ 45.00	
		Left Hand AMR122795	\$ 45.00	
	Sway Block Extension	Right Hand AMR108277	\$ 59.00	
		Left Hand AMR108278	\$ 59.00	

Prices Subject to Change without Prior Notice. The use of original equipment manufacturer (OEM) part numbers or trademarks, e.g. Case® and John Deere®, are for reference purposes only and for indicating product use and compatibility. Our company and the listed replacement parts contained herein are not sponsored, approved or manufactured by the OEM. All parts are New unless designated Reman in the description.

John Deere®—Tractor

Application	Description	Part Number	Retail Price	Core
8120, 8120T, 8130, 8220, 8220T, 8225R, 8230, 8230T, 8235R, 8245R, 8260R, 8270R, 8285R, 8295R, 8295RT, 8310R, 8310RT, 8320, 8320R, 8320RT, 8320T, 8330, 8330T, 8335R, 8335RT, 8345R, 8345RT, 8360R, 8360RT, 8370RT, 8420, 8420T, 8430 2006-09, 8430T, 8520, 8520T, 8530	Sway Block	Right Hand AMR207665	\$ 78.34	
		Left Hand AMR207666	\$ 78.34	
920, 940, 1020, 1030, 1040, 1120, 1130, 1140, 1350, 1520, 1530, 1550, 1750, 1850, 1950, 1950N, 2020, 2030, 2040, 2120, 2150, 2255, 2350, 2355, 2440, 2550, 2555, 2630, 2750, 2755 Low Profile, Ind: 300, 300B, 301, 301A, 302, 302A, 400, 401, 401B, 401C, 401D, Utility: 820, 830, 2155, 2240	Sway Block Support Plate	Right Hand AMAT20167	\$ 47.00	
	Sway Block Support Plate Replaces AR90971	Left Hand AMAT20168	\$ 47.50	



Battery Boxes and Components

Application	Description	Part Number	Retail Price	Core
50, 60, 520, 530, 620, 630	Battery Box	AMAA7337R	\$ 101.50	
3010, 3020, 4010, 4020, 4320, 4520, 4620	Battery Box	Right Hand AMAR40673	\$ 70.00	
	Battery Box	Left Hand AMAR40674	\$ 70.00	
820 German, 830, 920, 1020, 1530, 2020, 2030, 2040 BSN 349999, 2240 BSN 349999, 2630, 2640 BSN 340999, Ind: 300 Series, 301, 400 Series, 401, 401B	Battery Box Door Cover	AMAT20026	\$ 40.00	
2940, 2950, (3040, 3140 ASN 430000), 3055, 3150, 3155, 3255, 4030, 4040, 4050, 4230, 4240, 4250, 4430, 4440, 4450, (4555, 4755, 4955 BSN 010000), 4630, 4640, 4650, 4840, 4850	Battery Box Cover	Right Hand AMR57970	\$ 35.00	
	Battery Box Cover	Left Hand AMR57971	\$ 35.00	
8100, 8110, 8200, 8210, 8300, 8310, 8400, 8410	Battery Box Cover Replaces R124686	AMR151467	\$ 265.00	
2940, 4030, 4040, 4050, 4055, 4230, 4240, 4250, 4255, 4430, 4440, 4450, 4455, (4555, 4755, 4955 BSN 010000), 4630, 4640, 4650, 4840, 4850	Battery Box Cover/Step	Right Hand AMAR85335	\$ 90.00	
2940, 4030, 4040, 4050, 4055, 4230, 4240, 4250, 4255, 4430, 4440, 4450, 4455, 4630, 4640, 4840	Battery Box Cover/Step	Left Hand AMAR85336	\$ 90.00	
4555, 4650, 4755, 4850, 4955	Battery Box Cover/Step	Left Hand AMAR96916	\$ 130.00	
4010, 4020 Early - w/ Syncro-Range	Support Brackets, 4-Piece	AMAR406SUP	\$ 175.00	
3010, 3020 BSN 122999, 4010, 4020, Ind: 500	Positive Battery Cable 38" Long	AMAR28950	\$ 21.23	
3020, 4020, 4030, 4230, 4320, 4430, 4520, 4620, 4630, 7020, 8430, 8630	Negative Battery Cable 15" Long	AMAT10309	\$ 20.00	



Side Rails

Application	Description	Part Number	Retail Price	Core
3010, 3020	Side Rail	Right Hand AMR27021	\$ 360.00	
		Left Hand AMR27022	\$ 360.00	
4010, 4020	Side Rail	Right Hand AMR34113	\$ 389.00	
		Left Hand AMR34114	\$ 389.00	
4240, 4430, 4440, 4630	Side Rail	Right Hand AMR60579	\$ 287.00	
		Left Hand AMR60580	\$ 410.81	
4640, 4840	Side Rail	Right Hand AMAR73324	\$ 569.76	
		Left Hand AMAR73325	\$ 569.76	



Side Screens

Application	Description	Part Number	Retail Price	Core
50, 520, 530	Side Screen	AMB3039R	\$ 50.00	
60, 70, 620, 630, 720, 730	Side Screen	AMA4316R	\$ 40.00	
1020, 1520, 1530, 2040, Utility: 820, 830, 2240	Side Screen	17.00" x 13.50" AMAR72949	\$ 60.00	
1520, 2020, 2030, (2240, 2440, 2630, 2640 - Early)	Side Screen	17.00" x 17.00" AMAR72950	\$ 60.00	
2355, 2555, 2755, 2855N	Side Screen w/ Knob	19.50" x 17.00" AMAL67554	\$ 105.00	
2510, 2520	Side Screen	17.219" x 16.875" AMAR38234	\$ 90.00	
2840, (3030, 3130 ASN 182150)	Side Screen, Right Hand	AMAR72859	\$ 125.00	
	Side Screen, Left Hand	AMAR72860	\$ 125.00	
2940, 2950, 3040, 3140, 3150	Side Screen Replaces AL31250, AL36736	20 1/2" x 22 1/4" AMAL56764	\$ 139.05	
2955, 3055, 3155, 3255	Side Screen w/ Knob	22.50" x 20.75" AMAL67191	\$ 130.00	
3010, 3020	Side Screen	19.25" x 18.25" AMAR26849	\$ 65.00	
4000, 4010, 4020	Side Screen	20.00" x 17.00" AMAR32720	\$ 70.00	
4030	Side Screen	22.25" x 20.00" AMAR65458	\$ 120.00	
4230, 4040	Side Screen	23.875" x 21.00" AMAR65459	\$ 90.00	
4240, 4430	Side Screen	26.00" x 23.00" AMAR65460	\$ 95.00	
4250, 4450, 4055, 4255, 4455, 4050 ASN 005511	Side Screen w/ Clamp & Knob	AMRE12764	\$ 125.00	
4320	Side Screen	21.00" x 20.75" AMAR48488	\$ 90.00	
4440, 4630, 4640	Side Screen	26.00" x 25.00" AMAR65461	\$ 95.00	
4520, 4620	Side Screen	23.5625" x 23.1875" AMAR43060	\$ 160.00	
4555, 4560, 4650, 4755, 4760, 4850, 4955, 4960 - w/ MFWD	Side Screen, Right Hand	AMRE12879	\$ 395.00	
	Side Screen, Left Hand	AMRE12880	\$ 553.87	
4555, 4560, 4650, 4760, 4755, 4850, 4955, 4960 - 2WD	Side Screen, Right Hand	AMRE12881	\$ 410.00	
	Side Screen, Left Hand	AMRE12882	\$ 410.00	
4840	Side Screen	32.50" x 24.75" AMAR73911	\$ 100.00	
5200, 5300, 5400, 5400N, 5500N	Side Screen Replaces RE40812	AMRE66040	\$ 100.00	
6030, 7520	Side Screen	25.156" x 18.1878" AMAR53791	\$ 130.00	
8430, 8440, 8630, 8640	Side Screen	24.00" x 21.50" AMAR69164	\$ 90.00	
8450, 8650	Side Screen	24.00" x 19.25" AMAR98442	\$ 90.00	
Sprayers: 6100, 6500, 6600	Side Screen	AMAN153468	\$ 350.00	
940, 1020, 1030, 1040, 1120, 1130, 1140, 1630, 1640, 1830, 2020, 2030, 2040, 2120, 2130, 2140	Spring 11.87" Free Length, 0.578" OD	AMR26858	\$ 4.50	

Hoods

Hoods come already primed.



Application	Description	Part Number	Retail Price	Core
3010, 3020 BSN 122999	Hood Round Muffler, w/o Precleaner Hole	AMAR41148	\$ 850.00	
8120, 8120T, 8220, 8220T, 8320, 8320T, 8420, 8420T, 8520, 8520T	Hood Fiberglass Construction, Pre-Painted Replaces RE169901, RE194633	AMRE215791	\$ 4200.00	
1010, 1020, 2510, 2520, 3010, 3020, 4000, 4010, 4020, 4320, 4520, 4620, 5010, 5020, 6030, 7020, 7520	Front Hood Medallion	AMAR28047	\$ 35.00	

John Deere®—Tractor

Decals

Application	Description	Part Number	Retail Price	Core
430	Decal Set, Hood Replaces T11020T, T11021T	AMJD430	\$ 65.63	
630	Decal Set, Hood	AMJD630	\$ 51.85	
820	Decal Set For 2 Cylinder Model	AMJD820	\$ 51.09	
830	Decal Set, Hood For 2 Cylinder Model Replaces R60502, R61238, R61239	AMJD830	\$ 85.38	
950	Decal Set, Hood	AMJD950	\$ 56.88	
1010	Decal Set	AMJD1010	\$ 71.52	
1050	Decal Set, Hood	AMJD1050	\$ 59.27	
1530	Decal Set, Hood Replaces L293854, L29385, L65447, L65448, L65449	AMJD1530	\$ 94.39	
2010	Decal Set	AMJD2010	\$ 71.52	
2020	Decal Set, Hood Replaces R48203, R48204, R48222, R48223, T22802, T22803	AMJD2020	\$ 55.77	
2030 BSN 187301	Decal Set, Hood Replaces R50676, R89983, R89984	AMJD2030E	\$ 55.37	
2030 ASN 187300	Decal Set, Hood Replaces R55752, R55753	AMJD2030	\$ 94.39	
2040	Decal Set, Hood	AMJD412	\$ 78.05	
2140	Decal Set, Hood	AMJD2140	\$ 95.75	
2150	Decal Set, Hood	AMJD405	\$ 88.91	
2155	Decal Set, Hood	AMJD2155	\$ 93.47	
2240 BSN 350000	Decal Set, Hood Replaces R60502, R60662, R60663	AMJD2240E	\$ 99.43	
2240	Decal Set, Hood	AMJD416	\$ 85.38	
2350	Decal Set, Hood Replaces L35121, L35124, L40150, L63977, L65466	AMJD407	\$ 76.26	
2355	Decal Set, Hood	AMJD408	\$ 76.26	
2440 BSN 341000	Decal Set, Hood Replaces R60503, R60504	AMJD2440E	\$ 94.39	
2440	Decal Set, Hood	AMJD409	\$ 88.15	
2510, 2520, 3010 BSN 050000, 3020, 4010, 4020, 4320, 4520, 4620, 5010, 5020, 6030	Decal Set For Syncro-Range or Powershift Models Replaces AR34177, R47091	AMAR52393	\$ 53.17	
2550	Decal Set, Hood Replaces L35121, L35124, L40150, L63977, L65467	AMJD2550	\$ 76.29	
2555	Decal Set, Hood Replaces L35121, L35124, L59302, L63269, L63270, L63281, L63282	AMJD2555	\$ 76.26	
2640	Decal Set, Hood Replaces R60502, R60652, R60653, R70391, R74208, R74209	AMJD2640	\$ 76.26	
2750	Decal Set, Hood Replaces L35121, L35124, L40150, L63977, L65468	AMJD2750	\$ 76.26	
2755	Decal Set, Hood Replaces L35121, L35124, L63269, L63270, L63283, L63284, L65349	AMJD2755	\$ 76.29	
2840	Decal Set, Hood Replaces L32544, L32545, L60502, L65447, L65448, L65449	AMJD2840	\$ 80.98	
2940	Decal Set, Hood Replaces L35120, L35121, L35124, L35494, L35495	AMJD2940	\$ 72.07	

John Deere®—Tractor

Application	Description	Part Number	Retail Price	Core
2950	Decal Set, Hood	AMJD410	\$ 72.07	
2955	Decal Set, Hood Replaces L35121, L35124, L63269, L63270, L63297, L63928, L65349	AMJD2955	\$ 75.19	
3010	Decal Set, Hood	AMJD411S	\$ 76.72	
3020	Decal Set, Hood	AMJD412S	\$ 36.32	
3130	Decal Set, Hood Replaces L29028, L29035, R60502, R61191, R91192	AMJD414	\$ 55.11	
3155	Decal Set, Hood	AMJD415	\$ 70.84	
4010	Decal Set, Hood	AMJD416S	\$ 76.72	
4020	Decal Set, Hood	AMJD417S	\$ 71.43	
4030	Decal Set, Hood Replaces R63407, R63413, R63418, R63419, R64308	AMJD4030	\$ 80.04	
4040	Decal Set, Hood	AMJD4040TP	\$ 76.26	
4055	Decal Set, Hood Replaces R97651, R97652, R97675, R97678	AMJD4055	\$ 72.07	
4230	Decal Set, Hood Replaces R63409, R63410, R63413, R63420, R63421	AMJD4230	\$ 78.14	
4240	Decal Set, Hood	AMJD4240	\$ 75.19	
4255	Decal Set, Hood Replaces R97655, R97656, R97675, R97678	AMJD4255	\$ 59.84	
4320	Decal Set, Hood	AMJD418	\$ 73.33	
4430	Decal Set, Hood	AMJD419	\$ 61.71	
4440	Decal Set, Hood Replaces R65855, R65859, R65862	AMJD4440TP	\$ 80.98	
4450	Decal Set, Hood	AMJD4450	\$ 72.66	
4455	Decal Set, Hood Replaces R97659, R97660, R97675, R97678	AMJD4455	\$ 59.84	
4555	Decal Set, Hood Replaces R97671, R97672, R97675, R97678	AMJD4555	\$ 59.84	
4560	Decal Set, Hood Replaces R97675, R97678, R109024, R109025	AMJD4560	\$ 59.84	
4620	Decal Set Includes Side Panel and Operator Station Decals	AMJD4620	\$ 62.71	
4630	Decal Set, Hood Replaces R63414, R63424, R63425	AMJD420	\$ 58.62	
4640	Decal Set, Hood	AMJD4640	\$ 75.19	
4755	Decal Set, Hood Replaces R97663, R97664, R97675, R97678	AMJD4755	\$ 59.84	
4760	Decal Set, Hood Replaces R97675, R97678, R109026, R109027	AMJD4760	\$ 59.84	
4840	Decal Set, Hood Replaces R65857, R65865	AMJD4840	\$ 75.19	
4850	Decal Set, Hood Replaces R65865, R73487, R73488	AMJD4850	\$ 72.26	
4955	Decal Set, Hood Replaces R97667, R97668, R97675, R97678	AMJD4955	\$ 59.84	
4960	Decal Set, Hood Replaces R97675, R97678, R112288, R112289	AMJD4960	\$ 59.84	
6200	Decal Set, Hood Replaces L79807, L79810, L79811, L101625, L101628, L101629	AMJD6200	\$ 90.31	
6300	Decal Set, Hood Replaces L79807, L79812, L79813, L101625, L101630, L101631	AMJD6300	\$ 88.91	

John Deere®—Tractor

Application	Description	Part Number	Retail Price	Core
6400	Decal Set, Hood Replaces L79814, L79815, L101632, L101633	AMJD6400	\$ 93.80	
A	Decal Set, Hood	AMJDA	\$ 50.73	



Side Moldings

Application	Description	Part Number	Retail Price	Core
1010, 2010, 3010, 4010, 4020, 4320, 4520, 4620, 5010, 5020	Side Molding Set Raised Letter Style, Includes Right and Left Hand Replaces AR28048, AR28049	AMX1910120	\$ 145.00	

Side Panels, Front

Panels are painted with a primer coat unless otherwise noted.



Application	Description	Part Number	Retail Price	Core
4000, 4010, 4020	Front Side Panel	Right Hand	AMAR32689	\$ 85.00
		Left Hand	AMAR32690	\$ 85.00
7200, 7210, 7400, 7410, 7510	Front Side Panel	Right Hand	AMAL80545	\$ 147.24
		Left Hand	AMAL80544	\$ 147.24

Side Panels, Rear

Panels are painted with a primer coat unless otherwise noted.



Application	Description	Part Number	Retail Price	Core
1830, 2020, 2030, 2120, 2130	Rear Side Panel	Right Hand	AML29049	\$ 45.00
		Left Hand	AML29050	\$ 45.00
2510	Rear Side Panel	Left Hand	AMAR38203	\$ 120.00
2520	Rear Side Panel	Left Hand	AMAR38839	\$ 145.00
3010, 3020 Early	Rear Side Panel	Right Hand	AMAR26850	\$ 86.00
		Left Hand	AMAR26851	\$ 86.00
3020 ASN 123000	Rear Side Panel	Right Hand	AMAR40777	\$ 75.00
		Left Hand	AMAR40778	\$ 75.00
4010, 4020 BSN 200999	Rear Side Panel	Right Hand	AMAR26769	\$ 86.00
		Left Hand	AMAR26770	\$ 86.00
(4000, 4020 ASN 201000)	Rear Side Panel	Right Hand	AMAR40773	\$ 54.00
		Left Hand	AMAR40774	\$ 54.00
4040, 4230	Rear Side Panel	Right Hand	AMAR82260	\$ 65.00
		Left Hand	AMAR82261	\$ 65.00
4320	Rear Side Panel	Right Hand	AMAR49200	\$ 97.00
		Left Hand	AMAR49201	\$ 97.00
4520, 4620	Rear Side Panel	Right Hand	AMAR43290	\$ 65.00
4520	Rear Side Panel	Left Hand	AMAR43291	\$ 95.06
4240, 4430	Rear Side Panel	Right Hand	AMAR82258	\$ 80.00
		Left Hand	AMAR82259	\$ 80.00
4050 ASN 005511, 4055, 4250, 4255, 4440, 4450, 4455, 4630	Rear Side Panel	Right Hand	AMAR82256	\$ 60.00
4050 ASN 005511, 4055, 4250, 4255, 4440, 4450, 4455	Rear Side Panel	Left Hand	AMAR81380	\$ 61.00

John Deere®—Tractor

Application	Description	Part Number	Retail Price	Core
(4555, 4755, 4955 BSN 010000), 4640, 4650, 4840, 4850	Rear Side Panel	Right Hand	AMAR76438	\$ 87.00
		Left Hand	AMAR82257	\$ 89.00

Front Grilles, Nose Cones and Components

Application	Description	Part Number	Retail Price	Core
6605	Upper Front Grill Frame Frame Only	AML80034	\$ 85.00	
1010	Front Grille	AMAT20629	\$ 175.00	
2510, 2520	Front Grille	AMAR38233	\$ 85.00	
40 SN 060001-063119, 420	Grille Screen 23" Wide, 18" Tall	AMM1728T	\$ 127.22	
320, 330, 420, 430	Grille Screen	AMM4326T	\$ 50.00	
3010, 3020	Grille Screen	AMAR26494	\$ 85.00	
4000, 4010, 4020	Grille Screen	AMAR26477	\$ 90.00	
6605	Upper Front Grille Screen	AML80035	\$ 85.00	
2010	Front Grille Screen	AMAT11703	\$ 176.00	
5200, 5300, 5400, 5400N, 5500, 5500N	Front Grille Screen	AMRE63225	\$ 78.50	
(1640, 2040, 2040S, 3040, 3140 ASN 430000), 2940, 4030, 4040, 4040S, 4230, Utility: 2155 BSN 621999, 2240 ASN 350000	Nose Cone	AMR52362	\$ 59.00	
2040, (2240, 2440, 2640 BSN 349999)	Nose Cone	AMR59961	\$ 55.00	

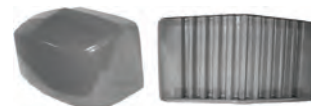

Cowl (Dash) Covers

Application	Description	Part Number	Retail Price	Core
1640, 1840, 2040 ASN 430000, 2040S, 2140, 2350, (2440, 2640 ASN 341000), 2550, 2750	Cowl Cover Green Plastic	Right Hand AMAL31039	\$ 289.64	

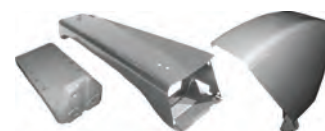

Fenders, Platforms and Components

Fenders are painted with a primer coat unless otherwise noted.

Application	Description	Part Number	Retail Price	Core
30, 40, 50, 55 Series	Fender Bolt on style fender for Sound-Gard™ cabs, Can replace welded-on fenders on 30 Series tractors	Right Hand	AMRE11219	\$ 250.00
		Left Hand	AMRE11220	\$ 250.00
40, 430, 435D, 1010, Ind: 420	Fender Clamshell style fender	Left or Right Hand	AMAM1834T	\$ 164.00
50, 60, 70, 520, 530, 620, 630, 720, 730, A, B	Fender Clamshell style fender	Left or Right Hand	AMAA4655R	\$ 164.00
530, 630, 730	Fender w/o Grab Hole Correct OEM Primer Coated, Ready for Paint	Right Hand Restoration Quality	AMAR20869	\$ 285.00
530, 630, 730, 2010, 2440, 2520, 2630, 2640, 2940, 2840, 2955, 3010, 3020, 4000, 4010, 4020	Fender Row-Crop Style Fender w/ Grab Hole Two Headlight Opening Correct OEM Primer Coated, Ready for Paint Includes Grommet	Left Hand Restoration Quality	AMAR48873	\$ 285.00







John Deere®—Tractor

Application	Description	Part Number	Retail Price	Core
830, 1020, 1530, 2020, 2030, 2040, 2240, 2440, 2630, 2640, Ind: 300, 301, 400	Fender Primer Coated, Ready for Paint	Right Hand AMAT20777	\$ 105.00	
		Left Hand AMAR51407	\$ 105.00	
2010, 2440, 2520, 2630, 2640, 2840, 2940, 2955, 3010, 3020, 4000, 4010, 4020	Fender Row-Crop Style Fender w/ Grab Hole Two Headlight Opening Correct OEM Primer Coated, Ready for Paint Includes Grommet	Right Hand AMAR48872 Restoration Quality	\$ 285.00	
2140, 2350, 2355, 2550, 2555, 2750, 2755, 2855N, 2940, 2950, 2955, 3040, 3055, 3140, 3150, 3155, 3255	Fender w/ Sound-Gard™ Body	Right Hand AMAR84678	\$ 275.00	
		Left Hand AMAR84679	\$ 275.00	
(4000, 4020 ASN 250001), 4320	Fender Single Headlight Opening Restoration Quality Correct OEM Primer Coated, Ready for Paint Includes Grommet	Right Hand AMAR51444	\$ 285.00	
		Left Hand AMAR51445	\$ 285.00	
4320, 4520, 4620, 5020, 6030	Fender Restoration Quality Correct OEM Primer Coated, Ready for Paint Includes Grommet	Right Hand AMAR43967	\$ 360.00	
		Left Hand AMAR43968	\$ 360.00	
4560, 4755 ASN 10001, 4760, 4955 ASN 10001, 4960	Fender Bolt-on style fender for Sound-Gard™ cabs w/ square headlights	Right Hand AMRE46294	\$ 285.00	
		Left Hand AMRE47822	\$ 285.00	
A BSN 650763, (B, BN, BNH, BW, BWH - BSN 260983), (G, GH, GN, GW - BSN G41667)	Fender	Right Hand AMAA1582R	\$ 362.93	
		Left Hand AMAA1583R	\$ 302.26	
6110L, 6200, 6210L, 6300, 6310L, 6400, 6405, 6410L, 6605	Fender Extension Long Version	Right Hand AML101643	\$ 113.35	
		Left Hand AML101649	\$ 114.24	
2520, 3020 ASN 123000, (4000, 4020 ASN 201000), 4010, 4020 BSN 200999, 4320	Platform	AMAR48727	\$ 250.00	
530, 630, 730	Cast Fender Bracket 3 Bolt Hole Style Bracket	AMR20573	\$ 110.00	
2010, 2030, 2440, 2510, 2520, 2630, 2640, 2840, 3010, 3020, 4000, 4010, 4020, 4520, 4620, 5020, 6030, 8430, 8440, 8450, 8630, 8640, 8650	Cast Fender Bracket 2 Bolt Hole Style Bracket	AMR70588	\$ 95.00	
2010, 2520, 2630, 3010, 3020, 4000, 4010, 4020	Mounting Bracket U Clamp Use w/ AMR70588 for AMAR48872 & AMAR48873	AMR26992	\$ 15.00	
530, 630, 730, 820, 830, 920, 930, 1020, 2010, 2020, 2030, 2130, 2440, 2510, 2520, 2630, 2640, 2840, 2940, 3010, 3020, 3120, 4000, 4010, 4020, 4030, 4040, 4050, 4055, 4230, 4240, 4250, 4255, 4320, 4430, 4440, 4450, 4455, 4520, 4555, 4560, 4620, 4630, 4640, 4650, 4755, 4760, 4840, 4850, 4955, 4960, 5010, 5020, 6030, 8430, 8440, 8450, 8630, 8640, 8650, 8850	Grommet, Fender Handle 4.50" x 1.50" ID, 5.75" x 2.75" OD	AMR20759	\$ 8.00	
2140 ASN 430000, 2250, 2350, 2355, 2450, 2550, 2555, 2650, 2750, 2755, 2850, 2940, 2950, 2955, 3040, 3050, 3055, 3140, 3150, 3155, 3255, 3350, 4030, 4040, 4040S, 4050, 4055, 4230, 4240, 4240S, 4250, 4255, 4350, 4430, 4440, 4450, 4455, 4555, 4630, 4640, 4650, 4755, 4840, 4850, 4955 - All 1973 and Later	Front Light Bezel For Tractors w/ Sound-Gard™ Body or Open Station Replaces AR84969	Right Hand AMR81696	\$ 65.00	
		Left Hand AMR81697	\$ 65.00	







John Deere®—Tractor

Application	Description	Part Number	Retail Price	Core
2140 ASN 430000, 2250, 2350, 2355, 2450, 2550, 2555, 2650, 2750, 2755, 2850, 2940, 2950, 2955, 3040, 3050, 3055, 3140, 3150, 3155, 3255, 3350, 4030, 4040, 4040S, 4050, 4055, 4230, 4240, 4240S, 4250, 4255, 4350, 4430, 4440, 4450, 4455, 4560, 4630, 4640, 4650, 4755, 4760, 4840, 4850, 4955, 4960 - All 1973 and Later	Rear Tail Light Bezel	Right Hand AMR52561	\$ 31.00	
	For Tractors w/ Sound-Gard™ Body or Open Station	Left Hand AMR52562	\$ 31.00	
8100, 8110, 8200, 8210, 8300, 8310, 8400, 8410	Fender Pivot Isolator	AMRE60938	\$ 167.00	



Lighting

Application	Description	Part Number	Retail Price	Core
 7630, 7720, 7730, 7820, 7830, 7920, 7930, 8120, 8130, 8220, 8225R, 8230, 8245R, 8270R, 8295R, 8320, 8330, 8420, 8430, 8520, 8530, 9120, 9220, 9230, 9320, 9330, 9420, 9430, 9520, 9530, 9620, 9630	Replacement Bulb	AMRE179326	\$ 6.30	
 1640, 2040, 2140, 2150, 2255, 2350, 2355N, 2550, 2855N, 2940, 2950, 2955, 3040, 3055, 3140, 3150, 3155, 3255, 4030, 4040, 4230, Utility: 2155, 2240	LED Floodlight Conversion Kit Converts Hood Lights to LED Lights (3) Rectangle Floodlights, Each Light is 320 Lumens, 90 Watts, 7.50 Amps For 12 Volt to 24 Volt Systems Includes Wire Harness, Housing, Billet Bezel and Mounting Hardware	AMTL3000	\$ 380.00	
 2355, 2555, 2750, 2755	LED Floodlight Conversion Kit Converts Hood Lights to LED Lights (3) Rectangle Floodlights, Each Light is 4320 Lumens, 90 Watts, 7.50 Amps For 12 Volt to 24 Volt Systems Includes Wire Harness, Housing, Billet Bezel and Mounting Hardware	AMTL2700	\$ 380.00	
 4240, 4430, 4440, 4630	LED Floodlight Conversion Kit Converts Hood Lights to LED Lights (3) Rectangle Floodlights, Each Light is 4320 Lumens, 90 Watts, 7.50 Amps For 12 Volt to 24 Volt Systems Includes Wire Harness (Plug-and-Play), Housing, Billet Bezel and Hardware	AMTL4200	\$ 380.00	
 4555, 4560, 4755, 4760, 4955, 4960	LED Floodlight Conversion Kit Converts Hood Lights to LED Lights (4) 2.49" x 5.44" Rectangle Floodlights, Each Light is 1440 Lumens, 20 Watts, 1.60 Amps Trapezoid Pattern For 12 Volt to 24 Volt Systems Includes LED Lights, Wire Harness, Housing, Bezels and Mounting Hardware	AMX1910148	\$ 430.00	
 4640, 4840, 8430, 8440, 8450, 8630, 8640, 8650	LED Floodlight Conversion Kit Converts Hood Lights to LED Lights (4) Rectangle Floodlights, Each Light is 5760 Lumens, 120 Watts, 10 Amps Includes Wire Harness (Plug-and-Play), Housing, Billet Bezel and Hardware	AMTL4600	\$ 430.00	







John Deere®—Tractor

Application	Description	Part Number	Retail Price	Core
4650, 4850	LED Floodlight Conversion Kit Converts Hood Lights to LED Lights Includes (4) 2.49" x 5.44" Rectangle Floodlights Each are 1440 Lumens, 20 Watts, 1.60 Amps Trapezoid Pattern Includes LED Lights, Wire Harness, Housing, Bezels and Mounting Hardware	AMTL4850	\$ 430.00	
 7130, 7230, 7330, 7430, 7530, 7630, 7720, 7730, 7820, 7830, 7920, 7930, 8120, 8130, 8220, 8225R, 8230, 8245R, 8260R, 8270R, 8285R, 8295R, 8320, 8335R, 8345R, 8420, 8430, 8520, 8530, 9220, 9230, 9320, 9420, 9430, 9520, 9530, 9620, 9630	LED Floodlight Conversion Kit (2) 6.50" x 4.50" Oval Lights, Each Light is 5000 Lumens, 60 Watts, 5 Amps For 12 Volt to 24 Volt Systems Includes Mounting Brackets, Stainless Steel Hardware and Wiring Harness (Plug-and-Play)	AMTL8320-KIT	\$ 350.00	
 4050, 4055, 4250, 4255, 4450, 4455	LED Hood Conversion Kit Converts Hood Lights to LED Lights (3) Rectangle Floodlights, Each Light is 4320 Lumens, 90 Watts, 7.50 Amps For 12 Volt to 24 Volt Systems Includes Wire Harness (Plug-and-Play), Housing, Billet Bezel and Hardware	AMTL4000	\$ 380.00	
 8100, 8100T, 8110, 8110T, 8200, 8200T, 8210, 8210T, 8300, 8300T, 8310, 8310T, 8400, 8400T, 8410, 8410T	LED Floodlight Kit Includes (12) Rectangle Lights and Interchangeable Mounts Each Light is 3200 Lumens, 40 Watts, 3.20 Amps For 12 Volt to 24 Volt Systems Plug-and-Play Installation Replaces RE154900, RE154901, RE154902, RE154903, RE154904, RE154906, RE154908	AMX34163	\$ 1100.00	
 Gator™ Utility Vehicles: RSX, XUV	LED Spotlight Kit All-Position Light (2) Round Spotlights, Each Light is 5000 Lumens, 35 Watts, 3 Amps For 12 Volt to 24 Volt Systems Includes Wire Harness, Switch, Mounting Brackets and Hardware	AMTLG3	\$ 395.00	
 9100, 9200, 9300, 9300T, 9400, 9400T	LED Light Kit Includes (2) LED Headlights, Center*, (2) LED Headlights, Hi/Lo Beams*, (4) LED Worklights, Rear Fender**, (4) LED Trapezoid Light, Par 36 Replacement Light*** For 12 Volt to 24 Volt Systems Plug-and-Play Installation *3500 Lumens, 60 Watts, 5 Amps **3600 Lumens, 40 Watts, 3.33 Amps ***2200 Lumens, 24 Watts, 2 Amps	AMX34173	\$ 880.00	
 2340, 5045, 5055, 5065, 5075, 5083, 5085, 5093, 5095, 5100, 5101, 5105, 5115, 5220, 5225, 5325, 5420, 5425, 5520, 5525, 5625, Utility: 1023E, 1026R, 2305, 2320, 2520, 2720, 3033R, 3039R, 3046R, 3120, 3203, 3320, 3520, 3720, 4010, 4044M, 4044R, 4052M, 4052R, 4066M, 4066R, 4105, 4110, 4115, 4120, 4210, 4310, 4320, 4410, 4510, 4520, 4610, 4710, 4720 Replaces R198623	LED Conversion Light Rear Fender Mount 5.75" x 3.75" Oval Light 2900 Lumens, 35 Watts, 2.90 Amps For 12 Volt to 24 Volt Systems Includes Bracket and Connectors	AMTL5650	\$ 95.00	
	LED Conversion Light Rear Fender Mount 5.75" x 3.75" Oval Light 2900 Lumens, 35 Watts, 2.90 Amps For 12 Volt to 24 Volt Systems Includes Bracket and Connectors	AMAH207788	\$ 76.00	







John Deere®—Tractor

	Application	Description	Part Number	Retail Price	Core
	1020, 1520, 1530, 2010, 2020, 2030, 2040, 2350, 2355, 2510, 2520, 2550, 2555, 2630, 2640, 2750, 2755, 2840, 2855, 2940, 2950, 2955, 3010, 3020, 4000, 4010, 4020, 4320, 4520, 4620, 5010, 5020, 6030, Utility: 2240 Replaces AR85262, RE19080	LED Trapezoid Light Fender Mount 4.50" Sealed Beam Round Light 2800 Lumens, 40 Watts, 3.30 Amps For 12 Volt to 24 Volt Systems Rear Stud Mount w/ Built-In Heat Sink Includes Both Long and Short Rubber Bezels	AMTL2060	\$ 95.00	
		Headlight Sealed Beam, 12 Volt, 2-Wire	AMRE25126	\$ 45.00	
	6105M, 6105R, 6110M, 6110R, 6115M, 6115R, 6120M, 6120R, 6125M, 6125R, 6130M, 6130R, 6140M, 6140R, 6145M, 6145R, 6150M, 6150R, 6150RH, 6155M, 6155R, 6155RH, 6170M, 6170R, 6175M, 6175R, 6190R, 6195M, 6195R, 6210R, 6215R Replaces AL209455	LED Headlight Front Mount 3.37" Diameter Round Light 3200 Lumens, 32 Watts, 2.60 Amps For 12 Volt to 24 Volt Systems Replaces the factory bulb/housing Plug-and-Play Installation	AMTL6020	\$ 95.00	
		LED Headlight Front Mount 3.37" Diameter Round Light 3200 Lumens, 40 Watts, 2.60 Amps For 12 Volt to 24 Volt Systems Will Bolt into Factory Light Housing Plug-and-Play Installation	AMX34172	\$ 76.00	
	7630, 7720, 7730, 7820, 7830, 7920, 7930	LED Headlight, Right Hand Outside Corner Mount 6.50" x 4.75" x 2.75" Oval Light 2000 Lumens, 30 Watts, 2.50 Amps For 12 Volt to 24 Volt Systems Uses Original Mount and Wiring, Plug-and-Play Replaces RE205362	AMTL7830R	\$ 115.00	
		LED Headlight, Left Hand Outside Corner Mount 6.50" x 4.75" x 2.75" Oval Light 2000 Lumens, 30 Watts, 2.50 Amps For 12 Volt to 24 Volt Systems Uses Original Mount and Wiring, Plug-and-Play Replaces RE205361	AMTL7830L	\$ 115.00	
		LED Headlight, Right Hand Outside Corner Mount 6.50" x 4.75" x 2.75" Oval Light 2000 Lumens, 30 Watts, 2.50 Amps For 12 Volt to 24 Volt Systems Uses Original Mount and Wiring, Plug-and-Play Replaces RE205362	AMRE181913	\$ 92.00	
		LED Headlight, Left Hand Outside Corner Mount 6.50" x 4.75" x 2.75" Oval Light 2000 Lumens, 30 Watts, 2.50 Amps For 12 Volt to 24 Volt Systems Uses Original Mount and Wiring, Plug-and-Play Replaces RE205361	AMRE181916	\$ 92.00	





John Deere®—Tractor

Application	Description	Part Number	Retail Price	Core
 9100, 9200, 9300, 9300T, 9400, 9400T Replaces RE65223, RE65423	LED Headlight Hood and Cab Mount 6.75" x 4.25" Rectangle Light Dual Hi/Lo Beam 3500 Lumens, 60 Watts, 5 Amps For 12 Volt to 24 Volt Systems Includes Connector and Adpater, Plug-and-Play	AMTL9020	\$ 99.00	
	LED Headlight Hood and Cab Mount 6.75" x 4.25" Rectangle Light Dual Hi/Lo Beam 3500 Lumens, 60 Watts, 5 Amps For 12 Volt to 24 Volt Systems Includes Connector, Plug-and-Play	AMRE46298	\$ 79.20	
 720, 730, 1030, 1130, 1630, 1640, 1830, 2030, 2040, 2130, 2140, 2350, 2510, 2750, 2940, 2950, 3010, 3020, 3040, 3150, 4000, 4020, 4030, 4050, 4230, 4250, 4430, 4440, 4450, 4620, 4630, 4640, 4840, 5010, 5020, 7020, 8430, 8440, 8640, Utility: 2240, 4500	Halogen Floodlight, Sealed Beam 4.50" Diameter Round Light 2-Terminal Connection For 12 Volt Systems Replaces A47179, AR104119, E3NN15330AA	AMH7606	\$ 13.25	
 Universal Equipment	LED Floodlight All-Position Light 4.25" x 4.25" Square Light 2650 Lumens, 48 Watts, 4 Amps For 12 Volt to 24 Volt Systems Includes Mounting Bracket and Stainless Steel Hardware	AMTL105F	\$ 95.00	
 Universal Equipment	LED Floodlight All-Position Light 5" Round Light 3200 Lumens, 40 Watts, 3.30 Amps For 12 Volt to 24 Volt Systems Includes Mounting Bracket and Stainless Steel Hardware	AMTL180	\$ 89.00	
 Universal Equipment	LED Floodlight All-Position Light 6.25" x 1.75" Rectangle Light 1300 Lumens, 18 Watts, 1.50 Amps For 12 Volt to 24 Volt Systems Includes Mounting Bracket and Stainless Steel Hardware	AMTL118F	\$ 50.00	
 Universal Equipment	LED Floodlight All-Position Light Round Light 6900 Lumens, 50 Watts, 4.10 Amps For 9 Volt to 32 Volt Systems Includes Mounting Bracket and Stainless Steel Hardware	AMTL500F	\$ 120.00	
	LED Floodlight All-Position Light 4.30" Round Light 5040 Lumens, 50 Watts, 4.10 Amps For 12 Volt to 24 Volt Systems Includes Stainless Steel Adjustable Mounting Bracket Replaces AT135485, AT135486, AT443223	AMAT305931	\$ 96.00	

John Deere®—Tractor

Application	Description	Part Number	Retail Price	Core
 Universal Equipment	LED Floodlight All-Position Light 4.25" Round Light 2650 Lumens, 42 Watts, 3.50 Amps For 12 Volt to 24 Volt Systems Includes Mounting Bracket and Stainless Steel Hardware	AMTL115F	\$ 59.00	
 Universal Equipment	LED Wide Floodlight All-Position Light 5" x 7" Rectangle Light 3800 Lumens, 35 Watts For 12 Volt to 24 Volt Systems Replaces AT135485, AT135486, AT305931, AT443223, AT443224	AMX34171	\$ 60.00	
 Most Models Replaces AT305931, AT443223, AT443224	Compact LED Wide Floodlight 4.25" x 4.50" x 3" Round Light 6900 Lumens, 50 Watts, 4.10 Amps 90° Flood Pattern For 9 Volt to 32 Volt Systems Includes Mounting Bracket and Stainless Steel Hardware	AMTL500WF	\$ 120.00	
 8100, 8100T, 8110, 8110T, 8200, 8200T, 8210, 8210T, 8300, 8300T, 8310, 8310T, 8400, 8400T, 8410, 8410T, 9100, 9200, 9300, 9300T, 9400, 9400T	LED Floodlight All-Position Light 4" x 6" Oval Light 2450 Lumens, 24 Watts, 2 Amps Plugs directly into existing wire harness w/ no modifications Replaces RE154900	AMRE154898	\$ 75.00	
 Universal Equipment	LED Floodlight, Sealed Beam Fender Mount 4.50" Diameter Round Light 1250 Lumens, 18 Watts, 1.50 Amps Trapezoid Pattern For 12 Volt to 24 Volt Systems Replaces AF3892R, AT25451, RE285628, RE336111, RE561116, RE561117	AMTL3010	\$ 40.00	
	LED Floodlight Fender Mount 4.50" Diameter Sealed Beam Round Light 1250 Lumens, 18 Watts, 1.20 Amps Trapezoid Pattern For 12 Volt to 24 Volt Systems Lasts 50 times longer than halogen lighting, vibration resistant w/ no filament failures, uses original mount and wiring, Operating temperature of -40°F to 140°F / -40°C to 60°C Replaces AF3892R, AT25451, RE285628, RE336111, RE561116, RE561117	AMRE336111	\$ 35.00	
 Universal Equipment	LED Floodlight Fender Mount 4.50" Diameter Sealed Beam Round Light 1440 Lumens, 18 Watts, 1.60 Amps Lasts 50 times longer than halogen lighting, vibration resistant w/ no filament failures, 2-terminal connection, Operating temperature of -40°F to 140°F / -40°C to 60°C Replaces RE285628	AMRE336112	\$ 67.75	





John Deere®—Tractor

Application	Description	Part Number	Retail Price	Core
 9100, 9200, 9300, 9300T, 9400, 9400T	LED Floodlight Fender Mount 6" x 3" Rectangle Light 3600 Lumens, 40 Watts, 3.33 Amps For 12 Volt to 24 Volt Systems Uses Original Mount and Wiring Includes Connector, Mounting Bracket and Stainless Steel Hardware	AMTL3080	\$ 90.00	
	LED Floodlight Fender Mount 6" x 3" Rectangle Light 3600 Lumens, 40 Watts, 3.33 Amps For 12 Volt to 24 Volt Systems	AMRE68473	\$ 72.00	
 5055E, 5065E, 5075E, 5075M, 5083E, 5083EN, 5085M, 5093E, 5093EN, 5100M, 5100MH, 5101E, 5101EN, 5115M, 5220, 5225, 5320, 5325, 5325N, 5420, 5425, 5425N, 5520, 5525, 5525N, 5603, 5625, 6105M, 6110M, 6115M, 6120, 6120M, 6125M, 6130M, 6140M, 6145M, 6150M, 6155M, 6170M, 6175M, 6195M, 6215, 6220, 6230, 6320, 6320L, 6330, 6415, 6420, 6420L, 6430, 6520L, 6615, 6715, 7130, 7220, 7230, 7320, 7330, 7420, 7520	LED Floodlight 4.25" x 4.50" x 3.00" Oval Light 3200 Lumens, 40 Watts, 3.20 Amps For 12 Volt to 24 Volt Systems Housing Has Powder Coat Finish Includes 2-Terminal Connector, Mounting Bracket and Stainless Steel Hardware Replaces AL150478, AL174341, AL175528, AL175529, AL202742, AL202743, AL205375, RE219708, RE233263, RE567623	AMTL5670	\$ 105.00	
	LED Floodlight 4.25" x 4.50" x 3" Oval Light 3200 Lumens, 40 Watts, 3.20 Amps For 12 Volt to 24 Volt Systems Housing Has Powder Coat Finish Includes 2-Terminal Connector, Mounting Bracket and Stainless Steel Hardware Replaces AL150478, AL174341, AL175528, AL175529, AL202742, AL202743, AL205375, RE219708, RE233263	AMRE567623	\$ 84.00	
 7630, 7720, 7730, 7820, 7830, 7920, 7930, 8120, 8120T, 8130, 8220, 8220T, 8225R, 8230, 8230T, 8245R, 8270R, 8295RT, 8320, 8320R, 8320RT, 8320T, 8330, 8330T, 8345R, 8345RT, 8420, 8420T, 8430, 8430T, 8520, 8520T, 8530, 9120, 9220, 9230, 9320, 9320T, 9330, 9420, 9420T, 9430, 9430T, 9520, 9520T, 9530, 9530T, 9620, 9620T, 9630, 9630T Replaces RE173600, RE260102	LED Floodlight Hood Mount 6.50" x 4.50" x 4" Oval Light Dual Hi/Lo Beam 6000 Lumens, 65 Watts, 5.40 Amps For 12 Volt to 24 Volt Systems Uses Original Mount and Wiring, Plug-and-Play	AMTL8520S	\$ 125.00	
	LED Floodlight Hood Mount 6.50" x 4.50" x 4" Oval Light Dual Hi/Lo Beam 6000 Lumens, 65 Watts, 5.40 Amps For 12 Volt to 24 Volt Systems Uses Original Mount and Wiring, Plug-and-Play	AMRE173600	\$ 112.50	
 8120, 8120T, 8220, 8220T, 8225R, 8245R, 8270R, 8295R, 8295RT, 8320, 8320R, 8320RT, 8320T, 8345R, 8345RT, 8420, 8420T, 8520, 8520T Replaces RE180613, RE181282, RE271573, RE271574	LED Floodlight Hood Mount 5.50" x 3.75" Oval Light 3000 Lumens, 35 Watt, 2.90 Amps For 12 Volt to 24 Volt Systems Use Original Mount and Wiring, Plug-and-Play	AMTL8220	\$ 115.00	
	LED Floodlight Hood Mount 5.50" x 3.75" Oval Light 3000 Lumens, 39 Watts, 2.90 Amps For 12 Volt to 25 Volt Systems Includes Connector for Plug-and-Play Installation Replace 86038024, RE180613, RE181282, RE271573	AMRE271574	\$ 92.00	



John Deere®—Tractor

Application	Description	Part Number	Retail Price	Core
 9120, 9220, 9230, 9320, 9330, 9420, 9420T, 9430, 9430T, 9520, 9520T, 9530, 9530T, 9620, 9620T, 9630, 9630T	LED Floodlight Hood Mount 5.50" x 3.75" Oval Light 3000 Lumens, 35 Watts, 2.90 Amps For 12 Volt to 24 Volt Systems Uses Original Mount and Wiring, Plug-and-Play Replaces 86038024, RE180613, RE181282, RE271573, RE271574	AMTL9220	\$ 115.00	
 7630, 7720, 7730, 7820, 7830, 7920, 7930, 8120, 8130, 8220, 8230, 8245R, 8270R, 8295R, 8320, 8320R, 8330, 8330T, 8345R, 8420, 8430, 8430T, 8520, 8530	LED Headlight Hood Mount 7.12" x 4.75" x 3" Oval Light Dual Hi/Lo Beam 5000 Lumens, 65 Watts, 5.40 Amps For 12 Volt to 24 Volt Systems Plug-and-Play, Uses Original Hardware Replaces RE181963, RE181964, RE205360	AMTL7820	\$ 125.00	
	LED Headlight Hood Mount 7" x 4.75" x 3.25" Oval Light Dual Hi/Lo Beam 5000 Lumens, 65 Watts, 5.40 Amps For 12 Volt to 24 Volt Systems Uses Original Mount and Hardware, Plug-and-Play Replaces RE181963, RE181964, RE205360	AMRE181963	\$ 100.00	
 Most Models	LED Floodlight Hood, Front and Rear Fender Mount 5" Diameter Round Light 2800 Lumens, 40 Watts, 3.30 Amps Trapezoid Pattern 1/2" rear stud mount w/ built-in heat sink for cooling, a brighter light and longer life, Includes both long and short rubber bezels, For use w/ stud mounted front fender lights	AMAR85859	\$ 90.00	
 4040, 4050, 4055, 4240, 4250, 4255, 4440, 4450, 4455, 4555, 4560, 4640, 4650, 4755, 4760, 4840, 4850, 4955, 4960, 6110, 6200, 6210, 6300, 6310, 6400, 6410, 6500, 7200, 7210, 7400, 7410, 7510, 7600, 7610 BSN	LED Floodlight Replacement Hood and Cab Mount 2.49" x 5.44" Rectangle Light 1440 Lumens, 12 Watts, 1 Amp For 12 Volt to 24 Volt Systems Uses Original Mount and Wiring Replaces R161288, RE37450, RE306510	AMX34182	\$ 40.00	
	LED Floodlight Replacement Hood and Cab Mount 2.49" x 5.44" Rectangle Light 1440 Lumens, 12 Watts, 1 Amp For 12 Volt to 24 Volt Systems Replaces RE161288, RE37450, RE37849	AMRE306510	\$ 32.00	
 5220, 5225, 5320, 5325, 5420, 5425, 5520, 5525, 6105, 6120, 6215, 6220, 6230, 6320, 6320L, 6330, 6403, 6415, 6420, 6420L, 6420S, 6430, 6520, 6520L, 6603, 6615, 6715, 7130, 7200, 7220, 7230, 7320, 7330, 7400 (Bracket Required), 7420, 7520, 7610, 7710, 7720, 7810, 7820, 7920	LED Floodlight Cab Mount 4.25" x 4.50" Oval Light 3600 Lumens, 40 Watts, 3.20 Amps For 12 Volt to 24 Volt Systems Replaces RE567623, AL150478, AL156627, AL174341, AL175528, AL175529, AL202742, AL202743, AL205375	AMRE219708	\$ 105.00	
 Universal Equipment	LED Floodlight Cab and Fender Mount 3.50" x 6" Rectangle Light 3600 Lumens, 40 Watts, 3 Amps	AMX34146	\$ 65.00	





John Deere®—Tractor

Application	Description	Part Number	Retail Price	Core
 <p>2350, 2355, 2550, 2555, 2750, 2755 GPT, 2855N, 2950, 2955 BSN 765516, 3055, 3150, 3155, 3255, 4030, 4040, 4050, 4055, 4230, 4240, 4250, 4255, 4430, 4440, 4450, 4455, 4555, 4560, 4630, 4640, 4650, 4680, 4755, 4760, 4840, 4850, 4955, 4960 Replaces AR85260, RE10965, RE12718</p>	<p>LED Floodlight Cab and Fender Mount 4.50" Diameter Round Light 3200 Lumens, 40 Watts, 3.30 Amps For 12 Volt to 24 Volt Systems Includes Mounting Bracket and Stainless Steel Hardware</p>	AMX34183	\$ 105.00	
	<p>LED Floodlight Cab and Fender Mount 4.50" Diameter Round Light 3200 Lumens, 40 Watts, 3.30 Amps For 12 Volt to 24 Volt Systems Includes Mounting Bracket and Stainless Steel Hardware</p>	AMRE19079	\$ 84.00	
 <p>7630, 7720, 7730, 7820, 7830, 7920, 7930, 8120, 8120T, 8130, 8220, 8220T, 8225R, 8230, 8230T, 8235R, 8245R, 8260R, 8270R, 8285R, 8295R, 8295RT, 8310R, 8310RT, 8320, 8320R, 8320RT, 8320T, 8330, 8330T, 8335R, 8335RT, 8345R, 8345RT, 8360RT, 8420, 8420T, 8430, 8430T, 8520, 8520T, 8530, 9120, 9220, 9230, 9320, 9320T, 9330, 9420, 9420T, 9430, 9430T, 9520, 9520T, 9530, 9530T, 9620, 9620T, 9630, 9630T Replaces AH212522, AH212576, RE181281</p>	<p>LED Floodlight Upper Front and Rear Cab, Rear Fender and Mid Mount 6.50" x 4" Oval Light 5200 Lumens, 65 Watts, 5.40 Amps For 12 Volt to 24 Volt Systems Housing Has Powder Coat Finish Includes Mounting Bracket and Stainless Steel Hardware</p>	AMTL5680	\$ 125.00	
	<p>LED Floodlight Upper Front and Rear Cab, Rear Fender and Mid Mount 6.50" x 4" Oval Light 5500 Lumens, 65 Watts For 12 Volt to 24 Volt Systems Housing Has Powder Coat Finish Includes Connector and Bracket for Plug-and-Play Installation</p>	AMAH212523	\$ 100.00	
 <p>5200, 5210, 5300, 5310, 5400, 5410, 5500, 5510, 6105M, 6110, 6115M, 6120, 6125M, 6200, 6210, 6215, 6220, 6230, 6300, 6310, 6310S, 6320, 6320L, 6330, 6400, 6405, 6410, 6410S, 6415, 6420, 6420L, 6430, 6500, 6510S, 6520L, 6605, 6615, 6715, 7130, 7200, 7210, 7220, 7230, 7320, 7330, 7400, 7410, 7420, 7430, 7510, 7520, 7600, 7610, 7700, 7710, 7800, 7810</p>	<p>LED Floodlight, Right Hand Cab Mount 4.75" x 3.25" x 2.50" Rectangle Light Amber Lens, 7 Watts, 0.06 Amp For 12 Volt to 24 Volt Systems Includes Stainless Steel Hardware and Plug-and-Play Installation Replaces RE39582</p>	AMTL7020R	\$ 50.00	
	<p>LED Floodlight, Left Hand Cab Mount 4.75" x 3.25" x 2.50" Rectangle Light, Amber Lens, 7 Watts, 0.06 Amp For 12 Volt to 24 Volt Systems Includes Stainless Steel Hardware and Plug-and-Play Installation Replaces RE39581</p>	AMTL7020L	\$ 50.00	
 <p>7200, 7210, 7400, 7410, 7510, 7600, 7610, 7700, 7710, 7800, 7810, 8100, 8100T, 8110, 8110T, 8200, 8200T, 8210, 8210T, 8300, 8300T, 8310, 8310T, 8400, 8400T, 8410, 8410T, 9100, 9200, 9300, 9300T, 9400, 9400T Replaces RE154898, RE154900, RE154901, RE154902, RE154903, RE154904, RE154906</p>	<p>LED Floodlight Rectangle Light 3200 Lumens, 40 Watts, 3.20 Amps For 12 Volt to 24 Volt Systems Includes Interchangeable Mounts</p>	AMTL8400	\$ 99.00	
	<p>LED Floodlight 6" x 4" Rectangle Light 3200 Lumens, 40 Watts, 3.20 Amps For 12 Volt to 24 Volt Systems</p>	AMRE154908	\$ 79.20	







John Deere®—Tractor

	Application	Description	Part Number	Retail Price	Core
	5105, 6110, 6110L, 6200, 6200L, 6210, 6210L, 6300, 6300L, 6310, 6310L, 6310S, 6400, 6400L, 6405, 6410, 6410L, 6410S, 6500, 6500L, 6510L, 6510S, 6605, 7200, 7210, 7400, 7410, 7600, 7610, 7700, 7710, 7800, 7810	LED Floodlight/Spotlight Combo Grille Mount 6" x 4" Rectangle Light 3500 Lumens, 60 Watts, 5 Amps For 12 Volt to 24 Volt Systems Includes Connector, Adapter and Stainless Steel Hardware Replaces AL75338	AMTL6700	\$ 110.00	
		LED Floodlight/Spotlight Combo Grille Mount 6" x 4" Rectangle Light 3500 Lumens, 60 Watts, 5 Amps For 12 Volt to 24 Volt Systems Includes Connector, Adapter and Mounting Hardware	AMAL75338	\$ 88.00	
	5055E, 5065E, 5065M, 5075E, 5075M, 5083EN, 5093E, 5093EN, 5095M, 5095MH, 5101EN, 5105M, 5105ML, 5225, 5325, 5325N, 5425, 5425N, 5525, 5525N, 5725N, 6100D, 6110D, 6115D, 6120, 6120L, 6125D, 6130D, 6140J, 6155J, 6215, 6220, 6220L, 6320, 6320L, 6415, 6420, 6420L, 6520L, 6615, 6645, 6715, 7220, 7320, 7420, 7515, 7520 Replaces AL152329, RE269110	LED Floodlight/Spotlight Combo Grille Mount 6" x 4" Rectangle Light 3500 Lumens, 60 Watts, 5 Amps For 12 Volt to 24 Volt Systems Includes Mounting Bracket and Stainless Steel Hardware	AMTL6420	\$ 110.00	
		LED Floodlight/Spotlight Combo Grille Mount 6" x 4" Rectangle Light 3500 Lumens, 60 Watts, 5 Amps For 12 Volt to 24 Volt Systems Includes Mounting Bracket and Stainless Steel Hardware	AMAL152328	\$ 88.00	
	2355, 2555, 2755, 2855N, 2940, 2955, 3055, 3150, 3155, 3255, 4030, 4040, 4050, 4230, 4240, 4250, 4320, 4430, 4440, 4450, 4630, 4640, 4650, 4840, 4850, 5020, 8430, 8630	LED Floodlight/Spotlight Combo Fender Mount 4.50" Sealed Beam Round Light, Dual Hi/Low Beam 2200 Lumens, 24 Watts, 2 Amps For 12 Volt to 24 Volt Systems Uses Original Mount and Wiring (Plug-and-Play) Includes Wired Cable for Installation Replaces RE25126	AMTL3020	\$ 50.00	
		LED Floodlight/Spotlight Combo Fender Mount 4.50" Sealed Beam Round Light Dual Hi/Low Beam 2200 Lumens, 24 Watts, 3 Amps For 12 Volt to 24 Volt Systems Replaces AR85263, AR85264, AR93335, RE10962, RE10963, RE19081, RE19082, RE25126	AMAR48723	\$ 40.00	



John Deere®—Tractor

Application	Description	Part Number	Retail Price	Core
 <p>2355, 2555, 2755, 2855N, 2940, 2955, 3055, 3150, 3155, 3255, 4030, 4040, 4050, 4230, 4240, 4250, 4320, 4430, 4440, 4450, 4630, 4640, 4650, 4840, 4850, 5020, 8430, 8630 Replaces RE25126</p>	LED Floodlight/Spotlight Combo Fender Mount 4.50" Sealed Beam Round Light Dual Hi/Lo Beam 2200 Lumens, 24 Watts, 2 Amps For 12 Volt to 24 Volt Systems Uses Original Mount and Wiring, Plug-and-Play Screwed Connection for Installation	AMTL3025	\$ 50.00	
	LED Floodlight/Spotlight Combo Fender Mount 4.50" Sealed Beam Round Light Dual Hi/Lo Beam 2200 Lumens, 24 Watts, 2 Amps For 12 Volt to 24 Volt Systems Uses Original Mount and Wiring, Plug-and-Play Screwed Connection for Installation	AMAR85263	\$ 40.00	
 <p>4560, 4760, 4960</p>	LED Floodlight/Spotlight Combo Fender Mount 6" x 4" Rectangle Light, Dual Hi/Lo Beam 3500 Lumens, 60 Watts, 5 Amps For 12 Volt to 24 Volt Systems Uses Original Mount and Wiring Bezel Not Included	AMTL6060	\$ 99.00	
 <p>9100, 9200, 9300, 9300T, 9400, 9400T</p>	LED Floodlight/Spotlight Combo Hood Mount 6" x 4" Rectangle Light 3500 Lumens, 60 Watts, 5 Amps For 12 Volt to 24 Volt Systems Uses Original Mount and Wiring	AMTL9010	\$ 99.00	
 <p>5105, 5200, 5205, 5210, 5220, 5300, 5310, 5320, 5400, 5403, 5410, 5420, 5500, 5510, 5520</p>	LED Floodlight/Spotlight Combo Hood Mount 6" x 4" Rectangle Light, Dual Hi/Lo Beam 3500 Lumens, 60 Watts, 5 Amps For 12 Volt to 24 Volt Systems Uses Original Mount and Wiring Includes Connector, Adapter and Stainless Steel Hardware	AMTL5500	\$ 110.00	
 <p>6105R, 6110R, 6115R, 6120R, 6125R, 6130R, 6140R, 6145R, 6150R, 6150RH, 6155R, 6155RH, 6170R, 6175R, 6190R, 6195R, 6210R, 6215R, 7200R, 7210R, 7215R, 7230R, 7250R, 7260R, 7270R, 7280R, 7290R, 7310R, 8225R, 8235R, 8245R, 8260R, 8270R, 8285R, 8295R, 8295RT, 8310R, 8310RT, 8320R, 8320RT, 8335R, 8335RT, 8345R, 8345RT, 8360R, 8360RT, 8370R, 8370RT, 8400R, 9360R, 9370R, 9410R, 9420R, 9460R, 9460RT, 9470R, 9470RT, 9470RX, 9510R, 9510RT, 9520R, 9520RT, 9520RX, 9560R, 9560RT, 9570R, 9570RT, 9570RX, 9620R, 9620RX Replaces RE269637, RE331642</p>	LED Floodlight/Spotlight Combo Upper Cab Mount 6" x 3" x 3.25" Oval Light 3200 Lumens, 40 Watts, 3.30 Amps For 12 Volt to 24 Volt Systems Uses Original Hardware, Plug-and-Play Plastic Bezel Not Included	AMTL8050	\$ 95.00	



John Deere®—Tractor

Application	Description	Part Number	Retail Price	Core	
	5085E, 5085M, 5100E, 5100M, 5115M, 6105R, 6110R, 6115R, 6120R, 6125R, 6130R, 6140R, 6145R, 6150R, 6150RH, 6155R, 6155RH, 6170R, 6175R, 6190R, 6195R, 6210R, 6215R, 7200R, 7210R, 7215R, 7230R, 7250R, 7260R, 7270R, 7280R, 7290R, 7310R, 8225R, 8235R, 8245R, 8260R, 8270R, 8285R, 8295R, 8295RT, 8310R, 8310RT, 8320R, 8320RT, 8335R, 8335RT, 8345R, 8345RT, 8360R, 8360RT, 8370R, 8370RT, 8400R, 9360R, 9370R, 9410R, 9420R, 9460R, 9460RT, 9470R, 9470RT, 9470RX, 9510R, 9510RT, 9520R, 9520RT, 9520RX, 9560R, 9560RT, 9570R, 9570RT, 9570RX, 9620R, 9620RX	LED Floodlight/Spotlight Combo Cab Mount 6" x 3" x 3.25" Oval Light 3000 Lumens, 40 Watts, 3.30 Amps For 12 Volt to 24 Volt Systems Plug-and-Play for Direct Replacement Replaces RE269640, RE331643, RE573609	AMTL8060	\$ 95.00	
		LED Floodlight/Spotlight Combo Cab Mount 6" x 3" x 3.25" Oval Light 3000 Lumens, 40 Watts, 3.30 Amps For 12 Volt to 24 Volt Systems Plug-and-Play for Direct Replacement Replaces AL207359, RE269640, RE331643, RE573609	AMRE269638	\$ 76.00	
	Universal Equipment LED Spotlight All-Position Light 4.25" x 4.25" Square Light 1400 Lumens, 27 Watts, 2.20 Amps For 12 Volt to 24 Volt Systems	AMTL100S	\$ 45.00		
	Universal Equipment LED Spotlight All-Position Light 6.25" x 1.75" Rectangle Light 1300 Lumens, 18 Watts, 1.50 Amps For 12 Volt to 24 Volt Systems Includes Mounting Bracket and Stainless Steel Hardware	AMTL118S	\$ 50.00		
	Universal Equipment LED Spotlight All-Position Light Round Light 6900 Lumens, 50 Watts, 4.10 Amps For 9 Volt to 32 Volt Systems Includes Mounting Bracket and Stainless Steel Hardware	AMTL500S	\$ 120.00		
	2010, 2040, 2240, 2510, 2520, 2840, 2940, 3010, 3020, 4000, 4010, 4020, 4030, 4040, 4050, 4055, 4230, 4240, 4250, 4255, 4320, 4430, 4440, 4450, 4455, 4520, 4555, 4560, 4620, 4630, 4640, 4650, 4755, 4760, 4840, 4850, 4955, 4960, 5010, 5020, 6030, 7020, 7520, 8440, 8450, 8560, 8570, 8630, 8640, 8650, 8760, 8770, 8850, 8870, 8960, 8970, 9100, 9200, 9300, 9400	LED Trapezoid Light Fender Mount 4.50" Sealed Beam Round Light 2200 Lumens, 24 Watts, 2 Amps For 12 Volt to 24 Volt Systems Uses Original Mount and Wiring Replaces RE336111	AMTL3015	\$ 50.00	
	8120, 8120T, 8130, 8220, 8220T, 8230, 8230T, 8320, 8320T, 8330, 8330T, 8420, 8420T, 8430, 8430T, 8520, 8520T, 8530, 9120, 9220, 9230, 9320, 9320T, 9330, 9420, 9420T, 9430, 9430T, 9520, 9520T, 9530, 9530T, 9620, 9620T, 9630, 9630T	LED Light Kit Includes (2) LED Hood Lights, Hi/Lo Beam*, (4) LED Inner Hood Lights**, (6) LED Work Lights***, Connectors and Mounting Hardware For 12 Volt to 24 Volt Systems Plug-and-Play Installation *6000 Lumens, 65 Watts, 5.40 Amps **3000 Lumens, 35 Watts, 2.90 Amps ***5200 Lumens, 65 Watts, 5.40 Amps	AMX34189	\$ 1200.00	

John Deere®—Tractor

Application	Description	Part Number	Retail Price	Core	
	Universal Equipment LED Trapezoid Light Cab and Fender Mount 4.50" Diameter Round Light 2800 Lumens, 40 Watts, 3.30 Amps Trapezoid Pattern For 12 Volt to 24 Volt Systems Bottom Mount w/ Built-In Heat Sink Includes Mounting Bracket, Long and Short Rubber Bezels and Stainless Steel Hardware Replaces AR85260, RE19079	AMTL2080	\$ 95.00		
	LED Trapezoid Light Cab and Rear Fender Mount 4.50" Diameter Round Light 2800 Lumens, 40 Watts, 3.30 Amps Trapezoid Pattern For 12 Volt to 24 Volt Systems Bottom Mount w/ Built-In Heat Sink Includes Mounting Bracket, Long and Short Rubber Bezels and Stainless Steel Hardware Replaces AR85260, RE19079	AMX33121	\$ 76.00		
	7630, 7720, 7730, 7820, 7830, 7920, 7930, (8120, 8120T, 8220, 8220T, 8320, 8320T, 8420, 8420T, 8520, 8520T ASN 014367), 8130, 8230, 8230T, 8330, 8330T, 8430T, 8530 Nite-Gard® Warning Light Assembly Complete Assembly for Both Sides of the Tractor, Pre-Assembled Extendable Arms from 36"-52" Includes (2) Amber Lens Warning Lights, (2) Universal Breakaway Mounting Brackets, Ag Yellow Reflective Front-Facing Tape, Red Reflective Rear-Facing Tape, Red-Orange Fluorescent Rear-Facing Tape and Mounting Hardware	AMSS3244	\$ 497.00		
	900HC, 950, 970, 1020, 1250, 1450, 1520, 1530, 1650, 2020, 2030, 2040, 2150, 2255, 2350, 2355, 2440, 2550, 2555, 2630, 2640, 2750, 2755, 2840, 2855, 2940, 2950, 2955, 3055, 3150, 3155, 3255, 4030, 4040, 4050, 4055, 4230, 4240, 4250, 4255, 4430, 4440, 4450, 4455, 4555, 4560, 4630, 4640, 4650, 4755, 4760, 4840, 4850, 4955, 4960, 5200, 5300, 5400, 5500, 6100, 6110, 6200, 6210, 6300, 6310, 6400, 6403, 6405, 6410, 6500, 6600, 6603, 6605, 7200, 7210, 7220, 7320, 7400, 7405, 7410, 7420, 7510, 7520, 7600, 7610, 7700, 7710, 7800, 7810, 8430, 8440, 8450, 8560, 8570, 8630, 8640, 8650, 8760, 8770, 8850, 8870, 8960, 8970, Utility: 820, 850, 870, 1050, 1070, 2155, 2240 - All w/ Sound-Gard™ Cab)	LED Warning Light Cab Mount 2" x 7.75" Rectangle Light Amber Lens 9 Watts, 0.75 Amp For 12 Volt to 24 Volt Systems Requires 6 Ohm Load Resistor if 4 Lights Are Installed	AMX34184	\$ 50.00	
	LED Warning Light Cab Mount 2" x 7.75" Rectangle Light Amber Lens 9 Watts, 0.75 Amp For 12 Volt to 24 Volt Systems Requires 6 Ohm Load Resistor if 4 Lights Are Installed	AMAR60250	\$ 40.00		





John Deere®—Tractor

Application	Description	Part Number	Retail Price	Core	
	5055E, 5065E, 5065M, 5075E, 5075M, 5076E, 5082E, 5083E, 5083EN, 5085E, 5085M, 5090E, 5090EH, 5093E, 5093EN, 5095M, 5095MH, 5100E, 5100M, 5100MH, 5101E, 5101EN, 5105M, 5115M, 5220, 5225, 5320, 5325, 5325N, 5420, 5425, 5425N, 5520, 5525, 5525N, 5603, 5625, 5725, 6100D, 6105D, 6105E, 6105M, 6110D, 6110M, 6115D, 6115M, 6120, 6120E, 6120M, 6125D, 6125M, 6130D, 6130M, 6135E, 6140D, 6140J, 6140M, 6145M, 6150M, 6155J, 6155M, 6170M, 6175M, 6195M, 6215, 6220, 6230, 6320, 6330, 6403, 6415, 6420, 6430, 6603, 6615, 6715, 7130, 7220, 7230, 7320, 7330, 7420, 7430, 7520, 7530, 7630, 7730, 7830, 7930, 8130, 8230, 8230T, 8330, 8330T, 8430, 8430T, 8530, 9120, 9220, 9230, 9320, 9320T, 9330, 9420, 9420T, 9430, 9430T, 9520, 9520T, 9530, 9530T, 9620, 9620T, 9630, 9630T, Utility: 3033R, 3039R, 3046R, 3320, 3520, 3720, 4044R, 4052R, 4066R, 4320, 4520, 4720	LED Warning Light Floodlight 6.75" x 4" x 2.75" Rectangle Light Amber Lens, 11 Watts, 0.90 Amp For 12 Volt to 24 Volt Systems Plug-and-Play for Direct Replacement Includes Stainless Steel Hardware Replaces AT151873, AT326622	AMTL8020	\$ 50.00	
	LED Warning Light Floodlight 6.75" x 4" x 2.75" Rectangle Light Amber Lens, 11 Watts, 0.90 Amp For 12 Volt to 24 Volt Systems Plug-and-Play for Direct Replacement Includes Stainless Steel Hardware Replaces AT151873, AT326622	AMRE217551	\$ 40.00		
	5090R, 5100R, 5115R, 5125R, 6105R, 6110R, 6115R, 6120R, 6125R, 6130R, 6140R, 6145R, 6150R, 6150RH, 6155R, 6155RH, 6170R, 6175R, 6190R, 6195R, 6210R, 6215R, 7200R, 7210R, 7215R, 7230R, 7250R, 7260R, 7270R, 7280R, 7290R, 7310R, 8225R, 8235R, 8245R, 8260R, 8270R, 8285R, 8295R, 8295RT, 8310R, 8310RT, 8320R, 8320RT, 8335R, 8335RT, 8345R, 8345RT, 8360R, 8360RT, 8370R, 8370RT, 8400R, 9360R, 9370R, 9410R, 9420R, 9420RX, 9460R, 9460RT, 9470R, 9470RT, 9470RX, 9510R, 9510RT, 9520R, 9520RT, 9520RX, 9560R, 9560RT, 9570R, 9570RT, 9570RX, 9620R, 9620RX	LED Warning Light Cab Mount Floodlight/Spotlight Combo 6" x 3" x 3.25" Oval Light 40 Watts, 3.20 Amps For 12 Volt to 24 Volt Systems Polycarbonate Lens w/ Amber Bulb Aluminum Housing, Plug-and-Play Includes Plastic Bezel Uses Original Hardware Replaces AT151873, AT326622	AMTL8070	\$ 95.00	
	LED Warning Light Cab Mount Floodlight/Spotlight Combo 6" x 3" x 3.25" Oval Light 40 Watts, 3.20 Amps For 12 Volt to 24 Volt Systems Polycarbonate Lens w/ Amber Bulb Aluminum Housing, Plug-and-Play Includes Plastic Bezel Uses Original Hardware Replaces AT151873, AT326622	AMRE269636	\$ 76.00		
	Universal Equipment	LED Warning Light Cab, Header or Swather Mount Can be used for Turn Signal, Brake or Running Lights 4.125" Diameter Round Light Double Sided, Amber Lenses 25 Bulbs per Side For 12 Volt to 24 Volt Systems	AMTLFL2	\$ 55.00	
	LED Warning Light Cab, Header or Swather Mount Can be used for Turn Signal, Brake or Running Lights 4.125" Diameter Round Light Double Sided, Amber Lenses 25 Bulbs per Side For 12 Volt to 24 Volt Systems	AMX1910149	\$ 44.00		

John Deere®—Tractor

Application	Description	Part Number	Retail Price	Core
 Universal Equipment	LED Warning Light Cab, Header or Swather Mount Can be used for Turn Signal, Brake or Running Lights 4.125" Diameter Round Light Double Sided, Red and Amber Lenses 25 Bulbs per Side For 12 Volt to 24 Volt Systems	AMTLFL3	\$ 55.00	
	LED Warning Light Cab, Header or Swather Mount Can be used for Turn Signal, Brake or Running Lights 4.125" Diameter Round Light Double Sided, Red and Amber Lenses 25 Bulbs per Side For 12 Volt to 24 Volt Systems	AMX33126	\$ 44.00	
 Universal Equipment	LED Magnetic Warning Light All-Position Light 360° Flashing Light, Multiple Patterns 9.50" x 6.75" Rectangle Light Magnetic Base or Solid Mount For 12 Volt to 24 Volt Systems Includes Cigarette Lighter Adapter, Wiring and Switch	AMTL1100	\$ 170.00	
 Universal Equipment	LED Magnetic Warning Light All-Position Light 360° Flashing Light, Multiple Patterns 14" x 6.75" Rectangle Light Magnetic Base or Solid Mount For 12 Volt to 24 Volt Systems Includes Cigarette Lighter Adapter, Wiring and Switch	AMTL1200	\$ 190.00	
Universal Equipment	Warning Beacon 360° Flashing Beacon, Amber Lens For 0.9435" Diameter Pipe Replaces 84337818, AZ44705, AZ101891	AM82018390	\$ 45.64	
 Universal Equipment	LED Warning Beacon 360° Flashing Beacon 2.75" x 5.25" Light Polycarbonate Amber Lens and Housing For 12 Volt to 24 Volt Systems Includes Solid Mounting Pad and Stainless Steel Hardware	AMTL2100	\$ 30.00	
 Universal Equipment	LED Warning Beacon 360° Flashing Beacon, 3 Different Patterns 5" x 10" Light Amber Lens, 48 Watts, 4 Amps For 12 Volt to 24 Volt Systems Brackets Sold Separately	AMX33131	\$ 75.00	
 Universal Equipment	Warning Beacon Bracket	AMX33132	\$ 15.00	
 Universal Equipment	Warning Beacon Bracket	AMX33133	\$ 15.00	



John Deere®—Tractor

	Application	Description	Part Number	Retail Price	Core
	Universal Equipment	Warning Beacon Bracket	AMX33137	\$ 15.00	
	Universal Equipment	Warning Beacon Bracket	AMX33135	\$ 15.00	
	(6110, 6210, 6310, 6410 - w/ Cab or ASN 294394 w/ 2-Post Canopy Top), (6100D, 6110D, 6115D, 6125D, 6130D, 6140D BSN 050001), 6120M, 6130M, 6200, (6210L, 6310L, 6410L, 6510L ASN 294394), 6230, 6300, 6310S, 6330, 6400, 6410S, 6510S, 7600, 7610, 7700, 7710, 7800, 7810, 8100, 8200, 8300, 8400	Tail Light Assembly	AMAL112964	\$ 48.66	
	2140, 2350, 2355, 2510, 2550, 2555, 2750, 2755, 2855N, 2940, 2950, 2955, 3020, 3040, 3055, 3140, 3150, 3155, 3255, 4000, 4020, 4030, 4040, 4050, 4055, 4230, 4240, 4250, 4255, 4320, 4430, 4440, 4455, 4520, 4560, 4620, 4630, 4640, 4650, 4755, 4760, 4840, 4850, 4955, 4960, 5020, 5210, 5310, 5410, 5510, 6030, 7020, 7520, 8430, 8440, 8450, 8630, 8640, 8650, 8850	LED Tail Light Oval Light, Red Lens 9 Watts, 0.75 Amp For 12 Volt to 24 Volt Systems Replaces RE39223	AMAR78825	\$ 49.00	
	9100, 9120, 9200, 9220, 9300, 9320, 9400, 9420, 9520, 9620	LED Light Bar Kit Includes AMLED50C LED Light Bar, (2) Mounting Brackets and (2) Clamps	AMX34145	\$ 475.00	

John Deere®—Tractor

Application	Description	Part Number	Retail Price	Core
 Universal Equipment	LED Light Bar 4" Long, 1260 Lumens, Cree Bulbs	AMLED4	\$ 45.00	
	LED Light Bar Flood/Spotlight Combo 10" Long, 5700 Lumens, 50 Watts, 4.20 Amps For 12 Volt to 24 Volt Systems Includes Mounting Bracket and Stainless Steel Hardware	AMTL10SRC	\$ 129.00	
	LED Light Bar Floodlight/Spotlight Combo 14" Long, 5400 Lumens, 72 Watts, 6 Amps Die Cast Aluminum Housing, Polycarbonate Lens For 12 Volt to 24 Volt Systems Includes Mounting Bracket and Heavy Duty Stainless Steel Hardware	AMTLB410C	\$ 150.00	
	LED Light Bar Floodlight/Spotlight Combo 30" Long, 13600 Lumens, 150 Watts, 12.50 Amps For 12 Volt to 24 Volt Systems Includes Mounting Bracket and Stainless Steel Hardware	AMTL30SRC	\$ 230.00	
	LED Light Bar 30" Long, 13860 Lumens, Cree Bulbs	AMLED30	\$ 130.00	
	LED Light Bar Floodlight/Spotlight Combo 40" Long, 17300 Lumens, 200 Watts, 16.70 Amps For 12 Volt to 24 Volt Systems Includes Mounting Brackets and Stainless Steel Hardware	AMTL40SRC	\$ 300.00	
	LED Light Bar 40" Long, 18200 Lumens, Cree Bulbs	AMLED40	\$ 160.00	
	LED Light Bar Floodlight/Spotlight Combo 42" Long, 14500 Lumens, 240 Watts, 19 Amps For 12 Volt to 24 Volt Systems Includes Mounting Bracket and Stainless Steel Hardware Replaces 1163691	AMTLB440C	\$ 250.00	
	LED Light Bar, Curved 50" Long, 21500 Lumens, Cree Bulbs	AMLED50C	\$ 190.00	
	 7200, 7210, 7400, 7410, 7510, 7600, 7610, 7700, 7710, 7720, 7800, 7810, 7815, 7820, 7920, 8100, 8110, 8120, 8200, 8210, 8220, 8300, 8310, 8320, 8400, 8410, 8420, 8520, 9100, 9120, 9200, 9220, 9300, 9320, 9400, 9420, 9520, 9620	LED Corner Floodlight Cab Mount 8.75" x 4" Flashing Corner Light, Polycarbonate Amber Lens 18 Watts, 1.50 Amps For 12 Volt to 24 Volt Systems Replaces RE55150	AMTL8045	\$ 59.00
 7200, 7210, 7400, 7410, 7510, 7600, 7610, 7700, 7710, 7720, 7800, 7810, 7815, 7820, 7920, 8100, 8110, 8120, 8200, 8210, 8220, 8300, 8310, 8320, 8400, 8410, 8420, 8520, 9100, 9120, 9200, 9220, 9300, 9320, 9400, 9420, 9520, 9620 Replaces RE55151		LED Corner Floodlight Set of 2 Cab Mount 8.75" x 4" Flashing Corner Lights, Amber Lenses Each Light is 18 Watts, 1.50 Amps For 12 Volt to 24 Volt Systems Replaces TL8045	AMRE55150	\$ 78.40

John Deere®—Tractor

Application	Description	Part Number	Retail Price	Core
 Universal Equipment	LED Magnetic Work Light All-Position Light 3.25" Square Floodlight 900 Lumens Magnetic Base Includes Lithium Ion Battery, Cigarette Lighter and DC Charger	AMTL2460	\$ 79.00	
 4055, 4255, 4455, 4560, 4760, 4960	Light Bezel Made from Billet Aluminum, Silver Powder Coat Finish	AMR98630	\$ 20.00	
2040, 2140 Late, 2150, 2255, 2350, 2355N, 2440, 2550, 2630, 2640, 2750, 2755, 2840, 2940, 2950, 2955, 3055, 3140, 3155, 3255, 4030, 4040, 4230, 4240, 4430, 4440, 4630, 4640, 4840, 5103 BSN 009422, 5105, 5200, 5203 BSN 005261, 5205, 5210, 5300, 5303 BSN 005763, 5310, 5310N, (5320N, 5420N, 5520N - w/ Cab), 5400, 5400N, 5410, 5500, 5500N, 5510, 5510N, Utility: 2155, 2240,	Control Switch, Turn Signal Replaces AR67398	AMAR64422	\$ 55.88	
2640	Control Switch, Flashing Warning Light Replaces AR67398	AMAR64422	\$ 55.88	

Cab Components—Miscellaneous



Application	Description	Part Number	Retail Price	Core
4030, 4230, 4430, 4630	Kick Panel	Right Hand AMR52706 Left Hand AMR52707	\$ 58.00 \$ 58.00	
4040, 4240, 4440, 4640, 4840	Kick Panel	Right Hand AMR65301 Left Hand AMR65302	\$ 58.00 \$ 58.00	
2940, 2950, 3140, 4050, 4250, 4450, 4650, 4850	Kick Panel Brown	Left Hand AMR78168	\$ 70.00	
4050, 4250, 4450, 4650, 4850	Kick Panel Brown	Right Hand AMR80323	\$ 70.00	
2010 ASN 42001, 2350, 2355, 2510, 2520, 2550, 2555, 2750, 2755, 2940, 2950, 2955, 3010, 3020, 3055, 3150, 3155, 3255, 4000 ASN 201000, 4010, 4020, 4030, 4040, 4050, 4055, 4230, 4240, 4250, 4255, 4320, 4430, 4440, 4450, 4455, 4520, 4555, 4560, 4620, 4630, 4640, 4650, 4755, 4760, 4840, 4850, 4955, 4960, 5010, 5020, 6030, 7020, 7520, 8430, 8630	Rear View Mirror	AMAR89137	\$ 40.00	

John Deere®—Tractor

Application	Description	Part Number	Retail Price	Core	
4030, 4040, 4050, 4055, 4230, 4240, 4250, 4255, 4430, 4440, 4450, 4455, 4555, 4560, 4630, 4640, 4650, 4755, 4760, 4840, 4850, 4955, 4960, 6030, 6100, 6100D, 6110, 6110D, 6115D, 6120, 6125D, 6125E, 6130, 6130D, 6140D, 6200, 6205, 6210, 6215, 6220, 6230, 6300, 6310, 6320, 6325, 6330, 6400, 6403, 6405, 6410, 6415, 6420, 6420S, 6430, 6500, 6505, 6506, 6510, 6515, 6603, 6605, 6610, 6615, 6715, 7130, 7185J, 7200, 7205J, 7210, 7220, 7225J, 7230, 7320, 7330, 7400, 7410, 7420, 7500, 7505, 7510, 7520, 7600, 7610, 7630, 7700, 7710, 7715, 7720, 7730, 7800, 7810, 7815, 7820, 7830, 7920, 7930, 8100, 8100T, 8110, 8110T, 8120, 8120T, 8130, 8200, 8200T, 8210, 8210T, 8220, 8220T, 8230, 8230T, 8300, 8300T, 8310, 8310T, 8320, 8320T, 8330, 8330T, 8400, 8400T, 8410, 8410T, 8420, 8420T, 8430 MFWD, 8430T, 8440, 8450, 8520, 8520T, 8530, 8630, 8640, 8650, 8850, 9100, 9120, 9200, 9220, 9230, 9300, 9320, 9320T, 9330, 9400, 9420, 9420T, 9430, 9520, 9520T, 9530, 9530T, 9620, 9620T, 9630, 9630T, Premium Models: 6330, 6430, 7130, 7230, 7330, 7430	Rear View Mirror w/ Wide Angle Mirror on Lower Portion 13.50" x 8" Upper Mirror 5" x 7" Lower Mirror, 20" x 9" Overall	Right Hand Left Hand	AMRMV120RH AMRMV120LH	\$ 67.58 \$ 67.58	
	4030, 4040, 4050, 4055, 4230, 4240, 4250, 4255, 4430, 4440, 4450, 4455, 4550, 4560, 4630, 4640, 4650, 4755, 4760, 4840, 4850, 4955, 4960, 4960 - w/ Sound-Gard™ Cab	Mirror	Right or Left Hand	AMSS3127	\$ 211.00
4030, 4040, 4050, 4055, 4230, 4240, 4250, 4255, 4350, 4430, 4440, 4450, 4455, 4555, 4560, 4630, 4640, 4650, 4755, 4760, 4840, 4850, 4955, 4960, 8430, 8630	Mirror Bracket For Interior Mirror	Right Hand	AMR53477	\$ 35.00	
4030, 4040, 4050, 4055, 4230, 4240, 4250, 4255, 4430, 4440, 4450, 4455, 4555, 4560, 4630, 4640, 4650, 4755, 4760, 4840, 4850, 4955, 4960, 8430, 8630 - w/ Sound-Gard™ Cab	Mirror Extension Kit Bolts in place or on OEM bracket		AMX19119	\$ 165.00	
4050, 4230, 4240, 4250, 4430, 4440, 4450, 4630, 4640, 4650, 4840, 4850 - 2WD	Cab Caddie, 18" Long One-piece molded design in durable black poly. Quick and easy installation.		AMX92005	\$ 40.00	
6110, 6200, 6210, 6215, 6220, 6230, 6300, 6310, 6320, 6330, 6400, 6410, 6415, 6420, 6430, 6500, 6510, 6615, 6715, 7200, 7210, 7220, 7230, 7320, 7330, 7400, 7410, 7420, 7430, 7500, 7510, 7520, 7600, 7610, 7630, 7700, 7710, 7720, 7730, 7800, 7810, 7820, 7830, 7920, 7930	Mirror	Right or Left Hand	AMSS3138	\$ 211.00	
4030, 4230, 4430, 4440, 4630, 4640, 4840	Field Office Thermoformed black plastic panel w/ black vinyl covering Mounts to left hand fender Hardware Included		AMSS4239	\$ 249.00	
2040, 2140, 2150, 2255, 2350, 2355, 2440, 2550, 2555, 2640, 2750, 2755, 2840, 2940, 2950, 2955, 3040, 3055, 3140, 3150, 3155, 3255, 4030, 4040, 4050, 4055, 4230, 4240, 4250, 4255, 4430, 4440, 4450, 4455, 4555, 4560, 4630, 4640, 4650, 4755, 4760, 4840, 4850, 4955, 4960, 4WD: 8430, 8440, 8450, 8630, 8640, 8650, 8850, Utility: 2240	Monitor Bracket Well-suited for use with multiple monitors, less restriction of operator's view improves safety. Assembly hardware and tray pad included, monitor mounting hardware not included.		AMSS3189	\$ 159.00	
7200R, 7215R, 7230R, 7260R, 7280R, 8225R, 8235R, 8245R, 8260R, 8270R, 8285R, 8295R, 8295RT, 8310R, 8310RT, 8320R, 8320RT, 8335R, 8335RT, 8345R, 8345RT, 8360R, 8360RT, 9460RT, 9510RT, 9560RT, 4WD: 9360R, 9410R, 9460R, 9510R, 9560R	Monitor Bracket Well-suited for use with multiple monitors, less restriction of operator's view improves safety. Assembly hardware and tray pad included, monitor mounting hardware not included.		AMSS3174	\$ 159.00	

John Deere®—Tractor

Application	Description	Part Number	Retail Price	Core
7600, 7610, 7700, 7710, 7800, 7810 - w/ Powershift Transmission	Monitor Bracket Well-suited for use with multiple monitors, less restriction of operator's view improves safety. Assembly hardware and tray pad included, monitor mounting hardware not included.	AMSS3175	\$ 159.00	
7630, 7720, 7730, 7820, 7830, 7920, 7930, 8130, 8230, 8230T, 8330, 8330T, 8430, 8430T, 8530, 9120, 9220, 9320, 9320T, 9420, 9420T, 9430T, 9520, 9520T, 9530T, 9620, 9620T, 9630T, 4WD: 9230, 9330, 9430, 9530, 9630	Monitor Bracket Well-suited for use with multiple monitors, less restriction of operator's view improves safety. Assembly hardware and tray pad included, monitor mounting hardware not included.	AMSS3173	\$ 159.00	
8100, 8100T, 8110, 8110T, 8120, 8120T, 8200, 8200T, 8210, 8210T, 8220, 8220T, 8300, 8300T, 8310, 8310T, 8320, 8320T, 8400, 8400T, 8410, 8410T, 8420, 8420T, 8520, 8520T	Monitor Bracket Well-suited for use with multiple monitors, less restriction of operator's view improves safety. Assembly hardware and tray pad included, monitor mounting hardware not included.	AMSS3172	\$ 159.00	
4030, 4040, 4230, 4240, 4430, 4440, 4630, 4640, 4840, 8430, 8440, 8630, 4WD: 8640, Combines: 4425, 4435, 6620, 6622, 7720, 8820, Cotton Pickers: 6720, 6730, 9910, 9920, 9930, 9940, 9950, 9960, Cotton Strippers: 7440, 7445, Forage Harvesters: 5720, 5730, 5820, 5830, Sprayer: 6000 Hi-Cycle, Swathers: 2320, 2420, 3430, 3830	A/C Control Bezel, Black Plastic 8 Louver Style Includes vents, decals and hardware	AMAH118028	\$ 112.00	
4050, 4055, 4250, 4255, 4450, 4455, 4555, 4560, 4650, 4755, 4760, 4850, 4955, 4960, Cotton Pickers: 9930, 9935, 9965, 9970, 9976, Cotton Strippers: 7445, 7450, 7455, Sprayer: 6000 Hi-Cycle, Swathers: 6100, 6500, 6600, 6700	A/C Control Bezel, Brown Plastic Includes vents, decals and hardware	AMRE33620	\$ 117.00	
2510, 3020, 4000, 4020, 4030, 4040, 4050, 4055, 4230, 4240, 4250, 4255, 4320, 4430, 4440, 4450, 4455, 4520, 4555, 4560, 4630, 4640, 4650, 4755, 4760, 4840, 4850, 4955, 4960, 5020, 6030, 7020, 7520, 8430, 8440, 8450, 8630, 8640, 8650, 8850, Combines: 4400, 4420, 6600, 6620, 7700, 7720, 8820, Cotton Pickers: 9900, 9910, 9920, 9930, 9940, 9950, 9960, Cotton Strippers: 484, 7440, 7445, Forage Harvesters: 5200, 5400, 5440, 5460, 5720, 5820, Sprayer: 6000, Swathers: 2250, 2270, 2280, 2320, 2420	Windshield Wiper Motor 12 Volt Replaces RE13280, RE53496, RE56380, RE58851, RE234000	Right Hand AMAR59444	\$ 60.00	
4030, 4040, 4050, 4230, 4240, 4250, 4430, 4440, 4450, 4630, 4640, 4650, 4840, 4850, 8430, 8440, 8450, 8630, 8640, 8650, 8850	Windshield Wiper Motor 12 Volt Replaces AR56691, RE18943	Left Hand AMRE48783	\$ 105.00	
8100, 8110, 8200, 8210, 8300, 8310, 8400, 8410	Command Arm Bracket 7-Gauge Steel, Black Powder Coat Finish, Includes Hardware Allows seat assemblies to fit into tractors where there is a "command center" in place of the right armrest	AMSAP4M	\$ 78.00	











John Deere®—Tractor

Application	Description	Part Number	Retail Price	Core
2350, 2355, 2550, 2555, 2750, 2755, 2950, 2955, 3055, 3150, 3155, 3255, 4040, 4050, 4055, 4230, 4240, 4250, 4255, 4430, 4440, 4450, 4455, 4555, 4560, 4755, 4760, 4850, 4955, 4960, 5200, 5210, 5220, 5225, 5300, 5310, 5310N, 5320, 5325, 5400, 5400N, 5410, 5420, 5425, 5500, 5500N, 5510, 5510N, 5520, 5525, 6110, 6120, 6200, 6210, 6215, 6220, 6300, 6310, 6310S, 6320, 6320L, 6400, 6403, 6405, 6410, 6410S, 6415, 6420, 6420L, 6500, 6506, 6510S, 6520L, 6600, 6603, 6605, 6615, 6715, 6800, 6810, 6820, 6900, 6910, 6910S, 6920, 6920S, 7200, 7210, 7220, 7320, 7400, 7410, 7420, 7505, 7510, 7515, 7520, 7600, 7610, 7700, 7710, 7800, 7810	Cab Mount Isolator	AMR111173	\$ 15.00	
2350, 2355, 2550, 2555, 2750, 2755, 2940, 2950, 2955, 3055, 3150, 3155, 3255, 4040, 4040S, 4050, 4055, (4230, 4430, 4630 - w/ Replacement 40 Series Sound-Gard™ Body), 4240, 4240S, 4250, 4255, 4350, 4440, 4450, 4455, 4555, 4560, 4640, 4650, 4755, 4760, 4840, 4850, 4955, 4960, 5200, 5210, 5220, 5225, 5300, 5310, 5310N, 5320, 5325, 5400, 5400N, 5410, 5420, 5425, 5500, 5500N, 5510, 5510N, 5520, 5525, 6110, 6120, 6200, 6210, 6215, 6220, 6300, 6310, 6310S, 6320, 6320L, 6400, 6403, 6405, 6410, 6410S, 6415, 6420, 6420L, 6500, 6506, 6510S, 6520L, 6600, 6603, 6605, 6615, 6715, 6800, 6810, 6820, 6900, 6910, 6910S, 6920, 6920S, 7200, 7210, 7400, 7410, 7420, 7510, 7520, 7600, 7610, 7700, 7710, 7800, 7810	Cab Mount Isolator, Rear	AMR66375	\$ 17.00	
(2350, 2355, 2550, 2555, 2750, 2755, 2940, 2950, 3150, 3155, 4040, 4050, 4240, 4440, 4555, 4560, 4640, 4650, 4755, 4760, 4840, 4850, 4955, 4960, 4960 - w/ Sound-Gard™ Body), (2955, 3055, 3255 - w/ Sound-Gard™ Body or 4-Post Roll Guard), (4230, 4430, 4630 - w/ Sound-Gard™ Body and Replacement Sound-Gard™ Cab)	Cab Mount Isolator 1.006" ID, 1.791" OD	AMR66374	\$ 15.63	
5075M, 5085M, 5090M, 5100M, 5100MH, 5115M, 6100D, 6105D, 6105E, 6110B, 6110D, 6115D, 6120E, 6125D, 6130D, 6135B, 6135E, 6140D, 7185J, 7195J, 7200J, 7205J, 7210J, 7215J, 7225J, 7230J, 7630, 7715, 7720, 7730, 7815, 7820, 7830, 7920, 7930, 8100 ASN 001113, 8100T, 8110, 8110T, 8120, 8120T, 8200 ASN 001117, 8200T, 8210, 8210T, 8220, 8220T, 8300 ASN 001396, 8300T, 8310, 8310T, 8320, 8320T, 8400 ASN 001052, 8400T, 8410, 8410T, 8420, 8420T, 8520, 8520T, 9100, 9120, 9200, 9220, 9230, 9300, 9300T, 9320, 9320T, 9330, 9400, 9400T, 9420, 9420T, 9430, 9430T, 9520, 9520T, 9530, 9530T, 9620, 9620T, 9630, 9630T, Sprayers: 4700, 4710, 4720, 4730, 4830, 4920, 4930, 4940	Cab Mount Isolator, Lower 1.24" ID, 3.789" OD, 1.398" Long, 1.063" Flange Height	AMRE62910	\$ 29.51	

Steps

Application	Description	Part Number	Retail Price	Core
 6120, 6220, 6320 6420, 6605, 6615, 6715, Premium Models: 6230, 6330, 6430, 7130, 7230, 7330	Step Assembly 3 Steps	AMAL156877	\$ 110.00	

John Deere®—Tractor

Application	Description	Part Number	Retail Price	Core
 A, B, 50, 60, 70, 520, 530, 620, 630, 720, 730	Step Assembly w/ Bracket	AMAA6092R	\$ 58.00	
 30, 40, 50 & 55 Series - Row Crop & Utility Tractors	Step Kit Includes Handrail, Steps, Mounting Bracket and Hardware Replaces RE61690	Left Hand AMX19102	\$ 260.00	
 3010, 3020, 4000, 4010, 4020 - Row Crop & Utility Tractors	Step Kit Includes Handrail, Steps, Mounting Bracket and Hardware Replaces RE62856	Left Hand AMX19103	\$ 325.00	
 30, 40, 50, 55 Series Row Crop & Utility, 3010, 3020, 4000, 4010, 4020	4th Step Kit Add to AMX19102 and AMX19103 to create 4th step Replaces RE163104	AMX19122	\$ 85.00	
 30, 40, 50, 55 Series Row Crop & Utility, 3010, 3020, 4000, 4010, 4020	4th Step Kit w/ Rubber Side Plate Add to AMX19102 and AMX19103 to create 4th step	AMX19123	\$ 87.00	
 2510, 3010, 3020, 4010, 4020, 4320	Step	AMR27883	\$ 37.00	
60 Series	Window Step	AMSS3413	\$ 381.00	
 7200, 7210, 7400, 7410	Window Step	AMSS3414	\$ 344.00	
 7600, 7610, 7700, 7710, 7800, 7810	Window Step	AMSS3411	\$ 381.00	
8000, 8010 Series	Window Step	AMSS3402	\$ 465.00	
8020 Series	Window Step	AMSS3409	\$ 440.00	
 7210R, 7230R, 7250R, 7270R, 7290R, 7310R	Rubber Hanger For Bottom Step	AMR542428	\$ 30.07	
 7630, 7730, 7830, 7930, 8225R, 8235R, 8245R, 8260R, 8270R, 8285R, 8295R, 8310R, 8310RT, 8320R, 8320RT, 8335R, 8335RT, 8345R, 8345RT, 8360R, 8360RT, 8370RT, 9430T, 9460RT, 9510RT, 9520RT, 9530T, 9560RT, 9570RT, 9630T	Rubber Hanger For Bottom Step	AMR344084	\$ 53.00	

Cab Doors

Door frame only. No glass, seal or hardware included.



Application	Description	Part Number	Retail Price	Core
1640, 2040, 2040S, 2140, 2350, 2550, 2750, 2940, 2950, (3040, 3140 ASN 4630000), 3150	Door Frame, Left Hand	AMAL118343	\$ 415.00	

John Deere®—Tractor

Application	Description	Part Number	Retail Price	Core
2355, 2555, 2755, 2955, 3055, 3155, 3255	Door Frame, Left Hand	AMAL69425	\$ 350.00	
4030, 4040, 4230, 4240, 4430, 4440, 4630, 4640, 4840 - Prior to 1981	Cab Door Frame Primer Coated, Ready for Paint Fits Cabs w/ Twist-Style Door Handle	AMAR73256	\$ 350.00	
4040, 4050, 4055, 4240, 4250, 4255, 4440, 4450, 4455, 4555, 4560, 4640, 4650, 4755, 4760, 4840, 4850, 4955, 4960	Cab Door Frame, Early Primer Coated, Ready for Paint Fits Cabs w/ Push-Button Style Door Handle	AMAR109555	\$ 350.00	
	Cab Door Frame, Late For Cabs w/ Pin for Bell Crank Pivot	AMAR109555L	\$ 350.00	
2940, 4030, 4040, 4050, 4230, 4240, 4250, 4430, 4440, 4450, 4630, 4640, 4650, 4840, 4850, 8430, 8440, 8450, 8630, 8640, 8650, 8850	Cab Door Handle, Push Button Replaces AR91895	AMVLD1443	\$ 66.90	
(4050, 4250, 4450, 4650, 4850 - w/ Replacement 55 Series Sound-Gard™ Cab), 4055, 4255, 4455, 4555, 4560, 4755, 4760, 4955, 4960, 8560, 8570, 8760, 8770, 8870, 8960, 8970, Combines: 9400, 9410, 9450, 9500, 9500SH, 9510, 9510SH, 9550 BSN 700201, 9550SH BSN 700701, 9600, 9610, 9650 BSN 700301, 9650CTS BSN 700401, 9650STS BSN 700501, 9750STS BSN 700601, CTS, CTS II, Sprayers: 6500 ASN 100000, 6600 ASN 200000, Swathers: 4890, (4895, 4995 BSN 183001), 4990	Cab Door Handle	AMRE35161	\$ 45.33	
2350, 2550, 2750, 2940, 2950, 3150, 4030, 4040, 4050, 4230, 4240, 4250, 4430, 4440, 4450, 4630, 4640, 4650, 4840, 4850	Right Hand Access Door for Sound-Gard™	AMRE14480	\$ 160.00	

Cab Roofs and Liners







Application	Description	Part Number	Retail Price	Core
2140, 2350, 2355, 2550, 2555, 2750, 2755, 2850, 2950, 2955, 3040, 3055, 3140, 3150, 3155, 3255, 4030, 4040, 4050, 4055, 4230, 4240, 4250, 4430, 4440, 4450, 4555, 4560, 4630, 4640, 4650, 4755, 4760, 4840, 4850, 4955, 4960, 8430, 8440, 8450, 8640, 8650	Cab Roof OEM direct replacement made from green molded plastic, w/ flasher light holes Replaces AL41448	AMAR74143	\$ 285.00	
7200 ASN 003435, 7210, 7400 ASN 004456, 7410, 7600 ASN 006345, 7610, 7700 ASN 007444 7710, 7800 ASN 010830, 7810	Cab Roof Will not fit European cab w/ 2 rain gutters in back	AMRE67856	\$ 550.00	
7200, 7210, 7400, 7410, 7510, 7610, 7710, 7810	Inner Cab Roof	AMRE150482	\$ 1230.00	
7210R, 7215R, 7230R, 7250R, 7260R, 7270R, 7280R, 7290R, 7310R, 8225R ASN 119999, 8235R, 8245R, 8260R, 8270R, 8285R, 8295R, 8310R, 8310RT, 8320R, (8320RT, 8345RT ASN 912000), 8335R, 8335RT, 8345R, 8360R, 8360RT, 8370R, 8370RT, 8400R, 9360R, 9370R, 9410R, 9420R, 9420RX, 9460R, 9470R, 9470RT, 9470RX, 9520R, 9520RT, 9520RX, 9560R, 9560RT, 9570R, 9570RT, 9570RX, 9620R, 9620RX	Inner Cab Roof Replaces RE562585, RE570965, RE574478	AMRE583893	\$ 950.00	
520, 530, 1020, 2020, 2030, 2040, 2150, 2350, 2355, 2440, 2630, 2640, 2750, 2840, 2950, 2955, Utility: 2155, 2240	Canopy Top, 2-Post OEM direct replacement made from green molded plastic, w/ flasher light holes	AMAR78261	\$ 345.00	
2510, 2520, 3010, 3020, 4000, 4010, 4020, 4030, 4040, 4230, 4240, 4320, 4430, 4440, 4520, 4620, 4630, 5020, 6030	Canopy Top, 2-Post Restoration Quality, Powder-Coated	AMAR51452	\$ 1150.00	
2955 BSN 765516, 3055, 3150, 3155, 3255, 4030, 4040, 4050, 4055, 4230, 4240, 4250, 4255, 4430, 4440, 4450, 4455, 4555, 4560, 4630, 4640, 4650, 4755, 4760, 4955, 4960	Canopy Top, 4-Post OEM direct replacement made from green molded plastic, w/ flasher light holes Mounting holes marked	AMAR69840	\$ 345.00	



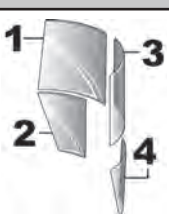
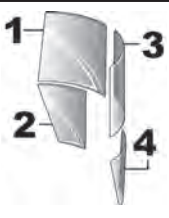





John Deere®—Tractor

Application	Description	Part Number	Retail Price	Core
1020, 1250, 1450, 1520, 1530, 1650, 2020, 2030, 2040, 2150, 2350, 2355, 2440, 2550, 2555, 2630, 2640, 2750, 2755, 2840, 2940, 2950, 2955, 5105, 5200, 5205, 5210, 5220, 5300, 5310, 5320, 5400, 5410, 5420, 5500, 5510, 5520, 7405, Utility: 820, 2155, 2240	Roof Liner, 2-Post Made from black molded plastic, OEM direct replacement	AMR60103	\$ 145.00	
2955, 3055, 3150, 3155, 3255, 4030, 4040, 4050, 4055, 4230, 4240, 4250, 4255, 4430, 4440, 4450, 4455, 4555, 4560, 4630, 4640, 4650, 4755, 4760, 4955, 4960	Roof Liner, 4-Post Open Station Made from black molded plastic, OEM direct replacement	AMR50624	\$ 155.00	











Glass

	Application	Description	Part Number	Retail Price	Core
	1 2140, 2350, 2550, 2750, 2940, 2950, 3140, 3150 BSN 071269, 4030, 4040, 4040S, 4050, 4230, 4240, 4240S, 4250, 4350, 4430, 4440, 4450, 4630, 4640, 4650, 4840, 4850, 8430, 8440, 8450, 8630, 8640, 8650, 8850	Upper Door Glass, Left Hand	AMR50755	\$ 95.00	
	2 2140, 2350, 2355, 2550, 2555, 2750, 2755, 2940, 2950, 2955, 3140, 3150, 3155, 4030, 4040, 4050, 4230, 4240, 4250, 4350, 4430, 4440, 4450, 4630, 4640, 4650, 4840, 4850	Lower Door Glass, Left Hand	AMR50756	\$ 79.00	
	3 2140, 2350, 2550, 2750, 2940, 2950, 3140, 3150 BSN 071269, 4030, 4040, 4040S, 4050, 4230, 4240, 4240S, 4250, 4350, 4430, 4440, 4450, 4630, 4640, 4650, 4840, 4850, 8430, 8440, 8450, 8630, 8640, 8650, 8850	Upper Windshield Glass, Right Hand	AMR50753	\$ 95.00	
	4 2140, 2350, (2355, 2555, 2755, 2955, 3155 BSN 691586), 2550, 2750, 2940, 2950, 3140, 3150, 4030, 4040, 4050, 4230, 4240, 4250, 4430, 4440, 4450, 4630, 4640, 4650, 4840, 4850	Lower Windshield Glass, Right Hand	AMR50754	\$ 49.00	
	1 4050*, 4055, 4250*, 4255, 4450*, 4455, 4555, 4560, 4650*, 4755, 4760, 4850*, 4955, 4960 *w/ 55 Series Replacement Sound-Gard™ Cab	Upper Door Glass, Left Hand	AMR93150	\$ 100.00	
	2 4050*, 4055, 4250*, 4255, 4450*, 4455, 4555, 4560, 4650*, 4755, 4760, 4850*, 4955, 4960 *w/ 55 Series Replacement Sound-Gard™ Cab	Lower Door Glass, Left Hand	AMR93149	\$ 88.50	
	3 4050*, 4055, 4250*, 4255, 4450*, 4455, 4555, 4560, 4650*, 4755, 4760, 4850*, 4955, 4960 *w/ 55 Series Replacement Sound-Gard™ Cab	Upper Windshield Glass, Right Hand Replaces 111840	AMR93148	\$ 157.00	
	4 4050*, 4055, 4250*, 4255, 4450*, 4455, 4555, 4560, 4650*, 4755, 4760, 4850*, 4955, 4960 *w/ 55 Series Replacement Sound-Gard™ Cab	Lower Windshield Glass, Right Hand Replaces 113032	AMR93147	\$ 70.00	
	(6110, 6210, 6310, 6410 ASN 223898), 6120, 6215, 6220, 6320, 6405, 6415, 6420, (6510, 6610, 6810, 6910, 6910S European ASN 223898), (6420S, 6520, 6620, 6820, 6920, 6920S European), 6605, 6615, 6715	Windshield Glass Note: This is not the Panoramic Style Window	AML112972	\$ 228.88	
	(6110, 6210, 6310, 6410 BSN 223897), (6200, 6300, 6400, 6500 - w/ ComfortGard™ Cab), (6506, 6600, 6800, 6900 European), (6510, 6610, 6810, 6910, 6910S European BSN 223897)	Windshield Glass, Non-Tilt	AML78733	\$ 280.00	
	6120, 6220, 6320, 6420	Windshield Glass	AML211446	\$ 539.43	











John Deere®—Tractor

	Application	Description	Part Number	Retail Price	Core
	7200, 7210, 7400, 7410, 7510, 7600, 7610, 7700, 7710, 7800, 7810	Windshield Glass	AMR96187	\$ 263.00	
	8100, 8100T, 8110, 8110T, 8200, 8220T, 8210, 8210T, 8300, 8300T, 8310, 8310T, 8400, 8400T, 8410, 8410T	Windshield Glass Tinted	AMR135976	\$ 438.00	
	5045E, 5055E, 5065E, 5075E, 6100D, 6105D, 6105E, 6110D, 6115D, 6120E, 6125D, 6130D, 6135E, 6140D	Front Windshield Glass	AMSU26078	\$ 150.01	
	6010, 6020, 6100, 6110, 6120, 6200, 6210, 6220, 6300, 6310, 6320, 6400, 6410, 6420, 6420S, 6506, 6510, 6600, 6610, 6800, 6810, 6900, 6910, 6910S, SE6010, SE6100, SE6110, SE6200, SE6210, SE6300, SE6310, SE6400, SE6410, SE6510, SE6610 - European	Front Windshield Glass, Tilttable Replaces L78725, L78726, L212277	AML129214	\$ 345.00	
	6105M, 6115M, 6125M, 6140M, 6150M, 6170M, 6215, 6230, 6330, 6415, 6430, 6615, 6715, 7130, 7230, 7330 - w/ 3-Piece Windshield	Front Windshield Glass	AML213346	\$ 270.00	
	6120, 6220, 6320, 6420, 7220, 7320, 7420, 7520	Front Windshield Glass Replaces L155222, L157582	AML166875	\$ 540.00	
	7600, 7610 BSN 089999, 7700, 7710, 7800, 7810	Front Windshield Glass	AMR114807	\$ 360.00	
	2355, 2555, 2755, 2955 BSN 765216, 3055, 3155, 3255	Upper Windshield Glass, Right Hand Replaces L62980	AML58953	\$ 203.55	
	(6110, 6210, 6310, 6410 BSN 223897), 6200, 6300, 6400, (6506, 6600, 6800, 6900 European), (6510, 6610, 6810, 6910, 6910S European BSN 223897)	Lower Windshield Glass, Right Hand	AML78534	\$ 137.92	
		Lower Windshield Glass, Left Hand	AML78533	\$ 130.86	
	(6110, 6210, 6310, 6410 ASN 223898), 6405, (6510, 6610, 6810, 6910, 6910S, SE6010, SE6110, SE6210, SE6310, SE6410, SE6510, SE6610 European ASN 223898), 6605	Lower Windshield Glass, Left Hand Replaces L171331	AML114753	\$ 85.63	
	7200, 7210, 7400, 7410, 7510, 7600, 7610, 7700, 7710, 7800, 7810	Lower Windshield Glass, Left Hand	AMR96196	\$ 50.00	
	6105M, 6110M, 6115M, 6120, 6120M, 6125M, 6130M, 6140M, 6140J, 6145M, 6150M, 6155J, 6155M, 6170M, 6175M, 6195M, 6215, 6220, 6230, 6320, 6330, 6415, 6420, 6430, 6615, 6715, 7130, 7230, 7330	Lower Front Glass, Right Hand Replaces L151753, L171334 Lower Front Glass, Left Hand Replaces L151752, L171333	AML213350 AML213349	\$ 110.00 \$ 110.00	
	(6110, 6210, 6310, 6410 ASN 223898), 6405, 6605	Lower Front Glass, Right Hand Replaces L114754	AML171332	\$ 127.00	
	1640, 2040, 2040S, 2140, 3040, 3140 - w/ SG2 Cab	Side Glass, Right or Left Hand Replaces L55040, L57976	AML57977	\$ 163.97	









John Deere®—Tractor

	Application	Description	Part Number	Retail Price	Core
	2140 ASN 430000, 2350, 2550, 2750, 2940, 2950, 3140 ASN 430000, 3150, 4030, 4040, 4050, 4055, 4230, 4240, 4250, 4255, 4430, 4440, 4450, 4455, 4555, 4560, 4630, 4640, 4650, 4755, 4760, 4840, 4850, 4955, 4960, 8440, 8450, 8560, 8570, 8630, 8640, 8650, 8760, 8770, 8850, 8870, 8960, 8970, (2355, 2555, 2755, 2955, 3155 BSN 631621)	Side Glass, Right or Left Hand	AMR50757	\$ 58.00	
	(2355, 2555, 2755, 3155 ASN 631622), 2955 BSN 767516, 3055, 3255	Side Glass, Right or Left Hand	AML57980	\$ 143.56	
	6110, 6120, 6200, 6210, 6215, 6220, 6300, 6310, 6320, 6400, 6405, 6410, 6415, 6420, 6605, 6615, 6715, 7220, 7320, 7420, 7505, 7520	Side Glass, Right Hand Side Glass, Left Hand	AML113305 AML113306	\$ 57.50 \$ 69.00	
	6200, 6300, 6400, 6500 - w/ ComfortGard™ Cab	Side Glass, Right Hand Side Glass, Left Hand Replaces L78538, L78540	AML78538 AML78539	\$ 101.74 \$ 95.00	
		Side Glass, Left Hand Tinted Replaces L78539	AML78537	\$ 95.00	
	7200, 7210, 7400, 7410, 7510, 7600, 7610, 7700, 7710, 7800, 7810	Side Glass, Right Hand Side Glass, Left Hand	AMR96193 AMR96194	\$ 104.00 \$ 123.50	
	8100, 8100T, 8110, 8110T, 8120, 8120T, 8200, 8200T, 8210, 8210T, 8220, 8220T, 8300, 8300T, 8310, 8310T, 8320, 8320T, 8400, 8400T, 8410, 8410T, 8420, 8420T, 8520, 8520T	Side Glass, Stationary Right Hand Tinted	AMR208587	\$ 523.13	
	5083E, 5085E, 5093E, 5100E, 5101E, 5220, 5225, 5320, 5325, 5420, 5425, 5525, 5603, 5625, 5725, (6100D, 6110D, 6115D, 6125D, 6130D, 6140D BSN 050000), 6403, 6603	Door Glass, Left Hand	AMR198624	\$ 356.00	
	5085E, 5093E, 5093E Limited, 5100E, 5101E, 5101E Limited, (5220, 5320, 5420, 5520 ASN 420000), 5225, 5325, 5425, 5525, 5603, 5625, (6100D, 6110D, 6115D, 6125D, 6130D, 6140D BSN 050001), 6403, 6603	Door Glass, Right Hand	AMR198625	\$ 350.45	
	5200, 5210, 5300, 5310, 5400, 5410, 5500, 5510	Door Glass, Right or Left Hand Tinted	AMR141527	\$ 333.95	
	6105R, 6110R, 6115R, 6120R, 6125R, 6130R, 6140R, 6145R, 6150R, 6155R, 6155RH, 6170R, 6175R, 6190R, 6195R, 6210R, 6215R	Door Glass, Right Hand Panorama Style Replaces L207691, L209796	AML212968	\$ 345.00	
		Door Glass, Left Hand Panorama Style Replaces L209795	AML212967	\$ 345.00	





John Deere®—Tractor

	Application	Description	Part Number	Retail Price	Core
	6110, 6120, (6200, 6300, 6400, 6500 - w/ ComfortGard™ Cab), 6210, 6215, 6220, 6310, 6320, 6410, 6415, 6420, 6430, 6605, 6615, 6715, (7220, 7320, 7330, 7420, 7520 - w/ Premium Cab)	Door Glass, Right Hand Non-Panoramic Style Replaces L77648, L213354	AML169103	\$ 165.00	
		Door Glass, Left Hand Non-Panoramic Style Replaces L77647, L213355	AML169102	\$ 160.00	
	6230, 6330, 6430, 7130, 7230, 7330, 7430, 7530	Door Glass, Right Hand Panorama Style	AML174377	\$ 287.00	
	6405, 6415, 6605, 6615, 7220, 7320, 7420, 7505, 7515, 7520	Door Glass, Right Hand Replaces L170677	AML78989	\$ 251.90	
	7200, 7210, 7400, 7410, 7510, 7600, 7610, 7700, 7710, 7800, 7810	Door Glass, Stationary Right Hand	AMR186465	\$ 356.10	
	7200, 7210, 7400, 7410, 7510, 7600, 7610, 7700, 7710, 7800, 7810	Door Glass, Right Hand Replaces R110825	AMR131164	\$ 290.00	
		Door Glass, Left Hand Replaces R96191	AMR131163	\$ 280.00	
	8100, 8100T, 8110, 8110T, (8120, 8220, 8320, 8420, 8520 BSN 014366), 8120T, 8200, 8200T, 8210, 8210T, 8220T, 8300, 8300T, 8310, 8310T, 8320T, 8400, 8400T, 8410, 8410T, 8420T, 8520T, 9300T, 9320T, 9400T, 9420T, 9520T, 9620T	Door Glass, Left Hand Tinted	AMR157210	\$ 370.00	
	2355, 2555, 2755, 2955 BSN 765516, 3055, 3155 BSN 738221, 3255	Upper Door Glass, Left Hand Replaces L58959, L62979	AML58951	\$ 99.50	
	(1640, 2040, 2040S, 2140 - w/ SG2 Cab), 2350, 2355, 2550, 2555, 2750, 2755, 2855N, 2950, 2955 BSN 767516, 3040, 3055, 3140, 3150, 3155, 3255	Lower Door Glass, Left Hand Replaces L62575, R50756	AML62577	\$ 111.19	
	2250, (2355, 2555, 2755, 2955, 3155 ASN 691587), (2450, 2650, 2850, 3150, 3350 ASN115799), 3055, 3255	Lower Door Glass, Right Hand	AML62594	\$ 170.55	
	(1640, 2040, 2040S ASN 430000)	Rear Glass	AML57284	\$ 177.41	
	2140 ASN 430000, 2350, 2550, 2750, 2940, 2950, 3140 ASN 430000, 3150, 4030, 4040, 4050, 4055, 4230, 4240, 4250, 4255, 4430, 4440, 4450, 4455, 4555, 4560, 4630, 4640, 4650, 4755, 4760, 4840, 4850, 4955, 4960, 8440, 8450, 8560, 8570, 8630, 8640, 8650, 8760, 8770, 8850, 8870, 8960, 8970, (2355, 2555, 2755, 2955, 3155 BSN 631621)	Rear Glass Replaces AR79738, AR86109	AMR50758	\$ 95.00	





John Deere®—Tractor

	Application	Description	Part Number	Retail Price	Core
	2350, 2355, 2550, 2555, 2750, 2755, 2855N, 2940, 2950, 2955, 3055, 3150, 3155, 3255, 4030, 4040, 4050, 4055, 4230, 4240, 4250, 4255, 4430, 4440, 4450, 4455, 4555, 4560, 4630, 4640, 4650, 4755, 4760, 4840, 4850, 4955, 4960, 8430, 8440, 8450, 8640, 8650, 8850	Rear Glass, Sliding w/ holes for the Handle	AMAR87997	\$ 154.77	
	(2355, 2555, 2755, 2855N, 2955, 3155 ASN 631622), 3055, 3255	Rear Glass	AML57981	\$ 125.00	
	5085M, 5100M, 5100MH, 5115M, 6100D, 6110D, 6115D, 6125D, 6130D	Rear Glass	AMR261272	\$ 78.50	
	5200, 5210, 5300, 5310, 5400, 5410, 5500, 5510	Rear Glass	AMR129954	\$ 209.74	
	6105R, 6110R, 6115R, 6120R, 6125R, 6130R, 6140R, 6145R, 6150R, 6155R, 6170R, 6175R, 6190R, 6195R, 6210R, 6215R	Rear Glass Includes (3) Guides/Brackets for the Struts and Latch Replaces AL209501	AMAL212195	\$ 204.00	
	6105M, 6110, 6110M, 6115M, 6120, 6120M, 6125M, 6130, 6130M, 6140M, 6145M, 6150M, 6155M, 6170M, 6175M, 6195M, (6200, 6300, 6400 - w/ Comfort-Gard™ Cab), 6210, 6215, 6220, 6230, 6310, 6320, 6330, 6405, 6410, 6415, 6420, 6430, 6500, 6530, 6534, 6605, 6615, 6630, 6715, 6830, 6930, 7130, 7230, 7320, 7330, 7420, 7430	Rear Glass Replaces L202528, L213351	AML171335	\$ 185.00	
	6110, 6120, 6200, 6210, 6215, 6220, 6300, 6310, 6320, 6400, 6405, 6410, 6415, 6420, 6605, 6615, 6715, 7220, 7320, 7420, 7520	Rear Glass w/ Sunscreen Tabs	AMAL156653	\$ 199.00	
	6120, 6220, 6320, 6420, 7220, 7320, 7420, 7520	Rear Glass, Heated Tinted	AMAL152337	\$ 219.00	
	7200R, 7210R, 7215R, 7230R, 7250R, 7260R, 7270R, 7280R, 7290R, 7310R, 8225R BSN 053100, 8295RT, (8320RT, 8345RT BSN 907101), 8360R, 8360RT, 8370R, 8370RT, 8400R, 9360R, 9370R, 9410R, 9420R, 9420RX, 9460R, 9460RT, 9470R, 9470RT, 9470RX, 9510R, 9510RT, 9520R, 9520RT, 9520RX, 9560R, 9560RT, 9570R	Rear Glass Replaces R279082, R564758	AMR537532	\$ 431.36	
	7720, 7820, 7920, 8100 ASN 5157, 8100T, 8110, 8110T, 8120, 8120T, 8200 ASN 003733, 8200T, 8210, 8210T, 8220, 8220T, 8300 ASN 006255, 8300T, 8310, 8310T, 8320, 8320T, 8400 ASN 007010, 8400T, 8410, 8410T, 8420, 8420T, 8520, 8520T, 9100, 9120, 9200, 9220, 9300, 9300T, 9320, 9320T, 9400, 9400T, 9420, 9420T, 9520, 9520T	Rear Glass Tinted	AMR127903	\$ 322.00	
	8100 BSN 005156, 8200 BSN 003732, 8300 BSN 006254, 8400 BSN 007009	Rear Glass Tinted	AMR130522	\$ 416.22	



John Deere®—Tractor

	Application	Description	Part Number	Retail Price	Core
	5065M, 5075M, 5083E, 5085M, 5093E, 5095M, 5095MH, 5101E, 5105M, (5220, 5320, 5420, 5520 ASN 420001), 5225, 5325, 5425, 5525, 5603, 5625, 5720, 5725, 5820, 6100D, 6110D, 6115D, 6125D, 6130D, 6140D, 6403, 6603	Upper Rear Glass Tinted	AMR206835	\$ 188.00	
	7200, 7210, 7400, 7410, 7510, 7600, 7610 BSN 089999, 7700, 7710, 7800, 7810	Upper Rear Glass	AMR110990	\$ 375.00	
	2140 ASN 430000, 2350, 2550, 2750, 2940, 2950, 3140 ASN 430000, 3150, 4030, 4040, 4050, 4055, 4230, 4240, 4250, 4255, 4430, 4440, 4450, 4455, 4555, 4560, 4630, 4640, 4650, 4755, 4760, 4840, 4850, 4955, 4960, 8440, 8450, 8560, 8570, 8630, 8640, 8650, 8760, 8770, 8850, 8870, 8960, 8970, (2355, 2555, 2755, 2955, 3155 BSN 631621)	Bulk Weatherstripping Edging on 1/4" Glass, Sold by the Foot (Minimum of 100')	AMX19107	\$ 3.75	
	7720, 7820, 7920, 8100, 8100T, 8110, 8110T, 8120, 8200, 8200T, 8210, 8210T, 8220, 8220T, 8300, 8300T, 8310, 8310T, 8320, 8320T, 8400, 8400T, 8410, 8410T, 8420, 8420T, 8520, 8520T, 9100, 9200, 9300, 9300T, 9320T, 9400, 9400T, 9420T, 9520T, 9620T	Weatherstrip 240" Long For Front Windshield	AMR115196	\$ 41.00	
	5220, 5320, 5420, 5520	Weatherstrip For Upper Front Cab Windshield and Lower Front Cab Window Replaces RE570092	AMRE249465	\$ 37.00	
	1640, 2040, 2040S, 2140, 2350, 2550, 2750, 2940, 2950, 3040, 3140, 4040, 4040S, 4050, 4055, 4240, 4250, 4255, 4350, 4440, 4450, 4455, 4555, 4560, 4640, 4650, 4755, 4760, 4840, 4850, 4955, 4960	Weatherstrip For Cab Window, Right or Left Hand Replaces AR89830, AR86111, RE240205	AMR237130	\$ 17.02	
	1640, 2040, 2040S, 2140, 2350, 2550, 2750, 2950, 3040, 3150, 3640, 3640S, 4030, 4040, 4040S, 4050, 4230, 4240, 4250, 4350, 4430, 4440, 4450, 4630, 4640, 4650, 4840, 4850, 8430, 8440, 8450, 8630, 8640, 8650, 8850	Weatherstrip For Upper Front Cab Window, Right Hand Replaces R52112	AML40412	\$ 27.78	
	1640, 2040, 2140, 2350, (2355, 2555, 2755, 2955, 3155 BSN 691586), 2550, 2750, 2940, 2950, 3040, 3140, 3150, 4030, 4040, 4050, 4230, 4240, 4250, 4350, 4430, 4440, 4450, 4630, 4640, 4650, 4840, 4850	Weatherstrip For Lower Front Cab Window, Right Hand Replaces R52115	AML40415	\$ 38.69	

John Deere®—Tractor

	Application	Description	Part Number	Retail Price	Core
	2940, 4040, (4050, 4250, 4450 BSN 011260), 4240, 4440, (4650, 4850 BSN 005709)	Weatherstrip For Cab Door Replaces RE240206	AMAR85558	\$ 12.03	
	2940, 4030, 4040, 4050, 4055, 4230, 4240, 4250, 4255, 4430, 4440, 4450, 4455, 4555, 4560, 4630, 4650, 4755, 4760, 4850, 4955, 4960, 7200, 7400, 7600, 7700, 7800	Weatherstrip For Cab Door, Left Hand Replaces AR93828, RE17519	AMR238022	\$ 4.33	
	4040, 4050, 4055, 4240, 4250, 4255, 4440, 4450, 4455, 4555, 4560, 4650, 4755, 4760, 4850, 4955, 4960	Weatherstrip 37.50" Long For Cab Door	AMR112304	\$ 7.82	
	(4050, 4250, 4450 ASN 011260), 4055, 4255, 4455, 4555, 4560, (4650, 4850 ASN 005709), 4755, 4760, 4955, 4960	Weatherstrip For Cab Door	AMRE15998	\$ 31.50	
	1640, 2040, 2040S, 2140, 2350, 2550, 2750, 2940, 2950, 3040, 3140, (3150, 3640S BSN 071269), 4030, 4040, 4040S, 4050, 4230, 4240, 4240S, 4250, 4350, 4430, 4440, 4450, 4630, 4640, 4650, 4840, 4850, 8430, 8440, 8450, 8630, 8640, 8650, 8850	Weatherstrip For Upper Cab Door Window Replaces R52114	AML40414	\$ 37.83	
	1640, 2040, 2040S, 2140, 2350, 2550, 2750, 2940, 2950, 3040, 3140, (3150, 3640S BSN 071269), 4030, 4040, 4040S, (4050, 4250, 4450 BSN 017297), 4230, 4240, 4240S, 4430, 4440, 4630, 4640, (4650, 4850 BSN 008568), 4840	Weatherstrip For Upper Cab Door Replaces F53628, F64267, F64403, F64773	AMAR85559	\$ 25.00	
	(4055, 4250, 4450 ASN 017298), 4255, 4455, 4555, 4560, (4650, 4850 ASN 008569), 4755, 4760, 4955, 4960	Weatherstrip For Upper Cab Door Replaces RE16307	AMRE22487	\$ 10.77	
	1640, 2040, 2040S, 2140, 2350, 2355, 2450S, 2550, 2555, 2650S, 2750, 2755, 2850S, 2855N, 2940, 2950, 2955 BSN 767516, 3040, 3055, 3140, 3150, 3150S, 3155, 3255, 3350S, 3640S, 4030, 4040, 4040S, 4050, 4230, 4240, 4250, 4350, 4430, 4440, 4450, 4540, 4630, 4650, 4840, 4850	Weatherstrip For Lower Cab Door Window Replaces R52113	AML40413	\$ 29.56	
	2940, 4030, 4040, 4050, 4055, 4230, 4240, 4250, 4255, 4430, 4440, 4450, 4555, 4560, 4630, 4640, 4650, 4755, 4760, 4840, 4850, 4955, 4960	Weatherstrip For Lower Cab Door Replaces AR85560	AMRE22488	\$ 11.17	
	2940, 4030, 4040, 4050, 4055, 4230, 4240, 4250, 4255, 4430, 4440, 4450, 4455, 4555, 4560, 4630, 4640, 4650, 4755, 4760, 4840, 4850, 4955, 4960, (8450, 8650, 8850 BSN 008652)	Weatherstrip 25 1/8" Long For Lower Access Door, Right Hand Replaces R75761	AMR83716	\$ 26.30	
	8100, 8100T, 8110, 8110T, 8120, 8120T, 8200, 8200T, 8210, 8210T, 8220, 8220T, 8300, 8300T, 8310, 8310T, 8320, 8320T, 8400, 8400T, 8410, 8410T, 8420, 8420T, 8520, 8520T, 9100, 9120, 9200, 9220, 9300, 9300T, 9320, 9320T, 9400, 9400T, 9420, 9420T, 9520, 9520T	Weatherstrip For Stationary Door, Right Hand Replaces RE570092	AMRE249465	\$ 37.00	
	(2140, 3140 ASN 430000), 2350, (2355, 2555, 2755, 2955, 3155 BSN 631621), 2550, 2750, 2940, 2950, 3150, 4030, 4040, 4050, 4055, 4230, 4240, 4250, 4255, 4430, 4440, 4450, 4455, 4555, 4560, 4630, 4640, 4650, 4755, 4760, 4840, 4850, 4955, 4960, 8440, 8450, 8560, 8570, 8630, 8640, 8650, 8760, 8770, 8850, 8870, 8960, 8970	Weatherstrip For Rear Glass Requires 118" Replaces AR86110	AMRE228688	\$ 35.00	

John Deere®—Tractor

Application	Description	Part Number	Retail Price	Core
 2140, 2350, (2355, 2555, 2755, 3155 BSN 631621), 2550, 2750, 2940, 2950, 3140, 3150, 4030, 4040, 4040S, 4050, 4055, 4230, 4240, 4240S, 4250, 4255, 4430, 4440, 4450, 4455, 4555, 4560, 4630, 4640, 4650, 4755, 4760, 4840, 4850, 4955, 4960, 8100, 8100T, 8110, 8110T, 8120, 8120T, 8200, 8200T, 8210, 8210T, 8220, 8220T, 8300, 8300T, 8310, 8310T, 8320, 8320T, 8400, 8400T, 8410, 8410T, 8420, 8420T, 8430 Prior to 1981, 8440, 8450, 8520, 8520T, 8630, 8640, 8650, 8850, 9100, 9120, 9200, 9220, 9300, 9300T, 9320, 9320T, 9400, 9400T, 9420, 9420T, 9520, 9520T Note: may need to cut to length for some applications	Weatherstrip For Rear Cab Window Replaces RE570092	AMRE249465	\$ 37.00	
 7200, 7210, 7400, 7410, 7510, 7600, 7610, 7630, 7700, 7710, 7720, 7730, 7800, 7810, 7820, 7830, 7920, 7930, 8100, 8100T, 8110, 8110T, 8120, 8120T, 8200, 8200T, 8210, 8210T, 8220, 8230, 8230T, 8300, 8300T, 8310, 8310T, 8320, 8320T, 8330, 8330T, 8420, 8430, 8430T, 8520, 8530, 9100, 9120, 9200, 9220, 9230, 9300, 9300T, 9320, 9320T, 9330, 9400, 9400T, 9420, 9420T, 9430, 9430T, 9520, 9520T, 9530, 9530T, 9620, 9620T, 9630, 9630T	Weatherstrip 52" Long For Rear Cab Window Replaces R111684, R117033	AMR234302	\$ 14.43	
 6105M, 6110M, 6115M, 6120, 6120M, 6125M, 6130M, 6140M, 6145M, 6150M, 6155M, 6170M, 6175M, 6195M, 6220, 6230, 6320, 6330, 6420, 6430, 7130, 7220, 7230, 7320, 7330, 7420, 7430, 7520, 7530, Premium Models: 6230, 6330, 6430, 7130, 7230, 7330	Weatherstrip 264" Long For Panorama Style Windshield	AMAL155973	\$ 54.48	

Gas Struts



Application	Description	Part Number	Retail Price	Core
(2155, 2355N ASN 669788), 2355, 2555, 2755	Gas Strut, Hood	AMAL57946	\$ 23.15	
(6100, 6200, 6200L, 6300, 6300L, 6400, 6400L, 6500L BSN 150268), 6506, 6510, 6600, 6605, 6610, 6800, 6810, 6900, 6910, 6910S	Gas Strut, Hood	AMAL77767	\$ 20.00	
6100D, 6110D, (6115D, 6130D, 6140D BSN 050000), 6120, 6125D, 6215, 6220, 6220L, 6230, 6320, 6330, 6415, 6420, 6430	Gas Strut, Hood	AMAL174088	\$ 19.00	
6105M, 6105R, 6110M, 6110R, 6115M, 6115R, 6120M, 6120R, 6125M, 6125R, 6130M, 6130R	Gas Strut, Hood Replaces AL214868	AMAL209934	\$ 48.37	
6140J, 6155J, 6615, 6715, 7130, 7230P, 7330, 7330P, 7430P, 7530P	Gas Strut, Hood	AMAL174087	\$ 32.00	
6140M, 6140R, 6145M, 6145R, 6150M, 6150R, 6150RH, 6155M, 6155R, 6155RH, 6170M, 6175M, 6175R, 6195M, 6195R, 6215R	Gas Strut, Hood	AMAL215748	\$ 50.23	
6170R, 6190R, 6210R	Gas Strut, Hood	AMAL214376	\$ 47.90	
7200, 7210, 7400, 7410, 7510, 7600, 7610, 7700, 7710, 7800, 7810	Gas Strut, Hood	AMRE235000	\$ 19.00	
9120, 9220, 9300T, 9320, 9320T, 9400T, 9420, 9420T, 9520, 9520T, 9620, 9620T	Gas Strut, Hood	AMRE234993	\$ 47.25	
6105M, 6115M, 6125M, 6140M, 6150M, 6170M, 6230, 6330, 6430, 7130, 7220, 7230, 7320, 7330, 7420, 7430, 7520, 7530	Gas Strut, Roof Hatch	AMAL160699	\$ 19.00	
7200, 7210, 7400, 7410, 7510, 7600, 7610, 7700, 7800, 7810	Gas Strut, Door & Hood	AMRE70191	\$ 19.00	
5200, 5210, 5300, 5310, 5400, 5410, 5500, 5510	Gas Strut, Door	AMR132455	\$ 40.00	

John Deere®—Tractor

Application	Description	Part Number	Retail Price	Core
5220, 5320, 5420, 5520, 5603, 6100D, 6105M, 6110, 6110D, 6115D, 6115M, 6120, 6125D, 6125M, 6130D, 6140D, 6140J, 6140M, 6155J, 6170M, 6200, 6210, 6215, 6220, 6230, 6300, 6310, 6320, 6330, 6400, 6403, 6405, 6410, 6415, 6420, 6430, 6500, 6603, 6605, 6615, 6715, 7130, 7230, 7330, 7430, 7530	Gas Strut, Door Replaces AL78435, AL110629, AL151278	AMAL174358	\$ 19.00	
7720, 7815, 7820, 7920, 8100, 8110, 8120, 8120T, 8200, 8210, 8220, 8220T, 8300, 8320, 8320T, 8400, 8410, 8420, 8420T, 8520, 8520T, 9300T, 9320T, 9400T, 9420T, 9520T, 9620T	Gas Strut, Door Replaces RE44680	AMRE234165	\$ 19.00	
8100 BSN 001278, (8120, 8220, 8320, 8420, 8520 BSN 014366), 8200 ASN 001283, 8300 ASN 01972, 8400 ASN 000001, 8560, 8570, 8760, 8770, 8870, 8960, 8970, (9320T, 9420T, 9520T, 9620T BSN 902251) Replaces RE58715, RE234998	Gas Strut, Door	AM1343825C1	\$ 19.00	
8560, 8570, 8760, 8770, 8870, 8960, 8970	Gas Strut, Door Replaces RE23768	AMRE234998	\$ 20.00	
6105R, 6110R, 6115R, 6120R, 6125R, 6130R, 6140R, 6145R, 6150R, 6150RH, 6155R, 6155RH, 6170R, 6175R, 6190R, 6195R, 6210R, 6215R, 6230R, 6250R, Premium Models: 6230, 6330, 6430, 6530, 6630, 6830, 6930, 7130, 7230, 7330, 7430, 7530, 7530E	Gas Strut, Door & Rear Window	AMAL203035	\$ 51.43	
5215, 5220, 5320, 5420, 5520, 5603, 6100, 6110, 6110L, 6120, 6120L, 6130, 6200, 6200L, 6210, 6210L, 6215, 6220, 6220L, 6230, 6300, 6300L, 6310, 6310L, 6310S, 6320, 6320L, 6330, 6400, 6400L, 6405, 6410, 6410L, 6410S, 6415, 6420, 6420L, 6420S, 6430, 6500, 6500L, 6510, 6510L, 6510S, 6520, 6520L, 6530, 6600, 6605, 6610, 6615, 6620, 6630, 6715, 6800, 6810, 6820, 6830, 6900, 6910, 6910S, 6920, 6920S, 6930, 7130, 7220, 7230, 7320, 7330, 7420, 7515, 7520, SE6020, SE6120, SE6220, SE6320	Gas Strut, Steering Column Replaces AL150755	AMAL209275	\$ 45.00	
5055E, 5065E, 5065M, 5075E, 5075M, 5076E, 5080R, 5080RN, 5082E, 5083E, 5083EN, 5085E, 5085M, 5090E, 5090EH, 5090R, 5090RN, 5093E, 5093EN, 5095M, 5095MH, 5100M, 5100MH, 5100R, 5100RN, 5101E, 5101EN, 5105M, 5105ML, 5115M, 5115ML, 5225, 5325, 5325N, 5425, 5425N, 5525, 5525N, 5620, 5625, 5720, 5725, 5820, 6090MC, 6090RC, 6100MC, 6100RC, 6110MC, 6110RC	Gas Strut, Steering Column	AMAL222225	\$ 62.81	
7200, 7210, 7400, 7410, 7510, 7600, 7610, 7700, 7710, 7800, 7810	Gas Strut, Steering Column Replaces RE50227, RE151217	AMRE152042	\$ 65.00	
520, 530, 800, 5065M, 5070M, 5075M, 5080M, (5080RN, 5090RN, 5104, 5100RN, 5620, 5720, 5820, 6010, 6020, 6100, 6130, 6420S, 6506, 6510, 6534, 6600, 6610, 6620, 6630, 6810, 6820, 6830, 6900, 6910, 6910S, 6920, 6920S, 6930 - European), 5083E, 5085M, 5090M, 5093E, 5095M, 5095MH, 5100M, 5101E, 5105M, 5115M, 5220, 5225, 5320, 5325, 5420, 5425, 5520, 5525, 5603, 5625, 6110, 6120, 6155J, 6200, 6210, 6215, 6220, 6230, 6300, 6310, 6320, 6330, 6400, 6405, 6410, 6415, 6420, 6430, 6500, 6603, 6605, 6615, 6715, 7130, 7220, 7230, 7320, 7420, 7520	Gas Strut, Rear Window Replaces AL77303, AL81578, AL174357	AMAL114803	\$ 19.00	
1040, 1140, 1640, 2040, 2040S, 2140, 3040, 3140	Gas Strut, Rear Window	AMAL33170	\$ 16.00	
1640, 2040, 2040S, 2140, 2650, 2650N, 2850, 3040, 3140, 4050, 4055, 4250, 4255, 4450, 4455, 4555, 4650, 4755, 4955, 4850	Gas Strut, Rear Window Replaces AL35675, AL63085	AMAL66992	\$ 19.00	
7200, 7210, 7400, 7410, 7600, 7610 BSN 089999, 7700, 7710, 7800, 7810, 8100 BSN 005156, 8200 BSN 003732, 8300 BSN 006254, 8400 BSN 007009	Gas Strut, Rear Window Replaces RE174161, RE51083	AMRE234995	\$ 19.00	
7720, 7815, 7820, 7920, 8110, 8110T, 8120, 8120T, 8210, 8220, 8220T, 8310, 8310T, 8320, 8320T, 8410, 8410T, 8420, 8420T, 8520, 8520T, 9100, 9120, 9200, 9220, 9300, 9300T, 9320, 9320T, 9400, 9400T, 9420, 9420T, 9520, 9520T, 9620, 9620T	Gas Strut, Rear Window 15" Extended Length Replaces RE170089, RE174162	AMRE234166	\$ 19.00	

Prices Subject to Change without Prior Notice. The use of original equipment manufacturer (OEM) part numbers or trademarks, e.g. Case® and John Deere®, are for reference purposes only and for indicating product use and compatibility. Our company and the listed replacement parts contained herein are not sponsored, approved or manufactured by the OEM. All parts are New unless designated Reman in the description.

John Deere®—Tractor

Application	Description	Part Number	Retail Price	Core
8100 ASN 005157, 8100T, 8110, 8110T, 8200 ASN 003733, 8200T, 8210, 8210T, 8295RT, 8300 ASN 006255, 8300T, 8310, 8310RT, 8310T, 8320RT, 8335RT, 8345RT, 8360RT, 8400 ASN 007010, 8400T, 8410, 8410T, 9100, 9120, 9200, 9220, 9300, 9300T, 9320, 9320T, 9400, 9400T, 9420, 9420T, 9520, 9520T, 9620, 9620T	Gas Strut, Rear Window 12.75" Extended Length Replaces RE66665, RE190916	AMRE234988	\$ 20.00	

Fuel Tanks and Components

Made of high-quality polyethylene material unless otherwise noted.



Application	Description	Part Number	Retail Price	Core
(2440, 2640 ASN 341000)	Fuel Tank Kit Includes Polyethylene Fuel Tank, Fuel Cap, Filler Neck, Hose and Hose Clamps	AMAR90968	\$ 465.00	
920, 930, 1020, 1030, 1120, 1130, 1630, 2040, Utility: 820, 830, 2240 BSN 340999	Fuel Tank, Fiberglass	AMAR72910	\$ 495.00	
1520, 2020, 2030, (2440, 2640 BSN 340999), 2630, Ind: 300B	Fuel Tank w/ Cap	AMAR72996	\$ 465.00	
3010, 3020	Fuel Tank	AMAR39586	\$ 475.00	
4000, 4010, 4020	Fuel Tank	AMAR39587	\$ 475.00	
2350, (2355, 2555, 2755, 2855N ASN 669698), 2550, 2750	Fuel Sending Unit Replaces AL33498, AL38314	AMAL68201	\$ 55.00	
(2440, 2640 ASN 340999)	Fuel Sending Unit	AMAR93317	\$ 55.65	
2510	Fuel Sending Unit	AMAR38269	\$ 89.10	
2520	Fuel Sending Unit	AMAR38806	\$ 84.64	
3010, 3020 BSN 123000, 4010, 4020 BSN 201000, 8020, Ind: 500, 600	Fuel Sending Unit 2" Bolt Circle, 16.75" Overall Length Operates from 0 to 30 Ohms, Works w/ Positive or Negative Ground Systems, Gas or Diesel Includes Mounting Gasket	AMAR26434	\$ 44.01	
3020 ASN 123000, (4000, 4020 ASN 201000), 4320, Ind: 600 ASN 201000	Fuel Sending Unit Includes Mounting Gasket	AMAR46268	\$ 58.14	
4030, 4040, 4050, 4230, 4240, 4430	Fuel Sending Unit Replaces AR56614, RE221715	AMAR73995	\$ 62.11	
4050 ASN 005510, 4055, 4250, 4255, 4440, 4450, 4455, 4555, 4560, 4630, 4640, 4755, 4760, 4840, 4955, 4960	Fuel Sending Unit Replaces AR80622, RE11127, RE221707	AMRE19409	\$ 43.46	
5200, 5220, 5300, 5310N, 5320, (5320N, 5420N, 5520N - w/o Cab), 5400, 5400N, 5500, 5500N, 5510N	Fuel Sending Unit	AMRE190977	\$ 52.94	
(6110, 6120, 6210, 6220, 6320, 6410, 6420 - w/ High Clearance Tank), 6110L, 6200, 6200L, 6210L, 6300, 6300L, 6310, 6310L, 6400, 6400L, 6410L, 6500L, (6120L, 6215, 6220L, 6320L, 6420L, 6520L - w/o Tier 3 Engine)	Fuel Sending Unit w/ Pump For 30.6 Gallon Tank	AMAL113225	\$ 201.86	
Utility: 3033R, 3038R, 3039R, 3045R, 3046R, 3320, 3520, 3720, 4044R, 4049R, 4052R, 4066R, 4320, 4520, 4720	Fuel Sending Unit Replaces LVA17746, LVA19140	AMLVA15463	\$ 74.00	
5103, (5200, 5300, 5400, 5400N Engine ASN 202231), 5203, 5210, 5303, 5310, 5320N, 5403, 5410, 5420N, 5500, 5510, 5520N, 6200, 6200L, 6300, 6300L, 6400, 6400L, 6500, 6500L, 7200, (7210, 7410, 7510 BSN 706977), 7220, 7320, 7400, 7600 Engine ASN 483408, 7610	Fuel Filter Head Assembly	AMRE500160	\$ 74.07	

John Deere®—Tractor





Application	Description	Part Number	Retail Price	Core
1010, 1020, 1520, 1530, 2010, 2020, 2030, 2040, 2444, 2510, 2520, 2630, 2640, 3010, 3020, 4000, 4010, 4020, 4030, 4040, 4230, 4240, 4320, 4430, 4440, 4520, 4620, 4630, 5010, Utility: 820 w/ 3 Cylinder	Filler Neck Grommet	AMR39613R	\$ 16.00	
	Fuel Tank Cap	AMAT20911	\$ 8.00	
3010, 3020, 4000, 4010, 4020	LP Shut Off Valve This Kit will allow you to use original in-dash controls Includes Shut off valve and valve adapter Replaces AR26967	AMRE561679	\$ 150.00	
	Valve Adapter This adapter will allow you to use the new OEM LP valve and still be able to control the vapor and liquid controls from the operators station	AMX36245	\$ 50.00	

Steering Wheels and Caps







Application	Description	Part Number	Retail Price	Core
50*, 60*, 70*, 80* BSN 8203099, 520 BSN 52080999, 530, 620 BSN 6213099, 630, 720* BSN 7214899, 730*, BSN 8203099, (A, G, D - 1941 and Later), B 1949 and Later, R, Utility: 820* BSN 8203099 *w/ Power Steering	Steering Wheel 17 1/2", 3 Spokes, Keyed, Tapered Hub 3/4" to 7/8", 13/16" Shaft	AMAA380R	\$ 49.00	
520 BSN 5208100, 530, 620 ASN 6213100, 630, 720 BSN 7214900, 730, Utility: 820 BSN 8203100, 830	Steering Wheel Rubber Covered Steel Core, 3 Spokes, 18" Diameter, 36 Spline Hub For 7/8" Steering Shaft	AMAF3856R	\$ 76.00	
1020, 1030, 1120, 1130, 1520, 1530, 1630, 1830, 2020, 2030, 2040, 2120, 2130, 2440 BSN 350000, 2520, 2630, 2640, 3010 ASN 123000, 3120, 4000, 4020 ASN 201000, 4030, 4040, 4050, 4230, 4240, 4250, 4430, 4440, 4450, 4630, 4640, 4650, 4840, 4850, 8430, 8440, 8450, 8640, 8650, 8850, Ind: 300B, Utility: 2240 BSN 350000	Steering Wheel Smooth-finish, Dished Steering Wheel w/ 3 Covered Spokes, 16" Diameter, 7/8" Splined Hub	AMAR78405	\$ 64.00	
2010, 2510, 2520, 3010, 3020 BSN 123000, 4000, 4010, 4020 BSN 201000, 4320, 4520, 4620, 5020, 6030, 7020, 7520, Utility: 1010	Steering Wheel Flat-Style, Low-Profile Steering Wheel w/ 3 Covered Spokes, 16" Diameter, 7/8" Splined Hub	AMAR26625	\$ 49.00	
320, 330, 420, 430, 520, 530, 620, 630, 720, 730, 1010, 1020, 1520, 1530, 2010, 2020, 2030, 2040, (2440, 2640 BSN 340999), 2510, 2520, 2630, 3010, 3020, 4000, 4010, 4020, 4030, 4040, 4050, 4055, 4230, 4240, 4250, 4255, 4320, 4430, 4440, 4450, 4455, 4520, 4555, 4560, 4620, 4630, 4640, 4650, 4755, 4760, 4955, 4960, 5020, 5103, 5105, 5200, 5203, 5205, 5220, 5225, 5303, 5320, 5325, 5400, 5415 Narrow, 5420, 5425, 5520, 5525, 6030, 6120, 6220, 6320, 6403, 6420, 6603, 7020, 7200, 7210, 7220, 7320, 7400, 7410, 7420, 7510, 7520, 7600, 7610, 7700, 7710, 7720, 7800, 7810, 7820, 7920, 8100, 8110, 8120, 8200, 8210, 8220, 8300, 8310, 8320, 8400, 8410, 8420, 8430, 8440, 8450, 8520, 8560, 8570, 8630, 8640, 8650, 8760, 8770, 8850, 8870, 8960, 8970, 9100, 9120, 9200, 9220, 9300, 9320, 9400, 9420, 9520, 9620, Utility: 820, 830, 2240	Steering Wheel Cap Replaces AL118173, AL155227, F3629R	AMR47998	\$ 65.00	

John Deere®—Tractor











Air Conditioning and Components

Application	Description	Part Number	Retail Price	Core
 1640, 2040, 2140, (2250, 2450, 2650 BSN 646946), 2350, 2355, 2550, 2555, 2750, 2755, (2850, 4030 - w/o Idler Pulley), 3050, 3350, 4040S - All w/ 329 CID Engine	Compressor Conversion Kit A6 to Sanden Brackets Mount to Original A6 Mounting Brackets Includes Compressor, Mounting Brackets, Support Bracket, Compressor Manifold, Hex Shafts, Hi-Lo Pressure Switches, Wiring Harness for Hi-Lo Switches, Retrofit Adapters, O-Ring, Belt and Mounting Hardware Requires Pag Oil 100V, 6.76 oz (200 cc)	AMX10206	\$ 355.00	
	Ultra Pag Double End Capped, 100V, 8 oz	AMX10267	\$ 12.00	
	Universal Pag Oil, 8 oz	AMX10274	\$ 8.25	
	(2355, 2555, 2755, 2955 ASN 663473), 3055, 3155, 3255	Compressor Conversion Kit For Models w/ Compressor Mounted on Upper Left Side of Engine Only	AMX10294	\$ 495.00
 4050, 4055, 4250, 4255, 4450, 4455, 4555, 4560 BSN 003582, 4650, 4755 BSN 010678, 4760 BSN 003364, 4850, 4955 BSN 010370, 4960 BSN 005728, 8450, 8560, 8650, 8760, 8850, 8960	Compressor Conversion Kit Nippondenso to Sanden Includes Compressor, Mounting Brackets, Compressor Manifold, Retrofit Adapters, O-Rings and Mounting Hardware Requires Synthetic Ester Oil 100V, 6.42 oz (190 cc)	AMX10167	\$ 495.00	
	Premium Synthetic Ester Oil, 100V, 12 oz	AMX10273	\$ 11.00	
	 2940, 2950, 3040	Compressor Conversion Kit A6 to Sanden Includes Compressor, Mounting Brackets, Compressor Manifold, Binary Switches, Retrofit Adapters and Mounting Hardware Requires Pag Oil 100V, 6.76 oz (200 cc)	AMX10231	\$ 550.00
Ultra Pag Double End Capped, 100V, 8 oz		AMX10267	\$ 12.00	
Universal Pag Oil, 8 oz		AMX10274	\$ 8.25	
 4000, 4020, 4040, 4230, 4240, 4320, 4430, 4440, 4520, 4620, 4630, 5020, 6030, 7020, 7520, 8430, 8440, 8630, 8640	Compressor Conversion Kit A6 to Sanden Includes Compressor, Mounting Brackets, Compressor Manifold, Retrofit Adapters, O-Rings and Mounting Hardware Requires Pag Oil 100V, 6.76 oz (200 cc)	AMX10164	\$ 355.00	
	Ultra Pag Double End Capped, 100V, 8 oz	AMX10267	\$ 12.00	
	Universal Pag Oil, 8 oz	AMX10274	\$ 8.25	
	Compressor, Sanden Requires Pag Oil 100V, 6.76 oz (200 cc)	AMX10236	\$ 245.00	
	Ultra Pag Double End Capped, 100V, 8 oz	AMX10267	\$ 12.00	
	Universal Pag Oil, 8 oz	AMX10274	\$ 8.25	
 4040, 4230, 4240, 4430, 4440, 4630	Compressor Conversion Kit A6 Style to Sanden Style Includes Compressor, Mounting Brackets, Compressor Manifold, Receiver Drier, Expansion Valve, Adapters, Hoses, O-Rings and Mounting Hardware	AMX10258	\$ 795.00	











John Deere®—Tractor

Application	Description	Part Number	Retail Price	Core
 <p>4640, 4840</p>	Compressor Conversion Kit A6 Style to Sanden Style Includes Compressor, Mounting Brackets, Compressor Manifold, Binary Switch, Retrofit Adapters, O-Rings and Mounting Hardware Requires Pag Oil 100V, 6.76 oz (200 cc)	AMX10168	\$ 355.00	
	Ultra Pag Double End Capped, 100V, 8 oz	AMX10267	\$ 12.00	
	Universal Pag Oil, 8 oz	AMX10274	\$ 8.25	
	Sanden Replacement Compressor Requires Pag Oil 100V, 6.76 oz (200 cc)	AMX10185	\$ 325.00	
	Compressor to Condenser Hose Replaces A145696	AMX10170	\$ 50.00	
	Ultra Pag Double End Capped, 100V, 8 oz	AMX10267	\$ 12.00	
Universal Pag Oil, 8 oz	AMX10274	\$ 8.25		
 <p>1640, 2040, 2040S, 2140, 2250, 2350, 2355, 2450, 2550, 2555, 2650, 2750, 2755, 2850, 2940, 4000, 4020, 4030, 4040, 4230, 4240, 4320, 4350, 4430, 4440, 4520, 4620, 4630, 4640, 4840, 5020, 6030, 7020, 8440, 8630, 8640, 4WD: 7520, 8430 Replaces SE501456, SE501457, TY6665, TY6770</p>	Compressor w/ Dust Cover, HD Superheat Compressor, 12 Volt, w/ Single Groove Clutch, 5.58" (142 mm) Clutch Diameter, Can be used for 2 o'clock and 10 o'clock Positions, Must use Original Hoses and Belts, Replaces A6 Style w/ 10 Cylinder Nippondenso 10PA20 Style, Uses Less Power for Greater Efficiency Requires Pag Oil 46V, 7.00 oz (207 cc)	AMX10223	\$ 390.00	
	Ultra Pag Double End Capped, 46V, 8 oz	AMX10266	\$ 12.00	
 <p>(2250, 2450, 2650, 2850, 3050, 3350, 3650 BSN 646946 w/ SG2 Cab), 2350, 2355, 2550, 2555, 2750, 2755, 2940, 2950, 2955, 3140, 3150, 3155, 4000, 4020, 4030, 4040, 4230, 4240, 4320, 4430, 4440, 4520, 4620, 4630, 4640, 4840, 5020, 6030, 7020, 7520, 8430, 8440, 8630, 8640</p>	Compressor, A6 Style Superheat Compressor w/ Superheat Switch, 12 Volt, w/ Single Groove Clutch, 5.10" (130 mm) Clutch Diameter, Coil Mounted at 10 o'clock Position, Must use Original Manifold Requires Synthetic Ester Oil 100V, See Manufacturer for Oil Quantity	AMX10142	\$ 550.00	
	Premium Synthetic Ester Oil, 100V, 12 oz	AMX10273	\$ 11.00	
 <p>(2250, 2450, 2650, 2850 BSN 646946 w/ SG2 Cab), 2350, 2355, 2550, 2555, 2750, 2755, 2940, 2950, 2955, (3050, 3350, 3650 BSN 646946 w/ SG2 Cab), 3140, 3150, 3155, 4000, 4020, 4030, 4040, 4230, 4240, 4320, 4430, 4440, 4520, 4620, 4630, 4640, 4840, 5020, 6030, 7020, 7520, 8430, 8440, 8630, 8640 Replaces SE501456, SE501457, TY6665, TY6770</p>	Reman Frigidaire A6 Compressor Superheat Compressor, Superheat Switch Not Included, 12 Volt, w/ Single Groove Clutch, 5.58" (142 mm) Clutch Diameter, 0.50" Belt Width See Manufacturer for Oil Type and Quantity	AM50-014	\$ 345.00	\$ 100.00
 <p>4050, 4055, 4250, 4255, 4450, 4455, 4555, 4560 BSN 003582, 4650, 4755 BSN 010678, 4760 BSN 003364, 4850, 4955 BSN 010370, 4960 BSN 005728, 8450, 8560, 8650, 8760, 8850, 8960 Replaces RE501460, SE501464, SE503051, TY6626, TY6766</p>	Nippondenso Replacement Compressor 12 Volt, w/ Single Groove Clutch, 5.76" (146 mm) Clutch Diameter, Must use Original Manifold Requires Pag Oil 46V, 8.00 oz (236 cc)	AMX10203	\$ 345.00	
	Ultra Pag Double End Capped, 46V, 8 oz	AMX10266	\$ 12.00	
 <p>2855N ASN 663474, 3055, 3255, 4040, 4050, 4055, 4230, 4240, 4250, 4255, 4430, 4440, 4450, 4455, 4555, 4560 BSN 003583, 4630, 4640, 4650, 4755 BSN 010878, 4760 BSN 003365, 4840, 4850, 4955 BSN 010371, 4960 BSN 005729, 8450, 8560, 8650, 8760, 8850, 8960 Replaces RE10980, RE10981</p>	Nippondenso Manifold Kit Includes Suction Manifold, Discharge Manifold and Pressure Relief Valve Use w/ AMX10203 Compressor	AMX10253	\$ 75.00	





John Deere®—Tractor

Application	Description	Part Number	Retail Price	Core
 4560 ASN 003538, 4755 ASN 010679, 4760 ASN 003366, 4955 ASN 010371, 4960 ASN 005729, 8570, 8770, 8870, 8970 Replaces RE52454, RE55422, TY6784	Compressor, Nippondenso 10PA17C Style 12 Volt, w/ Single Groove Clutch, 5.748" (146 mm) Clutch Diameter, Must use Original Manifold Requires Pag Oil ND8, 7.77 oz (230 cc)	AMX10137	\$ 250.00	
	Denso ND8 Pag Oil, 46V, 8.50 oz	AMX10272	\$ 30.00	
 5200, 5210, 5300, 5310, 5400, 5500 Replaces RE64024, TY6789	Compressor, Nippondenso 10PA17C Style 12 Volt, w/ Single Groove Clutch, 5.748" (146 mm) Clutch Diameter, 0.50" Belt Width, Must use Original Manifold	AMX10138	\$ 350.00	
 5410, 5510, 7200, 7210, 7400, 7410, 7510, 7600, 7610, 7630, 7700, 7710, 7715, 7720, 7730, 7800, 7810, 7820, 7830, 7920, 8100, 8110, 8120, 8130, 8200, 8210, 8220, 8230, 8300, 8310, 8320, 8330, 8400, 8410, 8420, 8430, 8520, 8530, 9100, 9120, 9200, 9220, 9230, 9300, 9320, 9330, 9400, 9450, 9430, 9520, 9530, 9620, 9630 Replaces RE46609, TY6764, TY24304, RE69716	Compressor, Nippondenso Style 12 Volt, w/ 8-Groove Clutch for Serpentine Belt, 5.75" (146 mm) Clutch Diameter, Must use Original Manifold Requires Pag Oil ND8, 7.77 oz (230 cc)	AMX10139	\$ 250.00	
	Denso ND8 Pag Oil, 46V, 8.50 oz	AMX10272	\$ 30.00	
 6110, 6120, 6200, 6210, 6215, 6220, 6300, 6310, 6400, 6410, 6500, 6510, 7220, 7320, 7420, 7505, 7520 Replaces AL78779, AL153386, AL154203, AL155836, RE257084, TY6769	Compressor, Nippondenso Style 12 Volt, w/ 8-Groove Clutch for Serpentine Belt, 4.90" Clutch Diameter, Must use Original Manifold Requires Pag Oil 46V, 5.40 oz (160 cc)	AMX10140	\$ 315.00	
	Ultra Pag Double End Capped, 46V, 8 oz	AMX10266	\$ 12.00	
 7600, 7610, 7700, 7710, 7800, 7810, 9100, 9120, 9200, 9220, 9300, 9300T, 9320, 9400, 9400T, 9420, 9420T, 9520, 9520T, 9620, 9620T	Compressor Manifold Use w/ RE52454 Compressor Includes Cap and Pressure Valve	AMRE69715	\$ 100.00	
 (2040, 1640 w/ SG2 Cab), 3040, (3050, 3350, 2650, 2850, 2250, 2450 BSN 646946 w/ SG2 Cab), 3140, 3150, 4000, 4020, 4030, 4040, 4230, 4240, 4320, 4430, 4440, 4520, 4620, 4630, 4640, 4840, 5020, 6030, 7020, 8440, 8630, 8640 Replaces AR71287, AR71286	Compressor Clutch w/o Coil A6 Clutch w/o Coil, 5.58" Single Groove Pulley Includes Dust Cover, Hub, Pulley and Bearing	AMX10229	\$ 145.00	
 (2355, 2555, 2755, 2955, 3155 ASN 663474), 3055, 3255, 4050, 4055, 4250, 4255, 4450, 4455, 4555, 4560, 4650, 4755, 4760, 4850, 4955, 4960, 8450, 8560, 8650, 8760, 8850, 8960	Compressor Clutch 5.75" w/ 12 Volt Coil, Single Groove, Standard 6E171, w/o Dust Cover	AMRE10975	\$ 125.00	
 4560 ASN 003583, 4760 ASN 010679, 4955 ASN 010371, 4960 ASN 005729, 8770, 8850, 8870, 8970	Compressor Clutch w/ Pulley 10PA17C Clutch w/ 12 Volt Coil, 5.74" Single Groove Pulley	AMRE58348	\$ 110.00	
 5225, 5325, 5325N, 5425, 5425N, 5525, 5525N, 7200, 7210, 7400, 7410, 7510, 7600, 7610, 7700, 7710, 7720, 7800, 7810, 7815, 7820, 7920, 8100, 8100T, 8110, 8110T, 8120, 8120T, 8200, 8200T, 8210, 8210T, 8220, 8220T, 8300, 8300T, 8310, 8310T, 8320, 8320T, 8400, 8400T, 8410, 8410T, 8420, 8420T, 8520, 8520T, 9100, 9120, 9200, 9220, 9300, 9300T, 9320, 9320T, 9400, 9400T, 9420, 9420T, 9520, 9520T, 9620, 9620T	Compressor Clutch w/ Pulley 10PA17C Clutch w/ 12 Volt Coil, 5.70" 8-Groove Pulley w/o Dust Cover	AMRE52508	\$ 120.00	
 6120, 6200, 6200L, 6210, 6220, 6230, 6300, 6300L, 6310, 6320, 6330, 6400, 6400L, 6405, 6410, 6420, 6430, 6500, 6500L, 6510, 6605, 7220, 7320, 7420, 7520, 8200T, 8215T, 8220T, 8400T, 8415T, 8420T	Compressor Clutch w/ Pulley 10PA15C Clutch w/ 12 Volt Coil, 4.90" 8-Groove Pulley	AMAL78494	\$ 120.00	









John Deere®—Tractor

	Application	Description	Part Number	Retail Price	Core
	6110, 6200, 6200L, 6210, 6300, 6300L, 6310, 6400, 6400L, 6410, 6500, 6500L, 6510	Compressor Clutch Coil, 12 Volt 10PA15C, 10PA17C Inline Diode	AMX10232	\$ 60.00	
	6404, 6466 Engines	Compressor Conversion Bracket Kit A6 to Sanden Use w/ Ear Mount Sanden or Seltec Compressors	AMX10219	\$ 125.00	
	Universal Equipment	High Pressure Switch Normally Open, Opens at 305 PSI, Closes at 395 PSI, 7/16"x20 Thread	AMX10276	\$ 35.00	
	Universal Equipment	Low Pressure Switch Normally Open, Opens at 6 PSI, Closes at 45 PSI, Standard 7/16"x20 Thread	AMX10277	\$ 55.00	
	Universal Equipment	Low Pressure Switch Normally Open, Opens at 35 PSI, Closes at 46 PSI, Standard 7/16"x20 Thread	AMX10278	\$ 42.00	
	Most Models	High Pressure Switch Normally Closed, Opens at 375 PSI, Closes at 190 PSI	AMX10227	\$ 27.00	
	Most Models	Low Pressure Switch Normally Open, Opens at 6 PSI, Closes at 31 PSI For use on low side of system. Shuts compressor off before going into vacuum. Wires switch in series w/ coil wire for low side protection.	AMX10226	\$ 22.00	
	6120	Binary Pressure Switch Normally Open Low Pressure Opens at 28 PSI, Closes at 25 PSI High Pressure Opens at 350 PSI, Closes at 220 PSI 7/16"x20 Thread Replaces AL112954	AMAL168231	\$ 47.00	
	4030, 4040, 4050, 4055, 4230, 4240, 4250, 4255, 4430, 4440, 4450, 4455, 4520, 4555, 4560, 4620, 4630, 4640, 4650, 4755, 4760, 4840, 4850, 4955, 4960, 5020, 5200, 5210, 5300, 5310, 5400, 5410, 5500, 8430, 8440, 8450, 8630, 8640, 8650, 8850 Replaces AR59779, AL59879	Rotary Adjustable Thermostatic Switch 36" Capillary Tube	AMX10251	\$ 45.00	
	4000, 4020, 4040, (4040, 4240, 4440 European), 4230, 4240, 4320, 4430, 4440, 4520, 4620, 4630, 5020, 6030, 7020, 8440, 8630, 8640, 4WD: 7520, 8430	Clutch Saver Kit Protects Clutch from Slipping Due to Low Voltage, Maintains Adequate Voltage to Clutch Coil at all Times	AMX10252	\$ 25.00	

















John Deere®—Tractor

Application	Description	Part Number	Retail Price	Core
 <p>2040, (2140, 3040, 3140 ASN 430000), 2250, 2350, 2355, 2450, 2550, 2555, 2650, 2750, 2755, 2850, 2855, 2940, 2950, 2955, 3050, 3055, 3150, 3155, 3255, 3350, 3650, 4030, 4040, 4050, 4055, 4230, 4240, 4250, 4255, 4430, 4440, 4450, 4455, 4555, 4560, 4630, 4640, 4650, 4755, 4760, 4840, 4850, 4955, 4960, 5200, 5210, 5300, 5310, 5400, 5410, 5500, 5510, 6110, 6200, 6210, 6300, 6310, 6400, 6410, 6500, 6510, 7200, 7210, 7400, 7410, 7600, 7610, 7700, 7800, 7810, 8430, 8440, 8450, 8630, 8640, 8650, 9100, 9200, 9300, 9400 Replaces AH234098, AL77581, AR59780, AR59870, AR74486, RE49169, RE214439, RE291794</p>	Receiver Drier	AMX10154	\$ 25.00	
	Receiver Drier, Import 4" x 7 1/2", Inlet - #6 Female O-Ring, Outlet - #6 Male O-Ring, R12 and R134a Compatible	AMX10208	\$ 22.00	
 <p>4000, 4020, 4320, 4520, 4620, 5020, 7020, 7520 4WD Replaces AR45867</p>	Receiver Drier 3" x 6" Male Flare, R12 and R134a Compatible	AMX10211	\$ 22.00	
 <p>6120, 6215, 6220, 6320, 6420, 7420, 7520</p>	Receiver Drier 4" x 7 1/2", R12 and R134a Compatible, Inlet - #6 Female O-Ring, Outlet - #6 Male O-Ring Replaces AL162467	AMX10180	\$ 25.00	
 <p>(6120, 6220, 6320, 6320L, 6420, 6420L, 6520L, 7420, 7520 ASN 398656), 6230, 6330, 6430, 7130, (7220, 7320 ASN 012451), 7230, 7330, 7430</p>	Receiver Drier 3" x 11.5" Female O-Ring to Male O-Ring, R12 and R134a Compatible	AMAL163559	\$ 35.00	
 <p>7720, 7815 Brazil, 7820, 7920, (8120, 8220, 8320, 8420, 8520 ASN 014715), 8120T, 8220T, 8320T, 8420T, 8520T</p>	Receiver Drier 3" x 11 1/2", Inlet - #6 3/8" Female O-Ring, Outlet - #6 3/8" Male O-Ring, R12 and R134a Compatible	AMRE214440	\$ 28.00	
 <p>8100, 8110, 8200, 8210, 8300, 8310, 8400, 8410 Replaces AH234099, AT125596, AT162848, AXE53638</p>	Receiver Drier 4" x 9", Inlet - #6 3/8" Female O-Ring, Outlet - #6 3/8" Male O-Ring, R12 and R134a Compatible Replaces AH234099, AT125596, AT162848, AXE53638	AMX10156	\$ 36.00	
 <p>8560, 8570, 8760, 8770, 8870, 8960, 8970</p>	Accumulator Kit, Steel 3 1/2" Diameter, 8 1/2" Overall Height Includes 461-3126 Standard 1/4" Switch Port and 461-3124 #12 Metric Switch Port Can Use RE24957 Standard or RE52295 Metric Pressure Switches Replaces RE24620	AMRE51918	\$ 50.00	
 <p>1640, 2040, 2040S, 2140, 2250, 2355, 2450, 2550, 2555, 2650, 2750, 2755, 2840, 2850, 2855N, 2950, 2955, 3040, 3050, 3055, 3140, 3150, 3155, 3255, 3355, 3640, 4030, 4040, 4050, 4055, 4230, 4240, 4250, 4255, 4430, 4440, 4450, 4455, 4555, 4560, 4630, 4640, 4650, 4755, 4840, 4850, 4955, 4960, 8440, 8450, 8630, 8640, 8650, 8850; 4WD - 8430</p>	Expansion Valve, OEM Bulb Type Externally Equalized 9" Capillary Tube, R12 and R134a Compatible	AMRE206757	\$ 20.00	
 <p>2040, 2140, 2250, 2350, 2355, 2450, 2550, 2555, 2650, 2750, 2755, 2850, 2855, 2940, 2950, 2955, 3040, 3050, 3055, 3140 ASN 430000, 3150, 3155, 3255, 3350, 3650, 4030, 4040, 4050, 4055, 4230, 4240, 4250, 4255, 4430, 4440, 4450, 4455, 4555, 4560, 4630, 4640, 4650, 4577, 4750, 4840, 4850, 4955, 4960, 8430, 8440, 8450, 8630, 8640, 8650, 8850 Replaces AL37525, RE13886, AH140818, AR58482</p>	Expansion Valve Bulb Type, Externally Equalized, R12 and R134a Compatible, 14" Tube Length, O-Ring Connection	AMX10145	\$ 20.00	









John Deere®—Tractor

Application	Description	Part Number	Retail Price	Core
 4000, 4020, 4320, 4520, 4620, 5020, 6030, 7020, 4WD: 7520 Replaces AR49961	Expansion Valve Internally Regulated w/ 12" Capacity Tube w/ Flare Connection, R12 and R134a Compatible	AMX10215	\$ 30.00	
 5200, 5210, 5300, 5310, 5400, 5410, 5500, 5510, 6210, 6310, 6410, 6510, 6610, 8100, 8110, 8200, 8210, 8300, 8310, 8400, 8410, 9100, 9200, 9300, 9400	Expansion Valve Block Type, R12 and R134a Compatible, O-Ring Connection Replaces RE57575	AMX10147	\$ 35.00	
 5083E, 5083E Limited, 5083EN, 5085E, 5085E Limited, 5085M, 5093E, 5093E Limited, 5100E, (5220, 5320 BSN 420001), 5325, 5420, 5425, 5520, 5525, 6120, 6220, 6230, 6320, 6320L, 6330, 6403, 6420, 6420L, 6430, 6520L, 6603, 7200 ASN 003822, 7200R, 7210, 7210R, 7215R, 7220, 7230R, 7250R, 7260R, 7270R, 7280R, 7290R, 7320, 7330, 7400 ASN 005043, 7410, 7420, 7510, 7520, 7600, 7610, 7700, 7710, 7720, 7730, 7800, 7810, 7820, 7830, 7920, 7930, 8110, 8110T, 8120, 8120T, 8130, 8210, 8210T, 8220, 8220T, 8225R, 8230, 8230T, 8235R, 8245R, 8260R, 8270R, 8285R, 8295R, 8295RT, 8310, 8310R, 8310RT, 8310T, 8320, 8320R, 8320RT, 8320T, 8330, 8330T, 8335R, 8335RT, 8345R, 8345RT, 8360R, 8360RT, 8370R, 8370RT, 8400R, 8410, 8410T, 8420, 8420T, 8430, 8430T, 8520, 8520T, 8530, 9100, 9120, 9200, 9220, 9300, 9320, 9320T, 9330, 9360R, 9370R, 9400, 9410R, 9420, 9420R, 9420RX, 9420T, 9430, 9460R, 9460RT, 9470R, 9470RT, 9470RX, 9510R, 9510RT, 9520, 9520R, 9520RT, 9520RX, 9520T, 9530, 9530T, 9560R, 9560RT, 9570R, 9570R, 9570RX, 9620, 9620R, 9620RX, 9620T ASN 901999, 9630, 9630T, Premium Models: 6230, 6330, 6430, 7330 Replaces AL160578, RE283957	Expansion Valve Flange Style, R12 and R134a Compatible	AMRE174764	\$ 20.00	
 5310N, 5320N, 5325N, 5400N, 5425N, 5420N, 5425N, 5510, 5510N, 5520N, 5525N, 6200, 6200L, 6215, 6300, 6300L, 6400, 6400L, 6405, 6415, 6500, 6500L, 6605, 6615, 6715, 7200 BSN003822, 7400, 7505, 7600 BSN008003, 7700, 7800 Replaces AL160645, RE62137, AT275040	Expansion Valve Block Type Flange Mount, R12 and R134a Compatible	AMAL77579	\$ 40.00	
 4040, 4230, 4240, 4430, 4440, 4630	R134a Hose Conversion Kit 10 piece hose and steel line kit, Includes Hold Down Plate, Cab Line Plate and Adaptor and O-Rings	AMX10222	\$ 425.00	
 4030, 4050, 4055, 4250, 4255, 4450, 4455, 4555, 4560, 4640, 4650, 4755, 4760, 4840, 4850, 4955, 4960	Hose Kit, 7 Pc. Cab Only Includes (5) Aluminum Lines and (2) Roof Hoses	AMX10256	\$ 295.00	
 4555, 4560, 4650, 4755, 4760, 4850, 4955, 4960	Hose Kit Cab Forward Hoses Only Includes Receiver Drier, O-Rings and R134 Adapters	AMX10255	\$ 250.00	
 8440, 8640	Hose Kit, 9 Pc. Includes (5) Hoses and (4) Steel Lines	AMX10259	\$ 545.00	







John Deere®—Tractor

Application	Description	Part Number	Retail Price	Core
 4040, 4230 ASN 007284, 4240, 4430 ASN 010933, 4440, 4630 ASN 082434, (8245R, 8270R, 8295R, 8320R, 8335R, 8345R, 8370R SN 090001-170000), (8320RT, 8345RT, 8370RT SN 912001-924000), 8400R ASN 115000	Condenser to Cab Hose 5/16" ID	AMRE57320	\$ 65.00	
 4640, 4840	Condenser to Cab Hose	AMRE57334	\$ 68.00	
 1640, 2040, 2140, 2350, 2550, 2750	Compressor to Condenser Hose Replaces AL70927	AMX10292	\$ 110.00	
 4030 ASN 013680	Compressor to Condenser Hose Replaces RE57325	AMX10286	\$ 85.00	
 4040, 4230, 4240, 4430, 4440, 4630	Compressor to Condenser Hose Replaces AR75567, RE256378	AMRE57327	\$ 75.00	
 4555 BSN 010000, 4560 BSN 003582, 4650, 4755 BSN 010877, 4760 BSN 003364, 4850, 4955 BSN 010370, 4960 BSN 005728	Compressor to Condenser Hose Replaces AR99854	AMRE57342	\$ 130.00	
 4640, 4840	Compressor to Condenser Hose Replaces AR87375, RE57333	AMX10288	\$ 84.00	
 (4030, 4230 ASN 004529), 4040, 4050, 4055, 4240, 4250, 4255, 4430 ASN 016534, 4450, 4455, 4560, 4630 ASN 004070, 4640, 4650, 4755, 4760, 4840, 4850, 4955, 4960, Utility: 4400	Quick Coupler to Receiver Drier Line Steel Line	AMRE37063	\$ 30.00	
 (4040, 4240, 4440, 4640, 4840 - w/ Cab BSN 167111), 4230, 4430, 8430, 8630	Evaporator Inlet Hose	AMRE57312	\$ 21.00	
 4050 ASN 005479, 4055, 4230, 4250 ASN 009608, 4255, 4430, 4450 ASN 019676, 4455, 4555, 4560, 4630, 4640, 4650, 4755, 4760, 4840, 4850, 4955, 4960, 8430, 8450, 8630, 8650, 8850	Evaporator Outlet Hose 1/2" ID Replaces AR58277, RE57351	AMRE161224	\$ 40.00	
 4030, 4040, 4050 BSN 005479, 4230, 4240, 4250 BSN 009608, 4430, 4440, 4450 BSN 019676, 4630, 4640, 4650 BSN 010928, 4840, 4850 BSN 008962	A/C Pressure Line	AMAR58281	\$ 25.00	
 (4030, 4230 ASN 004528), 4040, 4050 BSN 005479, 4240, 4250 BSN 009608, 4430 ASN 016533, 4440, 4450 BSN 019676, 4630 ASN 004069, 4640, 4650 BSN 010928, 4840, 4850 BSN 008962	Receiver Drier Outlet Line	AMAR65756	\$ 15.00	
 4030 ASN 013680	Suction Hose Replaces RE57326	AMX10287	\$ 115.00	
 4230, 4430, 4630, 4040, 4240, 4440 Replaces RE256380	Front Suction Hose	AMAR75568	\$ 80.00	
 (2355, 2555, 2755, 2955, 3155 ASN 663474), 3055, 3255	Return Line, Front Suction Hose Replaces AL64279, AL70474	AMX10291	\$ 55.00	
 4030, 4040, 4050 BSN 005479, 4230, 4240, 4250 BSN 009608, 4430, 4440, 4450 BSN 019676, 4630, 4640, 4650 BSN 010928, 4840, 4850 BSN 008962	Return Line w/ Insulation	AMAR58278	\$ 37.00	













John Deere®—Tractor

Application	Description	Part Number	Retail Price	Core
 (4030, 4230 ASN 004528), 4040, 4050 BSN 005479, 4240, 4250 BSN 009606, 4430 ASN 016533, 4440, 4450 BSN 019676, 4630 ASN 004069, 4640, 4650 BSN 010928, 4840, 4850 BSN 008962	Return Line w/ Insulation, 2 Pc. Some models may have 1-piece steel suction line and require both upper and lower lines for replacement	AMAR65755	\$ 35.00	
 (4030, 4230 ASN 004528), 4040, 4050, 4240, 4250, 4430 ASN 016533, 4440, 4450, 4555, 4560, 4630 ASN 004069, 4640, 4650 ASN 010927, 4755, 4760, 4840, 4850 ASN 008961, 4955, 4960	Return Line, Front and Rear Rubber Hose Replaces Steel Return Lines Replaces AR65755, RE36365	AMX10289	\$ 84.00	
 4040, 4230, 4240 Cab ASN 082855, 4430 Cab ASN 082819, 4440, 4630 Cab ASN 082433	Return Line, Front Suction Hose Replaces AR75568, RE57328	AMRE256380	\$ 80.00	
 8440, 8640	Return Line, Front Suction Hose Replaces RE58486	AMX10290	\$ 110.00	
 4030, 4040, 4230, 4240, 4430, 4440, 4630, 4640, 4840, 8430, 8440, 8630, 8640	O-Ring Kit, 30 Pc. All O-Rings and Quick Coupler Square Cut Seals	AMX10254	\$ 12.00	
 1640, 2040, 2040S, 2140, 2350, 2550, 2750, 2940, 2950, 3040, 3140, 4030, 4040, 4040S, 4050, 4055, 4230, 4240, 4240S, 4250, 4255, 4350, 4430, 4440, 4450, 4455, 4555, 4560, 4630, 4640, 4650, 4755, 4760, 4840, 4850, 4955, 4960, 8430 w/ MFWD, 8440, 8450, 8630, 8640, 8650, 8850, 4WD: 8430	Blower Motor Update Kit Complete Assembly w/ Resistor Includes One Assembly for Models w/ Single Blower Motor 12 Volt, Mounting Base: 21" x 6 5/8"	AMAR82006	\$ 270.00	
 (3020, 4320, 4620, 6030 - w/ Hinson Cab), (4000, 4020, 5020 - w/ Hinson Cab or Stolper Cab ASN 208299), 4030 w/ Sound-Gard™ Cab BSN 167884, (4040, 4240 - w/ Sound-Gard™ Cab BSN 167111), 4230, 4430, 4440, 4630, 4640 Cab BSN 167111, 7020, 7520, 8430, 8630	Blower Motor Update Kit Complete Assemblies, Includes both Assemblies to replace OEM plastic assemblies for tractors w/ double blower Motors 12 Volt, Mounting Base: 14 3/4" x 5" Replaces AR49968, AR68973	AMAR74019	\$ 385.00	
5200, 5300, 5400, 5500, 7200, 7210, 7400, 7410, 7510, 7600, 7610, 7630, 7700, 7710, 7720, 7730, 7800, 7810, 7820, 7830, 7920, 7930, 8100, 8100T, 8110T, 8120, 8120T, 8200, 8200T, 8210T, 8220, 8220T, 8300, 8300T, 8310T, 8320, 8320T, 8400, 8400T, 8410T, 8420, 8420T, 8520, 8520T, 9100, 9120, 9200, 9220, 9230, 9300, 9300T, 9320, 9320T, 9330, 9400, 9400T, 9420, 9420T, 9430, 9430T, 9520, 9520T, 9530, 9530T, 9620, 9620T, 9630, 9630T, (8110, 8130, 8210, 8230, 8230T, 8310, 8330, 8330T, 8410, 8430, 8430T, 8530 - w/o Auto Temp Control), Sprayers: 4700, 4710, 4720, 4730, 4830, 4920, 4930, 4940	Blower Motor Resistor	AMRE171329	\$ 22.75	
 (1640, 2040 SG2 Cab BSN 500462), (2140, 3040, 3140 Cab SN 430000-500460), 2350, 2750, 2940, 2950, (4030, 8430, 8630 Cab ASN 167884), (4040, 4240, 4440, 4640, 4840 Cab ASN 167111), 4230*, 4250, 4255, 4430*, 4450, 4455, 4555, 4560, 4630*, 4650, 4755, 4760, 4850, 4955, 4960, 8440, 8450, 8640, 8650, 8850 *Fits 4230, 4430 and 4630 w/ replacement SG body or replacement inner roof w/ SG1 Blower Replaces RE25160, AR82010, AR82005, RE13882, RE251028	Blower Motor Single Speed, Double Shaft, 2-Wire, Reversible, 3/8" Shaft Diameter, 5" Long	AMX10119	\$ 60.00	















John Deere®—Tractor

Application	Description	Part Number	Retail Price	Core
 1640*, 2140*, 2355, 2555, 2650, 2750 Late, 2755, 2850, 2955, 3040*, 3140*, 3150, 3155, 3255, 5200, 5210, 5220, 5300, 5310, 5320, 5400, 5410, 5500, 5510, 6110, 6120, 6200, 6210, 6215, 6220, 6300, 6310, 6400, 6410, 6500, 6510, 7200, 7210, 7220, 7320, 7400, 7410, 7420, 7520, 7600, 7610, 7700, 7710, 7800, 7810 *Cab ASN 500463 Replaces AL39043, AL110881, AL80700	Blower Motor	AMX10173	\$ 115.00	
 (4000, 4020, 4320, 4520, 4620, 6030, 7020, 7520 - w/ Hinson Cab), (4030, 8430, 8630 - w/ Cab BSN 167883), (4040, 4240, 4440, 4640, 4840 - w/ Cab BSN 167110), (4230, 4430, 4630 - w/ Double Blower Motors), 5020 ASN 025000 Replaces AR62497, RE223623	Blower Motor Single Speed, Double Shaft, 2-Wire, Reversible, 5/16" Shaft Diameter, 2 3/4" Long	AMX10112	\$ 55.00	
 4020, 4320, 4520, 4620 - w/ Hiniker Cab Replaces AR49962	Blower Motor, 12 Volt Single Speed, Reversible, 2-Wire, Single Shaft, 1 1/2" Shaft Length, 5/16" Diameter, 6" Overall Length, 3" Overall Diameter	AMX10123	\$ 80.00	
 7720, 7820, 7920, 8120, 8220, 8320, 8420, 8520, 9120, 9220, 9320, 9420, 9520, 9620	Blower Motor w/ Wheel 12 Volt, Single Speed, Single Shaft, 2-Wire, 5/16" Shaft Diameter, 1 5/8" Shaft Length Replaces RE162771, RE300527	AMRE208336	\$ 255.00	
 7720, 7820, 7920, 8120, 8220, 8320, 8420, 8520, 9120, 9220, 9320, 9420, 9520, 9620	Blower Motor w/ Wheel, Pressurizer 12 Volt, Single Speed, Single Shaft, 2-Wire, 5/16" Shaft Diameter, 2 5/16" Shaft Length Replaces RE159446, RE300524	AMRE208337	\$ 220.00	
 8100, 8110, 8200, 8210, 8300, 8310, 8400, 8410	Blower Motor Single Speed, Single Shaft, 2-Wire, Reversible, 5/16" Shaft Diameter, 1 1/2" Long	AMRE61419	\$ 69.00	
 8560, 8760, 8960	Blower Motor 12 Volt, Single Speed Vented Motor, 2-Wire w/ 5/16" Shafts, Fits early style tractors w/ a bolt-on flange attached to studs on motor, Must reuse original steel flange	AMRE37153	\$ 65.00	
 8560, 8570, 8760, 8770, 8960, 8970	Blower Motor 12 Volt, Single Speed Vented Motor, 2-Wire w/ 5/16" Shaft, Flange Mount Has 1-Piece Bracket/Flange Welded to Body of Motor	AMRE53219	\$ 200.00	
 8560, 8570, 8760, 8770, 8870, 8960, 8970	Pressurizer Motor 12 Volt, Single Speed, Single Shaft, 2-Wire, Reversible, 5/16" Shaft Diameter, 2 3/8" Long	AMRE46880	\$ 65.00	
 9400, 9410, 9450, 9500, 9500SH, 9510, 9510SH, 9550, 9550SH, 9560, 9560SH, 9600, 9610, 9650, 9650CTS, 9650STS, 9660, 9660CTS, 9660STS, 9750STS, 9760STS, 9860STS, CTS, CTS II Replaces AH167731	Pressurizer Motor Single Speed, Single Shaft, 2-Wire, CW, 5/16" Shaft Diameter, 1 3/8" Long	AMX10171	\$ 90.00	
 1640, 2040, 2140, 2350, 2550, 2750, 2940, 2950, 3040, 3140, 4030, 4040, 4050, 4055, 4230, 4240, 4250, 4255, 4430, 4440, 4450, 4455, 4555, 4560, 4630, 4640, 4650, 4755, 4760, 4840, 4850, 4955, 8440, 8450, 8630, 8640, 8650, 8850, 4WD: 8430	Blower Wheel, Plastic 4" Diameter, 3/8" Shaft, Reversible, Double Vented, Clamps Not Included	AMR81111	\$ 25.00	
 4000, 4020, 4030, 4040, (4040, 4240, 4440 European), 4230, 4240, 4320, 4430, 4440, 4620, 4630, 4640, 4840, 5020, 7020, 8630, 4WD: 7520, 8430	Blower Wheel, Plastic 3 1/4" Diameter, 5/16" Shaft Diameter, Reversible, Double Vented	AMAR66028	\$ 12.50	















John Deere®—Tractor

Application	Description	Part Number	Retail Price	Core
 4030, 4040, 4040 European, 4230, 4240, 4240 European, 4320, 4430, 4440, 4440 European, 4620, 4630, 4640, 4840, 6030, 7020, 4WD: 7520	Blower Motor Switch Update Kit 3-Speed, Includes New Style Switch and Resister Replaces Tandem Style Blower Switch	AMX10250	\$ 75.00	
 1640, 2040, 2140, 2350, 2550, 2750, 2940, 2950, 3040, 3140, 3150	Condenser Core: 17 1/2" x 14" x 1 1/4"	AMAL30364	\$ 285.00	
 2355, 2555, 2650, 2755, 2850, 2955, 3055, 3155, 3255	Condenser	AMAL70298	\$ 210.00	
 4030 ASN 005649	Condenser Overall: 12 1/2" x 21" Core: 9" x 21" x 2"	AMAR65854	\$ 275.00	
 4050, 4055, 4250, 4255, 4450, 4455, 4555, 4560, 4650, 4755, 4760	Condenser w/ Oil Cooler Overall: 22 1/4" x 24" Core: 22" x 20 1/4" x 3"	AMAR112965	\$ 455.00	
 4040, 4230, 4430, 4630	Condenser w/ Oil Cooler Overall: 20 1/4" x 23 1/4" Core: 19 3/4" x 18 1/2" x 2 1/2"	AMAR61885	\$ 222.95	
 4240, 4440, 4640	Condenser w/ Oil Cooler Overall: 22 1/4" x 24 1/2" Core: 22" x 20 1/2" x 2 1/2"	AMAR96767	\$ 365.00	
 4840	Condenser w/ Oil Cooler Overall: 26 1/4" x 26" Core: 25 1/2" x 23 1/4" x 3 1/2"	AMAR79857	\$ 775.00	
 4850, 4955, 4960	Condenser w/ Oil Cooler Overall: 26 1/2" x 28" Core: 26" x 23" x 3" Replaces AR96903	AMAR112966	\$ 550.00	
 5076E, 5076EN, 5082E, (5083E, 5093E, 5101E BSN 340000), (5083EN, 5093EN, 5101EN BSN 370000), 5090E, 5090EH, 5090EN, 5225, 5325, 5325N, 5425, 5425N, 5525, 5525N, 5603, 5625	Condenser w/ Oil Cooler	AMRE229585	\$ 436.00	
5200, 5300, 5400, 5400N, 5500, 5500N	Condenser Includes Mounting Bracket Overall: 15.25" x 21" Core: 12" x 18" x 2.50"	AMRE67220	\$ 385.00	
 6120, 6215, 6220, 6230, 6320, 6330, 6415, 6420, 6430, 6520L, 6615, 6715, 7130, 7220, 7230, 7320, 7330, 7420, 7430, 7520 MFWD, (7710, 7810 ASN 090000) Replaces AL156282	Condenser Overall: 20 1/8" x 22 1/4" Core: 17 1/2" x 18 1/2"	AMAL157615	\$ 385.00	
 (6200, 6200L, 6300, 6300L, 6400, 6500L BSN 175247), 6400L, 6500 Replaces AL77977, AL111999, AL112424	Condenser w/ Oil Cooler Overall: 20.50" x 24.50" Core: 16" x 20"	AMAL119566	\$ 575.00	
 7200, 7210, 7400, 7410, 7510	Condenser w/ Oil Cooler	AMRE55139	\$ 615.00	

John Deere®—Tractor















Application	Description	Part Number	Retail Price	Core
 7200 BSN 003307, 7400 BSN 004212	Condenser w/ Fuel Cooler	AMRE55140	\$ 324.00	
 (7200R, 7215R, 7230R, 7260R, 7280R BSN 080000)	Condenser	AMRE287864	\$ 600.00	
 (7210R, 7230R, 7250R, 7270R, 7290R, 7310R ASN 080001)	Condenser	AMRE560279	\$ 550.00	
 7600, (7610, 7710, 7810 BSN 089999), 7700, 7800	Condenser w/ Oil Cooler	AMRE34166	\$ 595.00	
 7630, 7730, 7830	Condenser w/ Fuel Cooler	AMRE226365	\$ 425.00	
 7720, 7820, 7920	Condenser w/ Fuel and Oil Cooler Condenser w/ Fuel Cooler	AMRE201742 AMRE181894	\$ 1775.00 \$ 875.00	
 (8100, 8200, 8300, 8400 BSN 009999)	Condenser w/ Fuel and Oil Cooler Replaces RE61071	AMRE63468	\$ 565.00	
 (8100, 8200, 8300, 8400 ASN 010000), 8100T, 8110, 8110T, 8200T, 8210, 8210T, 8300T, 8310, 8310T, 8400T, 8410, 8410T	Condenser w/ Fuel and Oil Cooler	AMRE66573	\$ 575.00	
 8120, 8120T, 8220, 8220T, 8320, 8320T, 8420, 8420T, 8520, 8520T	Condenser w/ Fuel and Oil Cooler Overall: 26" x 31" x 4" Core: 25 3/8" x 25" x 3 7/8" Replaces RE218194	AMRE222984	\$ 1200.00	
 (8120, 8220, 8320 BSN 014425), (8120T, 8220T, 8320T, 8420T, 8520T BSN 902343), (8420, 8520 BSN 014430)	Condenser w/ Fuel Cooler	AMRE183331	\$ 953.00	
 (8230R, 8285R, 8310R, 8335R, 8360R SN 016001-090000), (8310RT, 8335RT, 8360RT SN 902501-912000)	Condenser w/ Fuel Cooler Replaces RE297791	AMRE566085	\$ 977.00	
 (8235R, 8285R, 8310R, 8335R, 8360R SN 016001-090000), (8310RT, 8335RT, 8360RT SN 902501-912000), (9360R, 9410R, 9460R, 9510R, 9560R SN 000101-014999), (9370R, 9420R, 9470R, 9520R, 9570R ASN 015000), (9460RT, 9510RT, 9560RT SN 900101-905999), (9470RT, 9520RT, 9570RT ASN 906000), 9470RX, 9520RX, 9570RX	Condenser	AMRE297792	\$ 825.00	
 8440	Condenser w/ Oil Cooler Replaces AR75968	AMAR78958	\$ 1642.00	
 8560, 8760	Condenser	AMRE28764	\$ 546.00	
 8570, 8770, 8870	Condenser	AMRE53802	\$ 1300.00	

John Deere®—Tractor

Application	Description	Part Number	Retail Price	Core
 8960 ASN 004101, 8970	Condenser w/ Fuel Cooler	AMRE47768	\$ 1066.00	
 9100, 9200	Condenser w/ Oil Cooler	AMRE63881	\$ 2900.00	
 9120, 9220 - w/ Powershift Transmission	Condenser w/ Oil Cooler	AMRE172495	\$ 3425.00	
 9120, 9220, 9320, 9320T, 9420, 9420T, 9520, 9520T, 9620, 9620T	Condenser	AMRE171721	\$ 450.00	
 9200	Condenser w/ Oil Cooler Core: 28" x 36" x 3.80"	AMRE70871	\$ 3300.00	
 9230, 9330, 9430, 9430T, 9530, 9530T, 9630, 9630T	Condenser w/ Fuel and Oil Cooler	AMRE270117	\$ 1188.00	
 9300, 9400	Condenser	AMRE61924	\$ 905.00	
 9300T, 9400T	Condenser	AMRE162976	\$ 509.00	
7210R, 7230R, 7250R, 7270R, 7290R, 7310R	Condenser Bracket, Upper Front	AMRE560277	\$ 170.00	
	Condenser Pivot Bracket	AMRE560276	\$ 150.00	
	Fuel Cooler Mount	AMRE560280	\$ 145.00	
 Utility: 4520, 4720	Charge Air Cooler Core: 10" x 13.50" x 3"	AMLVA15119	\$ 485.00	
 (7200R, 7215R, 7230R BSN 080000)	Charge Air Cooler Core: 22 1/4" x 10" x 5 1/8"	AMRE287862	\$ 1335.00	
 (7210R, 7230R, 7250R, 7270R, 7290R, 7310R ASN 080001)	Charge Air Cooler	AMRE560271	\$ 1200.00	
 (7230R, 7260R, 7280R BSN 080000)	Charge Air Cooler	AMRE310076	\$ 1325.00	
 7630, 7720, 7730, 7820, 7830, 7920, 7930, 8110, 8130, 8210, 8230, 8310, 8330, 8410, 8430, 8530, 9230, 9330, 9430, 9430T, 9530, 9530T, 9630, 9630T	Evaporator Flange Mount, O-Ring Connection Overall: 18" x 4 3/8" x 10" Core: 13 1/2" x 3 3/4" x 10" Replaces RE187311, RE286345, RE292236	AMRE327083	\$ 320.00	
 7630, 7730, 7830, 7930	Charge Air Cooler Core: 21 1/4" x 11 5/8" x 4"	AMRE226367	\$ 1525.00	
(8235R, 8285R, 8310R, 8335R, 8360R SN 016001-090000), (8310RT, 8335RT, 8360RT SN 902501-912000)	Charge Air Cooler Core: 10" x 38 1/8" x 5"	AMRE297789	\$ 1318.00	
	Charge Air Cooler Core: 10 1/4" x 38 1/4" x 5"	AMRE330648	\$ 1625.00	
9230, 9330, 9430, 9430T	Charge Air Cooler Core: 18 3/4" x 35 1/2" x 3"	AMRE270140	\$ 2346.00	

Prices Subject to Change without Prior Notice. The use of original equipment manufacturer (OEM) part numbers or trademarks, e.g. Case® and John Deere®, are for reference purposes only and for indicating product use and compatibility. Our company and the listed replacement parts contained herein are not sponsored, approved or manufactured by the OEM. All parts are New unless designated Reman in the description.

John Deere®—Tractor

	Application	Description	Part Number	Retail Price	Core
	9530, 9530T, 9630, 9630T	Charge Air Cooler Core: 35.60" x 19.20" x 4"	AMRE231509	\$ 3500.00	
	4030, 4040, 4050, 4055, 4230, 4240, 4250, 4255, 4430, 4440, 4450, 4455, 4555, 4650, 4630, 4640, 4650, 4755, 4760, 4840, 4850, 4955, 4960, 7440, 7445, 7450, 7455, 8430, 8440, 8450, 8630, 8640, 8650, 8850	Evaporator Overall: 33 1/4" x 12 1/2" x 5" Core: 29" x 5" x 3 1/8" Replaces Evaporator on Early Models w/ Separate Heater Core Tractors w/ Separate Heater Core Must Remove Roof Panel Spacer For Clearance	AMAR88076	\$ 150.00	
	7210R, 7230R, 7250R, 7270R, 7290R, 7310R	Aftercooler Bracket, Lower	AMRE560283	\$ 120.00	
	7210R, 7230R, 7250R, 7270R, 7290R, 7310R	Aftercooler Bracket, Lower Front	AMRE587517	\$ 110.00	
	(1640, 2040, 2040S, 2140 ASN 430000), 2250, 2450, 2650, 2850, 3040, 3050, 3140, 3350, 3640	Evaporator Replaces AR90140	AMAL37526	\$ 215.00	
	2350, 2355, 2550, 2555, 2750, 2755, 28755N, 2940, 2950, 2955, 3055, 3150, 3155, 3255	Evaporator	AMRE13885	\$ 295.00	
	4030 BSN 076141, 4230 BSN 076059, 4430 BSN 076041, 4630 BSN 076110, 8430 BSN 075971, 8630 BSN 075998	Evaporator Overall: 31 1/2" x 4" x 9 3/4" Core: 29" x 3" x 4"	AMAR58152	\$ 260.00	
	(5220, 5320, 5420, 5520 ASN 420001), 5225, 5325, 5425, 5525, 5603, 5625, 6120, 6220, 6230, 6320, 6320L, 6330, 6420, 6420L, 6430, 6520L, 7130, 7230, 7330, 7420, 7430, 7520 MFWD Replaces AL160350	Evaporator Overall: 32 3/4" x 5 1/4" x 6" Core: 29" x 6" x 2 1/2"	AMAL163863	\$ 350.00	
	5320N, 5325N, 5400N, 5420N, 5425N, 5500N, 5510N, 5520N, 5525N, 6215, 6405, 6415, 6605, 6615, 6715, 7505 Replaces AL159602, AL110260	Evaporator Overall: 26 3/8" x 6 1/4" x 6" Core: 21 1/4" x 6" x 3 3/4"	AMAL163858	\$ 350.00	
	6110, 6210, 6310, 6310S, 6410, 6410S, 6510, 6510S, 7200 ASN 003823, (7210, 7410, 7510 BSN 055077), 7400 ASN 005044, 7600 ASN 008004, 7610, (7700, 7800 ASN 015008), 7710, 7810 Replaces RE66330, RE152404, RE241384	Evaporator Overall: 33 1/2" x 5 3/8" x 6 1/8" Core: 29" x 6 1/8" x 3 3/4"	AMRE180243	\$ 380.00	
	6120, 6200, 6200L, 6220, 6300, 6300L, 6320, 6320L, 6400, 6400L, 6420, 6420L, 6500, 6500L, 6520L, 7220, 7320, 7420, 7520 MFWD Replaces AL112100, AL119098, AL160349	Evaporator w/ Heater Core Overall: 33 1/2" x 5 1/2" x 6 1/8" Core: 28 3/4" x 6.00" x 3 7/8"	AMAL163862	\$ 265.00	
	7200 BSN 002429, 7400 BSN 002845, 7600 BSN 004774, 7700 BSN 007099, 7800 BSN 010246	Evaporator Overall: 33 1/2" x 6" x 6" Core: 29" x 3" x 6"	AMRE46768	\$ 265.00	
	8100, 8200, 8300, 8400, 9100, 9200, 9300, 9400	Blower Motor 12 Volt, Single Speed, 2-Wire, 5/16" Shaft, Flange Mount	AMRE67645	\$ 99.50	
	8100, 8100T, 8200, 8200T, 8300, 8300T, 8400, 8400T, (9100, 9200, 9300, 9400 BSN 030000), (9300T, 9400T BSN 900136)	Evaporator/Heat Exchanger w/ Heater Core Overall: 19 1/4" x 4 3/4" x 10 1/8" Core: 15.50" x 10" x 3.75"	AMRE57574	\$ 350.00	

John Deere®—Tractor

Application	Description	Part Number	Retail Price	Core
 1640, 2140, 2355, 2555, 2650, 2750 Late, 2755, 2850, 2955, 3040, 3140, 3150, 3155, 3255, 5200, 5210, 5220, 5300, 5310, 5320, 5400, 5410, 5500, 5510, 6110, 6120, 6200, 6210, 6215, 6220, 6300, 6310, 6400, 6410, 6500, 6510, 7200, 7210, 7220, 7320, 7400, 7410, 7420, 7520, 7600, 7610, 7700, 7710, 7800, 7810	Insulator Replaces 088273-00, BN98192, WR51207	AMR115928	\$ 15.00	

Shop Manuals and Collections

I&T Shop Service Manuals provide the information you need to service virtually any make or model of wheel-type farm tractor. Easy-to-follow procedures, detailed illustrations and comprehensive specifications help guide you through complete tractor maintenance and repair with accuracy and efficiency.



Application	Description	Part Number	Retail Price
Series: A, B, G, H, Models: D, M, MT	John Deere®	IT-JD-4	\$ 28.00
Models: 50, 60, 70	John Deere®	IT-JD-10	\$ 28.00
Series: 520, 530, 620, 630, 720, 730	John Deere®	IT-JD-16	\$ 28.00
Series: 1010, 2010	John Deere®	IT-JD-21	\$ 28.00
Series: 1020, 1520, 1530, 2020, 2030	John Deere®	IT-JD-37	\$ 28.00
Series: 850, 950, 1050	John Deere®	IT-JD-47	\$ 28.00
Series: 4030, 4230, 4430, 4630	John Deere®	IT-JD-50	\$ 28.00
Series: 4050, 4250, 4450, 4650, 4850	John Deere®	IT-JD-57	\$ 31.00
Models: 2150, 2155, 2255, 2350, 2355, 2355N, 2550, 2555	John Deere®	IT-JD-58	\$ 28.00
Models: 2750, 2755, 2855, 2955	John Deere®	IT-JD-59	\$ 28.00
Models: 4055, 4255, 4455, 4555, 4755, 4955	John Deere®	IT-JD-60	\$ 28.00
Models: (720, 730 Diesel), Series: 40, 320, 330, 420, 430, 440, Series: (80, 820, 830 - 2 Cylinder Diesel), Series: (820, 830 - 3 Cylinder Diesel), Series: (435D, 4401D - Diesel)	John Deere Collection®	IT-JD-201	\$ 31.00
Series: 2040, Series: 2510, 2520, Series: 2240, 2440, 2630, 2640, Series: 4040, 4240, 4440, 4640, 4840	John Deere Collection®	IT-JD-202	\$ 31.00
Series: 6030, 3020 ASN 123000, 4000, 4020 ASN 201000, 4320, 4520, 4620, 3010, 3020 BSN 123000, 4010, 4020 BSN 201000, 5010, 5020	John Deere Collection®	IT-JD-203	\$ 31.00



Tracks

Application	Description	Part Number	Retail Price	Core
8295RT, 8310RT, 8320RT, 8335RT, 8345RT, 8360RT, 8370RT	Rubber Track 635WX44LX204P, 25" Track Size 88 Tread Lugs, 8.03" Tread Lug Pitch, 2.76" Height 44 Guide Lugs, 8.03" Pitch, 4.52" Width, 4.25" Height	AMR545861	\$ 7830.00	
	Rubber Track 762WX44LX204P, 30" Track Size 88 Tread Lugs, 8.03" Tread Lug Pitch, 2.76" Height 44 Guide Lugs, 8.03" Pitch, 4.52" Width, 4.25" Height	AMR545863	\$ 8910.00	
8100T, 8110T, 8120T, 8200T, 8210T, 8220T, 8230T, 8300T, 8310T, 8320T, 8330T, 8420T, 8430T, 8520T	Rubber Track 635WX47LX175P, 25" Track Size 94 Tread Lugs, 6.89" Tread Lug Pitch, 2.60" Height 47 Guide Lugs, 6.90" Pitch, 3.35" Height, 5.91" Width	AMR241745	\$ 7019.00	
9300T, 9320T, 9400T, 9420T, 9520T, 9620T	Rubber Track 914WX42LX229P, 36" Track Size	AMR257978	\$ 11160.00	

John Deere®—Tractor

Application	Description	Part Number	Retail Price	Core
9430T, 9460RT, 9470RT, 9510RT, 9520RT, 9530T, 9560RT, 9570RT, 9630T	Rubber Track 914WX43LX229P, 36" Track Size Replaces R242792	AMR545870	\$ 12870.00	

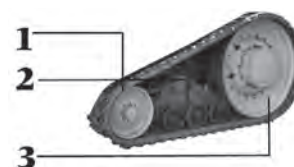

Track Parts

Application	Description	Part Number	Retail Price	Core
1 8100T, 8110T, 8120T, 8200T, 8210T, 8220T, 8230T, 8300T, 8310T, 8320T, 8330T, 8400T, 8410T, 8420T, 8430T, 8520T	Front Idler Wheel, Poly 27.50" Diameter, 5.25" Wide, 6.50" Pilot Hole Diameter	AMRE221427	\$ 1135.00	\$ 250.00
8100T, 8110T, 8120T, 8200T, 8210T, 8220T, 8230T, 8300T, 8310T, 8320T, 8330T, 8400T, 8410T, 8420T, 8430T, 8520T	Reman Front Idler Wheel, Poly 27.50" Diameter, 5.25" Wide, 6.50" Pilot Hole Diameter	AMRE221427-R	\$ 600.00	\$ 250.00
1 8295RT SN 900101-907100, (8310RT, 8335RT, 8360RT SN 902501-912000), (8320RT, 8345RT ASN 900101), 8370RT ASN 912001	Reman Front Idler Wheel, Poly 12-Bolt, 7.75" Wide	AMRE265435-R	\$ 650.00	\$ 250.00
9300T, 9320T, 9400T, 9420T, 9520T, 9620T	Reman Front Idler Wheel, Poly 8.75" Wide	AMRE173535-R	\$ 1500.00	\$ 250.00
2 8000 Series w/ 32" or 36" Wide Tracks, 9430T, 9460RT, 9470RT, 9510RT, 9520RT, 9530T, 9560RT, 9570RT, 9630T	Mid-Roller, Poly Stamped Steel, 8-Bolt, 14.50" Diameter, 9.25" Wide, 6" Pilot Hole Diameter Replaces RE322752	AMRE251071	\$ 910.00	\$ 75.00
8000 Series w/ 32" or 36" Wide Tracks, 9430T, 9460RT, 9470RT, 9510RT, 9520RT, 9530T, 9560RT, 9570RT, 9630T	Reman Mid-Roller, Poly Stamped Steel, 8-Bolt, 14.50" Diameter, 9.25" Wide, 6" Pilot Hole Diameter Replaces RE322752	AMRE251071-R	\$ 400.00	\$ 75.00
8100T, 8110T, 8120T, 8200T, 8210T, 8220T, 8300T, 8310T, 8320T, 8400T, 8410T, 8420T, 8520T	Mid-Roller, Poly 4-Bolt, 14.50" Diameter, 5" Wide, 3.625" Pilot Hole Diameter	AMRE165014	\$ 575.00	\$ 75.00
8100T, 8110T, 8120T, 8200T, 8210T, 8220T, 8300T, 8310T, 8320T, 8400T, 8410T, 8420T, 8520T	Reman Mid-Roller, Poly 4-Bolt, 14.50" Diameter, 5" Wide, 3.625" Pilot Hole Diameter	AMRE165014-R	\$ 300.00	\$ 75.00
8120T, 8220T, 8230T, 8320T, 8330T, 8420T, 8430T, 8520T	Mid-Roller, Poly 8-Bolt, 14.50" Diameter, 4.50" Wide, 6" Pilot Hole Diameter	AMRE254786	\$ 365.00	\$ 75.00
8120T, 8220T, 8230T, 8320T, 8330T, 8420T, 8430T, 8520T	Reman Mid-Roller, Poly 8-Bolt, 14.50" Diameter, 4.50" Wide, 6" Pilot Hole Diameter	AMRE254786-R	\$ 250.00	\$ 75.00
8120T, 8220T, 8320T, 8420T, 8520T	Mid-Roller, Poly 8-Bolt, 14.50" Diameter, 5" Wide, 6" Pilot Hole Diameter	AMRE212733	\$ 555.00	\$ 75.00
8120T, 8220T, 8320T, 8420T, 8520T	Reman Mid-Roller, Poly 8-Bolt, 14.50" Diameter, 5" Wide, 6" Pilot Hole Diameter	AMRE212733-R	\$ 300.00	\$ 75.00
8120T, 8220T, 8320T, 8420T, 8520T, 9300T, 9320T, 9400T, 9420T, 9520T, 9620T	Reman Mid-Roller, Poly 8-Bolt, 14.50" Diameter, 8" Wide, 6" Pilot Hole Diameter	AMRE254787-R	\$ 325.00	\$ 75.00
8120T, 8220T, 8320T, 8420T, 8520T, 9300T, 9320T, 9400T, 9420T, 9520T, 9620T	Reman Mid-Roller, Poly 14.60" Diameter, 8" Wide	AMRE200310-R	\$ 500.00	\$ 75.00
8295RT SN 900101-907100, (8310RT, 8335RT, 8360RT SN 902501-912000), (8320RT, 8345RT ASN 900101), 8370RT ASN 912001	Mid-Roller, Poly Stamped Steel, 8-Bolt, 17" Diameter, 5.50" Wide, 5.875" Pilot Hole Diameter Replaces RE576549	AMRE266293	\$ 635.00	\$ 75.00

John Deere®—Tractor

John Deere®—Tractor

Application	Description	Part Number	Retail Price	Core	
2	8295RT SN 900101-907100, (8310RT, 8335RT, 8360RT SN 902501-912000), (8320RT, 8345RT ASN 900101), 8370RT ASN 912001	Reman Mid-Roller, Poly Stamped Steel, 8-Bolt, 17" Diameter, 5.50" Wide, 5.875" Pilot Hole Diameter Replaces RE576549	AMRE266293-R	\$ 450.00	\$ 75.00
	8295RT SN 900101-907100, (8310RT, 8335RT, 8360RT SN 902501-912000), (8320RT, 8345RT ASN 900101), 8370RT ASN 912001, 9470RX, 9570RX, 9620RX	Reman Mid-Roller, Poly 8-Bolt, 17" Diameter, 9.25" Wide, 5.875" Pilot Hole Diameter	AMRE272331-R	\$ 440.00	\$ 75.00
3	8100T, 8110T, 8120T, 8200T, 8210T, 8220T, 8300T, 8310T, 8320T, 8400T, 8410T, 8420T, 8520T	Reman Rear Drive Wheel, Poly 18-Bolt, 61.125" Diameter, 5" Wide, 37" Pilot Hole Diameter	AMRE171404-R	\$ 3750.00	\$ 400.00
	8295RT SN 900101-907100, (8310RT, 8335RT, 8360RT SN 902501-912000), (8320RT, 8345RT ASN 900101), 8370RT ASN 912001	Reman Rear Drive Wheel, Poly Outer Right Hand or Inner Left Hand Steel, 18-Bolt, 58.50" Diameter, 9.25" Wide, 13.25" Pilot Hole Diameter	AMRE265437-R	\$ 2195.00	\$ 400.00
	8295RT SN 900101-907100, (8310RT, 8335RT, 8360RT SN 902501-912000), (8320RT, 8345RT ASN 900101), 8370RT ASN 912001	Reman Rear Drive Wheel, Poly Inner Right Hand or Outer Left Hand Steel, 18-Bolt, 58.50" Diameter, 9.25" Wide, 13.25" Pilot Hole Diameter	AMRE265436-R	\$ 2195.00	\$ 400.00
	9300T, 9320T, 9400T, 9420T, 9520T, 9620T	Reman Rear Drive Wheel, Poly 8-Bolt, 60.75" Diameter, 26.50" Wide, 25.125" Pilot Hole Diameter	AMRE160676-R	\$ 5725.00	\$ 400.00

Prices Subject to Change without Prior Notice. The use of original equipment manufacturer (OEM) part numbers or trademarks, e.g. Case® and John Deere®, are for reference purposes only and for indicating product use and compatibility. Our company and the listed replacement parts contained herein are not sponsored, approved or manufactured by the OEM. All parts are New unless designated Reman in the description.

John Deere®—Combine

Table of Contents

Air Conditioning and Components.....	1208
Alternators	1074
Auger Extension Kits	1147
Auger Tubes—Grain Bin Loading.....	1135
Augers & Components—Bare Header / Platform.....	1181
Augers & Components—Lower Clean Grain.....	1127
Augers & Components—Lower Return	1130
Augers & Components—Top Tailing Return	1132
Augers & Tubes—Horizontal Unloading.....	1142
Augers & Tubes—Vertical Unloading	1141
Augers—Bottom Bin Cross.....	1139
Augers—Distribution.....	1137
Augers—Grain Bin Loading.....	1133
Auger Supply Shafts.....	1138
Auger Tube Donuts.....	1148
Axle Drive Shafts and Couplers.....	1082
Beaters and Components.....	1125
Belts—3300, 4400	1235
Belts—4420	1237
Belts—4425, 4435, 4435 Hydro	1237
Belts—6600, 7700 – Left Hand View.....	1239
Belts—6600, 7700 – Right Hand View	1238
Belts—6620, 6622, 7720, 7721	1241
Belts—7722, 8820	1243
Belts—8000 Series Forage Harvesters.....	1258
Belts—9400, 9500, 9500SH, 9501, 9600	1244
Belts—9410, 9510, 9510SH, 9610	1246
Belts—9450, 9550, 9550SH, 9560, 9560SH, 9650, 9660	1247
Belts—9560, 9570, 9650, 9660, 9670, 9750, 9760, 9770, 9860, 9870 – STS.....	1249
Belts—9650CTS, 9660CTS, CTS, CTS II, CTS Rice.....	1251
Belts—Cotton Pickers & Swathers	1258
Belts—Platforms.....	1259
Belts—S550, S650, S660, S660HM, S670, S670HM, S680, S680HM, S690, S690HM.....	1253
Belts—S760, S770, S780, S785, S790	1255
Belts—T660, T670.....	1257
Brakes and Components	1079
Chaffer and Sieve Frames.....	1151
Chaffers—Adjustable Air Foil Top.....	1150
Chaffers—Long Finger Top	1149
Chaffers—Rigid Air Foil	1150
Chaffers—Short Finger Top	1148
Chaff Spreaders and Components	1177
Clean Grain Elevator Boot and Door	1124
Cleaning Fan Shafts and Components.....	1110
Concaves and Components	1105
Corn Doors and Wheat Doors	1177
Cornhead—Auger Liners.....	1219
Cornhead—Complete Polytin Kits.....	1215
Cornhead—Fenders and Snouts.....	1216
Cornhead—Hydraulic Deck Plate Kits.....	1220
Cornhead—Row Unit Components	1220
Auger Drive Components	1230
Curtain Componets	1227
Gearbox Components	121
Roller Chains and Components	1233
Row Unit Components	1222

Row Unit Gearboxes	1220
Cornhead—Stalk Stompers and Components	1219
Cutter Bar Components.....	1174
Cylinder Bars and Components.....	1101
Cylinder Drive Components.....	1109
Distribution Auger Pans and Components.....	1138
Distribution Auger Wood Block Bearing Set	1138
Draper Belts and Components	1188
Elevator Chains	1114
Elevator Chain Sprockets.....	1117
Elevator Gearbox.....	1119
Elevator Head Shafts.....	1120
Elevator Housings and Components.....	1116
Feederhouse Chains	1085
Feederhouse Chain Sprockets	1087
Feederhouse Components	1091
Feederhouse Drums and Shafts.....	1088
Feederhouse Floor Sheets	1090
Feed Reverser Assemblies and Components	1098
Final Drives and Components	1079
Fuel Tanks and Components	1207
Gas Struts.....	1206
Glass	1207
Grain Pans and Components	1154
Grain Tank Auger Floor Liners.....	1148
Grain Tank Extensions.....	250
Guards and Cutter Bar Parts	1175
Header End Shields.....	1191
Header Lift Cylinders.....	1188
Hoods	1192
Hydraulic Components	1085
Hydraulic Oil Coolers.....	1084
Hydraulic Pumps	1084
Hydrostatic Drive Components.....	1077
Hydrostat Output Shafts	1078
Hydrostat Transmissions and Components.....	1076
Knife Mount Channels and Parts.....	1167
Lighting.....	1193
Longblock Assemblies.....	1071
Platform Adapter Kits.....	1178
Platform Components.....	1185
Platform Floor Sheets.....	1186
Poly Skid Plate Kits and Components	1191
Power Steering Cylinders and Components.....	1204
Primary Countershafts and Components	1107
Radiator Hoses and Thermostats.....	1073
Radiators and Components.....	1071
Rear Deflector (Isolator)	1177
Rear Hood, Lower Panels	1178
Rear Hoods and Components.....	1178
Rear Wheel Drive and Components.....	1204
Reel Components.....	1184
Reel Conversion Kits	1183
Reel Drive Components	1183
Rotor Assemblies.....	1102

Table of Contents Continued on Next Page

John Deere®—Combine

Table of Contents - Continued

Rotor Components	1102	Straw Chopper Rotor Assemblies.....	1162
Row Crop Dividers.....	1187	Straw Choppers.....	1156
Row Crop Head Components.....	1179	Straw Spreader Components	1177
Secondary Countershafts and Components.....	1109	Straw Walkers and Components	1154
Sensors	1075	Styling Panels.....	1206
Separator Gearbox Components.....	1114	Tie Rods and Components.....	1203
Sickle Assemblies With Heads	1173	Tip-Up Assemblies.....	251
Sickle Drives and Components	1180	Transmission Input Shafts	1078
Sickle Knife Heads	1172	Transmissions	1078
Sieves—Lower	1151	Unloading Auger Countershafts and Components	1129
Spindles.....	1205	Unloading Auger Housings and Components.....	1121
Steering Wheels and Cap.....	1207	Unloading Auger Swing Cylinders	1127
Step Components.....	1206	Upper Sprocket Tubes.....	1088
Straw Chopper Blades and Components	1160	Wheel Hubs and Components.....	1206
Straw Chopper Drive Kits and Components.....	1157	Wide Spread Deflector Assemblies and Components.....	1168
Straw Chopper Floors.....	1166		
Straw Chopper Parts and Components.....	1162		

Longblock Assemblies

Application	Description	Part Number	Retail Price	Core
9400 BSN 337245 w/ 359T 6 Cylinder Diesel Engine	Reman Longblock Assembly	LBJD359TE9400	\$ 8100.00	\$ 1500.00
9400 ASN 337246 w/ 359T 6 Cylinder Diesel Engine	Reman Longblock Assembly	LBJD359TL9400	\$ 8100.00	\$ 1500.00
9500, 9600	Reman Longblock Assembly 190 Horsepower	LBJD60769600W85	\$ 9150.00	\$ 1500.00
	Reman Longblock Assembly 235 Horsepower	LBJD60769600W95	\$ 9150.00	\$ 1500.00
9550	Reman Longblock Assembly	LBJD8.1PT9550	\$ 10900.00	\$ 1500.00
9660	Reman Longblock Assembly	LBJD8.1PT9660	\$ 10900.00	\$ 1500.00
9770	Reman Longblock Assembly	LBJD6090E9770	\$ 12250.00	\$ 6000.00
	Reman Longblock Assembly	LBJD6090L9770	\$ 12250.00	\$ 6000.00
9870STS	Reman Engine, Complete 13.5 Liter	CRJD6135T9870H	\$ 35000.00	\$ 7500.00
Forage Harvester: 7300	Reman Engine, Complete 12.5 Liter, 6125, HH003	CRJD6125T9860L	\$ 32500.00	\$ 7500.00
Sprayers: 4630, 4700, 4710, 4720, 4730, 4830, R4023	Engine Mount Isolator	AMRE60720	\$ 27.94	



Radiators and Components

Application	Description	Part Number	Retail Price	Core
6600 w/ 6404 Engine, 6602 Hillside, 6620, 6622	Radiator Core: 27 3/4" x 32 5/8" 5 Rows, 5 Fins per Inch Replaces AH19911, AH87990, AH112173	AMAH124726	\$ 980.00	
7700 w/ Factory Rotary Screen, 7720, 8820	Radiator Overall: 31 3/4" x 40 1/2" Core: 27 1/2" x 33" x 3 3/8" 5 Rows, 6 Fins per Inch	AMAH124728	\$ 953.50	
9400 BSN 640100, 9500 BSN 640200, 9600 BSN 640330 w/o 235HP Engine	Radiator Overall: 42" x 21 3/16"	AMAH137544	\$ 1115.00	

John Deere®—Combine

John Deere®—Combine

Application	Description	Part Number	Retail Price	Core
9400 SN 640100-655316, 9500 SN 640200-656269, 9510, 9550, 9600 ASN 640301, 9650 BSN 695300, 9650CTS BSN 695400, CTS BSN 655419, Cotton Pickers: 9976, 9986	Radiator Overall: 41 3/4" x 26" 5 Rows, 5 Standard Fins per Inch Replaces AH133223, AH138940, AH169362	AMAH128257	\$ 1051.00	
9500 ASN 640201, 9510, 9550, 9600 ASN 640301, 9610, 9650 BSN 695300, 9650CTS BSN 695400, CTS, CTS II	Radiator Overall: 42" x 26 1/4" 6 Rows, 4 Wide Fins per Inch Replaces AH144719	AMAH169363	\$ 1195.00	
9550 ASN 700200, 9550SH ASN 700700, 9560, 9560SH, 9560STS, 9650 ASN 695300, 9650CTS ASN 695400, 9660, 9660CTS	Radiator Overall: 27 5/16" x 41 1/4" x 4" 4 Rows	AMAH168350	\$ 1095.00	
9650STS BSN 695600, 9750STS BSN 695500	Radiator Replaces AH145366	AMAH169364	\$ 1450.00	
9940, 9950, 9960 Engine SN 000101-004000	Radiator Overall: 27" x 37 3/8" 5 Rows Replaces AN191241	AMAN190887	\$ 1150.00	
Cotton Pickers: 9960 ASN 004001, 9965, 9970	Radiator Core: 25 7/8" x 29 1/2" x 3 1/4"	AMAN195300	\$ 1245.00	
Sprayer: 4720	Radiator Core: 16" x 25.50" x 3.30" Replaces RE181893	AMRE245236	\$ 1112.00	
Sprayers: 4730, 4830	Radiator Overall: 26" x 33" Core: 26" x 25 3/8" x 3 1/4" 4 Rows, 10 Fins per Inch	AMRE226366	\$ 980.00	
Sprayer: 4920	Radiator Core: 16" x 32 1/8" x 3.30"	AMRE245227	\$ 1140.00	
Sprayer: 4930	Radiator Core: 27 7/8" x 35.00" x 4 1/8" 5 Rows, 10 Fins per Inch Replaces RE242251	AMRE242256	\$ 1630.00	
Sprayer: 4940 w/ Tier 2 Engine	Radiator Overall: 21 1/2" x 46 3/8" Core: 21 1/4" x 38" x 5 1/4" 4 Rows, 10 Fins per Inch	AMRE297780	\$ 1200.00	
Sprayer: 4940 w/ Tier 4 Engine	Radiator Overall: 21 5/8" x 46 1/2" Core: 21 1/2" x 38" x 5 3/16" 5 Rows, 10 Fins per Inch	AMRE330645	\$ 1545.00	
Sprayers: R4030, R4038, R4045	Radiator	AMAN402264	\$ 1845.00	
Swathers: 4890, 4895	Radiator Overall: 22 1/4" x 33 7/8" Core: 22" x 28 1/8" x 3 1/2" 5 Rows, 8 Fins per Inch	AMRE63188	\$ 750.00	
Swathers: A400, D450, R450	Radiator Core: 33 5/8" x 23 3/8" x 5.20"	AMAFH202211	\$ 2175.00	
9400, 9410, 9500, 9500SH, 9510, 9510SH, 9610 ASN 681688, CTS, CTS II	Countershaft, Rotary Screen Drive 20.50" Long	AMH134528	\$ 79.09	
9450, 9550 BSN 700201, 9550SH BSN 700701, 9650 BSN 695301, 9650CTS BSN 695401	Drive Shaft, Rotary Screen 22.22" Long	AMH168256	\$ 98.40	
9560STS ASN 720101, 9570STS, 9650STS, 9660STS, 9670STS, 9750STS, 9760STS, 9770STS, S550 SN 745100-764999, S650 ASN 765000, (S660, S670 ASN 745100), S670HM BSN 765000	Drive Shaft, Rotary Screen 29.75" Long	AMH151146	\$ 99.50	
9550 ASN 700200, 9550SH ASN 700700, 9560, 9560SH, 9860STS, 9870STS, S680, S680HM, S690, S690HM, S780, S785, S790	Drive Shaft, Rotary Screen 52.81" Long	AMH175557	\$ 173.10	

John Deere®—Combine

John Deere®—Combine

Application	Description	Part Number	Retail Price	Core
9610	Drive Shaft, Engine Fan 12.63" Long	AMAH151439	\$ 130.62	
Combines: 9600, 9610 BSN 681688, Cotton Picker: 9976 BSN 004000	Countershaft, Rotary Screen Drive 23.62" Long	AMH123653	\$ 139.41	
9450 ASN 690111, 9550 ASN 690240, 9550SH ASN 690701, 9560, 9560SH, 9560STS, 9570STS, 9650 ASN 690338, 9650CTS ASN 690401, 9650STS ASN 690609, 9660, 9660CTS, 9660STS, 9670STS, 9750STS ASN 690662, 9760STS, 9770STS, 9860STS, 9870STS, Forage Harvester: 7250	Idler, Rotary Screen Upper Idler	AMAH169549	\$ 19.00	
8820, 9400, 9410, 9450, (9500, 9500SH ASN 642858), 9600, 9610, 9650, CTS	Idler Pulley, Flanged 2.187" Wide, 5.50" OD, 0.50" Hole Diameter	AMAH96292	\$ 61.75	
9400 ASN 645101, 9450, 9500 ASN 645201, 9510, 9510SH, 9550, 9550SH, 9560, 9560SH, 9570STS, 9600, 9610, 9650, 9650CTS, 9650STS, 9660, 9660CTS, 9660STS, 9670STS, 9750STS, 9760STS, 9770STS, 9860STS, 9870STS, CTS, CTS II, S550, S650, S660, S670, S670HM, S680, S680HM, S690, S690HM, Cotton Picker: 9976	Idler Pulley, Rotary Screen 3.252" OD, 1.102" Overall Width, 0.39" Bore, 0.961" Groove Width Replaces AB4828R, AH140497, RE29879	IPABFI-54-008	\$ 17.00	
3300 ASN 100000, 4400 ASN 101300, 4420, 6600 ASN 011501, 6620, 7700, 7720, 8820	Bearing Flange, Rotary Screen Drive Shaft	AME10018	\$ 2.40	
3300, 4400 Engine ASN 101300, 4420, 6600, 6620, 7720, 8820	Bearing, Rotary Screen Driveshaft 2.4409" OD, 1.125" Bore Diameter	AMJD9246	\$ 20.81	
9400 ASN 640100, 9410, 9450, (9500, 9510 ASN 640200), (9500SH, 9510SH ASN 645200), 9550, 9550SH, 9560, 9560SH, 9560STS, 9570STS, 9600 ASN 640300, 9610, 9650, 9650CTS, 9650STS, 9660, 9660CTS, 9660STS, 9670STS, 9750STS, 9760STS, 9770STS, 9860STS, 9870STS, S550, S650, S660, S670, S670HM, S680, S680HM, S690, S690HM, S770, S780, S785, S790, CTS, CTS II, Cotton Pickers: 7760, 9976, 9986, 9996, CP690, Cotton Stripper: CS690, Forage Harvesters: 6610, 6650, 6710, 6750, 6810, 6850, 6910, 6950, 7180, 7200, 7250, 7280, 7300, 7350, 7380, 7400, 7450, 7480, 7500, 7550, 7580, 7700, 7750, 7780, 7800, 7850, 7950, 7980, 8100, 8200, 8300, 8400, 8500, 8600, 8700, 8800, 9600, 9700, 9800, 9900	Outer Bearing, Rotary Screen Tapered Roller Bearing 1.456" Wide, 2.677" OD, 1.535" Bore	AMAH109788	\$ 51.02	

Radiator Hoses and Thermostats



Application	Description	Part Number	Retail Price	Core
4400	Radiator Hose, Upper 2" & 2.50" ID	AMR43582	\$ 17.22	
Cotton Pickers: 9950 ASN 4000, 9960 SN 0101-4000	Radiator Hose, Upper	AMR88353	\$ 12.45	
Forage Harvesters: (6810, 6910 BSN 502248)	Radiator Hose, Upper 2.25" & 2.50" ID	AMR57388	\$ 10.95	
Sprayers: 4700, 4710	Radiator Hose, Upper 2" & 2.375" ID	AMR130571	\$ 32.15	
Sprayer: 4720	Radiator Hose, Upper 2.50" ID	AMR164844	\$ 30.55	
Sprayers: 4700, 4710	Radiator Hose, Lower 2" ID	AMR128002	\$ 20.64	
3300, 9560STS, 9570STS, 9860STS, Forage Harvesters: 6610, 6710, 6810, 6910, 7300, 7400, 7500, Sprayers: 4700, 4710, 4730, 6000, 6100, 6500, 6600, Swathers: 2360, 2420, 3430, 3830	Thermostat, 180° Replaces AT22961	AMRE33705	\$ 5.96	
4400, 4420, 6600, Cotton Picker: 9900, Cotton Stripper: 484	Thermostat, 195° Replaces AR70601	AMAR77411	\$ 72.32	

John Deere®—Combine

Application	Description	Part Number	Retail Price	Core
6600, 6620, 7700, 7720, 8820, 9400, 9500, 9500SH, 9600, CTS Engine ASN 499999, Cotton Pickers: 9910, 9920, 9930, 9940, 9950, 9960, 9965, 9970, 9976, Cotton Strippers: 7440, 7450, Forage Harvesters: 5200, 5400, 5440, 5460, 5720, 5730, 5820, 5830, 6610, 6650, 6710, 6810, 6910, 7200, 7300, 7400, 7500, Sprayers: 4700, 4920	Thermostat, 180° Replaces RE524562	AMAR48675	\$ 4.61	
9560, 9660STS, 9670STS, 9760STS, 9770STS, 9780CTS, S560, S650, S660, S670, S670HM, S760, S770, T560, T660, T670, Cotton Picker: 7660, Forage Harvesters: 7180, 7250, 8100, 8200, Sprayers: 4930, R4038, R4045, R4060	Thermostat, 180° 2.125" OD Replaces RE540550	AMDZ100553	\$ 16.56	
9560STS, 9570STS, S540, S550, T550, Cotton Picker: 9970, Sprayers: 4730, 4830	Thermostat Replaces RE538806	AMRE538289	\$ 15.50	
S650, S660, S670, S670HM, S680, S680HM, S690, S690HM, S760, S770, S780, S785, S790, T550, T560, T660, T670, Cotton Pickers: CP690, 7760, Cotton Stripper: CS690, Forage Harvesters: 7280, 7380, 7480, 7580, 7780, 8100, 8200, 8300, 8400, 8500, 8600, 9600, Sprayers: R4023, R4030, R4044, R4045, R4060	Thermostat Replaces RE540379	AMRE554015	\$ 19.62	



Alternators

Application	Description	Part Number	Retail Price	Core
9400 ASN 635306, 9410, 9450, 9500, 9510, 9550, 9550SH, 9560, 9600, 9610, 9650, 9650CTS, 9660, 9660CTS, 9750STS, 9780CTS, 9860STS, CTS, CTS II Replaces A187623, AH137883, AT220394, RE36267, RE505895, SE501342, TY6750	Alternator w/o Pulley Bosch, 12 Volt, 95 Amps, IR/EF, CW Rotation	AMA187623	\$ 105.00	
9400 ASN 650101, 9410, 9450, (9500, 9500SH ASN 637628), 9510, 9510SH, 9550, 9550SH, 9560, 9560SH, 9560STS, 9600 ASN 636604, 9610, 9650, 9650CTS, 9650STS, 9660, (9660CTS, 9760STS BSN 715400), 9660STS, 9750STS, 9860STS BSN 715633, CTS, CTS II, Cotton Pickers: (7445, 9930 ASN 12001), 7450, 9960, 9965, Sprayers: 6100, 6500, 6600, Swathers: 3430, 3830	Alternator Bosch, 12 Volt, 95 Amps Replaces ABO0209, AL-6236	AMTY24485	\$ 141.00	
9450, 9550, 9550SH, 9560, 9560SH, 9560CTS, 9560STS BSN 715300, 9650, 9650CTS, 9650STS, 9660, 9660CTS, (9660STS, 9760STS BSN 715400), 9750STS, 9860STS BSN 715633, Cotton Stripper: 7460	Alternator, Delco 28SI Series, 12 Volt, 185 Amps, CW Rotation Replaces 8600307, 8600311	AMAH211398	\$ 325.00	
9560STS ASN 715301, 9570STS, (9660STS, 9760STS ASN 715401), 9670STS, 9770STS, 9860STS ASN 715634, 9870STS, S550, S650, S660, S670, S670HM, S680, S680HM, S690, S690HM, S760, S770, S780, S790	Alternator w/o Pulley 200 Amp Replaces AH212040, AH229090	AMAXE17691	\$ 245.00	
Forage Harvesters: 7950, 7980, 8100, 8200, 8400, 8500, 8600	Alternator, 14 Volt 200 Amps Note: Special Order Item	AMAL170947	\$ 300.00	
Cotton Pickers: 9935, 9970, 9976, 9986, Cotton Stripper: 7445, Sprayer: 6700, Swathers: 4890, 4895, 4990, 4995, A400 w/ 4045HE050 Engine	Alternator 12 Volt, 120 Amps Replaces AT185951, RE533654, SE502628	AMAH165975	\$ 236.00	
Sprayer: 4720	Alternator Denso Type, 12 Volt, 150 Amps, IR/IF Replaces RE186320, SE501837, Nippondenso 104210-3920, 104210-3921	AMRE257541	\$ 438.00	

John Deere®—Combine

Application	Description	Part Number	Retail Price	Core
Sprayers: 4730, 4830, 4940	Alternator w/ Pulley Bosch, 12 Volt, 200 Amps, IR/IF, Uses B+ and D+ post Can be used to replace AH229090, but may require change of pulley Replaces RE555751	AMRE210793	\$ 275.00	
9560STS, 9650STS, 9660STS, 9750STS, 9760STS, Cotton Stripper: 7460, Sprayer: 6700 ASN 773433, Swather: 4895	Belt Tensioner, Alternator 200 PSI Spring Pressure Replaces RE70535, RE70536, RE548027	AMRE518097	\$ 101.00	

Sensors

Application	Description	Part Number	Retail Price	Core
9410, 9450, 9500, 9500SH, 9510, 9510SH, 9550, 9550SH, 9560STS, 9570STS, 9600, 9610, 9640, 9650, 9650CTS, 9650STS, 9660, 9660CTS, 9660STS, 9750STS, 9760STS, 9780CTS, 9860STS, 9870STS, C670, CTS, CTS II, S550, S660, S670, S670HM, S680, S680HM, S690, S690HM, T550, T560, T660, T670, Cotton Pickers: 7660, 7760, 9935, 9965, 9970, 9976, 9986, Cotton Strippers: 7455, 7460, Forage Harvesters: 7180, 7250, 7280, 7350, 7380, 7450, 7480, 7550, 7580, 7750, 7780, 8100, 8200, 8300, 8400, 8500, 8600, Sprayers: 4630, 4700, 4710, 4720, 4730, 4830, 4920, 4930, 4940, 6700	Engine Speed Sensor	AMRE519144	\$ 20.00	
9410, 9450, 9510, 9510SH, 9550, 9550SH, 9560, 9560SH, 9570STS, 9610, 9650, 9650CTS, 9650STS, 9660CTS, 9660STS, 9670STS, 9770STS, 9780CTS, 9860STS, 9870STS, 9880STS, S550, S560	Sensor, Concave Indicator Replaces RE56165	AMAT333680	\$ 77.00	
9450, 9550, 9550SH, 9560, 9560SH, 9560STS, 9570STS, 9650, 9650STS, 9660, 9660CTS, 9660STS, 9670STS, 9750STS, 9760STS, 9770STS, 9780CTS, 9860STS, 9870STS	Circuit Board Moisture Sensor, 155 GreenStar™, Yield Mapping	AMAH209883	\$ 270.00	
9450, 9550, 9550SH, 9560, 9560SH, 9560STS, 9570STS, 9650CTS, 9650STS, 9660, 9660CTS, 9660STS, 9670STS, 9750STS, 9760STS, 9770STS, 9780CTS, 9860STS, 9870STS, Cotton Pickers: 7660, 7760, Cotton Stripper: CS690, Forage Harvesters: 7180, 7200, 7250, 7280, 7300, 7400, 7450, 7480, 7500, 7550, 7580, 7700, 7750, 7780, 7800, 7950, 7980	Neutral Start Switch	AMAH161154	\$ 31.00	
9550, 9550SH, 9650CTS, Cotton Pickers: 7660, 9970, 9986, 9996, Cotton Strippers: 7450, 7455, Sprayers: 4930, 4940	Potentiometer Sensor	AMRE261354	\$ 100.00	
9560STS, 9570STS, 9660STS, 9670STS, 9760STS, 9770STS, 9870STS, S540, S550, S560, S660, S670, S690, S690HM, S780, S790, T550, T560, T660, T670, Cotton Pickers: 7660, 7760, 9970, Sprayers: 4630, 4730, 4830, 4930, R4023, Forage Harvesters: 7350, 7380, 7450, 7480, 7550, 7580, 7750, 7780, 8100, 8200, 8300, 8400, 8500, 8600	Air Temperature Sensor Replaces 72102514	AMRE525016	\$ 19.25	
9560STS, 9660STS, 9670STS, 9760STS, 9770STS, 9780CTS, S550, S650, S660, S670, S670HM, S760, S770, Cotton Picker: 9970, Forage Harvester: 8100, Sprayer: 4940	Air Temperature Sensor	AMRE522823	\$ 45.00	
9570STS, 9670STS, 9770STS, 9870STS, S550, S650, S660, S670, S680, S680HM, S690, S690HM, S760, S770, S790, Platforms: 625D, 630D, 635D, 635FD, 640D, 640FD, 645FD, 725D, 730D, 735FD, 740D, 740FD, 745FD	Speed Sensor	AMAH228007	\$ 220.00	
9660STS, 9670, 9760STS, 9770, 9780CTS, S650, S660, S670, S670HM, T560, T660, T670, Cotton Picker: 7660, Forage Harvesters: 3520, 7180, 7250, 8100, 8200, Sprayer: 4930	Fuel Filter Moisture Sensor Replaces RE532949	AMRE503590	\$ 60.00	
S550, S650, S660, S670, S670HM, S680, S680HM, S690, S690HM, S785, T550, T560, T660, T670, Forage Harvesters: 8100, 8200, 8300, 8400, 8500, 8600, 8700, 8800, 9600, 9700, 9800, 9900, Sprayers: R4030, R4038, R4045	Wiring Harness, Propulsion Control	AMAL203916	\$ 80.00	
S760, S770, S780, S790	Solenoid Valve For Engine Compressor Solenoid	AMAH229996	\$ 293.00	

John Deere®—Combine

Application	Description	Part Number	Retail Price	Core
S760, S770, Forage Harvesters: 8100, 8200, 8300, 8400, 8500, 8600, 8700, 8800	Pressure Switch Replaces AXE35537	AMAXE72960	\$ 165.00	
Cotton Pickers: 7660, 7760, 9986, CP690, Cotton Strippers: 7460, CS690, Sprayers: 4630, 4720, 4730, 4830, 4930, 4940, R4023	Rotational Position Sensor	AMAN372268	\$ 104.00	
Cotton Pickers: 7760, CP690	Proximity Switch	AMAN372459	\$ 65.00	
Cotton Pickers: 7660, 7760	Sensor	AMAN373340	\$ 83.00	
Cotton Pickers: 7660, 7760, CP690, Cotton Stripper: CS690	Wheel Speed Sensor Replaces RE204888, RE558874	AMRE295929	\$ 85.00	
Sprayers: 4920, 4940	Flowmeter Sensor Replaces AKK23982	AMAN305054	\$ 135.00	
Sprayers: 4720, 4730, 4830	Wheel Speed Sensor	AMAN208025	\$ 375.00	
Sprayers: 4730, 4830	Cylinder Position Sensor Replaces AN302232, AN306617	AMAKK16814	\$ 140.00	
Platforms: (600F, 600R ASN 740101), 615F, 615R, 618F, 618R, 622F, 622R, 625D, 625R, 625F, 630D, 630FD, 630R, 635D, 635F, 635FD, 640D, 640FD, 645FD, 730FD, 735FD, 740FD, 745FD	Reel Resume and Fore/Aft Right Hand Sensor Replaces AXE57249	AMAXE17036	\$ 70.00	

Hydrostat Transmissions and Components

Our hydrostats are remanufactured by a remanufacturing facility recognized by Sauer/Sundstrand. All units are assembled by a factory-trained technician, using genuine new and remanufactured replacement parts. All units are fully tested to factory specifications for maximum performance.



Application	Description	Part Number	Retail Price	Core
6600, 7700	Reman Hydrostat, Sundstrand Replaces AH75517, PG203919	H7700S	\$ 1750.00	\$ 500.00
6620, 7720	Reman Hydrostat, Eaton Replaces AH112682	H7720E	\$ 3350.00	\$ 500.00
6620, 7720	Reman Hydrostat, Sundstrand Replaces AH98889, AH107887, AH119038	H7720S	\$ 3350.00	\$ 500.00
8820	Reman Hydrostat, Eaton Replaces AH130931	H8820E	\$ 3350.00	\$ 500.00
8820	Reman Hydrostat, Sundstrand Replaces AH96664, AH107888, AH119037	H8820S	\$ 3350.00	\$ 500.00
9400, 9500, 9600 w/ Ring and Pinion Final Drive, CTS, CTS II	Reman Hydrostat, Eaton, 2-Piece Replaces Pump AH131305, AH160785, Motor AH128575, AH131310	H9500E-46/46	\$ 5450.00	\$ 750.00
9560STS, 9570STS, 9650, 9650CTS, 9650STS, 9660, 9660CTS, 9660STS, 9670CTS, 9670STS, 9750STS, 9760STS, 9780CTS, 9860STS, 9880STS	Reman Hydrostat, Eaton 6493-036 Hydro Pump, 6433-081 Hydro Motor Replaces AH204424, AXE10219, PG200760	H9760STSE-64/64	\$ 4950.00	\$ 1000.00
9600 w/ Planetary Final Drive, CTS, CTS II	Reman Hydrostat, Eaton, 2-Piece Replaces Pump AH131385, AH204383, Motor AH131390, AH204424	H9600E-64/64	\$ 5450.00	\$ 750.00
9770STS, S660, S670	Reman Hydrostat, Eaton 3-Speed, Confirm Eaton Numbers on Pump and Motor Before Ordering	H9770E-64/64	\$ 4950.00	\$ 1000.00
9770STS, S660, S670	Reman Hydrostat, Eaton Pro Drive, Confirm Eaton Numbers on Pump and Motor Before Ordering	H9770EL-64/64	\$ 4950.00	\$ 1000.00
Cotton Pickers: 9900, 9910, 482, 484	Reman Hydrostat, Sundstrand	H9900S-22/22	\$ 3600.00	\$ 500.00
Cotton Pickers: 9910, 9920, 9960, 484, 7440, 7445	Reman Hydrostat, Eaton	H9900E-39/39	\$ 3800.00	\$ 500.00
Cotton Picker: 9930	Reman Hydrostat, Sundstrand	H9930S2-22/22	\$ 3600.00	\$ 500.00
Cotton Picker: 9976	Reman Hydrostat, Sundstrand, 2-Piece	H9976S-96/51	\$ 8750.00	\$ 500.00

John Deere®—Combine

John Deere®—Combine

Application	Description	Part Number	Retail Price	Core
9770STS, 9870STS	Hydrostat Motor 140 cc Replaces AH235084	AMAXE23886	\$ 10490.85	
S660, S670	Hydrostat Motor Replaces AH232682	AMAXE23885	\$ 8844.50	
S680, S680HM, S690, S690HM, (S780, S790 - w/o Drive by Noise Regulation), Cotton Stripper: CP690, Forage Harvesters: 8400, 8500, 8600	Hydrostat Motor 170 cc	AMAXE24902	\$ 8219.40	
Cotton Pickers: 7660, 7760	Hydrostat Motor	AMAN372934	\$ 7917.30	
9770STS, S670 BSN 766253	Hydrostat Pump Replaces AH234462, AXE17831, AXE21873, PG201016	AMAXE17831	\$ 6995.80	
9870STS	Hydrostat Pump Replaces AH233210, AH234461, AXE19716, AXE21874	AMAXE29041	\$ 8066.45	
S660 SN 765172-785000, S670 SN 765253-785000	Hydrostat Pump	AMAXE30234	\$ 6960.65	
(S660, S670 ASN 785000), S760 Excluding SN 1JOS760XXXX, S770 Excluding SN 1JOS770XXXX	Hydrostat Pump	AMAXE62024	\$ 7220.00	
S680 ASN 766006, S690 ASN 765249, S780, S785, S790	Hydrostat Pump	AMAXE30235	\$ 8066.45	
S680 BSN 766007, S680HM, S690 BSN 766250, S690HM	Hydrostat Pump Replaces AXE11598	AMAXE27489	\$ 8066.45	
Cotton Pickers: 7760, CP690, Cotton Stripper: CS690	Hydrostat Pump 180 cc Replaces AN278774, AN375055	AMAN406360	\$ 12640.70	
Forage Harvesters: 7200, 7250, 7280, 7300, 7350, 7380, 7400, 7450, 7480, 7500, 7550, 7580, 7700, 7750, 7780, 7800, 7850, 7950, 7980	Hydraulic Axial Piston Pump Replaces AZ102340	AMAXE23634	\$ 8066.45	

Hydrostatic Drive Components

Application	Description	Part Number	Retail Price	Core
6600, 6602, 6620, 6622, 7700, 7720, 8820	Hydrostatic Drive Oil Cooler	AMAH98812	\$ 835.00	
6600, 7700, Forage Harvesters: 5200, 5400, (5440, 5460 ASN 425000)	Hydro Drive Coupler 19 Spline, 2.50" Long, 1.25" Diameter Replaces H93940	AMH99060	\$ 73.04	
6620, 7720 w/ Eaton Hydrostat ASN 556300 or w/ Sundstrand Hydrostat BSN 556301 & ASN 610500, 8820, Forage Harvesters: 5720, 5730, 5820, 5830	Hydro Drive Coupler 23 Spline, 2.75" Long, 1.519" Diameter Replaces H93940	AMH98238	\$ 75.96	
9400, 9410, 9450 BSN 690100, 9500, 9510, 9510SH, 9550 BSN 690200, 9550SH BSN 690700, 9600, 9610, 9650 BSN 690300, 9650CTS BSN 690400, CTS, CTS II BSN 675952, Forage Harvesters: 6610, 6650, 6710, 6750, 6810, 6850, 6910, 6950	Hydrostatic Pump Shaft 23/23 Spline, 11.23" Long	AMAH133660	\$ 218.05	
Cotton Pickers: 9960, 9965	Driveshaft For Hydrostat Pump Drive	AMAN193853	\$ 490.00	
Cotton Pickers: 9970	Driveshaft For Hydrostat Pump Drive	AMAN274998	\$ 500.00	
Cotton Pickers: 9970, 9976 BSN 4000	Driveshaft For Hydrostat Pump Drive	AMAN273458	\$ 545.00	
Cotton Pickers: (9976, 9986 ASN 4001), 9996	Driveshaft For Hydrostat Pump Drive	AMAN275411	\$ 1185.00	

Prices Subject to Change without Prior Notice. The use of original equipment manufacturer (OEM) part numbers or trademarks, e.g. Case® and John Deere®, are for reference purposes only and for indicating product use and compatibility. Our company and the listed replacement parts contained herein are not sponsored, approved or manufactured by the OEM. All parts are New unless designated Reman in the description.

John Deere®—Combine



Hydrostat Output Shafts

Application	Description	Part Number	Retail Price	Core
6600, 7700, Forage Harvesters: (5200, 5400, 5440, 5460 BSN 425000)	Hydro Output Shaft 19/26 Spline, 11.66" Long, 1.48" Diameter For Sundstrand Units,	AMH81605	\$ 291.09	
6620, 7720, 8820, Forage Harvesters: (5200, 5400, 5440, 5460 ASN 425001), 5720, 5730, 5820, 5830	Hydro Output Shaft 26/23 Spline, 12" Long, 1.48" Diameter For 200 Series Sundstrand Units	AMH98071	\$ 466.49	
6600, 6602 BSN 353600, 7700, Forage Harvesters: 5200, 5400, 5440, 5460	Hydrostat Output Shaft, Motor Stub Drive 19 Tooth, 3.06" Long	AMH76111	\$ 75.09	
9560STS, 9570STS, 9650CTS, 9650STS, 9660, 9660CTS, 9660STS, 9670STS, 9750STS, 9760STS, 9770STS, 9780CTS ASN 072800, 9860STS, 9870STS, C670, S550 SN 745100-764999, S650 ASN 765000, (S660, S670 ASN 745100), S760, S770, T550, T560, T660, T670, Forage Harvesters: 6650, 6750, 6850, 6950, 7180, 7200, 7250, 7300, 7400, 7450, 7480, 7500, 7550, 7580, 7700, 7750, 7780, 7800, 7850, (8100, 8200, 8300, 8400, 8500, 8600, 8700, 8800 SN 513822-517999)	Hydrostat Output Shaft 26/23 Spline, 12.39" Long	AMAZ56818	\$ 375.00	

Transmission Input Shafts

Application	Description	Part Number	Retail Price	Core
6620, 7720, 8820 w/ Hydrostatic Drive	Transmission Input Shaft	AMAH109692	\$ 210.00	
9400, 9410, 9450, 9500, 9510, 9550, 9560, 9560STS, 9570STS, 9600, 9650, 9650CTS, 9650STS, 9660, 9660CTS, 9670STS, 9750STS, 9760STS, 9770STS, 9860STS, 9870STS, CTS, CTS II, S550, S660, S670, S680, Cotton Stripper: 7460, Forage Harvesters: 6610, 6650, 6710, 6750, 6810, 6850, 6910, 6950, 7180, 7200, 7250, 7280, 7300, 7350, 7380, 7400, 7450, 7480, 7500, 7550, 7580, 7700, 7750, 7780, 7800, 7850	Transmission Coupler	AMH129525	\$ 56.50	

Transmissions

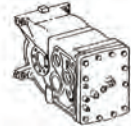

Application	Description	Part Number	Retail Price	Core
6620, 7720	Reman Transmission Units w/ Positorque or Gear Drive	AMT200PT	\$ 1750.00	\$ 400.00
	Reman Transmission Units w/ Hydrostat Drives	AMT200H	\$ 1750.00	\$ 400.00
8820	Reman Transmission Units w/ Hydrostat Drives	AMT8820	\$ 1750.00	\$ 500.00
9400, 9500, 9600	Reman Transmission Units w/ Bull Gear Final Drives Replaces AH168735	AMT9600B	\$ 3000.00	\$ 1500.00
9600, 9610	Reman Transmission Units w/ Planetary Final Drives Replaces AH156881	AMT9600P	\$ 3000.00	\$ 1500.00
9550, 9560, 9560STS, 9570STS, 9650 BSN 700300	Reman Transmission	AMAH203856	\$ 3000.00	\$ 2500.00
9650 ASN 700301, 9650STS ASN 700501, 9660, 9660CTS, 9660STS, 9670STS, 9750STS ASN 700601, 9760STS, 9770STS, 9860STS, 9870STS	Reman Transmission Cast # - AH219499	AMAH202673	\$ 7500.00	\$ 2500.00
9770STS	Reman Transmission Replaces DE20163	AMPG200954	\$ 9500.00	\$ 2500.00
9870STS	Reman Transmission Replaces DE19592	AMPG200876	\$ 9500.00	\$ 2500.00

John Deere®—Combine



Brakes and Components

Application	Description	Part Number	Retail Price	Core
6600 ASN 105890, 6620, 7700 ASN 111900, 7720, 8820, Forage Harvesters: 5200, 5400, 5440, 5460, 5720, 5730, 5820, 5830	Transmission Brake Shaft 12.964" Long	AMH85871	\$ 197.52	
6600 ASN 105891, 6620, 7700 ASN 111901, 7720, 8820, Forage Harvesters: (5200, 5400 ASN 160000), 5440, 5460, 5720, 5730, 5820, 5830	Brake Drum Cast Iron	AMH85887	\$ 285.00	
9400, 9410, 9450, 9500, 9510, 9510SH, 9550, 9550SH, 9560, 9560SH, 9560STS, 9570STS, 9600, 9610, 9650, 9650CTS, CTS, CTS II, Cotton Pickers: 7450, (7455, 9970, 9976 BSN 4000), 9935, 9965, Forage Harvesters: (6610, 6710, 6810, 6910 BSN 502211)	Brake Shoe Set Set of 4	AMAH132840	\$ 225.23	
9400, 9410, 9450, 9500, 9500SH, 9510, 9510SH, 9550, 9550SH, 9560, 9560SH, 9560STS, 9570STS, 9600, 9610, 9650, 9650CTS, 9650STS, 9660, 9660CTS, 9660STS, 9670STS, 9750STS, 9760STS, 9770STS, 9860STS, 9870STS, Cotton Pickers: 9935, 9960, 9965, 9970, 9976, 9986, Cotton Strippers: 7450, 7455, 7460, Forage Harvesters: 7180, 7200, 7250, 7280, 7300, 7350, 7380, 7400, 7450, 7480, 7500, 7550, 7580, 7700, 7750, 7780, 7800, Sprayers: 6100, 6500, 6600, 6700	Brake Fluid Reservoir Replaces AH130605, AH208639, AH212578	AMAH215111	\$ 26.12	
Cotton Pickers: 9940, 9950	Brake Plate 16 Tooth, 13.25" OD Use w/ R49427 Brake Shaft	AMR33816	\$ 69.00	
Cotton Pickers: 9940, 9950	Brake Pad 2.50" x 6.50" (6) Pads Required per Side, (12) Total for Tractor Pads Do Not Include Mounting Rivets Replaces R26969, R90085	AMAR28487	\$ 15.00	
Cotton Pickers: 9940, 9950	Brake Pad Rivets 0.135" x 0.203" Includes 36 Rivets (6) Required per pad	AMD1761	\$ 8.44	

Final Drives and Components



Application	Description	Part Number	Retail Price	Core
4400, 4420	Reman Final Drive Standard Duty, 6" Pilot Hole	FD4420	\$ 1150.00	\$ 350.00
	Reman Final Drive, HD 8 5/8" Pilot Hole Replaces AH104872	FD4420HD	\$ 1350.00	\$ 350.00
6600	Reman Final Drive Ratio - 13:89, Small Pinion, Pinion# H75164 Replaces AH86921	FD13-89SP	\$ 1350.00	\$ 350.00
	Reman Final Drive Ratio - 13:89, Big Pinion, Pinion# H85879 Replaces AH106894	FD13-89BP	\$ 1350.00	\$ 100.00

John Deere®—Combine

Application	Description	Part Number	Retail Price	Core
6600, 6620, 7700, 7720	Reman Final Drive 10:82 Ratio, Pinion # - H114203 Replaces AH112972	FD10-82	\$ 1350.00	\$ 350.00
	Reman Final Drive 11:90 Ratio, Big Pinion, Pinion # - H85817	FD11-90BP	\$ 1350.00	\$ 100.00
	Reman Final Drive 10:95 Ratio, Pinion # - H114203	FD10-95	\$ 1500.00	\$ 350.00
	Reman Final Drive 11:104 Ratio, Big Pinion, Pinion # - H85817	FD11-104BP	\$ 1500.00	\$ 350.00
6600, 7700	Reman Final Drive Ratio - 11:90, Small Pinion, Pinion# H75166	FD11-90SP	\$ 1350.00	\$ 350.00
	Reman Final Drive Ratio - 11:104, Small Pinion, Pinion# H75166	FD11-104SP	\$ 1350.00	\$ 350.00
7720, 8820	Reman Final Drive Planetary Type Replaces AH107609	FD8820PT	\$ 2000.00	\$ 350.00
9400, 9410, 9450, 9500, 9510, 9550, 9600, 9610, 9650, 9650CTS, CTS, CTS II	Reman Final Drive Bull Gear Type Replaces AH204987	Right Hand FD9600R	\$ 3500.00	\$ 1000.00
	Reman Final Drive Bull Gear Type Replaces AH204986	Left Hand FD9600L	\$ 3500.00	\$ 1000.00
9600, 9610	Reman Final Drive Planetary Type Replaces AH122742	Right Hand FD9600PTR	\$ 3750.00	\$ 1000.00
	Reman Final Drive Planetary Type Replaces AH122743	Left Hand FD9600PTL	\$ 3750.00	\$ 1000.00
9650, 9650CTS, 9650STS, 9660, 9660CTS, 9660STS, 9670STS, 9750STS, 9760STS, 9770STS, 9860STS, 9870STS	Reman Final Drive Heavy Duty Replaces AH205894, DE31747	Right Hand FD9650R	\$ 3750.00	\$ 2000.00
	Reman Final Drive Heavy Duty Replaces AH205893, DE31746	Left Hand FD9650L	\$ 3750.00	\$ 2000.00
S660, S670	Reman Final Drive 18 Spline Pinion	Right Hand AMAXE10563	\$ 4950.00	\$ 2000.00
		Left Hand AMAXE10562	\$ 4950.00	\$ 2000.00
S670, S680, S690, Cotton Pickers: 7660, 7760, CP690, Cotton Stripper: CS690	Reman Final Drive Extra Heavy Duty 22 Spline Pinion Replaces AN373648	Right Hand AMDE31282	\$ 4950.00	\$ 2000.00
	Reman Final Drive Extra Heavy Duty 22 Spline Pinion Replaces AN373649	Left Hand AMDE31283	\$ 4950.00	\$ 2000.00
6600, (6620, 7720, 8820 - w/ 32" Tires), 7700	Outer Final Drive Housing 11:104 Ratio Replaces H75060, H85150	AMH94882	\$ 510.48	
9400, 9410, 9450, 9500, 9510, 9510SH, 9550, 9550SH, 9560STS, 9600, 9610, 9650, 9650CTS, 9660, 9660CTS, 9660STS, 9760STS, CTS, CTS II, Cotton Pickers: 9970, 9976	Inner Final Drive Housing	Right Hand AMN276474	\$ 905.00	
		Left Hand AMN276475	\$ 905.00	

John Deere®—Combine

John Deere®—Combine

Application	Description	Part Number	Retail Price	Core
9400, 9410, 9450, 9500, 9510, 9550, 9560, 9600, 9610, 9650, 9660, 9560STS, 9650CTS, 9660CTS, CTS, CTS II, Forage Harvesters: 7200, 7300, 7400, 7500, 7700, 7800	Outer Final Drive Housing	AMH133092	\$ 650.00	
9410, 9450, 9550, 9550SH, 9560, 9560SH, 9560STS, 9610, 9650, 9650CTS, 9660, 9660STS, 9670STS, 9750STS, 9760STS, 9770STS, 9780CTS, 9860STS, 9870STS, 9880STS, CTS, CTS II, S550, S660, S670, S770, S780, S785, S790, Cotton Picker: 9970	Inner Final Drive Housing	Right Hand AMH225885	\$ 1595.00	
		Left Hand AMH225886	\$ 1595.00	
9550, 9550SH, 9560STS, 9570STS, 9610, 9650, 9650CTS, 9650STS, 9660, 9660CTS, 9660STS, 9670STS, 9750STS, 9760STS, 9770STS, 9780CTS, ASN 072800, 9860STS, 9870STS, C670, CTS II, S550 SN 745100-764999, S650 ASN 765000, (S660, S670, S680, S690 ASN 745100), (S670HM, S680HM BSN 765000), S690HM SN 745101-765000, S760, S770, S780, S785, S790, T550, T560, T660, T670, Cotton Pickers: 7660, 7760, 9970, 9986, 9996, CP690, Cotton Stripper: CS690, Forage Harvesters: 7180, 7200, 7250, 7280, 7300, 7350, 7380, 7400, 7450, 7480, 7500, 7550, 7580, 7700, 7750, 7780, 7800, 7850, 7950, 7980, (8100, 8200, 8300, 8400, 8500, 8600 SN 513822-620999), (8700, 8800 SN 513822-517999), (9600, 9700, 9800, 9900 SN 619000-620999)	Outer Final Drive Housing	AMH163694	\$ 675.00	
S650 ASN 765000, S660 ASN 765172, (S670, S680, S690 ASN 745100), S760, S770, S780, S785, S790, T550, T560, T660, T670, Cotton Pickers: 7660, 7760, 9996, CP690, Cotton Stripper: CS690	Inner Final Drive Housing	Right Hand AMN377018	\$ 825.00	
		Left Hand AMN377019	\$ 775.00	
9500 SideHill, 9550 SideHill, 9560 SideHill	Driveshaft	AMAH137816	\$ 840.00	
9400 ASN 640505, 9410, 9450, 9500 ASN 642630, 9510, 9550, 9560, 9560STS, 9650STS, 9660STS, 9670STS, 9750STS, 9760STS, 9770STS, 9860STS, 9870STS, S550 SN 745100-764999, S660 SN 745100-765171, S670 SN 745100-765252, T550, T560, T660, T670	Final Drive Shaft	Right Hand AMH165665	\$ 225.00	
		Left Hand AMH165666	\$ 250.00	
9450, 9550, 9550SH, 9600, 9610, 9650, 9660	Final Drive Shaft	AMH165509	\$ 263.00	
6600, 6620 BSN 553000	Pinion Shaft 11 Tooth, 23 Spline, 6.91" Long Replaces H87638	AMH93884	\$ 329.42	
6600, 6620, 7700, 7720	Pinion Shaft 11 Tooth, 8.32" Long For use in 11:104 and 11:90 Big Pinion Final Drives	AMH85817	\$ 140.00	
	Pinion Shaft 10 Tooth, 8.32" Long For use in 10:82 and 10:95 Final Drives	AMH114203	\$ 150.00	
7720, 8820, 9600, 9610	Pinion Shaft 27 & 23 Spline, 8.02" Long	AMH93674	\$ 185.71	
9400, 9410, 9500, 9510, 9600, 9610, CTS II, Cotton Pickers: 9965, 9970, 9976	Pinion Shaft	AMH157014	\$ 195.00	
(9450, 9550, 9650, 9650CTS, 9660, 9660CTS - w/ Heavy Duty Final Drive), 9560, 9560STS, 9650STS, 9660STS, 9750STS, 9760STS, 9860STS, Cotton Pickers: 9970, 9976, 9986, Forage Harvesters: (7180, 7280, 7380, 7480, 7580, 7780, 7950, 7980 - w/ Heavy Duty Final Drive), 7200, 7250, 7300, 7350, 7400, 7450, 7500, 7550, 7700, 7750, 7800, 7850	Pinion Shaft 10 Tooth, 18 Spline, 8.84" Long	AMH167722	\$ 220.00	

Prices Subject to Change without Prior Notice. The use of original equipment manufacturer (OEM) part numbers or trademarks, e.g. Case® and John Deere®, are for reference purposes only and for indicating product use and compatibility. Our company and the listed replacement parts contained herein are not sponsored, approved or manufactured by the OEM. All parts are New unless designated Reman in the description.

John Deere®—Combine

John Deere®—Combine

Application	Description	Part Number	Retail Price	Core
Cotton Picker: 7760, Cotton Stripper: CS690 BSN 065000, Forage Harvesters: (8100, 8300, 8400, 8500, 8600, 9800, 9900 BSN 620000), 8200, 8700, 8800	Pinion Shaft 10 Tooth	AMN377016	\$ 195.00	
Cotton Pickers: 9900, 9910, 9920, Cotton Strippers: 7440, 7445 BSN 4001	Pinion Shaft 14 Tooth, 21 Splines, 7.50" Long	AMP48573	\$ 308.97	
9450, 9550, 9550SH, 9560SH, 9560STS, 9650, 9650CTS, 9660, 9660CTS, 9970 ASN 6001, 9976 ASN 6001, 9986	Pinion, 10 Tooth	AMH168899	\$ 295.00	
9400, 9410, 9450, 9500, 9510, 9550, 9560, 9600, 9610, 9650, 9660, 9560STS, 9650CTS, 9660CTS, CTS, CTS II, Forage Harvesters: 7200, 7300, 7400, 7500, 7700, 7800	Axle Spindle Regular Duty Spindle Nut - Slotted	AMH201792 AMH129854	\$ 735.00 \$ 35.00	
9560STS, 9570STS, 9660, 9660STS, 9750STS, 9860STS, CTS II	Axle Spindle 10 Bolt Holes 17.52" Long, 4.328" Diameter, 3.739" Shoulder Diameter	AMH201791	\$ 755.00	
(S650, S760 BSN 805001 - w/ Heavy Duty Final Drive), S660 ASN 765171, (S670, S770 BSN 805001 - w/ Heavy Duty or Extra Heavy Duty Final Drive), (S680, S690, (S780, S790 BSN 805001) - w/ Extra Heavy Duty Final Drive), Cotton Pickers: 7660, 7760, CP690, Cotton Stripper: CS690	Axle Spindle	AMN380923	\$ 975.00	
9400, 9410, 9450, 9500, 9510, 9550, 9550SH, 9560, 9560SH, 9600, 9610, 9640, 9650CTS, 9650STS, 9660, 9660CTS, 9680, 9660STS, 9750STS, 9760STS, 9860STS, S660, S670, S680, S690, Forage Harvesters: 6650, 6750, 6850, 6950, 7200, 7300, 7400, 7500, 7700, 7800, Cotton Pickers: 9970, 9976, 9986, 9996	Gear, 95 Tooth	AMH167723	\$ 1600.00	
9410, (9450, 9550, 9650CTS - Heavy Duty), 9560, 9570STS, 9610, 9650, 9650STS, 9660, 9660CTS, 9660STS, 9670STS, 9750STS, 9760STS, 9770STS, 9860STS, 9870STS, S550, S660 SN 745100-765171, S670 SN 745100-765252, Cotton Pickers: 9970, 9976, 9986, 9996, Forage Harvesters: 7180, 7200, 7250, 7280, 7300, 7350, 7380, 7400, 7450, 7480, 7500, 7550, 7580, 7700, 7750, 7780, 7800, 7850, 7950, 7980	Cap	AMH161540	\$ 25.00	

Axle Drive Shafts and Couplers



Application	Description	Part Number	Retail Price	Core
4400 ASN 151501 w/ Heavy Duty Final Drive, 4420	Axle Drive Shaft 21 Splines, 14.688" Long	AMH87165	\$ 135.02	
4400 ASN 151501 w/ Heavy Duty Final Drive, 4420	Axle Drive Shaft 21 Splines, 22.682" Long Use w/ Axle Spacers	AMH87275	\$ 93.95	
(6600 ASN 105891, 6620 w/ Hydro Transmissions)	Axle Drive Shaft 23 Splines, 9" Long	Right Hand AMH123619	\$ 114.00	
6600 ASN 105891 w/ Belt Drive Transmission Right or Left Hand, 6620 w/ Posi-Torq™ Transmission Right or Left Hand, 7700 ASN 111901 w/ Posi-Torq™ Transmission Left Hand Only, 7720 w/ Posi-Torq™ Transmission Left Hand Only	Axle Drive Shaft 23 Splines, 14.938" Long	AMH123613	\$ 119.91	
(6600, 6620, 7700, 7720 - w/ 16" Axle Extensions)	Axle Drive Shaft 23 Splines, 15.75" Long Replaces H95197	AMH123630	\$ 75.00	

John Deere®—Combine

Application	Description	Part Number	Retail Price	Core
(6600 ASN 105981, 6620, 7700 ASN 111901, 7720 - w/ Hydro Transmissions)	Axle Drive Shaft 23 Spline, 20.813" Long Replaces H85875, H104542	Left Hand AMH123612	\$ 99.00	
(6600, 6620, 7700, 7720 - w/ 8" Axle Extensions)	Axle Drive Shaft 23 Spline, 7.75" Long	AMH123629	\$ 106.55	
(7700 ASN 111901, 7720 - w/ Hydro Transmissions)	Axle Drive Shaft 23 Splines, 19.875" Long Replaces H85877, H104544	Right Hand AMH123614	\$ 90.00	
7700 ASN 602386 w/ Belt Drive, 7720 w/ Posi-Torq™ Drive	Axle Drive Shaft 23 Spline, 25.813" Long Replaces H85874, H104541	Right Hand AMH123611	\$ 81.00	
8820	Axle Drive Shaft 23 Spline, 30.688" Long	Right Hand AMH123624	\$ 81.00	
9400, 9410, 9450, 9500, 9510, 9550, 9560, 9560STS, 9570STS, 9600, 9610, 9650, 9650CTS, 9650STS, 9660, 9660CTS, 9660STS, 9670STS, 9750STS, 9760STS, 9770STS, 9860STS, 9870STS, CTS, CTS II, S550, (S650, S660, S670 BSN 785001), Cotton Pickers: 9970, 9976, 9986	Axle Drive Shaft 18 Tooth, 15.748" Long, 1.575" ID, 1.772" OD Replaces H133246	AMH165663	\$ 236.45	
9400, 9410, 9450, 9500, 9510, 9550, 9560, 9560STS, 9570STS, 9650STS, 9660STS, 9670STS, 9750STS, 9760STS, 9770STS, 9860STS, 9870STS, S550, S660 BSN 765171, S670 BSN 765252, Cotton Pickers: 9976, 9986	Axle Drive Shaft 18 Spline, 17.874" Long, 1.331" ID, 1.772" OD Replaces H133248	AMH165664	\$ 189.89	
9400, 9410, 9450, 9500, 9510, 9560, 9560SH, 9560STS, 9570STS, 9600, 9610, 9650, 9650CTS, 9650STS, 9660STS, 9670STS, 9750STS, 9760STS, 9770STS, 9860STS, CTS, CTS II, S550, S660 BSN 765172, S670 BSN 765253, Cotton Pickers: 9970, 9976, 9986	Axle Drive Shaft 18 Tooth, 11.811" Long, 1.575" ID, 1.772" OD Replaces H133244	AMH165662	\$ 215.49	
9450, 9550, 9560STS, 9570STS, 9650, 9650CTS, 9650STS, 9660CTS, 9660STS, 9670STS, 9750STS, 9760STS, 9770STS, 9860STS, 9870STS, S550, S660 BSN 765000, S670 BSN 765253	Axle Drive Shaft 18 Spline, 3.75" Long	AMH176465	\$ 55.81	
4400 ASN 103931, 4420, 6600 BSN 105891, 7700 BSN 111901	Axle Drive Shaft Coupler 21 Spline, 4" Long Replaces P48679	AMH91808	\$ 65.73	
6600, 6620, 7700, 7720, 7722, 8820, Forage Harvesters: 5440, 5460, 5720, 5820	Axle Drive Shaft Coupler 23 Spline, 4" Long Replaces H106340	AMH106283	\$ 30.00	
9400, 9410, 9450, 9500, 9510, 9550, 9560STS, 9570STS, 9600, 9610, 9650, 9650CTS, 9650STS, 9660, 9660CTS, 9660STS, 9670STS, 9750STS, 9760STS, 9770STS, 9780CTS, 9860STS, 9870STS, CTS, CTS II, S550, S660, S670, S680, S690, S760, S770, S780, S790, Forage Harvesters: 6650, 6750, 6850, 6950, 7180, 7200, 7250, 7280, 7300, 7350, 7380, 7400, 7450, 7480, 7500, 7550, 7580, 7700, 7750, 7780, 7800, 7850, 7950, 7980	Axle Drive Shaft Coupler 18 Spline 4.016" Long, 2.156" OD, Replaces H133230, HXE30611	AMH165510	\$ 29.00	
9400, 9410, 9450, 9500, 9510, 9550, 9550SH, 9560STS, 9600, 9610, 9650, 9650CTS, 9650STS, 9660, 9660CTS, 9660STS, 9670STS, 9750STS, 9760STS, 9770STS, 9860STS, 9870STS, CTS, CTS II, S550 SN 745100-764999, S650 ASN 765000, (S660, S670, S680 ASN 745100), S690 ASN 765250, Forage Harvesters: 6610, 6650, 6710, 6750, 6810, 6850, 6910, 6950, 7180, 7200, 7250, 7280, 7300, 7350, 7380, 7400, 7450, 7480, 7500, 7550, 7580, 7700, 7750, 7780, 7800, 7850, 7950, 7980	Axle Drive Coupler Pin 2.047" Long, 0.394" OD	AMH131754	\$ 3.15	

Prices Subject to Change without Prior Notice. The use of original equipment manufacturer (OEM) part numbers or trademarks, e.g. Case® and John Deere®, are for reference purposes only and for indicating product use and compatibility. Our company and the listed replacement parts contained herein are not sponsored, approved or manufactured by the OEM. All parts are New unless designated Reman in the description.

John Deere®—Combine

Hydraulic Oil Coolers

Application	Description	Part Number	Retail Price	Core
9400 ASN 655100, 9410, 9450, (9500, 9500SH ASN 655200), 9510, (9550, 9550SH BSN 700201), 9600 ASN 650301, 9610, 9650 BSN 695301, CTS, CTS II	Hydraulic Oil Cooler Large Hose Fittings at Bottom Core: 26 3/8" x 1" x 2.50" Replaces AH145232	AMAH149588	\$ 655.00	
9400 BSN 6655100, 9500 BSN 556200, 9600, CTS BSN 665400	Hydraulic Oil Cooler Large Hose Fittings at Top Core: 21" x 26.50" x 2 7/8" Replaces AH120854	AMAH140472	\$ 1095.00	
9500, 9500SH, 9510, 9510SH, 9550, 9550SH, 9560, 9560SH, 9560STS, 9570STS, 9600, 9610, 9650, 9650CTS, 9650STS, 9660, 9660CTS, 9660STS, 9670STS, 9750STS, 9760STS, 9770STS, 9860STS, 9870STS, CTS II, S550, S650, S660, S670, S680, S690, S670 HillMaster, S680 HillMaster, S690 HillMaster, S760, S770, S780, S790	Hydraulic Oil Cooler	AMAH150687	\$ 250.00	
9550 ASN 700701, 9560STS, 9570STS, 9650 ASN 695301, 9650CTS ASN 695401, 9650STS ASN 695501, 9660, 9660CTS, 9660STS, 9670STS, 9760STS, 9770STS, 9780CTS ASN 072800, 9860STS, C670, S550 SN 745100-764999, (S660, S670 ASN 745100), T550, T560, T660, T670	Hydraulic Oil Cooler	AMAH168468	\$ 800.00	
Cotton Picker: 9996	Hydraulic Oil Cooler Core: 24" x 26.50" x 2.60"	AMAN278767	\$ 1500.00	
Forage Harvesters: (6750, 6850, 6950 BSN 504392, 6810, 6910 - w/ Hydraulic Oil Cooler), (6750, 6850, 6950 BSN 504392, 6810, 6910 - w/ Hydrostat Oil Cooler)	Hydraulic Oil Cooler Core: 38" x 24" x 3"	AMAZ45114	\$ 3900.00	
Sprayer: 4630	Hydraulic Oil Cooler	AMAT349069	\$ 292.00	
Sprayer: 4720	Hydraulic Oil Cooler Core: 12.75" x 21.50" x 3"	AMRE566108	\$ 1510.00	
Sprayer: 4940	Hydraulic Oil Cooler w/ Fuel Cooler Replaces AN403706	AMAKK12180	\$ 1645.00	
Sprayers: R4030, R4038, R4045	Hydraulic Oil Cooler	AMAN402266	\$ 1225.00	
Swathers: W235, W260	Hydraulic Oil Cooler	AMAFH212196	\$ 1558.00	
9400, 9500, 9500SH, 9600, CTS	Condenser w/ Dual Oil Cooler Core: 22 1/2" x 33" x 5 1/8"	AMAH150219	\$ 915.00	
9550 ASN 700201, 9560, 9560SH, 9560STS, 9570STS, 9650 ASN 695301, 9660, 9660CTS	Condenser w/ Oil Cooler	AMAH168467	\$ 1075.00	
9960, 9965, 9970	Condenser w/ Oil Cooler	AMAN194102	\$ 1585.00	
Cotton Pickers: 9940, 9950	Condenser w/ Oil Cooler Replaces AR75968	AMAR78958	\$ 1642.00	
Swather: A400	Condenser w/ Oil Cooler	AMAFH202216	\$ 2207.00	
Swathers: W235, W260	Condenser w/ Oil Cooler	AMAFH210943	\$ 1015.00	

Hydraulic Pumps

Application	Description	Part Number	Retail Price	Core
Cotton Pickers: 7760, CP690, Cotton Stripper: CS690	Hydraulic Pump, Baler Drive 85 cc	AMAN278775	\$ 5229.75	
Cotton Pickers: 9920, 9930, 9940, 9950, Cotton Strippers: 7440, 7445	Hydraulic Pump Keyed Input Shaft - 8 Pistons	AMAR103033	\$ 475.00	
Cotton Pickers: 9950, 9960, 9965, 9970 BSN 16000	Hydraulic Pump Drive Coupler Replaces T58195	AML34569	\$ 14.50	
Cotton Pickers: 9950, 9960, 9965, 9970	Hydraulic Pump Drive Cushion	AMR78202	\$ 7.50	

John Deere®—Combine

Hydraulic Components

Application	Description	Part Number	Retail Price	Core
Cutting Platforms: (615F, 615R, 618F, 618R, 620F, 620R, 622F, 622R, 625F, 625R, 630F, 630R, 635F, 635R - w/ Hydraulic Fore and Aft), (913F, 913R, 915F, 915R, 916F, 916R, 918F, 918R, 922F, 922R, 924F, 924R, 925F, 925R, 930F, 930R ASN 685400 w/ Multi-Coupler Conversion for 60 Series Combines and Hydraulic Fore and Aft), Draper Platforms: (625D, 630D, 630FD, 635D, 635FD, 640FD, 725D, 730D, 730FD, 735D, 735FD, 740D, 740FD, 745FD, 925D, 930D, 936D - w/ Hydraulic Fore and Aft), Cornheads: 493, 494, 594, 692, 693, 694	Hydraulic Coupler Block Plate w/ Couplers Replaces AH201340, AH208706, HXE117551	AMX27551	\$ 745.00	
493, 494, 594, 693, 606, 606C, 608, 608C, 612, 612C, 616, 616C, 618, 618C, 694, 894, 1092, 1290, 1293	Seal Kit, Hydraulic Quick Coupler	AMAH225672	\$ 22.00	
Platforms: 615F, 615R, 618F, 618R, 620F, 622F, 622R, 622X, 625F, 625R, 625X, 630F, 630R, 630X, 635F, 635R, 635X, 640X	Seal Kit, Hydraulic Quick Coupler	AMAH225673	\$ 27.00	

Feederhouse Chains

Our feederhouse chains for John Deere® combines use high-quality materials to meet exact specifications. Our t-slats are mounted in the middle of the links. Slats are mounted using 3/8" grade 5 plated bolts and locknuts for easy replacement. Chains feature full side plates and high-strength steel for added durability. Call for different slat and chain configurations available to fit your application.



Application	Description	Part Number	Retail Price	Core
4400, 4420	Feederhouse Chain 87 Links - T Slat, Wide Spaced Slats every 2nd and 4th link 3 Chain Assembly	AMAH116711	\$ 475.00	
	T-Slat For 16" Chain Centers	AMH85894	\$ 15.00	
6600, 6620, 6620 Titan II	Feederhouse Chain 87 links - T Slat, Closed Spaced Slats every 2nd link 3 Chain Assembly	AMAH123450	\$ 595.00	
	Feederhouse Chain 87 links - T Slat, Wide Spaced Slats every 2nd and 4th link 3 Chain Assembly	AMAH116713	\$ 420.00	
	Feederhouse Chain 104 links - T Slat, Wide Spaced Slats every 2nd and 4th link 3 Chain Assembly	AMAH116714	\$ 797.36	
	T-Slat For 19" Chain Centers	AMH85895	\$ 15.00	

John Deere®—Combine

John Deere®—Combine

Application	Description	Part Number	Retail Price	Core
7700, 7701, 7720, 7720 Titan II, 7721	Feederhouse Chain 87 links - T Slat, Closed Spaced Slats every 2nd link 3 Chain Assembly	AMAH123451	\$ 645.00	
	Feederhouse Chain 87 links - T Slat, Wide Spaced Slats every 2nd and 4th link 3 Chain Assembly	AMAH116716	\$ 440.00	
	Feederhouse Chain 102 links - T Slat, Closed Spaced Slats every 2nd link 3 Chain Assembly	AMAH123536	\$ 436.01	
	Feederhouse Chain 102 links - T Slat, Wide Spaced Slats every 2nd and 4th link 3 Chain Assembly	AMAH116717	\$ 723.38	
	T-Slat For 24 3/8" Chain Centers	AMH84497	\$ 18.00	
8820, 8820 Titan II	Feederhouse Chain 86 links - T Slat, Closed Spaced Slats every 2nd link 4 Chain Assembly	AMAH123452	\$ 1013.65	
	Feederhouse Chain 86 links - T Slat, Wide Spaced Slats every 2nd and 4th link 4 Chain Assembly	AMAH116718	\$ 595.00	
	Feederhouse Chain 128 links - T Slat, Wide Spaced Slats every 2nd and 4th link 4 Chain Assembly	AMAH116719	\$ 1118.74	
	T-Slat For 19 15/16" Chain Centers	AMH93558	\$ 19.00	
9400, 9500, 9450, 9550, 9410, 9510, CTS, CTS II	Feederhouse Chain 101 links - T Slat, Closed Spaced, chrome pins Slats every 2nd link 3 Chain Assembly	AMAH137845	\$ 750.00	
	T-Slat For 23 3/4" Chain Centers	AMH206436	\$ 18.00	
9400, 9500, 9450, 9550, 9410, 9510, 9560, CTS, CTS II	Feederhouse Chain 101 links - T Slat, Wide Spaced, chrome pins Slats every 2nd & 4th link 3 Chain Assembly, 557 Chain HD Replacement for AH207777	AMAH217634	\$ 775.00	
	Feederhouse Chain 101 links - T Slat, Wide Spaced, chrome pins Slats every 2nd and 4th link 3 Chain Assembly Replaces AH207777	AMAH138187	\$ 680.00	
	T-Slat For 23 3/4" Chain Centers	AMH206436	\$ 18.00	
9500SH, 9510SH, 9550SH, 9560SH	Feederhouse Chain 83 links - T Slat, 23 3/4" Center Spacing	AMAH137604	\$ 774.84	
9560STS, 9570STS, S550	Feederhouse Chain 89 links - T Slat, chrome pins Slats every 2nd and 4th link 3 Chain Assembly - CA557 Chain, 18 3/8" Center-to-Center Replaces AH231006	AMAH219918	\$ 735.00	
	T-Slat For 18.375" Chain Centers	AMH203392	\$ 18.00	

John Deere®—Combine

John Deere®—Combine

Application	Description	Part Number	Retail Price	Core
9600, 9610, 9650, 9660	Feederhouse Chain 101 links - T Slat, Wide Spaced, chrome pins Slats every 2nd and 4th link 4 Chain Assembly, CA550 Replaces AH138186	AMAH207778	\$ 895.00	
	Feederhouse Chain 101 links - T Slat, Closed Spaced, chrome pins Slats every 2nd link 4 Chain Assembly, CA550 Replaces AH143400	AMAH137844	\$ 900.00	
	Feederhouse Chain 101 links - T Slat, Wide Spaced, chrome pins Slats every 2nd and 4th link 4 Chain Assembly, CA557 Replaces AH138186	AMX28009	\$ 985.00	
9600, 9610, 9650, 9660, 9660W	T-Slat For 19 3/8" Chain Centers	AMH207776	\$ 7.00	
9650STS, 9660STS BSN 720301, 9750STS, 9760STS BSN 720301, 9860STS BSN 720501	Feederhouse Chain 89 links - T Slat, chrome pins Slats every 2nd and 4th link 3 Chain Assembly - CA557 Chain, 23 3/4" Center-to-Center Replaces AH209913, AH209915, AH212232, AH217632	AMAH217633	\$ 775.00	
(9660STS, 9760STS ASN 720300), 9670STS, 9770STS, 9860STS ASN 720500, 9870STS BSN 730101	Feederhouse Chain 91 links - Cast Slats, High Capacity, Wide Spaced, chrome pins 23.75" Chain Spacing 3 Chain Assembly Replaces AH220517, AH229908, AXE12764	AMAXE17470	\$ 1125.00	
	Cast Slat Replaces H229581	AMHXE24328	\$ 40.00	
(9670STS, 9770STS, 9870STS ASN 730100), (S660, S670, S680, S690 BSN 775001)	Feederhouse Chain 91 links - Cast Slats, High Capacity, Wide Spaced, chrome pins 21.625" Chain Spacing 3 Chain Assembly Replaces AXE17889, AXE17466, AH228592	AMAXE24307	\$ 1125.00	
	Chain Only Kit	AMAXE24307CO	\$ 787.00	
	Cast Slat Replaces H229581	AMHXE24328	\$ 40.00	
9880STS	Feederhouse Chain 101 links - T Slat, chrome pins 3 Chain Assembly, CA557	AMAH217634	\$ 775.00	
(S650, S660, S670, S680, S690 ASN 775000), S760, S770, S780, S790	Feederhouse Chain 91 links - 18 U-Shaped Steel Slats, 9 Cast Slats Slats every 4th and 6th link 4 Chain Assembly	AMAXE27247	\$ 1370.00	
S650, (S660, S670, S680, S690 ASN 775001), S760, S770, S780, S790	Cast Slat Replaces H229581	AMHXE24328	\$ 40.00	

Feederhouse Chain Sprockets

To extend the life of your chain assemblies, always replace the sprockets when installing a new chain.



Application	Description	Part Number	Retail Price	Core
3300, 4400, 4420, 6600, 6601, 6602, 7700	Feederhouse Chain Sprocket 10 Tooth, 1.50" Hex	AMH121435	\$ 35.00	
6600, 6620, 6622, 7700, 7720, 7721, 8820, 9400 ASN 641501, 9500 ASN 643901, 9600 ASN 645301, CTS	Feederhouse Chain Sprocket 10 Tooth, 1.75" Hex Bore	AMH118583	\$ 44.00	

John Deere®—Combine

John Deere®—Combine

Application	Description	Part Number	Retail Price	Core
9410, 9450, 9510, 9550, 9560, 9610, 9650, 9650CTS, 9660, 9660CTS, CTS II	Feederhouse Chain Sprocket - Outside 10 Tooth, 2.25" Round (2) Required	AMH159613	\$ 32.00	
9410, 9450, 9510, 9550, 9560, 9610*, 9650*, 9650CTS, 9660*, 9660CTS, CTS II *2 Required On These Models	Feederhouse Chain Sprocket - Inside 10 Tooth, 2.25" Round	AMH159614	\$ 36.00	
9560STS, 9570STS, 9650STS, 9660STS, (9670STS, 9770STS, 9870STS BSN 730100), 9750STS, 9760STS, 9860STS	Feederhouse Chain Sprocket - Outside 13 Tooth, 2.25" Round, (2) Required	AMH159615	\$ 40.00	
	Feederhouse Chain Sprocket - Inside 13 Tooth, 2.25" Round	AMH159616	\$ 56.00	
(9670STS, 9770STS, 9870STS ASN 730101), S650, S660, S670, S680, S690, S690HM, S760, S770, S780, S790	Feederhouse Chain Sprocket 13 Tooth Replaces H227474	AMHXE123463	\$ 75.00	



Upper Sprocket Tubes

Application	Description	Part Number	Retail Price	Core
9400 BSN 641500, 9500 BSN 643900	Sprocket Tube 10 Tooth, 52.18" Long	AMAH125196	\$ 485.00	
9600 BSN 645300	Sprocket Tube 10 Tooth, 63" Long	AMAH125195	\$ 625.00	



Feederhouse Drums and Shafts



Application	Description	Part Number	Retail Price	Core
(9670STS, 9770STS, 9870STS ASN 730101), (S650, S660, S670, S680, S690 BSN 775000)	Feederhouse Drum Assembly, Narrow	AMAH216876	\$ 428.00	
(9670STS, 9770STS, 9870STS ASN 730101), (S650, S660, S670, S680, S690 BSN 775000)	Feederhouse Drum, Posifeed	AMAH216876-PF	\$ 976.76	
6600, 6620	Feederhouse Drum Replaces AH79392	AMAH84645	\$ 527.28	
9400, 9410, 9450, 9500, 9510, 9550, 9650CTS, 9650STS, 9750STS, CTS, CTS II SN 675101-679050	Feederhouse Drum	AMAH142394	\$ 575.00	
9560STS ASN 720101, 9570STS, S550	Feederhouse Drum	AMAH220243	\$ 725.00	
9560STS ASN 720101, 9570STS, S550	Feederhouse Drum, Posifeed	AMAH220243-PF	\$ 954.87	
9560 ASN 710392, 9660CTS ASN 710408, 9660STS, 9760STS, 9860STS	Feederhouse Drum Replaces AH218323-PF	AMAH218323	\$ 678.00	
9600, 9610, 9650	Feederhouse Drum	AMAH142393	\$ 595.00	
9600, 9610, 9650 Contour-Master™	Feederhouse Drum	AMAH143365	\$ 1011.00	
(9660STS, 9760STS ASN 720301), (9670STS, 9770STS, 9870STS BSN 730100), 9860STS ASN 720501	Feederhouse Drum	AMAH220242	\$ 821.82	
(9660STS, 9760STS ASN 720301), (9670STS, 9770STS BSN 730100), 9860STS ASN 720501, 9870STS BSN 730100	Feederhouse Drum, Posifeed Heavy Duty, Narrow	AMAH220242-PF	\$ 924.78	
(S650, S660, S670, S680, S690 ASN 775000), S760, S770, S780, S785, S790	Feederhouse Drum	AMAXE27254	\$ 731.49	
6600, 6620, 6621	Feederhouse Drum Shaft	AMH76631	\$ 60.00	
7700, 7701, 7720, 7721	Feederhouse Drum Shaft	AMH77755	\$ 70.00	
8820	Feederhouse Drum Shaft	AMH98558	\$ 80.00	
9400, 9410, 9450, 9500, 9510, 9550, 9650CTS, 9650STS, 9750STS, CTS, CTS II SN 675101-679050	Feederhouse Drum Shaft	AMH123734	\$ 80.00	

John Deere®—Combine

Application	Description	Part Number	Retail Price	Core
9560 ASN 710391, (9650STS, 9750STS ASN 000808), 9660CTS ASN 710407, (9660STS, 9760STS ASN 711301), (9670STS, 9770STS BSN 730101), 9860STS ASN 710892, 9870STS BSN 730101	Feederhouse Drum Shaft 52.50" Long, 1.25" Hex Diameter	AMH218671	\$ 82.50	
9560STS ASN 710559, 9570STS, S550	Feederhouse Drum Shaft 41.94" Long, 1.25" Hex Diameter	AMH218670	\$ 131.66	
9600, 9610, 9650	Feederhouse Drum Shaft	AMH123733	\$ 83.00	
3300, 4400, 4420, 6600, 6620, 7700, 7720, 8820	Feederhouse Drum Shaft Arm Replaces AH79728	AMAH116698	\$ 23.00	
9400, 9410, 9450, 9500, 9510, 9550, 9600, 9610, 9650, 9650CTS, 9650STS, 9750STS, CTS, CTS II	Feederhouse Drum Shaft Arm	AMAH126091	\$ 33.00	
9560, 9560STS, 9660, 9660CTS, 9660STS, 9760STS, 9860STS	Feederhouse Drum Shaft Arm	AMAH218367	\$ 62.00	
9570STS, 9670STS, 9770STS, 9870STS	Feederhouse Drum Shaft Arm	AMAH226296	\$ 83.22	
4400, 4420 BSN 550001	Upper Feederhouse Shaft 46.375" Long Replaces H77959, H83783, H84329	AMH86092	\$ 199.52	
6600, 6620 BSN 551901	Upper Feederhouse Shaft 52.375" Long, 1 3/4" Hex Diameter Replaces H83784, H84330	AMH86088	\$ 289.35	
6620 ASN 551901	Upper Feederhouse Shaft 52.375" Long	AMH113408	\$ 242.86	
7700, 7720 BSN 556300	Upper Feederhouse Shaft 63.375" Long	AMH86089	\$ 161.17	
7720 ASN 556301, 7722	Upper Feederhouse Shaft 63.875" Long	AMH113407	\$ 201.85	
8820 BSN 564100	Upper Feederhouse Shaft 74.687" Long	AMH98560	\$ 246.96	
8820 ASN 564101	Upper Feederhouse Shaft 74.687" Long	AMH113406	\$ 413.07	
9400 ASN 641500, 9500 ASN 643900, 9500SH, CTS	Upper Feederhouse Shaft 63" Long Replaces H143353	AMH151566	\$ 367.00	
9410, 9450, 9510, 9510SH, 9550, 9550SH, 9560, 9560SH, 9560STS, 9650CTS, 9660STS, 9750STS, 9760STS, 9860STS, CTS II	Upper Feederhouse Shaft 62.94" Long	AMH156576	\$ 444.00	
9560STS	Upper Feederhouse Shaft 53.38" Long	AMH203039	\$ 463.27	
9600 ASN 645301	Upper Feederhouse Shaft 73.81" Long	AMH151567	\$ 325.00	
9610, 9650, 9660	Upper Feederhouse Shaft 73.87" Long	AMH156577	\$ 550.00	
9660STS, (9670STS, 9770STS, 9870STS BSN 730101), 9760STS, 9860STS	Upper Feederhouse Shaft 21 Spline, 63.06" Long	AMH203850	\$ 552.79	
9670STS, 9770STS, 9870STS, S650, S660, S670, S670HM, S680, S680HM, S690, S690HM, S770, S780, S785, S790	Upper Feederhouse Shaft	AMH224510	\$ 975.00	
S650, S660, S670, S690, S760, S770, S780, S785, S790	Upper Feederhouse Shaft	AMHXE42567	\$ 580.00	
4400, 4420, 6600 w/ Variable Belt Drive or ASN 206201 w/ Fixed Belt Drive, 6620 ASN 615101 w/o Reverser, 7700 w/ Variable Belt Drive or ASN 213301 w/ Fixed Belt Drive, 7720 ASN 615201 w/o Reverser, 8820 BSN 414850 w/ Long Feederhouse	Lower Feederhouse Shaft 91.50" Long Replaces H80922, H80923, H80924	AMH115230	\$ 285.03	
6620 w/ Feed Reverser	Lower Feederhouse Shaft 91.625" Long	AMAH97641	\$ 395.00	

Prices Subject to Change without Prior Notice. The use of original equipment manufacturer (OEM) part numbers or trademarks, e.g. Case® and John Deere®, are for reference purposes only and for indicating product use and compatibility. Our company and the listed replacement parts contained herein are not sponsored, approved or manufactured by the OEM. All parts are New unless designated Reman in the description.

John Deere®—Combine

John Deere®—Combine

Application	Description	Part Number	Retail Price	Core
7720 w/ Feed Reverser, 9501, (9400, 9410, 9500, 9510, CTS, CTS II SN 675101-679050 Fixed Speed w/ Reverser or Variable Speed)	Lower Feederhouse Shaft 91.437" Long Does Not Fit Contour Master Combines	AMAH97642	\$ 468.28	
9450, 9550, 9650	Feederhouse Shaft 63.06" Long	AMAH166651	\$ 341.07	
4420 ASN 550000, 6620 ASN 551900 w/ Regular Variable Drive or ASN 615100 w/ Regular Fixed Drive w/o Reverser, 6620SH SN 403300, 7720**, 8820 ASN 564100 w/ Variable Drive or ASN 564100 w/ Long Fixed Drive, 9400 ASN 641500, (9410, CTS, CTS II - w/ Fixed Speed), 9450, 9500, 9510, 9550, 9550SH, 9560, 9560SH, 9560STS, 9570STS, 9600 ASN 645300, 9610, 9650, 9650CTS, 9650STS, 9660, 9660CTS, 9660STS, 9670STS, 9750STS, 9760STS, 9770STS, 9860STS, 9870STS **Will fit a 7720 if the Combine fits one of the following criteria: - ASN 556300 w/ Regular Variable Drive - SN 556301-615200 w/ Regular Fixed Drive - All SN's w/ Fixed Drive w/ Reverser - ASN 615200 w/ Regular Fixed Drive w/o Reverser - ASN 556300 w/ Long Fixed Drive	Ball Bearing, Upper Feederhouse Shaft 3.1496" OD, 1.25" Hex Bore Diameter Replaces 575883, 70575883, 86523785	AMJD9373	\$ 14.50	
6600, 6620, 7700, 7720*, 8820 BSN 564101 *Will fit a 7720 if the Combine fits one of the following criteria: - BSN 556301 w/ Regular Variable Drive - BSN 556301 w/ Regular Fixed Drive w/ Reverser - BSN 409101 w/ Regular Fixed Drive w/o Reverser - BSN 556302 w/ Long Fixed Drive	Bearing, Upper Feederhouse Shaft 1.25" ID, 2.441" OD Replaces JD8545, JD9274	AMJD9452	\$ 24.59	
8820, 9400, 9500, 9600 BSN 637232	Bearing Housing 2.37" ID For Feederhouse Drum Shaft Replaces H93938	AMH97919	\$ 72.69	
9400 ASN 635700, 9410, 9450, (9500, 9500SH ASN 638058), 9501, 9510, 9510SH, 9550, 9550SH, 9600 ASN 637232, 9610, 9650, 9650CTS, 9650STS, 9750STS, CTS, CTS II	Bearing Housing For Feeder Roller Shaft	AMH138753	\$ 51.70	
9400 BSN 641501, 9500 BSN 643901, 9600 BSN 645301	Bearing, Upper Feederhouse Shaft Tapered Roller Bearing 1.456" Wide, 2.677" OD, 1.535" Bore	AMAH109788	\$ 51.02	
9560, 9560STS ASN 720100, 9570STS, 9650, 9650CTS, 9650STS, (9660STS, 9760STS ASN 720300), 9670STS, 9750STS, 9770STS, 9860STS ASN 720500, 9870STS, S550, S650, S660, S670, S670HM, S680, S680HM, S690, S690HM, S760, S770, S780, S790	Bearing w/ Housing, Feederhouse Drum Shaft	AMAH219987	\$ 66.50	
9560STS ASN 720100, 9570STS, (9660STS, 9760STS ASN 720300), (9670STS, 9770STS, 9870STS BSN 730101), 9860STS ASN 720500, S550	Bearing Cap	AMAH220241	\$ 78.04	



Feederhouse Floor Sheets

Application	Description	Part Number	Retail Price	Core
6600 ASN 5305, 6620 (Excluding SideHill)	Feederhouse Sheet Lower Front Bottom	AMAH88598	\$ 265.00	
7700 ASN 163900 w/ Regular Feederhouse	Feederhouse Sheet False Bottom 43 3/4" Long, 45 3/4" Wide Replaces AH83329, AH84115, AH86797	AMAH89523	\$ 338.64	

John Deere®—Combine

















Application	Description	Part Number	Retail Price	Core
7700 ASN 163900	Feederhouse Sheet False Bottom, Long 46 1/4" Long Replaces AH83332, AH84114, AH86798	AMAH89525	\$ 274.55	
7700, 7720	Feederhouse Sheet Upper Back Bottom Regular Length Feederhouse	AMAH83620	\$ 210.00	
7700 ASN 3642, 7720	Feederhouse Sheet Lower Front Bottom	AMAH88599	\$ 350.00	
7720	Feederhouse Sheet Regular Length Feederhouse 43.50" x 37"	AMAH124954	\$ 240.67	
8820	Feederhouse Sheet Lower Front Bottom	AMAH96439	\$ 417.16	
	Feederhouse Sheet Upper Back Bottom Regular Length Feederhouse	AMAH96541	\$ 265.00	
9400, 9410, 9450, 9500, 9510, 9510SH, 9550, 9550SH, 9650CTS	Feederhouse Sheet, Return For Airflow Retrofit Installation	AMAH155650	\$ 139.09	
9400, 9500	Feederhouse Sheet Bottom Floor Replaces AH159703	AMAH137733	\$ 675.00	
9400, 9500 ASN 643900, CTS	Feederhouse Sheet, Return	AMH143376	\$ 107.69	
9560, 9660CTS	Feederhouse Sheet, Narrow	AMAH166026	\$ 597.14	
9600	Feederhouse Sheet, Return	AMH143375	\$ 95.85	
9600, 9610, 9650	Feederhouse Sheet Bottom Floor Replaces AH159704	AMAH137732	\$ 840.00	
9650STS, 9750STS	Feederhouse Sheet Bottom Floor	AMAH147800	\$ 767.71	
9660	Feederhouse Sheet, Wide	AMAH166027	\$ 739.44	
(9660STS, 9760STS ASN 715701), 9670STS, 9770STS, 9860STS ASN 720501, 9870STS, S650 SN 765000-785000, (S660, S670, S680, S690 SN 745100-785000), (S670HM, S680HM BSN 765000), S690HM SN 745101-765000	Feederhouse Sheet Lower Front Bottom	AMH219180	\$ 190.00	
9660STS, 9670STS, 9760STS, 9770STS, 9860STS, 9870STS, S660, (S670, S680, S690 BSN 775000)	Feederhouse Sheet Replaces AXE15498, AXE24554	AMAH218352	\$ 875.00	
9660STS, 9760STS, 9860STS	Feederhouse Sheet, Front	AMH214781	\$ 130.00	
(S660, S670, S680, S690 ASN 775001 w/ Fore/Aft Tilt)	Feederhouse Sheet	AMAXE29353	\$ 795.00	
S660 ASN 765172, S670 ASN 765253, S680 ASN 766007, S690 ASN 765250, S760, S770, S780, S785, S790	Feederhouse Sheet, Floor	AMAXE36568	\$ 975.00	

Feederhouse Components









Application	Description	Part Number	Retail Price	Core
6600, 6620	Feederhouse Separator Plate Replaces H82498	AMH102469	\$ 161.32	
 7700, 7720	Feederhouse Separator Plate Replaces H94330	AMH102470	\$ 189.73	

John Deere®—Combine

John Deere®—Combine

Application	Description	Part Number	Retail Price	Core
8820	Feederhouse Separator Plate Replaces H99026	AMH102471	\$ 217.42	
 9400 ASN 640101, 9500 ASN 640201, 9600 ASN 640301, CTS, CTS II	Feederhouse Drive Shield, Right Hand	AMAH156377	\$ 325.00	
 9400 BSN 640100, 9500 BSN 640200, 9501 BSN 640400, 9600 BSN 640300	Feederhouse Drive Shield, Right Hand	AMAH130894	\$ 195.00	
 9560STS, 9660STS, 9760STS, 9860STS	Feederhouse Drive Shield, Right Hand	AMH206543	\$ 175.00	
 9560STS, 9660STS, 9760STS, 9860STS	Feederhouse Drive Shield, Left Hand	AMH205822	\$ 155.00	
 9600, 9610	Feederhouse Drive Shield, Left Hand	AMAH156376	\$ 275.00	
 9410, 9450, 9510, 9550, 9610, 9650, 9650CTS, 9650STS, 9750STS, CTS, CTS II	Deflector Shield, Right Hand For Feederhouse Drum, Front Replaces H123636	AMH159533	\$ 52.50	
	Deflector Shield, Left Hand For Feederhouse Drum, Front Replaces H123637	AMH159534	\$ 52.50	
 9400, 9410, 9450, 9500, 9510, 9550, 9650CTS, 9650STS, 9750STS, CTS, CTS II SN 675101-679050	Front Shield	AMH123633	\$ 80.00	
 9600, 9610	Front Shield	AMH123632	\$ 90.00	
 7700 ASN 213300, 7720	Stone Trap Support	AMAH90845	\$ 142.10	
 9400, 9410, 9500, 9501, 9510, CTS, CTS II	Stone Trap Door 54.50" Wide	AMAH120502	\$ 193.64	
 9600, 9610 BSN 680300	Stone Trap Door 65.375" Wide	AMAH120501	\$ 196.54	
 9570STS, S550	Stone Trap Hinge Narrow Version	AMAH227674	\$ 159.99	
 (9660STS, 9760STS ASN 720300), 9670STS, 9770STS, 9860STS ASN 720500, 9870STS, S650, (S660, S670, S680, S690 ASN 795000 w/ Solid Slat Chaffer Element), S670HM, S680HM, S690HM, S760, S770, S780, S785, S790	Stone Trap Hinge Replaces AH219193	AMAH227675	\$ 123.14	
 9610 ASN 680301, 9650, 9660	Feederhouse Plate Assembly, Wide	AMAH160605	\$ 221.27	
 9650STS, 9660STS, 9670STS, 9750STS, 9760STS, 9770STS, 9860STS, 9870STS, S650 ASN 765000, (S660, S670, S690 ASN 745100), S670HM BSN 765000, S680 ASN 745100, S680HM BSN 765000, S690HM SN 745101-765000	Feederhouse Plate	AMAH156157	\$ 240.00	
 9560STS, 9570STS, 9650STS, 9660STS, 9750STS, 9760STS, 9770STS, 9860STS, 9870STS, 9880STS, S660, S670, S680	Feederhouse Floor Plate	AMAH154691	\$ 475.00	
 9400 SN 635243-640100, (9500, 9550, 9650CTS - Rice), CTS	Front Wear Plate	AMH143456	\$ 75.00	







John Deere®—Combine

Application	Description	Part Number	Retail Price	Core
 9400 ASN 640101, 9410, 9450, 9500, 9510, 9550, CTS, CTS II SN 675101-679050	Front Wear Plate	AMH144052	\$ 75.00	
 9600 S/N 635520-640300	Front Wear Plate	AMH143455	\$ 75.00	
 9600 ASN 640301, 9610, 9650	Front Wear Plate	AMH144051	\$ 93.00	
9400, 9410, 9450, 9500, 9500SH, 9510, 9510SH, 9550, 9550SH, 9560, 9560SH, 9560STS, 9570STS, 9600, 9610, 9650, 9650CTS, 9650STS, 9660, 9660CTS, 9660STS, 9670STS, 9750STS, 9760STS, 9770STS, 9780CTS, 9860STS, 9870STS, C670, CTS, CTS II, T550, T560, T660, T670	Feederhouse Wear Plate, Right Hand Lower	AMH149460	\$ 42.20	
	Feederhouse Wear Plate, Left Hand Lower	AMH149459	\$ 42.20	
9400, 9410, 9450, 9500, 9500SH, 9510, 9510SH, 9550, 9550SH, 9560, 9560SH, 9560STS, 9570STS, 9600, 9610, 9650, 9650CTS, 9660, 9660CTS, 9660STS, 9670STS, 9750STS, 9770STS, 9860STS, 9870STS, C670, CTS, CTS II, S550 SN 745100-764999, S650 ASN 765000, (S660, S670, S680, S690 ASN 745100), (S670HM, S680HM BSN 765000), S690HM SN 745101-765000, S760, S770, S780, S785, S790, T550, T560, T660, T670	Feederhouse Wear Plate, Top	AMH149461	\$ 27.41	
 9660STS, 9670STS, 9760STS, 9770STS, 9860STS, 9870STS, S650 ASN 765000, (S660, S670, S680, S690 ASN 745100)	Feederhouse Wear Plate, Front	AMH219091	\$ 87.00	
 9560, 9560STS, 9660CTS, 9660STS	Wear Plate Heavier Gauge than OEM	AMH171372	\$ 67.00	
 9650STS, 9750STS - w/ Contour-Master™	Feederhouse Wear Plate, Front	AMH157112	\$ 100.00	
 9650STS, 9660STS, 9670STS, 9750STS, 9760STS, 9770STS, 9860STS, 9870STS, S660, S670, S670HM, S680, S680HM, S690, S690HM	Isolator Seal, Feederhouse Door	AMH220556	\$ 22.99	
 9610, 9650, 9660	Feed Plate Hinge Assembly, Wide	AMAH162292	\$ 197.90	
9600 ASN 642300, 9610, 9650, 9660	Front Feederhouse Support Channel	AMH143357	\$ 90.58	
9600 ASN 642301, 9610, 9650, 9660	Rear Feederhouse Support Assembly	AMAH141860	\$ 164.81	
9400 ASN 640505, 9410, 9450, 9500 ASN 642578, 9510, 9550, 9550SH, 9560, 9560SH, 9650CTS, 9660CTS, CTS, CTS II	Feederhouse Stripper Plate	AMH145464	\$ 39.50	
 9400 ASN 650101, 9410, 9450 BSN 685178, (9500, 9500SH ASN 650201), 9510, 9510SH, 9550 BSN 685741, 9550SH ASN 685703, 9600, 9610, 9650 ASN 686075, 9650CTS BSN 685496, 9650STS BSN 685804, 9750STS BSN 685840, CTS ASN 650401, CTS II	Wear Strip, Upper Return	AMH148187	\$ 9.75	

John Deere®—Combine







John Deere®—Combine

John Deere®—Combine

Application	Description	Part Number	Retail Price	Core
 9450 ASN 685178, 9550 ASN 685741, 9550SH ASN 685704, 9560, 9560SH, 9560STS, 9570STS, 9650 ASN 686075, 9650CTS ASN 685496, 9650STS ASN 685804, 9660, 9660CTS, 9660STS, 9670STS, 9750STS ASN 685841, 9760STS, 9770STS, 9860STS, 9870STS, S550, S650, S660, S670, S670HM, S680, S680HM, S690, S690HM, S760, S770, S770HM, S780, S780HM, S785, S785HM, S790, S790HM	Wear Strip, Upper Return	AMH171960	\$ 7.82	
4400, 4420, 6600, 6620, 7700, 7720, 8820	Poly Chain Guide	AMX27158	\$ 53.25	
 9400, 9410, 9500, 9510, 9600, 9610	Poly Chain Guide	AMX27157	\$ 53.25	
 6620, 7720, 8820	Feederhouse Pivot Arm, Idler	AMAH93333	\$ 64.86	
9400, 9410, 9450, 9500, 9501, 9510, 9510SH, 9550, 9550SH, 9560, 9560STS, 9570STS, 9600, 9610, 9650, 9650CTS, 9660, 9660STS, 9670STS, 9750STS, 9760STS, 9770STS, 9860STS, 9870STS, CTS, CTS II, S550 SN 745100-764999, S650 SN 765000-785000, (S660, S670, S680, S690 ASN 745100), (S670HM, S680HM BSN 765000), S690HM SN 745101-765000, S760, S770, S780, S785, S790	Feederhouse Shaft Replaces HXE31772	AMAH125454	\$ 147.34	
9650, 9660	Feederhouse Shaft, Wide Airflow 73.81" Long	AMAH166652	\$ 300.83	
 9400 BSN 641500, 9500 BSN 643900, 9600 BSN 645300, CTS, CTS II	Upper Stub Shaft, Right Hand 9.97" Long	AMH129681	\$ 259.66	
9400 BSN 641500, 9500 BSN 643900, 9600 BSN 645300	Upper Stub Shaft, Left Hand 2.93" Long	AMH129658	\$ 133.90	
 6620, 7720, 8820	Idler Arm For Feederhouse Drive	AMAH97338	\$ 139.87	
 9550, 9550SH, 9560, 9560SH, 9560STS, 9570STS, 9650, 9650CTS, 9650STS, 9660, 9660CTS, 9660STS, 9670STS, 9760STS, 9770STS, 9780CTS ASN 072800, 9870STS, C670, CTS, S550 SN 745100-764999, (S650, S660, S670, S680, S690 ASN 745100), (S670HM, S680HM BSN 765000), S690HM SN 745101-765000, S760, S770, S780, S785, S790, T550, T560, T660, T670, Cotton Pickers: 7260, 7660, 7760, CP690	Idler Pulley, Feed Accelerator Replaces AH166439	AMAH204389	\$ 61.29	
 9400, 9410, 9500, 9500SH, 9510, 9510SH, 9550, 9550SH, 9560, 9560SH, 9560STS, 9570STS, 9600, 9610, 9650, 9650CTS, 9650STS, 9660, 9660CTS, 9660STS, 9670STS, 9760STS, 9770STS, 9860STS, CTS, CTS II, S550, S660, S670, S680, S690	Variable Speed Idler Support	AMAH167579	\$ 210.00	

John Deere®—Combine

John Deere®—Combine

	Application	Description	Part Number	Retail Price	Core
	6620, 7720, 8820, 9400, 9410, 9450 BSN 695101, 9500, 9500SH, 9510, 9510SH, 9550 BSN 695201, 9550SH BSN 695701, 9560STS, 9600, 9610, 9650 BSN 695301, 9650CTS BSN 695401, 9650STS BSN 695501, 9660, 9750STS BSN 695601, CTS, CTS II	Hydraulic Cylinder	AMAH211577	\$ 209.00	
	Cornheads: 443, 444, 493, 494, 543, 546, 592, 594, 642, 643, 644, 645, 693, 694, 842, 843, 844, 893, 894, 1092, 1293, 1294	Bearing and Support Kit	AMX27553	\$ 155.00	
	9450, 9550, 9550SH, 9560, 9560SH, 9560STS, 9570STS, 9650, 9650CTS, 9650STS, 9660, 9660CTS, 9660STS, 9670STS, 9750STS, 9760STS, 9770STS, 9870STS, S550, S650, S660, S670, S670HM, S680, S680HM, S690, S690HM, S760, S770, S780, S785, S790	Feederhouse Idler Arm	AMAH168397	\$ 133.07	
	6620, 7720, 7722, 8820, 9400, 9410, 9450, 9500, 9501, 9510, 9550, 9560, 9560STS, 9600, 9610, 9650, 9650CTS, 9660, 9660CTS, CTS, CTS II	Feederhouse Slip Clutch Hub	AMH105590	\$ 73.50	
	6620, 6622, 7720, 8820, 9400, 9410, 9450, 9500, 9500SH, 9501, 9510, 9510SH, 9550, 9550SH, 9560, 9560SH, 9560STS, 9600, 9610, 9650, 9650CTS, 9660, 9660CTS, CTS, CTS II	Slip Clutch Jaw	AMH101677	\$ 29.50	
	6620, 7720, 8820	Feederhouse Pulley Support	AMAH96092	\$ 285.33	
	9400, 9410, 9450, 9500, 9500SH, 9501, 9510, 9510SH, 9550, 9550SH, 9560, 9560SH, 9600, 9610, 9650, 9650CTS, 9660, 9660CTS, 9780CTS ASN 070362, C670, CTS, CTS II, T550, T560, T660, T670	Pulley 4-Groove, 9.46" OD Dual Range Cylinder Drive	AMH125391	\$ 232.54	
	9400, 9450, 9500, 9550, 9550SH, 9560, 9560SH, 9600, 9650, 9650CTS, 9660, 9660CTS	Feederhouse Pulley, Dust Fan For Airflow Retrofit Installation 1.95" Wide, 1.336" ID, 5.88" OD	AMAH155706	\$ 56.67	
	9560, 9560STS, 9570STS, 9660, 9660STS, 9670STS, 9760STS, 9770STS, S550, S660 SN 745000-764999	Pulley, Fixed Speed 2.128" ID, 11.50" OD	AMAH206934	\$ 289.63	
	6620, 7720, 8820, 9400, 9410, 9450, 9500, 9510, 9510SH, 9550SH, 9560, 9560SH, 9560STS, 9570STS, 9600, 9610, 9650, 9650CTS, 9650STS, 9660, 9660CTS, 9660STS, 9670STS, 9750STS, 9760STS, 9770STS, 9860STS, S550 SN 745100-764999, S650 ASN 765000, (S660, S670 ASN 745100), S680 SN 766007-785000, S690 SN 765250-785000	Inner Hub For Feederhouse Pulley	AMH97378	\$ 107.38	
	6620, 7720, 8820, 9400, 9410, 9450 BSN 390218, 9500, 9500SH, 9510, 9510SH, 9550 BSN 690801, 9600, 9610, 9650 BSN 690821, 9650CTS BSN 690490, 9650STS BSN 691932, 9750STS BSN 691384, CTS, CTS II - w/ Standard Capacity	Feederhouse Sheave Half, Inner 12.50" OD Replaces H93189, H108673	AMH168126	\$ 345.00	

John Deere®—Combine

John Deere®—Combine

	Application	Description	Part Number	Retail Price	Core
	9450 ASN 690217, 9550 ASN 690800, 9560, 9560SH, 9560STS, 9570STS, (9600, 9610 - w/ AH153339 Gearbox), 9650 ASN 690820, 9650CTS ASN 690489, 9650STS ASN 691931, 9660, 9660CTS, 9660STS, 9670STS, 9760STS, 9770STS - w/ Standard Capacity	Feederhouse Sheave Half, Inner 12.524" OD	AMH201579	\$ 317.83	
	9560, 9560STS, 9570STS, 9660, 9660CTS, 9660STS, 9670STS, 9760STS, 9770STS, 9860STS BSN 715600, S550 SN 745100-764999, S650 ASN 765000, S660 ASN 745100	Feederhouse Sheave Half, Inner 2.127" ID, 14.168" OD	AMH216332	\$ 392.00	
	9560, 9560STS, 9570STS, 9660, 9660CTS, 9660STS, 9670STS, 9760STS, 9770STS, 9860STS BSN 715600, S550 SN 745100-764999, S650 ASN 765000, (S660 S670 ASN 745100), S680 SN 766007-785000, S690 SN 765250-785000	Variable Speed Sheave	AMAH204591	\$ 516.50	
	9660, 9660STS, 9670STS, 9760STS, 9770STS, 9860STS, 9870STS, S650 SN 765000-785000, (S660, S670 ASN 745100), (S680, S690 SN 745100-785000), S760, S770	Variable Speed Sheave	AMH217454	\$ 600.00	
	9770STS, 9870STS	Idler Pulley, Multi-Speed Feederhouse Drive 1.437" Overall Width, 7.992" Diameter, 0.637" Bore Diameter, 1" Groove Width Replaces AH85276, AH165366	AMAH97031	\$ 33.07	
	9560STS, 9660, 9660CTS, 9660STS, 9760STS, 9860STS	Feederhouse Drive Sprocket Double Sprocket, 22 & 26 Tooth, 21 Internal Spline	AMAH203076	\$ 194.12	
	(9560STS, 9660, 9660CTS, 9660STS, 9760STS - High-Capacity), 9860STS High Speed	Feederhouse Drive Sprocket Double Sprocket, 26 & 38 Tooth, 21 Internal Spline	AMAH218403	\$ 327.44	
	9650, 9650STS, 9660STS, 9750STS, 9760STS, 9860STS	Feederhouse Drive Sprocket, Upper 34 Tooth, 8.54" Diameter, 2.63" Bore Diameter	AMH119709	\$ 49.00	
	9570STS, 9670STS, 9770STS, 9870STS	Feederhouse Sprocket 34 Tooth	AMH219634	\$ 61.90	
	9400, 9410, 9500, 9501, 9510, 9600, 9610, CTS, CTS II	Sprocket Assembly Front Driveshaft w/ Reverser 60 Chain, 15 & 22 Tooth	AMAH125782	\$ 75.00	
	9400, 9410, 9450, 9500, 9501, 9510, 9550, 9560, 9560STS, 9600, 9610, 9650, 9650CTS, 9660, 9660CTS, CTS, CTS II	Sprocket, Slip Clutch 34 Tooth, 1.752" Bore Diameter, 0.78" Overall Height For 60 Chain	AMAH116232	\$ 65.00	
	9400, 9410, 9450, 9500, 9500SH, 9501, 9510, 9510SH, 9550, 9550SH, 9560, 9560SH, 9560STS, 9600, 9610, 9650, 9650CTS, 9650STS, 9660, 9660CTS, 9660STS, 9750STS, 9760STS, 9860STS, CTS, CTS II	Cam, Left Hand Shoe Drive Inner, 6 mm Keyway, 1.38" ID	AMH234550	\$ 69.95	





John Deere®—Combine

John Deere®—Combine

	Application	Description	Part Number	Retail Price	Core
	9400, 9410, 9450, 9500, 9500SH, 9510, 9550, 9550SH, 9560, 9560SH, 9560STS, 9570STS, 9600, 9610, 9650, 9650CTS, 9650STS, 9660, 9660CTS, 9660STS, 9750STS, 9760STS, 9770STS, 9860STS, 9870STS, CTS, CTS II	Bearing Housing	AMH147593	\$ 55.00	
	9600, 9610	Stone Trap Hinge	AMH148020	\$ 89.67	
	9400, 9410, 9450, 9500, 9501, 9510, 9510SH, 9550, 9550SH, 9650, 9650STS, 9750STS, CTS, CTS II SN 675101-679050	Feederhouse Seal Replaces H170737, H169170, H131452	AMH173904	\$ 47.00	
	9600, 9610, 9650	Feederhouse Seal	AMH173903	\$ 55.00	
	6620, 7720, 8820, 9400, 9410, 9450 BSN 695100, 9500, 9500SH, 9510, 9510SH, 9550 BSN 695200, 9550SH BSN 695700, 9560, 9560SH, 9560STS, 9570STS, 9600, 9610, 9650 BSN 695300, (9650CTS, 9650STS BSN 695400), 9660, 9660CTS, 9660STS, 9670STS, 9750STS BSN 695600, 9760STS, 9770STS, 9860STS, 9870STS, CTS, CTS II	Ball Bearing	AMJD10018	\$ 22.23	
	9400, 9410, 9500, 9510, 9600, 9610, CTS, CTS II	Feederhouse Drive Tightener Arm	AMAH128903	\$ 75.68	
	9400, 9410, 9450, 9500, 9500SH, 9510, 9510SH, 9550, 9550SH, 9560, 9560SH, 9560STS, 9610, 9650, 9650CTS, 9650STS, 9660, 9660CTS, 9660STS, 9750STS, 9760STS, 9770STS, 9860STS, 9870STS, CTS, CTS II	Bushing, Feederhouse Drive Tightener 1.005" ID, 1.128" OD, 1" Wide	AMH171061	\$ 5.00	
	9400, 9410, 9450, 9500, 9510, 9550, 9550SH, 9560, 9600, 9610, 9650, 9650CTS, 9660, 9660CTS, CTS, CTS II - All w/ existing Feederhouse Airflow or for use w/ Feederhouse Airflow	Return Floor Runner	AMAH157942	\$ 249.36	
	9400 BSN 641501, 9500 BSN 643901, 9600 BSN 645301	Bearing, Feederhouse Slip Clutch Tapered Roller Bearing 1.456" Wide, 2.677" OD, 1.535" Bore	AMAH109788	\$ 51.02	
	(4400, 4420 - Long), (6600, 7700 - Regular), 6620 BSN 502551, 7720 BSN 507351	Roller Chain, Feederhouse Drive 228 Links, Size 50 Chain	AMAH104375	\$ 52.00	
	6620 ASN 502551, 7720 ASN 507351, 8820 Regular	Roller Chain, Feederhouse Drive 228 Links, Size 50 Chain	AMAH104868	\$ 60.00	
	9400, 9410, 9500, 9510, 9600, 9610, CTS II	Roller Chain, Feederhouse Drive 219 Links, Size 60 Chain	AMAH145029	\$ 70.00	
	9450, 9550, 9650, 9650CTS, CTS, CTS II	Roller Chain, Feederhouse Drive 223 Links, Size 60 Chain	AMAH205015	\$ 60.00	
	9500SH, 9510SH, 9550SH	Roller Chain, Feederhouse Drive 229 Links, Size 60 Chain	AMAH135693	\$ 60.00	
	9560STS, 9570STS, 9660STS, 9670STS, 9760STS, 9770STS, 9860STS, 9870STS	Roller Chain, Feederhouse Drive Hi-Speed, 192 Links, Size 60 Chain	AMAH206701	\$ 75.00	

Prices Subject to Change without Prior Notice. The use of original equipment manufacturer (OEM) part numbers or trademarks, e.g. Case® and John Deere®, are for reference purposes only and for indicating product use and compatibility. Our company and the listed replacement parts contained herein are not sponsored, approved or manufactured by the OEM. All parts are New unless designated Reman in the description.

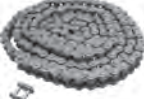
John Deere®—Combine

	Application	Description	Part Number	Retail Price	Core
	(9560STS, 9570STS, 9660STS, 9670STS, 9760STS, 9770STS, 9860STS, 9870STS BSN 735100)	Roller Chain, Feederhouse Drive 187 Links, Size 60 Chain	AMAH206862	\$ 56.00	
	(9570STS, 9670STS, 9770STS, 9870STS, S550, S560, S660, S670, S680, S690, S760, S770, S780, S790 ASN 735101)	Roller Chain, Feederhouse Drive 189 Links, Size 60H Chain Replaces AXE80366, AXE72709	AMAH232566	\$ 63.00	
	9650STS, 9750STS	Roller Chain, Feederhouse Drive 195 Links, Size 60 Chain	AMAH205013	\$ 58.00	
	S660, S670, S680, S690, S760, S770, S780, S790	Roller Chain, Feederhouse Drive 181 Links, Size 60H Chain For Hydraulic Fore/Aft Tilt	AMAXE28813	\$ 52.00	
	9500SH, 9510SH, 9550SH	Roller Chain, Lower Feederhouse Drive Shaft 54 Links, Size 60 Chain	AMAH135694	\$ 25.00	

Feed Reverser Assemblies and Components



Application	Description	Part Number	Retail Price	Core
6620	Reman Feed Reverser Assembly	AMAH120068-R	\$ 2000.00	\$ 250.00
7720, 7722, 9400, 9500	Reman Feed Reverser Assembly	AMAH134864-R	\$ 2750.00	\$ 250.00
9550, 9550SH, 9650CTS, 9650STS, 9750STS ASN 700301	Reman Feed Reverser Assembly High Capacity	AMAH204839-R	\$ 2900.00	\$ 500.00
9550 BSN 700200, 9650CTS BSN 700400 High-Capacity, 9650STS BSN 700500, 9750STS BSN 700600	Reman Feed Reverser Assembly 67 1/2" Long	AMAH159170-R	\$ 3000.00	\$ 250.00
8820, 9600	Reman Feed Reverser Assembly	AMAH134863-R	\$ 2750.00	\$ 250.00
9610	Reman Feed Reverser Assembly	AMAH156052-R	\$ 2750.00	\$ 250.00
9650 High-Capacity BSN 700300	Reman Feed Reverser Assembly 78 1/2" Long	AMAH159171-R	\$ 3000.00	\$ 250.00
(9600, 9610 - w/ Contour-Master™), 9650 BSN 700300 w/ Standard Gearbox	Reman Feed Reverser Assembly	AMAH153339-R	\$ 3000.00	\$ 250.00
9770STS, 9870STS	Reman Feed Reverser Assembly High Torque Replaces DE20076	AMDE20517	\$ 4000.00	\$ 500.00
9670STS, 9770STS, S650 ASN 765000, S660 ASN 745100	Reverser, Standard Duty Replaces AH204585, AH204589	AMAH225336	\$ 3000.00	\$ 250.00
6620, 6622, 7700, 7722, 8820, 9400, 9410, 9450, 9500, 9501, 9510, 9550, 9600, 9610, 9650, 9650CTS, CTS, CTS II	Reverser Gearbox Gear	AMH106073	\$ 110.00	
6620, 7720 BSN 626800, 8820 BSN 626300, 9400, 9410, 9450* BSN 700100, 9500, 9510, 9510SH, (9550*, 9550SH* BSN 700200), 9560SH*, 9600, 9610, 9650* BSN 700300, 9650CTS* BSN 700400, 9650STS* BSN 700500, 9750STS* BSN 700600, CTS, CTS II *w/ Standard Gearbox	Shift Collar, Reverser Gearbox 10 Spline, 3.23" Diameter Replaces H98905	AMH132328	\$ 135.00	

John Deere®—Combine

John Deere®—Combine

Application	Description	Part Number	Retail Price	Core
6620 ASN 610731, 6622 ASN 507051, 7720 ASN 612194, 7722, 8820 ASN 404351, 9400, 9410, 9450 BSN 700100, 9500, 9501, 9510, 9510SH, (9550, 9550SH BSN 700200), 9560, 9560SH, 9600, 9610, 9650 BSN 700300, 9650CTS BSN 700400, 9650STS BSN 700500, 9750STS BSN 700600, CTS, CTS II	Reverser Ring Gear 73 Tooth	AMAH105040	\$ 265.00	
6620, 6620SH, 6622, 9400, 9410, 9450, 9500, 9500SH, 9510, 9510SH, 9550, 9550SH, 9600, 9610, 9650, 9650CTS, 9650STS, 9750STS, CTS, CTS II	Planetary Input Gear w/ Oil Lube Spots	AMH166216	\$ 160.00	
9400*, 9410*, 9450 SN 690218-700100, 9500*, 9500SH*, 9510*, 9550 SN 690800- 700200, 9550SH SN 690720-700200, 9560SH, 9600**, 9610**, 9650 SN 690821- 700300, 9650CTS SN 690490-700400, 9650STS SN 691932-700500, 9750STS SN 691384-700600, CTS*, CTS II* *w/ AH153341 Gearbox **w/ AH153339 Gearbox	Planetary Input Gear	AMH201578	\$ 188.00	
6620, 6620SH, 6622, 7720, 7722 HillSide, 8820, 9400, 9410, 9450, 9500, 9500SH, 9510, 9510SH, 9550, 9560SH, 9600, 9610, 9650, 9650CTS, 9650STS, 9750STS, CTS, CTS II	Planetary Gear (3) Required Planetary Pin (3) Required	AMH168994 AMR33079	\$ 100.00 \$ 10.00	
9450, (9550, 9550SH - High Capacity or Standard Capacity ASN 700200), 9560, 9560STS, 9570STS, 9650 High Capacity or Standard Capacity ASN 700300, 9650CTS High Capacity or Standard Capacity ASN 700400, 9650STS High Capacity or Standard Capacity ASN 700500, 9660, 9660CTS, 9660STS, 9670STS, 9750STS, 9760STS, 9770STS, 9860STS, 9870STS w/o Pump	Planetary Pin 3.071" Long, 0.814" Diameter	AMZ61813	\$ 49.42	
9450 ASN 700100, 9550 w/ High Capacity or ASN 700200 w/ Standard Capacity, 9560, 9560STS, 9570STS, 9650 w/ High Capacity or ASN 700300 w/ Standard Capacity, 9650CTS ASN 700400, 9650STS w/ High Capacity or ASN 700500 w/ Standard Capacity, 9660, 9660CTS, 9660STS, 9670STS, 9750STS w/ High Capacity or ASN 700600 w/ Standard Capacity, 9760STS, 9770STS, 9860STS, S550, S650 ASN 785000 or SN 765000-785000 w/ Heavy Duty Variable, S660 ASN 765172 w/ Heavy Duty Variable Speed, S760 w/ Heavy Duty Variable Speed Only	Planetary Pinion Gear 14 Tooth Gear, 24 Tooth Sprocket, 3.071" Height, 0.814" Pin Diameter	AMZ12714	\$ 210.00	
9660, 9660STS, 9670STS, 9760STS, 9770STS ASN 730100, 9860STS, 9870STS, S650, S660, S670, S670HM, S680, S680HM, S690, S690HM, S760, S770, S780, S785, S790	Planetary Gear 14 Tooth, 29 Tooth Sprocket (3) Required	AMCE18522	\$ 225.00	
6620, 9400, 9410, 9450, 9500, 9510, 9550, 9560, 9600, 9610, 9650, 9650CTS, 9650STS	Reverser Pinion Carrier	AMH168125	\$ 750.00	
6620, 7720, 8820, 9400, 9410, 9450 BSN 700101, 9500, 9500SH, 9510, 9510SH, (9550, 9550SH BSN 700201), 9560, 9600, 9610, 9650 BSN 700301, 9650CTS BSN 700401, 9650STS BSN 700501, 9750STS BSN 700601	Ball Bearing	AMJD10010	\$ 35.09	

Prices Subject to Change without Prior Notice. The use of original equipment manufacturer (OEM) part numbers or trademarks, e.g. Case® and John Deere®, are for reference purposes only and for indicating product use and compatibility. Our company and the listed replacement parts contained herein are not sponsored, approved or manufactured by the OEM. All parts are New unless designated Reman in the description.

John Deere®—Combine

John Deere®—Combine

Application	Description	Part Number	Retail Price	Core
9450 ASN 700100, 9550, 9560, 9650, 9650CTS, 9650STS, 9660, 9660CTS, 9660STS, 9750STS, 9760STS, 9770STS, 9860STS BSN 715601 w/ Fixed Reverser, S650, S660, S760	Feed Reverser Gearbox Shaft, Standard 18.18" Long, 24 & 21 Spline	AMH177985	\$ 339.40	
9560STS, 9570STS, S550	Feed Reverser Gearbox Shaft 23.48" Long, 24 & 21 Spline	AMH202929	\$ 878.65	
(9660, 9660STS, 9760STS, 9860STS - w/ Variable Speed Drive), (9670STS, 9770STS BSN 730101), (9870STS BSN 730101 w/ High Torque Variable Drive Conversion Only), (S660, S670, S680, S690 BSN 785001 - w/ High Torque Variable Drive Conversion Only)	Feed Reverser Gearbox Shaft 18.18" Long, 24 & 21 Spline	AMH213514	\$ 663.57	
6620, 7720, 8820, 9400, 9450 BSN 700101, 9500, 9500SH, (9550, 9550SH BSN 700201), 9560, 9560SH, 9600, 9610, 9650 BSN 700301, 9650CTS BSN 700401, 9650STS BSN 700501, 9750STS BSN 700601, CTS, CTS II	Ball Bearing, Feed Reverser Gearbox	AMJD10011	\$ 30.42	
8820, 9600, 9610	Lower Feederhouse Shaft 91.44" Long	AMAH97643	\$ 375.00	
(9400 ASN 660100, 9410 BSN 680232, 9450 BSN 700101, 9500, 9510, 9550 BSN 700201 - w/ Contour-Master™), 9650CTS BSN 700401, 9650STS BSN 700501, 9750STS BSN 700601, CTS, CTS II	Lower Feederhouse Shaft 83.69" Long	AMAH152937	\$ 340.00	
9400 ASN 660101, 9410 BSN 680231, 9500, 9510, CTS ASN 660401, CTS II - w/ Contour-Master™	Lower Feederhouse Shaft 83.62" Long	AMAH136873	\$ 961.08	
9450 ASN 700100, 9550 ASN 700200, 9550SH ASN 700200 w/ Standard Reverser, 9560, 9560SH, 9650CTS ASN 700400, 9650STS ASN 700500 w/ Standard or High Capacity Reverser, 9660CTS, 9660STS, (9670STS, 9770STS BSN 730100 w/ High Torque and Variable High Torque Drive or BSN 735100 w/ Fixed Reverser and Variable Drive), 9750STS w/ Standard Reverser or ASN 700600 w/ High Capacity Reverser, 9760STS, 9860STS, 9870STS BSN 730100	Lower Feederhouse Shaft 70.81" Long Replaces H234410, H234555	AMH202940	\$ 425.95	
9670STS SN 730101-735100, (9770STS w/ Standard Multi-Speed Drive or SN 730101-735100 w/ High Torque Multi-Speed Drive), (9870STS w/ Multi-Speed Drive or SN 730101-735100 w/ Fixed Reverser)	Lower Feederhouse Shaft 70.81" Long Replaces H234556	AMH224011	\$ 445.05	
9550, 9650, 9650CTS, 9650STS, 9750STS - w/ High Capacity	Feederhouse Sheave, Inner 2.128" ID, 12.524" OD	AMH158575	\$ 297.50	
9600, 9610, 9650 BSN 700300	Front Shaft, Variable Drive Sheave 94.50" Long	AMAH152939	\$ 367.00	
9560, 9560SH, 9560STS, 9570STS, 9660, 9660CTS, 9660STS, 9670STS, 9760STS, 9770STS, 9780CTS ASN 074502, 9860STS, C670, S550 SN 745100-764999, S650 SN 765000-785000, S660 ASN 745100, S670 SN 105000-109999, S760, T550, T560, T660, T670	Feederhouse Input Gear 21 Tooth, 7.06" Long	AMH207015	\$ 246.00	

John Deere®—Combine

Application	Description	Part Number	Retail Price	Core
9400, 9410, 9450, 9500, 9510, 9510SH, (9550, 9550SH, 9560, 9560SH, 9560STS, 9570STS, 9650, 9650CTS, 9660, 9660CTS, 9660STS, 9670STS, 9760STS, 9770STS - w/ Standard Capacity), 9600, 9610, 9650STS, CTS, CTS II	Pulley Assembly, Variable Speed 4.878" ID, 12.508" OD For Outer Half Sheave Replaces, H97329, H107735, AH15793	AMAH201417	\$ 204.00	
9550, 9650CTS, 9650STS, 9750STS	Pulley Assembly, Variable Speed High Capacity 4.878" ID, 12.51" OD For Outer Half Sheave	AMAH201415	\$ 204.00	
9660STS, 9670STS, 9760STS, 9770STS, 9860STS, 9870STS, S650 SN 765000-785000, (S660, S670 ASN 745100), (S680, S690 SN 745100-785000)	Half Sheave High Torque	AMAH219367	\$ 537.00	
(9560, 9560STS, 9570STS, 9660, 9660CTS, 9660STS, 9760STS - w/ High Capacity), 9860STS BSN 715601	Half Sheave, Variable Speed 4.878" ID, 14.17" OD Replaces AH201889	AMAH204587	\$ 346.17	
9450 ASN 700101, 9550, 9560, 9560STS, 9570STS, 9650, 9650CTS, 9650STS BSN 700500, 9660, 9660CTS, 9660STS, 9670STS, 9750STS BSN 700600, 9760STS, 9770STS, 9860STS, C670, S550 SN 745100-764999, S650 ASN 765000, S660 ASN 745100, T550, T560, T660, T670	Gear 40 Tooth	AMH170781	\$ 545.00	
6620, 7720, 8820, 9400, 9410, 9450 BSN 700101, 9500, 9500SH, 9510, 9510SH, (9550, 9550SH BSN 700201), 9650 BSN 700301, 9650CTS BSN 700401, 9650STS BSN 700501, 9750STS BSN 700601	Needle Bearing, Feed Reverser/Feed Roll Gearbox	AMJD8819	\$ 14.12	
8820, 9600, 9610	Coupler Sprocket 14 Tooth 2.697" Long, 1.172" Bore Diameter For Size 60 Chain	AMAH96938	\$ 37.00	

Cylinder Bars and Components

All bars are carefully checked and sets are matched for equal weight distribution on the cylinder prior to shipment. Grade 8 fasteners are supplied for most models.



Application	Description	Part Number	Retail Price	Core
105	Cylinder Bar Kit	AMAH65107	\$ 368.47	
4400, 4420	Cylinder Bar Kit	AMAH75125	\$ 535.38	
4425, 4435	Cylinder Bar Kit	AMOJD-4425	\$ 533.51	
6600, 6601, 6602, 6620, 6620 Titan II, 6622, 6622 Titan II	Cylinder Bar Kit	Hardened AMAH75104	\$ 596.41	
		Chrome AMAH126545	\$ 739.00	
7700, 7701, 7720, 7720 Titan II, 7721	Cylinder Bar Kit	Hardened AMAH132976	\$ 613.22	
		Chrome AMAH132978	\$ 770.21	
8820, 8820 Titan II	Cylinder Bar Kit	Standard AMOJD-8820	\$ 647.66	
		Hardened AMAH132980	\$ 830.77	
		Chrome AMAH132982	\$ 996.00	
9400, 9500, 9450, 9550, 9410, 9510, 9650CTS, CTS, CTS II - 2 Rows of Holes	Cylinder Bar Kit	Hardened AMAH139432	\$ 766.48	
		Chrome AMAH134144	\$ 973.33	
9400, 9410, 9450, 9500, 9510, 9550, 9560, 9650CTS, 9660CTS, CTS, CTS II - 1 Row of Holes	Cylinder Bar Kit	Hardened AMAH205118	\$ 595.03	
		Chrome AMAH205120	\$ 802.32	
9600, 9610, 9650, 9660 - 2 Rows of Holes	Cylinder Bar Kit	Hardened AMAH139430	\$ 891.98	
		Chrome AMAH134142	\$ 1192.16	

John Deere®—Combine

John Deere®—Combine

Application	Description	Part Number	Retail Price	Core
9600, 9610, 9650, 9660 - 1 Row of Holes	Cylinder Bar Kit	Hardened AMAH161398	\$ 715.44	
		Chrome AMAH161390	\$ 962.18	
7700, 7720 BSN 556301	Cylinder Drive Shaft 3 Spline, 65.31" Long	AMH79642	\$ 499.56	
7720 ASN 556301	Cylinder Drive Shaft 29 Tooth, 67.81" Long	AMH110458	\$ 679.90	
7720 ASN 610501	Cylinder Drive Shaft 3 Spline, 65.37" Long	AMH123134	\$ 393.80	
8820 BSN 564101	Cylinder Drive Shaft 3 Tooth, 76.12" Long Replaces H93940	AMH99888	\$ 445.68	
8820 ASN 564101	Cylinder Drive Shaft 29 Spline, 78.75" Long	AMH117565	\$ 630.99	
9400, 9410, 9450, 9500, 9500SH, 9510, 9510SH, 9550, 9550SH, 9560, 9560SH, 9650CTS, 9660CTS, CTS, CTS II	Cylinder Filler Plate, Perforated Replaces H150837	AMH150837	\$ 104.00	
9600, 9610, 9650, 9660	Cylinder Filler Plate, Perforated Replaces H150836	AMH150836	\$ 115.00	
9400, 9410, 9450, 9500SH, 9510SH, 9550, 9550SH, 9560, 9560SH, 9650CTS, 9660CTS	Threshing Cylinder Shaft, Dual Range 69.50" Long	AMH140043	\$ 696.86	
9600, 9610, 9650, 9660	Threshing Cylinder Shaft, Dual Range 80.31" Long	AMH140042	\$ 817.13	
9400, 9500, 9510, 9510SH, 9550, 9550SH, 9560, 9560SH, 9650CTS, 9660CTS, CTS, CTS II ASN 655541	Threshing Cylinder Shaft, Single Range 67" Long Replaces H127972	AMH145970	\$ 696.83	
9600, 9610, 9650, 9660	Threshing Cylinder Shaft, Single Range 77.87" Long Replaces H127971	AMH145969	\$ 687.35	



Rotor Assemblies

Application	Description	Part Number	Retail Price	Core
9650STS, 9660STS, 9670STS, 9750STS, 9760STS, 9770STS, 9860STS, 9870STS, S650, S660, S670, S670HM, S680, S680HM, S690, S690HM	Reman STS Bullet Rotor For Grain & Corn Additional elements and tines required for Rice	AMAXE24832	\$ 7075.00	\$ 500.00









Rotor Components

Application	Description	Part Number	Retail Price	Core
9650STS, 9660STS, 9750STS, 9760STS, 9860STS	Front Rotor Flight, Set of 3	AMAH204533	\$ 265.00	







John Deere®—Combine

John Deere®—Combine

Application	Description	Part Number	Retail Price	Core
 9650STS, 9660STS, 9750STS, 9760STS, 9860STS	Rear Rotor Flight, Set of 3	AMAH204534	\$ 265.00	
 9660STS, 9670STS, 9760STS, 9770STS, 9860STS, 9870STS, S660, S670, S680, S690, S760, S770, S780, S790	Threshing Element, Set of 3 High Wear, Tungsten Carbide Coated Bullet Rotor 3rd, 4th, 5th Rows, Marked H215532 For Bullet™ or TriStream™ Rotors	AMAH216678	\$ 250.00	
 9650STS, 9660STS, 9670STS, 9750STS, 9760STS, 9770STS, 9860STS, 9870STS, S650, S660, S670, S670HM, S680, S680HM, S690, S690HM, S760, S770, S780, S790	Threshing Element, Set of 3 Tungsten Carbide Coated Bullet Rotor 2nd Row, Marked H212563 For Bullet™ or TriStream™ Rotors for Corn and Grain	AMAH216675	\$ 360.00	
 9650STS, 9660STS, 9750STS, 9760STS, BSN 712197, 9860STS BSN 000724	Threshing Element, Set of 3 Standard Rotor, Marked H173240 (5) Sets Required for Corn and Grain (9) Sets Required for Rice	AMAH167739	\$ 140.00	
 9650STS, 9660STS, 9670STS, 9750STS, 9760STS, 9770STS, 9860STS, 9870STS, S650, S660, S670, S670HM, S680, S680HM, S690, S690HM, S760, S770, S780, S790	Threshing Element, Set of 3 High Wear, Tungsten Carbide Coated Bullet Rotor 1st Row, Marked H212563 For Bullet™ or TriStream™ Rotors for Corn and Grain	AMAH216674	\$ 550.00	
 9660STS, 9670STS, 9760STS, 9770STS, 9860STS, 9870STS, S650, S660, S670, S670HM, S680, S680HM, S690, S690HM	Threshing Element, Ribbed, Set of 3 Marked H205999 Bullet Rotor 3rd, 4th, 5th Rows	AMAH216677	\$ 170.00	
(9660STS, 9760STS BSN 712198), 9860STS BSN 000724	Threshing Element, Set of 3 Standard Rotor, 2-Piece Smooth High Wear, Chrome Plated, Hardened	AMAH209118	\$ 223.15	
 9560STS, 9660STS, 9670STS, 9750STS, 9760STS, 9770STS, 9860STS, 9870STS	Separator Tines, Set of 3 High Wear	AMAH209123	\$ 168.62	
 (9650STS, 9670STS, 9750STS, 9770STS - Rice), 9660STS, 9760STS, 9860STS, 9870STS, S650, (S660, S670, S760, S770 - Excluding Rotors w/o Dense Pack), S680, S680HM, S690, S690HM, S780, S790	Separator Tines, Set of 3 Extended Wear, Tungsten Carbide Coated Marked H230288 For Bullet™ or TriStream™ Rotors Includes Hardware (8) Sets Required for Corn and Grain (9) Sets Required for Rice Replaces AH221387	AMAH228817	\$ 175.00	
 9650STS, 9660STS, 9750STS, 9860STS, 9880STS, S660, (S670, S680, S690, S760, S770 - w/ TriStream™ Rotor), S670HM, S690HM	Separator Tines, Set of 3 (8) Sets Required for Corn and Grain (9) Sets Required for Rice	AMAH208554	\$ 73.00	
9560STS, 9570STS, S550	Floor	AMH208676	\$ 190.00	
9560STS, 9570STS	Vane Transport Cover High Wear Replaces AH213327	AMAH213325	\$ 385.95	
9560STS, 9570STS	Separator Top Cover High Wear Replaces AH204327	AMAH213327	\$ 1066.87	

Prices Subject to Change without Prior Notice. The use of original equipment manufacturer (OEM) part numbers or trademarks, e.g. Case® and John Deere®, are for reference purposes only and for indicating product use and compatibility. Our company and the listed replacement parts contained herein are not sponsored, approved or manufactured by the OEM. All parts are New unless designated Reman in the description.

John Deere®—Combine

	Application	Description	Part Number	Retail Price	Core
	9650STS, 9660STS, 9670STS, 9750STS, 9760STS, 9770STS, 9860STS, 9870STS, S650, S680, S660, S670, S670HM, S680HM, S690, S690HM, S760, S770, S780, S790	Vane Transport Cover Replaces AH168166, AH171320, AH202853	AMAH208966	\$ 415.00	
	9650STS, 9660STS, 9670STS, 9750STS, 9760STS, 9770STS, 9860STS, 9870STS	Separator Top Cover Replaces AH146891	AMAH171322	\$ 776.48	
	9650STS, 9750STS	Separator Top Cover Replaces AH171321, AH202855, AH207382	AMAH235314	\$ 811.98	
	9660STS, 9670STS, 9760STS, 9770STS, 9860STS, 9870STS	Separator Top Cover Replaces AH207683	AMAH208573	\$ 836.41	
	9660STS, 9670STS, 9760STS, 9770STS, 9860STS	Separator Module Rail, Right Hand	AMAH205325	\$ 580.00	
	9650STS BSN 696896, 9750STS BSN 696325	Dust Cover Replaces H173329	AMAH201702	\$ 121.93	
	9650STS, 9660STS, 9670STS, 9750STS, 9760STS, 9770STS, 9860STS, 9870STS, S650, S660, S670, S670HM, S680, S680HM, S690, S690HM, S760, S770, S780, S790	Front Flight Repair Kit, Bullet Rotor Marked H217239 For Bullet™ or TriStream™ Rotors for Corn and Grain	AMAH216568	\$ 450.00	
	9650STS, 9660STS, 9670STS, 9750STS, 9760STS, 9770STS, 9860STS, 9870STS, S650, S660, S670, S670HM, S680, S680HM, S690, S690HM, S760, S770, S780, S790	Rear Flight Repair Kit, Bullet Rotor For Bullet™ or TriStream™ Rotors for Corn and Grain	AMAH216569	\$ 490.00	
	9560STS, 9570STS, 9650STS, 9660STS, 9750STS, 9760STS, 9860STS	Round Nut Retainer Sold in Multiples of 2, Priced Individually	AME80202	\$ 5.23	
	9560, 9560SH, (9650STS, 9750STS ASN 000181), 9660, 9660CTS, 9660STS, 9760STS, 9860STS, 9880STS ASN 705801	Fan Speed Actuator	AMAH170587	\$ 65.00	
	9560STS, 9570STS, 9650STS, 9660STS, 9670STS, 9750STS, 9760STS, 9770STS, 9860STS, 9870STS, S550, S660, S670, S680, S690	Rotor Drive Coupling	AMAH150405	\$ 308.00	
	9560STS, 9570STS, 9650STS, 9660STS, 9670STS, 9750STS, 9760STS, 9770STS, 9860STS, 9870STS, S550, S560, S660, S670, S680, S690	Rubber Seal	AMH226877	\$ 12.04	
	9560STS, 9570STS, 9650STS, 9660STS, 9670STS, 9750STS, 9760STS, 9770STS, 9860STS, 9870STS, S550, S650, S660, S670, S680, S690, S760, S770, S780, S785, S790	Rubber Seal	AMH158766	\$ 4.08	

John Deere®—Combine

Application	Description	Part Number	Retail Price	Core
9650STS, 9660STS, 9670STS, 9750STS, 9760STS, 9770STS, 9860STS, 9870STS, S650, S660, S670, S670HM, S680, S680HM, S690, S690HM, S760, S770, S780, S790	Rotor Nose Spider Repair Kit For Bullet™, TriStream™ or Variable Stream Rotor Replaces AH161700, AH229285	AMKXE10164	\$ 462.46	



Concaves and Components

Application	Description	Part Number	Retail Price	Core
4400 ASN 9501, 4420* *Retainer Required When Switching 14 to 13 Bar Concave	Concave, 13 Cross Bars	AMAH85396-13	\$ 711.49	
(6600, 6601 ASN 11501), 6602, 6620*, 6620 Titan II*, 6621*, 6622 *AMH116274 Retainer Required When Switching 14 to 13 Bar Concave	Concave, 13 Cross Bars	AMAH108864	\$ 730.00	
	Retainer	AMH116274	\$ 56.50	
(7700, 7701 ASN 8001), 7720*, 7720 Titan II*, 7721* *AMH116275 Retainer Required When Switching 14 to 13 Bar Concave	Concave, 13 Cross Bars	AMAH105066	\$ 905.00	
	Retainer	AMH116275	\$ 58.45	
8820*, 8820 Titan II* *AMH116276 Retainer Required When Switching 14 to 13 Bar Concave	Concave, 13 Cross Bars	AMAH113444	\$ 1150.00	
	Retainer	AMH116276	\$ 76.60	
9400, 9410, 9450, 9500, 9510, 9550, 9560, 9650CTS, 9660CTS, CTS, CTS II	Concave, 13 Cross Bars OEM Style short wire w/ wires in first half of concave - 27 3/4" diameter	AMAH150497	\$ 955.00	
	Concave Front Angle	AMAH151119	\$ 240.00	
9560STS, 9570STS, S550	Concave, Front, Round Bar	AMAH206174	\$ 615.00	
	Concave, Front, Small Wire High Wear	AMAH213234	\$ 1432.47	
	Concave, Middle/Rear, Round Bar High Wear	AMAH206455	\$ 600.00	
	Concave, Middle/Rear, Small Wire High Wear	AMAH213235	\$ 1153.42	
	Concave, Middle/Rear, Large Wire High Wear	AMAH206123	\$ 609.57	
	Concave Set, Small Wire, Set of 3 Replaces AH205488, AH205487	AMAH205488-SET	\$ 2150.00	
	Concave, Front, Large Wire Standard Wear	AMAH206122	\$ 600.00	
	Concave, Front, Small Wire Standard Wear	AMAH205487	\$ 830.00	
9600, 9610, 9650, 9660	Concave, 13 Cross Bars OEM Style short wire w/ wires in first half of concave - 27 3/4" diameter	AMAH150496	\$ 1275.00	
	Concave Front Angle	AMAH151118	\$ 315.00	

John Deere®—Combine

Application	Description	Part Number	Retail Price	Core
9650STS*, 9660STS, 9670STS, 9750STS*, 9760STS, 9770STS, 9860STS, 9870STS, S650, S660, S670, S670HM, S680, S680HM, S690, S690HM, S760, S770, S780, S790 *Requires AMAH210894 Latch Kit to install	Concave, Small Wire, Set of 3	AMBXE10389	\$ 2340.00	
	Concave, Front, Small Wire High Wear	AMAXE28960	\$ 860.00	
	Concave Lip	AMX27517	\$ 80.00	
	Concave, Middle/Rear, Small Wire High Wear	AMAXE28961	\$ 680.00	
	Concaves, Large Wire, Set of 3	AMBXE10391	\$ 2275.00	
	Concave, Front, Large Wire High Wear	AMAXE28965	\$ 1045.00	
	Concave Lip	AMX27517	\$ 80.00	
	Concave, Middle/Rear, Large Wire High Wear	AMAXE28966	\$ 1000.00	
9650STS*, 9660STS, 9670STS, 9750STS*, 9760STS, 9770STS, 9860STS, 9870STS, S650, S660, S670, S670HM, S680, S680HM, S690, S690HM, S760, S770, S780, S790 *Requires AMAH210894 Latch Kit to install	Concaves, Round Bar, Set of 3	AMBH84226	\$ 1920.00	
	Concave, Front Round Bar	AMAH205261	\$ 695.00	
	Concave Lip	AMX27517	\$ 80.00	
	Concave, Middle/Rear Round Bar	AMAH206456	\$ 625.00	
9650STS*, 9660STS, 9670STS, 9750STS*, 9760STS, 9770STS, 9860STS, 9870STS, S650, S660, S670, S670HM, S680, S680HM, S690, S690HM, S760, S770, S780, S790 *Requires AMAH210894 Latch Kit to install	Helical Concave, Front, Small Wire	AMAH205254H	\$ 1125.00	
9650STS, 9660STS, 9670STS, 9750STS, 9760STS, 9770STS, 9860STS, 9870STS, S650, S660, S670, S670HM, S680, S680HM, S690, S760, (S770, S780, S790 BSN 805001)	Concave Insert Replaces AH158835, AH168438	AMAH204423	\$ 367.84	
9650STS, 9660STS, 9750STS, 9760STS, 9770STS, 9860STS, 9870STS	Concave Cover Plate Set, Set of 3 For Narrow and Wide Concaves	AMBH81876	\$ 190.36	
9650STS, 9660STS, 9670STS, 9750STS, 9760STS, 9770STS, 9860STS, 9870STS	Concave Latch Kit Required when using 60 Series STS Concaves on a 50 Series STS Combine	AMAH210894	\$ 39.87	
	Concave Shock Kit Required when using 60 Series STS Concaves on a 50 Series STS Combine	AMCSK-ST5	\$ 218.02	
9400, 9410, 9450, 9500, 9510, 9510SH, 9550, 9550SH, 9560, 9560SH, CTS II	Concave Grate Use w/ AMAH150497 Concave	AMAH151121	\$ 473.76	
9400, 9410, 9450, 9500, 9500SH, 9510, 9510SH, 9550, 9550SH, 9560, 9560SH, 9650CTS, 9660CTS, CTS, CTS II	Concave Grate, Spike Tooth	AMAH131331	\$ 414.87	
9600, 9610, 9650, 9660	Concave Grate, Spike Tooth	AMAH131330	\$ 432.47	
9650STS, 9660STS, 9670STS, 9750STS, 9760STS, 9770STS, 9860STS, 9870STS, S650, S660, S670, S670HM, S680, S680HM, S690, S690HM	Concave Grate Cover Replaces AXE50778	AMAH170741	\$ 37.50	
S660, S670, S680, S690, S760, S770, S780, S785, S790	Concave Grate Filler Cover Heavy Duty Replaces AXE21144	AMAXE50779	\$ 33.39	
9660STS, 9760STS, 9860STS, 9870STS	Separator Grate Corn and Rice This is the earlier design corn cob mixer grate that uses only two carriage bolts on the replacement fingers	AMAH223656	\$ 1177.29	
9650STS, 9750STS, 9650STS, 9660STS, 9670STS, 9750STS, 9760STS, 9770STS, 9860STS, 9870STS, 9880STS, S540, S550, S560, S650, S660, S670, S680, S690, S760, S770, S780, S785, S790	Concave Latch Mechanism Handle	AMH206715	\$ 25.04	

John Deere®—Combine

John Deere®—Combine

Application	Description	Part Number	Retail Price	Core
9400, 9410, 9450, 9500, 9510, 9510SH, 9550, 9550SH, 9560, 9560SH, 9650, 9650CTS, 9660, 9660CTS	Concave Link Replaces H127986, H147484	AMH151484	\$ 38.02	
9400, 9410, 9450, 9500, 9500SH, 9510, 9510SH, 9550, 9550SH, 9560, 9560SH, 9650CTS, 9660CTS, CTS II	Concave Grate Rod Replaces H131002	AMH140803	\$ 57.50	
9650STS, 9660STS, 9670STS, 9750STS, 9760STS, 9770STS, 9860STS, 9870STS, S650, S660, S670, S670HM, S680, S680HM, S690, S690HM, S760, S770, S780, S790	Concave Support Plate Replaces AH146662, AH166173, AH201079, AXE59657	AMAH215091	\$ 225.00	
(S660, S670, S680, S690 ASN 775001)	Concave Support	AMAXE40868	\$ 320.00	
9410, 9450, 9510, 9510SH, 9550, 9550SH, 9560, 9560SH, 9600, 9610, 9650, 9650CTS, 9660, 9660CTS, CTS, CTS II, S660, S670, S670HM, S680, S680HM, S690, S690HM, S760, S770, S780, S790	Concave Actuator Replaces AH134728, AH160107	AMAH170291	\$ 525.00	
9400, 9410, 9450, 9500, 9510, 9510SH, 9550, 9550SH, 9560, 9560SH, 9600, 9610, 9650, 9650CTS, 9660, 9660CTS, CTS, CTS II	Concave Cam, Right Hand Replaces AH133156, H132821	AMH178115	\$ 184.34	
	Concave Cam, Left Hand	AMAH133157	\$ 185.38	
9400, 9410, 9450, 9500, 9500SH, 9510, 9510SH, 9550, 9550SH, 9560, 9560SH, 9650CTS, 9660CTS, CTS, CTS II	Concave Torque Shaft 53.50" Long Replaces H133632	AMH145639	\$ 213.58	
9600, 9610, 9650, 9660	Concave Torque Shaft 64.44" Long	AMH145638	\$ 271.16	
9410, 9450, 9510, 9510SH, 9550, 9550SH, 9560, 9560SH, 9560STS, 9570STS, 9600, 9610, 9650, 9650CTS, 9650STS, 9660, 9660CTS, 9660STS, 9670STS, 9750STS, 9760STS, 9770STS, 9860STS, 9870STS, CTS II	Deck Plate Indicator Shaft	AMR111692	\$ 30.27	
6620, 7720, 8820	Flange Bolt, Adjusting Replaces AH90840, AH127710	AMAH171838	\$ 105.19	
9400, 9410, 9500, 9510, 9510SH, 9600, 9610, 9650, 9660	Concave Eyebolt 7.08" Long, M16x2.00" Right Hand Thread Replaces H115179	AMH143610	\$ 14.77	
9400, 9410, 9450, 9500, 9510, 9510SH, 9550, 9550SH, 9560, 9560SH, 9600, 9610, 9650, 9650CTS, 9660, 9660CTS, CTS	Concave Insert Replaces AH143744, AH153688, AH171207	AMAH206756	\$ 16.19	
9560STS, 9570STS, 9650STS, 9670STS, 9750STS, 9770STS, 9860STS, 9870STS, S660 SN 765000-785000	Concave Adjusting Actuator	AMAXE13829	\$ 100.00	
9660STS ASN 715739, 9670STS, 9760STS ASN 715819, 9770STS, 9870STS, S660, S670, S670HM, S680, S680HM, S690, S690HM, S760, S770, S780, S785, S790	Concave Adjusting Gear 9 Tooth	AMH223940	\$ 52.50	
9560STS, 9570STS, 9650STS, 9660STS ASN 715739, 9750STS, 9760STS ASN 715819, 9860STS, S550	Concave Adjusting Gear 11 Tooth	AMH152305	\$ 157.00	
9560STS, 9570STS, 9660STS, 9670STS, 9760STS, 9770STS, 9860STS, 9870STS, S550 SN 745100-764999, S650 ASN 765000, (S660, S670, S680, S690 ASN 745100), (S670HM, S680HM BSN 765000), S690HM SN 745101-765000, S760, S770, S780, S785, S790	Concave Adjusting Worm Gear Replaces AH171768	AMAH224006	\$ 287.00	

Primary Countershafts and Components



Application	Description	Part Number	Retail Price	Core
4400, 4420	Primary Countershaft 63.25" Long	AMH114617	\$ 422.39	

Prices Subject to Change without Prior Notice. The use of original equipment manufacturer (OEM) part numbers or trademarks, e.g. Case® and John Deere®, are for reference purposes only and for indicating product use and compatibility. Our company and the listed replacement parts contained herein are not sponsored, approved or manufactured by the OEM. All parts are New unless designated Reman in the description.

John Deere®—Combine

John Deere®—Combine

Application	Description	Part Number	Retail Price	Core
6600	Primary Countershaft 70.187" Long	AMH89308	\$ 487.59	
6620	Primary Countershaft 66.625" Long	AMH93647	\$ 568.64	
7700	Primary Countershaft 81" Long	AMH89309	\$ 485.07	
7720	Primary Countershaft 77.50" Long	AMH99253	\$ 495.15	
8820	Primary Countershaft 88.375" Long	AMH99739	\$ 556.59	
9400, 9410, 9500, 9500SH, 9510, 9510SH, CTS, CTS II	Primary Countershaft 81.12" Long	AMH147483	\$ 1172.13	
9450, 9550, 9550SH, 9560, 9560SH, 9650CTS, 9660CTS	Primary Countershaft 29 Tooth, 80.19" Long	AMH163279	\$ 742.27	
9560STS, 9570STS, S550	Primary Countershaft 29 Tooth, 61.69" Long	AMH202801	\$ 682.14	
9600, 9610	Primary Countershaft 92" Long	AMAH122240	\$ 1100.00	
9650, 9660	Primary Countershaft 91" Long	AMAH156738	\$ 1375.73	
9650STS*, (9660STS*, 9760STS BSN 710500), 9670STS, 9750STS*, 9770STS, 9860STS* BSN 710700, 9870STS, S650, S660, S670, S670HM, S680, S680HM, S690, S690HM, S760, S770, S780, S790 *Will require additional parts to fit: H214619 Bracket, AH213902 Bearing w/ Housing, (4) 19M7793 M16x40 mm Screws and (4) 14M7291 Flange Nuts	Primary Countershaft 72.31" Long Replaces H161599	AMH214618	\$ 624.51	
9400, 9410, 9450, 9500, 9500SH, 9510, 9510SH, 9550, 9550SH, 9560, 9560SH, 9600, 9610, 9650, 9650CTS, 9660, 9660CTS, CTS, CTS II	Primary Countershaft Housing 36 Tooth	AMH127196	\$ 425.85	
	Inner Sheave 4.35" Wide, 16.732" OD, 4.952" Bore Diameter	AMH115755	\$ 436.04	
9400, 9410, 9450, 9500, 9510, 9550, 9550SH, 9560, 9560SH, 9600, 9610, 9650, 9650CTS, 9660, 9660CTS, CTS, CTS II	Inner Sheave 36 Spline, 10.87" Long Replaces AH122685	AMAH141820	\$ 683.72	
9560, (9560STS, 9570STS, 9660, 9660CTS, 9670STS - w/ High Capacity), 9760STS, 9860STS, S550, S650, S660, S760	Outer Half Sheave	AMH204872	\$ 650.00	
4425, 4435, 6600, 6620, 7700, 7720	Traction Drive Pulley, Inner	AMH84666	\$ 200.00	
6600 ASN 156501, 6620, 7700 ASN 111901, 7720	Reman Pulley Posi-Torq™ Ground Drive Upper Unit	AMAH86983	\$ 1250.00	\$ 100.00
9400, 9410, 9450, 9500, 9500SH, 9510, 9510SH, 9550, 9550SH, 9560, 9560SH, 9560STS, 9570STS, 9600, 9610, 9650, 9650CTS, 9650STS, 9660STS, 9670STS, 9750STS, 9760STS, 9770STS, 9860STS, 9870STS, S550, S650, S660, S670 BSN 785001	Idler Pulley, Primary Countershaft Drive 7.992" Diameter, 1.437" Overall Width, 0.637" Bore Diameter, 1" Groove Width Replaces AH85276, AH165366	AMAH97031	\$ 33.07	
9400, 9410, (9500, 9500SH ASN 646620), 9510, 9510SH, 9600, 9610, CTS, CTS II	Header Electromagnetic Clutch Pulley 14.567" Diameter, 2.50" Bore, 0.512" Crosshole Diameter, 1.259" Groove Width Replaces AH121657	AMAH139936	\$ 359.57	
9450, 9550, 9550SH, 9560SH, 9560STS, 9570STS, 9650, 9650CTS, 9650STS, 9660, 9660CTS, 9660STS, 9750STS, 9760STS, 9770STS, 9860STS, S550 SN 745100-764999, S650 (ASN 765000), (S660, S670 ASN 745100), S680 SN 766007-785000, S690 SN 765250-785000, S760, S770	Hydraulic Cylinder	AMAH213758	\$ 225.00	
3300, 4400, 4420, 6600, 6620, 7700, 7720, 8820, 9400, 9410, 9450, 9500, 9510, 9550, 9560, 9600, 9650CTS, 9660CTS	Ball Bearing	AMJD8669	\$ 150.00	

John Deere®—Combine

Application	Description	Part Number	Retail Price	Core
9400, 9410, 9450, 9501, 9550, 9550SH, 9600, 9610, 9650, 9650CTS, 9660, CTS	Bearing Housing	AMH133618	\$ 100.00	
9400, 9410, 9450, 9500, 9500SH, 9510, 9510SH, 9550, 9550SH, 9560, 9560SH, 9600, 9610, 9650, 9650CTS, 9780CTS ASN 720800, C670, CTS, CTS II, T550, T560, T660, T670	Bushing 4.256" ID, 4.815" OD, 1.181" Long Replaces H123557	AMH148131	\$ 42.62	
9660STS, 9760STS, 9770STS, 9860STS, 9870STS, S650, S660, S670, S680, S680HM, S690, S690HM, S760, S770, S780, S785, S790	Dipstick, Primary Countershaft Gearbox Replaces AH168685, AH173466	AMAXE23425	\$ 39.28	

Secondary Countershafts and Components



Application	Description	Part Number	Retail Price	Core
6620	Secondary Countershaft 63.75" Long, Splined	AMH94126	\$ 223.60	
7720	Secondary Countershaft 74.625" Long, Splined	AMH94127	\$ 207.87	
8820	Secondary Countershaft 85.437" Long, Splined	AMH93475	\$ 237.51	
6620*, 7720, 8820 *Must replace both Inner and Outer Sheaves	Inner Sheave	AMH93503	\$ 74.20	
4400, 4420, 6620*, 7720, 8820 *Must replace both Inner and Outer Sheaves	Outer Sheave	AMH100794	\$ 82.82	
9560STS, 9570STS, 9650STS, 9660STS, 9670STS, 9750STS, 9760STS, 9770STS, 9860STS, 9870STS, S550, S650, S660, S670, S670HM, S680, S680HM, S690, S690HM, S760, S770, S780, S785, S790	Idler 6.50" OD, 2.25" Wide, 0.698" Hole Diameter For Feed Accelerator and Secondary Jackshaft	AMAH150900	\$ 56.16	
9400, 9450, 9500, 9500SH, 9510, 9510SH, 9550, 9550SH, 9560, 9560SH, 9600, 9610, 9650, 9650CTS	Idler Pulley, Secondary Countershaft Drive 7.992" Diameter, 1.437" Overall Width, 0.637" Bore Diameter, 1" Groove Width Replaces AH85276, AH165366	AMAH97031	\$ 33.07	
7720, 8820	Bearing, Secondary Countershaft 2.8346" OD, 1.25" Round Bore Replaces AH10515, JD9316	AMG1104KRRB-I	\$ 25.58	

Cylinder Drive Components

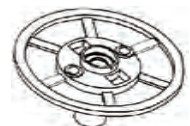

Application	Description	Part Number	Retail Price	Core
9400, 9410, 9450, 9500, 9510, 9510SH, 9550, 9550SH, 9560, 9560SH, 9650, 9650CTS, 9660, 9660CTS, CTS, CTS II	Cylinder Drive Intermediate Shaft 15.75" Long Replaces H115596	AMH148241	\$ 271.15	
6600, 6601, 6602, 7700, 7701	Variable Speed Sheave For Primary Countershaft Includes (2) R27899 Bushings	AMAH84886-N	\$ 325.00	
9400, 9410, 9450, 9500, 9500SH, 9510, 9510SH, 9550, 9550SH, 9560, 9560SH, 9600, 9610, 9650, 9650CTS, 9660, 9660CTS	Half Sheave 16.732" OD, 2" Bore Diameter For Dual Range Cylinder Drive Replaces H115599	AMH145955	\$ 421.60	
9400, 9410, 9450, 9500, 9510, 9550, 9550SH, 9510SH, 9560, 9560SH, 9600, 9650, 9650CTS, 9660, 9660CTS	Inner Sheave 6.07" Long, 16.74" Wide For Dual Range Cylinder Drive Replaces H125530, H144038	AMAH141973	\$ 503.65	

John Deere®—Combine

Application	Description	Part Number	Retail Price	Core
9400, 9410, 9450, 9550, 9550SH, 9650CTS	Cylinder Drive Sheave 7.598" OD For Extended Range Cylinder Drive Replaces H137574	AMH146395	\$ 215.40	
9400, 9410, 9450, 9550, 9550SH, 9650CTS	Outer Sheave Half 17.710" OD For Extended Range Cylinder Drive	AMH137580	\$ 514.39	
9400, 9410, 9500, 9500SH, 9510, 9510SH, 9550, 9550SH, 9560, 9560SH, 9600, 9610, 9650, 9650CTS, 9660, 9660CTS, CTS, CTS II	Cylinder Pulley, Slow Speed 4-Groove, 5.75" OD	AMH118616	\$ 144.25	
6600, 6620, 7700, 7720, 8820, 9400, 9410, 9450, 9500, 9510, 9550, 9560STS, 9570STS, 9600, 9610, 9650CTS, 9650STS, 9660CTS, 9660STS, 9670STS, 9750STS, 9760STS, 9770STS, 9860STS, 9870STS, 9880STS, S550, S650, S660, S670, S680, S690	Bearing Housing Used on feed accelerator and cylinder bar for conventional machines Replaces H75329	AMH203950	\$ 90.00	
9400, 9410, 9450, 9500, 9500SH, 9510, 9510SH, 9550, 9550SH, 9560, 9560SH, 9600, 9610, 9650, 9650CTS, 9660, 9660CTS, CTS, CTS II	Bearing w/ Lock Collar 3.937" OD, 2.105" Bore Diameter Use w/ AMH203950 Bearing Housing	AMJD10343	\$ 36.75	

Cleaning Fan Shafts and Components

Application	Description	Part Number	Retail Price	Core
6600*, 6620 *On models BSN 310500 fan sheaves must be replaced, See AMH97600 & AMAH100009	Cleaning Fan Shaft 54.75" Long	AMH108571	\$ 128.03	
7700*, 7720 *On models BSN 316000 fan sheaves must be replaced, See AMH97600 & AMAH100009	Cleaning Fan Shaft 65.625" Long	AMH108572	\$ 170.74	
8820	Cleaning Fan Shaft 77" Long	AMH108612	\$ 245.86	
8820	Bearing, Cleaning Fan Shaft Replaces JD9319	AMJD9275	\$ 24.15	
9400, 9410, 9450 BSN 690196, 9500, 9500SH, 9510, 9510SH, 9550 BSN 690669, 9550SH BSN 690701, 9650CTS BSN 690464, CTS, CTS II	Cleaning Fan Shaft 65.87" Long	AMH135396	\$ 425.52	
9400, 9410, 9500, 9510, 9510SH, CTS, CTS II	Cleaning Fan Shaft, Dust Fan 64.31" Long Replaces H164410	AMAH219997	\$ 484.95	
9450 ASN 690193, 9550 ASN 690669, 9550SH ASN 690701, 9560, 9560SH, 9650CTS ASN 690464, 9660CTS	Cleaning Fan Shaft, Narrow 64.19" Long	AMH174045	\$ 266.14	
9560STS, 9570STS	Cleaning Fan Shaft 55.12" Long Replaces AH228558	AMH202372	\$ 271.74	
9560STS, 9570STS, S550	Cleaning Fan Shaft 55.06" Long Replaces H179093	AMH201777	\$ 386.92	
9600, 9610, 9650	Cleaning Fan Shaft 76.75" Long Replaces H171316	AMAH131092	\$ 617.19	

John Deere®—Combine

John Deere®—Combine

Application	Description	Part Number	Retail Price	Core
9650STS ASN 690596, 9660STS, 9670STS, 9750STS SN 700602-700631, 9760STS, 9770STS, 9860STS, 9870STS, S650 SN 765000-785000, (S660, S670, S680, S690 SN 745100-785000), (S670HM, S680HM BSN 765000), S690HM SN 745101-765000	Cleaning Fan Shaft, Fan Drive 65.69" Long	AMH173376	\$ 376.31	
9650STS, 9750STS	Cleaning Fan Blade	AMH158420	\$ 54.10	
6600 ASN 301501, 6620, 7700 ASN 316001, 7720, 8820	Inner Fan Shaft Sheave	AMAH100009	\$ 127.94	
9400 ASN 670100, 9410, 9450, 9500 ASN 670200, 9510, 9510SH, 9550, 9550SH, 9560 BSN 705252, 9560SH BSN 705701, 9600 ASN 670300, 9610, 9650, 9650CTS, 9660 BSN 705332, 9660CTS BSN 705403, CTS ASN 670400, CTS II	Inner Fan Shaft Sheave 750-1350 RPM, 18.12" OD, 1.40" Bore	AMAH149356	\$ 377.41	
9400 ASN 670100, 9410, 9450, 9500 ASN 670200, 9510, 9510SH, 9550, 9550SH, 9560, 9560SH, 9600 ASN 670300, 9610, 9650, 9650CTS, 9660, 9660CTS, CTS BSN 670400, CTS II	Inner Fan Shaft Sheave 490-980 RPM, 12.99" OD, 1.37" Bore	AMAH149357	\$ 268.82	
9400 BSN 670100, 9500 BSN 670200, 9600 BSN 670300, CTS BSN 670400	Inner Fan Shaft Sheave 750-1350 RPM, 15.98" OD, 1.38" Bore Replaces H132298	AMAH134873	\$ 255.19	
9450 ASN 690196, 9550 ASN 690669, 9550SH ASN 690701, 9560, 9560SH, 9560STS, 9650 ASN 690730, 9650STS ASN 691595, 9660, 9660CTS, 9660STS, 9750STS ASN 691222, 9760STS, 9860STS, CTS ASN 690464	Inner Fan Shaft Sheave 10.16" OD	AMAH167535	\$ 182.43	
9570STS, 9650STS, 9670STS, 9750STS, 9770STS, 9870STS, S550, S650, (S660, S670, S680, S690 BSN 785001), (S670HM, S680HM, S690HM BSN 765000)	Inner Fan Drive Sheave 12.99" OD	AMH161051	\$ 268.40	
6600 ASN 301501, 6620, 7700 ASN 316001, 7720, 8820	Outer Fan Shaft Sheave	AMH97600	\$ 51.50	
9400, 9410, 9450, 9500, 9510, 9510SH, 9550, 9550SH, 9560, 9560SH, 9600, 9610, 9650, 9650CTS, 9660, 9660CTS, CTS, CTS II	Outer Fan Shaft Sheave 490-980 RPM 12.992" OD, 1.252" Bore Diameter Replaces AH146506	AMAH153040	\$ 99.00	
9400 ASN 670100, 9410, 9450 BSN 690197, 9500 ASN 670200, 9510, 9510SH, 9550 BSN 690670, 9550SH BSN 690701, 9600 ASN 670300, 9650 BSN 690731, 9650CTS BSN 690465, 9650STS BSN 691596, 9750STS BSN 691223, CTS ASN 670400, CTS II	Outer Fan Shaft Sheave 10.16" OD, 1.25" Bore	AMAH146462	\$ 203.30	
9450 ASN 690196, 9550 ASN 690669, 9550SH ASN 690701, 9560, 9560SH, 9560STS, 9570STS, 9650 ASN 690730, 9650CTS ASN 690454, 9650STS ASN 691595, 9660, 9660CTS, 9660STS, 9670STS, 9750STS ASN 691222, 9760STS, 9770STS, 9860STS ASN 700800, 9870STS, S550, S650, S660, (S670, S680, S690 BSN 785001), S670HM, S680HM, S690HM	Outer Fan Shaft Sheave 10.158" OD	AMAH167534	\$ 181.36	
9650STS, 9750STS	Outer Fan Shaft Sheave 12.99" OD	AMAH204179	\$ 334.97	
9400, 9500, 9501, 9600, CTS	Separator Fan Drive Sheave Cast # - H132299	AMAH127496	\$ 256.53	

Prices Subject to Change without Prior Notice. The use of original equipment manufacturer (OEM) part numbers or trademarks, e.g. Case® and John Deere®, are for reference purposes only and for indicating product use and compatibility. Our company and the listed replacement parts contained herein are not sponsored, approved or manufactured by the OEM. All parts are New unless designated Reman in the description.

John Deere®—Combine

John Deere®—Combine

Application	Description	Part Number	Retail Price	Core
9400, 9410, 9450, 9500, 9510, 9550, 9550SH, 9560, 9560SH, 9650CTS, 9660CTS	Separator Fan Drive Jackshaft 75.571" Long, 1.376" Diameter Replaces H132208	AMH212308	\$ 295.56	
9600, 9610, 9650, 9660	Separator Fan Drive Jackshaft 86.437" Shaft Length, 1.374" Shaft Diameter, 0.945" Thread Diameter Replaces H132207	AMH212310	\$ 351.25	
9400 ASN 670101, 9500 BSN 670200, 9600 BSN 670300, CTS BSN 670400	Separator Fan Drive Pulley 1.252" ID, 11.37" OD	AMAH131979	\$ 304.64	
9400 BSN 670100, (9500, 9500SH BSN 670200), 9600 BSN 670300, CTS BSN 670400	Separator Fan Drive Pulley 9.118" OD, 1.252" Bore	AMAH131248	\$ 157.00	
9400 ASN 670101, 9410, 9450, (9500, 9500SH ASN 670201), 9510, 9510SH, 9550, 9550SH, 9560 BSN 075251, 9600 ASN 670301, 9610, 9650, 9650CTS, 9660 BSN 705331, 9660CTS BSN 705403, 9780CTS BSN 078555, CTS ASN 670401, CTS II	Sheave Assembly 18.11" OD, 1.25" Bore	AMAH146463	\$ 479.94	
9560STS, 9660STS, 9760STS, 9860STS	Fan Drive Half Sheave, Inner 12.032" OD	AMH206016	\$ 144.78	
9400 ASN 670101, 9450 BSN 690196, 9550 BSN 690669, 9550SH BSN 690701, 9650 BSN 690730, 9650CTS BSN 690464, 9650STS BSN 691595, 9750STS BSN 691222	Sheave Assembly Inner Drive, Separator Fan 10.162" OD, 1.25" Bore Diameter	AMAH157219	\$ 131.50	
7720	Upper Cleaning Fan Housing	AMH97793	\$ 398.34	
9400, 9500, 9501, 9600	Fan Speed Motor Plug on back of Motor	AMAH124567	\$ 75.00	
9660STS, 9670STS, 9760STS, 9770STS, 9860STS, 9870STS, S650, S660, S670, S670HM, S680, S680HM, S690, S690HM, S760, S770, S780, S790	Cleaning Shoe Fan Blade 19.685" Long	AMH206345	\$ 51.50	
9400 BSN 670100, 9500 BSN 670200, 9600 BSN 670300, CTS BSN 670400	Cleaning Fan Drive Pulley 9.125" OD, 1.25" Bore Diameter	AMAH131249	\$ 115.00	
9400, 9410, 9450, 9500, 9501, 9510, 9550, 9550SH, 9560, 9560SH, 9600SH, 9600, 9610, 9640, 9650CTS, 9650, 9660, 9750, 9760STS, 9860STS, 9880STS	Cleaning Fan Sprocket	AMH122372	\$ 29.00	
9400, 9410, 9450, 9500, 9510, 9510SH, 9550, 9550SH, 9560, 9560SH, 9560STS, 9600, 9610, 9650, 9650CTS, 9650STS, 9660, 9660CTS, 9660STS, 9750STS, 9760STS, 9860STS, CTS, CTS II, S660 SN 765000-785000	Fan Speed Actuator	AMAXE13829	\$ 100.00	
9400, 9410, 9501, 9510, 9510SH, 9550, 9550SH, 9560, 9560STS, 9600, 9610, 9650, 9650STS, 9660, 9660CTS, 9660STS, 9750STS, 9760STS, 9780CTS ASN 072800, 9860STS, 9880STS, CTS, CTS II, Forage Harvesters: 5730, 5830	Fan Speed Actuator Plug under Motor Replaces AA77820	AMAH143903	\$ 60.00	
9400, 9410, 9450, 9500, 9500SH, 9501, 9510, 9510SH, 9600, 9610, 9650, 9650CTS, 9750STS, CTS, CTS II	Fan Drive Speed Shaft 10.31" Long	AMAH128384	\$ 32.37	

John Deere®—Combine

John Deere®—Combine

Application	Description	Part Number	Retail Price	Core
9400, 9410, 9450, 9500, 9500SH, 9501, 9510, 9510SH, 9550, 9550SH, 9560, 9560SH, 9560STS, 9570STS, 9600, 9610, 9650, 9650CTS, 9650STS, 9660, 9660CTS, 9660STS, 9670STS, 9750STS, 9760STS, 9770STS, 9780CTS ASN 072800, 9860STS, 9870STS, C670, CTS, CTS II, S550 SN 745100-764999, S650 ASN 765000, (S660, S670, S680 ASN 745100), S670HM BSN 765000, S690 ASN 745100-765249, S760, S770, S780, S785, S790, T550, T560, T660, T670	Thrust Bearing, Separator Fan Drive 3.678" OD, 2.002" Bore Replaces AH229175	AMAH124050	\$ 30.50	
9400, 9410, 9450, 9500, 9500SH, 9510, 9510SH, 9550, 9550SH, 9560, 9560SH, 9560STS, 9570STS, 9600, 9610, 9650, 9650CTS, 9650STS, 9660, 9660CTS, 9660STS, 9670STS, 9750STS, 9760STS, 9770STS, 9860STS, 9870STS, CTS, CTS II	Ball Bearing, Left Hand	AMAH139297	\$ 21.00	
9450 ASN 695100, 9550 ASN 695200, 9550SH ASN 695700, 9560, 9560SH, 9560STS, 9570STS, 9650 ASN 695300, 9650CTS ASN 695400, 9650STS ASN 695500, 9660, 9660CTS, 9660STS, 9670STS, 9750STS ASN 695600, 9760STS, 9770STS, 9860STS, 9870STS, S550, S650, S660, S670, S680, S690, S760, S770	Ball Bearing, Variable Drive Upper Countershaft	AMAH165609	\$ 29.00	
9400, 9410, 9450, 9500, 9500SH, 9510, 9510SH, 9550, 9550SH, 9560, 9560SH, 9560STS, 9570STS, 9600, 9610, 9650, 9650CTS, 9650STS, 9660, 9660CTS, 9660STS, 9670STS, 9750STS, 9760STS, 9770STS, 9860STS, 9870STS, CTS, CTS II, S650, S660, S670, S670HM, S680, S680HM, S690, S690HM, S760, S770, S780, S785, S790	Ball Bearing, Cleaning Fan Shaft 0.984" ID, 2.047" OD Replaces JD9490	AMAH225510	\$ 16.48	
9400, 9410, 9450, 9500, 9500SH, 9510, 9510SH, 9550, 9550SH, 9560, 9560SH, 9600, 9610, 9650, 9650CTS, 9660, 9660CTS, CTS, CTS II	Ball Bearing, Cleaning Fan Shaft 1.5748" ID, 3.1496" OD Use w/ AMH133621 Bearing Flange Replaces 96328C1, 552945	AMJD39109	\$ 21.00	
9560STS, 9650STS, 9660STS, (9670STS, 9770STS, 9870STS - w/ Regular Shoe Only), 9750STS, 9760STS, 9860STS, S550, (S650, S670, S680, S690 BSN 785001), S670HM, S680HM, S690HM	Ball Bearing, Cleaning Shoe Shaft 1.5748" ID, 3.1496" OD Use w/ AMH133621 Bearing Flange Replaces 96328C1, 552945	AMJD39109	\$ 21.00	
9400, 9410, 9450, 9500, 9500SH, 9510, 9510SH, 9550, 9550SH, 9560, 9560SH, 9560STS, 9570STS, 9600, 9610, 9650, 9650CTS, 9650STS, 9660, 9660CTS, 9660STS, (9670STS, 9770STS, 9870STS - w/ Regular Shoe), 9750STS, 9760STS, 9860STS, S550, (S650, S660, S670, S680, S690 BSN 785001), S670HM, S680HM, S690HM, CTS, CTS II	Bearing Flange 2.835" ID, 3.937" Bolt Circle Diameter	AMH133621	\$ 8.15	
9400, 9410, 9450, 9500, 9500SH, 9510, 9510SH, 9550, 9550SH, 9560, 9560SH, 9560STS, 9570STS, 9600, 9610, 9650, 9650CTS, 9650STS, 9660, 9660CTS, 9660STS, 9670STS, 9750STS, 9760STS, 9770STS, 9860STS, 9870STS, CTS, CTS II, S550, S650, S660, S670, S680, S760, S770, S780, S785, S790	Bearing Flange, Cleaning Fan Shaft 4.689" Bolt Circle Diameter	AMH113626	\$ 8.53	

Prices Subject to Change without Prior Notice. The use of original equipment manufacturer (OEM) part numbers or trademarks, e.g. Case® and John Deere®, are for reference purposes only and for indicating product use and compatibility. Our company and the listed replacement parts contained herein are not sponsored, approved or manufactured by the OEM. All parts are New unless designated Reman in the description.

John Deere®—Combine

Application	Description	Part Number	Retail Price	Core
9400, 9410, 9500, 9500SH, 9510, 9510SH, 9550, 9550SH, 9560, 9560SH, 9560STS, 9570STS, 9600, 9610, 9650, 9650CTS, 9650STS, 9660, 9660CTS, 9660STS, 9670STS, 9750STS, 9760STS, 9770STS, 9860STS, 9870STS, CTS, CTS II, S550, S650, S660, S670, S670HM, S680, S680HM, S690, S690HM, S760, S770, S780, S785, S790	Bearing Flange, Cleaning Fan Shaft 4.689" Bolt Circle Diameter	AMH113625	\$ 6.24	
3300, 4400, 4420, 6600, 6620, 7700, 7720, 8820	Bearing, Cleaning Fan Drive Sheave 1.50" ID, 2.507" OD	AMAH87207	\$ 19.79	
6600, 6620, 7700, 7720	Bearing, Cleaning Fan Driveshaft 2.4409" OD, 1.125" Bore Diameter	AMJD9246	\$ 20.81	

Separator Gearbox Components

Application	Description	Part Number	Retail Price	Core
9400, 9410, 9450, 9500, 9500SH, 9510, 9510SH, 9550, 9550SH, 9560, 9560STS, 9570STS, 9600, 9610, 9650, 9650CTS, 9650STS, 9660, 9660CTS, 9660STS, 9670STS, 9750STS, 9760STS, 9770STS, 9860STS, 9870STS, CTS, CTS II	Gearbox Shaft, Main Engine 28.812" Long	AMH129934	\$ 259.43	
9400, 9410, 9500, 9500SH, 9510, 9510SH, 9600, 9610, CTS	Main Clutch Shaft 8.71" Long, 20, 41 & 23 Tooth Replaces H148768	AMH148768	\$ 339.85	
9400, 9410, 9450, 9500, 9500SH, 9510, 9510SH, 9550 BSN 700200, 9550SH BSN 700700, 9560STS BSN 720100, 9600, 9610, 9660, 9660CTS, 9660STS, 9760STS, 9860STS, 9870STS, CTS, CTS II	Unloader Drive Sheave 2-Groove, 8.534" OD	AMH129935	\$ 178.33	
9570STS, 9650STS, 9660STS, 9670STS, 9750STS, 9760STS, 9770STS, 9860STS, 9870STS, S550, S650, S660, S670 BSN 765253, S670HM, S680, S680HM, S690, S690HM, S770 ASN 1Z0S770XXX110000, S780, S785, S790	Bearing, Separator Drive Variable Speed Replaces AH144150	AMAH209207	\$ 132.67	
6600, 6620, 7700, 7720, 8820	Double Idler Pulley, Separator Drive 3.25" Wide, 8" OD, 0.50" Bore Diameter Replaces AH87119	AMAH93318	\$ 59.09	

Elevator Chains

Elevator chains include rubber paddles attached with 5/16" plated bolts and nuts (unless noted in the individual description). Chains feature full side plates for added strength.



Application	Description	Part Number	Retail Price	Core
3300, 4400, 4420	Clean Grain Elevator Chain 100 links - 4 3/4" x 2 1/2" paddles every 4th link	AMAH87745	\$ 155.00	
	Rubber Paddle 4 3/4" x 2 1/2"	AMH86759	\$ 1.18	
4400, 4420, 6600, 6601, 6620, 7700, 7701, 7720, 7721, 8820	Clean Grain Elevator Chain 108 links - 6" x 3" paddles every 4th link	AMAH87747	\$ 165.00	
	Rubber Paddle 6" x 3"	AMH135235	\$ 1.98	

John Deere®—Combine

John Deere®—Combine

Application	Description	Part Number	Retail Price	Core
6600, 6601, 6620, 7700, 7701, 7720, 7721, 8820 BSN 464350	Clean Grain Elevator Chain 128 links - 6" x 3" paddles every 4th link	AMX29002	\$ 180.00	
	Rubber Paddle 6" x 3"	AMH135235	\$ 1.98	
8820 ASN 464350	Clean Grain Elevator Chain 108 links - 3" x 7 3/8" paddles every 4th link	AMAH134818	\$ 210.00	
	Rubber Paddle 3" x 7 3/8"	AMH106323	\$ 2.72	
9400, 9410, 9500, 9510, CTS, CTS II	Clean Grain Elevator Chain 144 links - 6" x 4 3/8" paddles every 4th link	AMAH162441	\$ 210.00	
	Rubber Paddle 6" x 4 3/4"	AMH137276	\$ 2.13	
9450, 9550, 9550SH, 9560, 9560SH, 9560STS, 9570STS, 9650, 9650CTS, 9650STS, 9660, 9660CTS, 9660STS, 9670STS, 9750STS, 9760STS, 9860STS, S550, S650, S660, S670 BSN 765253, S760	Clean Grain Elevator Chain 144 links - 8 3/4" x 4 3/4" paddles every 4th link Replaces AH162058, AXE25091, AXE28559	AMAH162059	\$ 310.00	
	Rubber Paddle 8 3/4" x 4 3/4"	AMH144667	\$ 3.68	
9600, 9610	Clean Grain Elevator Chain 144 links - 7 3/4" x 4 1/4" paddles every 4th link	AMAH162442	\$ 225.00	
	Rubber Paddle 7 3/4" x 4 1/4"	AMH137277	\$ 2.47	
9670STS, 9770STS, 9870STS, S660, S670, S670HM, S680, S680HM, S690HM, S770, S780, S790 w/ High Capacity Chain	Clean Grain Elevator Chain 147 Links - 4 3/4" x 8 7/8" paddles every 4th link CA550 Chain Replaces AH234790, AXE25092	AMAXE28560	\$ 395.00	
	Rubber Paddle 4 3/4" x 8 7/8"	AMH237830	\$ 4.04	
S690 ASN 745100, S790 w/ Extra High Capacity Chain	Clean Grain Elevator Chain 148 Links - 8 3/4" x 4 5/8" paddles every 4th link	AMAXE16681	\$ 695.00	
3300, 4400, 4420, 6600, 6601, 6620 BSN 610300, 7700, 7701, 7720 BSN 610500	Return Grain Elevator Chain 144 links - 4 3/4" x 2 1/2" paddles every 6th link	AMAH96388	\$ 160.00	
	Rubber Paddle 4 3/4" x 2 1/2"	AMH86759	\$ 1.18	
6620 ASN 610300, 7720 ASN 610501, 8820	Return Grain Elevator Chain 144 links - 6" x 3" paddles every 6th link	AMAH98032	\$ 185.00	
	Rubber Paddle 6" x 3"	AMH135235	\$ 1.98	
9400, 9410, 9450, 9500, 9510, 9550, 9600, 9610, 9650, CTS, CTS II	Return Grain Elevator Chain 151 links - 6" x 3" paddles every 6th link	AMAH131074	\$ 200.00	
	Rubber Paddle 6" x 3"	AMH135235	\$ 1.98	
9560STS, 9570STS, 9650STS, 9660STS, 9670STS, 9750STS, 9760STS, 9770STS, 9860STS, 9870STS, S550, S650, S660, S670, S670HM, S760, S770	Return Grain Elevator Chain 113 links - 6" x 3" paddles every 6th link	AMAH148021	\$ 160.00	
	Rubber Paddle 6" x 3"	AMH135235	\$ 1.98	
S680, S680HM, S690, S690HM, S780, S785, S790	Return Grain Elevator Chain 79 Links - 8 3/4" x 3 1/8" paddles every 6th link Replaces AXE10556	AMAXE47615	\$ 240.00	
	Rubber Paddle 8 3/4" x 3 1/8"	AMHXE15520	\$ 5.63	

Prices Subject to Change without Prior Notice. The use of original equipment manufacturer (OEM) part numbers or trademarks, e.g. Case® and John Deere®, are for reference purposes only and for indicating product use and compatibility. Our company and the listed replacement parts contained herein are not sponsored, approved or manufactured by the OEM. All parts are New unless designated Reman in the description.

John Deere®—Combine



Elevator Housings and Components

Application	Description	Part Number	Retail Price	Core
6600, 6620 Early, 7700, 7720 Early	Clean Grain Elevator Housing	AMAH96610	\$ 827.56	
6600, 6620 ASN 464350, 7700, 7720 ASN 556301, 8820 BSN 464350	Clean Grain Elevator Housing For Early Update, (2) AH125904 Bearing Plates are Required	AMAH112164	\$ 973.60	
8820 ASN 464350	Clean Grain Elevator Housing	AMAH105850	\$ 987.00	
9400, 9410, 9500, 9510, 9510SH, CTS, CTS II	Clean Grain Upper Elevator Housing Non-Stainless	AMAH153743	\$ 785.00	
9400, 9500, 9500SH, 9410, 9510, 9510SH, CTS, CTS II	Lower Clean Grain Elevator Housing Non-Stainless	AMAH156594	\$ 820.00	
9450, 9550, 9560, 9640, 9650, 9650CTS, 9660, 9660CTS, 9680	Clean Grain Elevator Housing	AMAH207172	\$ 1625.00	
9600, 9610	Upper Clean Grain Elevator Housing Non-Stainless	AMAH153741	\$ 765.00	
	Lower Clean Grain Elevator Housing Non-Stainless	AMAH156596	\$ 795.00	
9560STS, 9570STS, 9650STS, 9660STS, 9670STS, 9750STS, 9760STS, 9860STS	Clean Grain Elevator Housing Replaces AH149062, AH207168, AH218602	AMAXE12250	\$ 1754.97	
9770STS, 9870STS	Clean Grain Elevator Housing Replaces AH221442	AMAXE12248	\$ 2569.00	
9400, 9410, (9500, 9500SH ASN 640200), 9510, 9510SH, CTS, CTS II	Upper Clean Grain Auger Housing Replaces AH149183	AMAH235411	\$ 866.52	
S670, S670HM, S680, S680HM, S690, S690HM	Clean Grain Elevator Housing High Capacity and Regular Wear	AMAXE14370	\$ 2989.00	
9400, 9410, 9500, 9501, 9510, 9510SH	Perforated Door 25 5/8" Long, 7 1/8" Wide For Clean Grain Elevator	AMAH127396	\$ 94.84	
9600, 9610	Perforated Door 26" Long, 10 1/8" Wide, 0.437" Mounting Hole Diameter For Clean Grain Elevator	AMAH127397	\$ 117.42	
6600, 6601, 6602, 6620, 6622, 7700, 7701, 7720, 7721	Return Grain Elevator Housing	AMAH96371	\$ 887.18	
6620 Titan II, 7720 Titan II, 8820 Titan II	Return Grain Elevator Housing	AMAH112077	\$ 871.06	
9400, 9410, 9450, 9500, 9510, 9550, 9560, 9600, 9610, 9650, 9650CTS, 9660, 9660CTS, CTS II	Return Grain Elevator Housing Replaces AR93889	AMAH169233	\$ 1250.00	
	Solid Door For Return Grain Elevator Housings	AMAH130892	\$ 38.00	
9560STS, 9650STS, 9660STS, 9750STS, 9760STS, 9860STS	Return Grain Elevator Housing	AMAH149536	\$ 981.55	
9570STS, 9670STS, 9770STS, 9870STS, S550 SN 745100-764999, S650 SN 765000-785000, (S660, S670 SN 745100-785000), S670HM BSN 765000	Return Grain Elevator Housing Replaces AH232508	AMAXE14891	\$ 1165.02	
6620 ASN 610300, 7720 ASN 610500, 8820	Solid Door For Return Grain Elevator Housings	AMAH98029	\$ 56.50	
6620 ASN 610301, 7720 ASN 610501, 7721 ASN 610601, 8820	Perforated Door For Return Grain Elevator Housings	AMAH98030	\$ 67.85	
9400, 9410, 9450, 9500, 9501, 9510, 9510SH, 9550, 9550SH, 9560, 9560SH, 9600, 9610, 9650, 9660, 9660CTS, 9780CTS BSN 076057	Perforated Door 12" Long, 7 7/8" Wide For Return Grain Elevator Housing	AMAH130893	\$ 59.03	
S680, S680HM, S690, S690HM, S780, S790	Solid Door For Lower Return Grain Elevator	AMAH234729	\$ 68.57	
9600, 9610, 9650	Tube Assembly For Upper Tailings Auger Replaces AH137303, AH137582, AH141571	AMAH149179	\$ 733.10	

John Deere®—Combine

John Deere®—Combine

Application	Description	Part Number	Retail Price	Core
9560STS, 9570STS, 9650STS, 9660STS, 9670STS, 9750STS, 9760STS, 9770STS, 9860STS, 9870STS, S550 SN 745100-764999, S650 SN 765000-785000, S660 ASN 765172, S670 ASN 765253, S680 ASN 785001	Door Assembly, Perforated 24 3/4" Long, 6 1/4" Wide For Tailings Elevator	AMAH162156	\$ 78.08	
3300, 4400, 3300, 4420, 6600, 6601, 6602, 6620 BSN 610300, 6622, 7700, 7701, 7720 BSN 610500, 7721 BSN 610600	Solid Door For Clean Grain/Tailing Elevator	AMAH12678	\$ 35.22	
9400, 9410, 9450, 9500, 9510, 9510SH, 9550, 9550SH, 9600, 9610, 9650, 9650CTS, 9650STS, 9750STS, CTS, CTS II	Upper Clean Grain Elevator Sheave Hub 1.182" ID	AMH134760	\$ 60.38	
9560STS, 9570STS, 9650STS, 9660STS, 9670STS, 9750STS, 9760STS, 9770STS, 9860STS, 9870STS, S550, S650, S660, S670, S670HM, S760, S770	Slip Clutch Pulley 1.381" ID, 8.892" OD For Tailing Elevator	AMAH173040	\$ 184.45	
9560STS, 9570STS, 9650STS, 9660STS, 9670STS, 9750STS, 9760STS, 9770STS, 9860STS, 9870STS, S560, S650, S660, S670, S760, S770	Slip Clutch Hub 2.047" Long, 3.543" OD, 0.987" Bore, 0.276" Offset	AMH174509	\$ 69.25	
6620, 7700 ASN 163901	Spout	AMAH88989	\$ 374.89	
7720, 8820 BSN 464350	Spout	AMAH97856	\$ 370.00	
8820 ASN 464351	Upper Spout	AMAH105498	\$ 510.00	
S550, S650, S660, S670, S670HM, S680HM, S690HM, S760, S770, (S780, S790 ASN 1Z0S780XXX109999), S785	Vertical Unloading Auger Lower Drive Shaft Splined Shaft	AMHXE16941	\$ 204.00	
9400, 9410, 9450, 9500, 9500SH, 9510, 9510SH, 9550, 9550SH, 9560, 9560SH, 9560STS, 9610, 9650, 9650CTS, 9650STS, 9660, 9660CTS, 9660STS, 9750STS, 9760STS, 9770STS, 9860STS, 9870STS, CTS II	Bushing, Clean Grain Elevator Drive Tightener 1.005" ID, 1.128" OD, 1" Wide	AMH171061	\$ 5.00	
9560STS, 9570STS, 9650STS, 9660STS, 9670STS, 9750STS, 9760STS, 9860STS, 9870STS, S550, S650, S660, S670, S670HM, S680, S680HM, S690, S690HM, S760, S770	Bearing w/ Collar, Lower Tailings Return Elevator Housing	AMJD10384	\$ 22.00	
S680, S680HM, S690, S690HM, S780, S790	Bearing w/ Collar, Upper Active Tailings Elevator Shaft	AMJD10384	\$ 22.00	
	Bearing w/ Collar, Lower Active Tailings Elevator Housing	AMJD10384	\$ 22.00	

Elevator Chain Sprockets

To extend the life of your chain assemblies, always replace the sprockets when installing a new chain. Forged carbon steel, induction hardened tooth.



Application	Description	Part Number	Retail Price	Core
3300, 4400, 4420	Clean Grain Elevator Chain Sprocket, Upper 7 Tooth, 1" Shaft	AMH63577	\$ 38.58	
6600 ASN 3701, 6601, 6602, 6620 ASN 610301, 6622, 7700 ASN 2801, 7701, 7720 ASN 610501, 7721, 8820	Clean Grain Elevator Chain Sprocket, Upper 8 Tooth, 1" Shaft	AMH108576	\$ 30.00	
8820 ASN 464351	Clean Grain Elevator Chain Sprocket, Upper 8 Tooth, 1.25" Shaft	AMH91334	\$ 35.00	
9400, 9500, 9510, 9600, 9610, CTS, CTS II	Clean Grain Elevator Chain Sprocket, Upper 8 Tooth, 30 mm Shaft Replaces H177988	AMH128576	\$ 35.00	

John Deere®—Combine

John Deere®—Combine





Application	Description	Part Number	Retail Price	Core
9450, 9550, 9550SH, 9560, 9560SH, 9560STS, 9570STS, 9650, 9650CTS, 9650STS, 9660, 9660CTS, 9660STS, 9670STS, 9750STS, 9760STS, 9860STS, (S550, S650, S660, S670 BSN 765253, S760 - Standard Capacity)	Clean Grain Elevator Chain Sprocket, Upper 8 Tooth, 30 mm Shaft	AMH164796	\$ 26.00	
9770STS, 9870STS, S670, S670HM, S680, S680HM, S690HM, (S770, S790 - w/ High Capacity Chain), S780	Clean Grain Elevator Chain Sprocket, Upper Heavy Duty, 10 Tooth, 1.387" ID, 5.84" OD	AMH228385	\$ 33.00	
S690, S790 w/ Extra High Capacity Chain	Clean Grain Elevator Chain Sprocket, Upper	AMHXE22459	\$ 65.00	
3300, 4400, 4420	Clean Grain Elevator Chain Sprocket, Lower 7 Tooth, 1" Shaft	AMH63578	\$ 23.00	
6600 ASN 3701, 6620, 7700 ASN 2801, 7701, 7720, 7721, 8820	Clean Grain Elevator Chain Sprocket, Lower 8 Tooth, 1.25" Shaft	AMH91334	\$ 35.00	
6601, 6602, 6622	Clean Grain Elevator Chain Sprocket, Lower 8 Tooth, 1" Shaft	AMH108576	\$ 30.00	
9400, 9410, 9450, 9500, 9500SH, 9550, 9550SH, 9560, 9560SH, 9560STS, 9570STS, 9600, 9610, 9650, 9650CTS, 9650STS, 9660, 9660CTS, 9660STS, 9670STS, 9750STS, 9760STS, 9770STS, 9860STS, 9870STS, CTS, CTS II, (S550, S650, S660, S670 BSN 765253, S760 - Regular Capacity)	Clean Grain Elevator Chain Sprocket, Lower 8 Tooth, 35 mm Shaft	AMH133143	\$ 30.00	
9770STS, 9870STS, S670, S670HM, S680, S680HM, S690HM, S770, S780 - w/ High Capacity or High Unloading Rate	Clean Grain Elevator Chain Sprocket, Lower 10 Tooth, 1.779" ID, 5.84" OD	AMH228383	\$ 30.00	
S690, S790 w/ Extra High Capacity Chain	Clean Grain Elevator Chain Sprocket, Lower	AMHXE22458	\$ 65.00	
3300, 4400, 4420, 6600 ASN 003701, 6601, 6602, 6620 BSN 610300, 6622, 7700 ASN 002801, 7701, 7720 BSN 610500	Return Grain Elevator Chain Sprocket, Upper 7 Tooth, 1" Shaft	AMH63578	\$ 23.00	
6620 ASN 610301, 7720 ASN 610501, 8820	Return Grain Elevator Chain Sprocket, Upper 8 Tooth, 1" Shaft	AMH108576	\$ 30.00	
9400, 9410, 9450, 9500, 9510, 9550, 9560, 9600, 9610, 9650, 9660, 9660CTS, CTS, CTS II	Return Grain Elevator Chain Sprocket, Upper 8 Tooth, 1" Hex Shaft	AMH134603	\$ 20.00	
9560STS, 9570STS, 9650STS, 9660STS, 9670STS, 9750STS, 9760STS, 9770STS, 9860STS, 9870STS, CTS, CTS II, S550, S650, S660, S670, S670HM, S760, S770	Return Grain Elevator Chain Sprocket, Upper 8 Tooth, 30 mm Shaft Replaces H177988	AMH128576	\$ 35.00	
S680, S680HM, S690, S690HM, S780, S790	Return Grain Elevator Chain Sprocket, Upper 8 Tooth, 30 mm Shaft	AMH164796	\$ 26.00	
3300, 4400, 4420, 6600, 6601, 6602, 6622, 7700, 7701	Return Grain Elevator Chain Sprocket, Lower 7 Tooth, 1" Shaft	AMH63578	\$ 23.00	
6620 BSN 610300, 6622, 7720 BSN 610500, 7721	Return Grain Elevator Chain Sprocket, Lower 7 Tooth, 1.25" Shaft	AMH99472	\$ 35.00	
8820	Return Grain Elevator Chain Sprocket, Lower 8 Tooth, 1" Shaft	AMH108576	\$ 30.00	
9400, 9410, 9450, 9500, 9510, 9550, 9600, 9610, 9650, CTS	Return Grain Elevator Chain Sprocket, Lower 8 Tooth, 1" Hex Shaft	AMH134603	\$ 20.00	
9560STS, 9650STS, 9660STS, 9670STS, 9750STS, 9760STS, 9770STS, 9860STS, 9870STS, S550, S660, S670, S670HM, S680, S680HM, S690, S690HM, S760, S770, S780, S790	Return Grain Elevator Chain Sprocket, Lower 8 Tooth, 35 mm Shaft	AMH133143	\$ 30.00	
3300, 4400 BSN 101300, 4420, 6600, 6620 BSN 502550, 7700 BSN 507350, 7720, 9400, 9410, 9450, 9500, 9501, 9510, 9510SH, 9550, 9600, 9610, 9650, 9650CTS, 9660, 9660CTS, 9780CTS ASN 072800, C670, CTS, CTS II, T550, T560, T660, T670	Idler Sprocket 17 Tooth, 0.50" Shaft Replaces AH87204	AMAH98176	\$ 17.93	

John Deere®—Combine

John Deere®—Combine

Application	Description	Part Number	Retail Price	Core
3300, 4400, 4420, 6600, 6601, 6602, 6620, 7700, 7701, 7720	Idler Sprocket 17 Tooth, 0.50" Bore Diameter For Size 50 Chain	AMAH21440	\$ 23.69	
9400, 9410, 9450, 9500, 9500SH, 9501, 9510, 9510SH, 9550, 9550SH, 9560, 9560SH, 9600, 9610, 9650, 9650CTS, 9660, 9660CTS, CTS, CTS II	Upper Tailings Drive Sprocket Assembly 30 Tooth, 1" Hex Bore Diameter For Size 50 Chain	AMAH130571	\$ 35.00	
9400, 9410, 9450, 9500, 9500SH, 9501, 9510, 9510SH, 9550, 9550SH, 9560, 9560SH, 9600, 9610, 9650, 9650CTS, 9660, 9660CTS, CTS, CTS II	Tailings Drive Sprocket Assembly 18 Tooth, 1" Hex Bore Diameter For Size 50 Chain	AMAH130572	\$ 35.00	
9400, 9410, 9450, 9500, 9500SH, 9501, 9510, 9510SH, 9550, 9550SH, 9560, 9560SH, 9600, 9610, 9650, 9650CTS, 9660, 9660CTS, CTS, CTS II	Tailings Drive Sprocket Assembly 18 Tooth, 1.184" Bore Diameter For Size 50 Chain	AMAH121047	\$ 37.00	
9400, 9410, 9450, 9500, 9500SH, 9510, 9510SH, 9550, 9550SH, 9560, 9560SH, 9560STS, 9570STS, 9600, 9610, 9650, 9650CTS, 9650STS, 9660, 9660CTS, 9660STS, 9670STS, 9750STS, 9760STS, 9860STS, CTS, CTS II, S550, S650, S660, S760	Idler Pulley, Clean Grain Elevator Drive 7 15/16" Diameter	AMAN15237	\$ 26.68	
9770STS, 9870STS, S670, S670HM, S680, S680HM, S690, S690HM, S770, S780, S785, S790	Idler Pulley, Clean Grain Elevator Drive	AMAH220915	\$ 108.95	





Elevator Gearbox

Application	Description	Part Number	Retail Price	Core
 4400 ASN 151501, 4420, 6600 ASN 156501, 6620, 6622, 7700 ASN 163901, 7720, 7721, 8820	Reman Bin Loading Auger Gearbox Replaces AH89006, AH96760	AMAH129277	\$ 695.00	\$ 200.00
 4400 ASN 151500, 6620 ASN 620100, 7720 ASN 621219, 8820 ASN 620834	Bin Loading Auger Gearbox Shaft 5.63" Long Replaces H94702	AMH132607	\$ 33.50	
 9400, 9410, 9450, 9510, 9550, 9570STS, 9600, 9610, 9650, 9650STS, 9670STS, 9770STS, 9860STS, CTS, CTS II, S550, S650, S660, S670, S670HM, S680, S680HM, S690HM, S760, S770, S780	Grain Elevator Gearbox Replaces DE19271, DE31853	AMDE20100	\$ 1195.00	
9400, 9410, 9450, 9500, 9510, 9550, 9560, 9570STS, 9600, 9610, 9650, 9650CTS, 9650STS, 9660, 9660CTS, 9670STS, 9750STS, 9860STS, CTS, CTS II	Gearbox Pulley Use w/ AMDE20100 Gearbox Replaces AH164868	AMAH221847	\$ 82.00	
 9400, 9410, 9450, 9500, 9500SH, 9510, 9510SH, 9550, 9550SH, 9560, 9560SH, 9560STS, 9570STS, 9600, 9610, 9650, 9650CTS, 9650STS, 9660, 9660CTS, 9660STS, 9750STS, 9760STS, 9770STS, 9860STS, 9870STS, CTS, CTS II, S550, S650, S660, S670, S670HM, S680, S680HM, S690, S690HM, S760, S770, S780, S790	Clean Grain Elevator Gearbox Seal	AMAH131860	\$ 19.00	
 (4400, 6600 ASN 151500), 4420, 6620, 7700 ASN 163900, 7720, 8820	Gearbox Input Shaft 5.11" Long	AMH94703	\$ 30.50	

Prices Subject to Change without Prior Notice. The use of original equipment manufacturer (OEM) part numbers or trademarks, e.g. Case® and John Deere®, are for reference purposes only and for indicating product use and compatibility. Our company and the listed replacement parts contained herein are not sponsored, approved or manufactured by the OEM. All parts are New unless designated Reman in the description.

John Deere®—Combine

John Deere®—Combine

Application	Description	Part Number	Retail Price	Core
 9400, 9410, 9450, 9500, 9500SH, 9510SH, 9550, 9550SH, 9560, 9560SH, 9560STS, 9570STS, 9600, 9610, 9650, 9650CTS, 9650STS, CTS, CTS II, S650, S660, S670, S680	Gearbox Input Shaft	AMCE18445	\$ 85.00	
 9400, 9410, 9450, 9500, 9500SH, 9501, 9510, 9510SH, (9550, 9550SH ASN 685956), 9560, 9560SH, 9560STS, 9600, 9610, 9650 BSN 686232, 9650CTS ASN 685523, 9650STS, 9660, 9660CTS, 9660STS, 9670STS, 9750STS, 9760STS, 9770STS, 9860STS, 9870STS, CTS, CTS II	Gearbox Shaft 9.67" Long	AMH170967	\$ 83.50	
9400, 9410, 9450 BSN 685202, 9500, 9500SH, 9510, 9510SH, 9550 BSN 685955, 9550SH BSN 685735, 9650 BSN 686232, 9650CTS BSN 685522, 9650STS, 9750STS	Clean Grain Elevator Gearbox Shaft 8.74" Long Use w/ AH140127 Gearbox	AMH135452	\$ 37.00	
 9400, 9410, 9500, 9510, 9510SH, 9550, 9550SH, 9560, 9560SH, 9560STS, 9570STS, 9600, 9610, 9650, 9650CTS, 9650STS, 9660, 9660CTS, 9660STS, 9670STS, 9750STS, 9860STS, 9870STS, CTS, CTS II, S550, S650, S660, S670, S670HM, S680, S680HM, S690, S690HM, S760, S770, S780, S785, S790	Gear Kit Includes 46 and 53 Tooth Gears For Clean Grain Elevator Gearbox Replaces H135287, H145316, H145317	AMAH162230	\$ 290.00	
 4400 ASN 151500, 4420, 6600 ASN 156500, 6620, 7700 ASN 163900, 7720, 8820, 9400, 9410, 9450, 9500, 9500SH, 9510, 9510SH, 9550, 9550SH, 9560, 9560SH, 9560STS, 9600, 9610, 9650, 9650CTS, 9650STS, 9660, 9660CTS, 9660STS, 9750STS, 9760STS, 9770STS, 9860STS, 9870STS, CTS, CTS II	Ball Bearing 0.748 Wide, 1.181" ID, 0.835" OD For Clean Grain Elevator Gearbox Replaces 350358X1, 70097088	AMJD7689	\$ 8.10	

Elevator Head Shafts







Application	Description	Part Number	Retail Price	Core
3300, 4400, 4420	Clean Grain Elevator Head Shaft 12" Long	AMH80704	\$ 73.41	
6600, 6601, 6602, 6620, 6622, 7700, 7720, 7721, 8820 BSN 464350	Clean Grain Elevator Head Shaft 13.13" Long	AMH82948	\$ 30.00	
8820 ASN 464351	Clean Grain Elevator Head Shaft 13.44" Long	AMH106314	\$ 35.00	
9400, 9410, 9500, 9501, 9510, 9510SH, CTS, CTS II	Clean Grain Elevator Head Shaft 12.75" Long	AMH135713	\$ 29.00	
9450, 9550, 9550SH, 9560, 9560SH, 9560STS, 9570STS, 9650, 9650CTS, 9660, 9660CTS, 9670STS, 9750STS, 9860STS, S550, S650, S660, S760, S770 w/ Standard Capacity Chain	Clean Grain Elevator Head Shaft 15.68" Long	AMH157043	\$ 51.50	
9600, 9610	Clean Grain Elevator Head Shaft	AMH135714	\$ 48.00	
3300, 4400, 4420, 6600, 6601, 6620 BSN 610300, 6622, 7700, 7701, 7720 BSN 610500, 7721 BSN 610600	Upper Tailings Elevator Head Shaft 10.50" Long	AMH75978	\$ 36.19	
6620 ASN 610300, 7720 ASN 610500, 8820	Lower Tailings Elevator Shaft 11.75" Long	AMH89517	\$ 52.15	
9560STS, 9570STS, 9650STS, 9660STS, 9670STS, 9750STS, 9760STS, 9770STS, 9860STS, 9870STS, S550, S650, S660, S670, S670HM, S760, S770	Top Tailings Elevator Shaft 14" Long	AMH156938	\$ 57.50	

John Deere®—Combine

Application	Description	Part Number	Retail Price	Core
9450, 9550, 9550SH, 9560, 9560SH, 9560STS, 9570STS, 9650, 9650CTS, 9650STS, 9660, 9660CTS, 9660STS, 9670STS, 9750STS, 9760STS, 9860STS, S550, S650, S660, S670 BSN 765253, S760	Bearing w/ Collar, Upper Clean Grain Elevator Shaft	AMJD10384	\$ 22.00	
9560STS, 9570STS, 9650STS, 9660STS, 9670STS, 9750STS, 9760STS, 9770STS, 9860STS, 9870STS, S550, S650, S660, S670, S670HM, S680, S680HM, S690, S690HM, S760, S770	Bearing w/ Collar, Upper Tailings Return Elevator Shaft	AMJD10384	\$ 22.00	
8820, 9400, 9410, 9450, 9500, 9500SH, 9510, 9510SH, 9550, 9560, 9560SH, 9560STS, 9570STS, 9600, 9610, 9650, 9650CTS, 9650STS, 9660, 9660CTS, 9660STS, 9670STS, 9750STS, 9760STS, 9770STS, 9860STS, CTS, CTS II, S550, S650, S660, S670 SN 745100-765252, S670HM, S680 SN 745100-785000, S680HM, S690, S690HM, S760, S770 ASN 1Z0S770XXX110000 and ASN 1H0S770XXX800001, S780, S785, S790	Bearing Flange, Elevator Head Shaft	AME10018	\$ 2.40	

Unloading Auger Housings and Components







Application	Description	Part Number	Retail Price	Core
 9400, 9410, 9450, 9500, 9510, 9550, 9600, 9610, 9650CTS, 9650	Sump Housing	AMAH140713	\$ 985.00	
 9560STS, 9570STS, 9650STS, 9660STS, 9670STS, 9750STS, 9760STS, S550, S650, S660 BSN 765172	Sump Housing Standard Capacity Replaces AH167618, AH206835	AMAH215720	\$ 1355.00	
9400, 9410, 9450, 9500, 9510, 9510SH, 9550 BSN 695200, 9550SH BSN 695700, 9600, 9610, 9650 BSN 695300, 9650CTS BSN 695400, CTS, CTS II	Unloading Auger Elbow Ring Replaces H129550	AMH137227	\$ 538.99	
9670STS, 9770STS, 9860STS ASN 720688, 9870STS, S660, S670, S670HM, S680, S680HM, S690, S690HM, S760, S780, S785, S790	Unloading Auger Retainer, Lubeless	AMH217909	\$ 31.81	
 9000 Series	Panel Patch	AMX2710105	\$ 53.00	
 9400, 9410, 9450, 9500, 9510, 9510SH, 9550, 9550SH, 9560, 9560SH, 9560STS, 9570STS, 9600, 9610, 9650, 9650CTS, 9650STS, 9660, 9660CTS, 9660STS, 9670STS (Standard Rate), 9750STS, 9760STS, 9770STS (Standard Rate), S550, S650, CTS, CTS II	Horizontal Unloading Auger Gearbox Replaces DE19067	AMAH208345	\$ 850.00	
 9400, 9410, 9450, 9500, 9510, 9550, 9560STS, 9600, 9610, 9650, 9650CTS, 9650STS, 9660, 9660STS, 9660CTS, 9670STS, 9750STS, 9760STS, 9770STS, 9860STS	Reman Vertical Unloading Gearbox, Lower	AMX27287	\$ 975.00	\$ 250.00

John Deere®—Combine

Application	Description	Part Number	Retail Price	Core
9400, 9410, 9500, 9500SH, 9510, 9510SH, 9550, 9550SH, 9560, 9560SH, 9560STS, 9570STS, 9600, 9610, 9650, 9650CTS, 9650STS, 9660, 9660CTS, 9660STS, 9670STS, 9750STS, 9760STS, 9770STS, 9860STS, 9870STS, CTS, CTS II, S550, S650, S660, S670, S670HM, S680HM, S690HM, S760, S770, S780 ASN 1Z0S780XXX110000, S785, S790 ASN 1Z0S790XXX110000	Vertical Unloading Auger Gearbox Housing	AMH130137	\$ 707.46	
 6620, 7720, 8820, 9400, 9410, 9450, 9500, 9500SH, 9510, 9510SH, 9550, 9550SH, 9560, 9560SH, 9560STS, 9570STS, 9650STS, 9660, 9660CTS, 9660STS, 9670STS, 9750STS, 9760STS, 9770STS, 9870STS, CTS, CTS II	Ball Bearing, Vertical Auger Lower Gearbox	AMAH96585	\$ 12.78	
 (9660STS, 9670STS, 9770STS - High Unloading Rate), 9760STS, 9860STS, 9870STS, S660, S670, S670HM, S680, S680HM, S690, S690HM, S760, S770, S780, S790	Horizontal Unloading Auger Gearbox	AMDE19353	\$ 1175.00	
 9660STS, 9670STS, 9760STS, 9770STS, 9860STS, 9870STS, S660, S670, S680, S690	Reman Unloading Auger Gearbox	AMDE19353-R	\$ 975.00	\$ 250.00
6620, 7720, 8820	Horizontal Auger Gearbox Shaft, Lower 14" Long Replaces H98044, H113052	AMH135232	\$ 154.31	
S680, S690, S770, S780, S785, S790	Horizontal Unloading Auger Shaft	AMCE21382	\$ 220.00	
 6620, 6622, 7720, 7721, 8820, 9400, 9410, 9450, 9500, 9500SH Late, 9501 Late, 9510, 9510SH Late, 9550, 9550SH, 9560, 9560SH, 9560STS, 9570STS, 9600, 9610, 9650, 9650STS, 9650CTS, 9660, 9660CTS, 9660STS, 9670STS, 9750STS, 9760STS, 9770STS, 9860STS, 9870STS, CTS, CTS II	Vertical Auger Drive Shaft Replaces H96169	AMH215085	\$ 92.70	
 9400, 9410, 9450, 9500, 9500SH, 9510, 9510SH, 9550, 9550SH, 9560, 9560SH, 9560STS, 9570STS, 9600, 9610, 9650, 9650CTS, 9650STS, 9660, 9660CTS, 9660STS, 9670STS, 9750STS, 9760STS, 9770STS, 9860STS, 9870STS, CTS, CTS II	Vertical Auger Drive Shaft	AMH129653	\$ 120.00	
S550, S660, S670, S680, S690, S760, S770, S780, S790	Vertical Auger Drive Shaft Splined Replaces HXE17135	AMCE31099	\$ 184.00	
 S680, S690, S780, S790	Vertical Unloading Auger Drive Shaft, Lower	AMCE21376	\$ 145.00	
 6620, 7720, 8820, 9400, 9410, 9500, 9500SH, 9510, 9510SH, 9600, 9610, CTS, CTS II	Bevel Gear 18 Tooth, 19 Spline, 5.50" Long Replaces H96148 For Unloading Auger Gearbox	AMH149869	\$ 100.00	
 4400 ASN 151501, 4420, 6600 ASN 156501, 6620, 6622 ASN 610401, 7700 ASN 163901, 7701, 7720, 7721, 8820	Gear 17 Tooth, 1.002" ID For Loading Auger	AMH86912	\$ 62.50	



John Deere®—Combine

John Deere®—Combine

	Application	Description	Part Number	Retail Price	Core
	6620, 6622, 7720, 7721, 8820, 9400, 9410, 9450, 9500, 9500SH, 9510, 9510SH, 9550, 9550SH, 9560, 9560SH, 9560STS, 9570STS, 9600, 9610, 9650, 9650CTS, 9650STS, 9660, 9660CTS, 9660STS, 9670STS, 9750STS, 9760STS, 9770STS, 9860STS, 9870STS, CTS, CTS II	Gear For Vertical Loading Auger	AMH96294	\$ 155.00	
	6620, 7720, 8820, 9400, 9410, 9450, 9500, 9500SH, 9510, 9510SH, 9550, 9550SH, 9560, 9560SH, 9560STS, 9570STS, 9600, 9610, 9650, 9650CTS, 9660, 9660CTS, 9660STS, (9670STS, 9770STS - Standard Unload Rate), 9760STS, CTS, CTS II	Bearing Set, Horizontal Unloading Auger Gearbox	AMAH94661	\$ 39.00	
	9400, 9410, 9450, 9500, 9500SH, 9510, 9510SH, 9550, 9550SH, 9560, 9560SH, 9560STS, 9570STS, 9600, 9610, 9650, 9650CTS, 9660, 9660CTS, 9660STS, 9670STS, 9760STS, 9770STS, CTS, CTS II, S550, S650, S660 SN 745001-764171	Seal, Single Lip 0.25" Wide, 1.75" ID, 2.378" OD	AMAH98118	\$ 9.00	
	9400, 9410, 9500, 9500SH, 9510, 9510SH, 9550, 9550SH, 9560, 9560SH, 9560STS, 9600, 9610, 9650, 9650CTS, 9650STS, 9660, 9660CTS, 9660STS, 9750STS, 9760STS, 9770STS, CTS, CTS II	Vertical Auger Lower Gearbox Sprocket 46 Tooth, 1.502" Bore	AMAH125080	\$ 88.00	
	(9400, 9410, 9500, 9500SH, 9510, 9510SH, 9550, 9550SH, 9560, 9560SH, 9600, 9610, 9650, 9650CTS, 9650STS BSN 692273, 9660, 9660CTS, 9750STS BSN 691545, CTS ASN 660432, CTS II - Slow Speed or Rice), (9660STS, 9760STS, 9770STS - High Unload Rate), (9860STS, 9870STS - Regular Speed)	Vertical Auger Lower Gearbox Sprocket 40 Tooth, 2.677" Long, 1.502" Bore Diameter For Size 60 Chain	AMAH146352	\$ 80.23	
	9400, 9410, 9450, 9500, 9500SH, 9501, 9510, 9510SH, 9550, 9550SH, 9560, 9560SH, 9560STS, 9600, 9610, 9650, 9650CTS, 9660, 9660CTS, 9660STS, 9750STS, 9760STS, 9780CTS ASN 072800, 9860STS, C670, CTS, CTS II, T550, T560, T660, T670	Unloading Auger Countershaft Drive Sprocket 19 Tooth, 1.819" Long, 1.381" Bore For Size 60 Chain	AMAH128075	\$ 86.70	
	S550, S650, S660 BSN 765172 - w/ 2.20 BPS Unloader Drive	Unloading Auger Drive Sprocket 46 Tooth	AMHXE37870	\$ 102.00	
	9400, 9410, 9450, 9500, 9500SH, 9510, 9510SH, 9550, 9550SH, 9560, 9560SH, 9560STS, 9570STS, 9600, 9610, 9640, 9650, CTS, CTS II	Pinion Shaft Set of 2 17 Tooth, 19 Spline, 5.73" Long For Horizontal Unloading Auger Gearbox Replaces AH94661, AH98118, DE18970	AMDE31419	\$ 180.00	
	9400, 9410, 9450, 9500, 9510, 9510SH, 9550, 9550SH, 9560, 9560SH, 9560STS, 9600, 9610, 9650, 9650CTS, 9650STS, 9660, 9660CTS, 9660STS, 9670STS, 9750STS, 9760STS, 9770STS, CTS, CTS II	Pinion Shaft 17 Tooth, 19 Spline, 5.73" Long	AMCE18278	\$ 182.94	
	9670STS, 9770STS, 9860STS, 9870STS, (S660, S670, S680, S690 SN 745100-785000)	Pinion Shaft	AMCE18776	\$ 145.00	

John Deere®—Combine

John Deere®—Combine

Application	Description	Part Number	Retail Price	Core
 6620, 7720, 8820, 9400, 9410, 9450, 9500, 9510, 9510SH, 9550, 9550SH, 9560, 9560SH, 9560STS, 9570STS, 9600, 9610, 9650, 9650CTS, 9650STS, 9660, 9660CTS, 9660STS, 9670STS, 9750STS, 9760STS, 9770STS, 9860STS, CTS, CTS II, S550, S650, S660 BSN 765172	Unloading Auger Gearbox Bushing 1.26" ID, 1.625" OD, 1.13" Wide	AMN72989	\$ 12.31	
6620 BSN 610300, 7720 BSN 610500 w/ 14' Auger Systems, 8820 BSN 610700, (9400, 9450 - w/ 17' Auger System), (9410, 9510, 9510SH, 9550, 9550SH, 9600, 9610 - w/ 17' or 20' 2-Piece Auger Systems), 9500, 9500SH, (9560, 9560SH - w/ 18.50' or 21.50' Auger Systems), 9560STS, 9650, 9650CTS, 9660CTS, (9660STS, 9760STS - Hi-Rate), CTS, CTS II, S550, S650 SN 745100-764999	Splined Coupling	AMH116292	\$ 30.00	
 6620, 7720, 8820, 9400, 9410, 9450, 9500, 9500SH, 9510, 9510SH, 9550, 9560, 9560SH, 9560STS, 9570STS, 9600, 9610, 9650, 9650CTS, 9650STS, 9660, 9660CTS, 9660STS, 9670STS, 9750STS, 9760STS, 9770STS, CTS, CTS II, S550, S650, S660, S670, S670HM, S680HM, S690HM, S760, S770, S780, S785, S790	Seal 1.68" ID, 3.158" OD, 0.28" Wide For Vertical Unloading Gearbox Shaft	AMAH90963	\$ 16.00	

Clean Grain Elevator Boot and Door

Boot kits include outer and inner side boots, front and rear covers, deflector and non-perforated boot door. Kits also include nuts, bolts and washers to assemble the boot.



Application	Description	Part Number	Retail Price	Core
6600, 7700	Boot Complete w/ Solid Door	AMAH83511	\$ 177.29	
6620, 7720, 8820 BSN 464350	Boot Complete w/ Solid Door	AMAH93242	\$ 225.00	
8820 ASN 464351	Boot Complete w/ Solid Door	AMAH105854	\$ 233.90	
9400, 9500	Boot, 3-Bolt Mounting Complete w/ Solid Door	AMAH136484	\$ 525.00	
9400, 9410, 9500, 9510, CTS, CTS II	Boot, 4-Bolt Mounting Complete w/ Solid Door	AMAH149182	\$ 398.00	
9450, 9550, 9550SH, 9560, 9560SH, 9560STS, 9650, 9660, 9660STS, 9650CTS, 9660CTS, 9750STS, 9860STS	Boot	AMAH171008	\$ 350.00	
9570STS, 9670STS, S550, S650, S660, S670 BSN 765253, S760, S770 ASN 1ZOS770XXXX110000	Boot Replaces AH222240	AMAXE66789	\$ 828.00	
9600	Boot, 3-Bolt Mounting Complete w/ Solid Door	AMAH136487	\$ 365.00	
9600, 9610	Boot, 4-Bolt Mounting Complete w/ Solid Door	AMAH149181	\$ 425.00	
9770STS, 9870STS, S670	Boot	AMAH219600	\$ 469.00	
9450, 9550, 9550SH, 9560, 9560SH, 9560STS, 9570STS, 9650, 9650STS, 9660, 9660STS, 9670STS, 9750STS, 9760STS, 9770STS, 9860STS, 9870STS, S550, S650, S660, S680, S680HM, S690, S690HM, S760, S770, S780, S790	Door Assembly, Perforated 27.53" Long, 10.938" Wide	AMAH154068	\$ 120.00	
6600, 6620, 7700, 7720, 8820 BSN 464350	Door	AMAH77062	\$ 46.50	
8820 ASN 464351	Door	AMAH105855	\$ 55.00	

John Deere®—Combine

Application	Description	Part Number	Retail Price	Core
9400, 9410, 9500, 9510	Door	AMAH129357	\$ 82.00	
9450, 9550, 9560, 9560STS, 9570STS, 9650, 9650CTS, 9650STS, 9660, 9660CTS, 9660STS, 9670STS, 9750STS, 9760STS, 9770STS, 9860STS, 9870STS, S550, S660, S670, S680, S690	Door	AMAH138426	\$ 70.00	
9600, 9610	Door	AMAH129358	\$ 60.00	
9450, 9550, 9550SH, 9560, 9560SH, 9560STS, 9570STS, 9650, 9650CTS, 9650STS, 9660, 9660CTS, 9660STS, 9670STS, 9750STS, 9760STS, 9860STS, S550, S650, S660, S760	Bearing w/ Collar, Lower Clean Grain Elevator Boot	AMJD10384	\$ 22.00	
6600 ASN 105801, 7700 ASN 111901	Roller Chain, Clean Grain Elevator Drive 58 Links, Size 50 Chain	AMAH87147	\$ 80.00	

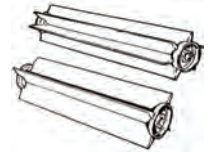

Beaters and Components

Heavy-duty, balanced 4- and 6-wing backbeaters increase stripping action and help prevent backfeeding over the top of the cylinder. Both styles of beaters are welded assemblies and made of heavy-duty, abrasive-resistant steel.

Application	Description	Part Number	Retail Price	Core
6600, 6610, 6620, 6621	Beater, 1 1/4" Shaft 6 Wing	AMAH146173	\$ 864.70	
6620, 6621	Beater, 1 1/2" Shaft 6 Wing	AMAH146171	\$ 860.79	
7720, 7721	Beater, 1 1/2" Shaft 6 Wing	AMAH146170	\$ 975.02	
8820	Beater, 1 1/2" Shaft 6 Wing	AMAH146149	\$ 1431.81	
9400, 9500	Beater, 1 1/2" Shaft 8 Wing	AMLBJD9400-8	\$ 942.94	
9600, 9610, 9650, 9660CTS	Beater, 1 1/2" Shaft 8 Wing	AMLBJD9600-8	\$ 947.47	
3300, 4400, 4420	Bearing Flange, Beater Shaft	AME10018	\$ 2.40	
6600 4 Wing ASN 008907 or 6 Wing, 7700 4 Wing ASN 005688 or 6 Wing	Ball Bearing Replaces H93944	AMJD10007	\$ 18.00	
6620, 7720, 8820, 9400, 9500, 9510, 9510SH, 9600	Idler Pulley, Beater Drive Replaces AH141762	AMAH111447	\$ 58.50	
(9400, 9410, 9450, 9500, 9510, 9550 - 4 Required), (9600, 9650, 9660 - 5 Required)	Beater Curtain	AMH148305	\$ 13.00	
9400, 9410, 9450, 9500, 9500SH, 9501, 9510, 9510SH, 9550, 9550SH, 9560, 9560SH, T550, T560	Beater Blade Replaces H133649	AMH147789	\$ 85.00	
9400, 9410, 9450, 9500, 9500SH, 9510, 9510SH, 9550, 9550SH, 9560, 9560SH	Beater Shaft 61.31" Long	AMH126941	\$ 277.32	
9400, 9410, 9450, 9500, 9500SH, 9510, 9510SH, 9550, 9550SH, 9560, 9560SH, 9600, 9610, 9650, 9650CTS, 9660, 9660CTS, CTS, CTS II	Bearing Flange, Beater Shaft 3.15" Bore Diameter, 4.689" Bolt Circle Diameter	AMH113626	\$ 8.53	
	Bearing Flange, Beater Shaft	AMH113625	\$ 6.24	
9400, 9410, 9450, 9500, 9500SH, 9510, 9510SH, 9550, 9550SH, 9560, 9560SH, 9600, 9650, 9660	Beater Arm Tension Adjustment	AMAH131508	\$ 88.34	
	Beater Drive Hub	AMH128327	\$ 31.25	
9560STS, 9570STS, 9650STS, 9660STS, 9670STS, 9750STS, 9760STS, 9770STS, 9860STS, 9870STS, S550	Idler Pulley, Discharge Beater Drive 1.437" Overall Width, 7.992" Diameter, 0.637" Bore Diameter, 1" Groove Width Replaces AH85276, AH165366	AMAH97031	\$ 33.07	
9560STS, 9570STS, 9650STS, 9660STS, 9670STS, 9750STS, 9760STS, 9770STS, 9860STS, 9870STS, S550 SN 745100-764999, S650 ASN 765000, (S670, S680, S690 ASN 745100)	Front Wear Plate Smooth, Solid, Hardened	AMH166689	\$ 15.33	

John Deere®—Combine

John Deere®—Combine

Application	Description	Part Number	Retail Price	Core
9560STS, 9570STS, 9650STS, 9660STS, 9670STS, 9750STS, 9760STS, 9770STS, 9860STS, 9870STS, S550, S660, S670, S680, S690	Feed Accelerator Plate Serrated, Hardened	AMH165407	\$ 17.00	
9560STS, 9570STS, 9650STS, 9660STS, 9670STS, 9750STS, 9760STS, 9770STS, 9860STS, 9870STS, S650 ASN 765000, (S660, S670, S680, S690 ASN 745100)	Front Wear Plate Hardened Angle Serrated	AMH201914	\$ 23.12	
S560, S650, S660, S670, S680, S690, S760, S770, S780, S790	Wear Plate, Feed Accelerator	AMHXE111121	\$ 15.37	
9560STS, 9570STS, S550	Rear Beater Shaft 52.31" Long	AMH202622	\$ 356.47	
	Wear Strip, Discharge Beater	AMH202621	\$ 68.19	
9600, 9610, 9650, 9660	Beater Grate, Wide Body	AMAH151120	\$ 567.47	
	Beater Shaft 72.12" Long	AMH126940	\$ 341.32	
	Beater Blade	AMH147788	\$ 104.00	
9650CTS	Double Idler Pulley, Beater Drive 3.25" Wide, 8" OD, 0.50" Bore Diameter Replaces AH87119	AMAH93318	\$ 59.09	
9650CTS, 9660CTS, 9780CTS, CTS, CTS II	Beater Shaft 66.25" Long	AMH146326	\$ 455.12	
9650STS, 9660STS, 9670STS, 9750STS, 9760STS, 9770STS, 9860STS, 9870STS	Beater Shaft, Rear Discharge 65" Long	AMH161010	\$ 365.11	
	Beater Wing Support	AMH166181	\$ 87.00	
9650STS, 9660STS, 9670STS, 9750STS, 9760STS, 9770STS, 9860STS, 9870STS, S650 ASN 765000, (S660, S670, S690 ASN 745100), S680 HillMaster BSN 765000, S690 HillMaster SN 745101-765000	Backup Strip	AMH165408	\$ 18.25	
9650STS, 9660STS, 9670STS, 9750STS, 9760STS, 9770STS, 9860STS, 9870STS, S650, S660, S670, S680, S690, S760, S770, S780, S785, S790	Front Feed Accelerator Shaft 63.69" Long	AMH158386	\$ 366.71	
9650STS, 9660STS, 9670STS, 9750STS, 9760STS, 9860STS, 9870STS, S650 ASN 750000, (S660, S670, S680, S690, ASN 745100), S680HM BSN 765000, S690HM SN 745101-765000	Beater Wing Support Replaces H166383	AMH221379	\$ 90.00	
9650STS, 9660STS, 9750STS, 9760STS, 9860STS	Rear Beater Fin Discharge Beater Wear Plate, Serrated	AMH209762	\$ 40.00	
	Rear Beater Fin Discharge Beater Wear Plate, Serrated, Chrome	AMH209762C	\$ 96.94	
9660STS, (9670STS, 9770STS BSN 730200), 9760STS, 9860STS	Wear Strip, Discharge Beater (10) Required Replaces H221355	AMH236279	\$ 43.77	
9670STS, 9770STS, S650, S660, S670, S670HM	Discharge Beater Blade Support	AMH236283	\$ 100.00	
(9670STS, 9770STS ASN 730201), S650 ASN 765000, (S660, S670 ASN 745100)	Wear Strip (10) Required	AMH236284	\$ 32.00	
S670 BSN 785001	Idler Pulley, Overshot Beater Drive 1.437" Overall Width, 7.992" Diameter, 0.637" Bore Diameter, 1" Groove Width Replaces AH85276, AH165366	AMAH97031	\$ 33.07	

John Deere®—Combine



Unloading Auger Swing Cylinders

Application	Description	Part Number	Retail Price	Core
(6620, 7720, 7721, 8820 BSN 600000), 6622 BSN 610400	Unloading Auger Swing Cylinder Kit Eyelet Style	AMX27187	\$ 500.00	
	Components:			
	Cylinder End, Female	1 AMAH107894	\$ 45.00	
	Cylinder End, Male	1 AMAH107895	\$ 45.00	
	Cylinder	1 AMAH174662	\$ 535.00	
	Nut	2 AM14H904	\$ 1.45	
(6620, 7720, 7721, 8820 ASN 600001), 9400 BSN 650100, 9500 BSN 650200, 9600 BSN 650300, CTS	Unloading Auger Swing Cylinder Kit Block Style	AMX27186	\$ 600.00	
	Components:			
	Cylinder	1 AMAH132210	\$ 525.00	
	Cylinder End	1 AMH137225	\$ 55.00	
	Nut	1 AMW13288	\$ 2.25	
9400 ASN 650101, 9410, 9450 BSN 695100, 9500 ASN 656569, 9510, 9510SH, 9550, 9550SH, 9600, 9610, 9650 BSN 695300, 9650CTS BSN 695400, CTS, CTS II	Unloading Auger Swing Cylinder Replaces AH145030, AH166484	AMAH176383	\$ 454.00	
9450, 9550, 9550SH, 9560, 9560SH, 9650, 9650CTS, 9660, 9660CTS	Unloading Auger Swing Cylinder	AMAH176381	\$ 517.00	
9560STS, 9570STS, 9650STS ASN 695501, 9660STS, (9670STS, 9770STS, 9870STS BSN 735100), 9750STS ASN 695601, 9760STS, 9860STS	Unloading Auger Swing Cylinder Replaces AH176274	AMAH176382	\$ 480.00	
(9670STS, 9770STS, 9870STS ASN 735101)	Unloading Auger Swing Cylinder	AMAH236427	\$ 480.00	
S550 SN 745100-764999, S650 ASN 765000, S660 SN 745100-785000	Unloading Auger Swing Cylinder	AMAH10669	\$ 517.00	
(S650 BSN 785001, S660, S670 w/ Grain Tank Doors Excluding 26' System, S670HM, S760 Excluding 26' and 28.50' Systems, S770 Excluding 26' and 28.50' Systems - w/ High Unload Rate), S680*, S690*, (S680HM, S690HM - w/ 22' System w/ or w/o Grain Tank Doors), (S780, S790 - w/ 22.50' System w/ or w/o Grain Tank Doors) *Will fit S680 and S690 if they fit the following criteria: - BSN 785001 w/ 22' System w/ or w/o Grain Tank Doors - SN 775001-785000 w/ 26' System w/ Grain Tank Doors - ASN 766006 w/ 22.50' System w/ or w/o Grain Tank Doors	Unloading Auger Swing Cylinder	AMAH10618	\$ 517.00	

Augers & Components—Lower Clean Grain

All augers are made with continuous roll-formed fighting for accuracy and durability.



Application	Description	Part Number	Retail Price	Core
4400, 4420	Lower Clean Grain Auger 63" Long, 6" Right Hand Fighting, 1" Shaft Diameter	AMAH76772	\$ 197.29	
6600	Lower Clean Grain Auger Extended Wear, 70 1/4" Overall Length, Right Hand Fighting, 6 3/4" Fighting Diameter, 1 1/4" Shaft Diameter, 7 1/2" Pitch	AMAH91468	\$ 200.00	
	Bearing	NPS100RPC	\$ 6.50	
6620	Lower Clean Grain Auger Extended Wear, 70 1/4" Overall Length, Right Hand Fighting, 6 3/4" Fighting Diameter, 1 1/4" Shaft Diameter, 7 1/2" Pitch	AMAH91283	\$ 221.00	
	Bearing - (2) Required	SA207-20	\$ 14.40	

John Deere®—Combine

John Deere®—Combine

Application	Description	Part Number	Retail Price	Core
7700	Lower Clean Grain Auger Extended Wear, 83" Long	AMAH91469	\$ 334.84	
	Bearing	NPS100RPC	\$ 6.50	
7720	Lower Clean Grain Auger Extended Wear, 72" Overall Length, Right Hand Flighting, 6 3/4" Flighting Diameter, 1 1/4" Shaft Diameter, 7 1/2" Pitch Replaces AH91284	AMAH107442	\$ 221.00	
	Bearing - (2) Required	SA207-20	\$ 14.40	
8820 BSN 464351	Lower Clean Grain Auger Extended Wear, 84" Overall Length, Right Hand Flighting, 6 3/4" Flighting Diameter, 1 1/4" Shaft Diameter, 7 1/2" Pitch Replaces AH91285	AMAH107400	\$ 268.00	
	Bearing - (2) Required	SA207-20	\$ 14.40	
8820 ASN 464351	Lower Clean Grain Auger Extended Wear, 84" Overall Length, Right Hand Flighting, 6 3/4" Flighting Diameter, 1 1/4" Shaft Diameter, 7 1/2" Pitch For Wide Elevator	AMAH105856	\$ 231.00	
	Bearing - (2) Required	SA207-20	\$ 14.40	
9400, 9500, 9410, 9510, CTS, CTS II	Lower Clean Grain Auger Extended Wear, 79 3/8" Overall Length, Right Hand Flighting, 8 1/2" Flighting Diameter, Shaft Diameter - 1.181" and 0.984", 6 1/2" Pitch	AMAH141577	\$ 310.00	
	Bearing	SA206-30MMG	\$ 14.40	
9450, 9550 9550SH, 9560, 9560SH, 9650CTS, 9650STS, 9660CTS, 9660STS, 9670STS, 9750STS, 9760STS, 9770STS w/ Standard Load System, 9860STS, S660, S670 Regular Capacity SN 745100-765252, S760	Lower Clean Grain Auger Extended Wear, 82" Overall Length, Right Hand Flighting, 8 1/2" Flighting Diameter, Shaft Diameter - 1 3/8" and 1", 8 1/2" Pitch	AMAH162154	\$ 478.00	
	Bearing	AMJD39102	\$ 11.00	
9560STS, 9570STS	Lower Clean Grain Auger Extended Wear, 71 1/4" Overall Length, Right Hand Flighting, 8 1/2" Flighting Diameter, Shaft Diameter - 1 3/8" and 1", 8 1/2" Pitch	AMAH218246	\$ 378.00	
	Bearing w/ Collar	AMJD10384	\$ 22.00	
9600, 9610	Lower Clean Grain Auger Extended Wear, 78 1/4" Overall Length, Right Hand Flighting, 8 1/2" Flighting Diameter, Shaft Diameter - 1.181" and 1", 8 1/2" Pitch Replaces AH133374	AMAH141576	\$ 315.00	
	Bearing	SA206-30MMG	\$ 14.40	
9650W, 9660W	Lower Clean Grain Auger Extended Wear, 93" Overall Length, Right Hand Flighting, 8 1/2" Flighting Diameter, Shaft Diameter - 1 3/8" and 1", 8 1/2" Pitch	AMAH162153	\$ 499.00	
	Bearing w/ Collar	AMJD10384	\$ 22.00	
9770STS, 9870STS, S670 High-Rate SN 745100-765252, S680	Lower Clean Grain Auger Extended Wear, 82 1/4" Overall Length, Right Hand Flighting, 9 1/2" Flighting Diameter, Shaft Diameter - 1.769" and 0.984", 9 1/2" Pitch Replaces AXE59539	AMAH219339	\$ 604.00	
	Bearing	AMJD39102	\$ 11.00	
6600, 7700, 7720, 8820	Lower Clean Grain Auger Cover	AMH77058	\$ 65.00	
6620, 7720, 8820	Clean Grain Auger Trough Door	AMH98488	\$ 159.00	
6620 Titan II	Clean Grain Auger Trough Door	AMH98486	\$ 95.00	
7720 Titan II, 8820 Titan II	Clean Grain Auger Trough Door	AMH98487	\$ 120.00	

John Deere®—Combine

John Deere®—Combine

Application	Description	Part Number	Retail Price	Core
9400, 9410, 9450, 9500, 9510, 9550, 9650STS, 9660STS, 9670STS, 9750STS, 9760STS, 9770STS, 9860STS, 9870STS	Clean Grain Auger Trough Door	AMAH139388	\$ 190.00	
9400, 9410, 9500, 9500SH, 9510, 9510SH, 9550, 9550SH, 9560, 9560SH, 9650STS, 9660CTS, 9660STS, 9670STS, 9750STS, 9760STS, 9770STS, 9860STS, 9870STS	Clean Grain Auger Trough Door, Perforated Replaces AH117281	AMAH139389	\$ 209.23	
9600, 9610, 9650, 9660	Clean Grain Auger Trough Door Solid w/ Protective Plate	AMAH139390	\$ 302.31	
9600, 9610, 9650W, 9660W	Clean Grain Auger Trough Door	AMAH139386	\$ 268.00	
9600, 9610, 9650, 9660	Lower Clean Grain Auger Trough Door Perforated	AMAH139387	\$ 252.95	
9400, 9410, 9450, 9500, 9510, 9510SH, 9550, 9550SH, 9560, 9560SH, 9650, 9650CTS, 9650STS, 9660CTS, 9660STS, 9670STS, 9750STS, 9760STS, 9770STS, 9860STS, CTS, CTS II	Lower Clean Grain Auger Door Solid w/ Protective Plate Replaces AH118251	AMAH139391	\$ 204.28	
9400, 9500, 9500SH, 9600 BSN 670301, CTS BSN 670401	Bearing Flange, Lower Clean Grain Auger	AME10018	\$ 2.40	
(S650, S660, S670 BSN 775001 and ASN 785000), S670HM, S680, S680HM, S690HM, S760, S770, S780, S790 ASN 1ZHOS790XXX110000	Lower Clean Grain Auger Trough Door	AMAXE15954	\$ 294.00	

Unloading Auger Countershafts and Components



Application	Description	Part Number	Retail Price	Core
4400 ASN 110151, 4420	Unloading Auger Countershaft 64.66" Long	AMAH86633	\$ 100.00	
	Bearing	WPS100GPC	\$ 15.00	
6600*, 6602 *Can Replace AH75330 on models BSN 14301 if you purchase 11H237 key and 14H874 Nut	Unloading Auger Countershaft 75.599" Long	AMAH86634	\$ 100.00	
	Bearing	WPS100GPC	\$ 15.00	
6620	Unloading Auger Countershaft 76" Long	AMAH130467	\$ 315.00	
	Bearing - (2) Required	AMJD9274	\$ 24.07	
7700* *Can Replace AH75331 on models BSN 14301 if you purchase 11H237 key and 14H874 Nut	Unloading Auger Countershaft 85.412" Long	AMAH86635	\$ 145.00	
	Bearing	WPS100GPC	\$ 15.00	
7720	Unloading Auger Countershaft 86.88" Long	AMAH130468	\$ 297.07	
	Bearing - (2) Required	AMJD9274	\$ 24.07	
9400, 9410, 9500, 9510, 9510SH, 9600, 9610, CTS, CTS II	Unloading Auger Countershaft 14.38" Long	AMH133024	\$ 99.50	
	Bearing - (2) Required	AMJD39104	\$ 20.00	
9450, 9550, 9550SH, 9560, 9560SH, 9650, 9650CTS, 9660, 9660CTS	Unloading Auger Countershaft 14.38" Long	AMH164212	\$ 218.05	
	Bearing - (2) Required	AMJD39104	\$ 20.00	
9560STS, 9570STS, 9650STS, 9660STS, 9670STS, 9750STS, 9760STS, 9770STS, 9860STS, 9870STS	Unloader Drive Jackshaft 22.12" Long Replaces H208598, H212900, H219352	AMH219352	\$ 180.38	
	Bearing - (2) Required	AMJD39104	\$ 20.00	

Prices Subject to Change without Prior Notice. The use of original equipment manufacturer (OEM) part numbers or trademarks, e.g. Case® and John Deere®, are for reference purposes only and for indicating product use and compatibility. Our company and the listed replacement parts contained herein are not sponsored, approved or manufactured by the OEM. All parts are New unless designated Reman in the description.

John Deere®—Combine

Application	Description	Part Number	Retail Price	Core
9400, 9410, 9500, 9501, 9510, 9600, 9610, CTS, CTS II	Pulley 0.895" Wide, 17.50" OD, 4.504" Bore Diameter For Unloading Auger Countershaft Drive	AMAH106096	\$ 96.89	
9560STS, 9650STS, 9660STS, 9750STS, 9760STS, 9860STS	Unloading Auger Drive Pulley Hub Replaces H150846, H212687	AMH215595	\$ 120.78	
9560STS, 9570STS, 9650STS, 9660STS, 9670STS, 9750STS, 9760STS, 9770STS, 9860STS, 9870STS	Unloading Auger Sprocket Use w/ AMH215595 Unloader Drive Pulley Hub	AMAH215152	\$ 71.79	
9570STS, 9670STS, 9770STS, 9870STS	Unloading Auger Drive Pulley Hub	AMH223290	\$ 102.99	
9400, 9410, 9500, 9500SH, 9510, 9510SH, 9560, 9560SH, 9600, 9610, 9660, 9660CTS, CTS, CTS II	Unloading Auger Drive Hub, 4-Bolt 1.811" Long, 1.378" ID, 3.74" OD	AMH133026	\$ 44.00	
9400, 9410, 9500, 9500SH, 9510, 9510SH, 9600, 9610, CTS, CTS II	Unloading Auger Drive Hub 6.298" OD, 1.38" Bore Diameter	AMH133025	\$ 76.97	
6620, 7720, 8820	Bearing w/ Lock Collar, Unloading Auger Countershaft	AMJD9274	\$ 24.07	
6620, 7720	Bearing Flange, Unloading Auger Countershaft	AME10018	\$ 2.40	
9400 ASN 670636, 9410, 9450, 9500, 9500SH, 9510, 9510SH, 9550, 9550SH, 9560, 9560SH, 9560STS, 9600 ASN 671991, 9610, 9650, 9650CTS, 9650STS, 9660, 9660CTS, 9660STS, 9750STS, 9760STS, 9860STS, CTS ASN 670636, CTS II	Pressed Flanged Housing	AMH161529	\$ 3.15	

Augers & Components—Lower Return

All augers are made with continuous roll-formed flighting for accuracy and durability.



Application	Description	Part Number	Retail Price	Core
4400, 4420	Lower Return Auger 66 1/2" Long	AMAH76130	\$ 188.78	
	Bearing	NPS100RPC	\$ 6.50	
6600	Lower Return Auger 72 3/4" Overall Length, Left Hand Flighting, 4 1/2" Flighting Diameter, Shaft Diameter - 1"-8 UNC Thread and 1", 5" Pitch	AMAH75836	\$ 200.00	
	Bearing	NPS100RPC	\$ 6.50	
6620 BSN 610301	Lower Return Auger Extended Wear, 72 3/4" Long	AMAH93662	\$ 315.50	
	Bearing	NPS100RPC	\$ 6.50	
6620 ASN 610301, 6620 Titan II	Lower Return Auger 75 1/2" Overall Length, Left Hand Flighting, 4 3/4" Flighting Diameter, Shaft Diameter - 1 1/8"-7 UNC Thread and 1 1/4", 5 1/4" Pitch	AMAH122335	\$ 184.00	
	Bearing - (2) Required	SA207-20	\$ 14.40	
7700	Lower Return Auger 83" Long	AMAH76092	\$ 125.00	
	Bearing	NPS100RPC	\$ 6.50	
7720 BSN 610501	Lower Return Auger Extended Wear, 3 1/2" Overall Length, Left Hand Flighting, 4 3/4" Flighting Diameter, Shaft Diameter - 1 1/8"-7 UNC-2A Thread and 1", 5 1/4" Pitch	AMAH93663	\$ 226.00	
	Bearing	WPS100GPC	\$ 15.00	
	Bearing	SA207-20	\$ 14.40	

John Deere®—Combine

John Deere®—Combine

Application	Description	Part Number	Retail Price	Core
7720 ASN 610501, 7720 Titan II	Lower Return Auger 86 1/8" Overall Length, Left Hand Flighting, 4 3/4" Flighting Diameter, Shaft Diameter - 1 1/8"-7 UNC Thread and 1 1/4", 5 1/4" Pitch	AMAH122336	\$ 205.00	
	Bearing - (2) Required	SA207-20	\$ 14.40	
8820 BSN 610701	Lower Return Auger 97" Overall Length, Left Hand Flighting, 4 3/4" Flighting Diameter, Shaft Diameter - 1 1/8"-7 UNC Thread and 1 1/4", 5 1/4" Pitch	AMAH96279	\$ 257.00	
	Bearing - (2) Required	SA207-20	\$ 14.40	
9400, 9410, 9500, 9510, CTS	Lower Return Auger Extended Wear, 94 1/2" Overall Length, Left Hand Flighting, 5 1/4" Flighting Diameter, Shaft Diameter - 1.181" and 1.24"-M20X2.50" Spline, 5 1/4" Pitch	AMAH146322	\$ 236.00	
	Bearing - (2) Required	SA206-30MMG	\$ 14.40	
9560STS, 9570STS, S550 745100-764999	Lower Return Auger 61.312" Long, 0.375" Shaft Diameter, 6.50" Right Hand Flighting	AMAH202510	\$ 289.51	
	Bearing	AMJD39102	\$ 11.00	
	Bearing w/ Collar	AMJD10384	\$ 22.00	
9650STS, 9660STS, 9670STS, 9750STS, 9760STS, 9770STS, 9860STS, 9870STS, S650, S660, S670, S670HM, S760, S770	Lower Return Auger Extended Wear, 71 3/4" Overall Length, Right Hand Flighting, 6 1/2" Flighting Diameter, Shaft Diameter - 0.984" and 1.181", 7" Pitch	AMAH147472	\$ 210.00	
	Bearing	AMJD39102	\$ 11.00	
	Bearing w/ Collar	AMJD10384	\$ 22.00	
9600, 9610, 9650	Lower Return Auger 105 3/8" Overall Length, Left Hand Flighting, 5 1/4" Flighting Diameter, Shaft Diameter - 1.1811" and 1 1/4"-M20x2.50" Spline, 5 1/4" Pitch	AMAH146313	\$ 278.00	
	Bearing - (2) Required	SA206-30MMG	\$ 14.40	
S680, S680HM, S690, S690HM, S780, S790	Lower Return Auger, Right Hand	AMAH232830	\$ 415.00	
9650STS, 9750STS	Lower Return Auger Trough Replaces AH149399	AMAH201865	\$ 171.91	
3300, 4400, 4420, 6600, 6620, 7700, 7720	Return Auger Cover, Perforated	AMH75975	\$ 58.00	
6620 Titan II, 7720 Titan II, 8820 Titan II	Return Auger Cover, Solid	AMH118676	\$ 59.00	
8820	Return Auger Cover, Solid	AMH99488	\$ 62.00	
9400, 9410, 9450, 9500, 9510, 9550, 9600, 9610, 9650, 9660, 9650CTS, 9660CTS, CTS, CTS II	Return Auger Cover, Solid	AMH136054	\$ 39.65	
9400, 9410, 9450, 9500, 9500SH, 9510, 9510SH, 9550, 9550SH, 9560, 9560SH, 9650, 9660, 9660CTS, CTS, CTS II	Return Auger Cover, Perforated	AMH136055	\$ 64.86	
9400, 9410, 9450, 9500, 9500SH, 9501, 9510, 9510SH, 9550, 9550SH, 9560, 9560SH, 9560STS, 9600, 9610, 9650, 9650CTS, 9650STS, 9660, 9660CTS, CTS, CTS II	Upper & Lower Tailings Shaft	AMAH130570	\$ 55.00	
	Bearing - (2) Required	AMJD9313	\$ 11.00	
6620, 7720, 8820, 9400, 9410, 9450, 9500, 9500SH, 9510, 9510SH, 9550, 9550SH, 9560, 9560SH, 9600, 9610, 9650, 9650CTS, 9660, 9660CTS, CTS, CTS II	Lower Return Tightener Hub 6.56" OD, 1.129" Bore Diameter	AMH97574	\$ 58.00	

John Deere®—Combine

Application	Description	Part Number	Retail Price	Core
9400 ASN 640100, (9500, 9500SH ASN 640200), 9510, 9510SH, 9600 ASN 640300, 9610	Idler Pulley, Lower Tailings Auger Drive 1.437" Overall Width, 7.992" Diameter, 0.637" Bore Diameter, 1" Groove Width Replaces AH85276, AH165366	AMAH97031	\$ 33.07	
3300 ASN 150000, 4400 ASN 151500, 4420, 6600 ASN 000821, 6620, 7700 ASN 001100, 7720, 8820	Lower Tailings Auger Drive Spring	AMH82072	\$ 12.00	
9400, 9410, 9450, 9500, 9500SH, 9510, 9510SH, 9550, 9550SH, 9560, 9560SH, 9600, 9610, 9650, 9650CTS, 9660, 9660CTS, CTS, CTS II, S680, S680HM, S690, S690HM, S780, S785, S790	Bearing Flange, Lower Return Auger	AME10018	\$ 2.40	
6620 ASN 610301, 7720 ASN 610501, 8820	Roller Chain, Lower Return Auger Drive 41 Links, Size 50 Chain	AMAH141164	\$ 15.00	
9400, 9410, 9450, 9500, 9510, 9550, 9600, 9610, 9650, CTS	Roller Chain, Lower Return Elevator Drive 43 Links, Size 50 Chain	AMAH126239	\$ 17.00	

Augers & Components—Top Tailing Return

All augers are made with continuous roll-formed fighting for accuracy and durability.



Application	Description	Part Number	Retail Price	Core
3300, 4400, 4420	Upper Return Auger 34.125" Long, 0.875" Tube Diameter, 4" Right Hand Fighting	AMAH76573	\$ 178.96	
4400 ASN 151501, 4420, 6600 ASN 156501, 6620, 6622 ASN 610401, 7700 ASN 163901, 7701, 7720, 7721, 8820	Upper Tailing Return Auger, Left Hand 79.875" Long, 4.75" Right Hand Fighting	AMAH75436	\$ 277.52	
	Bearing w/ Locking Collar	AMJD8562	\$ 9.75	
6600, 6620 BSN 610301	Upper Tailing Return Auger 69" Long, 0.875" Tube Diameter, 4.75" Right Hand Fighting	AMAH75435	\$ 188.34	
	Bearing w/ Locking Collar	AMJD8562	\$ 9.75	
6620 ASN 610302	Upper Return Auger 69.562" Long	AMAH127650	\$ 316.22	
	Bearing w/ Locking Collar	AMJD8562	\$ 9.75	
7720 ASN 610502	Upper Return Auger 80.69" Long	AMAH127651	\$ 281.36	
	Bearing w/ Locking Collar	AMJD8562	\$ 9.75	
8820	Upper Return Auger 91.25" Long Replaces AH98031, AH117426, AH127652	AMAH127652	\$ 352.00	
	Bearing	WPS100GPC	\$ 15.00	
9400, 9410, 9450, 9500, 9500SH, 9510SH, 9550, 9550SH, 9560, 9560SH, 9650CTS, 9660CTS, CTS, CTS II	Upper Tailing Return Auger 63.062" Long	AMAH125895	\$ 200.00	
	Bearing - (2 Required)	AMJD39102	\$ 11.00	
9560STS, 9570STS	Upper Return Auger 25.69" Long, 0.983" Shaft Diameter, 5" Fighting Diameter, Left Hand Rotation	AMAH202519	\$ 188.83	
	Bearing - (2) Required	AMAH129451	\$ 16.66	
9570STS, 9650STS, 9660STS, 9670STS, 9750STS, 9760STS, 9770STS, 9860STS, S650, S660, S670, S680, S690, S760, S770	Upper Tailing Return Auger 28.25" Long, 5.75" Left Hand Fighting Replaces AH147529	AMAH209421	\$ 152.00	
	Bearing - (2) Required	AMAH168161	\$ 16.00	
9600, 9610, 9650, 9660	Upper Tailing Return Auger 57.75" Long	AMAH125894	\$ 189.00	
	Bearing - (2) Required	AMJD39102	\$ 11.00	

John Deere®—Combine

John Deere®—Combine

Application	Description	Part Number	Retail Price	Core
9400, 9410, 9450, 9500, 9510, 9510SH, 9550, 9550SH, 9560, 9560SH, 9660, 9660CTS, CTS, CTS II	Auger Tube Housing Replaces AH137291, AH137581, AH141572	AMAH149180	\$ 1001.43	
	Bearing - (2) Required	SA206-30MMG	\$ 14.40	
9400, 9410, 9450, 9500, 9500SH, 9501, 9510, 9510SH, 9550, 9550SH, 9560, 9560SH, 9560STS, 9600, 9610, 9650, 9650CTS, 9650STS, 9660, 9660CTS, CTS, CTS II	Upper & Lower Tailings Shaft	AMAH130570	\$ 55.00	
9400, 9410, 9450, 9500, 9500SH, 9501, 9510, 9510SH, 9550, 9550SH, 9560, 9560SH, 9560STS, 9600, 9610, 9650, 9650CTS, 9650STS, 9660, 9660CTS, 9670STS, 9770STS, 9860STS, 9870STS, CTS, CTS II, S550, S660, S670	Upper Tailing Return Drive Sprocket 30 Tooth	AMAH126008	\$ 34.50	
9560STS, 9570STS, 9660STS, 9670STS, 9750STS, 9760STS, 9770STS, 9860STS, 9870STS, S550 SN 745100-764999, S650 ASN 765000, (S660, S670 ASN 745100), S670HM BSN 765000, S680 SN 766007-785000, S690 SN 765250-785000	Upper Tailing Return Drive Sprocket 19 Tooth, 0.987" Bore	AMAH147557	\$ 30.00	
9400, 9410, 9450, 9500, 9500SH, 9510, 9510SH, 9550, 9550SH, 9600, 9610, 9650, 9650CTS, 9660, 9660CTS, 9780CTS ASN 072800, CTS, CTS II	Upper Tailing Return Auger Sprocket 22 Tooth, 0.987" Bore	AMAH121046	\$ 44.00	
9560STS, 9570STS, 9650STS, 9660STS, 9670STS, 9750STS, 9760STS, 9770STS, 9860STS, 9870STS, S550, (S650, S660, S670, S680, S690 BSN 785001), S670HM, S680HM, S690HM, S770	Ball Bearing, Upper Return Auger w/ Lock Collar 0.984" ID, 2.441" OD	AMAH129451	\$ 16.66	
9400, 9410, 9450, 9500, 9500SH, 9510, 9510SH, 9550, 9550SH, 9560, 9560SH, 9560STS, 9570STS, 9600, 9610, 9650, 9650STS, 9660, 9660CTS, 9660STS, 9750STS, 9760STS, 9860STS, CTS, CTS II, S550, S650, S660, S670, 670HM, S680 SN 766007-785000, S690 SN 765250-785000, S760, S770	Bearing Flange, Upper Return Auger	AME10018	\$ 2.40	
6620, 7720, 8820	Roller Chain, Upper Return Auger Drive 52 Links, Size 50 Chain	AMAH141163	\$ 16.00	
9400, 9410, 9450, 9500, 9510, 9550, 9600, 9610, 9650, CTS	Roller Chain, Upper Return Auger Drive 124 Links, Size 50 Chain	AMAH126007	\$ 43.00	

Augers—Grain Bin Loading

All augers are made with continuous roll-formed flighting for accuracy and durability.



Application	Description	Part Number	Retail Price	Core
6600 ASN 156501	Grain Bin Loading Auger Extended Wear, 66 1/2" Overall Length, Left Hand Flighting, 7" Flighting Diameter, 1" Shaft Diameter, 8" Pitch	AMAH90624	\$ 285.00	
	Bearing	WPS100GPC	\$ 15.00	
6620, 7700 ASN 163901	Grain Bin Loading Auger Extended Wear, Single Flight Auger, 72" Overall Length, Left Hand Flighting, 7" Flighting Diameter, Shaft Diameter - 1" and 1 1/2", 8" Pitch	AMAH127728	\$ 260.00	
	Bearing	WPS100GPC	\$ 15.00	
7720	Grain Bin Loading Auger Extended Wear, Double Flight Auger, 75" Overall Length, Left Hand Flighting, 7 3/4" Flighting Diameter, 1" Shaft Diameter, 8 1/2" Pitch	AMAH127729	\$ 331.00	
	Bearing	WPS100GPC	\$ 15.00	

John Deere®—Combine

John Deere®—Combine





Application	Description	Part Number	Retail Price	Core
8820	Grain Bin Loading Auger Extended Wear, Double Flight Auger, 76 3/4" Overall Length, Left Hand Flighting, 7 3/4" Flighting Diameter, 1" Shaft Diameter, 8 1/2" Pitch Replaces AH98032, AH106608, AH108171, AH113813	AMAH127730	\$ 320.00	
	Bearing	WPS100GPC	\$ 15.00	
9400 BSN 640101, 9500 BSN 641201	Grain Bin Loading Auger Extended Wear, 48 3/16" Overall Length, Right Hand Flighting, 7 1/4" Flighting Diameter, Shaft Diameter - M12-1.75MM Internal Spline, 7 1/4" Pitch	AMAH136091	\$ 289.00	
	Bearing	SA206-19G	\$ 12.35	
9400 ASN 640101, 9410, 9500 ASN 641201, 9510, 9550, CTS, CTS II	Grain Bin Loading Auger Extended Wear, 50 7/16" Overall Length, Right Hand Flighting, 8 1/4" Flighting Diameter, Shaft Diameter - M12-1.75MM Internal Spline, 8 1/4" Pitch	AMAH136635	\$ 399.00	
	Bearing	SA206-19G	\$ 12.35	
9400, 9410, 9500, 9500SH, 9510, 9510SH, CTS, CTS II	Grain Bin Loading Auger - Upper Extended Wear , Upper Half of 2-Piece Fold Down Grain Bin Loading Auger 28 1/2" Overall Length, Right Hand Flighting, 8 1/4" Flighting Diameter, Shaft Diameter - M12-1.75MM Internal Spline, 8 1/4" Pitch	AMAH146509	\$ 263.00	
	Grain Bin Loading Auger - Lower Extended Wear, Lower Half of 2-Piece Fold Down Grain Bin Loading Auger 23 15/16" Overall Length, Right Hand Flighting 8 1/4" Flighting Diameter, Shaft Diameter - 1.249"-M24x3.00" Internal Spline, 8 1/4" Pitch	AMAH146214	\$ 394.00	
	Bearing - 1 per auger	SA206-19G	\$ 12.35	
9450, 9550, 9550SH, 9560, 9560SH, 9650, 9650CTS, 9650STS, 9660, 9660CTS, 9660STS, 9670STS, 9750STS, 9760STS, 9860STS, S650 BSN 785001, (S660, S670 BSN 765253, S760 BSN 805001 - Regular Capacity)	Grain Bin Loading Auger Extended Wear-Sectional, 56 5/8" Overall Length, Right Hand Flighting, 10" Flighting Diameter, 1.181" Shaft Diameter, 9 1/2" Pitch Replaces AH154330, AH204566, AH205897	AMAH218485	\$ 546.00	
	Bearing w/ Collar	AMJD10384	\$ 22.00	
9450, 9550, 9650, 9650CTS, 9650STS, 9660CTS, 9660STS, 9750STS, 9760STS	Grain Bin Loading Auger Extended Wear-Sectional, Abrasive Resistant, 52 1/8" Overall Length, Right Hand Flighting, 9 1/2" Flighting Diameter, M12-1.75MM Internal Spline Shaft Diameter, 9 1/2" Pitch w/o Bearing Support Replaces AH204563, AH205897	AMAH154330	\$ 541.00	
	Bearing	SA206-19G	\$ 12.35	
9560STS	Grain Bin Loading Auger When replacing the early original auger, AMJD10384 Bearing is required	AMAH205605	\$ 473.00	
	Bearing	SA206-19G	\$ 12.35	
9560STS, 9570STS	Grain Bin Loading Auger 51.875" Long When replacing the early original auger, AMJD10384 Bearing is required	AMAH223220	\$ 578.26	
	Bearing w/ Collar	AMJD10384	\$ 22.00	
9600 BSN 640301	Grain Bin Loading Auger Extended Wear, 57 5/8" Overall Length, Right Hand Flighting, 8 1/4" Flighting Diameter, Shaft Diameter - M12-1.75MM Internal Spline, 8 1/4" Pitch	AMAH136092	\$ 336.00	
	Bearing	SA206-19G	\$ 12.35	

John Deere®—Combine

John Deere®—Combine

Application	Description	Part Number	Retail Price	Core
9600 ASN 640301, 9610	Grain Bin Loading Auger Extended Wear, 57 5/8" Overall Length, Right Hand Flighting, 9 1/4" Flighting Diameter, Shaft Diameter - M12-1.75MM Internal Spline, 9 1/4" Pitch	AMAH136636	\$ 331.00	
	Bearing	SA206-19G	\$ 12.35	
9600, 9610	Grain Bin Loading Auger - Upper Extended Wear, 37 1/8" Overall Length, Right Hand Flighting, 9 1/4" Flighting Diameter, M12-1.75MM Internal Spline Shaft Diameter, 9 1/4" Pitch Upper Half of 2-Piece Fold Down Grain Bin Loading Auger	AMAH146553	\$ 295.00	
	Grain Bin Loading Auger - Lower Extended Wear, 30 1/8" Overall Length, Right Hand Flighting, 9 1/4" Flighting Diameter, Shaft Diameter - 1.62" and 24 Internal Spline, 9 1/4" Pitch Lower Half of 2-Piece Fold Down Grain Bin Loading Auger	AMAH146215	\$ 394.00	
	Bearing - 1 per auger	SA206-19G	\$ 12.35	
9770STS, 9870STS, (S670, S760 ASN 785000, S770 - High Capacity)	Grain Bin Loading Auger Extended Wear-Sectional, 57 1/8" Overall Length, Right Hand Flighting, 11" Flighting Diameter, 1.181" Shaft Diameter, 10 1/2" Pitch Replaces AH218258	AMAH230013	\$ 641.00	
	Bearing w/ Collar	AMJD10384	\$ 22.00	
S660, S670, S670HM, S680HM, S690HM, S760, S770	Grain Bin Loading Auger 300 Bushel Power Fold Replaces AXE69564	AMAXE13122	\$ 604.00	
	Bearing w/ Collar	AMJD10384	\$ 22.00	
S670 BSN 765253, S680, S690, S780, S790	Grain Bin Loading Auger 400 Bushel Power Fold and Manual Fold 64" Long, 11" Flighting Replaces AXE69563	AMAH233419	\$ 715.00	
	Bearing w/ Collar	AMJD10384	\$ 22.00	
S670, S680, S690, S780, S790 - w/ 12" Diameter Auger Tube	Auger Liner 12-Gauge Steel, 53 1/4" Long	AMX29179	\$ 535.00	
9550, 9560STS, 9570STS, 9650, 9650STS, 9660, 9660STS, 9670STS, 9750STS, 9760STS, 9860STS, S650, S660, S670 - w/ 11" Diameter Auger Tube	Incline Auger Liner Repair Sleeve 12-Gauge Steel Includes Bolt Kit	AMX29114	\$ 535.00	
(9770STS, 9870STS, 9880STS, S670, S680, S690, S760, S770, S780 - w/ 12" Diameter Auger Tube)	Incline Auger Liner Repair Sleeve	AMX29167	\$ 535.00	











Auger Tubes—Grain Bin Loading

Application	Description	Part Number	Retail Price	Core
 6600 BSN 156501 w/ U-Joint Auger Drive	Grain Bin Loading Auger Tube	AMAH75997	\$ 275.72	
 6620, 7700 ASN 163901	Grain Bin Loading Auger Tube	AMAH88982	\$ 231.00	
 7700 BSN 163901 w/ U-Joint Auger Drive	Grain Bin Loading Auger Tube Replaces AH75997	AMAH77064	\$ 257.00	
 7720, 8820	Grain Bin Loading Auger Tube	AMAH98300	\$ 233.00	
 9400 BSN 640100, 9500 BSN 640200	Grain Bin Loading Auger Tube 23.25" Long, 8.75" ID	AMAH131903	\$ 131.00	



Prices Subject to Change without Prior Notice. The use of original equipment manufacturer (OEM) part numbers or trademarks, e.g. Case® and John Deere®, are for reference purposes only and for indicating product use and compatibility. Our company and the listed replacement parts contained herein are not sponsored, approved or manufactured by the OEM. All parts are New unless designated Reman in the description.

John Deere®—Combine

John Deere®—Combine

Application	Description	Part Number	Retail Price	Core
	9400 ASN 640101, 9500 ASN 640201, 9410, 9510, CTS, CTS II	Grain Bin Loading Auger Tube 22.125" Long	AMAH135444	\$ 131.00
		Grain Bin Loading Auger Tube Stainless Steel	AMAH135445	\$ 280.00
		Auger Tube Support, Upper	AMAH135439	\$ 70.00
	9600 BSN 640300	Grain Bin Loading Auger Tube	AMAH131907	\$ 168.73
	9600 ASN 640301, 9610	Grain Bin Loading Auger Tube 28.25" Long 10.25" ID	AMAH135563	\$ 151.00
		Auger Tube Support, Upper	AMAH135558	\$ 53.00
	9450, 9550, 9560, 9650, 9650CTS, 9660, 9660CTS	Grain Bin Loading Auger Tube, Stainless Steel	AMAH211160	\$ 750.00
	9560STS, 9570STS, S550	Grain Bin Loading Auger Tube, Stainless Steel	AMAH219095	\$ 620.59
	9650STS, 9660STS, 9670STS, 9750STS, 9760STS, 9860STS, (S650, S670, S760 BSN 785001), S660	Grain Bin Loading Auger Tube, Stainless Steel High Wear w/o Pressure Flow Compensated Option Replaces AH219094	AMAH219093	\$ 595.00
	9650STS, 9660STS, 9670STS, 9750STS, 9760STS, 9860STS, S650, (S660, S670 - w/ Standard Auger)	Grain Bin Loading Auger Tube Regular Wear	AMAH219094	\$ 485.00
	9770STS, 9870STS	Grain Bin Loading Auger Tube High Wear	AMAH217983	\$ 600.00
	(S660, S670 BSN 785001 w/ Power Fold or All w/ Pressure Flow Compensated), (S670HM, S680HM, S690HM - w/ Power Fold), (S760 BSN 1H0S760XXX805001 & BSN 1Z0S760XXX115000, S770 BSN 1H0S770XXX805001, S780 BSN 1Z0S780XXX115000, S785 BSN 1Z0S785XXX115000, S790 BSN 1Z0S785XXX115000 - w/ Pressure Flow Compensated)	Grain Bin Loading Auger Tube 300 Bushel	AMAXE56593	\$ 1839.00
	S670	Grain Bin Loading Auger Tube Manual Fold	AMAXE12747	\$ 1129.00
	S680, S690, (S780, S790 BSN 1H0S780XXX805001 & BSN 1Z0S780XXX115000), S785 BSN 1Z0S785XXX115000	Grain Bin Loading Auger Tube 400 Bushel Power Fold Replaces AH233412	AMAXE56594	\$ 2035.00
	S680, S690, S780, S790	Grain Bin Loading Auger Tube 400 Bushel Manual Fold Replaces AXE21395	AMAXE56595	\$ 1871.00

John Deere®—Combine

Application	Description	Part Number	Retail Price	Core
 9400, 9410, 9450, 9500, 9500SH, 9510, 9510SH, 9550, 9550SH, 9560, 9560SH, 9560STS, 9570STS, 9600, 9610, 9650, 9650CTS, 9650STS, 9660, 9660CTS, 9660STS, 9670STS, 9750STS, 9760STS, 9770STS, 9860STS, 9870STS, CTS, CTS II	Grain Bin Loading Auger Driver 1.067" ID	AMH136186	\$ 36.75	
 9450, 9550, 9550SH, 9560, 9560SH, 9560STS, 9570STS, 9650, 9650CTS, 9650STS, 9660, 9660CTS, 9660STS, 9670STS, 9750STS, 9760STS, 9770STS, 9860STS, 9870STS, S550, S650, S660, S670, S670HM, S680, S680HM, S690, S690HM, S760, S770, S780, S790	Bearing w/ Collar, Grain Bin Loading Auger	AMJD10384	\$ 22.00	

Augers—Distribution



All augers are made with continuous roll-formed fighting for accuracy and durability.



Application	Description	Part Number	Retail Price	Core
6600, 6620, 7700, 7720, 8820	Distribution Auger 152 1/4" Overall Length, Right Hand and Left Hand Flighting, 4 5/8" Fighting Diameter, Shaft Diameter - 1" and 1 11/16", 5 1/4" Pitch	Right Hand AMAH95943	\$ 263.00	
	Distribution Auger Overall Length - 152 1/4", Right Hand and Left Hand Flighting, 4 5/8" Fighting Diameter, Shaft Diameter - 1" and 1 11/16", 5 1/4" Pitch	Left Hand AMAH95944	\$ 289.00	
	Bearing - (1) Required per Auger	WPS100GPC	\$ 15.00	
9400, 9500, 9600, 9410, 9510, 9610, CTS, CTS II	Distribution Auger 57 1/2" Overall Length, Right Hand Flighting, 5" Fighting Diameter, 1" Shaft Diameter, 5" Pitch Replaces AH169021	Right Hand AMAH130424	\$ 137.00	
	Distribution Auger 57 1/2" Overall Length, Left Hand Flighting, 5" Fighting Diameter, 1" Shaft Diameter, 5" Pitch	Left Hand AMAH130425	\$ 147.00	
	Bearing - (1) Required per Auger	WPS100GPC	\$ 15.00	
9560STS, 9570STS, 9650STS, 9660STS, 9670STS, 9750STS, 9760STS, 9770STS, 9860STS, 9870STS, S550, S660, S670, S680, S690, S760, S770, S780, S790	Distribution Auger "Extended Wear, 40 3/4" Overall Length, 6" Fighting Diameter, 1" Shaft Diameter, 6" Pitch"	Right Hand AMAH146787	\$ 100.00	
	Distribution Auger Extended Wear, 40 3/4" Overall Length, 6" Fighting Diameter, 1" Shaft Diameter, 6" Pitch	Left Hand AMAH146786	\$ 122.00	
9650STS, (9660STS, 9760STS BSN 711033), 9750STS, 9860STS BSN 710834	Rear Ball Bearing 2.047" ID, 1" OD Includes Lock Collar	AMAH159863	\$ 30.00	
9560STS, 9570STS, (9660STS, 9760STS ASN 711032), 9670STS, 9770STS, 9860STS ASN 710834, S650, S660, S670, S670HM, S680HM, S690, S690HM, S760, S770, S780, S785, S790	Bearing with Housing, Cleaning Shoe Auger 1" ID	AMAH163056	\$ 24.00	

John Deere®—Combine

Distribution Auger Wood Block Bearing Set

Application	Description	Part Number	Retail Price	Core
 All Models 6600 to 8820	Distribution Auger Wood Block Bearing Set	AMH84838	\$ 12.00	
 9400, 9410, 9450, 9500, 9500SH, 9501, 9510, 9510SH, 9550, 9550SH, 9560, 9560SH, 9600, 9610, 9650, 9650CTS, 9660, 9660CTS, C670, CTS, CTS II, T550, T560, T660, T670	Distribution Auger Wood Block Bearing Set Hardware Not Included	AMH135475	\$ 4.00	
 9400, 9500, 9600, 9410, 9510, 9610, CTS, CTS II	Distribution Auger Wood Block Bearing Set	AMH142188	\$ 5.75	

Distribution Auger Pans and Components

Application	Description	Part Number	Retail Price	Core
6620	Auger Pan, Front	AMAH131234	\$ 775.00	
7720	Auger Pan, Front	AMAH131235	\$ 945.00	
8820	Auger Pan, Front	AMAH131236	\$ 800.00	
9400, 9410, 9500, 9450, 9510, 9550, 9560, 9660CTS, CTS, CTS II	Distribution Pan	AMAH146655	\$ 826.79	
9600, 9610, 9650, 9660	Distribution Pan	AMAH146564	\$ 905.49	
(9660STS, 9760STS ASN 711032), 9670STS, 9770STS, 9860STS, 9870STS, S650 ASN 785000, S660, S670, S670HM, S680, S680HM, S690, S690HM, S760, S770, S780, S790	Distribution Pan Replaces AH218425	AMAXE62534	\$ 783.00	
9400, 9500, 9560, 9600, 9660	Auger Bed Liner, Shoe Supply Pan Stainless Steel	AMX29155	\$ 188.00	
9560STS, 9570STS, S550	Shoe Auger Drive Shaft 54" Long Replaces HXE119428	AMH202378	\$ 189.07	
3300, 4400, 4420, 6600, 6601, 6602, 6620, 6622, 7700, 7701, 7720, 7721, 8820, 9400, 9410, 9450, 9500, 9500SH, 9510, 9510SH, 9550, CTS, CTS II	Bevel Gear Replaces H75406	AMH137215	\$ 18.00	
9560STS, 9570STS, 9650STS, 9660STS, 9670STS, 9750STS, 9760STS, 9770STS, 9860STS, 9870STS, S650, S660, S670, S670HM, S680, S680HM, S690, S690HM, S760, S770, S780, S790	Bevel Gear, Conveyor Auger 13 Tooth Use w/ AMH171186 Drive Shaft Replaces H174745	AMH211285	\$ 32.00	

Auger Supply Shafts

Application	Description	Part Number	Retail Price	Core
4400, 4420	Auger Supply Shaft Replaces H77259	45.375" Long AMH83083	\$ 100.86	
6600, 6601, 6602, 6620	Auger Supply Shaft	52.025" Long AMH84498	\$ 95.00	
7700, 7701, 7720, 7721	Auger Supply Shaft	62.25" Long AMH84499	\$ 80.00	
8820	Auger Supply Shaft	73.75" Long AMH99635	\$ 141.86	
9400, 9410, 9450, 9500, 9500SH, 9510, 9510SH, 9550, 9550SH, 9560, 9560SH, 9650CTS, 9660CTS, CTS, CTS II	Auger Supply Shaft	65.44" Long AMH135422	\$ 204.00	
9600, 9610, 9650, 9660	Drive Shaft, Shoe Grain Supply	76.25" Long AMH135421	\$ 220.00	

John Deere®—Combine

John Deere®—Combine

Application	Description	Part Number	Retail Price	Core
9650STS, 9660STS, 9670STS, 9750STS, 9760STS, 9770STS, 9860STS, 9870STS, S650, S660, S670, S670HM, S680, S680HM, S690, S690HM, S760, S770, S780, S785, S790	Drive Shaft, Cleaning Shoe Replaces HXE116497	64.62" Long AMH171186	\$ 185.00	
9870STS, S650, (S660, S670, S680, S690 BSN 785001), S670HM, S680HM, S690HM	Drive Shaft, Cleaning Shoe Replaces H234556	67.69" Long AMH226032	\$ 223.21	
9400, 9410, 9450, 9500, 9500SH, 9510, 9510SH, 9550, 9550SH, 9560, 9560SH, 9560STS, 9600, 9610, 9650, 9650CTS, 9660, CTS, CTS II	Ball Bearing, Auger Supply Shaft w/ Lock Collar 0.984" ID, 2.441" OD	AMAH129451	\$ 16.66	
9560STS, 9650STS, 9660STS, 9750STS, 9760STS, 9860STS	Ball Bearing, Auger Supply Shaft	AMAH168161	\$ 16.00	
9570STS, 9670STS, 9770STS, 9870STS, S550, (S650, S660, S670, S680 BSN 785001), S670HM, S680HM, S690, S690HM	Ball Bearing, Auger Supply Shaft 3.346" ID, 5.118" OD	AMAH125975	\$ 39.56	
9400, 9410, 9450, 9500, 9500SH, 9510, 9510SH, 9550, 9550SH, 9560, 9560SH, 9560STS, 9570STS, 9600, 9610, 9650, 9650CTS, 9650STS, 9660, 9660CTS, 9660STS, 9670STS, 9750STS, 9760STS, 9860STS, CTS, CTS II, S550, (S650, S660, S670, S680, S690 SN 745100-785000), S670HM, S680HM, S690HM	Bearing Flange, Auger Supply Shaft	AME10018	\$ 2.40	

Augers—Bottom Bin Cross

All augers are made with continuous roll-formed flighting for accuracy and durability.



Application	Description	Part Number	Retail Price	Core
6600	Bottom Bin Cross Auger Extended Wear	AMLABB6600	\$ 670.00	
	Bearing	AM160796C91	\$ 11.84	
6600, 7700	Bottom Bin Cross Auger 6" Left Hand Flighting 42.375" Long, 1" Tube Diameter	AMAH76615	\$ 141.49	
	Bearing	AM160796C91	\$ 11.84	
6620	Front Bottom Bin Cross Auger Extended Wear, 102 1/8" Overall Length, Left Hand Flighting, 7 1/2" Flighting Diameter, 1 1/2" Shaft Diameter, 4 1/2" Pitch	AMAH98211	\$ 457.00	
	Bearing - (2) Required	SA208-24	\$ 20.50	
6620 BSN 600000	Rear Bottom Bin Cross Auger Extended Wear, 89 1/2" Overall Length, Left Hand Flighting, 7 1/2" Flighting Diameter, 1 1/2" Shaft Diameter, 4.50" Pitch	AMAH103727	\$ 462.00	
	Bearing - (2) Required	SA208-24	\$ 20.50	
6620 ASN 600001	Rear Bottom Bin Cross Auger	AMAH114715	\$ 499.41	
7700	Bottom Bin Cross Auger Extended Wear	AMLABB7700	\$ 599.00	
	Bearing	AM160796C91	\$ 11.84	
7720	Front Bottom Bin Cross Auger Extended Wear, 112 3/4" Overall Length, Left Hand Flighting, 7 1/2" Flighting Diameter, 1 1/2" Shaft Diameter, 4 1/2" Pitch	AMAH98212	\$ 520.00	
	Bearing - (2) Required	SA208-24	\$ 20.50	

John Deere®—Combine

John Deere®—Combine

Application	Description	Part Number	Retail Price	Core
7720 BSN 600000	Bottom Bin Cross Auger Extended Wear, 100 1/2" Overall Length, Left Hand Flighting, 7 1/2" Flighting Diameter, 1 1/2" Shaft Diameter, 4.50" Pitch	AMAH103728	\$ 478.00	
7720 ASN 600001	Rear Bottom Bin Cross Auger 100.375" Long	AMAH114716	\$ 497.22	
8820	Front Bottom Bin Cross Auger Extended Wear, 123 5/8" Overall Length, Left Hand Flighting, 7 1/2" Flighting Diameter, 1 1/2" Shaft Diameter, 4.50" Pitch	AMAH107393	\$ 462.00	
	Bearing - (2) Required	SA208-24	\$ 20.50	
8820 BSN 600000	Rear Bottom Bin Cross Auger Extended Wear, 111 3/8" Overall Length, Left Hand Flighting, 7 1/2" Flighting Diameter, 1 1/2" Shaft Diameter, 4.50" Pitch	AMAH103729	\$ 551.00	
	Bearing - (2) Required	SA208-24	\$ 20.50	
8820 ASN 600001	Rear Bottom Bin Cross Auger	AMAH114717	\$ 530.11	
9400, 9410, 9450, 9500, 9510, 9510SH, 9550, 9550SH, 9560, 9560SH, 9560STS, 9570STS, 9650CTS, 9650STS, 9660CTS, 9660STS, 9670STS, 9750STS, 9760STS, CTS, CTS II, S550, S650, S660 BSN 765172	Front Bottom Bin Cross Auger Regular Unloading Rate 112 7/16" Overall Length, Right Hand Flighting, 7 1/4" Flighting Diameter, 1 3/8", Shaft Diameter, 2" Tube Diameter, 9" Pitch Replaces AH125645, AH138398, AH154965, AH167847, AH201744	AMAXE18077	\$ 520.00	
	Rear Bottom Bin Cross Auger Regular Unloading Rate 112 7/16" Overall Length, Left Hand Flighting, 7 1/4" Flighting Diameter, 1 3/8" Shaft Diameter, 2" Tube Diameter, 9" Pitch Replaces AH125966, AH138399, AH154966, AH167848, AH201743	AMAXE18078	\$ 551.00	
	Bearing - (2) Required	AMJD39104	\$ 20.00	
9600, 9610, 9650, 9660	Front Bottom Bin Cross Auger Extended Wear-Sectional, Right Hand Flighting 123 5/16" Overall Length, 7 1/4" Flighting Diameter, 1 3/8" Shaft Diameter, 9" Pitch Replaces AH127975, AH138396, AH154697, AH167849	AMAH202875	\$ 525.00	
	Rear Bottom Bin Cross Auger Extended Wear-Sectional, Left Hand Flighting 123 5/16" Overall Length, 7 1/4" Flighting Diameter, 1 3/8" Shaft Diameter, 9" Pitch Replaces AH127976, AH138397, AH154968, AH167850	AMAH202881	\$ 509.00	
	Bearing - (2) Required	AMJD39104	\$ 20.00	
9660STS, (9670STS, 9760STS, 9770STS - High-Rate), 9860STS, 9870STS, S660, S670, S670HM, S680, S680HM, S690, S690HM, S760, S770, S780, S785, S790	Front Bottom Bin Cross Auger Extended Wear-Sectional, Right Hand Flighting 112 3/4" Overall Length, 9 1/2" Flighting Diameter, 1 3/8" Shaft Diameter, 11" Pitch Replaces AXE18081	AMAH202958	\$ 782.00	
	Rear Bottom Bin Cross Auger Extended Wear-Sectional, Left Hand Flighting 112 3/4" Overall Length, 9 1/2" Flighting Diameter, 1 3/8" Shaft Diameter, 11" Pitch Replaces AXE18082	AMAH202959	\$ 725.00	
	Bearing - (2) Required	AMJD39104	\$ 20.00	
9400, 9410, 9450, 9500, 9500SH, 9510, 9510SH, 9550, 9550SH, 9560, 9560SH, 9560STS, 9600, 9610, 9650, 9650CTS, 9650STS, 9660, 9660CTS, 9660STS, 9670STS, 9750STS, CTS, CTS II	Sprocket, Slow Down Rate Front or Rear Bottom Bin Cross Augers 60 Tooth, 1.575" Long, 1.381" Bore Diameter For Size 60 Chain	AMAH140001	\$ 99.00	

John Deere®—Combine

John Deere®—Combine

Application	Description	Part Number	Retail Price	Core
9400, 9410, 9450, 9500, 9500SH, 9510, 9510SH, 9550, 9550SH, 9560, 9560SH, 9560STS, 9570STS, 9600, 9610, 9650, 9650CTS, 9650STS, 9660, 9660CTS, 9660STS, 9670STS, 9750STS, 9760STS, CTS, CTS II	Sprocket, Front or Rear Bottom Bin Cross Augers 49 Tooth, 1.575" Overall Length, 1.381" Bore Diameter For Size 60 Chain Replaces AH126705	AMAH125070	\$ 96.25	
9660STS, 9670STS, 9760STS, 9770STS, 9860STS, 9870STS	Sprocket, High-Rate Front or Rear Bottom Bin Cross Augers 60 Tooth, 1.575" Long, 1.381" Bore Diameter For Size 60 Chain	AMAH140001	\$ 99.00	
S550, S650	Sprocket, 2.20 BPS Unloader Drive 49 Tooth, 1.575" Overall Length, 1.381" Bore Diameter For Size 60 Chain Replaces AH126705	AMAH125070	\$ 96.25	
S660, S670, S670HM, S680HM, S690HM, S760, S770	Sprocket, 3.30 and 3.80 BPS Unloader Drive 60 Tooth, 1.575" Long, 1.381" Bore Diameter For Size 60 Chain	AMAH140001	\$ 99.00	
6620, 7720, 7721, 7722, 8820	Roller Chain, Cross Auger Drive, Rear 104 Links, Size 50 Chain	AMAH87248	\$ 30.00	
6620, 7720, 7722, 8820	Roller Chain, Cross Auger Drive 109 Links, Size 60 Chain	AMAH97021	\$ 35.00	
9400, 9410, 9500, 9500SH, 9510, 9510SH, 9600, 9610, CTS, CTS II	Roller Chain, Cross Auger Drive 204 Links, 0.75" Pitch, Size 60H Chain For Slow Down Speed, Rice Replaces AH140004	AMAH146359	\$ 75.00	

Augers & Tubes—Vertical Unloading

All augers are made with continuous roll-formed flighting for accuracy and durability.



Application	Description	Part Number	Retail Price	Core
6620, 7720, 8820	Vertical Unloading Auger Extended Wear, Double Flight Auger 64 1/2" Overall Length, Left Hand Flighting, 13" Flighting Diameter, Shaft Diameter - 1 1/4"-19 Internal Spline and 1 3/4"-13 Internal Spline, 9" Pitch	AMAH123929	\$ 478.00	
9400, 9410, 9450 BSN 695101, 9500, 9500SH, 9510, 9510SH, 9550 BSN 695201, 9550SH BSN 695701, 9600, 9610, 9650 BSN 695301, 9650CTS BSN 695401, CTS, CTS II	Vertical Unloading Auger Extended Wear 43 7/16" Overall Length, Left Hand Flighting, 13" Flighting Diameter, Shaft Diameter - 1 1/4"-19 Internal Spline and 1 3/4"-13 Internal Spline, 9" Pitch Replaces AH171554	AMAH124852	\$ 473.00	
9450 ASN 695100, 9550 ASN 695200, 9550SH ASN 695700, 9560, 9560SH, 9650 ASN 695300, 9650CTS ASN 695400, 9660, 9660CTS	Vertical Unloading Auger Extended Wear, 40 1/2" Overall Length, Left Hand Flighting, 13" Flighting Diameter, Shaft Diameter - 1 1/4"-19 Internal Spline and 1 3/4"-13 Internal Spline, 9" Pitch	AMAH171550	\$ 448.00	
9560STS, 9650STS, (9660STS, 9760STS - w/ Standard Rate Unload), 9750STS	Vertical Unloading Auger Extended Wear, Double Flight Auger 30 4/2" Overall Length, Left Hand Flighting, 13" Flighting Diameter, Shaft Diameter - 1 1/4"-19 Internal Spline and 1 3/4"-13 Internal Spline, 9" Pitch	AMAH146840	\$ 446.00	
(9660STS, 9670STS, 9760STS - High Unloading Rate), 9770STS, 9860STS, 9870STS	Vertical Unloading Auger Extended Wear-Sectional 32" Overall Length, Left Hand Flighting, 15 1/4" Flighting Diameter, Shaft Diameter - 4 1/4"-25 Internal Spline and 1 3/4"-13 Internal Spline, 10 3/4" Pitch Replaces AXE12921	AMAH202956	\$ 866.00	
S550, S650, S660 BSN 765172 - w/ High Wear 1.90 and 2.20 BPS Unloading Systems	Vertical Unloading Auger 31.06" Long, Left Hand Flighting, 13" Flighting Diameter, 4.50" Tube Diameter Replaces AXE17156	AMAXE53849	\$ 740.20	

Prices Subject to Change without Prior Notice. The use of original equipment manufacturer (OEM) part numbers or trademarks, e.g. Case® and John Deere®, are for reference purposes only and for indicating product use and compatibility. Our company and the listed replacement parts contained herein are not sponsored, approved or manufactured by the OEM. All parts are New unless designated Reman in the description.

John Deere®—Combine

John Deere®—Combine

Application	Description	Part Number	Retail Price	Core
S660 (High-Rate), S670, S670HM, S680, S680HM, S690, S690HM, S760, S770, S780, S790	Vertical Unloading Auger Extended Wear-Sectional 32 1/4" Overall Length, Left Hand Flighting, 15 1/4" Flighting Diameter, Shaft Diameter - 4.063"-25 Internal Spline and 4.063"-20 Internal Spline, 10 1/2" Pitch	AMAXE18070	\$ 775.00	
9400, 9410, 9450, 9500, 9500SH, 9510, 9510SH, 9550, 9550SH, 9600, 9610, 9650, 9650STS, 9660, 9660CTS, 9660STS, 9750STS, 9760STS, 9860STS, CTS, CTS II	Vertical Unloading Auger Clean Out Spout	AMAH167433	\$ 121.76	
S550 SN 745100-764999, S650 ASN 765000, (S660, S670, S680, S690 ASN 745100), S670HM BSN 765000, S680HM BSN 765000, S690HM SN 745101-76500, S760, S770, S780, S785, S790, T550, T560, T670	Auger Gear Set, Vertical Unloading Includes (2) 23 Tooth Gears	AMDE20711	\$ 330.00	
9400, 9410, 9450, 9510, 9510SH, 9550, 9550SH, 9560, 9560SH, 9600, 9610, 9650, 9650CTS, 9660, 9660CTS, CTS, CTS II	Splined Coupler, Vertical Unloading Auger Lower	AMAH124878	\$ 103.50	
S550, S650, S660 BSN 765172	Roller Chain, 2.20 BPS Unloader Drive 258 Links, Size 60H Chain	AMAH144891	\$ 90.00	
S660 ASN 765171, S670, S670HM, S680HM, S690HM, S760, S770	Roller Chain, 3.30 and 3.80 BPS Unloader Drive 264 Links, Size 60H Chain Replaces AH161460, AH202176	AMAXE53952	\$ 95.00	
9560STS, 9570STS, 9650STS, 9660STS, 9670STS, 9750STS, 9760STS, 9770STS	Roller Chain, Standard Rate Unloader Drive 258 Links, Size 60H Chain	AMAH144891	\$ 90.00	
9560STS, 9570STS, 9650STS, 9660STS, 9670STS, 9750STS, 9760STS, 9770STS, 9860STS, 9870STS	Roller Chain, High Rate Unloader Drive Slow Down Speed 264 Links, Size 60H Chain Replaces AH161460, AH202176	AMAXE53952	\$ 95.00	
3300, 4400, 4420, 6600, 6602, 7700	Roller Chain, Unloading Auger Drive 122 Links, Size 50 Chain	AMAH141170	\$ 30.00	
9400, 9410	Roller Chain, Unloading Auger Drive 198 Links, Size 60 Chain	AMAH126836	\$ 60.00	
9400, 9410, 9500, 9500SH, 9510, 9510SH, 9600, 9610, CTS, CTS II	Roller Chain, Unloading Auger Drive 204 Links, 0.75" Pitch, Size 60H Chain For Slow Down Speed, Rice Replaces AH140004	AMAH146359	\$ 75.00	
9550, 9550SH, 9560, 9560SH, 9650, 9650CTS, 9660, 9660CTS	Roller Chain, Unloading Auger Drive 196 Links, 0.75" Pitch, Size 60H Chain For Regular Speed	AMAH157083	\$ 75.00	
9450, 9550, 9550SH, 9560, 9560SH, 9650, 9650CTS, 9660, 9660CTS	Roller Chain, Unloading Auger Drive 200 Links, 0.75" Pitch, Size 60H Chain Slow Speed, Rice	AMAH157084	\$ 75.00	
(9500, 9500SH - w/ 6076 Engine), 9510, 9510SH, 9600, 9610, CTS, CTS II	Roller Chain, Unloading Auger Drive 198 Links, 0.75" Pitch, Size 60H Chain For Regular Speed	AMAH126837	\$ 85.00	
S680, S690, S780, S790	Roller Chain, Unloading Auger Drive 197 Links, Size 80 Chain	AMAXE15956	\$ 150.00	
6620, 6622, 7720, 7721, 7722, 8820	Roller Chain, Vertical Auger Drive 132 Links, Size 60 Chain	AMAH141166	\$ 40.00	

Augers & Tubes—Horizontal Unloading

All augers are made with continuous roll-formed flighting for accuracy and durability.



Application	Description	Part Number	Retail Price	Core
3300 ASN 101300, 4400	Horizontal Unloading Auger Tube Replaces AH76608	137" AMAH87107	\$ 1327.31	

John Deere®—Combine

Application	Description	Part Number	Retail Price	Core
6600, 7700	Horizontal Unloading Auger Extended Wear	144" AMAH99394	\$ 553.00	
	Bearing	NPS100RPC	\$ 6.50	
6620, 7720, 8820	Horizontal Unloading Auger Tube (Outer)	144" AMAH145049	\$ 683.00	
	Horizontal Unloading Auger Extended Wear, Left Hand Flighting, 11 1/2" Flighting Diameter, Shaft Diameter - 1" and 1 1/4"-19 Internal Spline, 13" Pitch For 14' System Replaces AH97026, AH112451, AH116107, AH123436, AH132032	166 1/4" AMAH143731	\$ 693.00	
	Bearing	NPS100RPC	\$ 6.50	
	Horizontal Unloading Auger Tube (Outer)	180" AMAH145050	\$ 820.00	
9400, 9410, 9500, 9510, 9600, 9610	Horizontal Unloading Auger Extended Wear, Left Hand Flighting, 11 1/2" Flighting Diameter, Shaft Diameter - 1" and 1 1/4"-19 Internal Spline, 13" Pitch For 17' System Replaces AH96555, AH113501, AH116108, AH123437, AH132033	202 1/4" AMAH143729	\$ 809.00	
	Bearing	NPS100RPC	\$ 6.50	
	Horizontal Unloading Auger Tube (Outer)	144" AMAH145049	\$ 683.00	
	Horizontal Unloading Auger (Outer) Extended Wear, Left Hand Flighting, 11 1/2" Flighting Diameter, Shaft Diameter - 1" and 1 1/4"-19 Internal Spline, 13" Pitch For 14' Single Auger System Replaces AH97026, AH112451, AH116107, AH123436, AH132032	166 1/4" AMAH143731	\$ 693.00	
7700 BSN 008001	Bearing	NPS100RPC	\$ 6.50	
	Horizontal Unloading Auger Tube (Outer)	180" AMAH145050	\$ 820.00	
	Horizontal Unloading Auger Extended Wear, Left Hand Flighting, 11 1/2" Flighting Diameter, Shaft Diameter - 1" and 1 1/4"-19 Internal Spline, 13" Pitch For 17' System Replaces AH96555, AH113501, AH116108, AH123437, AH132033	202 1/4" AMAH143729	\$ 809.00	
	Bearing	NPS100RPC	\$ 6.50	
7700 BSN 008001	Horizontal Unloading Auger (Inner) Replaces AH76507	117.62" AMAH85410	\$ 685.05	

John Deere®—Combine

John Deere®—Combine

John Deere®—Combine

Application	Description	Part Number	Retail Price	Core
8820, 9400, 9410, 9450, 9500, 9500SH, 9510, 9510SH, 9550, 9550SH, 9600, 9610, 9650, 9650CTS, 9650STS BSN 690501, 9750STS BSN 690601, CTS, CTS II - w/ 2-Piece Auger	Horizontal Unloading Auger Tube (Outer)	144" AMAH145049	\$ 683.00	
	Horizontal Unloading Auger (In Elbow) Extended Wear, Left Hand Flighting, 11 7/8" Flighting Diameter, Shaft Diameter - 1 1/4"-19 Spline and 1 1/4"-19 Internal Spline, 13" Pitch	68 1/4" AMAH112435	\$ 499.00	
	Horizontal Unloading Auger (Outer) Extended Wear, Left Hand Flighting, 11 1/2" Flighting Diameter, Shaft Diameter - 1" and 1 1/4"-19 Internal Spline, 13" Pitch For 17' 2-Piece System	130.50" AMAH143727	\$ 557.00	
	Bearing	NPS100RPC	\$ 6.50	
	Horizontal Unloading Auger Tube (Outer)	180" AMAH145050	\$ 820.00	
	Horizontal Unloading Auger (In Elbow) Extended Wear, Left Hand Flighting, 11 7/8" Flighting Diameter, Shaft Diameter - 1 1/4"-19 Spline and 1 1/4"-19 Internal Spline, 13" Pitch	68 1/4" AMAH112435	\$ 499.00	
	Horizontal Unloading Auger (Outer) Extended Wear, Left Hand Flighting, 11 1/2" Flighting Diameter, Shaft Diameter - 1" and 1 1/4"-19 Internal Spline, 13" Pitch For 20' 2-Piece Auger System Replaces AH97026, AH112451, AH116107, AH123436, AH132032	166 1/4" AMAH143731	\$ 693.00	
9560STS	Horizontal Unloading Auger Tube (Outer)	144" AMAH210024	\$ 1034.00	
	Horizontal Unloading Auger (Outer) For 18.50' System	120" AMAH173593	\$ 930.04	
	Horizontal Unloading Auger (In Elbow) Extended Wear, Left Hand Flighting, 11 7/8" Flighting Diameter, Shaft Diameter - 1 1/4"-19 Spline and 1 1/4"-19 Internal Spline, 13" Pitch	68 1/4" AMAH112435	\$ 499.00	
	Horizontal Unloading Auger Tube (Outer)	180" AMAH210023	\$ 1171.00	
	Horizontal Unloading Auger (Outer) Extended Wear, Left Hand Flighting, 11 1/2" Flighting Diameter, Shaft Diameter - 1" Hex Shaft and 1 1/4"-19 Internal Spline, 13" Pitch For 21.50' Systems	160 7/8" AMAH173595	\$ 777.00	
	Ball Bearing	AMJD9373	\$ 14.50	
	Unloading Auger Sheet	AMH211327	\$ 25.00	

John Deere®—Combine

Application	Description	Part Number	Retail Price	Core	
9650STS ASN 690500, 9750STS ASN 690600	Horizontal Unloading Auger (In Elbow) Extended Wear, Left Hand Flighting, 11 7/8", Flighting Diameter, Shaft Diameter - 1 1/4" Hex x 1 1/4"-19 Spline and 1 1/4"-19 Internal Spline, 13" Pitch	83" AMAH169061	\$ 525.00		
	Ball Bearing	AMJD9373	\$ 14.50		
	Horizontal Unloading Auger Tube (Outer)	144" AMAH145049	\$ 683.00		
	Horizontal Unloading Auger (Outer) Extended Wear, Left Hand Flighting, 11 1/2" Flighting Diameter, Shaft Diameter - 1" and 1 1/4"-19 Internal Spline, 13" Pitch For 17' System	130.50" AMAH143727	\$ 557.00		
	Horizontal Unloading Auger (In Elbow) Extended Wear, Left Hand Flighting, 11 7/8", Flighting Diameter, Shaft Diameter - 1 1/4" Hex x 1 1/4"-19 Spline and 1 1/4"-19 Internal Spline, 13" Pitch	83" AMAH169061	\$ 525.00		
	Ball Bearing	AMJD9373	\$ 14.50		
	Horizontal Unloading Auger Tube (Outer)	180" AMAH145050	\$ 820.00		
	Horizontal Unloading Auger (Outer) Extended Wear, Left Hand Flighting, 11 1/2" Flighting Diameter, Shaft Diameter - 1" and 1 1/4"-19 Internal Spline, 13" Pitch For 20' System Replaces AH97026, AH112451, AH116107, AH123436, AH132032	166 1/4" AMAH143731	\$ 693.00		
	Horizontal Unloading Auger Tube (Outer)	144" AMAH210024	\$ 1034.00		
	Horizontal Unloading Auger (Outer) For 18.50' System	120" AMAH173593	\$ 930.04		
9560, 9560STS, 9570STS, 9660CTS, S550, S650, S660	Horizontal Unloading Auger Tube (Outer)	180" AMAH210023	\$ 1171.00		
	Horizontal Unloading Auger (In Elbow) Extended Wear, Left Hand Flighting, 11 7/8" Flighting Diameter, Shaft Diameter - 1 1/4"-19 Spline and 1 1/4"-19 Internal Spline, 13" Pitch	68 1/4" AMAH112435	\$ 499.00		
	Horizontal Unloading Auger (Outer) Extended Wear, Left Hand Flighting, 11 1/2" Flighting Diameter, Shaft Diameter - 1" Hex Shaft and 1 1/4"-19 Internal Spline, 13" Pitch For 21.50' Systems	160 7/8" AMAH173595	\$ 777.00		
	Ball Bearing	AMJD9373	\$ 14.50		
	(9660STS, 9760STS, 9860STS - Hi- Rate), 9670STS, 9770STS, 9870STS, S660, S670, S680, S690	Horizontal Unloading Auger Tube (Outer)	184" AMAH203020	\$ 1444.00	
	Horizontal Unloading Auger (In Elbow) Extended Wear, Left Hand Flighting, 14" Flighting Diameter, Shaft Diameter - 1 1/4" Hex x 1 1/4"-19 Spline and 1 5/8"-25 Internal Spline, 16" Pitch	95 7/16" AMAH201797	\$ 782.00		
Ball Bearing	AMJD9373	\$ 14.50			
	Horizontal Unloading Auger (Outer) Extended Wear, Left Hand Flighting, 15" Flighting Diameter, Shaft Diameter - 1 1/4" Hex Shaft and 1 1/4"-19 Internal Spline, 16" Pitch For 22.50' System	163 1/2" AMAH203021	\$ 1134.00		

John Deere®—Combine

John Deere®—Combine

John Deere®—Combine

Application	Description	Part Number	Retail Price	Core
9670STS, 9770STS, 9870STS, S660, S670, S680, S690	Horizontal Unloading Auger (Middle) Extended Wear, Left Hand Flighting, 15" Flighting Diameter, Shaft Diameter - 1 1/4" Hex Shaft and 1 1/4"-19 Internal Spline, 16" Pitch	95 7/16" AMAH234554	\$ 893.00	
	Horizontal Unloading Auger (Outer) Extended Wear-Sectional, Left Hand Flighting, 15" Flighting Diameter, Shaft Diameter - 1 1/4" Hex Shaft and 1 1/4"-19 Internal Spline, 16" Pitch	114 3/4" AMAH235525	\$ 1045.00	
	Horizontal Unloading Auger (In Elbow) Extended Wear, Left Hand Flighting, 14" Flighting Diameter, Shaft Diameter - 1 1/4" Hex x 1 1/4"-19 Spline and 1 5/8"-25 Internal Spline, 16" Pitch	95 7/16" AMAH201797	\$ 782.00	
	Auger Tube (Outer) For 26' or 7.9m Non-Folding Systems	112" AMAXE26714	\$ 995.00	
	Ball Bearing	AMJD9373	\$ 14.50	
9560STS*, 9650STS, 9660STS, 9670STS, 9750STS, 9760STS, 9770STS, 9860STS*, 9880STS* *Requires (3) H217909 Retainers, (2) H217859 Wear Rings and H209009 Ring	Horizontal Unloading Auger Tube w/ Elbow (Inner) Ball Style Pivot 15" Tube Diameter	AMAH215721	\$ 2293.00	
9650STS, 9750STS, S650 ASN 765000	Horizontal Unloading Auger Tube (Inner)	AMAXE27514	\$ 2290.00	
9660STS, 9670STS, 9760STS, 9770STS, 9860STS, 9870STS, S660, S670, S680, S690	Horizontal Unloading Auger 15.25" Left Hand Flighting OD	60.50" AMAH211828	\$ 656.00	
	Ball Bearing	AMJD9373	\$ 14.50	
9660STS, 9670STS, 9760STS, 9770STS, 9860STS, 9870STS, S660 SN 765172-775001, S670 SN 765253-775001, S680 SN 766007-785001, S690 SN 765250-785001, S760 ASN 1ZOS760XXX110000 & 1JZOS760XXX110000, S770 ASN 1ZOS770XXX110000 & 1JZOS770XXX110000, (S780, S790 ASN 1ZOS770XXX110000)	Horizontal Unloading Auger Tube (Outer) 17" Diameter, 2-Piece Folding 22.50" High Rate System Replaces AH202040	AMAXE36427	\$ 734.00	
9670STS, 9770STS, 9870STS, S660, S670, S680, S690	Horizontal Unloading Auger (Inner) Extended Wear-Sectional, Left Hand Flighting, 15" Flighting Diameter, Shaft Diameter - 1 1/4" Hex Shaft and 1 1/4"-19 Internal Spline, 16" Pitch For 22.5' Folding System	100 9/16" AMAH226068	\$ 903.00	
	Ball Bearing	AMJD9373	\$ 14.50	
(S660, S670, S680, S690 ASN 775701), S760, S770, S780, S790	Horizontal Unloading Auger (Outer) For 28.50' System	AMAXE41770	\$ 1601.00	
	Ball Bearing	AMJD9373	\$ 14.50	
(S660, S670, S680, S690 ASN 775000), S760, S770, S780, S785, S790	Horizontal Unloading Auger Tube For 26' Non-Folding System Replaces AXE29044, AXE47450	112.25" AMAXE68700	\$ 1202.08	
	Horizontal Unloading Auger Tube For 28.50' System Replaces AXE25770, AXE47447	130.875" AMAXE68702	\$ 2100.00	
	Horizontal Unloading Auger Tube For 26' and 28.50' Non-Folding Systems Replaces AXE41983, AXE47451	93.375" AMAXE68701	\$ 1019.27	
(S760, S770 ASN 1ZOS760XXX110000 & 1JZOS760XXX110000), (S780, S790 ASN 1ZOS760XXX110000)	Horizontal Unloading Auger Tube (Middle) For 22.50' Folding System	AMAXE38891	\$ 1920.00	

John Deere®—Combine

John Deere®—Combine

Application	Description	Part Number	Retail Price	Core
6620, 6622, (9400, 9600 ASN 651468), 9410, 9450, 9500, 9500SH, 9501, 9510, 9510SH, 9550, 9550SH, 9610, 9650, 9650CTS, 9650STS, 9750STS, CTS ASN 650418, CTS II	Rubber Spout	AMH149780	\$ 48.00	
9660STS, 9670STS, 9760STS, 9770STS, 9860STS, 9870STS, S660, S670, S680, S685, S690, S760, S770, S780, S785, S790	Rubber Spout	AMH208234	\$ 29.50	
(8820, 9400, 9410, 9450, 9500, 9500SH, 9510, 9510SH, 9550, 9550SH, 9560, 9560SH, 9560STS, 9570STS, 9600, 9610, 9650, 9650CTS, 9650STS, 9660, 9660CTS, 9660STS, 9670STS, 9750STS, 9760STS, 9770STS, 9860STS, 9870STS, CTS, CTS II - w/ 2-Piece System), S660, S670, S680, S690, S760, S770, S785, S790	Ball Bearing, Horizontal Unloading Auger 3.1496" OD, 1.25" Hex Bore Diameter Replaces 575883, 70575883, 86523785	AMJD9373	\$ 14.50	
3300, 4400, 4420, 6601, 6620, 6622, 7720, 7721, 8820, 9400, 9500, 9600, CTS, CTS II	Bearing Flange 2.047" (52 mm) OD	AMH103264	\$ 2.55	
9450, 9550, 9550SH, 9560, 9560SH, 9560STS, 9570STS, 9650, 9650CTS, 9650STS, 9660, 9660CTS, 9660STS, 9670STS, 9750STS, 9760STS, 9770STS, 9780CTS, 9860STS, 9870STS, S550, S650, S660, S670, S670HM, S680, S680HM, S690, S690HM, S760, S770, S780, S790	Unloader Elbow Pivot Bushing 2 Required	AMH202433	\$ 14.50	

Auger Extension Kits

These kits extend the length of your unloading auger approximately three feet and increase your clearance for larger platforms and grain carts. Includes spring-loaded grain saver. Replacement for OEM auger and tube. Pieces are sold separately, but must be used together.



Application	Description	Part Number	Retail Price	Core
6620, 7720, 8820, 9400, 9410, 9450, 9500, 9510, 9550, 9600, 9610, 9650, 9650CTS, 9650STS, 9750STS, CTS, CTS II - w/ 3.50" Auger Tube	Unloading Auger Extension Kit, 3' For 12" Diameter Auger	AMJD3EXT	\$ 795.00	
6620, 7720, 8820, 9400, 9410, 9500, 9510, 9550, 9600, 9610, 9650, 9650CTS, 9650STS, 9660CTS, 9660STS, 9670STS, 9750STS, 9760STS, 9770STS, CTS, CTS II	Snout For JD Extenders - Poly Auger Flighting, 36" Long Use on AMJD3EXT	AMJDEXT-PS AMX27500	\$ 145.00 \$ 75.00	
9560STS, 9660STS, 9760STS, 9770STS, 9860STS, 9870STS, S670, S680, S690	Unloading Auger Extension Kit High-Rate, For 17" Diameter Auger Adds 4' to Length	AMJD3EXT-HF	\$ 1025.00	
6620, 7720, 8820, 9400, 9500, 9600	Grain Saver Door	AMX27236	\$ 330.00	
6620, 7720, 8820, 9400, 9410, 9450, 9500, 9510, 9550, 9600, 9610, 9650, 9650CTS, 9650STS, 9660CTS, 9750STS, CTS, CTS II	Spring Kit, Grain Saver Door	AMX29019	\$ 42.00	

John Deere®—Combine

Auger Tube Donuts

Application	Description	Part Number	Retail Price	Core
6620, 7720, 8820, 9400, 9410, 9450, 9500, 9500SH, 9510, 9510SH, 9550, 9550SH, 9560, 9560SH, 9600, 9610, 9650, 9650STS, 9660, 9660CTS, 9660STS, 9750STS, 9760STS, CTS, CTS II	Splined Coupling (Donut), 4.275" OD Used at top of the vertical unloading auger to connect the drive end of the horizontal auger	AMH128861	\$ 60.00	
6620, 7720, 8820	Quick Coupler Socket (Donut), 4.275" OD Used at the bottom end of the vertical auger	AMAH123930	\$ 80.00	

Grain Tank Auger Floor Liners

Application	Description	Part Number	Retail Price	Core
9400, 9410, 9450, 9500, 9510, 9550 BSN 695201, 9550SH BSN 295701, 9560, 9560SH, 9600, 9610, 9650, 9650CTS, 9660, 9660CTS, CTS, CTS II	Grain Tank Auger Floor Liner Kit Includes Stainless Steel Panels for both Grain Tank Auger Troughs, Rivets and Installation Instructions	AMAH168093	\$ 815.00	
9400, 9410, 9500, 9510	Grain Tank Auger Floor Liner Kit	AMX27141	\$ 445.00	
9450, 9550, 9560, 9600, 9610, 9650, 9660	Grain Tank Auger Floor Liner Kit	AMX27142	\$ 434.50	
9560STS, 9570STS, 9650STS, 9750STS	Grain Tank Auger Floor Liner Kit	AMX27394	\$ 443.75	
(9660STS, 9670STS, 9760STS, 9770STS - w/ High Capacity Unload Rate), 9860STS, 9870STS, 9880STS, S550, S650, S660, S670, S670HM, S680, S680HM, S690, S690HM	Grain Tank Auger Floor Liner Kit Includes Stainless Steel Panes for both Grain Tank Auger Troughs, Rivets and Installation Instructions Replaces AH207238	AMX29144	\$ 575.00	
9660STS, 9670STS, 9760STS, 9770STS, 9860STS, 9870STS, S550, S660, S670, S680, S690	Grain Tank Auger Floor Liner Kit	AMX27395	\$ 403.25	
9570STS Standard Unload Rate, 9650STS, 9660STS, 9670STS, 9750STS, 9760STS, 9770STS	Grain Tank Auger Floor Liner Stainless Steel (2) Required	AMAH202864	\$ 335.00	

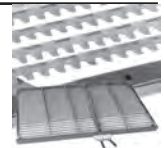

Chaffers—Short Finger Top

Adjustable short finger chaffer with 1 1/8" wire spacing. For use in cereal and fine seed crops.

Application	Description	Part Number	Retail Price	Core
4400, 4420	Short Finger Top Chaffer	36.07" x 50.63" AMAH87874	\$ 650.00	
6600, 6620	Short Finger Top Chaffer	42.01" x 60.76" AMAH99748	\$ 510.00	
6620 Titan II	Short Finger Top Chaffer	42.01" x 66.88" AMAH130378	\$ 748.82	
7700, 7720	Short Finger Top Chaffer	52.87" x 60.91" AMAH106770	\$ 650.00	
7720 Titan II	Short Finger Top Chaffer	52.87" x 66.88" AMAH130381	\$ 850.00	
8820	Short Finger Top Chaffer	63.73" x 61.65" AMAH96770	\$ 740.00	
8820 Titan II	Short Finger Top Chaffer	63.73" x 67.62" AMAH130384	\$ 750.00	
9400, 9500, 9510, 9450, 9550, CTS, CTS II	Short Finger Top Chaffer (2) Required Replaces AH172949	25.67" x 35.71" AMAH132785	\$ 285.00	
	Short Finger Top Chaffer Extension, 1-Piece	52.05" x 17.92" AMAH172953	\$ 308.00	
	Short Finger Top Chaffer Precleaner (2) Required	25.67" x 35.71" AMAH130151	\$ 270.00	
9560STS, 9570STS	Short Finger Top Chaffer Land Level (General Purpose)	AMAH212255	\$ 620.00	
9570STS Touchset, S550	Short Finger Top Chaffer	AMAXE20451	\$ 1696.85	

John Deere®—Combine

Application	Description		Part Number	Retail Price	Core
9600, 9610, 9650, 9660	Short Finger Top Chaffer (2) Required	31.10" x 35.71"	AMAH132784	\$ 325.00	
	Short Finger Top Chaffer Extension, 1-Piece	62.91" x 17.92"	AMAH172952	\$ 619.16	
	Short Finger Top Chaffer Precleaner (2) Required	31.10" x 35.71"	AMAH172941	\$ 325.00	
9600, 9610, 9650, 9660, CTS	Short Finger Top Chaffer Precleaner 1/8" Wire Spacing	35.729" x 31.228"	AMAH131214	\$ 382.75	
9650STS, 9660STS, 9670STS, 9750STS, 9760STS, 9770STS, 9860STS, 9870STS	Short Finger Top Chaffer Touchset	51.87" x 63.25"	AMAH212239	\$ 825.00	
9650STS, 9660STS, 9750STS, 9760STS, 9770STS	Short Finger Top Chaffer, Manual Adjust Replaces AH154460, AH168338, AH211936	51.87" x 63.25"	AMAH208291	\$ 780.00	
	Chaffer Adjustment Mechanism		AMX27423	\$ 175.00	
9650STS, 9660STS, 9750STS, 9760STS, 9860STS	Short Finger Top Chaffer Precleaner Flat Adjustable	51.50" x 34.00"	AMAH201930	\$ 1477.93	
9660STS, 9670STS, 9760STS, 9770STS, 9860STS, 9870STS	Short Finger Top Chaffer Precleaner Humped Non-Adjustable Replaces AH217044, AH205609, AH212423	51.50" x 34.00"	AMAH217044	\$ 715.00	
(S650, S660, S670, S680, S690 ASN 785000), S760, S770, S780, S785, S790	Short Finger Top Chaffer Level Land (General Purpose) Replaces AXE47216, AXE57966, AXE60614		AMAXE62796	\$ 1495.00	
(S650, S660, S670, S680, S690 BSN 785001), S670HM, S680HM, S690HM	Short Finger Top Chaffer Dual Adjust, 1 3/16" Wire Spacing Replaces AXE20447	51.57" x 80.875"	AMAXE28477	\$ 895.00	

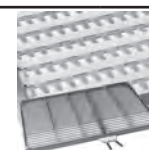

Chaffers—Long Finger Top

Adjustable long finger chaffers with 1 5/8" wire spacing. For use in large seed crops such as corn and beans.

Application	Description		Part Number	Retail Price	Core
4400, 4420	Long Finger Top Chaffer	36.07" x 50.63"	AMAH87876	\$ 730.18	
6600, 6620	Long Finger Top Chaffer	42.01" x 60.76"	AMAH99750	\$ 465.00	
6620 Titan II	Long Finger Top Chaffer	42.01" x 66.88"	AMAH130380	\$ 675.00	
7700, 7720	Long Finger Top Chaffer	52.87" x 60.91"	AMAH106772	\$ 570.00	
7720 Titan II	Long Finger Top Chaffer	52.87" x 66.88"	AMAH130383	\$ 660.00	
8820	Long Finger Top Chaffer	63.73" x 61.65"	AMAH97998	\$ 665.00	
8820 Titan II	Long Finger Top Chaffer	63.73" x 67.62"	AMAH130386	\$ 675.00	
9400, 9410, 9450, 9500, 9500SH, 9510, 9510SH, 9550, 9550SH, 9560, 9560SH, 9660CTS, CTS	Long Finger Top Chaffer Precleaner Deep Tooth, 1 5/8" Wire Spacing		AMAH172945DT	\$ 297.00	
9400, 9410, 9450, 9500, 9510, 9550, 9560, 9660CTS, CTS, CTS II	Long Finger Top Chaffer (2) Required	25.67" x 35.71"	AMAH172951	\$ 310.00	
	Long Finger Top Chaffer Extension, 1-Piece	52.05" x 17.92"	AMAH127435	\$ 302.50	
	Long Finger Top Chaffer Precleaner (2) Required Replaces AH172942	25.67" x 35.71"	AMAH172945	\$ 295.00	
	Long Finger Top Chaffer Precleaner, Raised		AMAXE13768	\$ 1142.00	
9560, 9560SH, 9570STS, 9660, 9660CTS, 9660STS, 9670STS, 9760STS, 9770STS, 9860STS, 9870STS					

John Deere®—Combine

Application	Description	Part Number	Retail Price	Core
9600, 9610, 9650, 9660	Long Finger Top Chaffer (2) Required	31.10" x 35.71" AMAH172950	\$ 310.00	
	Long Finger Top Chaffer Extension, 1-Piece	62.91" x 17.92" AMAH127434	\$ 443.28	
	Long Finger Top Chaffer Precleaner (2) Required	31.10" x 35.71" AMAH172944	\$ 350.00	
	Long Finger Top Chaffer Precleaner Deep Tooth, 1 5/8" Wire Spacing	AMAH172944DT	\$ 373.00	
9650STS, 9660STS, 9670STS, 9750STS, 9760STS, 9770STS	Long Finger Top Chaffer, Manual Adjust Replaces AH161895, AH208288	51.87" x 63.25" AMAH212248	\$ 795.00	
	Chaffer Adjustment Mechanism	AMX27423	\$ 175.00	
9650STS, 9660STS, 9670STS, 9750STS, 9760STS, 9770STS, 9860STS, 9870STS	Long Finger Top Chaffer Touchset Replaces AXE20457	51.87" x 63.25" AMAH212245	\$ 885.00	
9650STS, 9660STS, 9750STS, 9760STS, 9860STS	Long Finger Top Chaffer Precleaner	AMAH201411	\$ 886.00	
S650, S660, S670, S680, S690 BSN 785001	Long Finger Top Chaffer Deep Tooth, Dual Adjust	81.00" x 51.89" AMAXE28478	\$ 995.00	
(S650, S660, S670, S680, S690 ASN 785000), S760, S770, S780, S790	Long Finger Top Chaffer Replaces AXE61277	AMAXE63073	\$ 1250.00	



Chaffers—Adjustable Air Foil Top

Application	Description	Part Number	Retail Price	Core
6600, 6620	Adjustable Air Foil Top Chaffer	42.01" x 60.76" AMAH99748P	\$ 1184.23	
7700, 7720	Adjustable Air Foil Top Chaffer	52.87" x 60.91" AMAH106770P	\$ 1391.38	
7720 Titan II	Adjustable Air Foil Top Chaffer	52.87" x 66.88" AMAH130381P	\$ 1569.11	
8820	Adjustable Air Foil Top Chaffer	63.73" x 61.65" AMAH96770P	\$ 1657.16	
9400, 9450, 9500, 9510, 9550, CTS, CTS II	Adjustable Air Foil Top Chaffer (2) Required	25.67" x 35.71" AMAH132785P	\$ 445.44	
9400, 9500, 9510, 9450, 9550, CTS, CTS II	Adjustable Air Foil Top Chaffer Precleaner (2) Required	25.67" x 35.31" AMAH130151P	\$ 532.60	
9600, 9610, 9650	Adjustable Air Foil Top Chaffer Extension, 1-Piece	62.91" x 17.92" AMAH172952P	\$ 397.85	
9650STS, 9660STS, 9670STS, 9750STS, 9760STS, 9770STS, 9860STS, 9870STS	Adjustable Air Foil Precleaner Humped Style	51.50" x 34" AMPJDPC9660	\$ 1334.75	

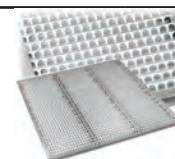

Chaffers—Rigid Air Foil

Rigid air foil chaffers are made of galvanized material. Dividers are included for even distribution and extra strength. These chaffers are preset for maximum performance at normal conditions.

Application	Description	Part Number	Retail Price	Core
6600, 6620	Rigid Air Foil Chaffer	42.01" x 60.76" AMAH128754	\$ 702.27	
7700, 7720	Rigid Air Foil Chaffer	52.87" x 60.91" AMAH128755	\$ 872.66	
6620 Titan II	Rigid Air Foil Chaffer	42.01" x 66.88" AMAH144637	\$ 773.85	
7720 Titan II	Rigid Air Foil Chaffer	52.87" x 66.88" AMAH144638	\$ 1009.65	
8820	Rigid Air Foil Chaffer	63.73" x 61.65" AMAH128756	\$ 1079.98	
8820 Titan II	Rigid Air Foil Chaffer	63.73" x 66.81" AMAH144639	\$ 1218.40	
9400, 9400, 9450, 9500, 9510, 9550, 9560, 9660CTS, CTS, CTS II	Rigid Air Foil Chaffer (2) Required	25.67" x 35.74" AMAH130486	\$ 355.53	
9600, 9610, 9650, 9660	Rigid Air Foil Chaffer (2) Required	31.10" x 35.71" AMAH130485	\$ 363.30	

John Deere®—Combine

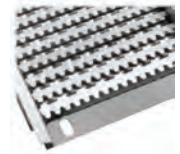

Sieves—Lower

Adjustable, blunt and short finger bottom sieves with 1 1/8" wire spacing. Use in cereal and fine seed grain crops.

Application	Description	Part Number	Retail Price	Core
4400, 4420	Blunt Finger Bottom Sieve	35.88" x 42.63" AMAH85351	\$ 867.62	
6600, 6620	Blunt Finger Bottom Sieve	41.87" x 46.05" AMAH85352	\$ 415.00	
6620 Titan II	Blunt Finger Bottom Sieve	41.87" x 52.31" AMAH130387	\$ 585.00	
7700, 7720	Blunt Finger Bottom Sieve	52.72" x 46.83" AMAH96771	\$ 550.00	
7720 Titan II	Blunt Finger Bottom Sieve	52.72" x 52.43" AMAH130389	\$ 625.00	
8820	Blunt Finger Bottom Sieve	63.63" x 46.86" AMAH96772	\$ 610.00	
8820 Titan II	Blunt Finger Bottom Sieve	63.63" x 53.50" AMAH130391	\$ 625.00	
9400, 9500, 9510, 9550, CTS, CTS II	Blunt Finger Bottom Sieve (2) Required	25.69" x 48.63" AMAH130160	\$ 290.00	
9600, 9610, 9650	Blunt Finger Bottom Sieve (2) Required	31.00" x 48.50" AMAH130159	\$ 315.00	
9650STS, 9660STS, 9670STS, 9750STS, 9760STS, 9770STS	Blunt Finger Bottom Sieve Replaces AH148909, AH211944 Chaffer Adjustment Mechanism	51.87" x 54.75" AMAH208290 AMX27423	\$ 740.00 \$ 175.00	
9650STS, 9660STS, 9670STS, 9750STS, 9770STS, 9860STS, 9880STS	Blunt Finger Bottom Sieve Touchset	51.87" x 54.75" AMAH212241	\$ 795.00	
(S650, S660, S670, S680, S690 ASN 785000), S760, S770, S780, S790	Blunt Finger Bottom Sieve Level Land (General Purpose) Replaces AXE47218, AXE57970, AXE60449	AMAXE62797	\$ 1495.00	
S650 ASN 765000, (S660, S670, S680, S690 ASN 745100), (S670 HillMaster, S680 HillMaster BSN 765000), S690 HillMaster SN 745101-765000	Blunt Finger Bottom Sieve	51.89" x 63.90" AMAXE20448	\$ 895.00	
9650STS, 9660STS, 9670STS, 9750STS, 9760STS, 9770STS	Long Finger Bottom Sieve Deep Tooth, 1 1/8" Wire Spacing Replaces AH162605, AH208286	AMAH212249	\$ 913.00	
9650STS, 9660STS, 9670STS, 9750STS, 9760STS, 9770STS, 9870STS	Long Finger Bottom Sieve Touchset Replaces AH208129	51.81" x 54.75" AMAH212247	\$ 1397.19	
(S650, S660, S670, S680, S690 BSN 785001)	Long Finger Bottom Sieve Deep Tooth Replaces AXE20449	51.89" x 63.90" AMAXE20450	\$ 895.00	
(S650, S660, S670, S680, S690 ASN 785000), S760, S770, S780, S785, S790	Long Finger Bottom Sieve Deep Tooth Replaces AXE60451	AMAXE62801	\$ 1190.00	



Chaffer and Sieve Frames

Application	Description	Part Number	Retail Price	Core
S550, S660, S670, S670HM, S680, S680HM, S690, S690HM	Chaffer Frame Kit Includes Right and Left Hand Frames Replaces KXE10322, KXE10355, KXE10581	AMKXE10605	\$ 2335.00	
(S660, S670, S680, S690 BSN 745100- 785000), (S670HM, S680HM BSN 765000), S690HM BSN 745101-765000	Sieve Frame Kit Includes Right and Left Hand Frames	AMKXE10161	\$ 1945.00	

John Deere®—Combine

John Deere®—Combine

Application	Description	Part Number	Retail Price	Core
9570STS, 9670STS, 9770STS, 9870STS	Chaffer Shoe Frame, Right Hand Replaces AH164487, AH165502	AMAH222863	\$ 1150.00	
	Chaffer Shoe Frame, Left Hand Replaces AH164488, AH165503	AMAH222862	\$ 995.00	
6600, 6620, 6622	Chaffer Frame	AMAH97752	\$ 1351.40	
	Sieve Shoe Frame	AMAH112543	\$ 824.70	
6620 Titan II, 6622 Titan II	Chaffer Frame	AMAH115198	\$ 1528.57	
	Sieve Shoe Frame	AMAH116659	\$ 1026.64	
7700*, 7720 *Requires (1) AH99760 Door and (1) H99004 Angle	Chaffer Frame	AMAH97751	\$ 1025.00	
	Sieve Shoe Frame	AMAH112544	\$ 920.56	
7720 Titan II	Chaffer Frame	AMAH115199	\$ 1125.00	
	Sieve Shoe Frame	AMAH116660	\$ 1018.77	
8820	Chaffer Frame	AMAH97715	\$ 1200.00	
	Sieve Shoe Frame	AMAH112545	\$ 1302.87	
8820 Titan II	Chaffer Frame	AMAH114417	\$ 1425.00	
	Sieve Shoe Frame	AMAH116661	\$ 1218.50	
9400, 9410, 9500, 9510, 9450, 9550, 9560, 9650CTS, 9660CTS, CTS, CTS II	Chaffer Frame	AMAH204976	\$ 1366.21	
	Chaffer Precleaner Frame	AMAH153808	\$ 1856.48	
	Sieve Shoe Frame	AMAH149701	\$ 1037.00	
9560STS, 9650STS, 9660STS, 9750STS, 9760STS, 9860STS	Sieve Shoe Frame, Right Hand	AMAH218675	\$ 506.27	
	Sieve Shoe Frame, Left Hand	AMAH218676	\$ 506.27	
9600, 9610, 9650, 9660	Chaffer Frame	AMAH204975	\$ 1475.00	
	Chaffer Precleaner Frame	AMAH153807	\$ 1500.00	
	Sieve Shoe Frame	AMAH149702	\$ 995.00	
9660STS, 9670STS, 9760STS, 9770STS, 9870STS, S650 SN 765000-785000, (S660, S670, S680, S690 SN 745100-785000), (S670HM, S680HM BSN 765000), S690HM SN 745101-765000	Chaffer Air Deflector Replaces AH218191	AMAXE17210	\$ 620.00	
9400, 9410, 9450, 9500, 9500SH, 9510, 9510SH, 9550, 9550SH, 9560, 9560SH, 9650CTS, 9650STS, 9660CTS, 9750STS, CTS, CTS II	Cleaning Shoe Drive Shaft 65.81" Long	AMH133598	\$ 261.00	
9600, 9610, 9650, 9660	Cleaning Shoe Drive Shaft 76.69" Long	AMH133597	\$ 404.63	
9400, 9410, 9450, 9500, 9500SH, 9501, 9510, 9510SH, 9550, 9550SH, 9560, 9560SH, 9560STS, 9570STS, 9600, 9610, 9650, 9650CTS, 9650STS, 9660, 9660CTS, 9660STS, 9670STS, 9750STS, 9760STS, 9770STS, 9860STS, 9870STS, C670, CTS, CTS II, S550 SN 745100-764999, S650 ASN 765000, (S660, S670, S680 ASN 745100), S690 ASN 745100, S670HM, S680HM BSN 765000, S690HM SN 745101-765000, T550, T560, T660, T670	Housing Flange, Pre-Cleaner Chaffer Drive	AMH134118	\$ 14.62	
9400, 9410, 9450, 9500, 9501, 9510, 9510SH, 9550, 9550SH, 9560, 9560SH, 9600, 9610, 9650, 9650CTS, 9780CTS ASN 072800, C670, CTS, CTS II, T550, T560, T660, T670	Outer Cam, Right Hand 1.379" ID, 6 mm Keyway For Shoe Drive	AMH133602	\$ 70.08	
	Outer Cam, Left Hand 1.261" ID, 6 mm Keyway For Shoe Drive	AMH133599	\$ 71.96	

John Deere®—Combine

Application	Description	Part Number	Retail Price	Core
9560STS, 9570STS, 9650STS, 9660STS, 9670STS, 9750STS, 9760STS, 9770STS, 9860STS, 9870STS, S550, (S650, S660, S670 BSN 785001)	Idler Pulley, Shoe and Conveyor Auger Drive 1.437" Overall Width, 7.992" Diameter, 0.637" Bore Diameter, 1" Groove Width Replaces AH85276, AH165366	AMAH97031	\$ 33.07	
9560STS ASN 705604, 9570STS, 9650STS, 9660STS ASN 706997, 9670STS, 9760STS ASN 706955, 9770STS, 9860STS ASN 706195, 9870STS, S550, (S650, S660, S670, S680, S690 BSN 785001), S670HM, S680HM, S690HM	Rear Seal, Bottom Sieve Frame w/ Center Pilot Hole	AMH214184	\$ 15.56	
9400 BSN 645513, 9410, (9500, 9500SH (BSN 646967), 9510, 9510SH, 9600, CTS BSN 645656	Bushing, Hanger Arm 0.532" ID	AMAH125200	\$ 6.46	
9400, 9410, 9500, 9500SH, 9501, 9510, 9510SH, 9600, 9610, 9780CTS ASN 072800, C670, CTS, CTS II, S550 SN 745100-764999, T550, T560, T660, T670	Bushing, Chaffer Frame 0.687" ID	AMAH125201	\$ 24.25	
9650STS, 9660STS, 9750STS, 9760STS, 9860STS, 9880STS	Chaffer Frame Curtain	AMH177907	\$ 67.21	
9660STS, 9670STS, 9760STS, 9770STS, 9860STS, 9870STS	Chaffer Curtain Replaces H215519	AMH230279	\$ 25.00	
9670STS, 9770STS, 9870STS	Chaffer Pan Limit Curtain	AMHXE27152	\$ 67.00	
9400, 9410, 9450, 9500, 9510, 9510SH, 9550, 9550SH, 9560, 9560SH, 9570STS, 9600, 9610, 9650, 9650CTS, 9650STS, 9660, 9660CTS, 9660STS, 9670STS, 9750STS, 9760STS, 9770STS, 9860STS, 9870STS, CTS, CTS II	Sieve Adjuster Crank	AMAH149543	\$ 79.08	
9400, 9410, 9450, 9500, 9510, 9510SH, 9550, 9550SH, 9560, 9560SH, 9560STS, 9570STS, 9650, 9650CTS, 9650STS, 9660STS, 9750STS, 9760STS, 9860STS	Cleaning Shoe Drive Hub	AMH133603	\$ 31.78	
7720 ASN 610500, 8820 ASN 610700	Double Sprocket, Cleaning Shoe 18 & 15 Tooth	AMAH115268	\$ 35.00	
9400, 9410, 9450, 9500, 9500SH, 9510, 9510SH, 9550, 9550SH, 9560STS, 9600, 9610, 9650, 9650CTS, 9650STS, 9660, 9660CTS, 9660STS, 9750STS, 9760STS, 9860STS, CTS, CTS II	Ball Bearing, Chaffer Hanger 3.346" ID, 5.118" OD	AMAH125975	\$ 39.56	
6600 ASN 003700, 7700 ASN 002800	Bearing, Shoe Pitman Shaft 2.4409" OD, 1.125" Bore Diameter	AMJD9246	\$ 20.81	
6600, 7700	Bearing Flange, Shaker Shoe Shaft	AME10018	\$ 2.40	
3300, 4400, 4420	Roller Chain, Shoe Drive 136 Links, Size 50 Chain	AMAH76933	\$ 35.00	
6600 BSN 105801, 7700 BSN 111901	Roller Chain, Shoe Drive 122 Links, Size 50 Chain	AMAH141170	\$ 30.00	
6600 ASN 105801, 7700 ASN 111901	Roller Chain, Shoe Drive 104 Links, Size 50 Chain	AMAH87248	\$ 30.00	
	Roller Chain, Shoe Drive 61 Links, Size 50 Chain	AMAH87247	\$ 80.00	
6620 ASN 610301, 7720, 8820	Roller Chain, Shoe Drive 57 Links, Size 60 Chain	AMAH115329	\$ 25.00	
7720, 8820	Roller Chain, Shoe Drive 99 Links, Size 60 Chain	AMAH90208	\$ 35.00	

Prices Subject to Change without Prior Notice. The use of original equipment manufacturer (OEM) part numbers or trademarks, e.g. Case® and John Deere®, are for reference purposes only and for indicating product use and compatibility. Our company and the listed replacement parts contained herein are not sponsored, approved or manufactured by the OEM. All parts are New unless designated Reman in the description.

John Deere®—Combine

Grain Pans and Components

Application	Description	Part Number	Retail Price	Core
9400, 9410, 9450, 9500, 9501, 9510, 9510SH, 9550, 9550SH, 9560, 9560SH, CTS	Grain Pan	AMAH128909	\$ 1011.97	
9600, 9610, 9650, 9660	Grain Pan	AMAH128908	\$ 1069.20	
9650STS, 9660STS, 9670STS, 9750STS, 9760STS, 9770STS, 9860STS, 9870STS, (S650, S660, S670, S680, S690 BSN 785001), S670HM, S680HM, S690HM	Return Pan Shaker, Wide Replaces AH216253, AH229379, AXE17166	AMAXE10046	\$ 1329.00	
9400, 9410, 9450, 9500, 9510, 9550, 9600, 9610, 9650, 9650CTS, 9660, 9660CTS, CTS, CTS II	Shaker Pan Arm, Right Hand	AMAH125970	\$ 222.31	
	Shaker Pan Arm, Left Hand	AMAH125969	\$ 231.97	
9560STS, 9570STS, 9650STS, 9660STS, 9670STS, 9750STS, 9760STS, 9770STS, 9860STS, 9870STS, S550 SN 745100-764999, S650 SN 765000-785000, S660 SN 745000-785000, (S670HM, S680HM BSN 765000), (S680, S690 SN 745100-785000), 690HM SN 745101-765000	Shaker Arm, Right Hand Replaces AH146570, AH170778	AMAH219846	\$ 189.80	
	Shaker Arm, Left Hand Replaces AH146569, AH170777	AMAH219844	\$ 189.77	
9400, 9410, 9450, 9500, 9500SH, 9501, 9510, 9510SH, 9550, 9550SH, 9560, 9560SH, 9560STS, 9570STS, 9600, 9610, 9650, 9650CTS, 9650STS, 9660, 9660CTS, 9660STS, 9750STS, 9760STS, 9780CTS, 9860STS, C670, CTS, CTS II, T550, T560, T660, T670	Sieve to Grain Pan Link	AMAH138230	\$ 45.00	
9570STS, S550, (S650, S660, S670, S680, S690 BSN 785001), S670HM, S680HM, S690HM	Front Seal, Return Pan	AMHXE59223	\$ 14.45	
9560STS, 9570STS, 9650STS, 9660STS, 9670STS, 9750STS, 9760STS, 9770STS, 9860STS, 9870STS, S550, (S650, S660, S670, S680, S690 BSN 785001), S670HM, S680HM, S690HM	Rear Seal, Shaker Pan w/ Offset Pilot Hole	AMH239920	\$ 15.56	
9560STS, 9660STS, 9760STS, 9860STS	Rear Seal, Shaker Pan w/ Center Pilot Hole	AMH214184	\$ 15.56	



Straw Walkers and Components

Application	Description	Part Number	Retail Price	Core
6600, 7700	Straw Walker	AMAH93701	\$ 960.83	
6620, 7720, 8820	Straw Walker	AMAH94469	\$ 595.00	
9400, 9410, 9450	Straw Walker	AMAH135381	\$ 1201.57	
9500, 9510, 9550, 9600, 9610, 9650	Straw Walker	AMAH135380	\$ 895.00	
9400, 9410, 9450, 9500, 9510, 9550	Straw Walker Crank - Front	AMAH151332	\$ 575.00	
	Straw Walker Crank - Rear	AMAH145604	\$ 575.00	
9600, 9610, 9650	Straw Walker Crank - Front	AMAH151331	\$ 575.00	
6600, 6620, 7700	Straw Walker Wood Block Bearing Set Set of 2 w/ hardware, 1 1/4" Shaft	AMH119613S	\$ 23.00	
7720, 8820	Straw Walker Wood Block Bearing Set Set of 2 w/ hardware, 1 1/2" Shaft	AMH119614S	\$ 23.00	
9400 BSN 635181, 9500 BSN 636926, 9600 BSN 636084 - Series One	Straw Walker Wood Block Bearing Set Set of 2 Includes Upper Half, Lower Half and Hardware	AMH140070S	\$ 35.00	

John Deere®—Combine

Application	Description	Part Number	Retail Price	Core
9400 SN 635181-650100, 9500 SN 636926-650200, 9600 SN 636084-650300 - Series Two	Straw Walker Wood Block Bearing Set Set of 2, Vertical 2-Bolt Mount Includes Upper Half, Lower Half and Hardware	AMH140677	\$ 29.00	
9400 ASN 650101, 9500 ASN 650201, 9510, 9600 ASN 650301, 9610 - Series Three	Straw Walker Wood Block Bearing Set Set of 2 w/ Hardware Replaces Aluminum Blocks	AMAH168158S	\$ 40.00	
	Straw Walker Wood Block Bearing Set Set of 2 w/ Hardware (0.002 Undersize) Replaces Aluminum Blocks	AMAH168158SU	\$ 50.00	
9400, 9410, 9500, 9510, 9600, 9610, 9650	Straw Walker Wood Block Bearing Set Set of 2 w/ Hardware 2-Groove, Fits around rings like OEM Aluminum Block	AMAH168158S2	\$ 45.00	
9400, 9410, 9500, 9501, 9510, 9510SH, 9560, 9560SH, 9610, 9650, 9650CTS, 9660, 9660CTS, CTS, CTS II	Hub-Sheave 7.29" OD, 0.985" Bore For Auger Drive	AMH135423	\$ 100.00	
6620, 7720, 8820	Slip Clutch Hub 3.57" OD, 2.63" Wide	AMH93999	\$ 78.92	
9400, 9410, 9450, 9500, 9510, 9510SH, 9550, 9550SH, 9560, 9560SH, 9560STS, 9570STS, 9610, 9650, 9650CTS, 9650STS, 9660, 9660CTS, 9660STS, 9750STS, 9760STS, 9860STS, 9870STS, CTS, CTS II, S550, S650, S660, S670, S680, S690, S760, S770, S780, S785, S790	Slip Clutch Hub Used on Straw Walker, Conveyor Auger and Chaffer/Sieve Drives	AMH131098	\$ 31.50	
6600, 6601, 6602, 7700, 7701	Chain Sprocket 49 Tooth, 2.253" ID, 10.11" OD For Straw Walker Drive	AMH86128	\$ 48.00	
6600 BSN 105801, 7700 BSN 111901	Chain Sprocket 15 Tooth, 1.125" ID, 3.265" OD For Size 50 Chain For Straw Walker and Shoe Drive Replaces H80389	AMAH84243	\$ 23.81	
6600 ASN 105800, 7700 ASN 111900	Chain Sprocket 15 and 15 Tooth, 1.127" ID, 3.316" OD For Size 50 Chain For Walker and Shoe Drive	AMAH87249	\$ 20.50	
6620 BSN 610301	Chain Sprocket 15 and 18 Tooth, 19 Internal Spline, 3.316" & 2.592" OD For Size 50 Chain For Straw Walker Drive	AMAH93152	\$ 68.91	
7720 BSN 610500, 7721 BSN 610600, 8820 BSN 610700	Chain Sprocket 15 Tooth Double Sprocket, 3.979" Diameter, For Straw Walker Drive	AMAH92689	\$ 45.00	
6620	Drive Sprocket 49 Tooth, 2.877" ID, 10.09" OD For Size 50 Chain	AMH100778	\$ 41.00	
6620 ASN 610300	Drive Sprocket, Straw Walker/Cleaning Shoe 18 & 15 Tooth, 19 Internal Spline, 4.703" & 3.316" OD For Size 60/50 Chain	AMAH115267	\$ 47.50	
6620 ASN 610300, 7720, 8820	Drive Sprocket, Straw Walker 28 Tooth, 3.685" ID, 7.11" OD For Size 60 Chain	AMH93477	\$ 21.40	
7720, 8820	Drive Sprocket, Straw Walker 49 Tooth, 2.872" ID, 12.115" OD For Size 60 Chain	AMH93463	\$ 62.00	

Prices Subject to Change without Prior Notice. The use of original equipment manufacturer (OEM) part numbers or trademarks, e.g. Case® and John Deere®, are for reference purposes only and for indicating product use and compatibility. Our company and the listed replacement parts contained herein are not sponsored, approved or manufactured by the OEM. All parts are New unless designated Reman in the description.

John Deere®—Combine

Application	Description	Part Number	Retail Price	Core
Forage Harvesters: 5200, 5400, 5440, 5460, 5720, 5730, 5820, 5830, 6610, 6650, 6710, 6750, 6810, 6850, 6910, 6950	Idler Sprocket 15 Tooth, 0.638" ID For Size 60 Chain	AMAE27909	\$ 27.46	
7720 ASN 610500, 8820 ASN 610700	Double Sprocket, Straw Walker 18 & 15 Tooth	AMAH115268	\$ 35.00	
9400, 9410, 9450, 9500, 9500SH, 9510, 9510SH, 9550, 9550SH, 9560, 9560SH, 9650, 9650CTS, 9660, 9660CTS, CTS, CTS II	Pulley 8.882" Diameter, 1.378" Bore, 0.394" Hole Diameter For Chaffer and Sieve Drive	AMH131170	\$ 175.00	
6600, 6620, 7700, 7720, 8820	Bearing w/ Lock, Rear Straw Walker Crank	AMJD9274	\$ 24.07	
7700	Bearing w/ Lock, Front Straw Walker Crank	AMJD9274	\$ 24.07	
9400, 9410, 9450, 9500, 9500SH, 9510, 9510SH, 9550, 9550SH, 9560, 9560SH, 9600, 9610, 9650, 9660	Ball Bearing, Straw Walker Gearbox	AMJD10011	\$ 30.42	
9400, 9410, 9450, 9500, 9510, 9510SH, 9550, 9550SH, 9560, 9560SH, 9600, 9610, 9650, 9660	Ball Bearing, Front, Right Hand For Straw Walker Crank	AMAH132823	\$ 32.50	
7720, 8820	Roller Chain, Straw Walker Drive 99 Links, Size 60 Chain	AMAH90208	\$ 35.00	
6600 ASN 105801, 7700 ASN 111901	Roller Chain, Straw Walker Drive 104 Links, Size 50 Chain	AMAH87248	\$ 30.00	



Straw Choppers

Assembly includes rotor, side sheets, knife bank, flanges and hardware.



Application	Description	Part Number	Retail Price	Core
7700 Late, 7720	Straw Chopper Assembly w/ Used Drive Kit	Corn AMC7720-CD	\$ 3900.00	
		Wheat AMC7720-WD	\$ 3900.00	
	Straw Chopper Assembly w/o Drive Kit	AMC7720-N	\$ 3350.00	
8820	Straw Chopper Assembly w/ Used Drive Kit	Corn AMC8820-CD	\$ 4250.00	
		Wheat AMC8820-WD	\$ 4250.00	
	Straw Chopper Assembly w/o Drive Kit	AMC8820-N	\$ 3750.00	
9400, 9410, 9450, 9500, 9510, 9550	Straw Chopper Assembly w/o Drive Kit	AMC9500-N	\$ 3500.00	
9500, 9510, 9550	Straw Chopper Assembly w/ Used Drive Kit	Corn AMC9500-CD	\$ 4000.00	
9560STS BSN 700500, 9750STS BSN 700600	Straw Chopper Assembly w/o Drive Kit w/ 12 Vane Deflector	AMC9750STS-N12	\$ 6195.00	
		AMC9750STS-N	\$ 4950.00	
9560STS BSN 715300	Straw Chopper Assembly w/ Drive Kit	AMC9560STS-E	\$ 9950.00	
9560STS	Straw Chopper Assembly w/o Drive Kit w/ 10 Vane Deflector	AMC9560STS-N10	\$ 5710.00	
		AMC9560STS-N	\$ 4675.00	
9560STS ASN 715301	Straw Chopper Assembly w/ Drive Kit	AMC9560STS-L	\$ 9950.00	
9570STS	Straw Chopper Assembly w/o Drive Kit w/ 10 Vane Deflector	AMC9570STS-N10	\$ 5710.00	
		AMC9570STS-N	\$ 4715.00	
9570STS, S550	Straw Chopper Assembly w/ Drive Kit	AMC9570STS	\$ 10000.00	
9600, 9610, 9650	Straw Chopper Assembly w/ Used Drive Kit	Corn AMC9600-CD	\$ 4250.00	
		AMC9600-N	\$ 3750.00	
9650STS BSN 700500, 9750STS BSN 700600	Straw Chopper Assembly w/ Drive Kit	AMC9750STS-E	\$ 10425.00	

John Deere®—Combine

John Deere®—Combine

Application	Description	Part Number	Retail Price	Core
9650STS ASN 700501, 9660STS, 9750STS ASN 700601, 9760STS, 9860STS	Straw Chopper Assembly w/o Drive Kit w/ 12 Vane Deflector	AMC9650STS-N12	\$ 6250.00	
	Straw Chopper Assembly w/o Drive Kit w/o 12 Vane Deflector	AMC9650STS-N	\$ 5065.00	
9650STS ASN 700501, 9750STS ASN 700601	Straw Chopper Assembly w/ Drive Kit	AMC9750STS-L	\$ 10425.00	
9660STS BSN 715400, 9760STS BSN 715500	Straw Chopper Assembly w/ Drive Kit	AMC9760STS-E	\$ 10700.00	
9660STS ASN 715401, 9760STS ASN 715501	Straw Chopper Assembly w/ Drive Kit	AMC9760STS-L	\$ 10700.00	
9670STS	Straw Chopper Assembly w/ Drive Kit	AMC9670STS	\$ 10900.00	
	Straw Chopper Assembly w/o Drive Kit w/ 12 Vane Deflector	AMC9670STS-N12	\$ 6250.00	
	Straw Chopper Assembly w/o Drive Kit w/o 12 Vane Deflector	AMC9670STS-N	\$ 5065.00	
9770STS, 9870STS	Straw Chopper Assembly w/o Drive Kit w/ 12 Vane Deflector	AMC9870STS-N12	\$ 6300.00	
	Straw Chopper Assembly w/o Drive Kit w/o 12 Vane Deflector	AMC9870STS-N	\$ 5125.00	
9860STS BSN 705797	Straw Chopper Assembly w/ Drive Kit	AMC9860STS-E	\$ 10975.00	
9860STS ASN 705797	Straw Chopper Assembly w/ Drive Kit	AMC9860STS-L	\$ 10975.00	







Straw Chopper Drive Kits and Components

Application	Description	Part Number	Retail Price	Core
 9400, 9410, 9450, 9500, 9510, 9550, 9560, 9600, 9610, 9650, 9660	Straw Chopper Drive Kit	AMX27118	\$ 1000.00	
 6620, 7720, 8820, 9400, 9410, 9500, 9510, 9600, 9610	Straw Chopper Drive Pulley Replaces AH119770	AMAH95486	\$ 150.00	
9400 ASN 640100, 9410, 9450, 9500, 9501, 9510, 9510SH, 9600, 9610	Straw Chopper Drive Pulley 2-Groove 11.104" ID, 1.375" OD	AMAH127602	\$ 274.11	
9450 BSN 700100, 9550 BSN 700200, 9550SH BSN 700700, 9650 BSN 700300	Straw Chopper Drive Pulley 2-Groove 4.134" ID, 10.915" OD	AMH139986	\$ 212.69	
 9450, 9550, 9550SH, 9560, 9560SH, 9660	Straw Chopper Drive Pulley, Standard 2-Groove 1.378" ID, 12.275" OD	AMAH162529	\$ 280.54	
 9450, 9550, 9550SH, 9560, 9560SH, 9650, 9660	Straw Chopper Drive Pulley	AMAH162528	\$ 125.00	
9560STS, 9570STS, 9650STS, 9660STS, 9670STS, 9750STS, 9760STS, 9770STS, 9860STS, 9870STS, S550	Straw Chopper Drive Pulley 2-Groove	AMH161983	\$ 400.00	
9560STS, 9570STS, 9650STS, 9660STS, 9670STS, 9750STS, 9760STS, S550 SN 745100-764999	Straw Chopper Drive Pulley	AMAH163887	\$ 270.00	









Prices Subject to Change without Prior Notice. The use of original equipment manufacturer (OEM) part numbers or trademarks, e.g. Case® and John Deere®, are for reference purposes only and for indicating product use and compatibility. Our company and the listed replacement parts contained herein are not sponsored, approved or manufactured by the OEM. All parts are New unless designated Reman in the description.

John Deere®—Combine

John Deere®—Combine



	Application	Description	Part Number	Retail Price	Core
	9400, 9410, 9450, 9500, 9500SH, 9510, 9510SH, 9550, 9550SH, 9560, 9560SH, 9600, 9610, 9650, 9660	Double Idler Pulley, Straw Chopper Drive 3.25" Wide, 8" OD, 0.50" Bore Diameter Replaces AH87119	AMAH93318	\$ 59.09	
	9560STS, 9660STS, 9670STS, 9760STS, 9770STS, 9860STS, 9870STS	Straw Chopper Pivot Bracket, Right Hand	AMAH218278	\$ 50.00	
		Straw Chopper Pivot Bracket, Left Hand	AMAH226899	\$ 74.00	
	9560STS, 9660STS, 9670STS, 9760STS, 9770STS, 9860STS, 9870STS, 9880STS	Straw Chopper Pivot Bracket Bushing 3/4" ID	AMH213638	\$ 15.00	
	9400, 9410, 9450, 9500, 9510, 9510SH, 9550, 9550SH, 9560, 9560SH, 9600, 9610, 9650, 9660	Straw Chopper Drive Pulley Arm Bracket	AMH132976	\$ 42.00	
	9400, 9410, 9450, 9500, 9510, 9550, 9560, 9600, 9610, 9650, 9660	Straw Chopper Bracket	AMH132901	\$ 35.00	
	9400, 9410, 9450, 9500, 9510, 9550, 9560, 9600, 9610, 9650, 9660	Straw Chopper Rear Drive Arm	AMAH169220	\$ 95.00	
	9400, 9410, 9450, 9500, 9500SH, 9510, 9510SH, 9550, 9550SH, 9560, 9560SH, 9600, 9610, 9650, 9660	Straw Chopper Drive Pulley Arm Strap	AMH129125	\$ 22.00	
	9450, 9550, 9550SH, (9560, 9560SH BSN 705261), 9650, 9660 BSN 705331	Straw Chopper Jackshaft Drive 14.34" Long	AMH169065	\$ 156.67	
	9650STS, 9660STS, 9670STS, 9750STS, 9760STS, 9870STS	Straw Chopper Jackshaft 18.50" Long Replaces H157539	AMH222676	\$ 159.74	
	9500, 9500SH, 9510, 9510SH, (9600, 9610 - w/ Straw Chopper and/or Chaff Spreader w/ Tapped End)	Straw Chopper Jackshaft Drive 8.51" Long M20x2.50" Thread For Fine Cut Straw Choppers Replaces H157687	AMH169712	\$ 169.98	
	(9560, 9560SH ASN 705261), 9660 ASN 705331	Straw Chopper Jackshaft, Regular Cut 14.25" Long	AMH210087	\$ 123.33	
	9560STS, 9570STS, 9650STS, 9660STS, 9670STS, 9750STS, 9760STS, 9860STS, 9870STS, S550 SN 745100-764999	Pin, Jackshaft Arm Pivot 10" Long, 1" OD M16x20 Right Hand Thread	AMH201324	\$ 41.63	
	9400, 9410, 9500, 9510, 9600, 9610	Straw Chopper Front Drive Arm	AMAH135342	\$ 70.00	
	9560STS, 9570STS, (9660STS, 9760STS ASN 710501), 9670STS, 9770STS, 9860STS ASN 705798, 9870STS, S550 SN 745100-764999	Arm Assembly	AMAH210883	\$ 176.00	
	9560STS, 9570STS, (9660STS, 9760STS ASN 710501), 9670STS, 9770STS, 9860STS ASN 705798, 9870STS, S550 SN 745100-764999	Arm Assembly Replaces AH220821, AH222044	AMAH223728	\$ 237.00	
	9560STS BSN 715300, 9650STS, 9660STS, 9750STS, 9760STS, 9860STS	Arm Assembly Replaces AH160596, AH201042, AH206671	AMAH211558	\$ 218.00	
	9650STS, (9660STS, 9760STS BSN 710500), 9750STS	Arm Assembly	AMAH155256	\$ 128.00	

John Deere®—Combine

Application	Description	Part Number	Retail Price	Core
9400, 9410, 9450, 9500 BSN 643457, 9510, 9550, 9550SH, 9560, 9560SH, 9560STS, 9570STS, 9600 BSN 642112, 9610, 9650, 9650CTS, 9650STS BSN 695788, 9660, 9660CTS, 9660STS, 9670STS, 9750STS BSN 695706, 9750STS, 9760STS, 9770STS, 9780CTS BSN 74501, 9860STS, 9870STS, S550 SN 745100-7649999, S650 ASN 7656000, S660 SN 745100-785000 & ASN 7451001, (S670, S680 ASN 7451000), (S670 HillMaster, S680 HillMaster BSN 765000), S690 SN 765250-785000, S690 HillMaster SN 745101-765000, Cotton Picker: 7260, Cotton Stripper: 9460	Pin 3.354" Long, 0.315" Thick, 1" Diameter, 2.756" Hole Diameter	AMAH212002	\$ 28.00	
	9400, 9410, 9450, 9500, 9510, 9550, 9560, 9600, 9610, 9650, 9660	Idle Arm Pin	AMAH172214	\$ 49.00
	9400, 9410, 9450, 9500, 9500SH, 9501, 9510, 9510SH, 9550, 9550SH, 9560, 9560SH, 9600, 9610, 9650, 9660	Straw Chopper Bracket	AMH133812	\$ 47.00
	9400, 9410, 9450, 9500, 9500SH, 9510, 9510SH, 9550, 9550SH, 9560, 9560SH, 9560STS, 9610, 9650, 9650CTS, 9650STS, 9660, 9660CTS, 9660STS, 9750STS, 9760STS, 9770STS, 9860STS, 9870STS, CTS, CTS II	Bushing, Straw Chopper Drive Tightener and Idler Arms 1.005" ID, 1.128" OD, 1" Wide	AMH171061	\$ 5.00
	3300, 4400, 4420, 6600, 6620, 7700, 7720, 8820, 9400, 9410, 9500, 9500SH, 9510, 9510SH, 9600, 9610, CTS, CTS II	Idler Pulley, Straw Chopper Drive 7 15/16" Diameter	AMAN15237	\$ 26.68
	6620, 7700, 7720, 8820, CTS, CTS II, (S670 BSN 765253 w/o Dual Chopper Drive and SN 765253-785000 w/ Standard and Extra Fine Cut Dual Chopper Drive)	Idler Pulley, Straw Chopper Drive 1.437" Overall Width, 7.992" Diameter, 0.637" Bore Diameter, 1" Groove Width Replaces AH85276, AH165366	AMAH97031	\$ 33.07
	9560STS ASN 715300, 9570STS, (9660STS, 9760STS ASN 710500), 9670STS, 9770STS	Idler Pulley Replaces AH171385	AMAH210922	\$ 98.00
	9560STS, (9660STS, 9760STS ASN 710500), 9670STS, 9770STS, 9860STS ASN 705797, 9870STS, S550	Idler Pulley	AMAH211639	\$ 91.00
	9650STS ASN 700500, 9660STS BSN 710501, 9750STS ASN 700600, 9760STS BSN 700501, 9860STS BSN 705798	Idler Pulley	AMAH170234	\$ 91.00
	9650STS SN 695501-700500, 9750STS SN 695501-700600	Idler Pulley	AMAH171385	\$ 70.00
	9400, 9410, 9450, 9500, 9510, 9550, 9560, 9600, 9610, 9650, 9660	Stud Shaft	AMH164756	\$ 30.00
	9560STS, 9570STS, (9660STS, 9760STS ASN 710501), 9770STS, 9860STS ASN 705798, 9870STS, S550 SN 745100- 764999, (S670, S680, S690 ASN 745100)	Spring Gauge	AMH211566	\$ 7.00

John Deere®—Combine

John Deere®—Combine

Application	Description	Part Number	Retail Price	Core
9560STS, 9570STS, 9650STS, 9660STS, 9670STS, 9750STS, 9760STS, 9770STS, 9860STS, 9870STS, S550 SN 745100-764999	Spacer	AMH211141	\$ 8.00	
9560STS, 9570STS, 9660STS ASN 710501, 9670STS, 9770STS, 9860STS ASN 705798, 9870STS, S550 SN 745100-764999	Yoke 1.125" Outside Width, 16.929" Bore to End, 0.474" Hole Size, 0.472" End Size, 1.125" Throat Depth, 0.563" Throat Width Replaces AH209881	AMAH222033	\$ 45.00	
 9560STS, 9570STS, 9660STS, 9670STS, 9750STS, 9760STS, 9860STS, S550 SN 745100-764999	Flange Bearing w/ Collar 1.687" Wide, 1.501" Bearing ID, 3.15" Bearing OD	AMAH163595	\$ 123.00	
9650STS ASN 696539, (9660STS, 9760STS ASN 710500), 9750STS, 9860STS BSN 705797	Hookbolt	AMH208405	\$ 26.00	
9650STS, (9660STS, 9760STS BSN 710500), 9750STS, 9860STS BSN 705797	Spring Gauge 1.378" Long, 0.394" Wide, 7.323" Tall, 0.063" Thick, 0.512" Hole Diameter	AMH173262	\$ 6.00	
 9770STS, 9860STS ASN 715601, 9870STS	Flange Bearing w/ Collar Replaces AH212944	AMAH232668	\$ 142.00	

Straw Chopper Blades and Components



Application	Description	Part Number	Retail Price	Core
John Deere® Combines: 3300 (Requires 3 Sets), (4400, 4420, 6600, 6620 - Requires 4 Sets)	Straw Chopper Blade Set Set of 6 Harden Steel Blades w/o Hardware 9.25" Long Replaces AH172022, P48066	Straight Edge AMAH126851	\$ 30.00	
(7700, 7720, 7721, 9400, 9410, 9450, 9500, 9510, 9550, CTS, CTS II - Requires 5 Sets), (8820, 9600, 9610, 9650, 9650CTS - Requires 6 Sets)	Straw Chopper Blade Set Set of 6 w/o Hardware, 8.375" Long	Straight Edges AMAH124635	\$ 30.00	
		Single Bevel AMAH124635SB	\$ 24.00	
		Double Bevel AMAH124635DB	\$ 25.00	
9500, 9500SH, 9510, 9510SH, 9550, 9550SH, 9560, 9560SH, 9560STS, 9600, 9610, 9650, 9650CTS, 9650STS, 9660, 9660CTS, 9660STS, 9750STS, 9760STS, 9860STS, CTS, CTS II	Straw Chopper Blade Set, Paddle Type Set of 8 Includes (4) Right Hand and (4) Left Hand	AMAH205909	\$ 55.00	
	Straw Chopper Blade Bushing For paddle type blade Use w/ AMAH205909	AMH167127	\$ 5.50	
9500, 9500SH, 9510, 9510SH, 9550, 9550SH, 9560, 9560SH, 9600, 9610, 9650, 9650CTS, 9650STS, 9660, 9660CTS, 9660STS, 9750STS, 9760STS, 9860STS, CTS, CTS II	Straw Chopper Blade Set, Fine Cut Set of 8 w/o Hardware Replaces H156098	Double Bevel AMAH205910	\$ 39.00	
	Chopper Blade Bushing Use w/ AMAH205910	AMH156100	\$ 5.00	
9570STS, 9670STS, 9770STS, 9870STS, S550	Straw Chopper Blade Set, Scoop Type Set of 8 6.19" Long, 1.97" Wide	AMAH225940	\$ 134.83	

John Deere®—Combine

John Deere®—Combine

Application	Description	Part Number	Retail Price	Core
(7700, 7720, 9400, 9500 - Requires 5 Sets), (8820, 9600 - Requires 6 Sets)	Straw Chopper Blade Set Set of 6 Hardened Steel Blades w/ Hardware 8.375" Long Replaces AH124635, H88809	Straight Edges AMAH171588	\$ 40.00	
	Straw Chopper Blade Set Set of 6 w/ Hardware 8.375" Long Replaces AH124635, H88809	Single Bevel AMAH171588SB	\$ 35.00	
S650, S660, S670, S670HM, S680, S680HM, S690, S690HM	Straw Chopper Blade Set Set of 8 w/o Hardware	Serrated Edges AMKXE10256	\$ 140.00	
(7700, 7720, 9400, 9500 - Requires 5 Sets), (8820, 9600 - Requires 6 Sets)	Straw Chopper Blade Set Set of 6 w/ Hardware 8.375" Long Replaces AH124635, H88809	Double Bevel AMAH171588DB	\$ 60.20	
6600, 6620	Straw Chopper Rotor Rod (3) Required for New Style "Tri-Rotor" Assemblies	AMH139500	\$ 55.00	
7700, 7720, 9400 BSN 645110, 9410, 9450, 9500 BSN 646108, 9510, 9550	Straw Chopper Rotor Rod (3) Required for New Style "Tri-Rotor" Assemblies	AMH139600	\$ 60.00	
8820, 9600 BSN 645300	Straw Chopper Rotor Rod (3) Required for New Style "Tri-Rotor" Assemblies	AMH132122	\$ 70.00	
9400, 9410, 9450, 9500, 9500SH, 9501, 9510, 9510SH, 9550SH, 9560SH, 9560STS, 9570STS, 9600, 9610, 9650, 9650CTS, 9650STS, 9660, 9660CTS, 9660STS, 9670STS, 9750STS, 9760STS, 9770STS, 9860STS, 9870STS, CTS, CTS II, (S550, S690HM SN 745101-765000), S65 (ASN 765000), (S660, S670, S680, S690 ASN 745100), (S670HM, S680HM BSN 765000), S760, S770, S780, S785, S790	Straw Chopper Blade, 7.50" Stationary Double Bevel Blade 0.988" hole, 2-Hole For Late Models, Hardware Not Included	AMH215004	\$ 5.00	
(9400, 9410, 9500, 9510 - Requires 29 Blades), (9600, 9610 - Requires 35 Blades)	Straw Chopper Blade, 8.50" Stationary Single Bevel Blade Sold Individually, Hardware Not Included	AMH142141FC	\$ 7.50	
6620, 7720, 8820, 9400 BSN 640101, 9500 BSN 640201, 9600 BSN 640301	Sickle Knife Bracket Assembly, Straw Chopper Single Blade Bracket	AMAP23601	\$ 6.75	
3300, 4400, 6620, 6622, 7720, 7721, 8820, 9400, 9500, 9501, 9600	Stationary Knife	AME76372	\$ 1.50	
6620, 7720, 8820, 9400 BSN 640100, 9500 BSN 640200, 9600 BSN 640300	Straw Chopper Bracket Assembly w/ Knife Sections	AMAH89918	\$ 11.30	
8820	Straw Chopper Knife Bar	AMH100419	\$ 220.00	
8820 ASN 620962, 9400 SN 650101- 655100, 9410, 9500, 9500SH, 9510, 9510SH, CTS BSN 655400, CTS II - w/ Tri-Rotor Straw Chopper	Straw Chopper Rotor Shaft 62.94" Long Replaces H141580, H141582	AMH145275	\$ 303.41	
9570STS, 9670STS, 9770STS, 9870STS, S550 SN 745100-764999	Trunnion Bushing (1) Required per Blade	AMH218499	\$ 8.00	
3300 ASN 200000, 4400 ASN 201250, 4420, 6600 ASN 206200, 6620, 7700 ASN 213300, 7720, 8820, 9400 BSN 650101, 9500, 9500SH, 9600	Straw Chopper Bushing 0.38" ID, 0.75" OD	AMH88783	\$ 7.81	
S650 ASN 765000, (S660, S670, S680, S690 ASN 745100), (S670HM, S680HM BSN 765000), S690HM SN 745101-765000	Straw Chopper Bushing Straw Chopper Spacer	AMHXE59496 AMHXE15909	\$ 5.50 \$ 6.50	

John Deere®—Combine











Straw Chopper Rotor Assemblies









These rotor assemblies are balanced and ready for installation. For a new style "Tri-Rotor."

Application	Description	Part Number	Retail Price	Core
7700, 7720, 9400, 9410, 9450, 9500, 9510, 9550, 9650CTS, CTS, CTS II	Straw Chopper Rotor Assembly	AMAH143426	\$ 1600.00	
8820, 9600, 9610, 9650	Straw Chopper Rotor Assembly	AMAH143424	\$ 1700.00	













Straw Chopper Parts and Components

Application	Description	Part Number	Retail Price	Core
 4400, 4420, 6600, 6620, 7700, 7720, 8820	Side Sheet Kit	AMBH77683	\$ 350.00	
	Components:			
	Side Sheet, Right Hand	1 AMAH112271	\$ 130.00	
	Side Sheet, Left Hand	1 AMAH112272	\$ 130.00	
	Inner Hanger, Right Hand	1 AMH113983	\$ 35.00	
	Inner Hanger, Left Hand	1 AMH113984	\$ 35.00	
	Outer Hanger, Right Hand	1 AMAH111646	\$ 45.00	
Outer Hanger, Left Hand	1 AMAH111647	\$ 45.00		
 9400, 9410, 9500, 9510, 9550, 9600, 9610, 9650, CTS, CTS II	Side Sheet	Right Hand AMAH138157	\$ 185.00	
		Left Hand AMAH138156	\$ 185.00	
9400 BSN 640100, 9500 BSN 640200, 9600 BSN 640300	Side Sheet Replaces AH131979	Left Hand AMAH131865	\$ 230.34	
 9560STS, 9650STS ASN 700501, 9660STS, 9750STS ASN 700601, 9760STS, 9860STS	Side Sheet	Right Hand AMH204974	\$ 185.00	
		Left Hand AMH204973	\$ 185.00	
9570STS, 9670STS, S550 SN 745100-764999	Side Sheet	Right Hand AMH224428	\$ 156.98	
		Left Hand AMH223995	\$ 149.48	
 9650STS BSN 700500, 9750STS BSN 700600	Side Sheet	Right Hand AMH157481	\$ 200.00	
		Left Hand AMH157480	\$ 200.00	
 9660STS ASN 715400, 9760STS ASN 715501	Side Sheet	Right Hand AMAH217814	\$ 225.00	
		Left Hand AMAH217813	\$ 240.00	
 9770STS, 9870STS	Side Sheet	Right Hand AMH223543	\$ 215.00	
		Left Hand AMH223542	\$ 215.00	
 9500, 9500SH, 9510, 9550, 9600, 9610, 9650, CTS, CTS II SN 675101-679050	Side Rail	Right Hand AMAH139679	\$ 138.00	
		Left Hand AMAH139680	\$ 138.00	
9500, 9500SH, 9510, 9550, 9600, 9610, 9650, CTS, CTS II SN 675101-679050	Side Rail	Right Hand AMAH130483	\$ 317.26	
		Left Hand AMAH130482	\$ 291.03	
 9560STS, 9570STS	Chopper Panel, Rear	AMH215050	\$ 240.00	
	9560STS, 9570STS, S550 SN 745100-764999	Chopper Panel, Rear	AMH205348	\$ 258.00

John Deere®—Combine









Application	Description	Part Number	Retail Price	Core
9650STS BSN 700500, 9750STS BSN 700600	Chopper Panel, Rear	AMH157482	\$ 290.00	
 9650STS, 9660STS, 9670STS, 9750STS, 9760STS, 9770STS, 9860STS, 9870STS	Cob Deflector	AMAH201004	\$ 215.00	
 9650STS, 9660STS, 9670STS, 9750STS, 9760STS, 9770STS, 9860STS, 9870STS	Deflector Sheet, Top	AMH172614	\$ 203.00	
 9570STS, 9670STS, 9770STS, 9870STS, S550 SN 745100-764999			\$ 23.00	
			\$ 23.00	
9560STS, 9570STS, 9650STS BSN 700500, 9660STS, 9670STS, 9750STS, 9760STS, 9770STS, 9860STS, 9870STS, S550 SN 745100-764999	Handle	AMAH201026	\$ 50.00	
 9560STS, 9650STS ASN 700501, (9660STS, 9760STS BSN 715400), 9750STS, 9860STS BSN 715600	Hanger	Right Hand AMAH215919	\$ 215.00	
9570STS, S550 SN 745100-764999	Hanger	Right Hand AMAH223140	\$ 171.00	
		Left Hand AMAH222816	\$ 182.00	
9650STS ASN 700501, (9660STS, 9760STS BSN 715400), 9750STS, 9860STS BSN 715600	Hanger	Left Hand AMAH205104	\$ 227.00	
9650STS BSN 700500, 9750STS BSN 700600	Hanger	Right Hand AMH157502	\$ 170.00	
		Left Hand AMAH149959	\$ 185.00	
 9570STS, 9670STS, 9770STS, 9870STS, S550 SN 745100-764999	Housing	Right Hand AMAH224940	\$ 83.00	
		Left Hand AMAH224939	\$ 83.00	
9560STS, 9570STS, 9650STS BSN 700500, 9660STS, 9670STS, 9750STS, 9760STS, 9770STS, 9860STS, 9870STS, S550 SN 745100-764999	Plate	AMH201116	\$ 18.00	
9560STS, 9570STS, 9650STS BSN 700500, 9660STS, 9670STS, 9750STS, 9760STS, 9770STS, 9860STS, 9870STS, S550 SN 745100-764999	Plate	AMAH201027	\$ 66.00	
 9560STS, 9570STS, 9650STS, 9660STS, 9670STS, 9750STS, 9760STS, 9770STS, 9860STS, 9870STS, 9880STS European BSN 715700, S540 South America, S550, (S560, S690 European)	Rubber Air Chute Flap	AMH204853	\$ 12.03	
 9650STS, 9660STS, 9670STS, 9750STS, 9760STS, 9770STS, 9860STS, 9870STS, 9880STS European BSN 715700	Rubber Hood Seal	AMH157528	\$ 17.24	
 (9660STS, 9760STS ASN 715401), 9670STS, 9770STS, 9860STS ASN 715604, 9870STS	Seal 54.528" Long For Rear Panel	AMH229546	\$ 21.00	
9560STS, 9570STS, S550 SN 745100-764999	Seal 4.724" Long For Rear Panel	AMH203963	\$ 18.00	

John Deere®—Combine

	Application	Description	Part Number	Retail Price	Core
	9400, 9410, 9450, 9500, 9510, 9550, CTS, CTS II	Shield	AMH146308	\$ 50.00	
	9600, 9610, 9650	Shield	AMH146307	\$ 40.00	
	9600 ASN 640300 w/ Standard Straw Chopper or SN 645301-655300 w/ Tri-Rotor Straw Chopper, 9610	Straw Chopper Rotor Shaft 73.87" Long	AMH145276	\$ 320.42	
	S650 ASN 765000, (S660, S670, S680, S690 ASN 745100), S670HM BSN 765000	Straw Chopper Outlet Housing For PowerCast™ Straw Chopper	AMAXE20855	\$ 775.00	
	S550, S650, S660, S670, S680, S690, S760, S770, S780, S790	Tailboard Trash Tube	AMX29126	\$ 165.00	
	9560STS, 9570STS, 9650STS, 9660STS, 9670STS, 9750STS, 9760STS, 9770STS, 9860STS, 9870STS, S550	Straw Chopper Actuator Replaces AH149880, AXE23606	AMAH209992	\$ 450.00	
	S650 ASN 765000, (S660, S670, S680, S690 ASN 745100), (S670HM, S680HM BSN 765000), S690HM SN 745101-765000, S760, S770, S780, S785, S790	Straw Chopper Actuator 12 Volt	AMAXE12904	\$ 885.00	
	9400, 9410, 9450, 9500, 9510, 9550, CTS, CTS II	Straw Chopper Adjuster Shaft	AMAH135837	\$ 145.00	
	9600, 9610, 9650, 9660	Straw Chopper Adjuster Shaft	AMAH135836	\$ 145.00	
	9400, 9410, 9450, 9500, 9500SH, 9501, 9510, 9510SH, 9550, 9550SH, 9560, 9560SH, 9600, 9610, 9650, 9660	Straw Chopper Adjuster Shaft Shield	AMH141388	\$ 10.00	
	9650STS, 9660STS, 9670STS, 9750STS, 9770STS, 9860STS, 9870STS	Straw Chopper Door	AMAH168277	\$ 545.00	
	9400, 9410, 9450, 9500, 9510, 9600, 9610	Straw Chopper Jackshaft	AMH137570	\$ 48.64	
	S660, S670	Straw Chopper Strip Electric Tailboard	AMH207023	\$ 80.00	
	9560STS, 9570STS, S550 SN 745100-764999	Straw Chopper Strip For Rear Panel	AMH203964	\$ 24.00	
	9650STS BSN 700500, 9660STS, 9670STS, 9750STS, 9760STS, 9770STS, 9860STS, 9870STS	Straw Chopper Strip For Rear Panel	AMH168323	\$ 30.00	
	9560STS ASN 715301, 9570STS, (9660STS, 9760STS ASN 715401), 9670STS, 9770STS, 9860STS BSN 715600, 9870STS, S550 SN 745100-764999	Bracket	AMAH220827	\$ 47.00	
	9560STS BSN 715300, 9570STS, 9650STS ASN 700501, (9660STS, 9760STS BSN 715400), 9750STS, 9860STS BSN 715600, S550 SN 745100-764999	Bracket	AMH204769	\$ 32.00	

John Deere®—Combine



John Deere®—Combine

Application	Description	Part Number	Retail Price	Core
9560STS, 9570STS, 9650STS BSN 700500, 9660STS, 9670STS, 9750STS, 9760STS, 9770STS, 9860STS, 9870STS, S550 SN 745100-764999	Bracket For Rear Panel	AMH208584	\$ 32.00	
9560STS, 9650STS BSN 700500, (9660STS, 9760STS BSN 715400), 9750STS, 9860STS	Bracket	AMAH201984	\$ 24.00	
 9400, 9410, 9450, 9500, 9510, 9550, CTS, CTS II	Chopper Rail Bracket	AMH145778	\$ 70.00	
 9600, 9610, 9650	Chopper Rail Bracket	AMH145779	\$ 70.00	
 3300, 4400, 4420, 6600, 6601, 6602, 6620, 6622, 7700, 7701, 7720, 7721, 8820, 9400, 9500, 9500SH, 9501, 9600	Knife Bar Adjuster	AMH84992	\$ 10.00	
 9670STS, 9770STS, 9870STS	Hanger Bracket	Right Hand AMAH223141 Left Hand AMAH222462	\$ 161.00 \$ 162.00	
 (9560STS, 9660STS, 9760STS, 9860STS ASN 715601), 9670STS, 9770STS, 9870STS	Lower Bracket	Right Hand AMH209928 Left Hand AMH209929	\$ 42.00 \$ 42.00	
 9560STS BSN 715300, 9570STS, 9650STS ASN 700501, (9660STS, 9760STS BSN 715400), 9750STS ASN 700601, 9860STS BSN 715600, S550 SN 745100-764999	Lower Bracket Replaces H175499	Right Hand AMH207703	\$ 31.00	
 9560STS BSN 715300, 9570STS, 9650STS ASN 700501, (9660STS, 9760STS BSN 715400), 9750STS ASN 700601, 9860STS BSN 715600, S550 SN 745100-764999	Lower Bracket	Left Hand AMH175500	\$ 30.00	
9560STS ASN 715301, (9660STS, 9760STS ASN 715401), 9860STS ASN 715601	Mounting Bracket	Left Hand AMAH218277	\$ 115.00	
9560STS BSN 715300, 9570STS, 9650STS BSN 700500, (9660STS, 9760STS BSN 715400), 9750STS, 9860STS BSN 715600, S550 SN 745100-764999	Mounting Bracket	Right Hand AMAH165095	\$ 110.00	
9570STS, S550 SN 745100-764999	Mounting Bracket	Left Hand AMAH226898	\$ 122.00	
 9400 BSN 655100, 9610, 9650, 9660	Retaining Rod, Wide 62.756" Long Replaces H141135, H149993	AMH172440	\$ 34.11	
9450, 9550, 9550SH, 9560, 9560SH, 9650CTS, 9650STS BSN 700501, 9660CTS, 9660STS, 9670STS, 9750STS BSN 700601, 9760STS, 9770STS, 9860STS, 9870STS, CTS	Retaining Rod, Narrow 52.756" Long Replaces H141138, H149992, H172439	AMH206215	\$ 54.77	
 9560STS, 9570STS, 9650STS BSN 700500, 9660STS, 9670STS, 9750STS, 9760STS, 9770STS, 9860STS, 9870STS, S550 SN 754100-764999	Pin 5.344" Long, 0.675" Diameter, 0.161" Hole Diameter	AMH165584	\$ 21.00	

Prices Subject to Change without Prior Notice. The use of original equipment manufacturer (OEM) part numbers or trademarks, e.g. Case® and John Deere®, are for reference purposes only and for indicating product use and compatibility. Our company and the listed replacement parts contained herein are not sponsored, approved or manufactured by the OEM. All parts are New unless designated Reman in the description.

John Deere®—Combine

John Deere®—Combine

Application	Description	Part Number	Retail Price	Core
9570STS, 9670STS, 9770STS, 9860STS ASN 715601, 9870STS, S550 SN 745100-764999	Dowel Pin	AMH213314	\$ 29.00	
9560STS BSN 715300, 9570STS, 9650STS ASN 700501, 9660STS BSN 715400, 9750STS, 9760STS, 9860STS BSN 715600, S550 SN 745100-764999	Bushing w/ Large Hole	AMH176787	\$ 18.00	
9560STS, 9570STS, 9650STS, 9670STS, 9750STS, 9770STS, 9860STS, 9870STS, S650, S660, S670, S680, S690	Bushing	AMR117879	\$ 19.00	
9650STS BSN 700500, 9750STS BSN 700600	Bushing w/ Small Hole	AMH157507	\$ 18.00	
 9400 ASN 640100, 9410, 9450, 9500 ASN 640201, 9510, 9510SH, 9550, 9550SH, 9560, 9560SH, 9600 ASN 640300, 9610, 9650, 9650CTS, 9660, 9660CTS, CTS, CTS II	Drive Sprocket Bearing w/ Housing	AMAH139260	\$ 60.00	
 3300 ASN 200000, 4400 ASN 201251, 4420, 6600 ASN 206200, 6620, 7700 ASN 213300, 7720, 8820	Bearing, Straw Chopper Rotor Replaces JD9319	AMJD9275	\$ 24.15	
S670, S680, S690	Chop-To-Drop Actuator Replaces AN276545	AMAN272297	\$ 641.50	



Straw Chopper Floors

Application	Description	Part Number	Retail Price	Core
4400, 4420	Straw Chopper Floor Powder Coat Finish	AMH149830	\$ 185.00	
6600, 6620	Straw Chopper Floor Powder Coat Finish	AMH149831	\$ 210.00	
7700, 7720	Straw Chopper Floor Powder Coat Finish	AMH149832	\$ 245.00	
8820	Straw Chopper Floor Powder Coat Finish	AMH149833	\$ 285.00	
9400 BSN 655100, 9500 BSN 604200	Straw Chopper Floor Powder Coat Finish For Early Combines w/ Sickle Section Knives	AMAH123012	\$ 385.00	
9400 ASN 655101, 9410, 9450, 9500 ASN 640200, 9510, 9550, 9650CTS	Straw Chopper Floor Combines w/ Straw Chopper Knives	AMAH143048	\$ 565.00	
9560STS	Straw Chopper Floor	AMAH205006	\$ 515.00	
9570STS	Straw Chopper Floor	AMAH226920	\$ 535.00	
9600 BSN 640300	Straw Chopper Floor Powder Coat Finish For Early Combines w/ Sickle Section Knives	AMAH123011	\$ 415.00	
9600 ASN 640300, 9610, 9650	Straw Chopper Floor Powder Coat Finish For Combines w/ Straw Chopper Knives Replaces AH138154	AMAH143047	\$ 540.00	
(9650STS, 9750STS ASN 700501), 9660STS, 9760STS, 9860STS	Straw Chopper Floor Powder Coat Finish Replaces Bottom w/ 35 Knives	AMAH214452	\$ 425.00	

John Deere®—Combine

Application	Description	Part Number	Retail Price	Core
(9650STS, 9750STS BSN 700500)	Straw Chopper Floor Powder Coat Finish Replaces Bottom w/ 29 Knives	AMAH149878	\$ 490.00	
9670STS, 9770STS, 9870STS	Straw Chopper Floor	AMAH218187	\$ 465.00	
S550, S650, S660, S670, S680, S690, S760, S770, S780, S790	Straw Chopper Floor	AMAXE14857	\$ 565.00	

Knife Mount Channels and Parts



Application	Description	Part Number	Retail Price	Core
9400, 9410, 9450, 9500, 9510, 9550	Knife Mount Channel	AMAH140129	\$ 160.00	
9510, 9510SH, 9550, 9550SH, 9560, 9560SH, 9650, 9650CTS, 9650STS, 9660CTS, 9750STS, CTS	Knife Mount Channel For Fine Cut Choppers Requires (27) Knives	AMAH158821	\$ 169.98	
9560STS	Knife Mount Channel	AMAH205921	\$ 161.00	
9570STS, S550 SN 745100-764999	Knife Mount Channel	AMAH218230	\$ 174.00	
9600, 9610, 9650	Knife Mount Channel	AMAH140128	\$ 175.00	
9600, 9610, 9650, 9660	Knife Mount Channel For Fine Cut Choppers Requires (35) Knives	AMAH158820	\$ 188.69	
(9660STS, 9760STS ASN 715401), 9860STS ASN 715601	Knife Mount Channel	AMAH218313	\$ 180.00	
9670STS, 9770STS, 9870STS	Knife Mount Channel	AMAH218189	\$ 208.00	
9560STS	Knife Bar Kit Single Point Adjustment Includes (35) Stationary Knives	AMAH219258	\$ 345.00	
9560STS, 9650STS, 9660STS, 9750STS, 9760STS, 9860STS	Knife Bar Kit Single Point Adjustment Includes (35) Stationary Knives	AMAH219257	\$ 400.00	
6600, 6620	Knife Bar	AMH88798	\$ 105.00	
7700, 7720	Knife Bar	AMH88804	\$ 115.00	
9560STS ASN 715301, 9570STS, 9650STS, (9660STS, 9760STS ASN 715401), 9670STS, 9750STS, 9770STS, 9860STS ASN 715601, 9870STS, S550 SN 745100- 764999	Lift Arm	AMAH214384	\$ 38.00	
3300, 4400, 4420	Bracket	AMH88801	\$ 9.00	
6600, 6620, 6622, 7700, 7720, 8820, 9400 BSN 640100, 9500 BSN 640200, 9600 BSN 640300	Bracket	AMH88800	\$ 4.55	
(9400, 9500SH ASN 655101), 9450, 9500 ASN 955101, 9501 ASN 640401, 9510, 9510SH, 9550, 9550SH, 9560, 9560SH, 9600 ASN 650301, 9610, 9650, 9650CTS, 9660, 9660CTS, CTS BSN 655400	Support Bracket, Right Hand Support Bracket, Left Hand	AMH149026 AMH149027	\$ 30.75 \$ 30.75	
9560STS ASN 715301, 9570STS	Adjuster Assembly	AMAH223998	\$ 98.00	
9650STS, (9660STS, 9760STS ASN 715401), 9670STS, 9750STS, 9770STS, 9860STS ASN 715601, 9870STS	Adjuster Assembly	AMAH223985	\$ 102.00	
9560STS ASN 715301, 9570STS, S550 SN 745100- 764999	Adjuster Rod	AMAH217972	\$ 47.00	
9650STS, (9660STS, 9670STS, 9760STS, 9860STS ASN 715601), 9750STS, 9770STS, 9870STS, S650 ASN 765000, (S660, S670, S680, S690 ASN 745100)	Adjuster Rod Replaces AH214385	AMAH234779	\$ 54.00	
9560, 9560SH, 9560STS, 9570STS, 9650STS BSN 700500, 9660, 9660STS, 9670STS, 9750STS, 9760STS, 9770STS, 9860STS BSN 715600, S550 SN 745100-764999	Bushing	AMN110219	\$ 10.00	

John Deere®—Combine

John Deere®—Combine

Application	Description	Part Number	Retail Price	Core
9560STS ASN 715301, 9570STS, 9650STS, (9660STS, 9760STS, 9860STS ASN 715601), 9670STS, 9750STS, 9770STS, 9870STS, S550 SN 745100-764999	End Plate	AMH215015	\$ 8.00	
9560STS ASN 715301, 9570STS, 9650STS, (9660STS, 9760STS ASN 715401), 9670STS, 9750STS, 9770STS, 9860STS ASN 715601, 9870STS, S550 SN 745100-764999	Wing Nut	AMAH214386	\$ 10.00	



Wide Spread Deflector Assemblies and Components

Application	Description	Part Number	Retail Price	Core
4400, 4420	Wide Spread Deflector Assembly	AMJDDA4400	\$ 525.00	
	Components:			
	Short Fin, Right Hand	3 AMH114537	\$ 15.00	
	Short Fin, Left Hand	3 AMH114538	\$ 15.00	
	Back	1 AMH113330	\$ 90.00	
	Tail Board	1 AMAH125071	\$ 220.00	
	Tail Support Rod Kit	1 AMH138800	\$ 40.00	
6600, 6620	Wide Spread Deflector Assembly	AMJDDA6600	\$ 645.00	
	Components:			
	Long Wide Fin, Right Hand	1 AMH130949	\$ 28.00	
	Long Wide Fin, Left Hand	1 AMH130948	\$ 29.00	
	Long Narrow Fin, Right Hand	1 AMH114535	\$ 25.00	
	Long Narrow Fin, Left Hand	1 AMH114536	\$ 25.00	
	Short Fin, Right Hand	1 AMH114537	\$ 15.00	
	Short Fin, Left Hand	1 AMH114538	\$ 15.00	
	Back	1 AMH113331	\$ 110.00	
	Tail Board	1 AMAH125072	\$ 275.00	
	Tail Support Rod Kit	1 AMH138800	\$ 40.00	
7700, 7720	Wide Spread Deflector Assembly	AMJDDA7700	\$ 735.00	
	Components:			
	Long Wide Fin, Right Hand	1 AMH130949	\$ 28.00	
	Long Wide Fin, Left Hand	1 AMH130948	\$ 29.00	
	Long Narrow Fin, Right Hand	1 AMH114535	\$ 25.00	
	Long Narrow Fin, Left Hand	1 AMH114536	\$ 25.00	
	Short Fin, Right Hand	1 AMH114537	\$ 15.00	
	Short Fin, Left Hand	1 AMH114538	\$ 15.00	
	Back	1 AMH113332	\$ 125.00	
	Tail Board	1 AMAH125073	\$ 315.00	
	Tail Support Rod Kit	1 AMH138800	\$ 40.00	

John Deere®—Combine

Application	Description	Part Number	Retail Price	Core
8820	Wide Spread Deflector Assembly	AMJDDA8820	\$ 815.00	
	Components:			
	Long Wide Fin, Right Hand	1 AMH130949	\$ 28.00	
	Long Wide Fin, Left Hand	1 AMH130948	\$ 29.00	
	Long Narrow Fin, Right Hand	2 AMH114535	\$ 25.00	
	Long Narrow Fin, Left Hand	2 AMH114536	\$ 25.00	
	Short Fin, Right Hand	1 AMH114537	\$ 15.00	
	Short Fin, Left Hand	1 AMH114538	\$ 15.00	
	Back	1 AMH113333	\$ 145.00	
	Tail Board	1 AMAH125074	\$ 320.00	
	Tail Support Rod Kit	1 AMH138800	\$ 40.00	
9400, 9410, 9450, 9500, 9510, 9550	Wide Spread Deflector Assembly OEM Standard	AMJDDA9500	\$ 855.00	
	Components:			
	Long Wide Fin, Right Hand	1 AMH130949	\$ 28.00	
	Long Wide Fin, Left Hand	1 AMH130948	\$ 29.00	
	Long Narrow Fin, Right Hand	1 AMH114535	\$ 25.00	
	Long Narrow Fin, Left Hand	1 AMH114536	\$ 25.00	
	Short Fin, Right Hand	1 AMH114537	\$ 15.00	
	Short Fin, Left Hand	1 AMH114538	\$ 15.00	
	Back	1 AMAH139791	\$ 110.00	
	Tail Board	1 AMAH125999	\$ 245.00	
	Tail Support Rod Kit	1 AMH138800	\$ 40.00	
9400, 9410, 9500, 9510, 9550	Wide Spread Deflector Assembly OEM Wide	AMJDDA9550	\$ 855.00	
	Components:			
	Long Wide Fin, Right Hand	2 AMH150401	\$ 33.00	
	Long Wide Fin, Left Hand	2 AMH150402	\$ 33.00	
	Short Wide Fin, Right Hand	1 AMH150403	\$ 19.00	
	Short Wide Fin, Left Hand	1 AMH150404	\$ 19.00	
	Back	1 AMAH144478	\$ 100.00	
	Tail Board	1 AMAH125999	\$ 245.00	
	Tail Support Rod Kit	1 AMH138800	\$ 40.00	
9600, 9610, 9650	Wide Spread Deflector Assembly OEM Standard	AMJDDA9600	\$ 915.00	
	Components:			
	Long Wide Fin, Right Hand	1 AMH130949	\$ 28.00	
	Long Wide Fin, Left Hand	1 AMH130948	\$ 29.00	
	Long Narrow Fin, Right Hand	1 AMH114535	\$ 25.00	
	Long Narrow Fin, Left Hand	1 AMH114536	\$ 25.00	
	Short Fin, Right Hand	2 AMH114537	\$ 15.00	
	Short Fin, Left Hand	2 AMH114538	\$ 15.00	
	Back	1 AMAH139790	\$ 125.00	
	Tail Board	1 AMAH125998	\$ 250.00	
	Tail Support Rod Kit	1 AMH138800	\$ 40.00	

Prices Subject to Change without Prior Notice. The use of original equipment manufacturer (OEM) part numbers or trademarks, e.g. Case® and John Deere®, are for reference purposes only and for indicating product use and compatibility. Our company and the listed replacement parts contained herein are not sponsored, approved or manufactured by the OEM. All parts are New unless designated Reman in the description.

John Deere®—Combine

John Deere®—Combine

Application	Description	Part Number	Retail Price	Core
9600, 9610, 9650	Wide Spread Deflector Assembly OEM Wide	AMJDDA9650	\$ 915.00	
	Components:			
	Long Wide Fin, Right Hand	2 AMH150401	\$ 33.00	
	Long Wide Fin, Left Hand	2 AMH150402	\$ 33.00	
	Short Wide Fin, Right Hand	2 AMH150403	\$ 19.00	
	Short Wide Fin, Left Hand	2 AMH150404	\$ 19.00	
	Back	1 AMAH144477	\$ 175.00	
	Tail Board	1 AMAH125998	\$ 250.00	
	Tail Support Rod Kit	1 AMH138800	\$ 40.00	
9670STS, 9770STS, 9870STS	Wide Spread Deflector Assembly	AMX2710106	\$ 1150.00	
	Components:			
	Long Curved Vane, Right Hand	2 AMHXE80254	\$ 35.75	
	Long Curved Vane, Left Hand	2 AMHXE36443	\$ 36.00	
	Straight Vane, Right Hand	1 AMHXE80252	\$ 37.00	
	Straight Vane, Left Hand	1 AMHXE36439	\$ 36.00	
	Cupped Vane, Right Hand	2 AMHXE80255	\$ 49.00	
	Cupped Vane, Left Hand	2 AMHXE36445	\$ 47.00	
	Vane, Right Hand	2 AMHXE80253	\$ 32.00	
	Vane, Left Hand	1 AMHXE36441	\$ 36.00	
	Tail Board	1 AMAH218490	\$ 645.00	
	Tail Board Support	2 AMAH220019	\$ 68.00	
6600, 6620, 7700, 7720, 9400, 9410, 9500, 9510	Wide Spread Fin Kit	AMAH138803	\$ 125.00	
	Components:			
	Long Wide Fin, Right Hand	1 AMH130949	\$ 28.00	
	Long Wide Fin, Left Hand	1 AMH130948	\$ 29.00	
	Long Narrow Fin, Right Hand	1 AMH114535	\$ 25.00	
	Long Narrow Fin, Left Hand	1 AMH114536	\$ 25.00	
	Short Fin, Right Hand	1 AMH114537	\$ 15.00	
	Short Fin, Left Hand	1 AMH114538	\$ 15.00	
9400, 9410, 9500, 9510, 9550	Wide Spread Fin Kit OEM Wide	AMX2710104	\$ 175.00	
	Components:			
	Long Wide Fin, Right Hand	2 AMH150401	\$ 33.00	
	Long Wide Fin, Left Hand	2 AMH150402	\$ 33.00	
	Short Wide Fin, Right Hand	1 AMH150403	\$ 19.00	
	Short Wide Fin, Left Hand	1 AMH150404	\$ 19.00	
9600, 9610, 9650	Wide Spread Fin Kit OEM Standard	AMX2710102	\$ 150.00	
	Components:			
	Long Wide Fin, Right Hand	1 AMH130949	\$ 28.00	
	Long Wide Fin, Left Hand	1 AMH130948	\$ 29.00	
	Long Narrow Fin, Right Hand	1 AMH114535	\$ 25.00	
	Long Narrow Fin, Left Hand	1 AMH114536	\$ 25.00	
	Short Fin, Right Hand	2 AMH114537	\$ 15.00	
	Short Fin, Left Hand	2 AMH114538	\$ 15.00	

John Deere®—Combine

Application	Description	Part Number	Retail Price	Core
9600, 9610, 9650	Wide Spread Fin Kit Deep & Wide Spread	AMX2710103	\$ 200.00	
	Components:			
	Long Wide Fin, Right Hand	2 AMH150401	\$ 33.00	
	Long Wide Fin, Left Hand	2 AMH150402	\$ 33.00	
	Short Wide Fin, Right Hand	2 AMH150403	\$ 19.00	
	Short Wide Fin, Left Hand	2 AMH150404	\$ 19.00	
9560STS, 9570STS, 9650STS ASN 696468, 9660STS, 9670STS, 9750STS ASN 696058, 9760STS, 9770STS, 9860STS, 9870STS, S550 SN 745100-764999, (S650, S660, S670, S680, S690 ASN 745100), S670HM BSN 765000	Vane, Right Hand Cupped, 7.049" Wide Fins in #4 and #5 Positions Replaces HXE80255	AMH204777	\$ 45.89	
	Vane, Left Hand Cupped, 7.049" Wide Fins in #4 and #5 Positions Replaces HXE36445	AMH204776	\$ 48.97	
9570STS, 9670STS, 9770STS, 9870STS, S550 SN 745100-764999, S650 ASN 765000, (S660, S670, S680, S690 ASN 745100)	Vane, Right Hand Tailboard	AMH236607	\$ 39.00	
	Vane, Tailboard, Left Hand Long Curved Replaces H236606	AMHXE36443	\$ 36.00	
9560STS, 9570STS, 9650STS ASN 696468, 9660STS, 9670STS, 9750STS ASN 696068, 9760STS, 9770STS, 9860STS, 9870STS, S550 SN 745100-764999, S650 ASN 765000, (S660, S670, S680, S690 ASN 745100), S670HM, S680HM, S690HM, S760, S770, S780, S790	Vane, Right Hand Straight Replaces H204218, H223218	AMHXE80252	\$ 37.00	
	Vane, Left Hand Straight Replaces H223216	AMHXE36439	\$ 36.00	
9650STS BSN 696468, 9750STS BSN 696058	Vane, Right Hand Straight, 5.906" Wide	AMH167216	\$ 24.60	
	Vane, Left Hand Straight, 5.906" Wide	AMH167215	\$ 24.60	
9650STS BSN 696467, 9750STS BSN 696058	Vane, Right Hand Deep, 6.024" Wide	AMH167320	\$ 24.60	
	Vane, Left Hand Deep, 6.024" Wide	AMH167319	\$ 24.60	
9670STS, 9770STS, 9870STS, S550 SN 745100-764999, S650 ASN 765000, (S660, S670, S680, S690 ASN 745100)	Vane, Right Hand Fins in #2 Position	AMHXE80253	\$ 32.00	
	Vane, Left Hand Fins in #2 Position	AMHXE36441	\$ 36.00	
	Vane, Right Hand Tailboard, Cupped Fins in #4 and #5 Positions	AMHXE80255	\$ 49.00	
	Vane, Left Hand Tailboard, Cupped Fins in #4 and #5 Positions	AMHXE36445	\$ 47.00	
9670STS, 9770STS, 9870STS, S650 ASN 765000, (S660, S670, S680, S690 ASN 745100)	Vane, Right Hand Long Curved	AMHXE80254	\$ 35.75	
S650 ASN 765000, (S660, S670, S680, S690 ASN 745100)	Vane, Tailboard, Left Hand Long Curved Replaces H236606	AMHXE36443	\$ 36.00	
S660 SN 745100-765171, S670 SN 745100-765252	Vane Link	AMH205541	\$ 11.00	
9560STS, 9650STS BSN 696467, 9660STS, 9750STS BSN 696057, 9760STS, 9860STS	Bracket	AMH162520	\$ 22.00	

John Deere®—Combine

John Deere®—Combine

Application	Description	Part Number	Retail Price	Core
9560STS, 9570STS, 9650STS BSN 700500, 9660STS, 9670STS, 9750STS, 9760STS, 9770STS, 9860STS, 9870STS, S550 SN 745100-764999	Bracket	AMH174305	\$ 23.00	
9400, 9410, 9500, 9500SH, 9510, 9510SH, 9550, 9550SH, 9560, 9560SH, 9650CTS, 9660CTS, CTS, CTS II	Straw Chopper Deflector Sheet, Standard 54.188" Long, 6.89" Wide	AMH157109	\$ 92.26	
9400, 9410, 9450, 9500, 9500SH, 9510, 9510SH, 9550, 9550SH, 9560, 9560SH, 9650CTS, 9660CTS, CTS, CTS II	Straw Chopper Deflector Sheet, Wide Spread 54.188" Long, 3.937" Wide	AMH150408	\$ 74.37	
9560STS, 9570STS, S550 SN 745100-764999	Cob Deflector Deflector Sheet, Top	AMAH204812 AMH205980	\$ 210.00 \$ 198.00	
9560STS, 9570STS, S550 SN 745100-764999	Door	AMAH201237	\$ 450.00	
9400, 9410, 9450, 9500, 9510, 9550, 9560, 9570STS, 9600, 9610, 9650, 9650STS, 9660, 9670STS, 9750STS, 9770STS, 9860STS, 9870STS, CTS, CTS II, S550, S660, S670, S680, S690	Pin	AMH136179	\$ 11.96	
9560STS, 9570STS, 9650STS BSN 700500, 9660STS, 9670STS, 9750STS, 9760STS, 9770STS, 9860STS, 9870STS, S550 SN 745100-764999	Plate	AMH157499	\$ 19.00	
9560STS, 9570STS, 9650STS, 9660STS, 9670STS, 9750STS, 9760STS, 9770STS, 9860STS, 9870STS	Small Fin, Right Hand Replaces H223218	AMH204218	\$ 30.39	
9670STS, 9770STS, 9870STS	Tail Board	AMAH218490	\$ 645.00	
S650, S660, S670, S680, S690, S760, S770, S780, S790	Tail Board	AMBXE10176	\$ 1560.00	
9570STS, S550	Tail Board	AMAH222834	\$ 610.00	
9570STS, 9670STS, 9770STS, 9870STS, S550	Tail Board Support	AMAH220019	\$ 68.00	

Sickle Knife Heads



Application	Description	Part Number	Retail Price	Core
Platforms: 213, 215, 216, 218, 220, 222, 224, 230, 314, 315, 319, 323, 325, 913F, 913R, 915F, 915R, 918F, 918R, 920F, 920R, 922F, 922R, 924F, 924R, 925F, 925R, 930F, 930R	Sickle Knife Head	AMAH89498	\$ 134.88	
Platforms: 615F, 615R, 618F, 618R, 620F, 620R, 622F, 622R, 625D, 625F, 625R, 630D, 630F, 630FD, 630R, 635D, 635F, 635FD, 635R, 640D, 640FD, 725D, 730D, 730FD, 735D, 735FD, 740D, 740FD, 745FD, (925D, 930D, 936D ASN 710101)	Sickle Knife Head, Drive Block Replaces DE19294	AMAXE24816	\$ 198.89	
Platforms: 615F, 615R, 618F, 618R, 620F, 620R, 622F, 622R, 625F, 625R, 630F, 630R, 635F, 635R	Sickle Knife Head	AMAH205916	\$ 100.00	
Platforms: 625D, 630D, 635D, 640D	Sickle Knife Head	AMAH231841	\$ 90.00	
Platforms: 630FD, 635FD, 645FD	Sickle Knife Head	AMAH231842	\$ 92.00	
Draper Platforms: 925D, 930D, 936D	Sickle Knife Head	AMAH220050	\$ 120.00	

John Deere®—Combine



Sickle Assemblies With Heads

Application	Description		Part Number	Retail Price	Core
Platforms: 213, 913	Sickle Assembly w/ Head, Coarse	13'	AMAH121076	\$ 324.00	
Platforms: 215, 915	Sickle Assembly w/ Head, Coarse 60 Sections	15'	AMAH121077	\$ 355.00	
Platform: 216	Sickle Assembly w/ Head, Coarse	16'	AMAH125752	\$ 450.00	
Platforms: 218, 918	Sickle Assembly w/ Head, Coarse	18'	AMAH121079	\$ 433.00	
Platforms: 220, 920	Sickle Assembly w/ Head, Coarse	20'	AMAH121081	\$ 430.00	
Platforms: 222, 922	Sickle Assembly w/ Head, Coarse	22'	AMAH121083	\$ 487.00	
Platform: 224	Sickle Assembly w/ Head, Coarse	24'	AMAH121085	\$ 507.00	
Platforms: 230, 930	Sickle Assembly w/ Head, Coarse	30'	AMAH121087	\$ 579.00	
Platform: 615	Sickle Assembly w/ Head, Coarse	15'	AMX29008	\$ 406.00	
Platform: 618	Sickle Assembly w/ Head, Coarse	18'	AMX29009	\$ 647.00	
Platform: 620	Sickle Assembly w/ Head, Coarse	20'	AMX29010	\$ 480.00	
Platform: 622	Sickle Assembly w/ Head, Coarse	22'	AMX29011	\$ 521.00	
Platform: 625	Sickle Assembly w/ Head, Coarse	25'	AMX29012	\$ 573.00	
Platform: 630	Sickle Assembly w/ Head, Coarse	30'	AMX27333	\$ 693.00	
	Sickle Assembly w/ Head, Fine Plated, Serrated Includes Splice Kit and Installation Instructions Replaces AH213011, AH219604	30'	AMX34134	\$ 675.00	
Platforms: 635, 635R	Sickle Assembly w/ Head, Coarse	35'	AMX27334	\$ 828.00	
Platforms: 635F, 635R	Sickle Assembly w/ Head, Fine Plated, 14 Teeth per Inch Top Serrated Features bolt-together, bolt-on coarse sections. Replaces AH213011, AH219604		AMX34135	\$ 807.00	
Platform: 925R, 925F	Sickle Assembly w/ Head, Coarse	25'	AMAH121221	\$ 495.00	
Draper Platform: 925D	Sickle Assembly w/ Head, Coarse Plated, 7 Teeth per Inch Includes Splice Kit Features bolt-together, bolt-on coarse sections Convenient to transport and store	25'	AMX29064	\$ 646.00	
	Sickle Assembly w/ Head, Fine Plated, 14 Teeth per Inch Includes Splice Kit Features bolt-together, bolt-on fine sections Convenient to transport and store	25'	AMX29065	\$ 646.00	
Platform: 930D	Sickle Assembly w/ Head, Coarse Plated, 7 Teeth per Inch Includes Splice Kit Features bolt-together, bolt-on coarse sections Convenient to transport and store	30'	AMX29066	\$ 700.00	
	Sickle Assembly w/ Head, Fine Plated, 14 Teeth per Inch Includes Splice Kit Features bolt-together, bolt-on fine sections Convenient to transport and store	30'	AMX29067	\$ 749.00	

John Deere®—Combine

John Deere®—Combine

Application	Description	Part Number	Retail Price	Core
Draper Platform: 600R Double Drive	Sickle Assembly w/ Head, Fine Plated, 14 Teeth per Inch	25' Right Hand	AMX29080	\$ 408.00
		25' Left Hand	AMX29079	\$ 404.00
	Features bolt-together, bolt-on fine sections	30' Right Hand	AMX29082	\$ 418.00
		30' Left Hand	AMX29081	\$ 435.00
	Convenient to transport and store	35' Right Hand	AMX29084	\$ 474.00
		35' Left Hand	AMX29083	\$ 522.00
		40' Right Hand	AMX29086	\$ 487.00
		40' Left Hand	AMX29085	\$ 490.00
Draper Platform: 630FD, 730FD - Double Drive	Sickle Assembly w/ Head, Coarse Plated, 7 Teeth per Inch, Top Serrated	30' Right Hand	AMX29071	\$ 461.00
		30' Left Hand	AMX29070	\$ 476.00
Features bolt-together, bolt-on coarse sections	Convenient to transport and store			
Draper Platform: 635FD, 745FD - Double Drive	Sickle Assembly w/ Head, Coarse Plated, 7 Teeth per Inch, Top Serrated	35' Right Hand	AMX29073	\$ 491.00
		35' Left Hand	AMX29072	\$ 566.00
Features bolt-together, bolt-on coarse sections	Convenient to transport and store			
Draper Platform: 640FD, 740FD - Double Drive	Sickle Assembly w/ Head, Coarse Plated, 7 Teeth per Inch, Top Serrated	40' Right Hand	AMX29075	\$ 598.00
		40' Left Hand	AMX29074	\$ 644.00
Features bolt-together, bolt-on coarse sections	Convenient to transport and store			
Draper Platform: 645FD, 745FD - Double Drive	Sickle Assembly w/ Head, Coarse Plated, 7 Teeth per Inch, Top Serrated	45' Right Hand	AMX29077	\$ 620.00
		45' Left Hand	AMX29076	\$ 640.00
Features bolt-together, bolt-on coarse sections	Convenient to transport and store			
Draper Platform: 936D	Sickle Assembly w/ Head, Coarse Plated, 7 Teeth per Inch	36'	AMX29068	\$ 953.00
Includes Splice Kit	Features bolt-together, bolt-on coarse sections			
	Convenient to transport and store			
	Sickle Assembly w/ Head, Fine Plated, 14 Teeth per Inch	36'	AMX29069	\$ 780.00
Includes Splice Kit	Features bolt-together, bolt-on fine sections			
	Convenient to transport and store			
Platforms: 213, 215, 216, 218, 220, 222, 224, 230, 913, 915, 918, 920, 922, 925, 930	Splice Kit	AMX29060	\$ 28.00	
Includes (10) Countersunk Bolts, (10) Metric Flange Nuts and Installation Instructions				
Platforms: 600F, 600R, 625D, 630D, 635D, 635FD, 640D, 640FD, 925D, 930D, 936D	Splice Kit	AMAH205715	\$ 30.00	
Replaces AH166962				
Draper Platforms: 600F, 600R, 635FD, 640FD, 645FD	Splice Kit	AMAH205918	\$ 30.00	
Includes (8) Countersunk Bolts, (8) Metric Flange Nuts and Installation Instructions				

Cutter Bar Components

The Gold'N Cut section utilizes a coarse serration that sharpens itself as wearing occurs, giving you the longest wear for your money. All sickle sections feature bolt-on convenience and are heat-treated for superior cutting life.

Application	Description	Part Number	Retail Price	Core
Platforms: 213, 215, 216, 218, 220, 222, 224, 230, 913F, 913R, 915F, 915R, 918F, 918R, 920F, 920R, 922F, 922R, 924F, 924R, 925F, 925R, 930F, 930R	Section, 3" Fine	AMH136807	\$ 2.75	
	14 Tooth			
	Sold in Multiples of 25, Priced Individually			
	Replaces H207929			
	Section, 3" Course	AMH168316	\$ 1.55	
	Sold in Multiples of 25, Priced Individually			
	Sickle Section Half, End Smooth	AMH125894	\$ 2.50	
	Replaces H81499			

John Deere®—Combine

John Deere®—Combine

Application	Description	Part Number	Retail Price	Core
Platforms: 213, 215, 216, 218, 220, 222, 224, 230, 615F, 615R, 618F, 618R, 620F, 620R, 622F, 622R, 625F, 625R, 630F, 630R, 635F, 635R, 913F, 913R, 915F, 915R, 918F, 918R, 920F, 920R, 922F, 922R, 924F, 924R, 925F, 925R, 930F, 930R, RD30F, RD35F, RD40F, RD45F, Draper Platforms: 625D, 630D, 630FD, 635D, 635FD, 640D, 640FD, 645FD, 725D, 730D, 730FD, 735D, 735FD, 740D, 740FD, 745FD, 925D, 930D, 936D	Section, 4" Fine Double Tooth, 14 Tooth	AMH153329	\$ 2.50	
Platforms: 213, 215, 216, 218, 220, 222, 224, 230, 615F, 615R, 618F, 618R, 620F, 620R, 622F, 622R, 625F, 625R, 630F, 630R, 635F, 635R, 913F, 913R, 915F, 915R, 918F, 918R, 920F, 920R, 922F, 922R, 924F, 924R, 925F, 925R, 930F, 930R, RD30F, Platforms: 625D, 630D, 630FD, 635D, 635FD, 640D, 640FD, 645FD, 725D, 730D, 730FD, 735D, 735FD, 740D, 740FD, 745FD, 925D, 930D, 936D	Section, 4" Course Double Tooth, 7 Tooth	AMH163131	\$ 2.35	
213, 215, 216, 218, 220, 222, 224, 230, 615F, 615R, 618F, 618R, 620F, 620R, 622F, 622R, 625F, 625R, 630F, 630R, 635F, 635R, 913F, 913R, 915F, 915R, 918F, 918R, 920F, 920R, 922F, 922R, 924F, 924R, 925F, 925R, 930F, 930R, Draper Platforms: 630FD, 730FD	Section Half, Fine 14 Tooth	AMH161242	\$ 3.00	
213, 215, 216, 218, 220, 222, 224, 230, 615F, 615R, 618F, 618R, 620F, 620R, 622F, 622R, 625F, 625R, 630F, 630R, 635F, 635R, 913F, 913R, 915F, 915R, 918F, 918R, 920F, 920R, 922F, 922R, 924F, 924R, 925F, 925R, 930F, 930R, Draper Platforms: 630FD, 730FD	Section Half, Coarse 7 Tooth	AMH163132	\$ 3.75	
Platforms: 630FD, 635FD, 640FD, 645FD	Section, End	AMH226352	\$ 4.50	
Platforms: 213, 215, 216, 218, 220, 222, 224, 230, 615F, 615R, 618F, 618R, 620F, 620R, 622F, 622R, 625F, 625R, 630F, 630R, 635F, 635R, 913F, 913R, 915F, 915R, 918F, 918R, 920F, 920R, 922F, 922R, 924F, 924R, 925F, 925R, 930F, 930R	Section Bolt and Nut Kit Package of 50 Replaces H158341, 14M7303	AMX27520	\$ 19.00	
Platforms: 913F, 913R, 915F, 915R, 918F, 918R, 920F, 920R, 922F, 922R, 924F, 924R, 925F, 925R, 930F, 930R	Section Bolt and Nut Kit Package of 50 Replaces H125891, H125892	AMX27521	\$ 11.00	



Guards and Cutter Bar Parts

Application	Description	Part Number	Retail Price	Core
Platforms: 213, 215, 216, 218, 220, 222, 224, 230, 913, 915, 916, 918, 920, 922, 924, 925, 930	Knife Guard Non-Clog	AME59625	\$ 11.00	
Platforms: 615F, 615R, 618F, 618R, 620F, 620R, 622F, 622R, 625F, 625R, 630F, 630R, 635F, 635R, RD35F, RD40F, RD45F, Draper Platforms: 630FD, 635FD, 640FD, 645FD, 730FD, 735FD, 740FD, 745FD	Knife Guard, Blunt Points Short/Long/Short Blunt Points 2.75" Long Middle Point Marked 615 Replaces AH205482, AH213055, H213400, H229538	AMH213507	\$ 13.00	
	Knife Guard, Blunt Points Long/Short/Long Blunt Points 2.75" Long Outside Points Marked 610 Replaces H213398, H205448, H205992, H229537	AMH213398	\$ 13.00	
Platforms: 625D, 630D, 635D, 640D, 630FD, RD35F, RD40F, RD45F, Draper Platforms: 635FD, 640FD, 645FD, 730FD, 735FD, 740FD, 745FD	Knife Guard End, Single Prong (1) Required per Head	AMH228526	\$ 10.00	
	Knife Guard Left Middle-Overlap 4" Non-Clog Dual Knife, Open (1) Required per Head	AMHXE18172	\$ 25.00	

John Deere®—Combine

Application	Description	Part Number	Retail Price	Core
Platforms: RD35F, RD40F, RD45F, Draper Platforms: 630FD, 635FD, 640FD, 645FD, 730FD, 735FD, 740FD, 745FD	Knife Guard Right Middle-Overlap 4" Non-Clog, Open (1) Required per Head	AMHXE19625	\$ 25.00	
Platforms: 213, 215, 216, 218, 220, 222, 224, 230, 913F, 913R, 915F, 915R, 918F, 918R, 920F, 920R, 922F, 922R, 924F, 924R, 925F, 925R, 930F, 930R	Knife Guard, Double Pronged Heat Treated Replaces H113571, H145791, H153719, H171031	AMH75386	\$ 9.00	
Platforms: 213, 215, 216, 218, 220, 222, 224, 230, 913F, 913R, 915F, 915R, 918F, 918R, 920F, 920R, 922F, 922R, 924F, 924R, 925F, 925R, 930F, 930R, Quik-Tatch™ Combine Platforms	Knife Guard, 3 Tine	AMH25603	\$ 15.00	
Platforms: 615R, 618R, 620R, 622R, 625R, 630R, 635R, Draper Platforms: 625D, 630D, 635D, 640D, 725D, 730D, 735D, 740D, 925D, 930D, 936D	Knife Guard, Long Point Short/Long/Short Points, Standard Wear 4" Long Middle Point Marked 630 Replaces AH159209, AH164123, AH206088, AH213056, H229540	AMH213508	\$ 16.00	
	Knife Guard, Long Points Long/Short/Long Points, High Wear 4" Long Outside Points Marked 635 Replaces H162565, H170338, H206177, H229539	AMH213405	\$ 15.00	
Platforms: 913F, 913R, 915F, 915R, 918F, 918R, 920F, 920R, 922F, 922R, 924F, 924R, 925F, 925R, 930F, 930R	Sickle Section, 3" Coarse 7 Tooth, Chrome Replaces H160251	AMH207930	\$ 2.00	
Platforms: 213, 215, 216, 218, 220, 222, 224, 230, Quik-Tatch™ Combine Platforms	Knife Clip, Low Profile Adjustable Replaces 1307280C3, 71346158, 86630786, H84412	AMX29115	\$ 14.75	
	Knife Clip, Low Profile Replaces 1307280C3, 71346158, 86630786, H84412	AMX27554	\$ 3.95	
Platforms: 213, 215, 216, 218, 220, 222, 224, 913, 915, 916, 918, 920, 922, 924, 925, 930	Wear Plate	AME47954	\$ 2.00	
Platforms: 213, 215, 216, 218, 220, 222, 224, 230, 913F, 913R, 915F, 915R, 918F, 918R, 920F, 920R, 922F, 922R, 924F, 924R, 925F, 925R, 930F, 930R, Quik-Tatch™ Combine Platforms	Wear Plate Replaces H153157	AMH141546	\$ 2.00	
Platforms: (213, 215, 216, 218, 220, 222, 224, 230 ASN 620300), 218, 915, 918, 920, 922, 925, 930, (314F, 314R, 316F, 316R, 319F, 319R, 323F, 325F ASN 024398), Draper Platform: 918	Hold Down Clip, Cast, Left Hand Use w/ Bolt-On Sickle Sections For Platforms w/ Sectionalized Knife Assemblies	AMH129024	\$ 4.82	
Platforms: (213, 215, 216, 218, 220, 222, 224, 230 ASN 620301), (316, 319, 325 ASN 024399), (620F, 620R, 622F, 622R, 625F, 625R, 630F, 630R, 635F, 635R ASN 710101), (913F, 913R, 915F, 915R, 918F, 918R, 920F, 920R, 922F, 922R, 924F, 924R, 930F, 930R 625301-685400), Draper Platforms: 218D, 918D, 920D	Hold Down Clip	AMH127801	\$ 3.15	
Platforms: 620F, 620R, 625F, 625R, 630F, 630R, 635F, 635R, 925D, 930D, 936D, RD30F, RD35F, RD40F, RD45F, Draper Platforms: 625D, 630D, 630FD, 635D, 635FD, 640D, 640FD, 645FD, 725D, 730D, 730FD, 735D, 735FD, 740D, 740FD, 745FD	Hold Down Clip, Hi-Arch Adjustable Replaces AH213058	AMAH218548	\$ 4.75	
	Hold Down Clip, Low Adjustable	AMAH218547	\$ 5.00	

John Deere®—Combine

Application	Description	Part Number	Retail Price	Core
Platforms: 630FD, 635FD, 640FD, 645FD	Hold Down Clip (2) Required on Double Drive Platforms	AMAH226928	\$ 17.50	

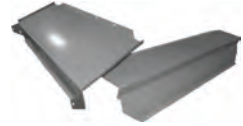

Rear Deflector (Isolator)

Application	Description	Part Number	Retail Price	Core
6620	Rear Deflector (Isolator), For Corn	AMH99507	\$ 210.00	
7720	Rear Deflector (Isolator), For Corn	AMH99508	\$ 240.00	
9500 BSN 640200	Rear Deflector (Isolator), For Corn	AMH136133	\$ 240.00	
9600 BSN 640200	Rear Deflector (Isolator), For Corn	AMH136134	\$ 245.00	



Corn Doors and Wheat Doors

Application	Description	Part Number	Retail Price	Core
6620	Corn Door	AMH85165	\$ 290.00	
7720	Corn Door	AMH112674	\$ 325.00	
8820	Corn Door	AMH112675	\$ 335.00	
9500, 9510, 9550	Corn Door	AMAH142778	\$ 280.00	
9600, 9610, 9650	Corn Door	AMAH142777	\$ 280.00	
All Straw Chopper Corn Doors	Corn Door Latch	Right Hand	AMAH86590	\$ 30.00
		Left Hand	AMAH86591	\$ 30.00
7700, 7720	Wheat Door	AMAH85665	\$ 295.00	
8820	Wheat Door	AMAH99304	\$ 290.00	

Chaff Spreaders and Components

Standard, patented single-wing arm design; spreader position is infinitely adjustable. Stainless steel front and rear shields. 39" chaff distribution area is the largest in the field. Complete with motor, hose kit and shaker pans.



Application	Description	Part Number	Retail Price	Core
6620	Chaff Spreader w/ Heavy Duty Adjustable or Rigid Axle	AMEF6602JDHD	\$ 1695.00	
7720	Chaff Spreader w/ Heavy Duty Adjustable or Rigid Axle	AMEF7702JDHD	\$ 1695.00	
8820	Chaff Spreader w/ Heavy Duty Adjustable or Rigid Axle	AMEF8802JDHD	\$ 1695.00	
9400, 9410, 9500, 9510, 9600, 9610	Chaff Spreader All Axles 39" Chaff Distribution Area Includes Motor, Hose Kit, Shaker Pans and Installation Instructions	AMEF9601JD92	\$ 1695.00	

Straw Spreader Components

Application	Description	Part Number	Retail Price	Core
9600, 9610, 9650, 9660	Straw Spreader Drive Shaft 59.56" Long	AMH134717	\$ 117.41	
(S660, S670, S680, S690 ASN 745100), S760, S770, S780, S790	Spreader Shaft	AMHXE42909	\$ 175.00	
9650STS, 9660STS, 9750STS, 9760STS, 9770STS, 9860STS, 9870STS, S650, S660, S670, S680, S690, S760, S770, S780, S790	Straw Spreader Disc	AMH171890	\$ 131.97	

Prices Subject to Change without Prior Notice. The use of original equipment manufacturer (OEM) part numbers or trademarks, e.g. Case® and John Deere®, are for reference purposes only and for indicating product use and compatibility. Our company and the listed replacement parts contained herein are not sponsored, approved or manufactured by the OEM. All parts are New unless designated Reman in the description.

John Deere®—Combine

Application	Description	Part Number	Retail Price	Core
6620, 7720, 8820	Spreader Blade	AMH76933	\$ 11.00	
9400, 9410, 9450, 9500, 9500SH, 9501, 9510, 9510SH, 9550SH, 9560, 9560SH, 9600, 9610, 9650, 9660	Idler Pulley 1.102" Wide, 3.25" OD, 0.677" Hole Diameter, 0.961" Groove Width Replaces AM108923	AMAM103480	\$ 21.07	
9400, 9410, 9450, 9510, 9550, 9550SH, 9560, 9560SH, 9600, 9610, 9650, 9650CTS, 9660, 9660CTS, CTS, CTS II	Straw Spreader Pulley 6.37" Diameter, 0.252" Hole Diameter, 1.001" Bore, 0.637" Groove Width	AMAH130964	\$ 42.52	
6600 ASN 7501, 6620, 7700 ASN 5001, 7720, 8820, 9400, 9410, 9450, 9500, 9510, 9550, 9600, 9610, 9650	Straw Spreader Bevel Gear 13 Tooth, 1" Bore For Dual Style Spreaders Only Sold in Multiples of 2, Priced Individually	AMH91796	\$ 29.50	
9650STS, 9660STS, 9670STS, 9750STS, 9760STS, 9770STS, 9860STS, 9870STS, S660, S670, S680, S690, S760, S770, S780, S790	Hub, Wide Straw Spreader Disc 1.006" ID, 0.04" OD	AMH211288	\$ 75.00	
9560STS, 9570STS, 9650STS, 9660STS, 9670STS, 9750STS, 9770STS, 9860STS, 9870STS, S550	Spreader Limited Curtain	AMH171649	\$ 111.80	
9570STS, 9650STS, 9660STS, 9670STS, 9750STS, 9760STS, 9770STS, 9860STS, 9870STS	Spreader Limited Curtain For Spreaders w/ Hitch	AMHXE27148	\$ 75.70	
9650STS, 9660STS, 9670STS, 9750STS, 9770STS, 9860STS, 9870STS	Spreader Limited Curtain Seal	AMH169618	\$ 33.39	

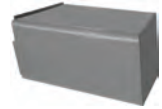

Rear Hoods and Components

Application	Description	Part Number	Retail Price	Core
8820	Separator Limit Curtain	AMAH91680	\$ 148.60	

Rear Hood, Lower Panels

Application	Description	Part Number	Retail Price	Core
6620, 7720, 8820	Hood Panel, Lower Rear Inner Right Hand	AMAH96734	\$ 375.00	
8820	Hood Panel, Lower Rear SMV decal fits on panel	AMAH96710	\$ 350.00	

Platform Adapter Kits

Application	Description	Part Number	Retail Price	Core
Cornheads and Platforms	Driveline Adapter Kit Adapts earlier model cornheads and platforms w/ hex back shafts to the newer John Deere® 50, 60 and 70 Series Combines that are either Rigid or Contour-Master™	AMX27555	\$ 1285.00	
Cornheads: 243, 244, 343, 344, 443, 444, 444SH, 493, 494, 543, 546, 592, 594, 642, 643, 643SH, 644, 645, 692, 693, 694, 842, 843, 844, 892, 893, 894, 1243	Cornhead Adapter Kit Shroud Not Included Replaces, AN102010, H147547, H153308	AMBH81399	\$ 68.00	

John Deere®—Combine



Row Crop Head Components

Application	Description	Part Number	Retail Price	Core
50 Series Early Style	Row Crop Belt	AMAE27079	\$ 190.00	
50A Series Late Style	Row Crop Belt	AMAH101172	\$ 120.00	
50A Series	Gathering Chain Drive Bearing Bearing # - 88506-R8 (4) Required Per Row	AMJD10091	\$ 14.50	
50 & 50A Series	Stationary Knife Hardfaced Replaces H101607	AMH139066	\$ 29.00	
50 & 50A Series	Rotating Knife Heat-treated Uses square-head, countersunk bolts to install (not included) Replaces H10167	AMH147109	\$ 7.00	
50A Series	Rotating Knife Drive Bearing Right and Left Hand, Bearing # - CSA206-18 (2) Required Per Row	AMJD10092	\$ 11.00	
50 & 50A Series	Row Unit Drive Bearing Bearing # - 206KRRB6 (2) Required Per Row	AMJD9313	\$ 11.00	
50 & 50A Series	Idler Sprocket Bearing, Press In Bearing # - 203KRR2	AMX27284	\$ 6.00	
50A Series	Gathering Chain Guide Sprocket Right Hand, 11 Tooth, 19 Spline, Ref# 1	AMAH101339	\$ 40.00	
50A Series	Gathering Chain Idler Sprocket 11 Tooth	AMAH103303	\$ 21.00	
50A Series	Gathering Chain Sprocket 11 & 12 Tooth, 19 Spline	AMAH101340	\$ 75.00	
50A Series	Chain Sprocket 13 Tooth, 1.756" ID, 3.475" OD	AMAH143100	\$ 68.00	
50A Series	Row Crop Drive Gear 18 Tooth, 1 1/8" Splined ID, Ref# 2	AMH101668	\$ 43.00	
50 & 50A Series	Row Crop Drive Gear 18 Tooth, 1" Hex Bore ID, Ref# 3	AMN14393	\$ 39.00	
50 Series, 50A Series, Forage Harvesters: 5440 w/ Double Auger, 5460, 5720, 5730, 5820, 5830	Auger Drive Gear 15 Tooth, 1.006" Hex Bore Diameter	AME63258	\$ 74.07	
50 & 50A Series	Finger Holder	AMAH171884	\$ 5.00	
50 & 50A Series	Finger Guide, Poly	AMH179000	\$ 3.00	
Platforms: 453, 453A BSN 655100, 454, 454A, 554, 653, 653A, 654, 654A, 853, 853A, (854A, 1253A BSN 630101)	Finger Guide Screw For Rigid or Flex Platforms	AMH86918	\$ 0.65	
50 & 50A Series	Finger Guide Plate, Steel	AMH87192	\$ 1.45	
50 & 50A Series	Finger Guide For Steel Finger	AMH87044	\$ 1.50	
50A Series	Finger Guide Kit Includes (2) AMH87044 Guides (for H87069 Finger), (2) AMH87192 Hold Down Plates and (4) Self-Tapping Screws	AMX27389	\$ 8.75	
50A Series ASN 655100	Shaft, Right Hand For gather chain drive on row crop bean head	AMH149665	\$ 49.00	

John Deere®—Combine

John Deere®—Combine

Application	Description	Part Number	Retail Price	Core
50A Series ASN 655100	Shaft, Left Hand For gather chain drive on row crop bean head	AMH149666	\$ 49.00	
50A Series	Coupler Sprocket 14 Tooth	AMAN102382	\$ 85.00	
50A Series ASN 685101	Deck Plate Indicator Shaft	AMR111692	\$ 30.27	
653, (653A, 853A, 1253A BSN 525351), 853, 1253	Wear Tip For Steel Center Snout Replaces H135290	AMH84480	\$ 23.00	
(653A, 853A, 1253A ASN 655100)	Access Hole Cover	AMH203897	\$ 21.63	
50A Series	Bearing Flange, Cross Auger Shaft	AME10018	\$ 2.40	
50 & 50A Series	Roller Chain, Auger Drive 99 Links, Size 60 Chain	AMAH90208	\$ 35.00	
443 ASN 620251, 444 ASN 620305, 493, 494 BSN 660200, 543 ASN 576762, 546 ASN 620401, 592, 594, 643 ASN 620537, 644 ASN 620575, 645 ASN 620601, 693, 694, 843 ASN 620716, 844 ASN 620710, 893, 894, 1092 BSN 659999	Roller Chain, Row Unit Drive 89 Links, Size 60 Chain	AMAH124998	\$ 40.00	
453A, 454A, 653A, 654A, 655A, 853	Roller Chain, Knife Drive 74 Links, Size 60 Chain	AMAH112546	\$ 30.00	
453A, 454A, 653A, 654A, 655A, 853A, 854A	Roller Chain, Row Unit Drive 130 Links, Size 60 Chain	AMAH94439	\$ 40.00	
854A, 1253A	Roller Chain, Knife Drive 77 Links, Size 60 Chain	AMAH112714	\$ 40.00	



Sickle Drives and Components

Application	Description	Part Number	Retail Price	Core
Platforms: 600F, 600R Replaces DE19409	Wobble Box	AMDE19785	\$ 1795.00	
Platforms: 625D, 630D, 630FD, 635D, 635FD, 640D, 640FD, 645FD	Wobble Box	AMDE21086	\$ 2950.00	
Platforms: 890 Heavy Duty, (895, 896 - Right and Left Hand), 918, 920, 922, 925, 930	Wobble Box, HD	AMAH206402	\$ 1275.00	
Platforms: 925D, 930D, 936D	Wobble Box Assembly	AMDE19786	\$ 1725.00	
Auger Platform: 890 Standard, Platforms: 213, 215, 216, 218, 220, 222, 224, 230, 913F, 913R, 915F, 915R, 918F, 918R, 920F, 920R, 922F, 922R, 924F, 924R, 925F, 925R, 930F, 930R	Wobble Box Assembly 4-Bolt Mounting	AMAE41481	\$ 895.00	
Platforms: 213, 215, 216, 218, 220, 222, 224, 230, 314, 316, 319, 323, 325, 913F, 913R, 915F, 915R, 918F, 918R, 920F, 920R, 922F, 922R, 924F, 924R, 925F, 925R, 930F, 930R	Wobble Box Fork w/ Bushings	AMAE38050	\$ 230.00	
	Wobble Box Housing	AMAE46307	\$ 150.00	
	Wobble Box Yoke Shaft	AME60129	\$ 215.00	
	Wobble Box Shaft Nut	AME59303	\$ 16.50	
	Pin Fastener Use w/ AMAE46307 Wobble Box Housing (2) Required	AME56839	\$ 17.00	
Platforms: 213, 215, 216, 218, 220, 224, 230, 240, 913, 915, 915F, 918, 918F, 918R, 920, 920F, 920R, 922, 924, 925, 925D, 925F, 925R, 930, 930D, 930F, 930R, 936D	Wobble Box Housing	AMAE35151	\$ 219.00	

John Deere®—Combine

John Deere®—Combine

Application	Description	Part Number	Retail Price	Core
Platforms: 78, (213, 215, 216, 218, 220, 222, 224, 230 ASN 375527), 325, 913, 915, 915F, 918, 918F, 918R, 920, 920F, 920R, 922, 922F, 925, 925F, 925R, 930, 930F, 930R, Draper Platforms: 925D, 930D, 936D	Wobble Box Housing Cover	AMAE38566	\$ 78.00	
Platforms: 218, 220, 230, 240, 314, 316, 319, 323, 325, 890, 895, 896 w/ Heavy Duty Knife Drive, (900F, 900R 2000-02), 918, 920	Needle Bearing, Wobble Box Housing 0.875" ID, 1.188" OD, 1" Wide Outer Race	AMJD9977	\$ 9.23	
6602, 6622, Platforms: 213, 215, 216, 218, 220, 222, 224, 230, 314, 316, 319, 323, 325, (913F, 913R, 915F, 915R, 916F, 916R, 918F, 918R, 920F, 920R, 922F, 922R, 924F, 924R, 925F, 925R, 930F, 930R ASN 685401)	Wobble Box Repair Kit	AMAE57735	\$ 647.00	
Platforms: 913F, 913R, 915F, 915R, 918F, 918R, 920F, 920R, 922F, 922R, 924F, 924R, 925F, 925R, 930F, 930R	Wobble Box Repair Kit, HD	AMAE71003	\$ 823.25	
Platforms: (213, 215, 216, 218, 220, 222, 224, 230 BSN 530050)	Knife Drive Arm	AMH86911	\$ 89.00	
Platforms: (213, 215, 216, 218, 220, 222, 224, 230 ASN 530051), 218E, 220E, 224E, 314R, 316R, 319R, (913, 915, 918, 920, 922, 925, 930 BSN 638500), Draper Platforms: 78, 218 ASN 611151, 918, 920	Knife Drive Arm 12 Spline	AME52444	\$ 120.12	
Platforms: (915F, 918F, 920F, 922F, 924F, 925F, 930F ASN 638501)	Sickle Drive Arm	AMH136758	\$ 132.00	
Cutting Platforms: (913R, 915R, 918R, 922R, 924R, 925R, 930R ASN 638500), 916R, 920R	Sickle Drive Arm	AMH136757	\$ 179.46	
Platforms: 213, 215, 216, 218, 220, 222, 224, 230, 918, 920	Pillow Block	AMH98780	\$ 30.00	
Cutting Platforms: 913F, 913R, 915F, 915R, 916F, 916R, 918F, 918R, 920F, 920R, 922F, 922R, 924F, 924R, 925F, 925R, 930F, 930R Draper Platforms: 918, 920	Idler Pulley, Knife Drive 7 15/16" Diameter	AMAN15237	\$ 26.68	
Cutting Platforms: 913F, 913R, 915F, 915R, 918F, 918R, 920F, 920R, 922F, 922R, 924F, 924R, 925F, 925R, 930F, 930R	Wobble Box Tension Bracket Kit w/ 5/8" Rod For Rotary Wobble Box Can Replace Early Assemblies Replaces H82418, H161835, H161836	AMAH155154	\$ 100.00	
9670STS, 9770STS, S550, S650, S660, S670, S670HM, S680, S680HM, S690, S690HM, Sprayer: 4940, Platforms: 213, 215, 216, 218, 220, 222, 224, 622, 625, 630, 635, 640, 645, 722, 725, 730, 735, 740, 745	Pressure Relief Valve	AMAE38448	\$ 6.00	

Augers & Components—Bare Header / Platform



Application	Description	Part Number	Retail Price	Core
Platform: 625	Header Auger, Full Finger, 25'	AMAH223185	\$ 4850.00	
Platform: 630	Header Auger, Full Finger, 30'	AMAH223184	\$ 5300.00	
Platform: 925	Header Auger, Full Finger, 25'	AMAH202558	\$ 4600.00	
	Bearing	SA207-22	\$ 14.40	
Platform: 930	Header Auger, Full Finger, 30'	AMAH202562	\$ 4700.00	
Platforms: (615F, 615R, 618F, 618R, 620F, 620R, 622F, 622R, 625F, 625R, 630F, 630R, 635F, 635R ASN 716465 w/ 1 3/8" Hex Bore)	Auger Drive Pulley Replaces H221000	AMHXE22628	\$ 280.00	

John Deere®—Combine

John Deere®—Combine

Application	Description	Part Number	Retail Price	Core
Platforms: 615F, 615R, 618F, 618R, 620F, 620R, 622F, 622R, 625F, 625R, 630F, 630R, 635F, 635R	Idler Pulley	AMAH201252	\$ 120.00	
Platforms: 213, 215, 216, 218, 220, 222, 224, 230, 300, 913F, 913R, 915F, 915R, 918F, 918R, 920F, 920R, 922F, 922R, 924F, 924R, 925F, 925R, 930F, 930R	Auger Finger, Steel Replaces H102724, H150050, H102724, H87069	AMH162662	\$ 4.20	
Platforms: 213, 215, 216, 218, 220, 222, 224, 230, 913F, 913R, 915F, 915R, 918F, 918R, 920F, 920R, 922F, 922R, 924F, 924R, 925F, 925R, 930F, 930R	Auger Finger, Poly 10.25" Long Replaces H202806, H205318	AMX27285	\$ 9.25	
Platforms: 615F, 615R, 618F, 618R, 620F, 620R, 622F, 622R, 625F, 625R, 630F, 630R, 635F, 635R	Auger Finger, Poly Sold Individually	AMAH214869	\$ 3.75	
Platforms: 625D, 630D, 630FD, 635D, 635FD, 640D, 640FD, 645FD, 725D, 730D, 730FD, 735D, 735FD, 740D, 745FD	Auger Finger Kit For 16" Drum	AMAH228229	\$ 15.35	
Platforms: 200, 900, 900F, 900R	Finger Holder	AMAH171884	\$ 5.00	
Platforms: 213, 215, 216, 218, 220, 222, 224, 230, 913F, 913R, 915F, 915R, 918F, 918R, 920F, 920R, 922F, 922R, 924F, 924R, 925F, 925R, 930F, 930R	Finger Guide Kit Includes (2) AMH87044 Guides (for H87069 Finger), (2) AMH87192 Hold Down Plates and (4) Self-Tapping Screws	AMX27389	\$ 8.75	
	Finger Guide For Steel Finger	AMH87044	\$ 1.50	
Platforms: 913F, 913R, 915F, 915R, 918F, 918R, 920F, 920R, 922F, 922R, 924F, 924R, 925F, 925R, 930F, 930R	Finger Guide, Poly	AMH179000	\$ 3.00	
Platforms: 213, 215, 216, 218, 220, 222, 913F, 913R, 915F, 915R, 918F, 918R, 922F, 922R, 925F, 925R, 930F, 930R, Draper Platforms: 918, 920	Finger Guide Screw For Rigid or Flex Platforms	AMH86918	\$ 0.65	
Platforms: 213, 215, 216, 218, 220, 222, 224, 230, 913F, 913R, 915F, 915R, 918F, 918R, 920F, 920R, 922F, 922R, 924F, 924R, 925F, 925R, 930F, 930R	Finger Guide Plate, Steel	AMH87192	\$ 1.45	
Platforms: 213, 215, 216, 218, 220, 222, 224, 230, 615F, 615R, 618F, 618R, 620F, 620R, 622F, 622R, 625F, 625R, 630F, 630R, 635F, 635R, 913F, 913R, 915F, 915R, 918F, 918R, 920F, 920R, 922F, 922R, 924F, 924R, 925F, 925R, 930F, 930R	Finger Guide Cap For Plastic and Fiberglass Fingers	AMH202409	\$ 4.65	
Draper Platforms: 625D, 630D, 630FD, 635D, 635FD, 640D, 640FD, 645FD, 725D, 730D, 730FD, 735D, 735FD, 740D, 740FD, 745FD	Finger Guide Ball 1" Diameter, 0.65" Bore Diameter	AMH217266	\$ 0.91	
Platforms: 614, 616, 618, 620, 622, 625, 630, 635, (913, 915, 918, 920, 922, 925, 930 ASN 705218)	Bearing Retainer	AMAH171602 AMH172459	\$ 5.00 \$ 1.95	
Auger Platforms: 220, 230, 240, Platforms: (213, 215, 216, 218, 220, 222, 224, 230 ASN 317200), (913, 915, 918, 920, 922, 924, 925, 930 BSN 635101), Draper Platform: 218	Bearing, Cross Auger Driveshaft 2.8346" OD, 1.25" Round Bore Replaces AH10515, JD9316	AMG1104KRRB-I	\$ 25.58	
Cutting Platforms: 615F, 615R, 618R, 618F, 618R, 620F, 620R, 622F, 622R, 625F, 625R, 625D, 630F, 630D, 630R, 630FD, 635D, 635F, 635FD, 635R, 640D, 640FD, 645FD, 725D, 730D, 730FD, 735D, 735FD, 740D, 740FD, 745FD, 918F, 918R, 920F, 920R, 922F, 922R, 925F, 925R, 930F, 930R	Access Hole Cover	AMH203897	\$ 21.63	

John Deere®—Combine

Application	Description	Part Number	Retail Price	Core
Cutting Platforms: 200, 213, 215, 216, 218, 220, 222, 224, 230 BSN 317201	Bearing w/ Lock Collar, Cross Auger Driveshaft	AMJD9274	\$ 24.07	
Cutting Platforms: 200, 213, 215, 216, 218, 220, 222, 224, 230 BSN 317201	Bearing w/ Lock Collar, Cutterbar Driveshaft	AMJD9274	\$ 24.07	
Platforms: (213, 215, 216, 218, 220, 222, 224, 230 ASN 317200), (913, 915, 918, 920, 922, 924, 925, 930 BSN 635101), Draper Platforms: 218, 918 BSN 635101	Bearing, Cutterbar Driveshaft 2.8346" OD, 1.25" Round Bore Replaces AH10515, JD9316	AMG1104KRRB-I	\$ 25.58	
Platform: (213, 215, 216, 218, 220, 222, 224, 230, 300 ASN 620300), (913F, 913R, 915F, 915R, 918F, 918R, 920F, 920R, 922F, 922R, 924F, 924R, 925F, 925R, 930F, 930R BSN 635101), Draper Platforms: 218, (918, 920 BSN 635101)	Bearing Flange, Cross Auger Shaft	AME10018	\$ 2.40	

Reel Conversion Kits

This kit will convert your old wooden board / metal finger pick-up reel to the new metal pipe / plastic (hi-visibility) reel. Kit includes reel bars, plastic tines and hardware. Bearings and outside tines are not included.



Application	Description	Part Number	Retail Price	Core
Platforms: 925	Reel Conversion Kit, 25' Header	AMRKJD-25	\$ 2350.00	

Reel Drive Components

Application	Description	Part Number	Retail Price	Core
Cutting Platforms: 625D, 630D, 630FD, 635D, 635FD, 640D, 640FD, 640X, 725D, 730D, 730FD, 735D, 735FD, 740D	Reel Drive Gear 85 Tooth	AMH228674	\$ 475.00	
9450 ASN 690243, 9550 ASN 695200, 9550SH ASN 695700, 9560, 9560SH, 9560STS, 9570STS, 9650 ASN 690876, 9650CTS ASN 690504, 9650STS ASN 695500, 9660, 9660CTS, 9660STS, 9670STS, 9750STS ASN 695600, 9760STS, 9770STS, 9860STS - w/ Standard Capacity	Reel Pump Drive Sheave 9.925" OD	AMH179093	\$ 355.71	
9550 ASN 695200, 9550SH ASN 695700, 9560, 9560SH, 9560STS, 9570STS, 9650 ASN 690876, 9650CTS ASN 690504, (9650STS, 9750STS ASN 695500), 9660, 9660CTS, 9660STS, 9670STS, 9760STS, 9770STS, 9860STS, 9870STS, (S550, S650, S660, S670, S670HM, S680, S680HM, S690, S690HM, S760, S770, S780, S785, S790 - w/ Heavy Duty Front End Drive) - All w/ High Capacity	Reel Pump Drive Sheave 9.21" OD	AMH179058	\$ 292.29	
9550, 9550SH, 9650 BSN 695300, 9650CTS BSN 695400, 9650STS, 9750STS - w/ High Capacity	Reel Pump Drive Sheave 9.21" OD	AMH157101	\$ 332.45	
9400, 9410, 9450 BSN 690243, 9500, 9500SH, 9510, 9510SH, 9550, 9550SH, 9600, 9610, 9650 BSN 690876, 9650CTS BSN 690504, 9650STS BSN 695500, 9750STS BSN 695600 - w/ Standard Capacity	Reel Pump Drive Pulley 5.059" Long, 9.803" Diameter, 1.259" Groove Width, 0.75" Bore	AMH132937	\$ 115.00	
9400, 9410, 9450, 9500, 9500SH, 9510, 9510SH, 9550, 9550SH, 9560, 9560SH, 9560STS, 9570STS, 9600, 9610, 9650, 9650CTS, 9650STS ASN 695500, 9660, 9660CTS, 9660STS, 9670STS, 9750STS ASN 695600, 9760STS, 9770STS, 9860STS, 9870STS, CTS, CTS II, S550, S650, S660, S670, S670HM, S680, S680HM, S690, S690HM, S760, S770, S780, S790	Bearing, Reel Pump Drive Sheave 0.787" Wide, 3.543" OD, 1.969" Bore Diameter Replaces JD10312	AMAH201531	\$ 35.85	

John Deere®—Combine

Reel Components

Application	Description	Part Number	Retail Price	Core
9660STS, 9670STS, 9760STS, 9770STS, 9860STS, 9870STS, 9880STS, S660, S670, S680, S690, S760, S770, S780, S785, S790	Tine Wear Plate, Feed Accelerator Package of 10 For Fast Tine Feed Accelerator	AMAH216018	\$ 217.58	
Platforms: (913, 915, 918, 920, 922, 924, 925, 930 BSN 645300), Draper Platforms: 918, 920 Replaces H127035	Reel Tine For Platforms w/ Tear Drop Bats and Tines Mounted to Rear of the Steel Bat	AM1970586C1	\$ 1.58	
Platforms: (913, 915, 918, 920, 922, 924, 925, 930 ASN 625300) Replaces AH136689, AH153175	Reel Tine Nylon, 3-Piece Double Wing Unit 4.50" Spacing Includes Hardware Sold in Multiples of 25, Priced Individually Replaces center tine, some modification required for right and left hand sides	AMTINE	\$ 2.00	
Platforms: 615F, 615R, 618F, 618R, 620F, 620R, 622F, 622R, 625F, 625R, 630F, 630R, 635F, 635R, (913F, 913R, 915F, 915R, 916F, 916R, 918F, 918R, 920F, 920R, 922F, 922R, 924F, 924R, 925F, 925R, 930F, 930R ASN 685401), Draper Platforms: 625D, 630D, (630FD, 635FD, 640FD BSN 785000), 635D, 640D, 725D, 730D, 735D, 925D, 930D, 936D Replaces AH166489, AH166493	Reel Tine Nylon, Double Wing Unit, 6" Spacing Includes Hardware Sold in Multiples of 25, Priced Individually	AMX27222	\$ 2.25	
Platforms: 615F, 615R, 618F, 618R, 620F, 620R, 622F, 622R, 625F, 625R, 630F, 630R, 635F, 635R, (913F, 913R, 915F, 915R, 916F, 916R, 918F, 918R, 920F, 920R, 922F, 922R, 924F, 924R, 925F, 925R, 930F, 930R ASN 685401), Draper Platforms: 625D, 630D, 630FD, 635D, 635FD, 640D, 640FD, 725D, 730D, 735D, 925D, 930D, 936D Replaces AH166491	Reel Tine, Right Hand Wing 6" Spacing, Includes Hardware	AMX29057	\$ 3.76	
Platforms: 615F, 615R, 618F, 618R, 620F, 620R, 622F, 622R, 625F, 625R, 630F, 630R, 635F, 635R, (913F, 913R, 915F, 915R, 916F, 916R, 918F, 918R, 920F, 920R, 922F, 922R, 924F, 924R, 925F, 925R, 930F, 930R ASN 685401), Draper Platforms: 625D, 630D, (630FD, 635FD, 640FD BSN 785000), 635D, 640D, 725D, 730D, 735D, 925D, 930D, 936D Replaces AH166490	Reel Tine, Left Hand Wing Nylon, 6" Spacing Includes Hardware	AMX29056	\$ 3.76	
Platforms: (622X, 625X, 630X, 635X, 640X ASN 053000), 625D, 630D, 630FD, 635D, 635FD, 640D, 640FD, 645FD, 725D, 730D, 730FD, 735D, 735FD, 740D, 740FD, 745FD	Reel Tine Sold in Multiples of 10, Priced Individually Replaces HXE81790, HXE96538, KXE10316	AMKXE10423	\$ 4.15	
Platforms: 600R, 600F, 925D, 930D, 936D	Reel Finger, Wide Use w/ 4" and 6" Reel Tines	AMH207933	\$ 4.56	
Platforms: 615F, 615R, 618F, 618R, 620F, 620R, 622F, 622R, 625F, 625R, 630F, 630R, 635F, 635R, 913F, 913R, 915F, 915R, 918F, 918R, 920F, 920R, 922F, 922R, 924F, 924R, 925F, 925R, 930F, 930R	Quick Fingers, 10 Pack	AMX27550	\$ 22.00	
Platforms: 314, 316, 319, 323, 325, 600F, 600R, 615F, 615R, 618F, 618R, 620F, 620R, 622F, 622R, 622X, 625D, 625F, 625R, 625X, 630D, 630F, 630FD, 630R, 630X, 635D, 635F, 635FD, 635R, 635X, 640D, 640FD, 640X, 645FD, 725D, 730D, 730FD, 735D, 735FD, 740D, 740FD, 745FD, (913, 915, 918, 920, 922, 924, 925, 930 ASN 625301), (913F, 913R, 915F, 915R, 916, 916F, 916R, 918F, 918R, 920F, 920R, 922F, 922R, 924F, 924R, 925F, 925R, 930F, 930R ASN 685401), 925D, 930D, 936D	Roller Bearing, Reel Cam Follower 1.738" Overall Length, 0.875" Wide, 1.50" OD, 0.739" Thread Length, 0.394" (10 mm) Thread Size	AMAH169497	\$ 32.32	

John Deere®—Combine

John Deere®—Combine

Application	Description	Part Number	Retail Price	Core
Platforms: 615F, 615R, 618F, 618R, 620F, 620R, 622F, 622R, 625F, 625R, 630F, 630R, 635F, 635R, (913F, 913R, 915F, 915R, 918F, 918R, 920F, 920R, 922F, 922R, 924F, 924R, 925F, 925R, 930F, 930R ASN 645300) Replaces AXE28803, H175727	Reel Bearing	AMH136954	\$ 3.20	
Platforms: 615F, 615R, 618F, 618R, 620F, 620R, 622F, 622R, 625F, 625R, 630F, 630R, 635F, 635R, 913F, 913R, 915F, 915R, 918F, 918R, 920F, 920R, 922F, 922R, 924F, 924R, 925F, 925R, 930F, 930R Replaces H136956	Bearing Clamp Set of 2	AMH175603	\$ 1.50	
Platforms: 316, 319, 325, 614, 616, 618, 620, 622, 625, 630, 635, (913, 915, 918, 920, 922, 925, 930 ASN 705218)	Strap	AMH175436	\$ 5.50	
Platforms: 625D, 630D, 630FD, 635D, 635FD, 640D, 640FD, 645FD, 725D, 730D, 730FD, 735D, 735FD, 740D, 745FD	Reel Drive Gear 21 Tooth Replaces H228673	AMHXE102049	\$ 275.00	
Platforms: 213, 215, 216, 218, 220, 222, 224, 230, 913F, 913R, 915F, 915R, 918F, 918R, 920F, 920R, 922F, 922R, 924F, 924R, 925F, 925R, 930F, 930R, Draper Platforms: 635FD, 640FD, 645FD, 730FD, 735FD, 740FD, 745FD	Reel Repair Kit, Hex Hole Style For Reel pipes w/ hex holes on the bottom of the pipes and 6" reel finger spacing	AMBN-KITHXH	\$ 35.00	
Platforms: 913F, 913R, 915F, 915R, 918F, 918R, 920F, 920R, 922F, 922R, 924F, 924R, 925F, 925R, 930F, 930R	Reel Repair Kit, Roll Pin Style For reel pipes w/ 4 1/2" reel finger spacing and roll pins or plastic washers on each side of the plastic bearing	AMBN-KITRP	\$ 29.50	

Platform Components

Application	Description	Part Number	Retail Price	Core
Platforms: 218F, 218R, (918F, 918R SN 625301-635101)	Drive Shaft, Right Hand 61.31" Long	AMH87351	\$ 228.92	
Platforms: 220F, 220R, (920F, 920R SN 625301-635101)	Drive Shaft 73.43" Long	AMH87352	\$ 306.84	
Platforms: 222F, 222R, (922F, 922R SN 625301-635101)	Drive Shaft 85.31" Long	AMH87363	\$ 334.36	
Platforms: 224F, 224R, (924F, 924R SN 625301-635101)	Drive Shaft 97.31" Long	AMH87353	\$ 383.53	
Platforms: (213, 215, 216, 218, 220, 222, 224, 230 ASN 317200), 913F, 913R, 915F, 915R, 918F, 918R, 920F, 920R, 922F, 922R, 924F, 924R, 925F, 925R, 930F, 930R	Drive Sprocket 14 Tooth, 3.483" OD, 1.13" Hex Hub Diameter For Row Unit	AMAH91784	\$ 71.56	
Platforms: 913, 915, 918, 920, 922, 925, 930	Drive Sprocket 14 Tooth, 1.791" Long, 1.379" Hex Bore For Size 60 Chain	AMAH148573	\$ 135.77	
3300, 4400, 4420, 6600, 6620, 7700, 7720, 8820, 9400, 9410, 9500, 9510, 9600, 9610, CTS, CTS II	Coupler Sprocket 14 Tooth	AMAN102382	\$ 85.00	
Platforms: 615F, 615R, 618F, 618R, 620F, 620R, 622F, 622R, 625F, 625R, 630F, 630R, 635F, 635R	Platform Sprocket	AMAH220303	\$ 78.00	
Platforms: 913F, 913R, 915F, 915R, 916F, 916R, 918F, 918R, 920F, 920R, 922F, 922R, 924F, 924R, 925F, 925R, 930F, 930R, Draper Platforms: 918, 920	Platform Sprocket	AMAH138180	\$ 50.00	
Platforms: (900F, 900R ASN 685056)	Deck Plate Indicator Shaft	AMR111692	\$ 30.27	
Platforms: 314, 316, 319, 323, 325, (913F, 913R, 915F, 915R, 916F, 916R, 918F, 918R, 920F, 920R, 922F, 922R, 924F, 924R, 925F, 925R, 930F, 930R SN 625301-685400), Draper Platforms: 918, 920, 925D, 930D, 936D	Slip Clutch Jaw	AMH101677	\$ 29.50	

Prices Subject to Change without Prior Notice. The use of original equipment manufacturer (OEM) part numbers or trademarks, e.g. Case® and John Deere®, are for reference purposes only and for indicating product use and compatibility. Our company and the listed replacement parts contained herein are not sponsored, approved or manufactured by the OEM. All parts are New unless designated Reman in the description.

John Deere®—Combine

Application	Description	Part Number	Retail Price	Core
Draper Platforms: 925D, 930D, 936D	Slip Clutch Hub, Feed Auger 3.618" OD, 2.835" Long, 1.154" Bore Diameter, 0.661" Offset	AMH101678	\$ 130.99	
Row Crop Heads: 453A, 454A, 653A, 654A, 655A, 853A, 854A, 1253A	Slip Clutch Hub, Auger Drive 3.618" OD, 2.835" Long, 1.154" Bore Diameter, 0.661" Offset	AMH101678	\$ 130.99	
Platforms: 213, 215, 216, 218, 220, 222, 224, 230, 316, 319, 325, 600F, 600R, 630FD, 635FD, 640FD, 645FD, 913, 915, 918, 920, 922, 925F, 930, 930F	Bushing 0.6325" Bore	AMAH154697	\$ 4.78	
Draper Platforms: 625D, 630D, 630FD, 635D, 635FD, 640D, 640FD, 645FD, 725D, 730D, 730FD, 735D, 735FD, 740D, 745FD	Finger Guide Top Retainer For Center Feed Drum	AMH217264	\$ 0.97	
	Finger Guide Bottom Retainer For Center Feed Drum	AMH217265	\$ 0.97	
Platforms: 213, 215, 216, 218, 220, 222, 224, 230, 314, 316, 319, 323, 325, 913F, 913R, 915F, 915R, 918F, 918R, 920F, 920R, 922F, 922R, 924F, 924R, 925F, 925R, 930F, 930R, Draper Platforms: 120, (130, 135 ASN 765000), 218, 918 BSN 635901, 920 ASN 646300	Knife Driven Pulley 11" OD For Standard Duty Knife Drive Case Replaces E48349	AME78705	\$ 204.85	
Platforms: 314, 316, 319, 323, 325, 625D BSN 785000, (913, 915, 918, 920, 922, 924, 925, 930 SN 625301- 685400)	Eccentric Shield, Platform Reel Replaces H136957	AMH175610	\$ 33.00	
Cutting Platforms: 615F, 615R, 618F, 618R, 620F, 620R, 622F, 622R, 625F, 625R, 630F, 630R, 635F, 635R	Idler Pulley, Cutterbar Drive 1.437" Overall Width, 7.992" Diameter, 0.637" Bore Diameter, 1" Groove Width Replaces AH85276, AH165366	AMAH97031	\$ 33.07	
3300, 4400, 4420, 4425, 4435, 6600, 6620, 7700, 7701, 7720, 7721, 8820, 9400, 9410, 9500, 9500SH, 9510SH, 9600, 9610, CTS, CTS II	Chain Coupler	AMAN102383	\$ 21.65	
Platforms: 630FD, 635FD, 640FD, 645FD	Ramp, Right Hand	AMHXE17296	\$ 6.38	
	Ramp, Left Hand	AMHXE20152	\$ 6.38	
Platforms: (615F, 615R, 618F, 618R, 620F, 620R, 622F, 622R, 625F, 625R, 630F, 630R, 635F, 635R - w/ Standard Shoe or ASN 720100 w/ Raised Shoe)	Float Arm Stabilizer	AMAH221194	\$ 625.00	
Platforms: 615F, 615R, 618F, 618R, 620F, 620R, 622F, 622R, 625F, 625R, 630F, 630R	Ball Joint, Float Arm Stabilizer	AMAH210858	\$ 117.00	
Platforms: 615, 618, 620, 622, 625, 630	Roller Chain, Auger Drive 104 Links, Size 60H Chain	AMAH162957	\$ 55.00	
Cutting Platforms: 615F, 615R, 618F, 618R, 620F, 620R, 622F, 622R, 625F, 625R, 630F, 630R, 635F, 635R	Roller Chain, Auger Drive 78 Links, Size 80H Chain	AMAH220304	\$ 75.00	
Cutting Platforms: (913F, 913R, 915F, 915R, 916F, 916R, 918F, 918R, 920F, 920R, 922F, 922R, 924F, 924R, 925F, 925R, 930F, 930R ASN 685401)	Roller Chain, Auger Drive 87 Links, Size 60H Chain	AMAH141274	\$ 35.00	

Platform Floor Sheets

Application	Description	Part Number	Retail Price	Core
Flex Cutting Platforms: 913, 915, 918, 922	Bottom Floor Sheet, Stainless Steel Right Hand 75 5/16" Long Replaces AH118969, AH137719	AMAH151632	\$ 208.00	
	Bottom Floor Sheet, Stainless Steel Left Hand 75 5/16" Long Replaces AH118970, AH137720	AMAH151633	\$ 208.00	
Flex Cutting Platforms: 915, 918, 920, 922, 925, 930	Bottom Floor Sheet, Stainless Steel Center 31 7/16" Long Replaces AH118964, AH137714	AMAH151627	\$ 110.00	

John Deere®—Combine

Application	Description	Part Number	Retail Price	Core
Flex Cutting Platform: 920	Bottom Floor Sheet, Stainless Steel 66 7/16" Long Replaces AH118967, AH137717	Right Hand AMAH151630	\$ 170.00	
	Bottom Floor Sheet, Stainless Steel 66 7/16" Long Replaces AH118968, AH137718	Left Hand AMAH151631	\$ 170.00	
Flex Cutting Platforms: 920, 924, 925	Bottom Floor Sheet, Stainless Steel 43 7/16" Long Replaces AH118966, AH137716	Center AMAH151629	\$ 123.00	
Flex Cutting Platforms: 922, 930	Bottom Floor Sheet, Stainless Steel 40 7/16" Long Replaces AH118965, AH137715	Center AMAH151628	\$ 123.00	
Flex Cutting Platforms: 924, 925, 930	Bottom Floor Sheet, Stainless Steel 78 7/16" Long Replaces AH118971, AH137721	Right Hand AMAH151634	\$ 206.00	
	Bottom Floor Sheet, Stainless Steel 78 7/16" Long Replaces AH118972, AH137722	Left Hand AMAH151635	\$ 206.00	
Draper Platforms: (630FD, 635FD, 640FD ASN 785000), 645FD, 730FD, 735FD, 740FD, 745FD	Center Feed Section Floor	AMHXE41585	\$ 340.00	

Row Crop Dividers

Eliminate costly grain loss from knocked down plants. Change from short to long dividers in minutes. Safer transportation and easy storage. Sectional design allows you to replace only the damaged piece which saves you money.



Application	Description	Part Number	Retail Price	Core
Platforms: 213, 215, 216, 218, 220, 222, 224, 230, 913F, 913R, 915F, 915R, 918F, 918R, 920F, 920R, 922F, 922R, 924F, 924R, 925F, 925R, 930F, 930R	Complete Set of Dividers, Long	AMSCD400JD	\$ 1350.00	
	Components:			
	Rear Divider, Right Hand	1 AMSCD100JD-RH	\$ 550.00	
	Rear Divider, Left Hand	1 AMSCD100JD-LH	\$ 550.00	
	Divider Front Wing Section, Long	2 AMSCD200	\$ 550.00	
	Divider Nose Bar	2 AMSCD300	\$ 50.00	
Flex Platforms: 200, 900 Series	Complete Set of Dividers, Short	AMSCD500JD	\$ 1175.00	
	Components:			
	Rear Divider, Right Hand	1 AMSCD100JD-RH	\$ 550.00	
	Rear Divider, Left Hand	1 AMSCD100JD-LH	\$ 550.00	
	Short Divider Tip	2 AMSCD250	\$ 75.00	
	Divider Nose Bar	2 AMSCD300	\$ 50.00	
Cutting Platforms: 615F, 615R, 618F, 618R, 620F, 620R, 622F, 622R, 625F, 625R, 630F, 630R, 635F, 635R, Draper Platforms: 625D, 630D, 635D, 640D, 725D, 730D, 735D, 740D, 925D, 930D, 936D	Short Divider Tip	AMSCD250	\$ 75.00	
Cutting Platforms: 615F, 615R, 618F, 618R, 620F, 620R, 622F, 622R, 625F, 625R, 630F, 630R, 635F, 635R, Draper Platforms: 625D, 630D, 635D, 640D, 725D, 730D, 735D, 740D, 925D, 930D, 936D	Crop Lifter Assembly	AMAH159210	\$ 26.80	
Platforms: 600F, 600R, 615F, 615R, 618F, 618R, 620F, 620R, 622F, 622R, 625F, 625R, 630F, 630FD, 630R, 635F, 635FD, 635R, 640FD	Wear Tip For Row Crop Divider Point	AMH174618	\$ 17.00	

John Deere®—Combine



Header Lift Cylinders

Application	Description	Part Number	Retail Price	Core
9410, 9510, 9600, 9610, 9650, 9650CTS, CTS II	Header Lift Cylinder	AMAH155265	\$ 660.00	
9560STS, 9660STS, 9760STS, 9860STS	Header Lift Cylinder 70 mm Replaces AH166921	AMAH234608	\$ 730.00	
9570STS, 9660STS, 9670STS, 9760STS, 9770STS, 9860STS, 9870STS, S550 SN 745100-764999, S650 ASN 765000, (S660, S670 ASN 745100), (S670HM, S680HM BSN 765000), S690HM SN 745101-765000, S760, S780, S785, S790	Hydraulic Cylinder Seal Kit For Header Lift Cylinder	AMAH167021	\$ 52.25	
9400, 9410, 9500, 9510, 9600, 9610, 9650, 9650CTS, CTS, CTS II	Hydraulic Cylinder Seal Kit For Header Lift Cylinder Replaces AH155265	AMAH162432	\$ 33.00	
Draper Platforms: 625D, 630D, 635D, 640D, 725D, 730D, 735D, 740D	Hydraulic Cylinder Seal Kit For Header Tilt Cylinder	AMAH161589	\$ 32.64	
Draper Platforms: 640D, 740D	Hydraulic Cylinder Seal Kit For Float Cylinder Replaces AH231937	AMAH164325	\$ 18.29	
Sprayer: 4730	Hydraulic Cylinder Seal Kit For Boom Cylinder	AMAH161589	\$ 32.64	



Draper Belts and Components

Application	Description	Part Number	Retail Price	Core
Platforms: 110, 132, 212, 214, 912, 914	Draper Belt 22.00" x 67.00", Pickup Belt, 60 Tooth	AMAH147909	\$ 219.00	
Platforms: 110, 132, 212, 214, 912, 914 Replaces AH92200	Draper Belt 22.00" x 66.53", Pickup Belt w/o Teeth	AMAH147908	\$ 111.00	
Platform: 625D Replaces AH228214, AXE111465, AXE15007	Draper Side Belt 25' Right and Left Hand, 39.54" x 237.13"	AMAXE12531	\$ 539.00	
Platforms: 625D, 630D, 635D, 640D Replaces AXE12117	Draper Center Feeder Belt 25', 30', 35' or 40', 55.30" x 58.01"	AMAXE12533	\$ 428.00	
Platforms: 625D, 630D, 635D, 640D	Draper Belt Repair Kit For 39.54" Belt Includes 34" Repair Section of RAPTOR Material, Pre-Punched for Connector, (2) Steel Tube Connectors and Hardware	AM1014723	\$ 159.00	
Platform: 630D Replaces AH229394, AXE11896, AXE15008	Draper Side Belt 30' Right and Left Hand, 39.54" x 297.13"	AMAXE14731	\$ 621.00	
Platform: 630FD	Endless Draper Belt 30' Right and Left Hand, 39.93" x 430.80"	AMAXE36429	\$ 1668.00	
Platform: 630FD ASN 785000	Endless Draper Belt 30' Right and Left Hand, 39.93" x 295.00" (2) Required	AMAXE31445	\$ 1835.00	
Platforms: 630FD, 635FD ASN 740831, 640FD ASN 740835 - w/ Center Delivery	Draper Center Feeder Belt 30', 35' or 45', 58.10" x 51.85" Double V-Guide	AMAXE17364	\$ 539.00	

John Deere®—Combine

John Deere®—Combine

Application	Description	Part Number	Retail Price	Core
Platforms: 630FD, 635FD, 640FD, 645FD ASN 785000	Draper Center Feeder Belt 30', 35', 40' or 45', 69.80" x 51.85" Double V-Guide (1) Required	AMHXE49231	\$ 595.00	
	Draper Center Feeder Belt 30', 35', 40' or 45', 69.80" x 51.85" Crescent Pattern Option Replaces HXE124019	AMAXE71261	\$ 674.00	
Platform: 635D Replaces AH225872, AXE11897, AXE14603	Draper Side Belt 35' Right and Left Hand, 39.54" x 357.13"	AMAXE12532	\$ 790.00	
Platform: (635FD, 640FD BSN 740835) - w/ Center Delivery	Draper Center Feeder Belt 40', 58.10" x 51.85" Single V-Guide	AMAXE12572	\$ 403.00	
Platforms: (635FD*, 640FD Short** BSN 784999) *4 Required **2 Required (Outside Belts) Replaces AXE22775	Endless Draper Belt 35' or 40' Right and Left Hand, 39.96" x 185.40"	AMAXE35348	\$ 1212.00	
Platforms: (635FD*, 640FD** ASN 785000) *4 Required **2 Required (Outside Belts)	Endless Draper Belt 35' or 40', Right and Left Hand, 39.93" x 180.00"	AMAXE36550	\$ 1247.00	
Platform: 640D Replaces AXE15009	Draper Side Belt 40' Right and Left Hand, 39.54" x 417.13"	AMAXE16051	\$ 895.00	
Platform: 640FD Long BSN 784999 Replaces AXE22776	Endless Draper Belt 40' Right and Left Hand, 39.93" x 245.40" (2) Required (Inside Belts)	AMAXE35349	\$ 1339.00	
Platforms: 640FD** ASN 785000, 645FD* *4 Required **2 Required (Inside Belts)	Endless Draper Belt 40' or 45', Right and Left Hand, 39.93" x 239.75"	AMAXE36551	\$ 1465.00	
Platforms: 730FD, RD30F	Endless Draper Belt 30' Right and Left Hand, 39.93" x 296.86"	AMAXE36557	\$ 1608.00	
Platforms: 735FD*, 740FD** *4 Required **2 Required (Outside Belts)	Endless Draper Belt 30' or 40' Right and Left Hand, 39.93" x 180.00"	AMAXE36558	\$ 1266.00	
Platform: 740FD	Endless Draper Belt 40' Right and Left Hand (2) Required (Inside Belts)	AMAXE36559	\$ 1598.00	
Platform: 925D Replaces AXE39582	Draper Side Belt 25' Right and Left Hand, 36.00" x 244.00"	AMAH159533	\$ 502.00	
Platforms: 925D, 930D, 936D Replaces AH159538, AH173119, AXE12053	Center Feeder Belt 25', 30' or 36', 60.00" x 63.56"	AMAH203047	\$ 389.00	
Platform: 930D	Draper Side Belt 30' Right and Left Hand, 36.00" x 304.00" Replaces AXE39583	AMAH159534	\$ 611.00	
Platform: 930D w/ Windrow Option	Draper Side Belt 30' Fixed, 36.00" x 86.00" Replaces AXE39586	AMAH159557	\$ 187.00	
Platforms: 930D, 936D - w/ Windrow Option	Draper Side Belt 30' or 36' Movable, 36.00" x 218.00" Replaces AXE39587	AMAH159558	\$ 502.00	
Platform: 936D	Draper Belt, HD 36' Right Hand, 36.00" x 420.00" Replaces AXE39585	AMAH159536	\$ 859.00	
	Draper Belt, HD 36' Left Hand, 36.00" x 332.00" Replaces AXE39584	AMAH159535	\$ 702.00	
Platform: 936D Short w/ Windrow Option	Draper Side Belt 36' Right Hand, 36.00" x 202.00" Replaces AXE39588	AMAH159537	\$ 487.00	

Prices Subject to Change without Prior Notice. The use of original equipment manufacturer (OEM) part numbers or trademarks, e.g. Case® and John Deere®, are for reference purposes only and for indicating product use and compatibility. Our company and the listed replacement parts contained herein are not sponsored, approved or manufactured by the OEM. All parts are New unless designated Reman in the description.

John Deere®—Combine

John Deere®—Combine

Application	Description	Part Number	Retail Price	Core
Platforms: 925D, 930D, 936D	Draper Belt Repair Kit For 36" Belt Includes 34" Repair Section of RAPTOR Material, Pre-Punched for Connector, (2) Steel Tube Connectors and Hardware	AM1014722	\$ 158.00	
Platforms: Most Models	Steel Tube Connector 7 Holes, 35" Long	AM1003863	\$ 30.25	
Platforms: 630FD, 635FD, 640FD, 645FD	Rubber Deflector For Center Feed Section	AMHXE119425	\$ 38.89	
Platforms: 625D, 630D, 635D, 640D, 725D, 730D, 735D, 740D	Knife Drive Belt 3-Banded Belt 53.02" Long	AMAH232955	\$ 89.00	
Draper Platform: 78	Draper Belt 9' Right or Left Hand, 40.00" x 73.00" Single V-Guide	AMAE25972	\$ 215.00	
	Draper Belt 11' Right or Left Hand, 40.00" x 97.00" Single V-Guide	AMAE23714	\$ 262.00	
	Draper Belt 11' Right or Left Hand, 42.00" x 94.00" Single V-Guide	AMAE24257	\$ 260.00	
	Draper Belt 36' Right Hand or Left Hand, 42.00" x 377.00" Single V-Guide	AMAE33360	\$ 852.00	
Draper Platform: 78 - w/ Narrow Platform	Draper Belt 10' Right or Left Hand, 40.00" x 86.00" Single V-Guide	AMAE20966	\$ 197.00	
Draper Platforms: 78, 88, 118	Draper Belt 12' Right or Left Hand, 42.00" x 110.00" Single V-Guide	AMAH18491H	\$ 267.00	
Draper Platforms: (78, 88, 118 - w/ Narrow Platform), 120	Draper Belt 14' Right or Left Hand, 42.00" x 134.00" Single V-Guide	AMAE20968	\$ 315.00	
Draper Platforms: 78, 88, 118, 120, 130, 135	Draper Belt 12' Right or Left Hand, 42.00" x 110.00" Single V-Guide	AMAE20967	\$ 269.00	
Draper Platforms: 78, 130 - w/ Narrow Platform	Draper Belt 15' Right or Left Hand, 40.00" x 138.00" Single V-Guide	AMAE34797	\$ 319.00	
Draper Platforms: 78, 130	Draper Belt 25' Right or Left Hand, 42.00" x 258.00" Single V-Guide	AMAE36834	\$ 583.00	
Draper Platform: 88	Draper Belt 14' Right or Left Hand, 42.00" x 134.00" Single V-Guide	AMAH18492H	\$ 322.00	
Draper Platforms: 88, 118	Draper Belt 10' Right or Left Hand, 42.00" x 86.00" Single V-Guide	AMAH18490H	\$ 245.00	
Draper Platform: 88	Draper Belt 16' Right or Left Hand, 42.00" x 158.00" Single V-Guide	AMAH18493H	\$ 376.00	
Draper Platforms: 118 w/ Narrow Platform	Draper Belt 16' Right or Left Hand, 42.00" x 157.00" Single V-Guide	AMAE20969	\$ 365.00	
Draper Platform: 130 Twin Swath	Draper Belt 21' Right or Left Hand, 42.00" x 186.00" Single V-Guide	AMAE38140	\$ 428.00	

John Deere®—Combine

Application	Description	Part Number	Retail Price	Core
Draper Platform: 130 (Twin Swath, Right Hand Short)	Draper Belt 40.00" x 47.00" Single V-Guide Replaces AE38276	AMAE24847	\$ 139.00	
Draper Platforms: 130, 135 - w/ Narrow Platform	Draper Belt Extension 12' or 15', 40.00" x 16.00" Narrow Extension Single V-Guide	AMAE32333	\$ 67.00	
	Draper Belt Extension 41.50" x 15.00", Regular Platform Extension Single V-Guide Replaces 1069543M91	AMAE36767	\$ 54.00	
Draper Platform: 420D	Draper Belt 20' Right or Left Hand, 41.60" x 157.24" Single V-Guide	AMAFH209068	\$ 406.00	

Header End Shields

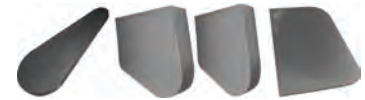

Application	Description	Part Number	Retail Price	Core
Platforms: 213, 215, 216, 218, 220, 222, 224, 230, (912, 913, 914, 915, 918, 920, 922, 924, 925, 930, 936 BSN 635101), Pickup Platforms: 912, 914	Header End Shield Right Hand	AMAH88889	\$ 275.00	
Platforms: 213, 215, 216, 218, 220, 222, 224, 230	Reel Drive Shield	AMAH95481	\$ 245.00	

Poly Skid Plate Kits and Components



Application	Description	Part Number	Retail Price	Core
Platform: 213F	Poly Skid Plate Kit	13' CS13JD	\$ 399.00	
Platform: 215F	Poly Skid Plate Kit	15' CS15JD	\$ 430.00	
Platforms: 216F	Poly Skid Plate Kit	16' CS16JD	\$ 445.00	
Platform: 218F	Poly Skid Plate Kit	18' CS18JD	\$ 520.00	
Platform: 220F	Poly Skid Plate Kit	20' CS20JD	\$ 540.00	
Platform: 222F	Poly Skid Plate Kit	22' CS22JD	\$ 750.00	
Platform: 224F	Poly Skid Plate Kit	24' CS24JD	\$ 795.00	
Platform: 620F	Poly Skid Plate Kit	20' CS20JD6	\$ 760.00	
Platform: 625F	Poly Skid Plate Kit	25' CS25JD6	\$ 960.00	
Platform: 630F	Poly Skid Plate Kit	30' CS30JD6	\$ 1140.00	
Platform: 635F	Poly Skid Plate Kit	35' CS35JD6	\$ 1335.00	
Platform: 913F	Poly Skid Plate Kit	13' CS13JD9	\$ 520.00	
Platform: 915	Poly Skid Plate Kit	15' CS15JD9	\$ 455.00	
Platform: 918F	Poly Skid Plate Kit	18' CS18JD9	\$ 540.00	
Platform: 920F	Poly Skid Plate Kit	20' CS20JD9	\$ 600.00	
Platform: 922	Poly Skid Plate Kit	22' CS22JD9	\$ 670.00	
Platform: 924	Poly Skid Plate Kit	24' CS24JD9	\$ 820.00	
Platform: 925F	Poly Skid Plate Kit	25' CS25JD9	\$ 732.00	
Platform: 930F	Poly Skid Plate Kit	30' CS30JD9	\$ 810.00	
Platforms: 618F, 620F, 622F, 625F, 630F, 635F	Poly Skid Plate, Float Arm Standard Height Option	AMAH204994	\$ 47.81	

Prices Subject to Change without Prior Notice. The use of original equipment manufacturer (OEM) part numbers or trademarks, e.g. Case® and John Deere®, are for reference purposes only and for indicating product use and compatibility. Our company and the listed replacement parts contained herein are not sponsored, approved or manufactured by the OEM. All parts are New unless designated Reman in the description.

John Deere®—Combine







Application	Description	Part Number	Retail Price	Core
Platforms: 620F, 622F, 625F, 630F, 635F	Poly Skid Plate, Left End	AMH208626	\$ 15.00	
Platforms: 620F, 622F, 625F, 630F, 635F, 635FD, 640FD BSN 784999	Poly Skid Plate, Center	AMH205344	\$ 10.50	
Platforms: 620F, 625, 625F, 630F, 635, 635F, 640FD	Poly Skid Plate, Rear Right End	AMH170501	\$ 25.00	
	Poly Skid Plate, Left End	AMH170502	\$ 55.00	
Platforms: 620F, 625F, 630F, 635F, 640FD	Poly Skid Plate, Front Right End Standard Height	AMH209696	\$ 18.00	
Platforms: 630FD, 635FD, 640FD BSN 784999	Poly Skid Plate, Right End	AMHXE59505	\$ 85.00	
	Poly Skid Plate, Left End	AMHXE59506	\$ 85.00	
Platforms: (630FD, 635FD, 640FD BSN 784999)	Poly Skid Plate, Center Feed	AMHXE16408	\$ 205.00	
Platforms: (630FD, 635FD, 640FD ASN 785000), 645FD	Poly Skid Plate, Right End	AMHXE87670	\$ 85.00	
	Poly Skid Plate, Left End	AMHXE87669	\$ 85.00	
Platforms: 630FD, 635FD ASN 765000, 640FD BSN 784999, 645FD BSN 784999	Poly Skid Plate, Center	AMH231690	\$ 17.50	
Platforms: (630FD, 635FD ASN 785000), 640FD, 645FD	Poly Skid Plate, Rear, Small	AMHXE81731	\$ 9.00	
Platforms: 630FD*, 635FD**, 640FD*** *(38) Required **(44) Required *** (52) Required BSN 784599 and (50) Required ASN 785000	Poly Skid Plate Cover	AMHXE10959	\$ 14.95	
Platforms: 630FD, 635FD, 640FD, 645FD, 730FD, 740FD, 745FD	Poly Skid Plate, Clean Out Door	AMHXE54477	\$ 240.00	
Cutting Platforms: 615F, 615R, 618F, 618R, 620F, 620R, 622F, 622R, 625F, 625R, 630F, 630R, 635F, 635R	Poly Skid Plate, Front, Right Hand Raised Rivets Not Included	AMH204243	\$ 28.41	
	Poly Skid Plate, Rear, Right Hand Raised	AMH204244	\$ 48.84	
	Poly Skid Plate, Left Hand	AMH218047	\$ 70.45	
	Poly Skid Plate, Left Hand Raised For Float Arm Stabilizer	AMH211864	\$ 38.46	
	Poly Skid Plate, Left Hand For Standard Height Float Arm Stabilizer	AMH215075	\$ 61.51	
	Poly Skid Plate, Center Raised For Float Arm w/ Increased Height Option	AMH204221	\$ 17.42	
	Poly Skid Plate, Float Arm Raised For Float Arm w/ Increased Height Option	AMH204225	\$ 29.55	
	Draper Platforms: 645FD ASN 785000, 730FD, 735FD, 740FD, 745D	Poly Skid Plate, Cutterbar For Standard Cut Height	AMHXE87738	\$ 19.37
For John Deere® Poly Skid Plates	Poly Skid Plate Rivet, Aluminum Sold in Multiples of 25, Priced Individually Replaces HXE52669	AMRVT531	\$ 0.26	

Hoods

Application	Description	Part Number	Retail Price	Core
Sprayer: 4920	Hood Fiberglass Construction, Pre-Painted Replaces RE169901, RE194633	AMRE215791	\$ 4200.00	







John Deere®—Combine

Lighting

	Application	Description	Part Number	Retail Price	Core
	9560SH, 9570STS, 9660, 9670STS, 9770STS, 9860STS, Forage Harvesters: 7200, 7300, 7400, 7500, Sprayers: 710, 4920, 4930	Replacement Bulb	AMRE179326	\$ 6.30	
	9560, 9560SH, 9560STS, 9570STS, 9650STS, 9660, 9660STS, 9670STS, 9750STS, 9760STS, 9770STS, 9860STS, 9870STS, Cotton Pickers: 7460, 7660, 7760, 9960, CP690, CS690, Sprayers: 4720, 4730, 4830, 4920, 4930, Swathers: 4895, 4995, A400, D450, R450	LED Floodlight Conversion Kit (2) 6.50" x 4.50" Oval Lights, Each Light is 5000 Lumens, 60 Watts, 5 Amps For 12 Volt to 24 Volt Systems Includes Mounting Brackets, Stainless Steel Hardware and Wiring Harness (Plug-and-Play)	AMTL8320-KIT	\$ 350.00	
	9450, 9500, 9510, 9550, 9550SH, 9560, 9560SH, 9560STS, 9570STS, 9600, 9610, 9650, 9650STS, 9660, 9660CTS, 9660STS, 9670STS, 9750STS, 9760STS, 9870STS, CTS	LED Floodlight/Spotlight Combo Kit Includes (6) Combo Lights, Stainless Steel Hardware and Connector 4" x 6" Rectangle Combo Lights Each Light is 3500 Lumens, 60 Watts, 5 Amps For 12 Volt to 24 Volt Systems Uses Original Mount and Wiring	AMX34185	\$ 570.00	
	9560, 9560SH, 9560STS, 9570STS, 9650STS, 9660, 9660STS, 9670STS, 9750STS, 9760STS, 9770STS, 9860STS, 9870STS	LED Light Kit Includes (6) Cab Mount LED Floodlights*, (2) Cab Mount LED Floodlight/Spotlight Combo Lights**, (6) LED Work Lights***, Connectors and Stainless Steel Mounting Hardware Uses Original Mount and Wiring *5200 Lumens, 65 Watts, 5.40 Amps **3500 Lumens, 60 Watts, 5 Amps ***2900 Lumens, 35 Watts, 2.90 Amps	AMX34160	\$ 1470.00	
	S550, S650, S660, S670, S670HM, S680, S680HM, S690, S690HM, S760, S770, S780, S790, T550, T560, T660, T670	LED Light Kit Includes (4) Cab Mount LED Headlights*, (4) Cab Mount LED Floodlight/Spotlight Combo Lights**, (2) Cab Mount LED Floodlight/Spotlight Combo Lights***, (6) LED Work Lights****, Connectors and Stainless Steel Mounting Hardware *2200 Lumens, 30 Watts, 2.50 Amps **3000 Lumens, 40 Watts, 3.30 Amps ***3500 Lumens, 60 Watts, 5 Amps ****2900 Lumens, 35 Watts, 2.90 Amps	AMX34161	\$ 1450.00	
	9560, 9560SH, 9560STS, 9570STS, 9650STS, 9660, 9660CTS, 9660STS, 9670STS, 9750STS, 9760STS, 9770STS, 9860STS, 9870STS Replaces R198623	LED Conversion Light Stubble Light 5.75" x 3.75" Oval Light 2900 Lumens, 35 Watts, 2.90 Amps For 12 Volt to 24 Volt Systems Includes Bracket and Connectors	AMTL5650	\$ 95.00	
		LED Conversion Light Stubble Light 5.75" x 3.75" Oval Light 2900 Lumens, 35 Watts, 2.90 Amps For 12 Volt to 24 Volt Systems Includes Bracket and Connectors	AMAH207788	\$ 76.00	







John Deere®—Combine

John Deere®—Combine

Application	Description	Part Number	Retail Price	Core
 Sprayers: 4720, 4730, 4830	LED Headlight Hood Mount 7.12" x 4.75" x 3" Oval Light Dual Hi/Lo Beam 5000 Lumens, 65 Watts, 5.40 Amps For 12 Volt to 24 Volt Systems Plug-and-Play, Uses Original Hardware Replaces RE181963, RE181964, RE205360	AMTL7820	\$ 125.00	
 Sprayers: 4720, 4730, 4830	LED Headlight Hood Mount 7" x 4.75" x 3.25" Oval Light Dual Hi/Lo Beam 5000 Lumens, 65 Watts, 5.40 Amps For 12 Volt to 24 Volt Systems Uses Original Mount and Hardware, Plug-and-Play Replaces RE181963, RE181964, RE205360	AMRE181963	\$ 100.00	
 S550 SN 745100-764999, (S650, S670HM, S680HM ASN 765000), (S660, S670, S680, S690 ASN 745100), S690HM SN 745101-765000, S760, S770, S780, S785, S790, T550, T560, T660, T670, Forage Harvesters: (8100, 8200, 8300, 8400, 8500, 8600, 8700, 8800 SN 513822-619999), (9600, 9700, 9800, 9900 SN 619000-619999)	LED Headlight 3.30" Round Light 2200 Lumens, 30 Watts, 2.50 Amps For 12 Volt to 24 Volt Systems Includes Swivel Mounting Bracket and Hardware Plug-and-Play for Direct Replacement	AMTL8090	\$ 90.00	
 S550 SN 745100-764999, (S650, S670HM, S680HM ASN 765000), (S660, S670, S680, S690 ASN 745100), S690HM SN 745101-765000, S760, S770, S780, S785, S790, T550, T560, T660, T670, Forage Harvesters: (8100, 8200, 8300, 8400, 8500, 8600, 8700, 8800 SN 513822-619999), (9600, 9700, 9800, 9900 SN 619000-619999)	LED Headlight 3.30" Round Light 2200 Lumens, 30 Watts, 2.50 Amps For 12 Volt to 24 Volt Systems Includes Swivel Mounting Bracket and Hardware Plug-and-Play	AMAXE20661	\$ 68.00	
 Forage Harvesters: 6650, 6750, 6850, 6950, 7180, 7200, 7250, 7280, 7300, 7350, 7380, 7400, 7450, 7480, 7500, 7550, 7580, 7700, 7750, 7780, 7800, 7850, 7950, 7980 Replaces 3713134M91, AZ41570	LED Headlight Floodlight/Spotlight Combo 7.25" x 3.25" x 3.25" Retangle Light 3500 Lumens, 40 Watts, 3.30 Amps For 12 Volt to 24 Volt Systems	AMTL9090	\$ 105.00	
 Forage Harvesters: 6650, 6750, 6850, 6950, 7180, 7200, 7250, 7280, 7300, 7350, 7380, 7400, 7450, 7480, 7500, 7550, 7580, 7700, 7750, 7780, 7800, 7850, 7950, 7980 Replaces 3713134M91, AZ41570	LED Headlight Floodlight/Spotlight Combo 7.25" x 3.25" x 3.25" Retangle Light 3500 Lumens, 40 Watts, 3.30 Amps For 12 Volt to 24 Volt Systems	AMAX41570	\$ 84.00	

John Deere®—Combine







John Deere®—Combine

Application	Description	Part Number	Retail Price	Core
 Sprayers: 4720, 4730, 4830	LED Headlight, Right Hand Outside Corner Mount 6.50" x 4.75" x 2.75" Oval Light 2000 Lumens, 30 Watts, 2.50 Amps For 12 Volt to 24 Volt Systems Uses Original Mount and Wiring, Plug-and-Play Replaces RE205362	AMTL7830R	\$ 115.00	
	LED Headlight, Left Hand Outside Corner Mount 6.50" x 4.75" x 2.75" Oval Light 2000 Lumens, 30 Watts, 2.50 Amps For 12 Volt to 24 Volt Systems Uses Original Mount and Wiring, Plug-and-Play Replaces RE205361	AMTL7830L	\$ 115.00	
	LED Headlight, Right Hand Outside Corner Mount 6.50" x 4.75" x 2.75" Oval Light 2000 Lumens, 30 Watts, 2.50 Amps For 12 Volt to 24 Volt Systems Uses Original Mount and Wiring, Plug-and-Play Replaces RE205362	AMRE181913	\$ 92.00	
	LED Headlight, Left Hand Outside Corner Mount 6.50" x 4.75" x 2.75" Oval Light 2000 Lumens, 30 Watts, 2.50 Amps For 12 Volt to 24 Volt Systems Uses Original Mount and Wiring, Plug-and-Play Replaces RE205361	AMRE181916	\$ 92.00	
 4400, 6620, 6622, 7720	Halogen Floodlight, Sealed Beam 4.50" Diameter Round Light 2-Terminal Connection For 12 Volt Systems Replaces A47179, AR104119, E3NN15330AA	AMH7606	\$ 13.25	
 Universal Equipment	LED Floodlight All-Position Light 4.25" x 4.25" Square Light 2650 Lumens, 48 Watts, 4 Amps For 12 Volt to 24 Volt Systems Includes Mounting Bracket and Stainless Steel Hardware	AMTL105F	\$ 95.00	
 Universal Equipment	LED Floodlight All-Position Light 6.25" x 1.75" Rectangle Light 1300 Lumens, 18 Watts, 1.50 Amps For 12 Volt to 24 Volt Systems Includes Mounting Bracket and Stainless Steel Hardware	AMTL118F	\$ 50.00	
 Universal Equipment	LED Floodlight All-Position Light 5" Round Light 3200 Lumens, 40 Watts, 3.30 Amps For 12 Volt to 24 Volt Systems Includes Mounting Bracket and Stainless Steel Hardware	AMTL180	\$ 89.00	
 Universal Equipment	LED Floodlight All-Position Light Round Light 6900 Lumens, 50 Watts, 4.10 Amps For 9 Volt to 32 Volt Systems Includes Mounting Bracket and Stainless Steel Hardware	AMTL500F	\$ 120.00	
	LED Floodlight All-Position Light 4.30" Round Light 5040 Lumens, 50 Watts, 4.10 Amps For 12 Volt to 24 Volt Systems Includes Stainless Steel Adjustable Mounting Bracket	AMAT305931	\$ 96.00	





Prices Subject to Change without Prior Notice. The use of original equipment manufacturer (OEM) part numbers or trademarks, e.g. Case® and John Deere®, are for reference purposes only and for indicating product use and compatibility. Our company and the listed replacement parts contained herein are not sponsored, approved or manufactured by the OEM. All parts are New unless designated Reman in the description.

John Deere®—Combine

John Deere®—Combine

Application	Description	Part Number	Retail Price	Core
 Universal Equipment	LED Floodlight All-Position Light 4.25" Round Light 2650 Lumens, 42 Watts, 3.50 Amps For 12 Volt to 24 Volt Systems Includes Mounting Bracket and Stainless Steel Hardware	AMTL115F	\$ 59.00	
 Sprayers: 4700, 4710, Swathers: 4890, 4895, 4990, 4995 Replaces RE154898, RE154900, RE154901, RE154902, RE154903, RE154904, RE154906	LED Floodlight Rectangle Light 3200 Lumens, 40 Watts, 3.20 Amps For 12 Volt to 24 Volt Systems Includes Interchangeable Mounts	AMTL8400	\$ 99.00	
	LED Floodlight 6" x 4" Rectangle Light 3200 Lumens, 40 Watts, 3.20 Amps For 12 Volt to 24 Volt Systems	AMRE154908	\$ 79.20	
 9560, 9560SH, 9560STS, 9570STS, 9660, 9660CTS, 9660STS, 9760STS, 9770STS, 9860STS, 9870STS, S550, S650 ASN 765000, (S660, S670, S680, S690 ASN 745100), (S670HM, S680HM BSN 765000), S690HM SN 745101-765000, S760, S770, S780, S785, S790, T550, T560, T660, T670 Replaces AH207788, AXE16947, AXE40244	LED Floodlight 5.75" x 3.75" x 3" Oval Light 2900 Lumens, 35 Watts, 2.90 Amps For 12 Volt to 24 Volt Systems Includes Stainless Steel Mounting Hardware and Mounting Bracket	AMTL5655	\$ 95.00	
 Universal Equipment	LED Wide Floodlight All-Position Light 5" x 7" Rectangle Light 3800 Lumens, 35 Watts For 12 Volt to 24 Volt Systems Replaces AT135485, AT135486, AT305931, AT443223, AT443224	AMX34171	\$ 60.00	
 Universal Equipment	LED Floodlight, Sealed Beam Fender Mount 4.50" Diameter Round Light 1250 Lumens, 18 Watts, 1.50 Amps Trapezoid Pattern For 12 Volt to 24 Volt Systems Replaces AF3892R, AT25451, RE285628, RE336111, RE561116, RE561117	AMTL3010	\$ 40.00	
	LED Floodlight Fender Mount 4.50" Diameter Sealed Beam Round Light 1250 Lumens, 18 Watts, 1.20 Amps Trapezoid Pattern For 12 Volt to 24 Volt Systems Lasts 50 times longer than halogen lighting, vibration resistant w/ no filament failures, uses original mount and wiring, Operating temperature of -40°F to 140°F / -40°C to 60°C Replaces AF3892R, AT25451, RE285628, RE336111, RE561116, RE561117	AMRE336111	\$ 35.00	
 Universal Equipment	LED Floodlight Fender Mount 4.50" Diameter Sealed Beam Round Light 1440 Lumens, 18 Watts, 1.60 Amps Lasts 50 times longer than halogen lighting, vibration resistant w/ no filament failures, 2-terminal connection, Operating temperature of -40°F to 140°F / -40°C to 60°C Replaces RE285628	AMRE336112	\$ 67.75	





John Deere®—Combine

Application	Description	Part Number	Retail Price	Core
 Sprayers: 4720, 4730, 4830, 4920, 4930 Replaces RE173600, RE260102	LED Floodlight Hood Mount 6.50" x 4.50" x 4" Oval Light Dual Hi/Lo Beam 6000 Lumens, 65 Watts, 5.40 Amps For 12 Volt to 24 Volt Systems Uses Original Mount and Wiring, Plug-and-Play	AMTL8520S	\$ 125.00	
	LED Floodlight Hood Mount 6.50" x 4.50" x 4" Oval Light Dual Hi/Lo Beam 6000 Lumens, 65 Watts, 5.40 Amps For 12 Volt to 24 Volt Systems Uses Original Mount and Wiring, Plug-and-Play	AMRE173600	\$ 112.50	
 Sprayers: 4920, 4930 Replaces RE180613, RE181282, RE271573, RE271574	LED Floodlight Hood Mount 5.50" x 3.75" Oval Light 3000 Lumens, 35 Watt, 2.90 Amps For 12 Volt to 24 Volt Systems Use Original Mount and Wiring, Plug-and-Play	AMTL8220	\$ 115.00	
	LED Floodlight Hood Mount 5.50" x 3.75" Oval Light 3000 Lumens, 39 Watts, 2.90 Amps For 12 Volt to 25 Volt Systems Includes Connector for Plug-and-Play Installation Replace 86038024, RE180613, RE181282, RE271573	AMRE271574	\$ 92.00	
 Cotton Stripper: 7460	LED Floodlight Replacement Hood and Cab Mount 2.49" x 5.44" Rectangle Light 1440 Lumens, 12 Watts, 1 Amp For 12 Volt to 24 Volt Systems Uses Original Mount and Wiring Replaces R161288, RE37450, RE306510	AMX34182	\$ 40.00	
	LED Floodlight Replacement Hood and Cab Mount 2.49" x 5.44" Rectangle Light 1440 Lumens, 12 Watts, 1 Amp For 12 Volt to 24 Volt Systems Replaces RE161288, RE37450, RE37849	AMRE306510	\$ 32.00	
 9780CTS, C670, T550, T560, T660, T670, Forage Harvesters: 7180, 7200, 7250, 7280, 7300, 7350, 7380, 7400, 7450, 7480, 7500, 7550, 7580, 7700, 7750, 7780, 7800, 7850, 7950, 7980, Sprayers: 4630, R4023, R4030, R4038, R4045	LED Floodlight 4.25" x 4.50" x 3.00" Oval Light 3200 Lumens, 40 Watts, 3.20 Amps For 12 Volt to 24 Volt Systems Housing Has Powder Coat Finish Includes 2-Terminal Connector, Mounting Bracket and Stainless Steel Hardware Replaces AL150478, AL174341, AL175528, AL175529, AL202742, AL202743, AL205375, RE219708, RE233263, RE567623	AMTL5670	\$ 105.00	
	LED Floodlight 4.25" x 4.50" x 3" Oval Light 3200 Lumens, 40 Watts, 3.20 Amps For 12 Volt to 24 Volt Systems Housing Has Powder Coat Finish Includes 2-Terminal Connector, Mounting Bracket and Stainless Steel Hardware Replaces AL150478, AL174341, AL175528, AL175529, AL202742, AL202743, AL205375, RE219708, RE233263	AMRE567623	\$ 84.00	







Prices Subject to Change without Prior Notice. The use of original equipment manufacturer (OEM) part numbers or trademarks, e.g. Case® and John Deere®, are for reference purposes only and for indicating product use and compatibility. Our company and the listed replacement parts contained herein are not sponsored, approved or manufactured by the OEM. All parts are New unless designated Reman in the description.

John Deere®—Combine

John Deere®—Combine





Application	Description	Part Number	Retail Price	Core
 <p>Forage Harvesters: 7200, 7300, 7400, 7500, 7700, 7800</p>	<p>LED Floodlight Cab Mount 4.25" x 4.50" Oval Light 3600 Lumens, 40 Watts, 3.20 Amps For 12 Volt to 24 Volt Systems Replaces RE567623, AL150478, AL156627, AL174341, AL175528, AL175529, AL202742, AL202743, AL205375</p>	AMRE219708	\$ 105.00	
 <p>Universal Equipment</p>	<p>LED Floodlight Cab and Fender Mount 3.50" x 6" Rectangle Light 3600 Lumens, 40 Watts, 3 Amps</p>	AMX34146	\$ 65.00	
 <p>9560, 9560SH, 9560STS, 9570STS, 9650STS, 9660, 9660STS, 9670STS, 9750STS, 9760STS, 9770STS, 9860STS, 9870STS, Cotton Pickers: 7660, 7760, 9996, CP690, CS690, Cotton Stripper: 7460, Sprayers: 4710, 4720, 4730, 4830, 4920, 4930, 4940, Swathers: 4895, 4995, A400, D450, R450 Replaces AH212522, AH212576, RE181281</p>	<p>LED Floodlight Upper Front and Rear Cab, Rear Fender and Mid Mount 6.50" x 4" Oval Light 5200 Lumens, 65 Watts, 5.40 Amps For 12 Volt to 24 Volt Systems Housing Has Powder Coat Finish Includes Mounting Bracket and Stainless Steel Hardware</p>	AMTL5680	\$ 125.00	
	<p>LED Floodlight Upper Front and Rear Cab, Rear Fender and Mid Mount 6.50" x 4" Oval Light 5500 Lumens, 65 Watts For 12 Volt to 24 Volt Systems Housing Has Powder Coat Finish Includes Connector and Bracket for Plug-and-Play Installation</p>	AMAH212523	\$ 100.00	
 <p>Forage Harvesters: 6610, 6650, 6710, 6750, 6810, 6850, 6910, 6950, Sprayers: 4700, 4710, 4720, 6500, 6600, 6700</p>	<p>LED Floodlight/Spotlight Combo Grille Mount 6" x 4" Rectangle Light 3500 Lumens, 60 Watts, 5 Amps For 12 Volt to 24 Volt Systems Includes Connector, Adapter and Stainless Steel Hardware Replaces AL75338</p>	AMTL6700	\$ 110.00	
	<p>LED Floodlight/Spotlight Combo Grille Mount 6" x 4" Rectangle Light 3500 Lumens, 60 Watts, 5 Amps For 12 Volt to 24 Volt Systems Includes Connector, Adapter and Mounting Hardware</p>	AMAL75338	\$ 88.00	
 <p>9400, 9410, 9450, 9500, 9510, 9550, 9560, 9570STS, 9600, 9610, 9650, 9660, 9670STS, 9750STS, 9760STS, 9860STS, 9870STS, 9880STS, CTS, Cotton Picker: 9986, Forage Harvesters: 7200, 7300, 7400, 7500, 7700, 7800, Swathers: 4895, 4990, 4995 Replaces AH128328, AH159332, AH159333, AH170565</p>	<p>LED Floodlight/Spotlight Combo Cab Mount 4" x 6" Rectangle Light 3500 Lumens, 60 Watts, 5 Amps (4) Required For 12 Volt to 24 Volt Systems Connector Included, Plug-and-Play</p>	AMTL9000	\$ 95.00	
	<p>LED Floodlight/Spotlight Combo Cab Mount 4" x 6" Rectangle Light 3500 Lumens, 60 Watts, 5 Amps (4) Required For 12 Volt to 24 Volt Systems Includes Connector, Plug-and-Play</p>	AMAH128327	\$ 76.00	

John Deere®—Combine







Application	Description	Part Number	Retail Price	Core
 <p>S550, S650, S660, S670, S670HM, S680, S680HM, S690, S690HM, S760, S770, S780, T550, T560, T660, T670, Forage Harvesters: 8100, 8200, 8300, 8400, 8500, 8600, 8700, 8800, Sprayers: R4023, R4030, R4038, R4045, Swathers: W235, W260</p>	<p>LED Floodlight/Spotlight Combo Cab Mount 6" x 3" x 3.25" Oval Light 3000 Lumens, 40 Watts, 3.30 Amps For 12 Volt to 24 Volt Systems Plug-and-Play for Direct Replacement Replaces RE269640, RE331643, RE573609</p> <p>LED Floodlight/Spotlight Combo Cab Mount 6" x 3" x 3.25" Oval Light 3000 Lumens, 40 Watts, 3.30 Amps For 12 Volt to 24 Volt Systems Plug-and-Play for Direct Replacement Replaces AL207359, RE269640, RE331643, RE573609</p>	<p>AMTL8060</p> <p>AMRE269638</p>	<p>\$ 95.00</p> <p>\$ 76.00</p>	
 <p>Universal Equipment</p>	<p>LED Spotlight All-Position Light 4.25" x 4.25" Square Light 1400 Lumens, 27 Watts, 2.20 Amps For 12 Volt to 24 Volt Systems</p>	AMTL100S	\$ 45.00	
 <p>Universal Equipment</p>	<p>LED Spotlight All-Position Light 6.25" x 1.75" Rectangle Light 1300 Lumens, 18 Watts, 1.50 Amps For 12 Volt to 24 Volt Systems Includes Mounting Bracket and Stainless Steel Hardware</p>	AMTL118S	\$ 50.00	
 <p>Universal Equipment</p>	<p>LED Spotlight All-Position Light Round Light 6900 Lumens, 50 Watts, 4.10 Amps For 9 Volt to 32 Volt Systems Includes Mounting Bracket and Stainless Steel Hardware</p>	AMTL500S	\$ 120.00	
 <p>3300, 4400, 4420, 6600, 6602, 6620, 6622, 7700, 7720, 7721, 8820</p>	<p>LED Trapezoid Light Fender Mount 4.50" Sealed Beam Round Light 2200 Lumens, 24 Watts, 2 Amps For 12 Volt to 24 Volt Systems Uses Original Mount and Wiring Replaces RE336111</p>	AMTL3015	\$ 50.00	
 <p>Universal Equipment</p>	<p>LED Trapezoid Light Cab and Fender Mount 4.50" Diameter Round Light 2800 Lumens, 40 Watts, 3.30 Amps Trapezoid Pattern For 12 Volt to 24 Volt Systems Bottom Mount w/ Built-In Heat Sink Includes Mounting Bracket, Long and Short Rubber Bezels and Stainless Steel Hardware Replaces AR85260, RE19079</p> <p>LED Trapezoid Light Cab and Rear Fender Mount 4.50" Diameter Round Light 2800 Lumens, 40 Watts, 3.30 Amps Trapezoid Pattern For 12 Volt to 24 Volt Systems Bottom Mount w/ Built-In Heat Sink Includes Mounting Bracket, Long and Short Rubber Bezels and Stainless Steel Hardware Replaces AR85260, RE19079</p>	<p>AMTL2080</p> <p>AMX33121</p>	<p>\$ 95.00</p> <p>\$ 76.00</p>	

John Deere®—Combine





John Deere®—Combine

Application	Description	Part Number	Retail Price	Core
 Universal Equipment	LED Warning Light Cab, Header or Swather Mount Can be used for Turn Signal, Brake or Running Lights 4.125" Diameter Round Light Double Sided, Amber Lenses 25 Bulbs per Side For 12 Volt to 24 Volt Systems	AMTLFL2	\$ 55.00	
	LED Warning Light Cab, Header or Swather Mount Can be used for Turn Signal, Brake or Running Lights 4.125" Diameter Round Light Double Sided, Amber Lenses 25 Bulbs per Side For 12 Volt to 24 Volt Systems	AMX1910149	\$ 44.00	
 Universal Equipment	LED Warning Light Cab, Header or Swather Mount Can be used for Turn Signal, Brake or Running Lights 4.125" Diameter Round Light Double Sided, Red and Amber Lenses 25 Bulbs per Side For 12 Volt to 24 Volt Systems	AMTLFL3	\$ 55.00	
	LED Warning Light Cab, Header or Swather Mount Can be used for Turn Signal, Brake or Running Lights 4.125" Diameter Round Light Double Sided, Red and Amber Lenses 25 Bulbs per Side For 12 Volt to 24 Volt Systems	AMX33126	\$ 44.00	
 Cotton Pickers: 9900, 9910, 9920, 9930, 9940, 9950, 9960, 9965, 9970, Cotton Stripper: 484 - All w/ Sound-Gard™ Cab	LED Warning Light Cab Mount 2" x 7.75" Rectangle Light Amber Lens 9 Watts, 0.75 Amp For 12 Volt to 24 Volt Systems Requires 6 ohm Load Resistor if 4 Lights are installed	AMX34184	\$ 50.00	
	LED Warning Light Cab Mount 2" x 7.75" Rectangle Light Amber Lens 9 Watts, 0.75 Amp For 12 Volt to 24 Volt Systems Requires 6 ohm Load Resistor if 4 Lights are installed	AMAR60250	\$ 40.00	
 Universal Equipment	LED Magnetic Warning Light All-Position Light 360° Flashing Light, Multiple Patterns 9.50" x 6.75" Rectangle Light Magnetic Base or Solid Mount For 12 Volt to 24 Volt Systems Includes Cigarette Lighter Adapter, Wiring and Switch	AMTL1100	\$ 170.00	
 Universal Equipment	LED Magnetic Warning Light All-Position Light 360° Flashing Light, Multiple Patterns 14" x 6.75" Rectangle Light Magnetic Base or Solid Mount For 12 Volt to 24 Volt Systems Includes Cigarette Lighter Adapter, Wiring and Switch	AMTL1200	\$ 190.00	
Universal Equipment	Warning Beacon 360° Flashing Beacon, Amber Lens For 0.9435" Diameter Pipe Replaces 84337818, AZ44705, AZ101891	AM82018390	\$ 45.64	

John Deere®—Combine

	Application	Description	Part Number	Retail Price	Core
	Universal Equipment	LED Warning Beacon 360° Flashing Beacon 2.75" x 5.25" Light Polycarbonate Amber Lens and Housing For 12 Volt to 24 Volt Systems Includes Solid Mounting Pad and Stainless Steel Hardware	AMTL2100	\$ 30.00	
	Universal Equipment	LED Warning Beacon 360° Flashing Beacon, 3 Different Patterns 5" x 10" Light Amber Lens, 48 Watts, 4 Amps For 12 Volt to 24 Volt Systems Brackets Sold Separately	AMX33131	\$ 75.00	
	Universal Equipment	Warning Beacon Bracket	AMX33132	\$ 15.00	
	Universal Equipment	Warning Beacon Bracket	AMX33133	\$ 15.00	
	Universal Equipment	Warning Beacon Bracket	AMX33137	\$ 15.00	
	Universal Equipment	Warning Beacon Bracket	AMX33135	\$ 15.00	
	9660, (S650, S670 BSN 785001), S660 SN 765172-785000, S680, S690 SN 765250-785000, (S760, S770, S780, S790 ASN 1Z0S760XXX110000), Cotton Pickers: 7760, CP690, Cotton Stripper: CS690, Forage Harvesters: 6650, 6750, 6850, 6950, 7180, 7200, 7250, 7280, 7300, 7350, 7380, 7400, 7450, 7480, 7500, 7550, 7580, 7700, 7750, 7780, 7800, 7850, 7950, Sprayers: 4940, R4023, R4030, R4038, R4045, R4060	Tail Light Assembly	AMAL112964	\$ 48.66	
	Cotton Pickers: 9900, 9910, 9920, 9930, 9940, 9950, 9960, 9965, 9970, Cotton Strippers: 484, 7440, 7445, Forage Harvesters: 5440, 5460, 5720, 5730, 5820, 5830, Sprayers: 6100, 6500, 6600	LED Tail Light Oval Light, Red Lens 9 Watts, 0.75 Amp For 12 Volt to 24 Volt Systems Replaces RE39223	AMAR78825	\$ 49.00	

John Deere®—Combine







Application	Description	Part Number	Retail Price	Core
	Universal Equipment LED Light Bar 4" Long, 1260 Lumens, Cree Bulbs	AMLED4	\$ 45.00	
	LED Light Bar Flood/Spotlight Combo 10" Long, 5700 Lumens, 50 Watts, 4.20 Amps For 12 Volt to 24 Volt Systems Includes Mounting Bracket and Stainless Steel Hardware	AMTL10SRC	\$ 129.00	
	LED Light Bar Floodlight/Spotlight Combo 14" Long, 5400 Lumens, 72 Watts, 6 Amps Die Cast Aluminum Housing, Polycarbonate Lens For 12 Volt to 24 Volt Systems Includes Mounting Bracket and Heavy Duty Stainless Steel Hardware	AMTLB410C	\$ 150.00	
	LED Light Bar Floodlight/Spotlight Combo 30" Long, 13600 Lumens, 150 Watts, 12.50 Amps For 12 Volt to 24 Volt Systems Includes Mounting Bracket and Stainless Steel Hardware	AMTL30SRC	\$ 230.00	
	LED Light Bar 30" Long, 13860 Lumens, Cree Bulbs	AMLED30	\$ 130.00	
	LED Light Bar Floodlight/Spotlight Combo 40" Long, 17300 Lumens, 200 Watts, 16.70 Amps For 12 Volt to 24 Volt Systems Includes Mounting Brackets and Stainless Steel Hardware	AMTL40SRC	\$ 300.00	
	LED Light Bar 40" Long, 18200 Lumens, Cree Bulbs	AMLED40	\$ 160.00	
	LED Light Bar Floodlight/Spotlight Combo 42" Long, 14500 Lumens, 240 Watts, 19 Amps For 12 Volt to 24 Volt Systems Includes Mounting Bracket and Stainless Steel Hardware Replaces 1163691	AMTLB440C	\$ 250.00	
	LED Light Bar, Curved 50" Long, 21500 Lumens, Cree Bulbs	AMLED50C	\$ 190.00	
	Sprayers: 4700, 4710 LED Corner Floodlight Cab Mount 8.75" x 4" Flashing Corner Light, Polycarbonate Amber Lens 18 Watts, 1.50 Amps For 12 Volt to 24 Volt Systems Replaces RE55150	AMTL8045	\$ 59.00	
	Universal Equipment LED Magnetic Work Light All-Position Light 3.25" Square Floodlight 900 Lumens Magnetic Base Includes Lithium Ion Battery, Cigarette Lighter and DC Charger	AMTL2460	\$ 79.00	
	Universal Sprayers LED Blue Work Light 4.25" x 4.50" x 3.00" Rectangle Light 2650 Lumens, 42 Watts, 3.50 Amps For 12 Volt to 24 Volt Systems Includes Stainless Steel Hardware and Mounting Bracket	AMTLFL5	\$ 59.00	

John Deere®—Combine

John Deere®—Combine

Application	Description	Part Number	Retail Price	Core
3300 ASN 100000, 4400 ASN 101300, 4420, 6600 ASN 105800, 6620, 7700 ASN 111900, 7720, 8820, Cotton Pickers: 9910, 9920, 9930, 9935, 9940, 9950, 9960, 9965, 9970, 9976, Cotton Strippers: 484, 7440, 7445, 7450, 7455, Forage Harvesters: (5440, 5460 BSN 490001), 5720, 5730, 5820, 5830, Sprayers: 6100, 6500, 6600, Swathers: 2320, 2420, 3430, 3830	Control Switch, Turn Signal Replaces AR67398	AMAR64422	\$ 55.88	
Cotton Pickers: 9900, 9910, 9940, 9950, 9960, Forage Harvesters: 5200, 5400, Sprayer: 6000, Swathers: 2280, 2360	Control Switch, Flashing Warning Light Replaces AR67398	AMAR64422	\$ 55.88	



Tie Rods and Components

Application	Description	Part Number	Retail Price	Core
 6620, 7720, 8820	Tie Rod 7" Long, 1" Diameter Right Hand, 16 Thread	AMAH101187	\$ 30.00	
 6620, 7720, 8820	Tie Rod 4.875" Long, 1" Diameter Left Hand, 16 Thread	AMAH101186	\$ 29.00	
 (6620, 7720 - w/ Adjustable Rear Axle), 8820, Cotton Pickers: 9940, 9950, 9965	Tie Rod Clamp	AMM2301T	\$ 6.00	
7700 ASN 036467	Tie Rod Tube 46.19" Long, 1 1/8" ID 12 UNF Right and Left Hand Internal Thread	AMR131288	\$ 243.57	
 9400, 9410, 9450, 9500, (9500SH, 9510SH, 9560SH - w/ Adjustable Rear Axle Only), 9510, 9550, 9560, 9600, 9610, 9650, 9660, 9660CTS, 9680, 9780CTS, CTS, CTS II	Inner Tie Rod 5.875" Long, 1.125" Diameter Right Hand Thread	AMRE12325	\$ 50.00	
 9400, 9410, 9450, 9500, (9500SH, 9510SH, 9560SH - w/ Adjustable Rear Axle Only), 9510, 9550, 9560, 9600, 9610, 9650, 9660, 9660CTS, 9680, 9780CTS, CTS, CTS II	Outer Tie Rod 5.875" Long, 1.125" Diameter Left Hand Thread	AMRE12326	\$ 55.00	
9400, 9410, 9450, 9500, 9510, 9550, 9550SH, 9560, 9560SH, 9600, 9610, 9650, 9650CTS, 9660, 9660CTS - w/ Adjustable Rear Axle	Tie Rod Tube, Right Hand 33.75" Long, 1 1/8" Diameter 12 Right Hand Thread	AMH130228	\$ 191.22	
9400, 9410, 9450, 9500, 9510, 9550, 9550SH, 9560, 9560SH, 9600, 9610, 9650, 9650CTS, 9660, 9660CTS - w/ Adjustable Rear Axle	Tie Rod Tube, Left Hand 33.75" Long, 1 1/8" Diameter 12 Left Hand Thread	AMH130227	\$ 191.22	
9560STS, 9570STS	Tie Rod	AMAH212899	\$ 100.00	
 9560STS, 9570STS, 9650STS, 9660STS, 9670STS, 9750STS, 9760STS, 9770STS, 9860STS, 9870STS	Tie Rod	AMAH154441	\$ 100.00	
 9560STS, 9570STS, 9650STS, 9660STS, 9670STS, 9750STS, 9760STS, 9770STS, 9860STS, 9870STS	Tie Rod	AMAH229183	\$ 132.00	

Prices Subject to Change without Prior Notice. The use of original equipment manufacturer (OEM) part numbers or trademarks, e.g. Case® and John Deere®, are for reference purposes only and for indicating product use and compatibility. Our company and the listed replacement parts contained herein are not sponsored, approved or manufactured by the OEM. All parts are New unless designated Reman in the description.

John Deere®—Combine

John Deere®—Combine

Application	Description	Part Number	Retail Price	Core
 9560STS, 9570STS, 9650STS, 9660STS, 9670STS, 9750STS, 9760STS, 9770STS, 9860STS, 9870STS, S550, S660, S670, S680, S690	Ball Joint	AMAH155001	\$ 99.50	
9570STS, 9670STS, 9770STS, 9870STS, S550, S660, S670	Tie Rod	AMAH231494	\$ 132.00	
2WD: (S550, S650, S660, S670, S680, S690 - w/ Standard Rear Axle), 4WD: (9570STS, 9670STS, 9770STS, 9870STS ASN 730100 w/ 2-Speed Rear Axle)	Tie Rod	AMAH231496	\$ 131.00	
S660, S670	Tie Rod	AMAH230771	\$ 100.00	
S660, S670, S680, S690	Tie Rod	AMAH230775	\$ 100.00	
 Cotton Picker: 9920 (w/ Wide Axle)	Tie Rod Tube 20.50" Long	AMR54965	\$ 55.00	

Power Steering Cylinders and Components

Application	Description	Part Number	Retail Price	Core
3300, 4400, 4420, 6600, 6620, 7700, 7720, Cotton Strippers: 7440, 7445, Forage Harvesters: 5200, 5400, 5440, 5460, 5720, 5730, 5820, 5830, Sprayers: 6500, 6600	Power Steering Cylinder End 2.25" Long, 0.6875" ID 18 Right Hand Thread	AMAH75396	\$ 27.00	
(3300, 4400, 4420, 6600, 7700, 7720 - w/ Fixed or Adjustable Axle), Cotton Strippers: 7440, 7445, Forage Harvesters: 5200, 5400, 5440, 5460, 5720, 5730, 5820, 5830, Sprayers: 6500, 6600, 6700	Power Steering Cylinder End 2" Long, 11/16" Diameter 18 Right Hand Thread	AMAH75397	\$ 53.14	
(6602 ASN 353601, 6620, 6622, 7720, 7722, 8820 - w/ Heavy Duty and 4WD Rear Axles), Cotton Pickers: 9930 w/ Wide Axle and Dual Wheels, 9960, 9965, 9970 BSN 022001, Cotton Stripper: 7445 ASN 4001 w/ Wide Axle	Power Steering Cylinder End 3.75" Long, 1" Diameter 16 Right Hand Thread	AMAH94057	\$ 69.61	
9400, 9410, 9450, 9500, 9500SH, 9510, 9510SH, 9550, 9550SH, 9650, 9650SH, 9600, 9610, 9650, 9650CTS, 9660, 9660CTS, CTS, CTS II	Power Steering Cylinder End 2.75" Long, 0.875" Diameter 14 Right Hand Thread	AMAH204612	\$ 45.00	
9400, 9410, 9450, 9500, 9510, 9550, 9550SH, 9560, 9560SH, 9600, 9610, 9650, 9650CTS, 9660, 9660CTS	Power Steering Cylinder 19.035" Closed Length, 0.984" Rod Diameter, 1.969" Bore Diameter Replaces AH125658	AMAH166833	\$ 362.62	
Cotton Picker: 9970 ASN 020000	Power Steering Cylinder Replaces RE178676	AMRE247841	\$ 700.00	
Sprayers: 4630, 4700, 4710, 4720, 4730, 4830, 4920, 4930, R4023	Power Steering Cylinder End External Thread Replaces AN203649, AN203822	AMAN209415	\$ 78.50	
	Power Steering Cylinder End Internal Thread Replaces AN203648, AN203821	AMAN209414	\$ 84.00	



Rear Wheel Drive and Components

Application	Description	Part Number	Retail Price	Core
9450, 9550, 9550SH, 9560, 9560SH, 9560STS, 9650, 9650CTS, 9650STS, 9660, 9660CTS, 9660STS, 9670STS, 9750STS, 9760STS, 9770STS, 9860STS, 9880STS, S670, S690	Reman Motor, Left Hand Rear Wheel Assist, Cam Lobe Motor, 2-Speed Replaces AH218390, AXE13854, PG200937	AMAH210373	\$ 7500.00	\$ 1000.00
	Reman Motor, Right Hand Rear Wheel Assist, Cam Lobe Motor, 2-Speed Replaces AH218391, PG200938	AMAH210374	\$ 7500.00	\$ 1000.00

John Deere®—Combine

Application	Description	Part Number	Retail Price	Core
9500, 9500SH, 9510, 9510SH, 9550, 9550SH, 9600, 9610, 9650, 9650CTS, CTS, CTS II	Reman Motor, Left Hand Rear Wheel Drive, Cam Lobe Motor, 1600 cc	AMRE33339	\$ 6790.00	\$ 1000.00
	Reman Motor, Right Hand Rear Wheel Drive, Cam Lobe Motor, 1600 cc	AMRE33338	\$ 6790.00	\$ 1000.00
Cotton Pickers: 7660, 7760, CP690, Cotton Stripper: CS690, Forage Harvesters: (7200, 7300, 7400, 7500, 7700, 7800 BSN 508099)	Hydraulic Wheel Motor, Rear 107 cc Replaces AN372513	AMAZ59182	\$ 7093.65	
Forage Harvesters: 7180, (7200, 7300, 7400, 7500, 7700, 7800 ASN 508099), 7250, 7280, 7350, 7380, 7450, 7480, 7550, 7580, 7750, 7780, 7850	Hydraulic Wheel Motor 140 cc Replaces AZ71318	AMAZ104009	\$ 9456.30	
Forage Harvesters: 7200, 7250, 7280, 7300, 7350, 7380, 7400, 7450, 7480, 7500, 7550, 7580, 7700, 7750, 7780, 7800, 7850, 7950, 7980	Hydraulic Wheel Motor 140 cc Replaces AZ65955	AMAZ102511	\$ 9888.55	
Forage Harvesters: 7280, 7350, 7380, 7450, 7480, 7550, 7580, 7750, 7780, 7850, 7950, 7980	Hydraulic Wheel Motor 160 cc	AMAZ104083	\$ 10395.85	

Spindles

Spindles are forged from high grades of alloy steel, machined and assembled to exact specifications.



Application	Description	Part Number	Retail Price	Core
6600 ASN 254050, 6620, 7700, 7720 BSN 507351, Cotton Stripper: 484 ASN 776, Forage Harvesters: 5720, 5820	Spindle	Right Hand AMAH87540	\$ 386.67	
		Left Hand AMAH87542	\$ 400.56	
6620, 7720, 8820 - w/ Heavy Duty Axle	Spindle	Right Hand AMAH94019	\$ 295.00	
		Left Hand AMAH94018	\$ 295.00	
9400, 9410, 9500, 9500 SideHill, 9510, 9510 SideHill, 9600, 9610, CTS, CTS II	Spindle	Right Hand AMAH125655	\$ 350.00	
		Left Hand AMAH125654	\$ 350.00	
9450, 9550, 9550SH, 9560, 9560SH, 9560STS, 9570STS, 9650, 9650CTS, 9650STS, 9660, 9660CTS, 9660STS, 9670STS, 9750STS, 9760STS, 9770STS, 9860STS, 9870STS, S550, S650, S660, S670, S760, S770, Cotton Picker: 9996	Spindle 9.268" OD, M36x2.00" Right Hand Thread Replaces H164559, H201109	AMH201111	\$ 499.84	
9400, 9410, 9500, 9500 SideHill, 9510, 9510 SideHill, 9600, 9610, CTS, CTS II	Spindle Housing	AMAH156821	\$ 295.00	
9450, 9550, 9560, 9560STS, 9650, 9650CTS, 9660, 9660CTS	Spindle Housing For Regular Duty Axles, Fixed and Adjustable	AMAH162576	\$ 337.70	
9400, 9410, 9500, 9500 SideHill, 9510, 9510 SideHill, 9600, 9610, CTS, CTS II	Spindle Housing Bushing	AMH158884	\$ 13.77	
9400, 9410, 9450, 9500, 9500SH, 9550, 9560, 9600, 9610, 9650, 9650CTS, 9660, 9660CTS, CTS	Rear Axle Support Pivot Bushing 2" Wide, 5" ID, 5.20" OD Replaces H114473	AMH146281	\$ 42.61	
9450, 9550, 9560, 9560SH, 9560STS, 9570STS, 9650, 9650CTS, 9650STS, 9660, 9660CTS, 9660STS, 9670STS, 9750STS, 9760STS, 9770STS, 9860STS, 9870STS, S550, S650, S660, S670, S760, S770, Cotton Picker: 9996 w/ Non-Powered Axle	Rear Spindle Bushing 1.624" Long, 2.002" ID, 2.191" OD	AMH201736	\$ 12.31	

John Deere®—Combine

Application	Description	Part Number	Retail Price	Core
9450, 9550, 9550SH, 9560, 9560SH, 9560STS, 9570STS, 9650CTS, 9650STS, 9660, 9660CTS, 9660STS, 9750STS, 9760STS, 9860STS, 9870STS, S550, S650, S660, S670, S760, S770, Cotton Picker: 9996 w/ Non-Powered Axle	Spindle Pin, Rear	AMH164561	\$ 64.86	



Wheel Hubs and Components

Application	Description	Part Number	Retail Price	Core
(6620, 7720, 8820 - w/ Heavy Duty Axle), 9400, 9410, 9500, 9510, 9600, 9610, CTS, CTS II	Wheel Hub	AMH94814	\$ 135.00	
7700, Cotton Pickers: 9900, 9910, 9920, 9930, Cotton Stripper: 7445, Sprayers: 6000, 6500	Wear Sleeve	AMR26632	\$ 4.00	
Cotton Pickers: 9920, 9930, Cotton Stripper: 7445	Wheel Hub, 8-Bolt Use w/ R50992 Press-On Hub Cap	AMR49841	\$ 85.00	
Platforms: 930, 936D, Swathers: 4895, 4995	Hub Assembly, 6-Bolt Replaces AN150825	AMAN183318	\$ 82.39	

Step Components

Application	Description	Part Number	Retail Price	Core
9400, 9410, 9450, 9500, 9500SH, 9510, 9510SH, 9550, 9550SH, 9560, 9560SH, 9560STS, 9570STS, 9600, 9610, 9650, 9650CTS, 9650STS, 9660, 9660CTS, 9660STS, 9670STS, 9750STS, 9760STS, 9770STS, 9860STS, 9870STS, CTS, CTS II	Plastic Hanger For Bottom Step	AMH136126	\$ 36.00	
	Rubber Hanger For Bottom Step	AMH136126R	\$ 26.05	
S550, S650, S660, S670, S670HM, S680, S680HM, S690, S690HM, T550, T560, T660, T670	Rubber Hanger 22" Long	AMHXE41289	\$ 70.00	
	Rubber Hanger 23 5/8" Long	AMHXE41292	\$ 70.00	

Styling Panels

Application	Description	Part Number	Retail Price	Core
9560STS ASN 720100, 9570STS, (9660STS, 9760STS ASN 715400), 9670STS, 9770STS, 9860STS ASN 715600, 9870STS, S550	Rear Wall Panel	AMAH213310	\$ 3000.00	

Gas Struts



Application	Description	Part Number	Retail Price	Core
Sprayer: 4630	Gas Strut, Hood	AMAL174087	\$ 32.00	
Sprayer: 4630	Gas Strut, Door Replaces AL78435, AL110629, AL151278	AMAL174358	\$ 19.00	
Sprayers: 4700, 4710 Replaces RE58715, RE234998	Gas Strut, Door	AM1343825C1	\$ 19.00	
9400, 9410, 9450, 9500, 9510, 9550, 9560, 9570STS, 9600, 9610, 9650, 9660, 9670STS, 9750STS, 9760STS, 9770STS, 9860STS, 9870STS, CTS, CTS II, S650, S660, S670, S680, S690	Gas Strut, Gullwing Door Service Access Shield and Rear Corner Sheet Replaces AH128598, AH128597	AMAH161391	\$ 19.00	
9560, 9570STS, 9650, 9660, 9670STS, 9750STS, 9760STS, 9770STS, 9860STS, 9870STS, S550, S660, S670, S680, S690	Gas Strut, Gullwing Door Replaces AH128597	AMAH161392	\$ 29.00	

John Deere®—Combine

Application	Description	Part Number	Retail Price	Core
Cutting Platforms: 600F, 600R	Gas Strut, End Shield	AMRE70191	\$ 19.00	
Forage Harvesters: 8100, 8200, 8300, 8400, 8500, 8600, 8700, 8800, 9600, 9700, 9800, 9900	Gas Strut, Rotary Screen Door	AMAL57946	\$ 23.15	

Fuel Tanks and Components



Made of high-quality polyethylene material

Application	Description	Part Number	Retail Price	Core
9400 w/ 6068HH050 Engine ASN 701276, Cotton Pickers: 9930 ASN 14000, 9935 BSN 766837, Cotton Strippers: 7445 ASN 16000, 7455 BSN 766837, Sprayers: 4700 BSN 780979, 6100, 6500, 6600, Swathers: 4890 BSN 706489, 4990	Fuel Filter Head Assembly	AMRE500160	\$ 74.07	
9400, 9410, 9450, Cotton Picker: 9935, Cotton Strippers: 7455, 7460, Sprayers: 4700, 4710, 6100, 6500, 6600, 6700, Swather: 4995	Fuel/Water Separator Replaces RE52987, RE53400, RE62418	AMRE62419	\$ 15.00	



Steering Wheels and Caps

Application	Description	Part Number	Retail Price	Core
45, 55, 95, 105	Steering Wheel Rubber covered steel core, 3 spokes, 18" diameter, 36 spline hub For 7/8" steering shaft	AMAF3856R	\$ 76.00	
3300, 4400, 4420, 6600, 6602, 6620, 6622, 7700, 7720, 8820, Cotton Pickers: 299, 9900, 9910, 9920, Cotton Strippers: 484, 7440	Steering Wheel Flat-style, low-profile steering wheel w/ 3 covered spokes, 16" diameter, 7/8" splined hub	AMAR26625	\$ 49.00	
9400, 9410, 9500, 9510, 9600, 9610, CTS, CTS II, Cotton Pickers: 9930, 9935, 9940, 9950, 9960, 9965, 9970, 9976, Cotton Strippers: 7445, 7450, 7455	Steering Wheel Smooth-finish, dished steering wheel w/ 3 covered spokes, 16" diameter, 7/8" splined hub	AMAR78405	\$ 64.00	



Glass

Application	Description	Part Number	Retail Price	Core
 9400, 9410, 9450, 9500, 9510, 9550, 9550SH, 9560, 9560STS, 9570STS, 9600, 9610, 9650, 9650CTS, 9650STS, 9660, 9660CTS, 9660STS, 9670STS, 9750STS, 9760STS, 9770STS, 9870STS, CTS, CTS II, Cotton Picker: 9986, Cotton Stripper: 7460, Swathers: 4890, 4895, 4990	Windshield Glass Replaces AH141412	AMAH166648	\$ 728.19	
 9400, 9410, 9450 BSN 700101, 9500, 9510, 9550, 9550SH, 9560 ASN 715100, 9560SH ASN 715100, 9560STS ASN 715300, 9600, 9610, 9650 BSN 700301, 9650CTS BSN 700401, 9650STS BSN 700501, 9660, 9660CTS, 9750STS BSN 700601, 9860STS ASN 715600, CTS, CTS II, Cotton Picker: 9986, Swathers: 4890, 4895 BSN 181001, 4990, 4995 BSN 183001	Door Glass Replaces AH125963, AH154280, H206852	AMAH168703	\$ 206.00	
 Sprayer: 4630	Door Glass, Right Hand	AMR198625	\$ 350.45	
	Door Glass, Left Hand	AMR198624	\$ 356.00	







John Deere®—Combine

Application	Description	Part Number	Retail Price	Core
 Sprayer: 4630	Upper Rear Glass Tinted	AMR206835	\$ 188.00	
 Sprayers: 4700, 4710, 4720, 4920, 4930	Weatherstrip 240" Long For Front Windshield	AMR115196	\$ 41.00	
 Sprayers: 4700, 4710, 4730, 4830, 4920, 4930, 4940	Weatherstrip 52" Long For Rear Cab Window Replaces R111684, R117033	AMR234302	\$ 14.43	









Air Conditioning and Components

Application	Description	Part Number	Retail Price	Core
 484, 4420, 4400, 6600, 7440, Cotton Pickers: 9910, 9920 - All w/ 329 CID Engine	Compressor Conversion Kit A6 to Sanden Brackets Mount to Original A6 Mounting Brackets Includes Compressor, Mounting Brackets, Support Bracket, Compressor Manifold, Hex Shafts, Hi-Lo Pressure Switches, Wiring Harness for Hi-Lo Switches, Retrofit Adapters, O-Ring, Belt and Mounting Hardware Requires Pag Oil 100V, 6.76 oz (200 cc)	AMX10206	\$ 355.00	
	Ultra Pag Double End Capped, 100V, 8 oz	AMX10267	\$ 12.00	
	Universal Pag Oil, 8 oz	AMX10274	\$ 8.25	
 4420 ASN 610101, 4425, 4435, (6620, 6622, 7720, 7722 ASN 600001), 8820 ASN 615401, 9400 BSN 650100, 9500 BSN 650200, 9600 BSN 650300, CTS BSN 650400, Cotton Pickers: 7440 ASN 001001, 7445 BSN 16000, 9920 ASN 381, 9930 BSN 14000, 9960, 9965 BSN 2000, Forage Harvesters: (5720, 5820 ASN 680001), 5730, 5830, (6610, 6710, 6810, 6910 BSN 500923), Swathers: 3430 BSN 985000, 3830 BSN 978856	Compressor Conversion Kit Nippondenso to Sanden Includes Compressor, Mounting Brackets, Compressor Manifold, Retrofit Adapters, O-Rings and Mounting Hardware Requires Synthetic Ester Oil 100V, 6.42 oz (190 cc)	AMX10167	\$ 495.00	
	Premium Synthetic Ester Oil, 100V, 12 oz	AMX10273	\$ 11.00	
 6600, 6620, 6622, 7700, 7720, 7722, Cotton Picker: 9940, Forage Harvesters: 5200, 5400, 5440, 5460, 5720	Compressor Conversion Kit A6 to Sanden Includes Compressor, Mounting Brackets, Compressor Manifold, Retrofit Adapters, O-Rings and Mounting Hardware Requires Pag Oil 100V, 6.76 oz (200 cc)	AMX10164	\$ 355.00	
	Ultra Pag Double End Capped, 100V, 8 oz	AMX10267	\$ 12.00	
	Universal Pag Oil, 8 oz	AMX10274	\$ 8.25	
	Compressor, Sanden Requires Pag Oil 100V, 6.76 oz (200 cc)	AMX10236	\$ 245.00	
	Ultra Pag Double End Capped, 100V, 8 oz	AMX10267	\$ 12.00	
	Universal Pag Oil, 8 oz	AMX10274	\$ 8.25	

John Deere®—Combine

Application	Description	Part Number	Retail Price	Core	
	9640	Compressor Conversion Kit A6 Style to Sanden Style Includes Compressor, Mounting Brackets, Compressor Manifold, Binary Switch, Retrofit Adapters, O-Rings and Mounting Hardware Requires Pag Oil 100V, 6.76 oz (200 cc)	AMX10168	\$ 355.00	
		Ultra Pag Double End Capped, 100V, 8 oz	AMX10267	\$ 12.00	
		Universal Pag Oil, 8 oz	AMX10274	\$ 8.25	
	484, 1055, 1065, 1085, 3300, 4400, 4420, 6600, 6620, 6622, 7440, 7700, 7720, 7722, 8820, Cotton Pickers: 9900, 9910, 9920, 9940, Swathers: 2250, 2270, 2280, 2320, 2420 Replaces SE501456, SE501457, TY6665, TY6770	Compressor w/ Dust Cover, HD Superheat Compressor, 12 Volt, w/ Single Groove Clutch, 5.58" (142 mm) Clutch Diameter, Can be used for 2 o'clock and 10 o'clock Positions, Must use Original Hoses and Belts, Replaces A6 Style w/ 10 Cylinder Nippondenso 10PA20 Style, Uses Less Power for Greater Efficiency Requires Pag Oil 46V, 7.00 oz (207 cc)	AMX10223	\$ 390.00	
		Ultra Pag Double End Capped, 46V, 8 oz	AMX10266	\$ 12.00	
	3300, 4400, 6600, 7700, Cotton Picker: 9900 Replaces AH84826, TY6788	Reman York Compressor Flange Head, Right Hand Suction, Clutch Not Included	AMX10176	\$ 235.00	
	(3300, 4400, 6600, 7700 - 1975 and Later), 4420 BSN 610100, (6620, 6622, 7720, 7722 BSN 600000), 8820 BSN 615400, Cotton Pickers: 9910, 9920 BSN 380, 9930 BSN 14000, 9940, Forage Harvesters: 5440, 5460, (5720, 5820 SN 550001-680000), Swathers: 2250, 2270, 2280, 2320, 2420	Compressor, A6 Style Superheat Compressor w/ Superheat Switch, 12 Volt, w/ Single Groove Clutch, 5.10" (130 mm) Clutch Diameter, Coil Mounted at 10 o'clock Position, Must use Original Manifold Requires Synthetic Ester Oil 100V, See Manufacturer for Oil Quantity	AMX10142	\$ 550.00	
		Premium Synthetic Ester Oil, 100V, 12 oz	AMX10273	\$ 11.00	
	(3300, 4400, 6600, 7700 - 1975 and Later), 4420 BSN 610100, (6620, 6622, 7720, 7722 BSN 600000), 8820 BSN 615400, Cotton Pickers: 9910, 9920 BSN 380, 9930 BSN 14000, 9940, Forage Harvesters: 5440, 5460, (5720, 5820 SN 550001-680000), Swathers: 2250, 2270, 2280, 2320, 2420 Replaces TY6665, TY6770	Reman Frigidaire A6 Compressor Superheat Compressor, Superheat Switch Not Included, 12 Volt, w/ Single Groove Clutch, 5.58" (142 mm) Clutch Diameter, 0.50" Belt Width See Manufacturer for Oil Type and Quantity	AM50-014	\$ 345.00	\$ 100.00
	4420 ASN 610101, 4425, 4435, (6620, 6622, 7720, 7722 ASN 600001), 8820 ASN 615401, 9400 BSN 650100, 9500 BSN 650200, 9600 BSN 650300, CTS BSN 650400, Cotton Pickers: 7440 ASN 001001, 7445 BSN 16000, 9920 ASN 381, 9930 BSN 14000, 9960, 9965 BSN 2000, Forage Harvesters: (5720, 5820 ASN 680001), 5730, 5830, (6610, 6710, 6810, 6910 BSN 500923), Swathers: 3430 BSN 985000, 3830 BSN 978856 Replaces RE501460, SE501464, SE503051, TY6626, TY6766	Nippondenso Replacement Compressor 12 Volt, w/ Single Groove Clutch, 5.76" (146 mm) Clutch Diameter, Must use Original Manifold Requires Pag Oil 46V, 8.00 oz (236 cc)	AMX10203	\$ 345.00	
		Ultra Pag Double End Capped, 46V, 8 oz	AMX10266	\$ 12.00	

John Deere®—Combine

Application	Description	Part Number	Retail Price	Core
 4420, 4425, 4435, 6620 ASN 600001, 6622 ASN 610401, 7720 ASN 600001, 8820 ASN 615401, 9400 BSN 650100, 9500 BSN 650200, 9600 BSN 6650300, CTS BSN 650400, Cotton Pickers: 9920, 9930, 9950, 9960, 9965, Cotton Strippers: 7440, 7445 BSN 16000, Forage Harvesters: 5720, 5730, 5820, 5830, 6610, 6710, 6810, 6910 Replaces RE10980, RE10981	Nippondenso Manifold Kit Includes Suction Manifold, Discharge Manifold and Pressure Relief Valve Use w/ AMX10203 Compressor	AMX10253	\$ 75.00	
 6600, 7700	Compressor, York Style Left Hand Suction, Rotolock Clutch Not Included Requires Synthetic Ester Oil 100V, See Manufacturer for Oil Quantity Double Groove Clutch for York Compressor, 7"	AMX10225	\$ 260.00	
	Premium Synthetic Ester Oil, 100V, 12 oz	AMX10273	\$ 11.00	
 9400 ASN 650101, 9500 ASN 650201, 9600 ASN 650301, CTS ASN 650401, Cotton Picker: 9930 BSN 14000 Replaces RE46657, TY6765	Compressor, Nippondenso Style 12 Volt, w/ Single Groove Clutch, 5.75" (146 mm) Clutch Diameter, Must use Original Manifold Requires Pag Oil 46V, 7.77 oz (230 cc)	AMX10141	\$ 325.00	
	Ultra Pag Double End Capped, 46V, 8 oz	AMX10266	\$ 12.00	
 9410, 9450, 9510, 9550, 9610, 9650, 9770STS, Swather: 4890 Replaces RE46609, TY6764, TY24304, RE69716	Compressor, Nippondenso Style 12 Volt, w/ 8-Groove Clutch for Serpentine Belt, 5.75" (146 mm) Clutch Diameter, Must use Original Manifold Requires Pag Oil ND8, 7.77 oz (230 cc)	AMX10139	\$ 250.00	
	Denso ND8 Pag Oil, 46V, 8.50 oz	AMX10272	\$ 30.00	
 Cotton Pickers: 9965 ASN 2001, 9970, 9976, Cotton Strippers: 7445 ASN 16001, 7450, Swathers: 3430 ASN 985001, 3830 ASN 978857 Replaces RE52454, RE55422, TY6784	Compressor, Nippondenso 10PA17C Style 12 Volt, w/ Single Groove Clutch, 5.748" (146 mm) Clutch Diameter, Must use Original Manifold Requires Pag Oil ND8, 7.77 oz (230 cc)	AMX10137	\$ 250.00	
	Denso ND8 Pag Oil, 46V, 8.50 oz	AMX10272	\$ 30.00	
 Forage Harvesters: (6610, 6710, 6810, 6910 - w/ ASN 500922), 6650, 6750, 6850, 6950, (7200, 7300, 7400, 7500, 7700, 7800 - w/ BSN 507478)	Compressor, Nippondenso 10PA15C Style 12 Volt, w/ 2-Groove Clutch, 5.33" (135 mm) Clutch Diameter	AMAZ44541	\$ 565.00	
 Swather: 2360 Replaces AW23886, AW24173	Compressor, Sanden SD510HD Style 12 Volt, w/ 2-Groove Clutch, 5.19" (132 mm) Clutch Diameter, Vertical #8 and #10 Flare Fittings, w/ R12 Charge Ports Requires Pag Oil 100V, 4.56 oz (135 cc)	AMX10126	\$ 200.00	
	Ultra Pag Double End Capped, 100V, 8 oz	AMX10267	\$ 12.00	
	Universal Pag Oil, 8 oz	AMX10274	\$ 8.25	
 Cotton Pickers: 7455, 7460, 9935, 9976 ASN 4001, 9986, 9996, Sprayer: 6700, Swathers: 4890, 4895 BSN 330015, 4990, 4995 BSN 330539	Compressor Manifold Use w/ RE52454 Compressor Includes Cap and Pressure Valve	AMRE69715	\$ 100.00	
 4420, 4425, 4435, 6620, 6622, 7720, 9500, 9600, CTS, Cotton Pickers: 9920, 9930, 9950, 9960, 9965, Sprayers: 6000, 6500, Swathers: 3430, 3830, Forage Harvesters: 5720, 5820, 5730, 5830, 6610, 6710, 6810, 6910	Compressor Clutch 5.75" w/ 12 Volt Coil, Single Groove, Standard 6E171, w/o Dust Cover	AMRE10975	\$ 125.00	

John Deere®—Combine

John Deere®—Combine

Application	Description	Part Number	Retail Price	Core
 <p>9410, 9450, 9510, 9510SH, 9550, 9550SH, 9560, 9560SH, 9610, 9640, 9650, 9650CTS, 9650STS, 9660, 9660CTS, 9660STS, 9680, 9750STS, 9760STS, 9860STS, CTS, CTS II, Cotton Pickers: 9935, 9986, 9996, Cotton Stripper: 7455, 7460, Forage Harvesters: (7200, 7300, 7400, 7500, 7700, 7800 ASN 507479), Sprayers: 4700, 4710, 4720, 4920, 6700, Swathers: 3430, 4890, 4895, 4990, 4995</p>	Compressor Clutch w/ Pulley 10PA17C Clutch w/ 12 Volt Coil, 5.70" 8-Groove Pulley w/o Dust Cover	AMRE52508	\$ 120.00	
 <p>Cotton Picker: 9965, Swathers: 3430, 3830</p>	Compressor Clutch w/ Pulley 10PA17C Clutch w/ 12 Volt Coil, 5.74" Single Groove Pulley	AMRE58348	\$ 110.00	
 <p>Universal Equipment</p>	High Pressure Switch Normally Open, Opens at 305 PSI, Closes at 395 PSI, 7/16"x20 Thread	AMX10276	\$ 35.00	
 <p>Universal Equipment</p>	Low Pressure Switch Normally Open, Opens at 6 PSI, Closes at 45 PSI, Standard 7/16"x20 Thread	AMX10277	\$ 55.00	
 <p>Universal Equipment</p>	Low Pressure Switch Normally Open, Opens at 35 PSI, Closes at 46 PSI, Standard 7/16"x20 Thread	AMX10278	\$ 42.00	
 <p>6600, 6620, 7700, 7720, 8820, Cotton Pickers: 9900, 9910, 9920, 9930, 9935, 9940, 9950, 9960, 9965, 9970, 9976, Cotton Strippers: 7440, 7445, 7450, 7455, Sprayer: 6600 Replaces AR59779</p>	Rotary Adjustable Thermostatic Switch 36" Capillary Tube	AMX10251	\$ 45.00	
 <p>6600, 6620, 6622, 7700, 7720, 7722, 9940, Forage Harvesters: 5200, 5400, 5440, 5460, 5720, 5820</p>	Clutch Saver Kit Protects Clutch from Slipping Due to Low Voltage, Maintains Adequate Voltage to Clutch Coil at all Times	AMX10252	\$ 25.00	
 <p>3300, 4400, 4420, 6600, 6620, 6622, 7700, 7720, 8820, Cotton Pickers: 9900 w/ Stolper Cab, 9910, 9920, 9930, 9935, Cotton Strippers: 7440, 7445, 7450, 7455 Replaces AH234098, AL77581, AR59780, AR59870, AR74486, RE49169, RE214439, RE291794</p>	Receiver Drier Receiver Drier, Import 4" x 7 1/2", Inlet - #6 Female O-Ring, Outlet - #6 Male O-Ring, R12 and R134a Compatible	AMX10154 AMX10208	\$ 25.00 \$ 22.00	
 <p>4425, 6620, 6620 Titan II, 6622, 7720, 7720 Titan II, 7722, 8820, 8820 Titan II, 9400, 9410, 9450, 9500, 9510, 9550, 9600, 9610, 9650, 9670STS, 9770STS, 9860STS, 9870STS, Cotton Pickers: 9940, 9950, 9960, 9970, 9976 Replaces AH234099, AT125596, AT162848, AXE53638</p>	Receiver Drier 4" x 9", Inlet - #6 3/8" Female O-Ring, Outlet - #6 3/8" Male O-Ring, R12 and R134a Compatible Replaces AH234099, AT125596, AT162848, AXE53638	AMX10156	\$ 36.00	
 <p>Sprayers: 4710, 4720, 4920</p>	Receiver Drier 3" x 11 1/2", Inlet - #6 3/8" Female O-Ring, Outlet - #6 3/8" Male O-Ring, R12 and R134a Compatible	AMRE214440	\$ 28.00	

Prices Subject to Change without Prior Notice. The use of original equipment manufacturer (OEM) part numbers or trademarks, e.g. Case® and John Deere®, are for reference purposes only and for indicating product use and compatibility. Our company and the listed replacement parts contained herein are not sponsored, approved or manufactured by the OEM. All parts are New unless designated Reman in the description.

John Deere®—Combine













	Application	Description	Part Number	Retail Price	Core
	484, Cotton Pickers: 9900, 9910 Replaces AR45882	Expansion Valve Internally Regulated w/ 12" Capacity Tube w/ Flare Connection, R12 and R134a Compatible	AMX10215	\$ 30.00	
	3300, 4400, 4420, 6600, 7700, Forage Harvesters: 5200, 5400, 5440, 5460, Swathers: 2250, 2270, 2280	Expansion Valve Bulb Type, R12 and R134a Compatible, 19" Tube Length, Flare Connection	AMX10146	\$ 20.00	
	4425, 4435, 6620, 6622, 7440, 7445, 7450, 7455, 7720, 7722, 8820, Cotton Pickers: 9920, 9930, 9935, 9940, 9950, 9960, 9965, 9970, 9976, Swathers: 3430, 3830	Expansion Valve, OEM Bulb Type Externally Equalized 9" Capillary Tube, R12 and R134a Compatible	AMRE206757	\$ 20.00	
	4425, 4435, 6620, 6622, 7720, 7722, 8820, Cotton Pickers: 9920, 9930, 9935, 9940, 9950, 9960, 9965, 9970, 9976, Cotton Strippers: 7440, 7445, 7450, 7455, Forage Harvesters: 5720, 5730, 5820, 5830, Swathers: 2320, 2420, 3430, 3830 Replaces AR58482, AH140818, RE206757	Expansion Valve Bulb Type, Externally Equalized, R12 and R134a Compatible, 14" Tube Length, O-Ring Connection	AMX10145	\$ 20.00	
	9400, 9410, 9450, 9500, 9510, 9550, (9560STS, 9560STS BSN 720100), 9600, 9610, 9650, 9650STS, 9660STS BSN 720300, 9750STS, 9760STS BSN 720400, CTS, Swather: 4890 Replaces AH122867, AH137702, AH203871	Expansion Valve Block Type, R12 and R134a Compatible, O-Ring Connection	AMX10150	\$ 26.00	
	9560STS ASN 720100, 9570STS, 9650STS, (9660STS, 9760STS ASN 720300), 9670STS, 9750STS, 9770STS, 9860STS ASN 720500, 9870STS, Cotton Pickers: 7660, 7760, CP690, Cotton Stripper: CS690, Forage Harvesters: 7180, 7250, 7280, 7350, 7380, 7450, 7480, 7550, 7580, 7750, 7780, 7850, 7950, 7980, Swathers: D450, R450	Expansion Valve	AMAH222255	\$ 40.00	
	Sprayers: 4700, 4710, 4720, 4730 BSN 014148, 4830 Early, 4920, 4930, 4940, R4030, R4038, R4044, R4045, R4060 Replaces AL160578, RE283957	Expansion Valve Flange Style, R12 and R134a Compatible	AMRE174764	\$ 20.00	
	Swather: 2360 Replaces CMX30213, AW23878	Expansion Valve Bulb Type, Externally Equalized, R12 and R134a Compatible, 28" Tube Length, O-Ring Connection	AMX10148	\$ 18.00	
	484, 1032, 1042, 1052, 1055, 1065, 1072, 1075, 1085, 2254, 4425, 6620, 6622, 7440, 7445, 7450, 7455, 7720, 7722, 8820, 9940, 9950, 9960, 9965, 9970, Forage Harvesters: 5720, 5730, 5820, 5830, Sprayers: 6000, 6100, 6500, 6600, 6700, Swathers: 2320, 2420, 3430, 3830	Blower Motor Update Kit Complete Assembly w/ Resistor Includes One Assembly for Models w/ Single Blower Motor 12 Volt, Mounting Base: 21" x 6 5/8"	AMAR82006	\$ 270.00	
	3300, 4400, 4420, 6600 1971-74, 7700, Forage Harvesters: 5200, 5400, (5440, 5460 BSN 490000), Swathers: 2250, 2270, 2280 Replaces AH80194	Blower Motor 3-Speed, Double Shaft, 4-Wire, Reversible, 3/8" Shaft Diameter, 4 1/4" Long	AMX10120	\$ 80.00	

John Deere®—Combine



	Application	Description	Part Number	Retail Price	Core
	3300, 4400 1971 and Later, 6600, 7700, Cotton Picker: 9900 Excel Cab, Forage Harvesters: 5200, 5400, Swathers: 2250, 2270 Replaces AH80698, AH81609, AH84394, AH88519	Blower Motor 12 Volt, Single Speed, Single Shaft, 2-Wire, Reversible, 5/16" Shaft Diameter, 1 1/2" Long	AMX10104	\$ 60.00	
	4425 ASN 017001, 4435 Replaces AL39043, AL110881, AL80700	Blower Motor	AMX10173	\$ 115.00	
	4425 BSN 017001, 6620, 6622, 7720, 8820, Cotton Pickers: 9910, 9920, 9930, 9935, 9940, 9950, 9960, 9965, 9970, 9976, Cotton Strippers: 7445, 7450, 7455, Forage Harvesters: 5720, 5730, 5820, 5830, Swathers: 2320, 2420, 3430, 3830 Replaces RE25160, AR82010, AR82005, RE13882, RE251028	Blower Motor Single Speed, Double Shaft, 2-Wire, Reversible, 3/8" Shaft Diameter, 5" Long	AMX10119	\$ 60.00	
	Swather: 2280, Forage Harvesters: 5440, 5460 Replaces AE40466	Blower Motor 12 Volt, Vented Motor, Reversible Single Speed, 2-Wire Motor w/ 3/8" Shaft	AMX10221	\$ 115.00	
	9400, 9410, 9450, 9500, 9510, 9550, 9600, 9610, 9650, Swathers: 4890, 4895, 4990, 4995 Replaces AH128926	Evaporator Heater Motor 12 Volt, Single Speed, Single Double Flat Shaft, 2-Wire, Reversible, 5/16" Shaft Diameter, 1 9/16" Long	AMX10174	\$ 90.00	
	Cotton Picker: 9986, Cotton Stripper: 7460, Forage Harvesters: 7200, 7300, 7400, 7500, 7700, 7800, Swathers: 4895, 4990, 4995 Replaces AH167731	Pressurizer Motor Single Speed, Single Shaft, 2-Wire, Clockwise, 5/16" Shaft Diameter, 1 3/8" Long	AMX10171	\$ 90.00	
	3300, 4400, 4420, 6600, 7700, Forage Harvesters: 5200, 5400, 5440, 5460, Swathers: 2250, 2270, 2280 BSN 490001	Blower Wheel, Steel 3.75" Diameter, 4" Long, 0.375" Shaft, Double Vented Replaces 83953316, E5NN18459AA, E5NN18459BA	AMH84107	\$ 13.00	
	4425, 6620, 6622, 7720, 8820, Cotton Pickers: 9910, 9920, 9930, 9935, 9940, 9950, 9960, 9965, 9970, 9976, Cotton Strippers: 7440, 7445, 7450, 7455, Sprayers: 6000 Hi-Cycle, 6100, 6500, 6600, 6700, Swathers: 2320, 2420, 3830, 3430, Forage Harvesters: 5720, 5730, 5820, 5830	Blower Wheel, Plastic 4" Diameter, 3/8" Shaft, Reversible, Double Vented, Clamps Not Included	AMR81111	\$ 25.00	
	484, 1032, 1042, 1052, 1055, 1065, 1072, 1075, 1085, 2254, 3300, 4400, 4420, 4425, 6600, 6602, 6620, 6622, 7440, 7445, 7450, 7455, 7700, 7720, 7722, 8820, 9940, 9950, 9960, 9965, 9970	Blower Motor Switch 3-Speed Replaces 168822C1, 168822C2, AH84588	AMX10261	\$ 16.00	
	4425, 4435, 6600, 6620, 7700, 7720, 8820, Swathers: 2250, 2270, 2280, Forage Harvesters: 5440, 5460, 5720, 5730, 5820, 5830	Condenser Core: 25 1/2" x 16" x 1 3/4"	AMAH87966	\$ 204.00	
	7720, 7820, 7920, Sprayer: 4720	Condenser w/ Fuel Cooler	AMRE181894	\$ 875.00	
	9400, 9410, 9450, 9500, 9510, 9550, 9600, 9610, 9650, 9660, 9660CTS, CTS, CTS II	Condenser Core: 26 1/2" x 13" x 3"	AMAH149618	\$ 450.00	
	9400, 9500, 9500SH, 9600, CTS	Condenser w/ Dual Oil Cooler Core: 22 1/2" x 33" x 5 1/8"	AMAH150219	\$ 915.00	

Prices Subject to Change without Prior Notice. The use of original equipment manufacturer (OEM) part numbers or trademarks, e.g. Case® and John Deere®, are for reference purposes only and for indicating product use and compatibility. Our company and the listed replacement parts contained herein are not sponsored, approved or manufactured by the OEM. All parts are New unless designated Reman in the description.

John Deere®—Combine

Application	Description	Part Number	Retail Price	Core
 9550, 9550SH, 9560, 9560SH, 9560STS, 9570STS, 9650, 9650CTS, 9650STS, 9660, 9660CTS, 9660STS, 9670STS, 9750STS, 9760STS, 9770STS, 9780CTS ASN 072800, 9860STS, 9870STS, C670, S550 SN 745100-764999, (S660, S670 ASN 745100), T550, T560, T660, T670, Cotton Pickers: 9976 ASN 006001, 9986, 9996	Condenser w/ Fuel Cooler	AMAH163522	\$ 550.00	
 9550 ASN 700201, 9560, 9560SH, 9560STS, 9570STS, 9650 ASN 695301, 9660, 9660CTS	Condenser w/ Oil Cooler	AMAH168467	\$ 1075.00	
 9960, 9965, 9970	Condenser w/ Oil Cooler	AMAN194102	\$ 1585.00	
 Cotton Pickers: 9940, 9950	Condenser w/ Oil Cooler Replaces AR75968	AMAR78958	\$ 1642.00	
 Forage Harvesters: 6610, 6650, 6710, 6750, 6850, 7250, 7300, 7350, (7400, 7500, 7700, 7800 ASN 507479), 7450, 7550, 7750, 7850, 7950	Condenser	AMRE28764	\$ 546.00	
 Forage Harvesters: 6750, 6810, 6850, 6910, 6950	Condenser	AMAZ43873	\$ 1818.00	
 Sprayers: 4730, 4830	Condenser w/ Fuel Cooler	AMRE226365	\$ 425.00	
 Sprayer: 4920	Condenser w/ Fuel and Oil Cooler Overall: 26" x 31" x 4" Core: 25 3/8" x 25" x 3 7/8" Replaces RE218194	AMRE222984	\$ 1200.00	
 Sprayer: 4940	Condenser	AMRE297792	\$ 825.00	
 Swather: A400	Condenser w/ Oil Cooler	AMAFH202216	\$ 2207.00	
 Swathers: W235, W260	Condenser w/ Oil Cooler	AMAFH210943	\$ 1015.00	
9400, 9410, 9450, 9500SH, 9500, 9510, 9510SH, 9550 BSN 700200, 9550SH BSN 700700, 9600	Charge Air Cooler Replaces AH136360, AH140474	AMAH151139	\$ 1285.00	
 9550 ASN 700201, 9550SH ASN 700701, 9560, 9560SH, 9560STS BSN 720100, 9650 ASN 695301, 9650CTS ASN 695401, 9660, 9660CTS	Charge Air Cooler Core: 34" x 12.50" x 5.20"	AMAH168353	\$ 2200.00	
 9560STS ASN 695501, (9660STS, 9760STS BSN 715400), Cotton Picker: 9996	Charge Air Cooler Replaces AH168324	AMAH219315	\$ 1730.00	

John Deere®—Combine

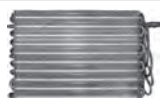
Application	Description	Part Number	Retail Price	Core
 9600 ASN 645301, 9610, 9650 BSN 695300, CTS, CTS II	Charge Air Cooler Replaces AH140473	AMAH149229	\$ 1675.00	
(9650STS, 9750STS BSN 695500)	Charge Air Cooler	AMAH145389	\$ 1450.00	
 Sprayers: 4730, 4830	Charge Air Cooler Core: 21 1/4" x 11 5/8" x 4"	AMRE226367	\$ 1525.00	
Sprayer: 4940	Charge Air Cooler Core: 10" x 38 1/8" x 5"	AMRE297789	\$ 1318.00	
	Charge Air Cooler Core: 10 1/4" x 38 1/4" x 5"	AMRE330648	\$ 1625.00	
 6620, 6622, 7720, 7722, 8820, Cotton Pickers: 9910, 9920, 9930, 9940, 9960, 9965, Forage Harvesters: 5720, 5730, 5820, 5830, Swathers: 2320, 2420, 3430, 3830	Evaporator Overall: 33 1/4" x 12 1/2" x 5" Core: 29" x 5" x 3 1/8" Replaces Evaporator on Early Models w/ separate heater core Tractors w/ Separate Heater Core Must Remove Roof Panel Spacer For Clearance	AMAR88076	\$ 150.00	
 Sprayers: 4730, 4830, 4930, 4940	Evaporator Flange Mount, O-Ring Connection Overall: 18" x 4 3/8" x 10" Core: 13 1/2" x 3 3/4" x 10" Replaces RE187311, RE286345, RE292236	AMRE327083	\$ 320.00	

Cornhead—Complete Polytin Kits



Mounting hardware is included with kits. Kits include snouts, dividers and fenders in light weight poly that never need paint.













Application	Description	Part Number	Retail Price	Core
443	4 Row - 30" Complete Assembly	AMPTJD430	\$ 2865.00	
643	6 Row - 30" Complete Assembly	AMPTJD630	\$ 4025.00	
843	8 Row - 30" Complete Assembly	AMPTJD830	\$ 5185.00	
1243	12 Row - 30" Complete Assembly	AMPTJD1230	\$ 7500.00	
444	4 Row - 36" Complete Assembly	AMPTJD436	\$ 3100.00	
643	6 Row - 36" Complete Assembly	AMPTJD636	\$ 4400.00	
844	8 Row - 36" Complete Assembly	AMPTJD836	\$ 5695.00	
1243	12 Row - 36" Complete Assembly	AMPTJD1236	\$ 7585.00	
444	4 Row - 38" Complete Assembly	AMPTJD438	\$ 3200.00	
644	6 Row - 38" Complete Assembly	AMPTJD638	\$ 4555.00	
844	8 Row - 38" Complete Assembly	AMPTJD838	\$ 5900.00	
444	4 Row - 40" Complete Assembly	AMPTJD440	\$ 3225.00	
644	6 Row - 40" Complete Assembly	AMPTJD640	\$ 4610.00	
844	8 Row - 40" Complete Assembly	AMPTJD840	\$ 5900.00	

John Deere®—Combine

Cornhead—Fenders and Snouts

















	Application	Description		Part Number	Retail Price	Core
	(243, 244, 343, 344, 443, 444, 543, 546, 643, 644, 645, 843, 1243 - Low-Profile ASN 380601)	Outer Fender, Right Hand	Poly	AMAH118342P	\$ 430.00	
			Steel	AMAH118342	\$ 880.00	
	(243, 244, 343, 344, 443, 444, 543, 546, 643, 644, 645, 842, 843 - High-Profile BSN 380600)	Outer Fender, Right Hand	Steel	AMAH82434	\$ 879.00	
	(243, 244, 343, 344, 443, 444, 483, 543, 546, 583, 642, 643, 644, 645, 683, 842, 843, 844, 883, 1243 - Low-Profile ASN 380601)	Outer Snout w/ Point, Right Hand	Poly	AMAH115402P	\$ 195.00	
		Outer Snout w/o Point, Right Hand	Steel	AMAH115402	\$ 271.00	
		Outer Snout w/o Point, Right Hand	Steel	AMAH109666	\$ 255.00	
	(243, 244, 343, 344, 443, 444, 543, 546, 643, 644, 645, 843, 1243 - Low-Profile ASN 380601)	Outer Fender, Left Hand	Poly	AMAH118343P	\$ 430.00	
			Steel	AMAH118343	\$ 880.00	
	(243, 244, 343, 344, 443, 444, 543, 546, 643, 644, 645, 842, 843 - High-Profile BSN 380600)	Outer Fender, Left Hand	Steel	AMAH82435	\$ 879.00	
	(243, 244, 343, 344, 443, 444, 483, 543, 546, 583, 642, 643, 644, 645, 683, 842, 843, 844, 883, 1243 - Low-Profile ASN380601)	Outer Snout w/ Point, Left Hand	Poly	AMAH115403P	\$ 195.00	
		Outer Snout w/o Point, Left Hand	Steel	AMAH115403	\$ 271.00	
		Outer Snout w/o Point, Left Hand	Steel	AMAH109667	\$ 255.00	
	243, 244, 343, 344, 443, 444, 543, 546, 642, 643, 644, 645, 842, 843, 844, 1243 - 30"	Narrow Row Center Snout w/ Point Poly to Replace Steel	Poly	AMAH129764P	\$ 180.00	
		Narrow Row Center Snout w/ Point Poly to Replace Poly	Poly	AMAH129764PK	\$ 200.00	
		Narrow Row Center Snout w/o Point	Steel	AMAH129764	\$ 180.00	
	(493, 494, 594, 693, 694, 893, 894, 1290, 1291, 1293, 1294 ASN 695301)	Narrow Row Center Snout	Poly	AMAH168313	\$ 250.00	
	(493, 693, 893, 1293 BSN 695300)	Narrow Row Center Snout w/ Stainless Steel Wear Strips Replaces AH141626	Poly	AMAH146577	\$ 430.00	

John Deere®—Combine

Application	Description	Part Number	Retail Price	Core
 600 BSN 745100, 606, 606C, 608, 608C, 608FC ASN 129189, 612, 612C, 612FC, 616, 616C, 706C, 708C, 708FC, 712C, 712FC, 716C, C6R, C8R, C12F, C12R, C16F, C16R	Narrow Row Center Snout	Poly AMAXE10905	\$ 285.00	
243, 244, 343, 344, 443, 444, 543, 546, 642, 643, 644, 645, 842, 843, 844, 1243 - 36", 38", 40"	Wide Row Center Snout w/ Point	Poly AMAH129766P	\$ 220.00	
	Wide Row Center Snout w/o Point	Poly on Poly AMAH129766PK Steel AMAH129766	\$ 220.00 \$ 175.00	
 Models w/ Polylin Snouts	Wear Plate, Stainless Steel	Right Hand AMX27289 Left Hand AMX27288	\$ 23.00 \$ 23.00	
 (493, 693, 893, 1293 BSN 695300)	Wear Strip, Stainless Steel For Inner Gathering Point	Right Hand AMAH146577WSR	\$ 33.00	
		Left Hand AMAH146577WSL	\$ 33.00	
 600, 606, 606C, 608, 608C, 612, 612C, 612FC, 616, 616C, 618, 618C, 706C, 708C, 708FC, 712C, 712FC, 718C	Wear Strip (4) Required on Inner Snouts (2) Required on Outer Snouts	AMH228917	\$ 2.75	
 244, 343, 344, 443, 444, 493, 494, 543, 546, 594, 606, 606C, 608, 608C, 608FC, 612, 612C, 612FC, 616, 616C, 618, 618C, 642, 643, 644, 645, 692, 693, 693SH, 694, 706C, 708C, 708FC, 712C, 712FC, 716C, 718C, 842, 843, 844, 892, 893, 894, 1092, 1243, 1290, 1291, 1293 - w/ Perm-Glide™	Wear Tip Replaces H115596	AMH148121	\$ 26.87	
 243 BSN 1001, 244 BSN 5501, (343, 643 BSN 4001), 344 BSN 2001, 443 BSN 4501, 444 BSN 11001, (546, 644, 645, 843 BSN 1501)	Wear Tip For Steel Center Snout Replaces H135290	AMH84480	\$ 23.00	
 (244, 343, 344, 443, 444, 543, 546, 642, 643, 644, 645, 842, 843, 844, 1243 - w/ Perm-Glide™), 493, 494, 594, 606, 606C, 608, 608C, 608FC, 612, 612C, 612FC, 616, 616C, 618, 618C, 692, 693, 693SH, 694, 706C, 708C, 708FC, 712C, 712FC, 716C, 718C, 892, 893, 894, 1092, 1290, 1291, 1293	Poly Replacement Tip	AMH148121P	\$ 18.00	
 443, 444, 444SH, 543, 546, 642, 643, 643SH, 644, 645, 842, 843, 844, 894, 1243	Wear Tip For Polylin	Poly AM71364963NP Cast AM71364963A	\$ 27.00 \$ 19.00	
	Wear Tip For Steel Divider Point	Cast AM71364963	\$ 40.00	
	Center Divider, Wide	Right Hand AMAH118340	\$ 163.00	
 443, 444, 444SH, 543, 546, 642, 643, 643SH, 644, 645, 842, 843, 844, 894, 1243	Center Divider, Narrow	Right Hand AMAH118338	\$ 262.00	
	Center Divider, Narrow	Left Hand AMAH118339	\$ 262.00	
 Poly Models Prior to 1998	Ear Saver, Poly	Inside AMX27174	\$ 12.75	
	Ear Saver, Poly (1) Inside and (1) Outside Required per Row	Outside AMX27175	\$ 12.75	

John Deere®—Combine

John Deere®—Combine

	Application	Description		Part Number	Retail Price	Core
	606C, 608C, 608FC, 612C, 612FC, 616C, 618C, 706C, 708C, 708FC, 712C, 712FC, 716C, 718C - 1998 and Later	Ear Saver, Poly (2) Required per Row Replaces H226324, HXE33313		AMX27176	\$ 12.75	
	243, 244, 343, 344, 443, 444, 543, 546, 642, 643, 644, 645, 842, 843, 844, 1243	Ear Saver, Poly (2) Required per Row		AMX27178	\$ 12.75	
	243, 244, 343, 344, 443, 444, 493, 494, 543, 546, 594, 642, 643, 644, 645, 692, 693, 693SH, 694, 842, 843, 844, 892, 893, 894, 1092, 1243, 1290, 1291, 1293	Ear Saver, Rubber	Inside	AMH166582	\$ 3.79	
	493, 494, 594, 692, 693, 693SH, 694, 892, 893, 894, 1092, 1290, 1291, 1293	Ear Saver Rubber (2) per machine on fender		AMH148223	\$ 3.75	
	493, 494, 594, 692, 693, 693SH, 694, 892, 893, 894, 1092, 1290, 1291, 1293	Ear Saver		AMH166581	\$ 5.00	
	493, 494, 594, 692, 693, 694, 892, 893, 894, 1092, 1290, 1291, 1293, 1294 BSN 676000	Ear Saver	Outside	AMH148222	\$ 4.30	
	(606, 608, 612 BSN 745100)	Ear Saver	Inside	AMHXE33313	\$ 3.82	
	(606, 608, 612 BSN 745100)	Ear Saver	Outside	AMHXE38892	\$ 3.23	
	606, 608, 612	Ear Saver Replaces HXE33313	Inner	AMH226324	\$ 4.73	
	606, 608, 612, 616, 618	Ear Saver	Outer	AMH226325	\$ 5.32	
	Models w/ Metal Heads For Narrow Rows Only	Poly Skid Bubble Tip	Outside Snout	AMX27144	\$ 18.50	
			Inside Snout	AMX27145	\$ 18.50	
	Models w/ Poly Snout For Narrow Rows Only	Poly Skid Bubble Tip	Outside Snout	AMX27150	\$ 18.50	
	Models w/ Poly Snout For Narrow Rows Only	Poly Skid Bubble Tip	Inside Snout	AMX27151	\$ 18.50	
	Most Models	Poly Gathering Chain Guard Green, 8.90" x 23" Includes Hardware		AMX27154	\$ 22.50	
	Models w/ Polytin Kits	Wear Strip, Stainless Steel For Fender Snout	Right Hand	AMX27314	\$ 23.00	
			Left Hand	AMX27313	\$ 23.00	
	Models w/ Polytin Kits - 40" Row	Divider, Center	Poly on Poly	AMX27322PK	\$ 470.00	
	443, 643, 843, 1243 - 30"	Divider Assembly, Center Poly on Poly		AMX27185	\$ 425.00	
	493, 693, 893, 1293	Divider, Center Rear Replaces AH141628		AMAH160065	\$ 420.00	

John Deere®—Combine

Cornhead—Auger Liners

Application	Description	Part Number	Retail Price	Core
30" Row	4 Row Poly Auger Liner	AMX27129	\$ 260.00	
30" Row	6 Row Poly Auger Liner	AMX27130	\$ 299.00	
30" Row	8 Row Poly Auger Liner	AMX27131	\$ 367.00	
30" Row	12 Row Poly Auger Liner	AMX27132	\$ 578.00	

Cornhead—Stalk Stompers and Components

600 and 700 Series kits include header mounting brackets (accommodates 5" - 6" main beam), 12" stalk stomper shoes, stalk stomper torsion mounts, end support kit, u-bolts and mounting hardware. 40 and 90 Series kits (excluding Quick Disconnect) include header mounting brackets, 12" stalk stomper shoes, stalk stomper torsion mounts, u-bolts and mounting hardware. All kits (excluding Quick Disconnect) require 2" x 2" square tool bar.

Application	Description	Part Number	Retail Price	Core
642, 643, 644, 645, 693, 694, 842, 843, 893, 1092, 1243, 1293 - Excluding 8 Row w/ 36" or Wider Row Widths	Stalk Stomper Kit, Quick Disconnect	AMX27329	\$ 706.50	
606, 606C, 608, 608C, 612, 612C, 616, 618, 618C, 708C, 712C, 716C, 718C	Stalk Stomper Kit, 2 Row Covers 1 Row on Each Side of Cornhead For Optional End Support Kit See AMX30016	AMX31018	\$ 1200.00	
	Stalk Stomper Kit, 4 Row Covers 2 Rows on Each Side of Cornhead For Optional End Support Kit See AMX30016	AMX31019	\$ 1600.00	
	Stalk Stomper Kit, 6 Row Covers 3 Rows on Each Side of Cornhead For Optional End Support Kit See AMX30016	AMX31020	\$ 2225.00	
608, 608C, 612, 612C, 616, 618, 618C, 708C, 712C, 716C, 718C	Stalk Stomper Kit, 8 Row Covers 4 Rows on Each Side of Cornhead	AMX31021	\$ 2775.00	
612, 612C	Stalk Stomper Kit, 12 Row Kit Mounts in 3 Sections	AMX31022	\$ 3650.00	
612FC	Stalk Stomper Kit, 12 Row Folding Head Kit Mounts in 3 Sections	AMX31023	\$ 3975.00	
616, 618, 618C, 716C, 718C	Stalk Stomper Kit, 16 Row Kit Mounts in 3 Sections	AMX31024	\$ 4225.00	
618, 618C, 718C	Stalk Stomper Kit, 18 Row	AMX31025	\$ 4875.00	
344, 443, 444, 493, 494, 594, 642, 643, 644, 645, 693, 694, 842, 843, 844, 893, 894, 1243, 1290, 1293	Stalk Stomper Kit, 2 Row Covers 2 Outer Rows of Cornhead	AMX31026	\$ 950.00	
443, 444, 493, 494, 594, 642, 643, 644, 645, 693, 694, 842, 843, 844, 893, 894, 1243, 1290, 1293	Stalk Stomper Kit, 4 Row Covers 4 Outer Rows of Cornhead	AMX31027	\$ 1450.00	
642, 643, 644, 645, 693, 694, 842, 843, 844, 893, 894, 1243, 1290, 1293	Stalk Stomper Kit, 6 Row Covers 2 Inner Rows and 4 Outer Rows of Cornhead	AMX31028	\$ 2025.00	
	Stalk Stomper Kit, 6 Row Covers 6 Outer Rows of Cornhead	AMX31029	\$ 1950.00	
842, 843, 844, 893, 894, 1243, 1290, 1293	Stalk Stomper Kit, 8 Row Covers 2 Inner Rows and 6 Outer Rows of Cornhead	AMX31030	\$ 2575.00	
1243, 1290, 1293	Stalk Stomper Kit, 12 Row Covers 2 Inner Rows and 10 Outer Rows of Cornhead	AMX31031	\$ 3625.00	
606, 606C, 608, 608C, 612, 612C, 616, 618, 618C, 708C, 712C, 716C, 718C	Header Mounting Bracket Use w/ AMX30015 Vertical Bracket	AMX30014	\$ 120.00	
	Vertical Bracket Use w/ AMX30014 Header Mounting Bracket	AMX30015	\$ 72.00	

John Deere®—Combine

John Deere®—Combine

Application	Description	Part Number	Retail Price	Core
344, 443, 444, 493, 494, 594, 606, 606C, 608, 608C, 612, 612C, 616, 618, 618C, 642, 643, 644, 645, 693, 694, 708C, 712C, 716C, 718C, 842, 843, 844, 893, 894, 1243, 1290, 1293	Single Row Shoe, 12" Includes Torsion Mounting Bracket	AMX30000	\$ 320.00	
	Replacement Shoe, 12" Torsion Mounting Bracket Not Included	AMX30002	\$ 125.00	
	Stalk Stomper Torsion Unit	AMX30005	\$ 160.00	
	Tool Bar 2" x 2" Square, 72" Long, 3/16" Sidewall Thickness	AMX30003	\$ 75.00	
606, 606C, 608, 608C, 612, 612C, 616, 618, 618C, 708C, 712C, 716C, 718C, 1243, 1290, 1293	Tool Bar 2" x 2" Square, 102" Long, 3/16" Sidewall Thickness	AMX30004	\$ 105.00	
608, 608C, 612, 612C, 616, 618, 618C, 708C, 712C, 716C, 718C, 1243, 1290, 1293	Tool Bar Splice Bracket Use to splice 2 Tool Bars together to add extended length for various row spacing and additional rows	AMX30006	\$ 42.00	
606, 606C, 608, 608C, 612, 612C, 616, 618, 618C, 708C, 712C, 716C, 718C	End Support Kit	AMX30016	\$ 130.00	

Cornhead—Hydraulic Deck Plate Kits

Kits include components to connect your cornhead to adjustable hydraulic deck plates.



Application	Description	Part Number	Retail Price	Core
443	Hydraulic Deck Plate Kit 40 Series, 4 Row 30"	AMX27512	\$ 2050.00	
493	Hydraulic Deck Plate Kit 90 Series, 4 Row 30"	AMX27504	\$ 1975.00	
643	Hydraulic Deck Plate Kit 40 Series, 6 Row 30"	AMX27513	\$ 2800.00	
693	Hydraulic Deck Plate Kit 90 Series, 6 Row 30"	AMX27505	\$ 2850.00	
843	Hydraulic Deck Plate Kit 40 Series, 8 Row 30"	AMX27514	\$ 3700.00	
893	Hydraulic Deck Plate Kit 90 Series, 8 Row 30"	AMX27506	\$ 3700.00	
1243	Hydraulic Deck Plate Kits 40 Series, 12 Row 30"	AMX27511	\$ 5400.00	
1293	Hydraulic Deck Plate Kit 90 Series, 12 Row 30"	AMX27503	\$ 5450.00	

Cornhead—Row Unit Components

Row Unit Gearboxes

Application	Description	Part Number	Retail Price	Core
443, 444, 444SH, 493, 494, 543, 546, 592, 594, 642, 643, 643SH, 644, 645, 692, 693, 694, 842, 843, 844, 892, 893, 894, 1092, 1243, 1290, 1291, 1293	Gearbox, Complete	AMAH209794	\$ 1375.00	
600, 606, 606C, 608, 608C, 612, 612C BSN 745100	Row Unit Gearbox Replaces DE20087	AMDE30412	\$ 3760.00	

Cornhead—Row Unit Components



John Deere®—Combine

Gearbox Components

Application	Description	Part Number	Retail Price	Core
243, 244, 343, 344, 443, 444, 493, 494, 543, 546, 594, 642, 643, 644, 645, 693, 694, 842, 843, 844, 892, 893, 894, 1243, 1290, 1291, 1293	Bearing Cap Includes Bushings For Row Unit Gearbox Replaces AN102512	AMAH87787	\$ 42.49	
 693, 694, 893, 894, 1293, 1693	Drive Shaft For Row Unit Gearbox	AMAH148769	\$ 103.00	
 243, 244, 343, 344, 443, 444, 493, 494, 543, 546, 594, 642, 643, 644, 645, 843, 844, 1243, 1290, 1291, 1293	Gear Assembly For Stalk Roll Drive Replaces AN102004	AMAH146441	\$ 230.00	
 243, 244, 343, 344, 443, 444, 493, 493, 543, 546, 594, 642, 643, 644, 645, 692, 693, 693SH, 694, 842, 843, 844, 892, 893, 894, 1243, 1290, 1291, 1293	Input Gear 17 Tooth	AMH107779	\$ 95.00	
 243, 244, 343, 344, 443, 444, 493, 494, 543, 594, 642, 643, 644, 645, 692, 693, 694, 842, 843, 844, 892, 893, 894, 1243, 1290, 1291, 1293	Row Unit Countershaft 0.872" Diameter, 7.87" Long	AMN102024	\$ 25.83	
243, 244, 343, 344, 443, 444, 493, 494, 543, 546, 594, 642, 643, 644, 645, 692, 693, 694, 842, 843, 844, 892, 893, 894, 1243, 1290, 1291, 1293	Row Unit Gearbox Housing Replaces AH144191, AN102014, AN102430	AMH220669	\$ 396.07	
 243, 244, 343, 344, 443, 444, 483, 493, 494, 543, 546, 583, 594, 642, 643, 644, 645, 683, 692, 693, 693SH, 694, 842, 843, 844, 883, 892, 893, 894, 1092, 1243, 1290, 1291, 1293	Stalk Roll Barrel, Binocular	AMAH84853	\$ 265.00	
 443, 444, 444SH, 493, 494, 543, 546, 592, 594, 642, 643, 643SH, 644, 645, 692, 693, 694, 842, 843, 844, 892, 893, 894, 1092, 1243, 1290, 1291, 1293	Stalk Roll Shaft Replaces AN102001	AMAH143881	\$ 75.00	
 (493, 494, 594, 692, 693, 694, 892, 893, 894, 1092, 1290, 1291, 1293 ASN 705101), (606C, 608C, 612C BSN 745101)	Slip Clutch Hub 12 Tooth, 2.14" Wide, 3.57" OD, 1 1/4" Hex Bore	AMH206755	\$ 120.62	
(592, 693, 694, 893, 894, 1092, 1290, 1291, 1293 ASN 665401)	Slip Clutch Hub	AMH154122	\$ 114.67	
606, 608, 612	Hub 3.734" OD, 2.75" Bolt Hole Centers OD, 1.256" Hex Bore For Row Unit	AMH223362	\$ 37.85	
 443, 444, 444SH, 493, 494, 543, 546, 592, 594, 642, 643, 643SH, 644, 645, 692, 693, 694, 842, 843, 844, 892, 893, 894, 1092, 1243, 1290, 1291, 1293	Slip Clutch Hub 1 1/8" Hex Bore	AMN102036	\$ 45.00	
 243, 244, 343, (444, 543, 643, 644, 645, 843 ASN 322700), (592, 693, 694, 893, 894, 1092, 1290, 1291, 1293 BSN 665200), (606C, 608C, 612C BSN 745101), 1243 ASN 471047	Slip Clutch Jaw	AMN102023	\$ 37.95	











Cornhead—Row Unit Components

John Deere®—Combine

John Deere®—Combine









John Deere®—Combine

Cornhead—Row Unit Components

	Application	Description	Part Number	Retail Price	Core
	(493, 494, 594, 692, 693, 694, 892, 893, 894, 1092, 1290, 1291, 1293 ASN 705100)	Slip Clutch Quick Coupler	AMH206870	\$ 54.80	
	243, 244, 343, 344, 443, 444, 494, 543, 642, 643, 644, 692, 693, 694, 842, 843, 844, 892, 893, 894, 1290, 1291, 1293	Slip Clutch Quick Coupler	AMN102040	\$ 70.99	
	443, 444, 643, 644, 693, 694, 843, 844, 893, 894, 1243, 1293, 1294,	Clutch Assembly	AMAH146250	\$ 220.00	
	243, 244, 343, 344, 443, 444, 493, 494, 543, 546, 594, 642, 643, 644, 645, 693, 693SH, 694, 842, 843, 844, 892, 893, 894, 1092, 1243, 1290, 1291, 1293	Ball Bearing, Stalk Roll Pinion Shaft	AMJD9415	\$ 17.00	
	443, 444, 444SH, 493, 494, 543, 546, 592, 594, 642, 643, 643SH, 644, 645, 692, 693, 694, 842, 843, 844, 892, 893, 894, 1092, 1243, 1290, 1291, 1293	Drive Sprocket Shaft Oil Seal	AMAN71326	\$ 3.00	
	243, 244, 343, 344, 443, 444, 493, 494, 543, 546, 594, 642, 643, 644, 645, 692, 693, 694, 842, 843, 844, 892, 893, 894, 1243, 1290, 1291, 1293	Idler Gear	AMAH93577	\$ 118.23	
	(243, 244, 343, 344, 443, 444, 642, 643, 644, 645, 842, 843, 844 BSN 416851), 493, 494, 594, 692, 693, 694, 892, 893, 894, 1243 ASN 470496, 1290, 1291, 1293	Input Cap Shim, 0.01"	AMN102008	\$ 1.83	
	243, 244, 343, 344, 443, 444, 483, 493, 494, 543, 546, 583, 642, 643, 644, 645, 683, 692, 693, 694, 842, 843, 844, 883, 892, 893, 894, 1092, 1243, 1290, 1293	Input Spur Gear Oil Seal	AMAN102006	\$ 10.00	
	243, 244, 343, 344, 443, 444, 493, 494, 543, 546, 594, 642, 643, 644, 645, 692, 693, 694, 842, 843, 844, 892, 893, 894, 1243, 1290, 1291, 1293	Input Spur Gear Thrust Washer	AMN102032	\$ 10.49	
	243, 244, 343, 344, 443, 444, 493, 494, 543, 594, 642, 643, 644, 645, 692, 693, 694, 842, 843, 844, 892, 893, 894, 1243, 1290, 1291, 1293	Needle Bearing 2" ID, 2.378" OD, 0.995" Wide For Row Unit Gearbox	AMJD8896	\$ 20.00	
	243, 244, 343, 344, 443, 444, 493, 494, 543, 594, 642, 643, 644, 645, 692, 693, 694, 842, 843, 844, 892, 893, 894, 1243, 1290, 1291, 1293	Needle Bearing 1" ID, 1.3125" OD, 0.75" Wide For Row Unit Gearbox Replaces JD9974	AMJD8877	\$ 8.00	
	443, 444, 444SH, 493, 494, 543, 546, 592, 594, 642, 643, 643SH, 644, 645, 692, 693, 694, 842, 843, 844, 892, 893, 894, 1092, 1243, 1290, 1291, 1293	Stalk Roll Barrel Bearing & Seal Kit Includes (2) Needle Bearings, (2) Ball Bearings and (2) Seals	AMX27109	\$ 45.00	
	443, 444, 444SH, 493, 494, 543, 546, 592, 594, 642, 643, 643SH, 644, 645, 692, 693, 694, 842, 843, 844, 892, 893, 894, 1092, 1243, 1290, 1291, 1293	Stalk Roll, Seal	AMAN102266	\$ 6.00	

John Deere®—Combine

Row Unit Components

	Application	Description	Part Number	Retail Price	Core
	243, 244, 343, 344, 443, 444, 483, 493, 494, 543, 546, 583, 594, 642, 643, 644, 645, 683, 692, 693, 693SH, 694, 842, 843, 844, 883, 892, 893, 894, 1092, 1243, 1290, 1291, 1293	Chain and Sprocket Kit Includes Chain, Hex Drive Sprocket and Greaseable Idler	AMX27128	\$ 50.00	
		Chain and Sprocket Kit Includes Chain, Hex Drive Sprocket and Non-Greaseable Idler	AMX27126	\$ 50.00	
	443, 444, 444SH, 493, 494, 543, 546, 592, 594, 642, 643, 643SH, 644, 645, 692, 693, 694, 842, 843, 844, 892, 893, 894, 1092, 1243, 1290, 1291, 1293	Chain Paddle Kit (32) Paddles, Hardware and Instructions Replaces H209897, H209898	AMH201762	\$ 65.00	
	243, 244, 343, 344, 443, 444, 483, 493, 494, 543, 546, 583, 594, 642, 643, 644, 645, 683, 692, 693, 693SH, 694, 842, 843, 844, 883, 892, 893, 894, 1092, 1243, 1290, 1291, 1293	Gathering Chain Sprocket 8 Tooth, 1" Hex Bore	AMH85252	\$ 14.00	
	243, 244, 343, 344, 443, 444, 483, 493, 494, 543, 546, 583, 594, 642, 643, 644, 645, 683, 692, 693, 693SH, 694, 842, 843, 844, 883, 892, 893, 894, 1092, 1243, 1290, 1291, 1293 Replaces AN102009	Gathering Chain, Black 48 Links, 8 Lug 2.63" Wide Attachment Links	AMCHG-100	\$ 30.00	
	243, 244, 343, 344, 443, 444, 483, 493, 494, 543, 546, 583, 594, 642, 643, 644, 645, 683, 692, 693, 693SH, 694, 842, 843, 844, 883, 892, 893, 894, 1092, 1243, 1290, 1291, 1293, 1693	Idler Sprocket, Greaseable 8 Tooth, 0.65" ID	AMAH101219	\$ 12.50	
		Idler Sprocket, Non-Greaseable 8 Tooth, 0.65" ID	AMAN102448	\$ 12.50	
	243, 244, 343, 344, 443, 444, 493, 494, 543, 546, 594, 642, 643, 644, 645, 692, 693, 694, 842, 843, 844, 892, 893, 894, 1092, 1243, 1290, 1291, 1293	Cap w/ Grease Zerk	AMAH204016	\$ 7.38	
	(606, 606C, 608, 608C, 612, 612C BSN 745100)	Chain and Sprocket Kit Includes AMAH208978 Cornhead Chain (Chrome Pins), AMH233287 Drive Sprocket and AMAH231386 Idler Sprocket	AMX27283	\$ 120.00	
	(606, 606C, 608, 608C, 612, 612C ASN 745101), (608FC, 706C, 708C, 708FC, 712C, 712FC, 716C, 718C ASN 129189), 612FC, 616, 616C, 618, 618C	Drive Sprocket Kit Includes Drive Sprocket and V-Ring Seals	AMKXE10488	\$ 38.84	
	(606, 608, 612 BSN 745100)	Gathering Chain Black Pin	AMAH233138	\$ 78.00	
	(606, 606C, 608, 608C, 612, 612C BSN 745100)	Idler Sprocket	AMAH231386	\$ 35.00	















Cornhead—Row Unit Components

John Deere®—Combine

John Deere®—Combine

John Deere®—Combine

Cornhead—Row Unit Components

	Application	Description	Part Number	Retail Price	Core
	(606, 606C, 608, 608C, 612C ASN745101), 608FC ASN129189, 616, 616C, 618, 618C	Idler Sprocket Replaces AXE18770	AMAXE63766	\$ 30.00	
	(606, 608, 612, 616, 618 BSN 756330)	Sprocket 6 Tooth For Row Unit	AMAXE36872	\$ 46.02	
	(606, 606C, 608, 608C, 612, 612C BSN 745100)	Cornhead Chain, Chrome Pins	AMAH208978	\$ 50.00	
	(606, 606C, 608, 608C, 612, 612C ASN 745100), 608FC	Chain Guide Latch, Right Hand	AMH237841	\$ 35.49	
	ASN 129188, 612FC, 616, 616C, 618, 618C, 706C, 708, 708FC, 712, 712FC, 716C, 718C	Chain Guide Latch, Left Hand	AMH237885	\$ 35.49	
	(606, 606C, 608, 608C, 612, 612C BSN 745100)	Drive Sprocket	AMH233287	\$ 32.00	
	(606, 608, 612, 616, 618 ASN 745101)	Chain and Sprocket Kit	AMX29123	\$ 115.00	
	(606C, 608C, 612C ASN 745100), 612FC, 616, 616C, 618, 618C, 706C, 708C, 708FC, 712C 712FC, 716C, 718C	Gathering Chain Chrome Pins Replaces AXE61091	AMAH234578	\$ 65.00	
	(606, 606C, 608, 608C, 612, 612C ASN 745101), 612FC, 616, 616C, 618, 618C, 706C, 708C, 708FC, 712C, 712FC, 716C, 718C	Gathering Chain RowMax™ Chrome Pin	AMAXE62423	\$ 92.00	
	(606, 606C, 608, 608C, 612, 612C ASN 745100 w/ RowMax™), 12FC, 706C, 708C, 708FC, 712C, 712FC, 716C, 718C, (616, 616C, 618, 618C - w/ RowMax™)	Idler Sprocket 8 Tooth, 0.512" Bore Diameter	AMAXE62424	\$ 27.52	
	(606, 608, 612, 616, 618 ASN 756331)	Sprocket Kit Includes (1) Sprocket and (2) V-Ring Seals For Row Unit Drive	AMKXE10258	\$ 34.00	
	(243, 244, 343, 344, 443, 444, 483, 543, 546, 583, 642, 643, 644, 645, 683, 842, 843, 844, 883, 1243 ASN 466451)	Deck Plate, Right and Left Hand 27 1/2" Long	AMH94952	\$ 18.50	
	(243, 244, 343, 344, 443, 444, 543, 546, 642, 643, 644, 645, 842, 843, 844, 1243 BSN 466451)	Deck Plate, Right Hand 25 3/16" Long	AMN102068	\$ 18.50	
		Deck Plate, Left Hand 25 3/16" Long	AMN102069	\$ 18.50	
	493, 592, 594, 692, 693, 694, 892, 893, 894, 1092, 1290, 1291, 1293	Deck Plate, Right and Left Hand	AMH154270	\$ 22.50	

John Deere®—Combine

Cornhead—Row Unit Components

	Application	Description	Part Number	Retail Price	Core
	493, 592, 594, 692, 693, 694, 892, 893, 894, 1092, 1290, 1291, 1293	Deck Plate, Left Hand Hydraulic Adjust	AMAH147773	\$ 65.00	
	493, 592, 594, 692, 693, 694, 892, 893, 894, 1092, 1290, 1291, 1293	Deck Plate Cover, Left Hand Hydraulic Adjust	AMAH140825	\$ 45.00	
	606, 608, 612	Deck Plate Knife, Right Hand	AMH234210	\$ 46.65	
		Deck Plate Knife, Left Hand	AMH234211	\$ 43.36	
	(606, 606C, 608, 608C, 612, 612C BSN 745100)	Deck Plate w/ Lip - Adjustable	AMAXE17618	\$ 65.00	
	(606, 606C, 608, 608C, 612, 612C BSN 745100)	Deck Plate w/ Lip - Fixed	AMHXE24566	\$ 45.00	
	(606, 608, 608C, 612, 612C ASN 745101), 606C, 612FC, 616, 616C, 618, 618C, 706C, 708C, 708FC, 712C, 712FC, 716C, 718C	Deck Plate, Adjustable	AMAH234656	\$ 74.20	
	606, (606C, 608C, 612, 612C ASN 745100), 608, 608FC ASN 129188, 612FC, 616, 616C, 618, 618C, 706C, 708C, 708FC, 712C, 712FC, 716C, 718C	Deck Plate, Fixed	AMH237437	\$ 47.35	
	(606, 606C, 608, 608C, 612, 612C BSN 745100)	Deck Plate, Hardfaced - Adjustable	AMAH232250	\$ 70.00	
	(606, 606C, 608, 608C, 612, 612C BSN 745100)	Deck Plate, Hardfaced - Fixed	AMH225719	\$ 45.00	
	606, 608, 612, 693, 694, 893, 894, 1293, 1693	Deck Plate Indicator Shaft	AMR111692	\$ 30.27	
	443, 444, 444SH, 493, 494, 543, 546, 592, 594, 642, 643, 643SH, 644, 645, 692, 693, 694, 842, 843, 844, 892, 893, 894, 1092, 1243, 1290, 1291, 1293	Stalk Roll, Right Hand Straight Roll, 1-Bolt Mounting	AMH104090	\$ 80.00	
		Stalk Roll, Left Hand Straight Roll, 1-Bolt Mounting	AMH104091	\$ 80.00	
	493, 494, 594, 643, 692, 693, 694, 892, 893, 894, 1092, 1290, 1291, 1293	Stalk Roll, Right Hand	AMH148320	\$ 85.00	
		Stalk Roll, Left Hand	AMH148321	\$ 85.00	
	493, 592, 594, 692, 693, 694, 892, 893, 894, 1092, 1290, 1291, 1293 - w/ Straight Cast Rolls	Stalk Roll, Right Hand 2-Bolt Mounting	AMH150138	\$ 90.00	
		Stalk Roll, Left Hand 2-Bolt Mounting	AMH150139	\$ 90.00	
	443, 444, 643, 644, 693, 694, 843, 844, 893, 894, 1243, 1293, 1693	Stalk Roll Knife, Right Hand	AMH150690	\$ 110.00	
		Stalk Roll Knife, Left Hand	AMH150691	\$ 110.00	
	606C, 608C, 612C, 616C, 618C, 706C, 708C, 708FC, 712C, 712FC, 716C, 718C	Stalk Chopping Knife Heat Treated, Tungsten Carbide	AMHXE36504	\$ 20.50	
	606C, 608C, 612C, 616C, 618C, 706C, 708C, 708FC, 712C, 712FC, 716C, 718C	Bushing, Chopping Gearbox Blades	AMHXE24237	\$ 10.65	

John Deere®—Combine

John Deere®—Combine





John Deere®—Combine

Cornhead—Row Unit Components







	Application	Description	Part Number	Retail Price	Core
	243, 244, 343, 344, 443, 444, 483, 493, 494, 543, 546, 583, 594, 642, 643, 644, 645, 683, 692, 693, 693SH, 694, 842, 843, 844, 883, 892, 893, 894, 1092, 1243, 1290, 1291, 1293	Cast Chain Guide	AMH151211	\$ 23.00	
	243, 244, 343, 344, 443, 444, 543, 546, 642, 643, 644, 645, 842, 843, 844, 1243	Steel Chain Guide	AMH118945	\$ 17.00	
	606, 606C, 608, 608C, 612, 612C, 612FC, 616, 616C, 706C, 708C, 708FC, 712C, 716C, 718C	Chain Guide, Right Hand RowMax™	AMHXE111768	\$ 12.00	
		Chain Guide, Left Hand RowMax™	AMHXE111724	\$ 12.00	
	(606, 606C, 608, 608C, 612, 612C ASN 745101), 608FC	Chain Guide, Right Hand	AMAH235033	\$ 32.00	
	ASN 129189, 612FC, 616, 616C, 618, 618C	Chain Guide, Left Hand	AMAH235031	\$ 32.00	
	(606, 606C, 608, 608C, 612, 612C ASN 745101), 612FC, 616, 616C, 618, 618C, 706C, 708C, 712C, 712FC, 716C, 718C	Guide Plate Replaces HXE13268	AMHXE78964	\$ 29.00	
	(606, 606C, 608, 608C, 612, 612C ASN 745101), 608FC ASN 129189, 612FC, 616, 616C, 618, 618C, 706C, 708C, 708FC, 712C, 712FC, 716C, 718C	Guard Deflector	AMAXE18146	\$ 171.08	
	443, 444, 444SH, 493, 494, 543, 546, 592, 594, 642, 643, 643SH, 644, 645, 692, 693, 694, 842, 843, 844, 892, 893, 894, 1092, 1243, 1290, 1291, 1293	Idler Strap	AMH144503	\$ 36.00	
	493, 592, 594, 692, 693, 694, 892, 893, 894, 1092, 1290, 1291, 1293	Lower Idler Support	AMH153898	\$ 27.00	
	443, 444, 444SH, 543, 546, 642, 643, 643SH, 644, 645, 842, 843, 844, 894, 1243	Lower Idler Support	AMH84479	\$ 17.00	
	606, 608, 612	Support For Deck Plate Sensor	AMR86457	\$ 2.26	
	443, 444, 444SH, 493, 494, 543, 546, 592, 594, 642, 643, 643SH, 644, 645, 692, 693, 694, 842, 843, 844, 892, 893, 894, 1092, 1243, 1290, 1291, 1293	Tension Spring Bolt	AM08H4219	\$ 5.00	
	443, 444, 444SH, 493, 494, 543, 546, 592, 594, 642, 643, 643SH, 644, 645, 692, 693, 694, 842, 843, 844, 892, 893, 894, 1092, 1243, 1290, 1291, 1293	Tension Spring Flat Washer	AM24H1373	\$ 1.00	
	243, 244, 343, 344, 443, 444, 493, 494, 543, 546, 642, 643, 644, 693, 693SH, 694, 843, 844, 893, 894, 1243, 1293	Stalk Roll Shim 0.010" Thick Sold in Multiples of 2, Priced Individually	AMN102004	\$ 2.75	

John Deere®—Combine

Cornhead—Row Unit Components

Application	Description	Part Number	Retail Price	Core
 443, 444, 444SH, 493, 494, 543, 546, 592, 594, 642, 643, 643SH, 644, 645, 692, 693, 694, 842, 843, 844, 892, 893, 894, 1092, 1243, 1290, 1291, 1293	Tension Spring, Lower Idler Support	AMN61703	\$ 4.00	
606, 608, 612	Spring For Auger Slip Clutch Drive	AMH101276	\$ 18.86	
 606, 608, 612	Tensioner Strap For Gathering Chain	AMH215634	\$ 29.35	
 443, 444, 444SH, 493, 494, 543, 546, 592, 594, 642, 643, 643SH, 644, 645, 692, 693, 694, 842, 843, 844, 892, 893, 894, 1092, 1243, 1290, 1291, 1293	Bushing Spring Cover	AMN104096	\$ 7.00	
 (600, 606, 606C, 608, 608C, 612, 612C BSN 745100)	Rotary Sensor Automatic Header Height Replaces AH228517, AH230475	AMAH233087	\$ 72.00	
 600, 606, 606C, 608, 608C, 612, 612C	Header Height Sensor, Contour-Master™ Left Hand Replaces AXE57249	AMAXE17036	\$ 70.00	

Curtain Components















Application	Description	Part Number	Retail Price	Core
 606C BSN 745100 - 30"	StalkMaster™ Rubber Curtain Kit Includes AMH227177 (29" x 9"), AMH228482 (40.44" x 17.75"), AMH228483 (42.62" x 17.75") and (2) AMH227178 (9" x 5") Rubber Shields	AMX28040	\$ 219.00	
 606C ASN 745101 - 30"	StalkMaster™ Rubber Curtain Kit Includes (2) AMHXE89078 (31.56" x 9.50") and (2) AMHXE30386 (54.06" x 9.50") Rubber Shields	AMX28041	\$ 185.00	
 608C BSN 745100 - 30"	StalkMaster™ Rubber Curtain Kit Includes AMH227180 (41.62" x 17.75), AMH227181 (43.62" x 17.62"), (2) AMH227178 (9" x 5") and (3) AMH227177 (29" x 9") Rubber Shields	AMX28042	\$ 265.00	
 608C ASN 745101 - 30"	StalkMaster™ Rubber Curtain Kit Includes (2) AMHXE21077 (18.50" x 9.50"), (2) AMHXE89079 (42.50" x 9.50") and (2) AMHXE30386 (54.06" x 9.50") Rubber Shields	AMX28043	\$ 265.00	
 612C BSN 745100 - 22"	StalkMaster™ Rubber Curtain Kit Includes AMH228513 (31.19" x 17.75"), AMH228514 (33.50" x 17.62"), (2) AMH227178 (9" x 5"), (2) AMH227184 (26.25" x 9") and (3) AMH227177 (29" x 9") Rubber Shields	AMX28045	\$ 330.00	
 612C BSN 745100 - 30"	StalkMaster™ Rubber Curtain Kit Includes AMH227182 (21" x 18"), (2) AMH227178 (9" x 5"), (2) AMH227185 (16" x 9"), (2) AMH227184 (26.25" x 9") and (3) AMH227177 (29" x 9") Rubber Shields	AMX28048	\$ 425.00	

John Deere®—Combine

John Deere®—Combine

John Deere®—Combine

Cornhead—Row Unit Components

Application	Description	Part Number	Retail Price	Core
 612C ASN 745101, 712C - 20"	StalkMaster™ Rubber Curtain Kit Includes (2) AMHXE21077 (18.50" x 9.50"), (2) AMHXE89083 (42.62" x 9.50") and (2) AMHXE30386 (54.06" x 9.50") Rubber Shields	AMX28044	\$ 280.00	
 612C SN 745101-774999 - 22"	StalkMaster™ Rubber Curtain Kit Includes (2) AMHXE21077 (18.50" x 9.50"), (2) AMHXE30386 (54.06" x 9.50") and (2) AMHXE89085 (59.25" x 9.50")	AMX28046	\$ 285.00	
 612C ASN 775000, 712C - 22"	StalkMaster™ Rubber Curtain Kit Includes (2) AMHXE89077 (18.50" x 9.50") and (2) AMHXE30386 (54.06" x 9.50")	AMX28047	\$ 290.00	
 612C ASN 745101, 712C - 30"	StalkMaster™ Rubber Curtain Kit Includes (2) AMHXE30386 (54.06" x 9.50"), (2) AMHXE89082 (59.25" x 9.50") and (2) AMHXE17918 (67.50" x 9.50") Rubber Shields	AMX28049	\$ 385.00	
 612FC, 712FC - 30"	StalkMaster™ Rubber Curtain Kit Includes (2) AM5XB00758 (30.50" x 9.50"), (2) AM5XB00763 (34.12" x 9.50"), (2) AM5XB00759 (50.75" x 9.37") and (2) AMHXE30386 (54.06" x 9.50") Rubber Shields	AMX28050	\$ 695.00	
 616C, 716C - 30"	StalkMaster™ Rubber Curtain Kit Includes (2) AMHXE21077 (18.50" x 9.50"), (2) AMHXE17919 (39.50" x 7.50"), (2) AMHXE20821 (48.75" x 9.50") and (2) AMHXE89084 (74.44" x 9.50") Rubber Shields	AMX28051	\$ 535.00	
 618C, 718C - 20"	StalkMaster™ Rubber Curtain Kit Includes (2) AMHXE21077 (18.50" x 9.50"), (2) AMHXE20821 (48.75" x 9.50"), (2) AMHXE30386 (54.06" x 9.50") and (2) AMHXE89085 (59.25" x 9.50") Rubber Shields	AMX28052	\$ 365.00	
 618C, 718C - 22"	StalkMaster™ Rubber Curtain Kit Includes (2) AMHXE21077 (18.50" x 9.50"), (2) AMHXE20821 (48.75" x 9.50"), (2) AMHXE30386 (54.06" x 9.50") and (2) AMHXE89086 (76" x 9.50") Rubber Shields	AMX28053	\$ 425.00	
 (606, 606C, 608, 608C BSN 745100), 612, 612C, 712C, C12R	StalkMaster™ Rubber Curtain, Rear 23.25" Long, 9.50" Wide	AMHXE89077	\$ 41.00	
 (606, 606C, 608, 608C BSN 745100), 612, 612C, 712C, C12R	StalkMaster™ Rubber Curtain, Rear 49.62" Long, 9.50" Wide	AMHXE89083	\$ 88.00	
 (606, 606C, 608C ASN 745100), 612, 612C, 712C, C12R	StalkMaster™ Rubber Curtain, Rear 53.25" Long, 9.50" Wide	AMHXE89082	\$ 59.00	
 (606, 606C, 612, 612C ASN 745100), 608, 608C, 708C, C8R	StalkMaster™ Rubber Curtain, Rear 42.50" Long, 9.50" Wide	AMHXE89079	\$ 77.00	
 606, 606C, 608, 608C, 612, 612FC, 616, 616C, 618, 618C, 706C, 708C, 712C, 716C, C6R, C8R, C12R, C16R, C18R	StalkMaster™ Rubber Curtain, Rear 54.06" Long, 9.50" Wide	AMHXE30386	\$ 59.00	
 606, 606C, 706C, C6R, (608, 608C, 612, 612C BSN 745100)	StalkMaster™ Rubber Curtain, Rear 31.56" Long, 9.50" Wide	AMHXE89078	\$ 54.00	
 612FC, 712FC	StalkMaster™ Rubber Curtain, Rear 30.50" Long, 9.50" Wide	AM5XB00758	\$ 105.00	

John Deere®—Combine

Cornhead—Row Unit Components









Application	Description	Part Number	Retail Price	Core
 612FC, 712FC	StalkMaster™ Rubber Curtain, Rear 50.75" Long, 9.37" Wide	AM5XB00759	\$ 133.00	
 612FC, 712FC	StalkMaster™ Rubber Curtain, Rear 34.12" Long, 9.50" Wide	AM5XB00763	\$ 66.00	
 616, 616C, 618, 618C, 716C, 718C, C16R, C18R	StalkMaster™ Rubber Curtain, Rear 18.50" Long, 9.50" Wide	AMHXE21077	\$ 41.00	
 616, 616C, 618, 618C, 716C, 718C, C16R, C18R	StalkMaster™ Rubber Curtain, Rear 48.75" Long, 9.50" Wide	AMHXE20821	\$ 84.00	
 618, 618C, 718C, C18R	StalkMaster™ Rubber Curtain, Rear 59.25" Long, 9.50" Wide	AMHXE89085	\$ 67.00	
 618, 618C, 718C, C18R	StalkMaster™ Rubber Curtain, Rear 76" Long, 9.50" Wide	AMHXE89086	\$ 83.00	
 616, 616C, 716C, C16R	StalkMaster™ Rubber Curtain, Rear 74.44" Long, 9.50" Wide	AMHXE89084	\$ 79.00	
 (606, 606C ASN 745100), 608, 608C, 612, 612C, 708C, 712C, C8R, C12R	StalkMaster™ Rubber Shield 40.31" Long, 9.50" Wide	AMHXE89081	\$ 128.00	
 (606C, 608C BSN 745101 - 30", 36", 38"), (612C BSN 745101 - 20", 22", 30")	StalkMaster™ Rubber Shield 9" Long, 5" Wide	AMH227178	\$ 35.00	
 (606C, 608C BSN 745101 - 30", 36", 38"), (612C BSN 745101 - 20", 22", 30")	StalkMaster™ Rubber Shield 29" Long, 9" Wide	AMH227177	\$ 35.00	
 612C BSN 745101 - 20", 22", 30"	StalkMaster™ Rubber Shield 26.25" Long, 9" Wide	AMH227184	\$ 42.00	
 612C BSN 745101 - 30"	StalkMaster™ Rubber Shield 16" Long, 9" Wide	AMH227185	\$ 43.00	
 606C BSN 745101 - 30", 36", 38"	StalkMaster™ Rubber Shield, End 40.44" Long, 17.75" Wide	AMH228482	\$ 77.00	
 608C BSN 745101 - 30", 36", 38"	StalkMaster™ Rubber Shield, End 41.62" Long, 17.75" Wide	AMH227180	\$ 69.00	
 606C BSN 745101 - 30", 36", 38"	StalkMaster™ Rubber Shield, End 42.62" Long, 17.75" Wide	AMH228483	\$ 78.00	
 608C BSN 745101 - 30", 36", 38"	StalkMaster™ Rubber Shield, End 43.62" Long, 17.62" Wide	AMH227181	\$ 64.00	
 612C BSN 745101 - 22"	StalkMaster™ Rubber Shield, End 31.19" Long, 17.75" Wide	AMH228513	\$ 63.00	
 612C BSN 745101 - 22"	StalkMaster™ Rubber Shield, End 33.50" Long, 17.62" Wide	AMH228514	\$ 65.00	
 612C BSN 745101 - 30"	StalkMaster™ Rubber Shield, End 21" Long, 18" Wide	AMH227182	\$ 78.00	
 612C BSN 745101 - 30"	StalkMaster™ Rubber Shield, End 43.75" Long, 17.87" Wide	AMH227183	\$ 80.00	

John Deere®—Combine



John Deere®—Combine

John Deere®—Combine

Cornhead—Row Unit Components



	Application	Description	Part Number	Retail Price	Core
	(606, 606C, 608, 608C, 612, 612C BSN 745100)	StalkMaster™ Rubber Divider Shield 29.87" Long, 7" Wide	AMHXE26384	\$ 29.00	
	(606, 606C, 608, 608C, 612, 612C BSN 745100), 712C, C12R	Rubber Curtain, Rear 67.50" Long, 9.50" Wide	AMHXE17918	\$ 93.00	
	616, 616C, 716C, C16R	Rubber Curtain, Rear 39.50" Long, 7.50" Wide	AMHXE17919	\$ 96.00	
	(606, 606C, 608, 608C, 612, 612C BSN 745100)	Rubber Side Curtain	AMH219002	\$ 39.00	
	(606, 606C, 608, 608C, 612, 612C BSN 745100)	Rubber Divider Shield	AMH227244	\$ 70.00	
	(606, 606C, 608, 608C, 612, 612C BSN 745100)	Rubber Divider Shield	AMHXE27218	\$ 33.00	
	(606, 606C, 608, 608C, 612, 612C BSN 745100)	Rubber Divider Shield	AMHXE33997	\$ 52.00	
	(606, 606C, 608, 608C, 612, 612C BSN 745100)	Rubber Divider Shield	AMHXE34386	\$ 35.00	

Auger Drive Components

	Application	Description	Part Number	Retail Price	Core
	(493, 494 BSN 655200), (594, 693, 893, 894, 1293 BSN 655400)	Chain Sprocket 64 Tooth, 13.11" OD, 1.13" Hex Bore For Size 50 Chain	AMAH145940	\$ 151.25	
	(493, 494 BSN 665200), 1243	Chain Sprocket 48 Tooth, 9.91" OD, 1.13" Hex Hub Diameter, For Size 50 Chain	AMAH113341	\$ 83.11	
	(493, 494 BSN 660200), 592, 594, 692, 693, 694, 892, 893, 894, 1092	Drive Sprocket 34 Tooth, 8.508 OD, 1.13" Hex Hub Diameter For Size 60 Chain	AMAH111501	\$ 72.04	
	(493, 494 ASN 665201), (594, 693, 893, 1290, 1291, 1293 ASN 665401)	Drive Sprocket 52 Tooth, 12.848" OD, 1.13" Hex Hub Diameter For Size 60 Chain	AMAH147693	\$ 175.33	
	(493, 693, 694, 893, 894 1092, 1290, 1291 ASN 665401), (494, 592 ASN 665201), 1293 ASN 705101	Chain Sprocket 13 Tooth, 1.756" ID, 3.475" OD	AMAH143100	\$ 68.00	
	443 ASN 620252, 444 ASN 620307, (493, 494 ASN 660199), 543 ASN 620306, 546 ASN 620401, 592, 594, 643 ASN 620537, 644 ASN 620576, 645 ASN 620602, 692, 693, 843 ASN 620717, 844 ASN 620711, 893, 894, 1243	Chain Sprocket 28 Tooth, 7.196" OD, 1.13" Hex Hub Diameter For Size 60 Chain	AMAH124999	\$ 64.01	
	(493, 494 BSN 655200), (592, 693, 694, 893, 894, 1092, 1290, 1291 BSN 655400), 1243, 1293 BSN 705100	Drive Sprocket 17 Tooth, 1.942" ID, 3.711" OD For Size 50 Chain	AMAH143227	\$ 112.07	

John Deere®—Combine

Cornhead—Row Unit Components









	Application	Description	Part Number	Retail Price	Core
	243, 244, 343, 344, 443, 444, 483, 493 SN 665201-670356, (494, 692, 693, 693SH, 694, 892, 893, 894 BSN 670356), 543, 546, 583, (592, 1092, 1290, 1291, 1293 BSN 659999), 594, 642, 643, 644, 645, 683, 842, 843, 883, 1243 BSN 630750	Idler Sprocket 15 Tooth, 0.638" ID For Size 60 Chain	AMAE27909	\$ 27.46	
	493, 494, 594, 643 ASN 620449, 644 ASN 620549, 645 ASN 620600, 693, 694, 893, 894, 1293	Drive Sprocket 14 Tooth, 3.483" OD, 1.13" Hex Hub Diameter For Row Unit	AMAH91784	\$ 71.56	
	592, (606, 608, 612 - w/ StalkMaster™), 693, 694, 893, 894, 1092, 1290, 1291, 1293	Chain Sprocket 10 Tooth For Auger Drive	AMAH217746	\$ 56.70	
	692 BSN 705250, 693 BSN 705437, 694 BSN 705420, 892 BSN 705500, 893 BSN 705984, 894 BSN 705667	Chain Sprocket 25 Tooth, 6.367" OD, 1.13" Hex Bore For Size 60 Chain	AMAH145983	\$ 77.16	
	692 ASN 705250, 693 ASN 705437, 694 ASN 705420, 892 ASN 705500, 893 ASN 705984, 894 ASN 705667	Chain Sprocket 27 Tooth, 6.822" OD, 1.13" Hex Hub Diameter For Size 60H Chain For Row Unit	AMAH212498	\$ 106.81	
	344 BSN 569762, 443 BSN 620251, (493, 494 SN 660201-705437), (543, 546, 642, 643, 644, 645, 842, 843 BSN 332701), 692 BSN 705250, 693 BSN 705437, 694 BSN 705420, 892 BSN 705500, 894 BSN 705667	Drive Sprocket 30 Tooth, 1.13" ID, 7.59" OD For Size 60 Chain	AMAN102027	\$ 71.16	
	592, 693, 694, 893, 894	Drive Sprocket 33 Tooth, 8.288" OD, 1.13" Hex Bore Diameter For Size 60 Chain For Row Unit	AMAH215181	\$ 112.56	
	592, 693, 694, 893, 894	Drive Sprocket 24 Tooth, 6.139" OD, 1.13" Hex Hub Diameter For Size 60 Chain For Row Unit	AMAH215182	\$ 105.11	
	592, 693, 694, 893, 894, 1092, 1291, 1293	Drive Sprocket 19 Tooth, 8.245" OD, 1.264" Hex Bore Diameter For Size 100 Chain For Row Unit	AMAH223489	\$ 77.77	
	(1092, 1290, 1291, 1293 BSN 710100), 1243	Chain Sprocket 23 Tooth, 7.857" OD, 1.13" Hex Hub Diameter For Size 80 Chain	AMAH114830	\$ 124.97	
	1092, 1290, 1291, 1293	Drive Sprocket 24 Tooth, 8.203" OD, 1.263" Hex Bore Diameter For Size 80 Chain For Row Unit	AMAH215519	\$ 73.80	
	1092, 1290, 1291, 1293	Drive Sprocket 17 Tooth, 5.938" OD, 1.262" Hex Bore Diameter For Size 80 Chain For Row Unit	AMAH215521	\$ 55.84	
	1092, 1290, 1291, 1293	Drive Sprocket 24 Tooth, 8.19" OD, 1.131" Hex Bore Diameter For Size 80 Chain For Row Unit	AMAH215493	\$ 70.31	

John Deere®—Combine

John Deere®—Combine



John Deere®—Combine

Cornhead—Row Unit Components

Application	Description	Part Number	Retail Price	Core
1092, 1290, 1291, 1293	Drive Sprocket 17 Tooth, 5.912" OD, 1.13" Hex Bore Diameter For Size 80 Chain For Row Unit	AMAH215495	\$ 53.67	
1293 ASN 705100	Drive Sprocket 18 Tooth, 6.269" OD, 1.255" Hex Bore Diameter For Size 80 Chain	AMAH206761	\$ 99.52	
1293 ASN 705100	Drive Sprocket 22 Tooth, 7.585" OD, 1.257" Hex Bore Diameter For Size 80 Chain	AMAH206760	\$ 111.82	
(606, 608, 612, 1092, 1290, 1291, 1293 - w/ StalkMaster™), 612	Chain Sprocket 12 Tooth, 0.637" ID, 4.334" OD For Auger Drive	AMAH216239	\$ 72.79	
 493, 494, 592, 594, 606, 608, 612, 693, 694, 893, 894, 900 Series, 1092, 1290, 1291, 1293	Pressed Flanged Housing	AMH161529	\$ 3.15	
(444, 543, 546, 643, 644, 645, 843 ASN 382700), (493, 494 BSN 665201), (592, 693, 694, 893, 894, 1092, 1290, 1291, 1293 SN 660000-665401), 844 ASN 380600, 1243 ASN 471047	Slip Clutch Hub	AMH135198	\$ 129.41	
592, 606, 608, 612, 693, 694, 893, 894, 1092, 1290, 1291, 1293	Slip Clutch Housing For Auger Drive	AMH209926	\$ 107.69	
 (592, 693, 694, 863, 894, 1092, 1290, 1291, 1293 ASN 665401), 606, 608, 612	Slip Clutch Jaw	AMH101677	\$ 29.50	
 (592, 693, 694, 863, 894, 1092, 1290, 1291, 1293 ASN 665401), 606, 608, 612	Washer For Auger Drive	AMH99303	\$ 4.54	
 606, 608, 612	Slip Clutch Drive Sprocket 10 Tooth, 1.756" ID, 3.674" OD For Auger Drive	AMAH222303	\$ 80.67	
606, 608, 612 w/ StalkMaster™	Slip Clutch Drive Sprocket 10 Tooth, 1.875" ID, 3.674" OD For Auger Drive	AMAH227660	\$ 123.87	
 493, 494, 592, 594, 606, 608, 612, 693, 694, 893, 894, 1092, 1290, 1291, 1293	Ball Bearing Hex Bore For Auger Drive	AMAN102010	\$ 15.00	
(592, 693, 694, 893, 894, 1092, 1290, 1291, 1293 ASN 665401), 606, 608, 612	Bushing For Auger Drive	AMG6579E	\$ 12.07	
 606, 608, 612	Ball Bearing For Gathering Chain Idler Sprocket	AMAA61722	\$ 3.50	
 606, 608, 612	Ball Bearing	AMJD10018	\$ 22.23	
 606, 608, 612 - w/ StalkMaster™	Ball Bearing 1.50" Hex Bore	AMAE40895	\$ 35.00	
 606, 608, 612, 693, 694, 893, 894, 1293, 1693	Ball Bearing 1.251" ID, 2.835" OD	AMJD9420	\$ 28.09	

Prices Subject to Change without Prior Notice. The use of original equipment manufacturer (OEM) part numbers or trademarks, e.g. Case® and John Deere®, are for reference purposes only and for indicating product use and compatibility. Our company and the listed replacement parts contained herein are not sponsored, approved or manufactured by the OEM. All parts are New unless designated Reman in the description.

John Deere®—Combine

	Application	Description	Part Number	Retail Price	Core
	(606, 608, 612 BSN 745100)	Bearing Cap	AMHXE25730	\$ 10.00	
	606, 608, 612	Bearing Cap For Gathering Chain	AMH233285	\$ 6.42	
	606, 608, 612	Bushing For Chopper Blade	AMH233284	\$ 9.16	





Roller Chains and Components

	Application	Description	Part Number	Retail Price	Core
	344, 443 BSN 620250, 444	Roller Chain, Row Unit Drive 85 Links, Size 60 Chain	AMAN102498	\$ 35.00	
	493, 494 ASN 665201, 592, 693, 694, 893, 894 ASN 665401	Roller Chain, Auger Drive 69 Links, Size 60 Chain	AMAH147697	\$ 35.00	
	493, 494 BSN 660200, 1293 BSN 659999	Roller Chain, Auger Drive 77 Links, Size 50 Chain	AMAH98784	\$ 25.00	
	493, 494 SN 660201-665200, 592, 594, 693, 694, 893, 894 SN 660000-665400, 1092, 1290, 1291 BSN 659999	Roller Chain, Auger Drive Slowdown 83 Links, Size 50 Chain	AMAH145941	\$ 30.00	
	493, 494 ASN 670357, 692, 693, 694, 892, 893, 894 ASN 705101	Roller Chain, Row Unit Drive 94 Links, Size 60H Chain	AMAH208711	\$ 59.00	
	493, 494 SN 660201-670356, 692, 693, 694, 892, 893, 894 SN 695301-705100	Roller Chain, Row Unit Drive 94 Links, Size 60 Chain	AMAH201472	\$ 45.00	
	692, 693, 694, 892, 893, 894 ASN 705101	Roller Chain, Row Unit Drive 88 Links, Size 60H Chain	AMAH208710	\$ 57.00	
	692, 693, 694, 892, 893, 894 SN 695301-705100	Roller Chain, Row Unit Drive 86 Links, Size 60 Chain	AMAH145991	\$ 41.00	
	592, 693, 694, 893, 894	Roller Chain, Row Unit Drive 86 Links, Size 60 Chain	AMAH215232	\$ 35.00	
	594 BSN 659999	Roller Chain, Auger Drive 76 Links, Size 50 Chain	AMAN102499	\$ 35.00	
	594, 693, 694, 893, 894 SN 660000-695300	Roller Chain, Row Unit Drive 88 Links, Size 60 Chain	AMAH145984	\$ 41.00	
	594, 693, 694, 893, 894 SN 660000-695300	Roller Chain, Row Unit Drive 83 Links, Size 60 Chain	AMAH145985	\$ 45.00	

Cornhead—Row Unit Components

John Deere®—Combine

John Deere®—Combine

	Application	Description	Part Number	Retail Price	Core
	1092, 1290, 1291, 1293	Roller Chain, Row Unit Drive 64 Links, Size 80 Chain	AMAH215490	\$ 45.00	
	1092, 1290, 1291, 1293 SN 660000-695300	Roller Chain, Row Unit Drive 67 Links, Size 80 Chain	AMAH145986	\$ 60.00	
	1092, 1290, 1291, 1293 SN 660000-695300	Roller Chain, Row Unit Drive 63 Links, Size 80 Chain	AMAH145987	\$ 60.00	
	1092, 1290, 1291, 1293 SN 695301-705100	Roller Chain, Row Unit Drive 67 Links, Size 80 Chain	AMAH201469	\$ 65.00	
	1092, 1290, 1291, 1293 SN 695301-705100	Roller Chain, Row Unit Drive 65 Links, Size 80 Chain	AMAH201470	\$ 60.00	
	1290, 1291, 1293 ASN 705100	Roller Chain, Row Unit Drive 64 Links, Size 80 Chain	AMAH209912	\$ 50.00	
	1290, 1291, 1293 ASN 705100	Roller Chain, Row Unit Drive 68 Links, Size 80 Chain	AMAH209914	\$ 50.00	
	1243 ASN 630751, 1290, 1291, 1293 BSN 659999	Roller Chain, Row Unit Drive 65 Links, Size 80 Chain	AMAH114886	\$ 60.00	
	1243 BSN 630750	Roller Chain, Row Unit Drive 87 Links, Size 60H Chain	AMAH141274	\$ 35.00	
		606, 606C, 608, 608C, 608FC ASN 129189, 612, 612C, 612FC, 616, 616C, 618, 618C, 706C, 708C, 708FC, 712C, 712FC, 716C, 718C	Roller Chain, Auger Drive 74 Links, Size 80 Chain	AMAH222291	\$ 55.00
		606, 606C, 608, 608C, 608FC ASN 129189, 612, 612C, 612FC, 616, 616C, 618, 618C, 706C, 708C, 708FC, 712C, 712FC, 716C, 718C - w/ StalkMaster™	Roller Chain, Row Unit Drive 66 Links, Size 100 Chain Endless Type Chain w/o Connecting Link	AMAH222151	\$ 90.00
		606, 606C, 608, 608C, 612, 612C, 706C, 708C, 712C	Roller Chain, Row Unit Drive 82 Links, Size 80 Chain Endless Type Chain w/o Connecting Link	AMAH224034	\$ 60.00

John Deere®—Combine

Belts—3300, 4400

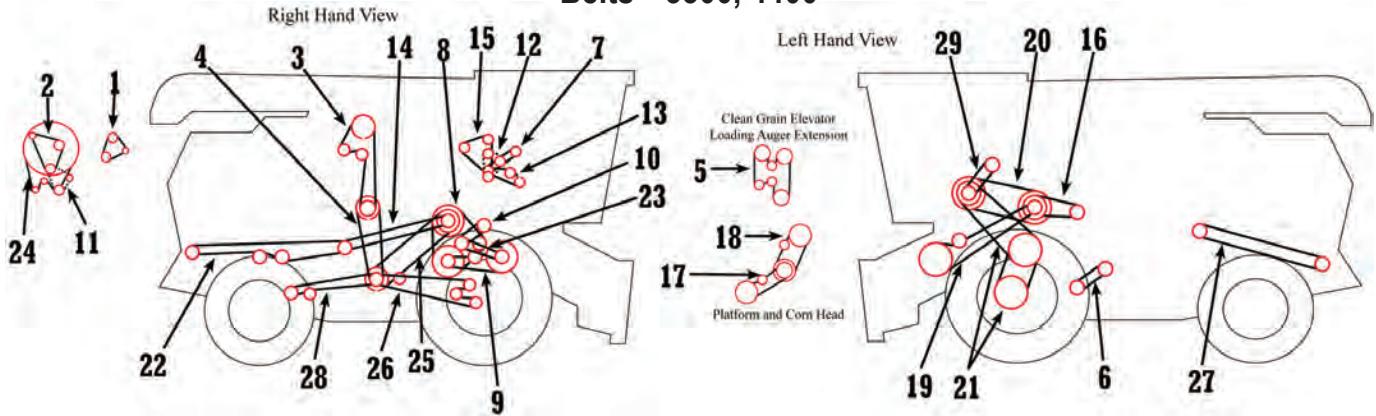

Application	Description	Part Number	Retail Price
1 4400	Alternator & Water Pump - 292 Gas	AMH30634	\$ 9.04
2 3300	Alternator & Water Pump	AMH80897	\$ 12.37
2 4400 BSN 202603	Alternator & Water Pump - 329Dh-02	AMH80896	\$ 8.00
2 4400 ASN 202604	Alternator & Water Pump - 329Dh-02&03	AMH82724	\$ 5.92
3 3300 BSN 101300, 4400 BSN 151200	Clean Grain Elevator, U-Joint Loading Auger	AME60212	\$ 33.00
3 3300 ASN 101300, 4400 ASN 151201	Clean Grain Elevator	AMH87648	\$ 42.78
4 3300, 4400	Clean Grain Elevator Countershaft	AMH23817	\$ 53.00
5 4400	Cvlean Grain Elevator & Loading Auger Extension	AMH81222	\$ 41.00
6 3300, 4400	Cleaning Fan	AMH80726	\$ 52.22
7 4400 S/N 101301-151500	Compressor, A/C - 329 Diesel	AMH77683	\$ 10.00
7 3300 BSN 100000, 4400 Gas BSN 151500, 4400 Diesel BSN 101300	Compressor, A/C - 292 Gas, 329 Diesel	AMH80896	\$ 8.00
7 3300 BSN 100000	Compressor, A/C	AMH81742	\$ 8.50
7 3300 S/N 100001-101300	Compressor, A/C	AMH63772	\$ 19.53
7 3300 BSN 150001	Compressor, A/C	AMH86273	\$ 7.33
7 4400 ASN 151500	Compressor, A/C - 6329DH-01	AMH86275	\$ 10.00
8 3300, 4400	Cylinder Intermediate Shaft	AMH75816	\$ 80.00
9 3300, 4400	Cylinder Set of 3	AMAH80500	\$ 61.00
10 3300, 4400	Cylinder Tachometer	AMH83078	\$ 6.20
11 3300	Engine Fan and Rotary Screen Drive Shaft	AMH86273	\$ 7.33
11 4400	Engine Fan and Rotary Screen Drive Shaft	AMH86275	\$ 10.00
12 3300 BSN 101300, 4400 BSN 151500	Engine Fan	AMH79236	\$ 8.36
12 3300, 4400 BSN 250500	Engine Fan, Cab w/ AC	AMH86271	\$ 7.29
12 4400 ASN 250501	Engine Fan	AMH94373	\$ 7.08
13 3300 BSN 101300, 4400 BSN 151500	Engine Fan Countershaft	AMH79235	\$ 7.05
14 3300, 4400	Front Straw Chopper	AMH20407	\$ 38.00
15 4400	Governor	AMH82479	\$ 14.40
16 3300, 4400	Hydrostatic Reel Pump	AMH77683	\$ 10.00
17 4400 Long Feederhouse	Platform and Corn Head Set of 3	AMAH76154	\$ 68.00
17 4400	Platform and Corn Head, Lower, Variable	AMAH87197	\$ 37.00
18 4400	Platform and Corn Head, Middle, Variable	AMP46553	\$ 90.00
19 3300, 4400	Platform and Feederhouse, Upper	AMH76028	\$ 77.00
20 3300, 4400	Primary Countershaft Set of 2	AMAH98052	\$ 52.00

John Deere®—Combine

John Deere®—Combine

Application	Description	Part Number	Retail Price
21 3300	Propulsion (Req. 2 - Upper and Lower)	AMH75911	\$ 149.66
21 4400	Propulsion (Req. 2 - Upper and Lower)	AMH75847	\$ 105.00
22 3300, 4400	Rear Straw Chopper	AMH79787	\$ 60.00
23 3300 S/N 853-100000, 4400 BSN 101300	Rotary Deflector	AMH86060	\$ 10.70
23 3300 ASN 100001, 4400 ASN 101301	Rotary Deflector	AMH86039	\$ 17.00
24 3300 ASN 100001, 4400	Rotary Screen	AMH86259	\$ 14.48
25 3300, 4400	Secondary Countershaft	AMH138762	\$ 55.00
26 3300, 4400	Shoe Grain Supply Augers	AMH79285	\$ 30.00
27 3300, 4400	Straw Spreader	AMH80159	\$ 26.00
28 3300, 4400	Tailings Lower Auger	AME63031	\$ 32.00
29 3300, 4400	Unloading Auger Countershaft	AMH76136	\$ 20.00

Belts—4420

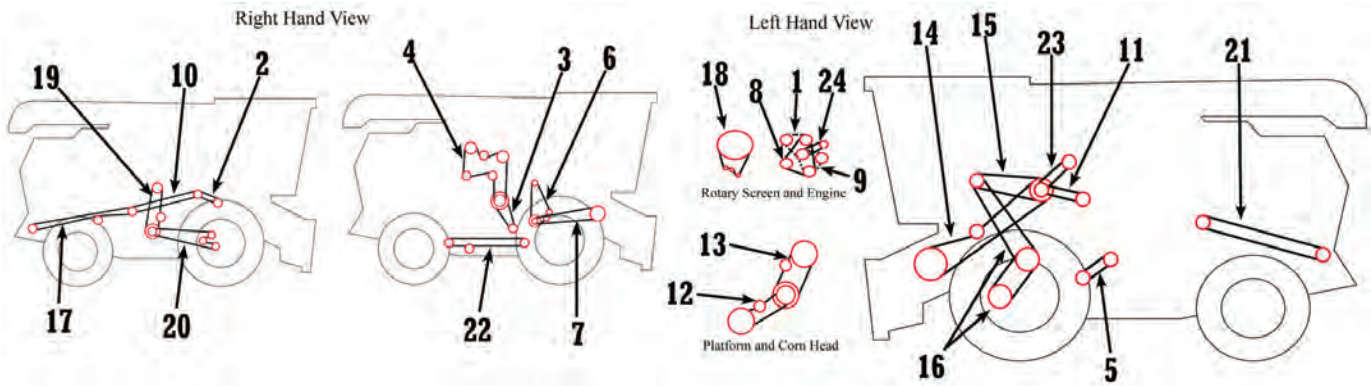

Application	Description	Part Number	Retail Price
1 4420 BSN 550000	Alternator & Water Pump	AMH82724	\$ 5.92
1 4420 ASN 550001	Alternator & Water Pump	AMH101813	\$ 12.84
2 4420	Beater (100% Beater Speed)	AMH86039	\$ 17.00
2 4420	Beater (150% Beater Speed)	AMH101352	\$ 11.23
3 4420	Clean Grain Elevator Countershaft	AMH23817	\$ 53.00
4 4420	Clean Grain Elevator & Loading Auger	AMH81222	\$ 41.00
5 4420	Cleaning Fan	AMH80726	\$ 52.22
6 4420	Cylinder Intermediate Shaft	AMH75816	\$ 80.00
7 4420	Cylinder Set of 3	AMAH80500	\$ 61.00
8 4420	Engine Fan, Cab w/o AC	AMH86271	\$ 7.29
8 4420	Engine Fan, Cab w/ AC	AMH94373	\$ 7.08
9 4420	Engine Fan & Rotary Screen Drive Shaft	AMH86275	\$ 10.00
10 4420	Front Straw Chopper	AMH20407	\$ 38.00
11 4420	Hydrostatic Reel Pump	AMH77683	\$ 10.00
12 4420	Platform Rice, Grain, Long Corn, Variable Set of 3	AMAH76154	\$ 68.00
12 4420	Platform and Corn Head, Lower, Variable	AMAH87197	\$ 37.00
13 4420	Platform and Corn Head, Middle, Variable	AMP46553	\$ 90.00
14 4420	Platform and Feederhouse, Upper	AMH76028	\$ 77.00
15 4420	Primary Countershaft Set of 2	AMAH98052	\$ 52.00
16 4420	Propulsion (Belt Drive)	AMH75847	\$ 105.00

John Deere®—Combine

Application	Description	Part Number	Retail Price
17 4420	Rear Straw Chopper	AMH79787	\$ 60.00
18 4420	Rotary Screen	AMH86259	\$ 14.48
19 4420	Secondary Countershaft	AMH138762	\$ 55.00
20 4420	Shoe Grain Supply Augers	AMH79285	\$ 30.00
21 4420	Straw Spreader	AMH80159	\$ 26.00
22 4420	Tailings Lower Auger	AME63031	\$ 32.00
23 4420	Unloading Auger Countershaft	AMH76136	\$ 20.00
24 4420	AC Compressor	AMH86275	\$ 10.00

Belts—4425, 4435, 4435 Hydro

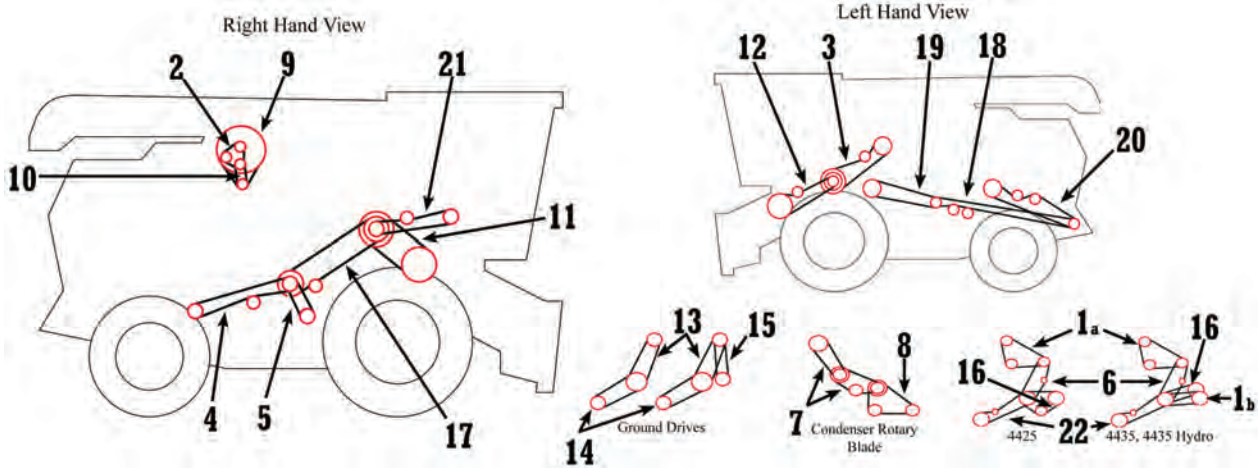

Application	Description	Part Number	Retail Price
1a 4425, 4435 Hydro	A/C Compressor	AMZ42756	\$ 15.02
1b 4435, 4435 Hydro	A/C Compressor	AMZ46759	\$ 11.49
2 4425, 4435, 4435 Hydro	Alternator / Water Pump	AMAR72036	\$ 29.27
3 4425, 4435, 4435 Hydro	Beater	AMZ33790	\$ 207.79
4 4435, 4435 Hydro	Clean Grain Elevator	AMZ47912	\$ 41.22
5 4425	Cleaning Fan	AMZ41178	\$ 26.65
5 4435, 4435 Hydro	Cleaning Fan	AMZ46365	\$ 37.95
6 4425, 4435 Hydro	Condenser Fan	AMZ45482	\$ 17.80
7 4435 Hydro	Condenser Rotary Blade, Upper (2)	AMZ43863	\$ 6.76
8 4435 Hydro	Condenser Rotary Blade, Lower	AMZ38704	\$ 16.44
9 4425, 4435 Hydro	Countershaft to Rotary Screen	AMZ34786	\$ 25.00
9 4435	Countershaft to Rotary Screen	AMZ46764	\$ 19.56
10 4425, 4435, 4435 Hydro	Crankshaft to Countershaft	AMZ32190	\$ 7.29
11 4425, 4435, 4435 Hydro	Cylinder Drive	AMZ65924	\$ 251.99
12 4425, 4435, 4435 Hydro	Feederhouse	AMZ38186	\$ 103.74
13 4425	Ground Drive, Upper	AMAZ35635	\$ 246.80
13 4435	Ground Drive, Upper	AMAZ37807	\$ 238.27
14 4425, 4435	Ground Drive, Lower	AMZ34099	\$ 263.91
15 4435 Hydro	Hydrostatic Drive	AMZ53290	\$ 209.02
16 4425, 4435, 4435 Hydro	Main Hydro Pump	AMZ34828	\$ 18.58
17 4425	Separator	AMZ34405	\$ 36.00
17 4435, 4435 Hydro	Separator	AMZ46366	\$ 41.71

Prices Subject to Change without Prior Notice. The use of original equipment manufacturer (OEM) part numbers or trademarks, e.g. Case® and John Deere®, are for reference purposes only and for indicating product use and compatibility. Our company and the listed replacement parts contained herein are not sponsored, approved or manufactured by the OEM. All parts are New unless designated Reman in the description.

John Deere®—Combine

Application	Description	Part Number	Retail Price
18 4425	Straw Chopper, Rear	AMZ44930	\$ 216.69
18 4435, 4435 Hydro	Straw Chopper, Rear	AMZ55645	\$ 322.63
19 4425, 4435, 4435 Hydro	Straw Chopper, Front	AMZ44761	\$ 140.29
20 4425	Straw Spreader	AMZ33774	\$ 58.00
20 4435, 4435 Hydro	Straw Spreader	AMZ32041	\$ 48.00
21 4425, 4435, 4435 Hydro	Tailings Elevator	AMZ45026	\$ 22.51
22 4425	Unloading Auger	AMZ47911	\$ 48.89
22 4435, 4435 Hydro	Unloading Auger	AMZ51212	\$ 103.77

Belts—6600, 7700 – Right Hand View

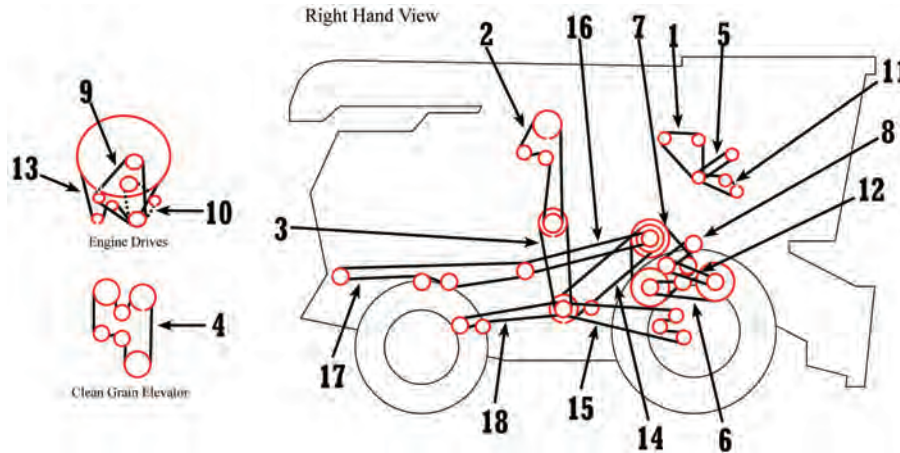

Application	Description	Part Number	Retail Price
1 6600 BSN 105800	Alternator & Water Pump	AMH80897	\$ 12.37
1 6600: 6329DH BSN 208510, 6329GH-02 BSN 156500	Alternator & Water Pump	AMH80896	\$ 8.00
1 6600 ASN 208511, 7700 S/N 2801-8001	Alternator & Water Pump - 6329DH-01	AMH82724	\$ 5.92
1 6600 BSN 605672	Alternator & Water Pump - 6404DH, SH	AMH85377	\$ 8.76
1 6600 ASN 305673, 7700 ASN 163901	Alternator & Water Pump - 6404TH, SH	AMH79236	\$ 8.36
1 7700 BSN 2800	Alternator & Water Pump - Gas Set of 2	AMAR41628	\$ 12.50
1 7700 BSN 2800	Alternator & Water Pump - Diesel Set of 2	AMAR41576	\$ 26.84
1 7700 ASN 8001	Alternator & Water Pump - 404DH-04	AMR52507	\$ 12.69
1 7700 S/N 8001-163900	Alternator & Water Pump - 404TH-01	AMR70871	\$ 7.19
2 6600, 7700	U-Joint Loading Auger	AMH23950	\$ 43.00
3 6600, 7700	Clean Grain Elevator Countershaft	AMH27433	\$ 28.00
4 6600, 7700	Clean Grain Elevator	AMH77766	\$ 43.00
5 6600 BSN 105800, 7700 404TH-01 S/N 8001-163900	Compressor, A/C	AMH80896	\$ 8.00
5 7700 Gas BSN 111900, 404DH-01 BSN 8000	Compressor, A/C	AMH80897	\$ 12.37
5 6600 S/N 105801-156500	Compressor, A/C - 329 Diesel	AMH77683	\$ 10.00
5 6600 ASN 156501	Compressor, A/C - 6329DH-01	AMH86275	\$ 10.00
5 6600 BSN 305672, 7700 BSN 163901 - w/ 6404DH-04	Compressor, A/C - 6404DH & SideHill 39.50" Long	AMH87459	\$ 4.88
5 6600 ASN 310500, 7700 6404TH-01 ASN 163901	Compressor, A/C - 6404TH & SideHill	AMR71603	\$ 5.45
5 7700 S/N 8001-163900	Compressor, A/C - 6404DH-04	AMH81742	\$ 8.50

John Deere®—Combine

John Deere®—Combine

Application	Description	Part Number	Retail Price
6 6600 BSN 821, 7700 BSN 8000	Cylinder, 280-845 RPM Set of 3	AMAH80505	\$ 87.00
6 6600, 7700 ASN 8801	Cylinder, 287-873 RPM	AMH96423	\$ 100.00
6 6600 BSN 821, 7700 BSN 8000	Cylinder, 407-828 RPM Set of 3	AMAH80503	\$ 72.00
6 7700 ASN 8001	Cylinder, 414-1250 RPM	AMH96408	\$ 78.00
7 6600 BSN 310500, 7700	Cylinder, Intermediate Shaft	AMH113749	\$ 113.00
7 6600, 7700	Cylinder, Intermediate Shaft, Heavy Duty	AMH161339	\$ 134.32
8 6600, 7700	Cylinder Tachometer	AMH83077	\$ 4.45
9 6600	Engine Fan - 6329GH-02 & 6329DH-01	AMH86272	\$ 7.54
9 6600 BSN 105800, 7700 BSN 8000	Engine Fan - 6404DH-01	AMH86271	\$ 7.29
9 7700 S/N 8001-111900	Engine Fan - 6404DH-04, TH-01	AMH84740	\$ 19.43
10 6600 & SideHill BSN 305672, 7700 6404DH-04	Engine Fan & Rotary Screen Drive Shaft	AMH137207	\$ 12.00
10 6600 & SideHill ASN 305673, 7700 404TH-01	Engine Fan & Rotary Screen Drive Shaft	AMH86273	\$ 7.33
10 6600 w/ 6329GH-02 BSN 156500 or 6329GH-01 Engine	Engine Fan & Rotary Screen Drive Shaft	AMH86274	\$ 11.94
11 6600 w/ 6329GH-02 or 6404DH-01 BSN 105800 Engine, 7700 w/ Gas BSN 111900 or 6404DH-01 BSN 8000 Engine	Engine Fan Countershaft	AMH79235	\$ 7.05
11 6600, 7700 6404DH-04 SN 8001-111900	Engine Fan Countershaft - 6404DH	AMH85377	\$ 8.76
11 7700 S/N 8001-111900	Engine Fan Countershaft - 6404TH-01	AMH84745	\$ 9.30
12 6600 BSN 105800, 7700 SN 1278-111900	Rotary Deflector	AMH86061	\$ 14.00
12 6600 ASN 105801, 7700 ASN 111901	Rotary Deflector	AMH86039	\$ 17.00
13 6600, 7700	Rotary Screen	AMH86259	\$ 14.48
14 6600, 7700	Secondary Countershaft	AMH77019	\$ 69.00
15 6600, 7700	Shoe Grain Supply Augers	AMH77010	\$ 47.00
16 6600, 7700	Straw Chopper	AMH138762	\$ 55.00
17 6600, 7700	Straw Chopper, Rear	AMH79789	\$ 65.00
18 6600 BSN 7500, 7700 BSN 5000	Tailings Lower Auger	AMN110085	\$ 55.00

Belts—6600, 7700 – Left Hand View

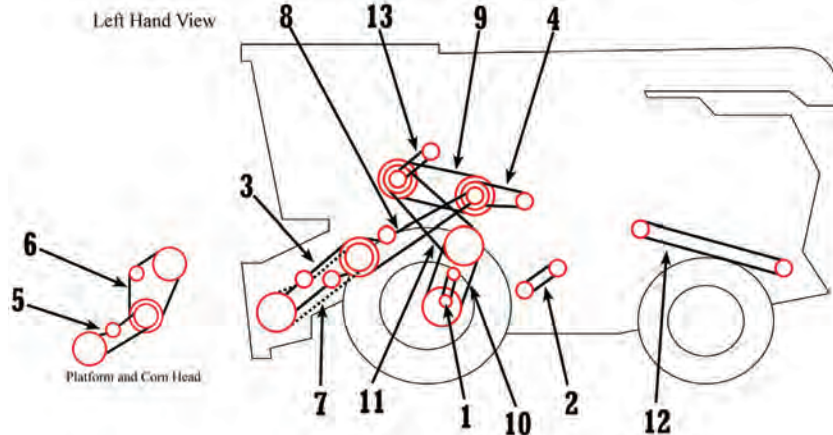

Application	Description	Part Number	Retail Price
1 6600 BSN 9582	Charge Pump, Hydrostatic Drive	AMT12042	\$ 17.00
1 7700 ASN 006208	Charge Pump, Hydrostatic Drive	AMT199T	\$ 9.00
2 6600	Cleaning Fan	AMH108668	\$ 40.00

John Deere®—Combine

Application	Description	Part Number	Retail Price
3 6600 ASN 156501	Feed Conveyor (Regular Feederhouse)	AMH77766	\$ 43.00
3 6600, 7700	Feed Conveyor (Long Feederhouse)	AMH125380	\$ 61.00
4 6600	Hydrostatic Reel Pump	AMH77683	\$ 10.00
5 6600	Platform and Cornhead Set of 3	AMAH76154	\$ 68.00
5 6600 SideHill	Platform and Cornhead, Lower Variable Set of 3	AMAH89436	\$ 90.00
6 6600 BSN 254350	Platform and Cornhead, Middle, Variable	AMP46553	\$ 90.00
6 6600 ASN 254251	Platform and Cornhead, Middle, Variable	AMH84441	\$ 90.00
7 6600	Platform and Feederhouse, Lower, Regular	AMH77765	\$ 90.00
7 7700	Platform and Feederhouse, Lower Long	AMH79796	\$ 95.00
8 6600 Excluding Corn Variable Speed	Platform and Feederhouse, Upper	AMH76030	\$ 66.00
8 6600 ASN 254501	Platform and Feederhouse, Vari-Speed Upper	AMH23927	\$ 60.00
9 7700 BSN 5000	Primary Countershaft Set of 2	AMAH75638	\$ 115.00
9 6600SH BSN 305672, 6600 ASN 11501	Primary Countershaft	AMH84462	\$ 97.00
9 7700 404TH-01 ASN 8001	Primary Countershaft	AMH108175	\$ 110.00
10 6600 ASN 156501	Propulsion Hydrostatic Drive, Lower	AMH88576	\$ 115.00
10 7700	Propulsion Hydrostatic Drive, Lower Set of 2	AMAH84633	\$ 102.00
10 6600, 7700 BSN 115000	Propulsion Belt Drive, Lower	AMH75846	\$ 125.00
10 6600	Propulsion Belt Drive, Lower	AMH75847	\$ 105.00
11 6600 BSN 165600	Propulsion Hydrostatic Drive, Upper	AMH88576	\$ 115.00
11 7700	Propulsion Hydrostatic Drive, Upper Set of 2	AMAH84633	\$ 102.00
11 7700 ASN 111901 404D	Propulsion Posi Torque, Upper Set of 2	AMAH21301	\$ 155.00
11 6600 SideHill ASN 305673	Propulsion Posi-Torq™, Upper Set of 2	AMAH87127	\$ 108.00
11 6600	Propulsion Belt Drive, Upper	AMH75847	\$ 105.00
11 7700 BSN 115000	Propulsion Belt Drive, Upper	AMH75846	\$ 125.00
12 7700	Straw Spreader	AMH26858	\$ 27.00
13 6600 SideHill BSN 305672	Unloading Auger Countershaft	AMH76150	\$ 33.00
13 6600 SideHill ASN 605673	Unloading Auger Countershaft	AMH84424	\$ 63.91

John Deere®—Combine

Belts—6620, 6622, 7720, 7721

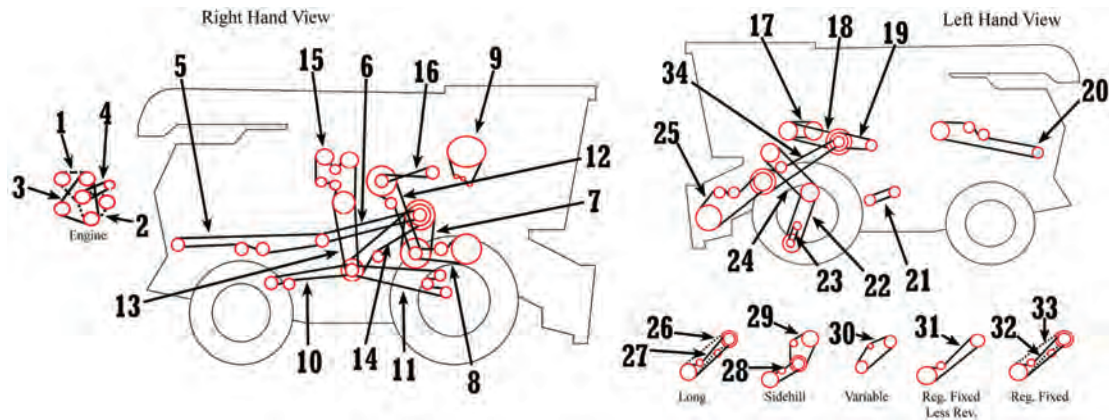

Application	Description	Part Number	Retail Price
1 6620 (6466DH-1 & 6466TH-01), 6622	Alternator & Water Pump	AMH79236	\$ 8.36
1 7720 (6466TH & 6466TH-02)	Alternator & Water Pump	AMH79236	\$ 8.36
2 6620, 6622, 7720	Rotary Screen Drive Shaft	AMH86273	\$ 7.33
3 6620, 6622	Engine Fan	AMH86272	\$ 7.54
3 7720	Engine Fan	AMH86271	\$ 7.29
4 6620 ASN 600001, 7720 ASN 600001	Compressor, A/C	AMH113565	\$ 8.00
4 6620 BSN 615401, 6622, 7720 BSN 615401	Compressor, A/C	AMR71603	\$ 5.45
5 6620, 6622, 7720, 7721	Rear Straw Chopper Drive	AMH103344	\$ 75.00
6 6620, 6622, 7720, 7721	Straw Chopper Drive	AMH101436	\$ 42.00
7 6620, 6622, 7720, 7721	Countershaft Drive, Torq-Sensing	AMH113749	\$ 113.00
7 6620	Countershaft Drive, Heavy Duty	AMH161339	\$ 134.32
8 6620 ASN 551901, 6622 ASN 556001, 7720 ASN 556301, 7721 ASN 562901	Cylinder, 4-Band (Std) 350-700 & 620-1240 RPM	AMH110375	\$ 123.00
8 6620 BSN 551901, 7720 BSN 556301	Cylinder, 3-Band 390-1030 or 450-1200 RPM	AMH96408	\$ 78.00
8 6620 ASN 551901, 6622, 7720 ASN 556301, 7721 ASN 562901	Cylinder, 4-Band (Opt) 380-560 & 500-1000 RPM	AMH96422	\$ 123.00
8 7721 BSN 562901	Cylinder, 4-Band 390-1030 or 450-1200 RPM	AMH96422	\$ 123.00
8 6620 BSN 551901, 6622, 7720 BSN 8001	Cylinder, 3-Band 315-830 RPM	AMH96423	\$ 100.00
8 7721 BSN 562901	Cylinder 160-320 & 285-570 RPM	AMH96421	\$ 120.00
9 6620, 7720	Rotary Screen	AMH86259	\$ 14.48
10 6620, 6622, 7720, 7721	Tailings Auger Drive	AMH118730	\$ 42.00
11 6620, 6622, 7720, 7721	Shoe Supply Auger Drive	AMH77010	\$ 47.00
12 6620, 6622, 7720, 7721	Beater (150% Speed), Grain & Rice	AMH101469	\$ 19.00
12 6620, 7720, 7721	Beater (100% Speed), Beans & Corn	AMH96414	\$ 21.00
13 6620, 6622, 7720, 7721	Clean Grain Elevator Countershaft	AMH27433	\$ 28.00
14 6620 BSN 551901, 6622 BSN 556001, 7720 BSN 556301	Secondary Countershaft Drive	AMH81222	\$ 41.00
14 6620 ASN 551901, 6622 BSN 556001, 7720 ASN 556301	Secondary Countershaft Drive	AMH110300	\$ 44.00
15 6620, 6622 ASN 610401, 7720, 7721	Clean Grain Elevator, Loading Auger	AMH77766	\$ 43.00
15 7721	Hydraulic Reel Pump Drive	AMH23950	\$ 43.00
16 6620, 6622, 7720	Cylinder Tachometer O-Ring	AMH83077	\$ 4.45
17 6620, 6622, 7720	Unloading Auger Drive Set of 2	AMAH96300	\$ 42.00
18 6620, 6622, 7720	Separator Drive	AMH108175	\$ 110.00
19 6620 BSN 625101, 6622, 7720 BSN 625201	Hydraulic Reel Pump Drive	AMH86275	\$ 10.00

John Deere®—Combine

John Deere®—Combine

John Deere®—Combine

Application	Description	Part Number	Retail Price
19 6620 ASN 625101, 7720 ASN 625201	Hydraulic Reel Pump Drive	AMH137207	\$ 12.00
19 7721	Hydraulic Reel Pump Drive	AMH86274	\$ 11.94
20 6620, 6622, 7720, 7721	Straw Spreader Drive	AMH112421	\$ 31.00
21 6620, 6622	Cleaning Fan Drive	AMH108668	\$ 40.00
21 7720, 7721	Cleaning Fan Drive	AMH108669	\$ 49.00
22 6620, 7720	Hydro, Lower Ground Drive Set of 2	AMAH84633	\$ 102.00
22 6620, 7720	Posi-Torq™, Lower Ground Drive	AMH75846	\$ 125.00
23 6620 BSN 610301, 7720 BSN 556301	Hydro Charge Pump	AMT199T	\$ 9.00
23 6620 ASN 610301, 7720 ASN 556301	Hydro Charge Pump	AMT32517	\$ 10.00
23 6622	Hydro Charge Pump	AMH86273	\$ 7.33
24 6620, 7720	Hydro, Upper Ground Drive Set of 2	AMAH84633	\$ 102.00
24 6622	Hydro, Ground Drive Set of 3	AMAH79627	\$ 256.51
24 6620, 7720	Posi-Torq™, Upper Ground Drive Set of 2	AMAH87127	\$ 108.00
25 6620 S/N 502551-615100, 7720 ASN 507351	Feederhouse Drive, Regular Lower	AMH111519	\$ 82.31
25 6620 ASN 403301, 7720 ASN 409101	Feederhouse Drive, Long Lower	AMH97929	\$ 95.00
26 6620 BSN 403301, 7720 BSN 409101	Feederhouse Conveyor Drive, Long	AMH125380	\$ 61.00
27 6620 BSN 403301, 7720 BSN 409101	Feederhouse Conveyor Drive, Long Lower	AMH79796	\$ 95.00
28 6620 BSN 610301	Platform and Cornhead, Lower, Variable Set of 3	AMAH89436	\$ 90.00
29 6620 BSN 610301	Feederhouse Drive, Upper, SideHill Only	AMH84441	\$ 90.00
30 6620, 7720	Feederhouse, Variable Conveyor Drive	AMH110921	\$ 123.00
30 6620 SideHill ASN 610301	Feederhouse, Lower, Fixed Less Reverser	AMH116422	\$ 185.00
31 6620 ASN 615101, 7720 ASN 615201	Feederhouse Drive, Lower, Fixed Less Reverser	AMZ30130	\$ 100.00
31 6620 BSN 502551, 7720 BSN 507351, 7721	Feederhouse Drive, Lower, Reg Fixed	AMZ30130	\$ 100.00
32 6622 BSN 507051	Feederhouse Drive, Lower	AMH33885	\$ 134.00
32 6622 ASN 507051	Feederhouse Drive, Lower	AMH77765	\$ 90.00
33 6620 BSN 502551, 7720 BSN 507351, 7721	Feederhouse Conveyor Drive, Reg Fixed	AMH77766	\$ 43.00
33 6622 BSN 507051	Feederhouse Conveyor Drive	AMH81222	\$ 41.00
34 6620 SideHill BSN 610301, 6622	Feederhouse Drive	AMH23927	\$ 60.00
34 6620 BSN 403301, 6622 BSN 507051, 7720 BSN 4091001, 7721	Feederhouse Drive	AMH76030	\$ 66.00
34 6620 BSN 502551, 7720 BSN 507351	Feederhouse Drive, Reg Fixed	AMH76030	\$ 66.00
34 6620, 7720	Feederhouse Drive Unloading Auger, Long Reg	AMH23927	\$ 60.00
34 6620 ASN 615101, 7720 ASN 615201	Feederhouse Drive, Less Reverser	AMH76030	\$ 66.00
NI 6620, 7720	Dip and Pour Elevator Drive, Upper Countershaft	AMP49415	\$ 46.61
NI 6620, 7720	Dip and Pour Elevator, Lower Countershaft	AME60212	\$ 33.00
NI 6622	Sickle Drive	AMH81524	\$ 53.10
NI 7721	Primary Countershaft	AMH94508	\$ 305.00

John Deere®—Combine

Belts—7722, 8820

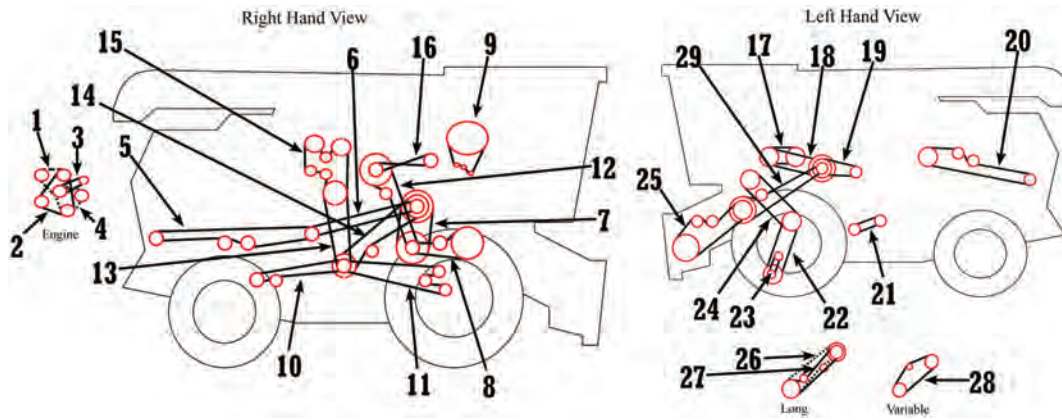

Application	Description	Part Number	Retail Price
1 8820 BSN 464351	Alternator & Water Pump	AMH79236	\$ 8.36
1 7722, 8820 SN 464351-620400	Alternator & Water Pump	AMH86271	\$ 7.29
2 7722, 8820	Rotary Screen	AMH86273	\$ 7.33
3 7722, 8820 ASN 615401	Compressor, A/C	AMH122189	\$ 10.52
3 8820 BSN 615401	Compressor	AMR71603	\$ 5.45
4 7722, 8820	Fan & Hydraulic Pump Set of 2	AMAH96333	\$ 35.70
5 8820	Rear Straw Chopper Drive	AMH103344	\$ 75.00
6 8820	Straw Chopper Drive	AMH101436	\$ 42.00
7 8820	Torq-Sensing Countershaft Drive	AMH113749	\$ 113.00
7 8820	Heavy Duty Countershaft Drive	AMH161339	\$ 134.32
8 8820 BSN 564101	Cylinder (4V) 315-830 RPM	AMH96421	\$ 120.00
8 8820 ASN 564101	Cyl. (4V)(Std) 350-700 & 620-1240 RPM	AMH110375	\$ 123.00
8 8820	Cyl. (4V) 390-1030 & 450-1200 RPM	AMH96422	\$ 123.00
8 8820 ASN 564101	Cylinder, 4-Bnd (Opt) 280-560 & 500-1000 RPM	AMH96422	\$ 123.00
9 8820	Rotary Screen	AMH86259	\$ 14.48
10 8820	Tailings Auger Drive	AMH118730	\$ 42.00
11 8820	Shoe Supply Augers	AMH77010	\$ 47.00
12 8820	Beater (150% Speed), Grain & Rice	AMH101469	\$ 19.00
12 8820	Beater (100% Speed), Beans & Corn	AMH96414	\$ 21.00
13 8820	Clean Grain Elevator	AMH27433	\$ 28.00
14 8820 BSN 556101	Secondary Countershaft Drive	AMH81222	\$ 41.00
14 8820 ASN 556101	Secondary Countershaft Drive	AMH110300	\$ 44.00
15 8820	Clean Grain & Loading Auger	AMH77766	\$ 43.00
16 8820	Cylinder, Tachometer O-Ring	AMH83077	\$ 4.45
17 8820	Unloading Auger Drive Set of 2	AMAH96300	\$ 42.00
18 8820	Separator Drive (3V)	AMH108175	\$ 110.00
19 8820 BSN 625401	Hydraulic Reel Pump Drive	AMH86275	\$ 10.00
19 8820 ASN 625401	Hydraulic Reel Pump Drive	AMH137207	\$ 12.00
20 8820	Straw Spreader Drive	AMH112421	\$ 31.00
21 8820	Cleaning Fan Drive	AMH108669	\$ 49.00
22 7722	Hydro Ground Drive, Lower	AMHAN1220	Call for Price
22 8820	Hydro Ground Drive, Lower Set of 2	AMAH84633	\$ 102.00

John Deere®—Combine

John Deere®—Combine

Application	Description	Part Number	Retail Price
23 7722, 8820	Hydro Charge Pump	AMT32517	\$ 10.00
24 7722, 8820	Hydro Ground Drive, Upper Set of 2	AMAH84633	\$ 102.00
25 7722	Feederhouse Drive, Lower	AMH111519	\$ 82.31
25 8820	Feederhouse Drive, Lower, Reg Fixed w/o Reverser	AMH79796	\$ 95.00
25 8820 ASN 414851	Lower Feederhouse Drive, Long	AMH97929	\$ 95.00
26 8820 BSN 409101	Feederhouse Conveyor, Long	AMH125380	\$ 61.00
27 8820 BSN 409101	Lower Feederhouse Conveyor Drive, Long	AMH79796	\$ 95.00
28 8820	Feederhouse, Variable Conveyor Drive	AMH110921	\$ 123.00
29 7722, 8820	Feederhouse Drive w/ Rev & Vari-Drive	AMH23927	\$ 60.00
29 8820 BSN 409101	Feederhouse Drive, Upper, Long	AMH76030	\$ 66.00
29 8820 BSN 414851	Feederhouse Drive, Less Reverser	AMH76030	\$ 66.00
NI 7722 Hillside	Cutterbar Drive	AMH136881	\$ 49.67

Belts—9400, 9500, 9500SH, 9501, 9600

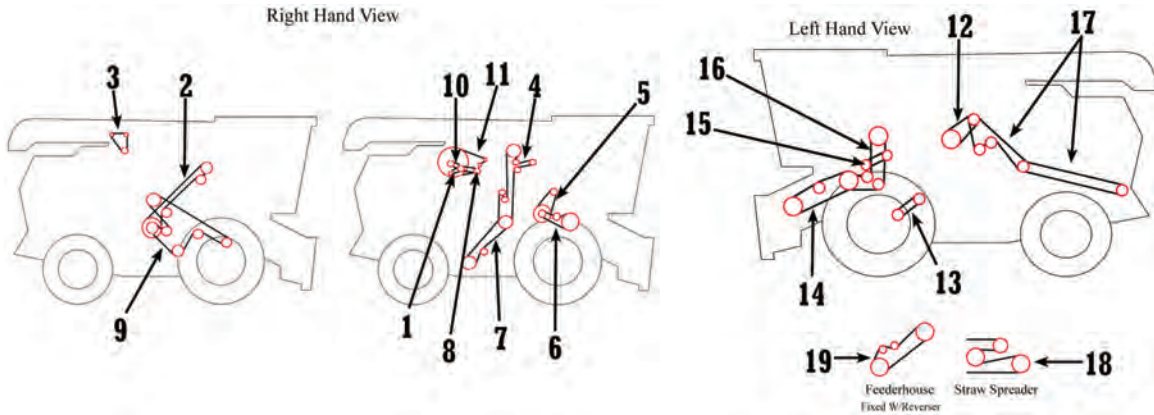

Application	Description	Part Number	Retail Price
1 9400 SN 630201-635100	Air Conditioning Compressor	AMH134772	\$ 11.25
1 9400 SN 635101-636600	Air Conditioning Compressor	AMH101813	\$ 12.84
1 9500 SN 630301-631100, 9600 BSN 631201	Air Conditioning Compressor	AMH134437	\$ 11.75
1 9500-9500SH SN 635201-648500, 9600 SN 631201-647500	Air Conditioning Compressor	AMH81742	\$ 8.50
1 9400 ASN 650101, 9500-9500SH ASN 650201, 9600 ASN 647501	Air Conditioning Compressor	AMH80896	\$ 8.00
2 9400, 9500, 9500SH, 9600	Secondary Countershaft	AMH128010	\$ 62.00
3 9400 BSN 635101, 9600 BSN 631201	Alternator	AMRE44538	\$ 17.05
3 9400 ASN 635101, (9500, 9500SH ASN 635201), 9600 ASN 631201	Alternator	AMH101813	\$ 12.84
3 9500, 9500SH	Alternator, Low Power	AMH134344	\$ 11.48
3 9500-9500SH SN 635201-645200	Alternator	AMR73189	\$ 5.70
4 9400 BSN 640101, 9500-9500SH BSN 640200, 9501	Clean Grain Elevator	AMH137830	\$ 111.00
4 9400 ASN 640101, 9500-9500SH ASN 640201	Clean Grain Elevator	AMH141167	\$ 120.00
4 9600 BSN 640301	Clean Grain Elevator	AMH135458	\$ 118.00
4 9600 ASN 640301	Clean Grain Elevator	AMH141166	\$ 125.00
5 9400, 9500, 9500SH, 9501, 9600	Cylinder, Intermediate Drive	AMH210476	\$ 260.00
5 9400	Cylinder, Intermediate Drive, Ext Range	AMH137670	\$ 245.00

John Deere®—Combine

Application	Description	Part Number	Retail Price
6 9400, 9500, 9500SH, 9501, 9600	Cylinder Drive, Reg Dual & Single Range	AMH115881	\$ 161.80
6 9400	Cylinder Drive, Extended Range	AMH145994	\$ 139.00
6 9400, 9500, 9500SH, 9600	Cylinder Drive, Slow Speed	AMH118618	\$ 150.00
7 9400, 9500, 9500SH, 9501, 9600	Tailings Auger & Elevator, Lower	AMN110085	\$ 55.00
8 9400 BSN 640506, 9500-9500SH BSN 642579	Rotary Screen Drive	AMH134216	\$ 20.57
8 9600 BSN 641922	Rotary Screen Drive, Round Belt	AMH133577	\$ 21.45
8 9600 BSN 641922	Rotary Screen Drive	AMH146636	\$ 10.09
9 9400, 9500, 9500SH, 9501, 9600	Shoe, Straw Walker and Conveyor Augers	AMH131169	\$ 110.00
10 9500, 9600 BSN 641717	Cooling Fan, Lower Power	AMH132808	\$ 14.42
10 9400	Cooling Fan	AMH132809	\$ 12.50
10 9500, 9500SH, 9600 ASN 641717	Cooling Fan, High Power	AMH153297	\$ 50.07
11 9400 BSN 640506, 9500-9500SH ASN 642579, 9600 BSN 641716	Rotary Screen	AMH143869	\$ 53.50
11 9400 ASN 640506, 9500-9500SH ASN 642579, 9600 ASN 641717	Rotary Screen	AMH145158	\$ 39.00
12 9400, 9500, 9500SH, 9501, 9600	Unloading System Set of 2	AMAH158880	\$ 60.00
13 9400 BSN 670101, 9500-9500SH BSN 670201, 9501, 9600 BSN 670301	Separator Fan, 490-980 RPM Slow Speed	AMH137264	\$ 67.00
13 9400 ASN 670101, 9500-9500SH ASN 670201, 9600 ASN 670301	Fan Drive, 490-980 RPM, Slow Speed	AMH152180	\$ 72.00
13 9400 BSN 670101, 9500-9500SH BSN 670201, 9501, 9600 BSN 670301	Separator Fan, Regular Speed	AMH140404	\$ 67.00
13 9400 ASN 670101, 9500-9500SH ASN 670201, 9600 ASN 670301	Fan Drive, 750-1350 RPM, Regular Speed	AMH152146	\$ 75.00
14 9400, 9500SH, 9501, 9600	Feederhouse, Variable Speed	AMH161648	\$ 170.00
15 9400, 9500SH, 9500, 9600	Beater Drive (75% Beater Speed) Set of 2	AMAH163931	\$ 74.00
15 9400, 9500, 9500SH, 9501, 9600	Beater Drive (100% Beater Speed) Set of 2	AMAH139436	\$ 61.00
16 9400 BSN 635101, 9500-9500SH BSN 635201, 9600 BSN 635301	Header and Reel Pump, Powershift	AMH125565	\$ 99.00
16 9400 ASN 635101, 9500-9500SH ASN 635201, 9501, 9600 ASN 635301	Header and Reel Pump, Powershift	AMH151952	\$ 102.00
17 9400, 9500, 9500SH, 9501, 9600	Front Chopper Drive	AMH125380	\$ 61.00
17 9400 BSN 640101	Chopper in Windrow or Forward Position	AME46113	\$ 31.00
17 9400 ASN 640101	Chopper in Windrow or Forward Position	AMH27433	\$ 28.00
17 9500-9500SH BSN 640201, 9501	Chopper in Windrow or Forward Position	AMP47885	\$ 37.53
17 9500-9500SH ASN 640201, 9600	Chopper in Windrow or Forward Position	AMH23950	\$ 43.00
17 9400	Chopper in Rear Operating Position	AMH101436	\$ 42.00
17 9500, 9500SH, 9501, 9600	Chopper in Rear Operating Position	AMH125381	\$ 57.00
17 9600	Chopper in Rear Operating Position, Fine Cut 2V Belt	AMH175434	\$ 145.00
18 9400	Straw Spreader	AMZ33774	\$ 58.00
18 9500, 9500SH, 9501, 9600	Straw Spreader	AMH128234	\$ 46.00
19 9400, 9500, 9500SH, 9501, 9600	New Feederhouse, w/ Reverser Fixed	AMH126345	\$ 113.00

John Deere®—Combine

Belts—9410, 9510, 9510SH, 9610

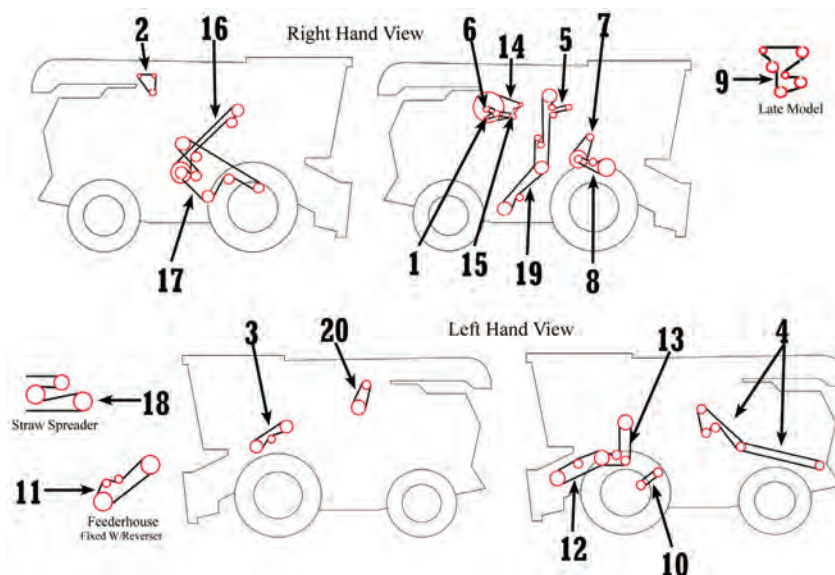

Application	Description	Part Number	Retail Price
1 9410, 9510, 9510SH	A/C Compressor	AMH80896	\$ 8.00
1 9610	A/C Compressor	AMH163515	\$ 47.94
2 9410, 9510, 9510SH	Alternator	AMH101813	\$ 12.84
2 9610	Alternator	AMH163515	\$ 47.94
3 9410, 9510, 9510SH, 9610	Beater Drive (75% Beater Speed) Set of 2	AMAH163931	\$ 74.00
3 9410, 9510, 9510SH, 9610	Beater Drive (100% Beater Speed) Set of 2	AMAH139436	\$ 61.00
4 9410, 9510, 9510SH, 9610	Chopper, Front	AMH125380	\$ 61.00
4 9610	Chopper, Front - Fine Cut	AMH22529	\$ 29.98
4 9410	Chopper, Windrow or Forward Position	AMH27433	\$ 28.00
4 9510, 9510SH, 9610	Chopper, Windrow or Forward Position	AMH23950	\$ 43.00
4 9410	Chopper, Rear Operating Position	AMH101436	\$ 42.00
4 9410, 9510, 9610	Chopper, Rear Operating Position - Fine Cut 2V Belt	AMH175434	\$ 145.00
4 9510, 9510SH, 9610	Chopper, Rear Operating Position	AMH125381	\$ 57.00
4 9610	Front Chopper Drive, Fine Cut	AMH157726	\$ 115.00
5 9610	Clean Grain Elevator	AMH141167	\$ 120.00
5 9410, 9410, 9510SH	Clean Grain Elevator	AMH160171	\$ 145.00
5 9610	Clean Grain Elevator	AMH135458	\$ 118.00
5 9610	Clean Grain Elevator	AMH141166	\$ 125.00
6 9410	Cooling Fan, High Power	AMH132808	\$ 14.42
6 9510, 9510SH	Cooling Fan, High Power	AMH160405	\$ 44.01
6 9410	Cooling Fan, Low Power	AMH132809	\$ 12.50
6 9510, 9510SH	Cooling Fan, Low Power	AMH161795	\$ 23.87
6 9510, 9510SH	Cooling Fan, Low Power	AMH132808	\$ 14.42
6 9610	Cooling Fan, High Power	AMH153297	\$ 50.07
7 9410	Cylinder, Intermediate Drive, Ext Range	AMH137670	\$ 245.00
7 9410, 9510, 9510SH, 9610	Cylinder, Intermediate Drive	AMH210476	\$ 260.00
8 9410	Cylinder Drive, Extended Range	AMH145994	\$ 139.00
8 9410, 9510, 9510SH, 9610	Cylinder Drive, Reg Dual & Single Range	AMH115881	\$ 161.80

John Deere®—Combine

John Deere®—Combine

Application	Description	Part Number	Retail Price
8 9410, 9510, 9510SH, 9610	Cylinder Drive, Slow Speed	AMH118618	\$ 150.00
9 9610	Alternator	AMH163515	\$ 47.94
10 9410, 9510, 9510SH, 9610	Fan Drive, 490-980 RPM, Slow Speed	AMH152180	\$ 72.00
10 9410, 9510, 9510SH, 9610	Fan Drive, 750-1350 RPM, Regular Speed	AMH152146	\$ 75.00
11 9410, 9510, 9510SH, 9610	Feederhouse, Fixed Speed w/ Reverser	AMH126345	\$ 113.00
12 9410, 9510, 9510SH, 9610	Feederhouse, Variable Speed	AMH161648	\$ 170.00
13 9410, 9510, 9510SH, 9610	Header and Reel Pump, Powershift	AMH151952	\$ 102.00
14 9410, 9510, 9510SH, 9610	Rotary Screen	AMH145158	\$ 39.00
15 9410, 9510, 9510SH, 9610	Rotary Screen Drive	AMH146636	\$ 10.09
16 9410, 9510, 9510SH, 9610	Secondary Countershaft	AMH128010	\$ 62.00
17 9410, 9510, 9510SH, 9610	Shoe, Straw Walker and Conveyor Augers	AMH131169	\$ 110.00
18 9410	Straw Spreader	AMZ33774	\$ 58.00
18 9510, 9510SH, 9610	Straw Spreader	AMH128234	\$ 46.00
18 9510, 9510SH	Straw Spreader, Deck Drive	AMM95728	\$ 45.02
19 9410, 9510, 9510SH, 9610	Tailings Auger and Elevator, Lower	AMN110085	\$ 55.00
20 9410, 9510SH, 9610	Unloading System Set of 2	AMAH158880	\$ 60.00
NI 9410, 9510, 9510SH, 9610	Air Flow Drive	AMH164452	\$ 11.75

Belts—9450, 9550, 9550SH, 9560, 9560SH, 9650, 9660

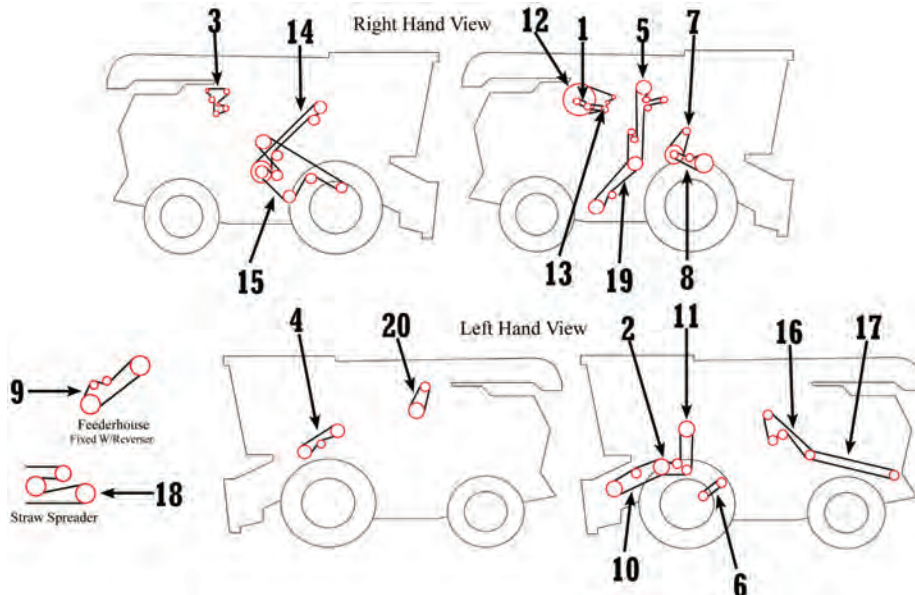

Application	Description	Part Number	Retail Price
1 9450	Air Conditioning Compressor	AMH101813	\$ 12.84
1 9450	Cooling Fan	AMH132808	\$ 14.42
1 9450, 9550SH	Cooling Fan	AMH160405	\$ 44.01
1 9650	Cooling Fan	AMH175467	\$ 26.40
1 9650 BSN 695300	Cooling Fan	AMH153297	\$ 50.07
1 9650 ASN 695301, 9660	Cooling Fan	AMH177186	\$ 40.34
2 9450, 9550, 9560, 9650, 9660	Air Flow Drive	AMH171386	\$ 25.14
3 9450	Alternator - 95 AMP	AMR502418	\$ 48.31
3 9550SH, 9650, 9660	Alternator - 95 AMP	AMH163515	\$ 47.94

Prices Subject to Change without Prior Notice. The use of original equipment manufacturer (OEM) part numbers or trademarks, e.g. Case® and John Deere®, are for reference purposes only and for indicating product use and compatibility. Our company and the listed replacement parts contained herein are not sponsored, approved or manufactured by the OEM. All parts are New unless designated Reman in the description.

John Deere®—Combine

Application	Description	Part Number	Retail Price
3 9560SH	Alternator - 95 AMP	AMR500380	\$ 51.11
3 9450	Alternator - 185 AMP	AMR502417	\$ 46.98
3 9550SH, 9650 BSN 695300	Alternator - 185 AMP	AMH166870	\$ 50.58
3 9560SH	Alternator - 185 AMP	AMH205240	\$ 49.68
3 9650 ASN 695301, 9660	Alternator - 185 AMP	AMR164820	\$ 26.93
4 9560SH, 9660	Beater Drive (75% Beater Speed) Set of 2	AMAH163931	\$ 74.00
4 9450, 9550SH, 9560SH, 9650, 9660	Beater Drive (100% Beater Speed) Set of 2	AMAH139436	\$ 61.00
5 9450, 9550SH, 9560SH, 9650, 9660	Clean Grain Elevator	AMH141166	\$ 125.00
6 9450, 9550SH, 9560SH, 9650, 9660	Fan Drive, 490-980 RPM	AMH152180	\$ 72.00
6 9450, 9550SH, 9560SH, 9650, 9660	Fan Drive, 750-1350 RPM	AMH152146	\$ 75.00
7 9450 (150-980 RPM), 9550SH, 9560SH, 9650, 9660	Cylinder, Intermediate Drive	AMH210476	\$ 260.00
7 9450 (300-1000 RPM)	Cylinder, Intermediate Drive	AMH137670	\$ 245.00
8 9450, 9550SH, 9560SH, 9650, 9660	Cylinder Drive, 240-960 RPM	AMH115881	\$ 161.80
8 9550, 9550SH, 9560, 9560SH, 9650, 9660	Cylinder Drive, 150-500 RPM	AMH118618	\$ 150.00
9 9450, 9550 SN 700200, 9550SH BSN 700700, 9650	Feederhouse w/ Reverser, Fixed Speed	AMH126345	\$ 113.00
9 9550 BSN 700200, 9550SH BSN 700700, 9650	Feederhouse w/ Reverser, Fixed Speed	AMH156796	\$ 140.00
9 9660	Feederhouse w/ Reverser, Fixed Speed	AMH203473	\$ 109.28
9 (9560, 9560SH ASN 710311), 9660	Feederhouse, Fixed Speed	AMH174885	\$ 245.00
10 9450, 9550 BSN 700200, 9550SH BSN 700700, 9650	Feederhouse, Variable Speed	AMH161648	\$ 170.00
10 9550 BSN 700200, 9550SH BSN 700700, 9650	Feederhouse, Variable Speed - Standard Capacity	AMH205167	\$ 215.00
10 9560SH, 9660	Feederhouse, Variable Speed - Standard Capacity	AMH203393	\$ 215.00
10 9550, 9560, 9650, 9660	Feederhouse, Variable Speed - High Capacity	AMH218728	\$ 234.00
11 9450, 9550SH, 9560SH, 9650, 9660	Header and Reel Pump - Standard Capacity	AMH151952	\$ 102.00
11 9550, 9560, 9650, 9660	Header and Reel Pump - High Capacity	AMH155998	\$ 142.00
12 9450, 9550SH, 9650	Rotary Screen	AMH145158	\$ 39.00
12 9560SH, 9660	Rotary Screen	AMH175632	\$ 20.87
13 9450, 9650, 9660	Rotary Screen Drive	AMH146636	\$ 10.09
13 9550SH	Rotary Screen Drive	AMH160406	\$ 9.60
13 9560SH	Rotary Screen Drive	AMH177589	\$ 11.02
14 9450, 9550SH, 9560SH, 9650, 9660	Secondary Countershaft	AMH128010	\$ 62.00
15 9450, 9550SH, 9560SH, 9650, 9660	Shoe, Straw Walker and Conveyor Augers	AMH131169	\$ 110.00
16 9450, 9550SH, 9560SH, 9650, 9660	Straw Chopper, Front	AMH157726	\$ 115.00
17 9450	Straw Chopper, Long Rear	AMH101436	\$ 42.00
17 9450	Straw Chopper, Short Rear	AMH27433	\$ 28.00
17 9550SH, 9560SH, 9650, 9660	Straw Chopper, Rear Operating Position, Fine Cut 2V Belt	AMH175434	\$ 145.00
17 9550SH, 9560SH, 9650, 9660	Straw Chopper, Standard	AMH160654	\$ 64.00
17 9550SH, 9560SH, 9650, 9660	Straw Chopper, Standard Bailing	AMH23950	\$ 43.00
17 9560SH, 9650, 9660 (Fine Cut Bailing)	Straw Chopper, Windrow	AMH22529	\$ 29.98
18 9450	Straw Spreader	AMZ33774	\$ 58.00
18 9550SH, 9560SH, 9650, 9660	Straw Spreader	AMH128234	\$ 46.00
19 9450, 9550SH, 9560SH, 9650, 9660	Tailings Auger & Elevator, Lower	AMN110085	\$ 55.00
20 9450, 9550SH, 9560SH, 9650, 9660	Unloading System Set of 2	AMAH158880	\$ 60.00

John Deere®—Combine

Belts—9560, 9570, 9650, 9660, 9670, 9750, 9760, 9770, 9860, 9870 – STS

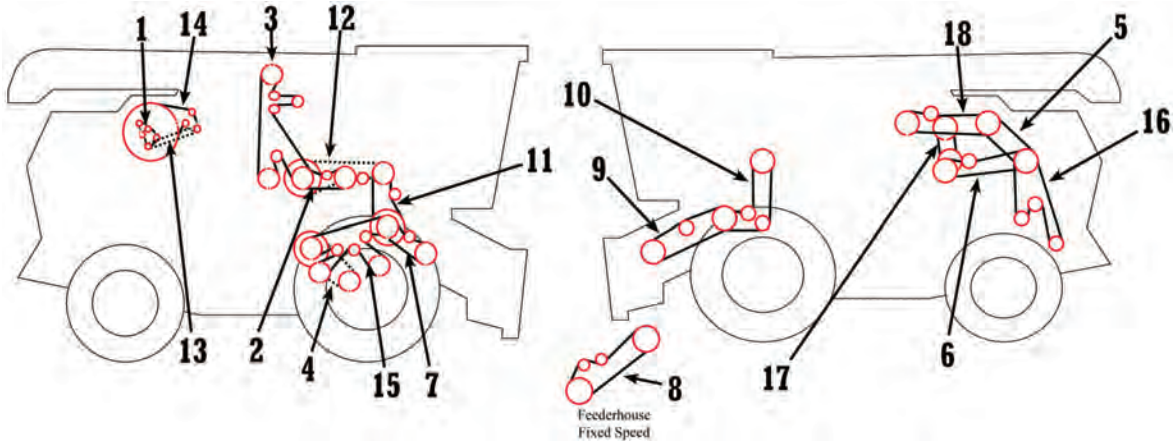

Application	Description	Part Number	Retail Price
1 9560, 9650, 9660, 9750, 9760	Alternator - 95 AMP	AMR135606	\$ 38.28
1 9560, 9650, 9660, 9750, 9760	Alternator - 185 AMP	AMR135609	\$ 48.00
1 9560	Alternator - 200 AMP	AMR135607	\$ 47.02
1 9570	Alternator - 200 AMP	AMR521053	\$ 52.49
1 9660, 9670, 9760, 9770	Alternator - 200 AMP	AMAT262958	\$ 66.00
1 9860, 9870	Alternator	AMR503505	\$ 43.91
1 9860, 9870	Engine Fan	AMR503312	\$ 66.36
2 9560, 9570, 9650, 9660, 9670, 9750, 9760, 9770, 9860, 9870	Tailings Auger and Elevator	AMH154731	\$ 36.00
2 9560, 9570, 9660, 9670, 9760, 9770, 9860, 9870	Edible Bean	AMCP72	\$ 24.27
3 9560, 9570, 9650, 9660, 9670, 9750, 9760, 9860	Clean Grain Elevator	AMH206738	\$ 118.00
3 9770, 9870	Clean Grain Elevator	AMH223230	\$ 207.00
4 9650, 9750	Cleaning Fan	AMH165072	\$ 71.00
4 9560, 9660, 9670, 9760, 9770, 9860	Cleaning Fan	AMH206048	\$ 68.00
4 9570STS, 9870STS	Cleaning Fan	AMH230909	\$ 72.00
4 9560, 9660, 9760, 9860	Cleaning Fan, Slow Speed	AMH211601	\$ 75.00
4 9570, 9670, 9770, 9870	Cleaning Fan, Slow Speed	AMH215389	\$ 69.00
5 9560, 9570, 9650, 9660, 9670, 9750, 9760, 9770, 9860, 9870	Countershaft, Discharge Beater and Chopper 2 Banded Belt	AMHXE15671	\$ 100.00
5 9670, 9770, 9870 - Standard Duty	Countershaft, Discharge Beater and Chopper 2 Banded Belt	AMHXE10556	\$ 142.00
5 9770, 9870 - Heavy Duty	Countershaft, Discharge Beater and Chopper 3 Banded Belt	AMHXE10501	\$ 215.00
5 9860 Heavy Duty	Countershaft, Discharge Beater & Chopper 3 Banded Belt	AMH201596	\$ 171.00
6 9560, 9570, 9650, 9660, 9670, 9750, 9760, 9770, 9860, 9870	Discharge Beater	AMH168301	\$ 63.00
7 9560 BSN 715301, 9650, 9660 BSN 715401, 9750, 9760 BSN 715501, 9860 BSN 715601	Feed Accelerator, Standard Speed	AMH204133	\$ 111.67
7 9560 ASN 715301, 9570, 9660 ASN 715401, 9670, 9760 ASN 715501, 9770, 9860 ASN 715601, 9870	Feed Accelerator, Standard Speed Replaces H211581, H236472	AMHXE95511	\$ 103.00
7 9560, 9570, 9650, 9660, 9670, 9750, 9760, 9770, 9860, 9870	Feed Accelerator, Slow Speed Replaces H221732	AMH216026	\$ 125.00
7 9560STS, 9650STS, 9660STS BSN 715401, 9670STS, 9750STS, 9760STS BSN 715501, 9770STS, 9860STS BSN 715601, 9870STS	Feed Accelerator Drive, Standard Speed Replaces H211581, H236475	AMH221731	\$ 123.00

John Deere®—Combine

John Deere®—Combine

Application	Description	Part Number	Retail Price
7 9660, 9670, 9760, 9770, 9860, 9870 BSN 730101	Feed Accelerator, High Speed 2V Belt Replaces H205209, H216027	AMH221733	\$ 135.00
7 (9670, 9770, 9870 ASN 730101), 9860	Feed Accelerator, High Speed 3V Belt Replaces H230230	AMHXE54503	\$ 145.00
8 9650-9750 BSN 695601	Feederhouse, Fixed Speed	AMH111519	\$ 82.31
8 9650-9750 ASN 695601	Feederhouse, Fixed Speed	AMH125565	\$ 99.00
8 9560	Feederhouse, Fixed Speed	AMH126345	\$ 113.00
8 9560, 9570, 9660, 9670, 9760, 9770	Feederhouse, Fixed Speed For Standard Duty or Standard Capacity	AMH203474	\$ 93.00
8 9670, 9770, 9870	Feederhouse, Fixed Speed - Multi Speed Drive	AMH229019	\$ 275.00
8 9560, 9660, 9760, 9770, 9860, 9870	Feederhouse, Fixed Speed	AMH174885	\$ 245.00
9 9650-9750 BSN 695601	Feederhouse, Variable Speed - Standard Capacity	AMH157732	\$ 207.00
9 9650-9750 ASN 695601	Feederhouse, Variable Speed - Standard Capacity	AMH205169	\$ 199.00
9 9560, 9570, 9660	Feederhouse, Variable Speed - Standard Capacity	AMH201334	\$ 192.00
9 (9560, 9570, 9660, 9750, 9760 - Heavy Duty or High Capacity), (9670, 9770 - Standard or High Capacity), 9860 Standard Capacity	Feederhouse, Variable Speed	AMH218726	\$ 270.00
9 9660, 9670, 9760, 9770, 9860 High Speed - w/o Hydraulic Fore/Aft Tilt	Feederhouse, Variable Speed, High Torque	AMH220911	\$ 337.00
10 9560, 9570	Header and Reel Pump - Standard Capacity	AMH126345	\$ 113.00
10 9650, 9660, (9670, 9770 Fixed Speed), 9750, 9760, 9860	Header and Reel Pump, Fixed Spd Drive - Standard Capacity	AMH156796	\$ 140.00
10 9560, 9570	Header and Reel Pump - High Capacity	AMH209507	\$ 233.00
10 9650, 9660, (9670, 9770 - Variable Speed), 9750, 9760, 9860, 9870	Header and Reel Pump - High Capacity	AMH156541	\$ 225.10
10 9670, 9770, 9870 (Multi Speed)	Header and Reel Pump	AMH229018	\$ 300.00
11 9650, 9660, 9670, 9750, 9760, 9770, 9860, 9870	RH Jackshaft - Front Set of 2	AMAH150678	\$ 105.00
11 9560, 9570	RH Jackshaft - Front Set of 2	AMAH202773	\$ 100.00
11 9570, 9660, 9670, 9760, 9770, 9860	Edible Bean - Front	AMCP144	\$ 47.81
12 9560, 9570, 9650, 9660, 9670, 9750, 9760, 9770, 9860, 9870	RH Jackshaft - Rear	AMH154723	\$ 80.00
12 9870	RH Jackshaft, Edible Bean - Rear	AMCP144	\$ 47.81
13 9650-9750 BSN 695601	Rotary Screen Drive - Engine Side	AMH157104	\$ 15.08
13 9560	Rotary Screen Drive - Engine Side	AMH201498	\$ 13.38
13 9570, 9660 ASN 715401, 9670, 9760 ASN 715501, 9770, 9860 ASN 715601, 9870	Rotary Screen Drive - Engine Side	AMH213353	\$ 21.11
13 9650 ASN 695601, 9660 BSN 715401, 9750 ASN 695601, 9760 BSN 715501, 9860 BSN 715601	Rotary Screen Drive - Engine Side	AMH206807	\$ 15.10
14 9650-9750 BSN 695601	Rotary Screen Drive - Screen Side	AMH157105	\$ 46.89
14 9560	Rotary Screen Drive - Screen Side	AMH175632	\$ 20.87
14 9570, 9670, 9770, 9870	Rotary Screen Drive - Screen Side	AMH221273	\$ 31.09
14 9650 ASN 695601, 9660 BSN 715401, 9750 ASN 695601, 9760 BSN 715501, 9860 BSN 715601	Rotary Screen Drive - Screen Side	AMH175628	\$ 28.00
14 9660 ASN 715401, 9760 ASN 715501, 9860 ASN 715601	Rotary Screen Drive - Screen Side	AMH214241	\$ 31.74
15 9560, 9570, 9650, 9660, 9670, 9750, 9760, 9770, 9860, 9870	Shoe Fan & Conveyor Augers	AMH175587	\$ 150.00
16 9560, 9570, 9650 ASN 700501, 9660, 9670 (CIS), 9750 ASN 700501, 9760, 9770 (CIS), 9870 (CIS)	Straw Chopper	AMH235564	\$ 140.00

John Deere®—Combine

Application	Description	Part Number	Retail Price
16 (9650, 9750 BSN 700501)	Straw Chopper	AMH201571	\$ 113.00
16 9670	Straw Chopper	AMH232997	\$ 110.00
16 9770, 9870	Straw Chopper	AMH223212	\$ 160.00
16 9860 (Premium Grain)	Straw Chopper	AMH174368	\$ 205.00
16 9860	Straw Chopper Drive	AMH220747	\$ 178.00
17 9560, 9570, 9650, 9660, 9670, 9750, 9760	Variable Rotor Drive	AMH221498	\$ 405.00
17 9860 BSN 705798	STS Variable Drive	AMH207851	\$ 685.00
17 9770, 9860 ASN 705798, 9870	STS Variable Drive Replaces H208431	AMHXE63990	\$ 625.00
17 9660, 9670, 9760 - w/ Regular Sheaves	Rotor Drive	AMHXE46027	\$ 445.00
18 9560, 9570, 9650, 9660, 9670, 9750, 9760, 9770, 9860, 9870	Unloading Auger System Set of 2	AMAH160080	\$ 85.00

Belts—9650CTS, 9660CTS, CTS, CTS II, CTS Rice

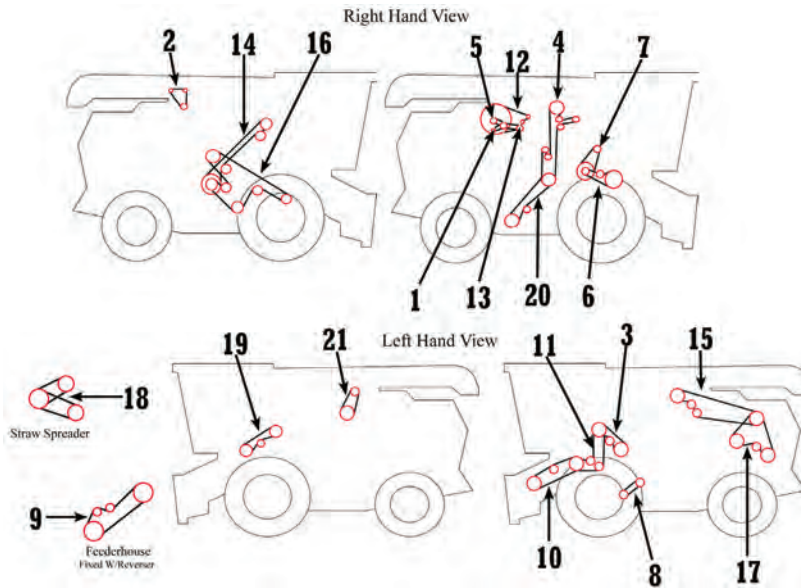

Application	Description	Part Number	Retail Price
1 CTS, CTS Rice, CTS II	Air Conditioning Compressor 58" OD	AMH134437	\$ 11.75
2 CTS, CTS Rice, CTS II	Alternator	AMH101813	\$ 12.84
2 9650CTS BSN 695401	Alternator - 95 AMP	AMH163515	\$ 47.94
2 9650CTS BSN 695401	Alternator - 185 AMP	AMH166870	\$ 50.58
2 9650CTS ASN 695401	Alternator - 185 AMP	AMR164820	\$ 26.93
3 CTS, CTS Rice, CTS II	Beater Drive	AMH143700	\$ 24.58
3 9650CTS	Overshot Beater Drive, 740-1170 RPM	AMH165708	\$ 83.17
3 9650CTS	Overshot Beater Drive, 400 RPM Slow Down Kit	AME16774	\$ 35.79
3 9650CTS	Overshot Beater Drive, 700 RPM Slow Down Kit	AMN121116	\$ 33.45
3 9650CTS	Overshot Beater Drive	AMH139963	\$ 15.13
4 9650CTS, 9660CTS	Clean Grain Elevator	AMH141166	\$ 125.00
4 CTS, CTS Rice	Clean Grain Elevator	AMH141167	\$ 120.00
4 CTS II	Clean Grain Elevator	AMH160171	\$ 145.00
5 CTS, CTS Rice	Cooling Fan, High Power	AMH153297	\$ 50.07
5 9650CTS BSN 695401, CTS II	Cooling Fan	AMH160405	\$ 44.01
5 9650CTS ASN 695401	Cooling Fan	AMH177186	\$ 40.34

Prices Subject to Change without Prior Notice. The use of original equipment manufacturer (OEM) part numbers or trademarks, e.g. Case® and John Deere®, are for reference purposes only and for indicating product use and compatibility. Our company and the listed replacement parts contained herein are not sponsored, approved or manufactured by the OEM. All parts are New unless designated Reman in the description.

John Deere®—Combine

Application	Description	Part Number	Retail Price
6 9650CTS	Cylinder Drive - 109" OD	AMH145994	\$ 139.00
6 9650CTS, 9660CTS, CTS, CTS Rice, CTS II	Cylinder Drive, Reg Dual & Single Range - 111.50" OD	AMH115881	\$ 161.80
6 9650CTS, 9660CTS, CTS, CTS Rice, CTS II	Cylinder Drive, Slow Speed - 107" OD	AMH118618	\$ 150.00
7 9650CTS, 9660CTS, CTS, CTS Rice, CTS II	Cylinder, Intermediate Drive - 2.50" Wide	AMH210476	\$ 260.00
7 9650CTS	Cylinder, Intermediate Drive - 3" Wide	AMH137670	\$ 245.00
8 CTS BSN 670401	Fan Drive, Regular, 750-1350 RPM	AMH140404	\$ 67.00
8 9650CTS, 9660CTS, CTS ASN 670401, CTS II	Fan Drive, Regular, 750-1350 RPM	AMH152146	\$ 75.00
8 CTS BSN 670401	Fan Drive, Slow Speed, 490-980 RPM	AMH137264	\$ 67.00
8 9650CTS, 9660CTS, CTS ASN 670401, CTS II	Fan Drive, Slow Speed, 490-980 RPM	AMH152180	\$ 72.00
9 9650CTS BSN 700401, CTS, CTS Rice, CTS II	Feederhouse, Fixed Speed w/ Reverser	AMH126345	\$ 113.00
9 9650CTS ASN 700401	Feederhouse, Fixed Speed w/ Reverser	AMH156796	\$ 140.00
10 9650CTS BSN 700401, CTS, CTS II, CTS Rice (w/ Rev)	Feederhouse, Variable Speed - Standard	AMH161648	\$ 170.00
10 9650 ASN 700401	Feederhouse, Variable Speed - Standard Capacity	AMH205167	\$ 215.00
10 9660CTS	Feederhouse, Variable Speed - Standard	AMH203393	\$ 215.00
10 9650CTS, 9660CTS	Feederhouse, Variable Speed - High Capacity	AMH218728	\$ 234.00
11 9650CTS, 9660CTS, CTS, CTS Rice, CTS II	Header and Reel Pump - Standard Capacity	AMH151952	\$ 102.00
11 9650CTS, 9660CTS	Header and Reel Pump - High Capacity	AMH155998	\$ 142.00
12 CTS, CTS Rice	Rotary Screen	AMH143869	\$ 53.50
12 9650CTS BSN 695401, CTS II	Rotary Screen	AMH145158	\$ 39.00
12 9650CTS ASN 695401	Rotary Screen	AMH175632	\$ 20.87
13 CTS, CTS Rice	Rotary Screen Drive	AMH134216	\$ 20.57
13 9650CTS ASN 695401, CTS II	Rotary Screen Drive	AMH146636	\$ 10.09
13 9650CTS BSN 695401	Rotary Screen Drive	AMH160406	\$ 9.60
14 9650CTS, 9660CTS, CTS, CTS Rice, CTS II	Secondary Countershaft	AMH128010	\$ 62.00
15 CTS, CTS Rice, CTS II	Separator Fan Drive	AMH141429	\$ 281.00
15 9650CTS	Tine Separator Drive	AMH163106	\$ 290.50
16 9650CTS, 9660CTS, CTS, CTS Rice, CTS II	Shoe, Straw Walker and Conveyor Augers	AMH131169	\$ 110.00
17 CTS II	Straw Chopper, Front - Fine Cut	AMH155525	\$ 129.76
17 CTS, CTS Rice, CTS II	Straw Chopper, Front	AMH168301	\$ 63.00
17 9650CTS	Straw Chopper Drive	AMH162727	\$ 155.23
18 CTS, CTS Rice, CTS II	Straw Spreader - 53" OD	AME61326	\$ 14.65
18 9650CTS, CTS, CTS Rice, CTS II	Straw Spreader, Lower	AMP49604	\$ 25.90
18 9650CTS	Straw Spreader, Upper	AMH164870	\$ 17.83
18 CTS II	Chaff Spreader Drive	AMM95728	\$ 45.02
19 CTS, CTS Rice, CTS II	Stripper Beater Drive	AMH139963	\$ 15.13
19 9650CTS	Stripper Beater Drive	AMH165708	\$ 83.17
20 9650CTS, 9660CTS, CTS, CTS Rice, CTS II	Tailings Auger and Elevator, Lower	AMN110085	\$ 55.00
21 9650CTS, 9660CTS, CTS, CTS Rice, CTS II	Unloading System Set of 2	AMAH158880	\$ 60.00
NI 9660CTS	Air Flow Drive	AMH164452	\$ 11.75

John Deere®—Combine

Belts—S550, S650, S660, S660HM, S670, S670HM, S680, S680HM, S690, S690HM

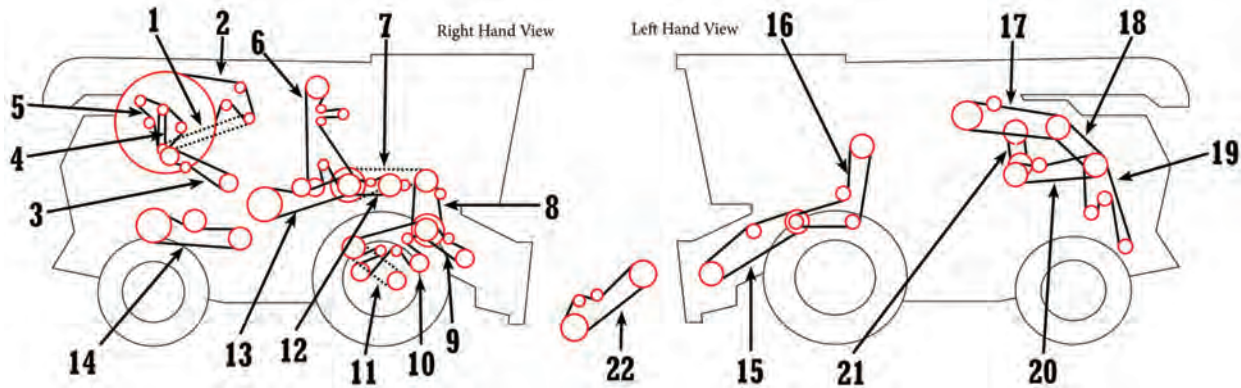

Application	Description	Part Number	Retail Price
1 S550 MY18	Air Screen Drive, Engine Side	AMH213353	\$ 21.11
1 S650, S660, S670, S670HM, S680, S680HM, S690, S690HM - MY18	Air Screen Drive, Engine Side	AMH238867	\$ 19.49
2 S550, S650, S660, S670, S670HM, S680, S680HM, S690, S690HM - MY18	Air Screen Drive, Screen Side	AMH221273	\$ 31.09
3 S650, S660, S670, S670HM - MY18	Vacuum Fan Drive, Upper Replaces HXE24085	AMHXE68015	\$ 16.77
3 S660, S670, S670 - MY18	Vacuum Fan, Lower	AMHXE24086	\$ 15.50
3 S680, S680HM, S690, S690HM - MY18	Vacuum Fan Drive	AMHXE38073	\$ 13.73
4 S550 MY18	Fan and Alternator	AMR521053	\$ 52.49
4 S650, S660, S670, S670HM - MY18	Fan Belt	AMHXE22617	\$ 52.05
4 S680, S680HM, S690, S690HM - MY18	Fan Belt	AMHXE32548	\$ 34.06
5 S650, S660, S670, S670HM - MY18	Alternator	AMH238822	\$ 32.95
5 S680, S680HM, S690, S690HM - MY18	Alternator	AMH238831	\$ 31.35
6 S550, S650, S660 - MY18	Clean Grain Elevator	AMH206738	\$ 118.00
6 S670, S670HM, S680, S680HM, S690HM - MY18	Clean Grain Elevator	AMH223230	\$ 207.00
6 S690 MY18	Clean Grain Elevator	AMHXE20763	\$ 195.00
7 S550, S650, S660, S670, S670HM, S680, S680HM, S690, S690HM - MY18	RH Separator Jackshaft, Rear	AMH154723	\$ 80.00
8 S550 MY18	RH Separator Jackshaft, Front Set of 2	AMAXE13650	\$ 105.00
8 S650, S660, S670, S670HM, S680, S680HM, S690, S690HM - MY18	RH Separator Jackshaft, Front Set of 2	AMAH150678	\$ 105.00
9 S550, S650, S660, S670, S670HM, S680, S680HM, S690, S690HM - MY18	Feed Accelerator, STD Speed Replaces H211581, H236472	AMHXE95511	\$ 103.00
9 S550, S650, S660, S670, S670HM, S680, S680HM, S690, S690HM - MY18	Feed Accelerator, Slow Speed Replaces H221732	AMH216026	\$ 125.00
9 S660 SN 745100-765171, (S670, S680, S690 SN 745100-785000), (S670HM, S680HM BSN 765000), S690HM SN 745101-765000 - All MY18	Feed Accelerator, High Speed 3V Belt Replaces H230230	AMHXE54503	\$ 145.00
10 S550, S650, S660, S670, S670HM, S680, S680HM, S690, S690HM - MY18	Shoe Fan & Conveyor Augers	AMH175587	\$ 150.00
11 S550, (S650, S660, S670, S680, S690 BSN 785000), S670HM, S680HM, S690HM - All MY18	Cleaning Fan Drive	AMHXE15594	\$ 78.00
11 (S650, S660, S670, S680 ASN 785001), S690 - All MY18	Cleaning Fan Drive	AMHXE99294	\$ 85.00
12 S550, S650, S660, S670, S670HM - MY18	Tailings Elevator Drive	AMH154731	\$ 36.00
13 S680, S680HM, S690, S690HM - MY18	Tailings Rethresher Drive	AMH240895	\$ 62.00
14 S670, S670HM, S680, S680HM, S690, S690HM - MY18	Overshot Beater Drive	AMH240895	\$ 62.00

Prices Subject to Change without Prior Notice. The use of original equipment manufacturer (OEM) part numbers or trademarks, e.g. Case® and John Deere®, are for reference purposes only and for indicating product use and compatibility. Our company and the listed replacement parts contained herein are not sponsored, approved or manufactured by the OEM. All parts are New unless designated Reman in the description.

John Deere®—Combine

Application	Description	Part Number	Retail Price
15 S550, S650, S660	Feederhouse, Variable Speed, Heavy Duty or High Capacity	AMH218726	\$ 270.00
15 S660, S670, S670HM, S680 SN 766007-785000 - w/o Hydraulic Fore/Aft Tilt	Feederhouse, Variable Speed, High Torque	AMH220911	\$ 337.00
16 S550 MY18	Front End Dr Clutch to Feederhouse, STD Duty	AMHXE16928	\$ 155.00
16 S550 MY18	Front End Dr Clutch to Feederhouse, Heavy Duty	AMHXE16927	\$ 160.00
16 S650, S660, S670, S670HM, S680, S680HM, S690 ASN 745100-765252, S690HM - MY18	Front End Dr Clutch to Feederhouse, Heavy Duty	AMH156541	\$ 225.10
16 S670, S680, S690 - MY18	Front End Dr 5 Spd to Feederhouse	AMH229018	\$ 300.00
17 S550, S650, S660, S670, S670HM - MY18	Unloading Auger System Set of 2	AMAH160080	\$ 85.00
17 S680, S680HM, S690, S690HM - MY18	Unloader Drive Set of 2	AMAH233198	\$ 125.00
18 S550 MY18	Chopper Drive, Upper 2 Banded Belt	AMHXE15671	\$ 100.00
18 S650, S660, S670, S670HM, S680, S680HM, S690, S690HM - MY18	Chopper Drive, Upper Fine Cut Replaces HXE124868	AMHXE124868	\$ 343.00
18 S670, S670HM - MY18	Chopper Drive, Upper Extra Fine Cut	AMH241000	\$ 238.00
18 S680, S680HM, S690, S690HM - MY18	Chopper Drive, Upper Extra Fine Cut	AMH240888	\$ 305.00
19 S550 MY18	Chopper Drive, Lower	AMH235564	\$ 140.00
19 S650, S660, S670, S670HM, S680, S680HM, S690, S690HM - MY18 w/ Manual or Powercast Tail Board	Chopper Drive, Lower Fine Cut (2) Required Replaces HXE124869	AMHXE124869	\$ 335.00
19 S650, S660, S670, S670HM, S680, S680HM, S690, S690HM - MY18	Chopper Drive, Lower Extra Fine Cut	AMH240974	\$ 235.00
19 S650, S660, S670HM, S670HM, S680, S680HM, S690, S690HM - MY18	Chopper Drive, Lower Extra Fine Cut	AMH240972	\$ 67.00
20 S550 MY18	Discharge Beater Drive	AMH168301	\$ 63.00
20 S650, S660 - MY18	Discharge Beater Drive	AMHXE15556	\$ 87.00
20 S660, S670, S680, S680HM, S690, S690HM - MY18	Discharge Beater Drive Fine Cut	AMHXE124870	\$ 215.00
20 S670, S670HM, S680, S680HM, S690, S690HM - MY18	Discharge Beater Drive Set of 2	AMAH236689	\$ 165.00
21 S550, S560 - MY18	Rotor Drive	AMH221498	\$ 405.00
21 S650, S660, S670 ASN 765252, S760 - MY18 w/ Regular Sheaves	Rotor Drive	AMHXE46027	\$ 445.00
21 S670, S670HM, S680, S680HM, S690, S690HM - MY18	Rotor Drive Replaces H208431	AMHXE63990	\$ 625.00
22 S550, S650 BSN 785001, S660 BSN 765172	Feederhouse, Fixed Speed For Standard Duty or Standard Capacity	AMH203474	\$ 93.00
22 S650 Heavy Duty and High Torque, (S660 Standard and Heavy Duty BSN 765172 or High Torque w/o Hydraulic Fore/Aft Tilt), (S670, S670HM, S680, S680MH, S690, S690HM - High Torque w/o Hydraulic Fore/Aft Tilt)	Feederhouse, Fixed Speed	AMH174885	\$ 245.00
22 S670, S680, S690 - MY18	Feederhouse, Fixed 5 Speed	AMH229019	\$ 275.00

John Deere®—Combine

Belts—S760, S770, S780, S785, S790

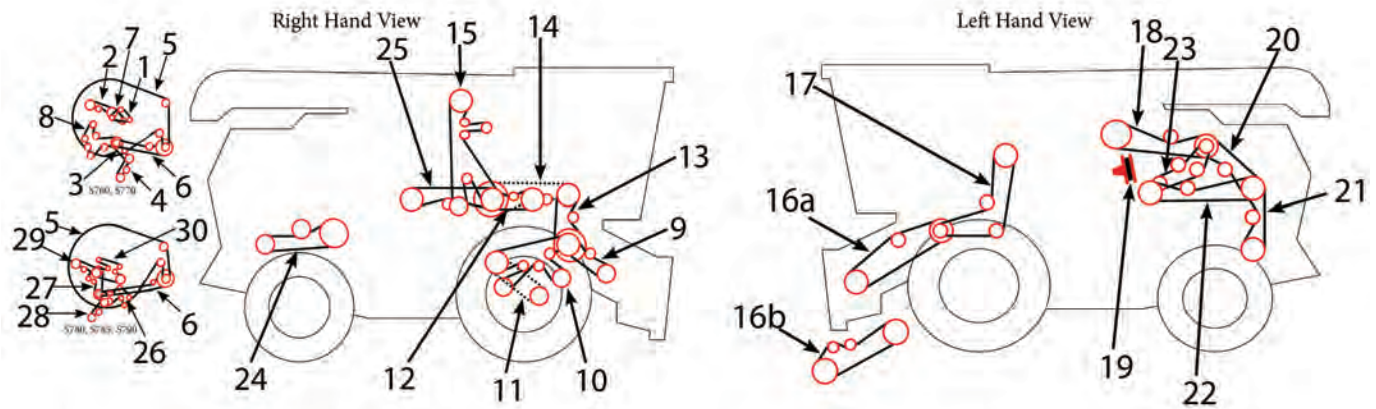

Application	Description	Part Number	Retail Price
1 S760, S770 - MY18	Air Compressor Drive (Tier 2)	AMR307304	\$ 31.00
2 S760, S770 - MY18	Air Compressor Drive (Tier 4)	AMHXE71043	\$ 32.00
3 S760, S770 - MY18	Vacuum Fan Drive, Upper Replaces HXE24085	AMHXE68015	\$ 16.77
4 S760, S770 - MY18	Vacuum Fan Drive, Lower	AMHXE68016	\$ 15.50
5 S760, S770, S780, S785, S790 - MY18	Air Screen Drive, Screen Side	AMH221273	\$ 31.09
6 S760, S770, S780, S785, S790 - MY18	Air Screen Drive, Engine Side	AMH238867	\$ 19.49
7 S760, S770 - MY18	Fan Belt, Variable Speed (Tier 4)	AMHXE22617	\$ 52.05
8 S760, S770 - MY18	Engine Front Drive (Tier 2)	AMHXE32806	\$ 43.00
8 S760, S770 - MY18	Engine Front Drive (Tier 4)	AMH238822	\$ 32.95
9 S760, S770, S780, S785, S790 - MY18	Feed Accelerator Stone Trap Drive, Standard Speed	AMHXE95511	\$ 103.00
9 S760, S770, S780, S785, S790 - MY18	Feed Accelerator Stone Trap Drive, High Speed 3V Belt Replaces H230230	AMHXE54503	\$ 145.00
9 S760, S770, S780, S790 - MY18	Feed Accelerator Stone Trap Drive, Slow Speed Replaces H221732	AMH216026	\$ 125.00
10 S760, S770, S780, S785, S790 - MY18	Conveyor Auger Drive	AMHXE102288	\$ 410.00
11 S760, S770, S780, S785, S790 - MY18	Cleaning Fan Drive	AMHXE99294	\$ 85.00
12 S760, S770 - MY18	Tailings Elevator Drive	AMH154731	\$ 36.00
13 S760, S770, S780, S785, S790 - MY18	Separator Jackshaft Drive, Front	AMHXE88564	\$ 160.00
14 S760, S770, S780, S785, S790 - MY18	Separator Jackshaft Drive, Rear	AMH154723	\$ 80.00
15 S760, S770 ASN 1JZS770110000 - MY18	Clean Grain Elevator Drive	AMH206738	\$ 118.00
15 S770 ASN 1H0S770800001, S780, S785, S790 ASN 1Z0S790110000 - MY18	Clean Grain Elevator Drive	AMH223230	\$ 207.00
15 S790 ASN 1H0S790800001 - MY18	Clean Grain Elevator Drive	AMHXE20763	\$ 195.00
16a S760 w/o Hydraulic Fore/Aft Tilt	Feeder House, Variable Speed, Heavy Duty	AMH218726	\$ 270.00
16a S760, S770 - MY18	Feeder House, Variable Speed High Torque w/ Fore-Aft Tilt	AMHXE50399	\$ 393.00
16a S760, S770 - w/o Hydraulic Fore/Aft Tilt	Feederhouse, Variable Speed High Torque w/o Fore-Aft Tilt	AMH220911	\$ 337.00
16a S770, S780, S785, S790 - MY18	Feeder House, Fixed 5-Speed w/ Fore-Aft Tilt Set of 2	AMHXE47152	\$ 360.00
16a S770, S780, S785, S790 - MY18	Feeder House, Fixed 5-Speed w/o Fore-Aft Tilt	AMH229019	\$ 275.00
16b S760, S770, S780, S785, S790 - MY18	Feeder House, Fixed Speed High Torque w/ Fore-Aft Tilt	AMHXE50398	\$ 405.00

John Deere®—Combine

Application	Description	Part Number	Retail Price
16b S760, S770, S780, S790	Feeder House, Fixed Speed High Torque w/o Fore-Aft Tilt	AMH174885	\$ 245.00
17 S760, S770, S780, S785, S790 - MY18	Feederhouse Front End Drive, Heavy Duty	AMH156541	\$ 225.10
17 S770, S780, S785, S790 - MY18	Feederhouse Front End Drive, 5-Speed	AMH229018	\$ 300.00
18 S760, S770 - MY18	Grain Tank Auger Drive Set of 2	AMAH160080	\$ 85.00
18 S780, S785, S790 - MY18	Grain Tank Auger Drive Set of 2	AMAH233198	\$ 125.00
19 S760, S770 - MY18	Separator Rotor Drive	AMHXE46027	\$ 445.00
19 S780, S785, S790 - MY18 w/ Large Sheaves	Separator Rotor Drive Replaces H208431	AMHXE63990	\$ 625.00
20 S760, S770, S780, S790 - MY18	Straw Spreader and Dual Chopper Drive Fine Cut Replaces HXE124868	AMHXE124868	\$ 343.00
20 S770 MY18	Dual Chopper Drive Extra Fine Cut, 3 Banded	AMH241000	\$ 238.00
20 S780, S785, S790 - MY18	Dual Chopper Drive Extra Fine Cut, 4 Banded	AMH240888	\$ 305.00
21 S760, S770, S780, S790 - MY18 w/ Manual or Powercast Tail Board	Dual Chopper Drive Fine Cut (2) Required Replaces HXE124869	AMHXE124869	\$ 335.00
21 S770, S780, S785, S790 - MY18	Dual Chopper Drive Extra Fine Cut, Single Belt	AMH240972	\$ 67.00
21 S770, S780, S785, S790 - MY18	Dual Chopper Drive Extra Fine Cut, Banded Belt	AMH240974	\$ 235.00
22 S760 MY18	Discharge Beater Drive	AMHXE15556	\$ 87.00
22 S760, S770, S780, S785, S790 - MY18	Discharge Beater Drive Fine Cut	AMHXE124870	\$ 215.00
22 S770 ASN 1Z0S770XXXX109999, S780 ASN 1Z0S780XXXX109999, S785 ASN 1Z0S790XXXX109999 - MY18	Discharge Beater Drive Extra Fine Cut	AMHXE124870	\$ 215.00
23 S760, S770 - MY18	After Treatment Blower Drive	AMHXE69280	\$ 24.00
23 S780, S785, S790 - MY18	After Treatment Blower Drive	AMHXE69281	\$ 21.80
24 S770, S780, S785, S790 - MY18	Overshot Beater Drive	AMH240895	\$ 62.00
25 S780, S785, S790 - MY18	Tailings Rethresher Drive	AMH240895	\$ 62.00
26 S780, S790 - MY18	Engine Front Drive (Tier 2)	AMR503505	\$ 43.91
26 S780, S785, S790 - MY18	Engine Front Drive (Tier 4)	AMH238831	\$ 31.35
27 S780, S790 - MY18	Fixed Fan Drive (Tier 2)	AMR503312	\$ 66.36
27 S780, S785, S790 - MY18	Fixed Fan Drive (Tier 4)	AMHXE32548	\$ 34.06
28 S780, S785, S790 - MY18	Vacuum Fan Drive (Tier 4)	AMHXE38073	\$ 13.73
29 S780, S785, S790 - MY18	Engine Front Drive (Tier 4)	AMHXE71061	\$ 18.25
30 S780, S790 - MY18	Air Compressor Drive (Tier 2)	AMHXE80480	\$ 46.00

John Deere®—Combine

Belts—T660, T670

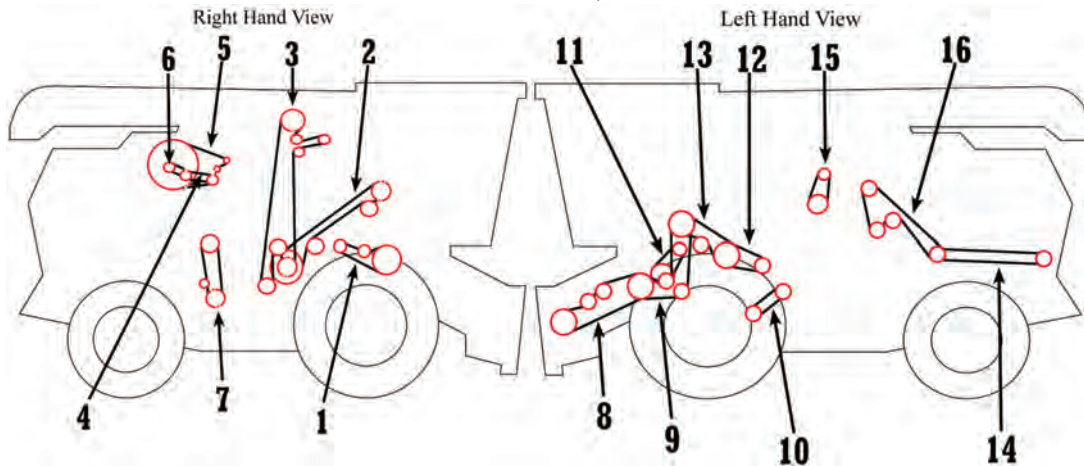

John Deere®—Combine

Application	Description	Part Number	Retail Price
1 T660, T670	Cylinder Drive	AMH115881	\$ 161.80
2 T660, T670	Secondary Countershaft	AMH128010	\$ 62.00
3 T660, T670	Clean Grain Elevator	AMH141166	\$ 125.00
4 T660, T670	Rotary Screen Drive	AMH146636	\$ 10.09
5 T660, T670	Rotary Screen Drive - Screen Side	AMH175628	\$ 28.00
6 T660, T670	Cooling Fan	AMH174455	\$ 56.27
7 T660, T670	Tailings Auger and Elevator, Lower	AMZ59557	\$ 50.80
8 T660, T670	Feederhouse Drive, 108.11"	AMH176766	\$ 164.78
8 T660-T670 (Hillmaster)	Feederhouse Drive, 112.05"	AMH202821	\$ 188.59
8 (T660-T670 ASN 85500)	Feederhouse Drive, 111.81"	AMHXE12426	\$ 293.89
8 (T660-T670 ASN 85500)	Feederhouse Drive, 107.87"	AMHXE12427	\$ 182.16
9 T660, T670	Header and Reel Pump	AMH176765	\$ 287.90
9 T660, T670	Header and Reel Pump, 900 RPM	AMHXE12425	\$ 311.27
10 T660, T670	Cleaning Fan	AMH152146	\$ 75.00
11 T660, T670	Stripper Beater	AMH139963	\$ 15.13
12 T660, T670	Overshot Beater Drive	AMZ103845	\$ 83.49
13 T660, T670	Beater Drive	AMZ103844	\$ 95.80
14 T660, T670	Straw Chopper/Spreader, For Corn	AMH177178	\$ 230.88
14 T660, T670	Straw Chopper/Spreader	AMZ59286	\$ 212.58
15 T660, T670	Unloading System Set of 2	AMAH158880	\$ 60.00
16 T660, T670	Separator Fan Drive	AMH177177	\$ 233.00

John Deere®—Combine

Belts—Cotton Pickers & Swathers

Application	Description	Part Number	Retail Price
NI 9900, 9910, 9920, 9930	Unit Drive, RH	AMN121116	\$ 33.45
NI 9960 BSN 4000	Unit Drive, RH	AMAN194750	\$ 67.00
NI 9960 ASN 4001	Unit Drive, RH Set of 2	AMAN194916	\$ 82.81
NI 9900, 9910, 9920, 9930	Unit Drive, LH	AMN111527	\$ 29.68
NI 9960	Unit Drive, LH	AMAN194917	\$ 83.24
NI 9940, 9950	Unit Drive	AMAN190948	\$ 89.28
NI 9930, 9920	Hydraulic Pump	AME61326	\$ 14.65
NI 9930	Lube Pump	AMM41592	\$ 12.45
NI 9900	Hydraulic Pump Cushion Mount	AMN115368	\$ 19.72
NI 9900, 9910	Hydraulic Pump Solid Mount	AMN117398	\$ 13.92
NI 9940, 9950	Hydrostat Charge Pump	AMN190043	\$ 12.13
NI 4895, 4990, 4995	Fan	AMR500244	\$ 60.42
NI 9900, 9910 BSN 3055	Fan	AMN124460	\$ 55.87
NI 9910 ASN 3056, 9920, 9930	Fan	AMN129368	\$ 55.59
NI 9940, 9950	Fan	AMN193822	\$ 90.37
NI 2280	Platform Drive	AME50873	\$ 117.00
NI 2280 BSN 490000	Sickle Drive 230 Platform	AME37905	\$ 40.75
NI 2280 ASN 490001	Sickle Drive 230 Platform	AME63036	\$ 44.66
NI Swathers: 800, 830	Platform Drive	AME48061	\$ 138.00
NI Swathers: (2250, 2270, 2280 ASN 490000)	Platform Drive 1000 RPM Speed Up Belt	AME58967	\$ 150.00

Belts—800 Series Forage Harvesters

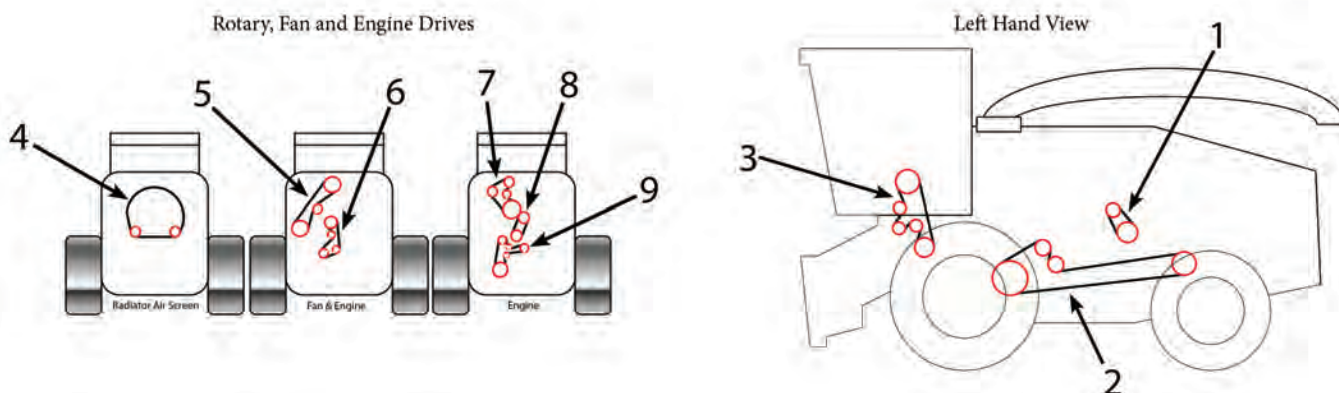

Application	Description	Part Number	Retail Price
1 8100, 8200, 8300, 8400, 8500, 8600, 8700, 8800	Vacuum Fan Drive	AMHXE64200	\$ 16.18
2 8100, 8200, (8300, 8400, 8500 SN 516000-517999), (8600, 8700, 8800 SN 517000-517999)	Main Drive	AMAXE37395	\$ 655.00
2 (8300, 8400, 8500 SN 513822-515999)	Main Drive	AMAXE51063	\$ 903.00
2 (8300, 8400, 8500 SN 513822-515999), 8600 SN 513822-516999	Main Drive, 1100 RPM	AMAXE17662	\$ 695.00
2 8600 SN 513822-516999	Main Drive, 1200 RPM	AMAXE51063	\$ 903.00
2 (8700, 8800 SN 513822-516999)	Main Drive, 1100 RPM	AMAXE41286	\$ 1075.00
2 (8700, 8800 SN 513822-516999)	Main Drive, 1200 RPM	AMAXE51876	\$ 1265.00

John Deere®—Combine

Application	Description	Part Number	Retail Price
3 8100, 8200, 8300, 8400, 8500, (8600, 8700, 8800 SN 517000-517999)	Kernel Processor	AMHXE39119	\$ 158.00
3 8100, 8200, 8300, 8400, 8500, (8600, 8700, 8800 SN 517000-517999)	Kernel Processor, KernelStar™	AMHXE93098	\$ 135.00
3 (8600, 8700, 8800 SN 513822-516999)	Kernel Processor Set of 2	AMAXE25334	\$ 248.00
3 (8600, 8700, 8800 SN 513822-516999)	Kernel Processor, KernelStar™ Set of 2	AMAXE52471	\$ 212.00
4 (8100, 8200, 8300, 8400, 8500, 8600, 8700, 8800 SN 517000-517999)	Radiator Air Screen	AMZ103479	\$ 33.00
5 8100, 8200, 8300, 8400, 8500, 8600, 8700 SN 517000-517999, (8800 SN 513822-515999 & 517000-517999)	Fan Drive	AMAXE33760	\$ 98.00
5 8800 SN 516000-516999	Fan Drive	AMCQ40222	\$ 108.00
6 8100, 8200, (8300, 8400, 8500 SN 516000-517999), (8600, 8700, 8800 SN 517000-517999)	Engine Drive (Non-EGR Engine)	AMHXE43428	\$ 31.00
6 8100, 8200, (8300, 8400, 8500 SN 516000-517999), (8600, 8700, 8800 SN 517000-517999)	Engine Drive (FT4 Engine)	AMHXE90896	\$ 36.00
6 (8300, 8400, 8500 SN 513822-515999), 8600 SN 513822-516999	Engine Drive (Non-EGR Engine)	AMHXE41402	\$ 40.00
6 (8300, 8400, 8500 SN 513822-515999), 8600 SN 513822-516999	Engine Drive (FT4 Engine)	AMHXE79106	\$ 32.00
7 (8700, 8800 SN 513822-516999)	Engine Drive, Air Compressor/Alternator	AMHXE24688	\$ 33.00
8 (8700, 8800 SN 513822-516999)	Engine Drive, Alternator 24 Volt	AMREC541298700	\$ 14.00
9 (8700, 8800 SN 513822-516999)	Engine Drive, Air Compressor (Tier 2)	AMHXE81232	\$ 56.00

Belts—Platforms

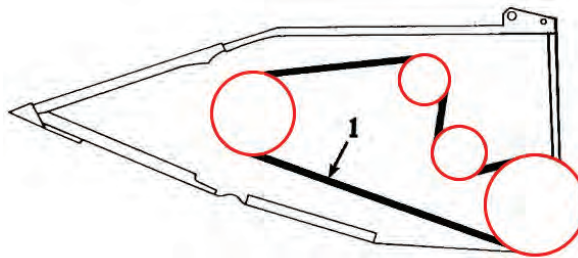

Application	Description	Part Number	Retail Price
1 213, 215, 216, 218, 220, 222, 224, 230, 920, 922, 925, 930	Platform 128" Long, Use w/ 11.50" or 12" Sheaves	AMH136881	\$ 49.67
1 600R	Platform Retracted and Middle Cutterbar, 111.25" Long	AMH210003	\$ 46.94
1 600R	Platform Extended Cutterbar, 121.45" Long Replaces H210001	AMH221324	\$ 52.82
1 918, 920, 922, 925, 930	Platform Belt 131" Long	AMH202647	\$ 50.67
NI 600F, 600R	Flex Drive 118.307" Long Replaces H201794	AMH220884	\$ 55.00
NI 925D, 930D, 936D	Knife Drive 117.00" Long	AMH166077	\$ 57.00

John Deere®—Industrial / Construction

Table of Contents

Air Cleaner Components	1274	Lower Lift Links.....	1283
Air Conditioning and Components.....	1285	Manifold and Components	1274
Alternators	1275	Mechanical Front Wheel Drive Parts.....	1278
Axle Pivot Pins.....	1279	MFWD Hub Components	1278
Balancer Shafts	1266	Oil Coolers, Engine.....	1267
Battery Boxes and Components.....	1283	Oil Pumps, Engine.....	1267
Belts.....	1271	Overhaul Kits	1261
Brake Pinion Shafts	1282	Power Steering Cylinder Components	1281
Brakes and Components	1282	PTO Shafts and Components.....	1282
Camshafts	1266	Radiator Hoses and Thermostats.....	1269
Connecting Rods.....	1266	Radiators	1268
Crankshafts	1263	Ring Gears	1270
Crankshafts Pulleys and Dampers	1266	Selective Control Valves and Couplers	1281
Cylinder Heads	1267	Sensors	1276
Drawbars and Components.....	1282	Shortblock Assemblies	1260
Fan Clutch Components.....	1271	Spindles.....	1278
Fuel Lift Pumps.....	1272	Starters.....	1274
Fuel Tanks and Components.....	1285	Steering Wheels	1285
Gas Struts.....	1284	Sway Blocks	1283
Glass	1284	Tachometers, Gauges and Instrument Cluster	1275
Hydraulic Oil Coolers.....	1279	Tie Rods and Components.....	1278
Hydraulic Pumps and Motors	1279	Toplink Assemblies Components.....	1283
Hydrostat Components and Drives.....	1276	Topshaft Components.....	1281
Injection Pumps	1272	Transmission Components.....	1282
Injectors	1272	Turbochargers and Components.....	1273
Lighting.....	1284	Water Pumps and Components.....	1270
Load Sensing Shafts	1283	Wheel Hubs and Components.....	1279
Longblock Assemblies.....	1260		

Longblock Assemblies

Our remanufactured longblocks meet the highest standards in quality. All remanufactured components are inspected for structural integrity, cracks and dimensional specifications and then remanufactured back to OEM specifications. The components are then assembled using the highest quality new parts. We back this with one of the best warranties in the industry.



Application	Description	Part Number	Retail Price	Core
Excavator: 450CLC, Wheel Loaders: 744J, 824J	Reman Engine, Complete 12.5 Liter, 6125, HH003	CRJD6125T9860L	\$ 32500.00	\$ 7500.00

Shortblock Assemblies

Application	Description	Part Number	Retail Price	Core
Skidders: 540E, 540G, 548E, 584G, Wheel Loaders: 544E, 544G - All w/ 6059T 6 Cylinder Diesel Engine	Reman Shortblock Assembly	SBJD6059T	\$ 5000.00	\$ 1000.00

John Deere®—Industrial / Construction



Overhaul Kits

Application	Description		Retail Price	Core
Crawler/Dozer: 40	100 Engine - Gas	Inframe Kit	\$ 554.00	
		Overhaul Kit	\$ 554.00	
Crawlers/Dozers: 420, 430, 440, Wheel Loader: 440	113 Engine - Gas	Inframe Kit	\$ 602.00	
		Overhaul Kit	\$ 627.00	
Crawler/Dozer: 350 Transmission BSN 105998	135 Engine - Gas O-Ring Grooves on Sleeves	Inframe Kit	\$ 706.00	
		Overhaul Kit	\$ 676.00	
Backhoe-Loader: 300B, Crawlers/Dozers: 350 Transmission ASN 105997, 350B, Forklift: 380	135 Engine - Gas O-Ring Grooves in Block	Inframe Kit	\$ 656.00	
		Overhaul Kit	\$ 735.00	
Crawler/Dozer: 350 SN 037637-101610 w/ Flywheel Housing Marked T25113	152 Engine - Diesel	Inframe Kit	\$ 469.00	
		Overhaul Kit	\$ 564.00	
Backhoe-Loader: 300B BSN 710724, Crawlers/Dozers: 350 ASN 101609, 350B, 350C, Forklift: 380	152 Engine - Diesel	Inframe Kit	\$ 469.00	
		Overhaul Kit	\$ 538.00	
Backhoe-Loaders: 300B ASN 710723, 310 ASN 189323, Crawler/Dozer: 350C	164 Engine - Diesel	Inframe Kit	\$ 468.00	
		Overhaul Kit	\$ 544.00	
Backhoe-Loader: 310 BSN 189324	164 Engine - Diesel	Overhaul Kit	\$ 536.00	
Crawler/Dozer: 450 Transmission BSN 102767, Forklift: 480 Transmission BSN 105591	180 Engine - Gas	Inframe Kit	\$ 922.00	
		Overhaul Kit	\$ 773.00	
Crawler/Dozer: 450 SN 037867-102767, Forklift: 480 SN 036618-104242	202 Engine - Diesel O-Ring Grooves On Sleeves	Inframe Kit	\$ 645.00	
		Overhaul Kit	\$ 720.00	
Crawler/Dozer: 450 ASN 102766, Forklifts: 480 ASN 104241, 480A	202 Engine - Diesel	Inframe Kit	\$ 572.00	
		Overhaul Kit	\$ 671.00	
Backhoe-Loader: 410 BSN 192001	202 Engine - Gas Engine ASN 157353	Inframe Kit	\$ 1610.00	
		Overhaul Kit	\$ 1587.00	
Backhoe-Loaders: 310A, 310B, 410 ASN 189345, 410B, Crawlers/Dozers: 450B ASN 187208, 450C, 450D, 455D, Forklifts: 480B, 480C	4219 and 4219T Engine - Diesel	Inframe Kit	\$ 621.00	
		Overhaul Kit	\$ 707.00	
Backhoe-Loader: 410 BSN 189345, Crawler/Dozer: 450B BSN 187209	4219 and 4219T Engine - Diesel	Inframe Kit	\$ 567.00	
		Overhaul Kit	\$ 664.00	
Crawlers/Dozers: 350D, 355D	3179 Engine - Diesel	Inframe Kit	\$ 433.00	
		Overhaul Kit	\$ 511.00	
Backhoe-Loaders: (210C, 310C, 315C Engine BSN 300000), 415B, Crawler/Dozer: 400G Engine BSN 300000, Forklift: 482C Engine BSN 300000	4239 Engine - Diesel	Inframe Kit	\$ 572.00	
		Overhaul Kit	\$ 675.00	
Backhoe-Loaders: (310C, 315C Engine BSN 300000), 515B	4239 and 4239T Engine - Diesel	Inframe Kit	\$ 577.00	
		Overhaul Kit	\$ 685.00	
Grader: 570 Engine BSN 158976, Wheel Loader: 544 Engine BSN 102642	6303E Engine - Diesel	Inframe Kit	\$ 935.00	
		Overhaul Kit	\$ 1019.00	
Grader: 570 Engine ASN 158975, Wheel Loader: 544 SN 102642-121499	6303L Engine - Diesel	Inframe Kit	\$ 842.00	
		Overhaul Kit	\$ 981.00	

John Deere®—Industrial / Construction

Application	Description		Retail Price	Core
Backhoe-Loader: 710B, Grader: 570A, Skidder: 540A, Wheel Loaders: 444, 444C, 444CH, 444D, 544A	6329 Engine - Diesel High Compression Piston	Inframe Kit	\$ 1113.00	
Backhoe-Loader: 710B, Grader: 570A Engine ASN 275230, Wheel Loaders: 444, 444C, 444CH, 444D, 544A ASN 181261	6329 Engine - Diesel Standard Compression Piston	Inframe Kit	\$ 906.00	
		Overhaul Kit	\$ 967.00	
Grader: 570A Engine SN 200851-275230, Power Units: (329DH01, HC329D, NB329D Engine SN 156943-277647), Wheel Loader: 544A Engine SN 085200-XXXXXX	6329 Engine - Diesel	Inframe Kit	\$ 839.00	
		Overhaul Kit	\$ 959.00	
Grader: 570B Engine BSN 300000, Wheel Loader: 444D Engine ASN 511476	6359 Engine - Diesel High Ring, Piston Marked RE19282	Inframe Kit	\$ 844.00	
		Overhaul Kit	\$ 936.00	
Backhoe-Loaders: 710B Engine SN 143930-299999, 710C Engine BSN 300000, Grader: 570B Engine BSN 300000, Wheel Loaders: 444D Engine ASN 511476, 544E Engine BSN 300000	6359T Engine - Diesel High Ring, Piston Marked NRE19278	Overhaul Kit	\$ 958.00	
Backhoe-Loader: 500	201 Engine - Gas and LPG	Inframe Kit	\$ 868.00	
		Overhaul Kit	\$ 1075.00	
Backhoe-Loaders: 500, 500A BSN 123114	227 Engine - Gas	Inframe Kit	\$ 630.00	
		Overhaul Kit	\$ 664.00	
Backhoe-Loaders: (500, 500A - w/ 270 Engine SN 050000-124999)	254 and 270 Engine - Diesel All Service Cylinder Kits are 4.250" Bore	Inframe Kit	\$ 731.00	
		Overhaul Kit	\$ 825.00	
Backhoe-Loaders: (500, 500A BSN 123114 - w/ 270 Engine)	254 and 270 Engine - Diesel Replacement Blocks Marked R40910, R46350, R46430 All Service Cylinder Kits are 4.250" Bore	Inframe Kit	\$ 709.00	
		Overhaul Kit	\$ 735.00	
Backhoe-Loaders: 500, 500A	270 Engine - Diesel Engine SN 050000-124999, Hyperperformance Original Blocks Marked R32020, R40850	Inframe Kit	\$ 965.00	
		Overhaul Kit	\$ 1065.00	
Backhoe-Loaders: 500A ASN 123113, 500B, 500C, 510	270 Engine - Diesel Engine ASN 124999	Inframe Kit	\$ 769.00	
		Overhaul Kit	\$ 691.00	
Backhoe-Loaders: 500A, 500B, 500C, 510	270 Engine - Diesel Engine ASN 124999, Hyperperformance	Inframe Kit	\$ 992.00	
		Overhaul Kit	\$ 1071.00	
Wheel Loaders: 644, 644A	6404T and 6404A Engine - Diesel Engine SN 215000-335845	Inframe Kit	\$ 1195.00	
		Overhaul Kit	\$ 1348.00	
	6404T and 6404A Engine - Diesel Engine SN 215000-335845, Hyperperformance	Inframe Kit	\$ 1581.00	
		Overhaul Kit	\$ 1755.00	
Scraper: 762A, Wheel Loader: 644C	6466T and 6466A Engine - Diesel Early Connecting Rod	Inframe Kit	\$ 1266.00	
		Overhaul Kit	\$ 1347.00	
	6466T and 6466A Engine - Diesel Early Connecting Rod, Hyperperformance	Inframe Kit	\$ 1588.00	
		Overhaul Kit	\$ 1773.00	
Crawler/Dozer: 850B, Graders: 770A, 770AH, 770B, 770BH, 772A, 772AH, 772B, 772BH, Scrapers: 762A, 762B, Wheel Loaders: 644C, 644D	6466T and 6466A Engine - Diesel Late Connecting Rod	Inframe Kit	\$ 1250.00	
		Overhaul Kit	\$ 1347.00	
	6466T and 6466A Engine - Diesel Late Connecting Rod, Hyperperformance	Inframe Kit	\$ 1690.00	
		Overhaul Kit	\$ 1812.00	
Crawler/Dozer: 850C, Excavators: 792DLC, 892ELC, Graders: 770B, 770BH, 772B, 772BH, Skidders: 740E, 740G, 748E, Wheel Loaders: 644E, 644EH, 644ER, 644EZ, 644G	6076A and 6076T Engine - Diesel Engine BSN 499999, Hyperperformance	Inframe Kit	\$ 1650.00	
Crawler/Dozer: 850C Engine BSN 500000, Graders: (770B, 770BH, 772B, 772BH Engine BSN 500000), Wheel Loaders: (644E, 644EH, 644ER, 644EZ, 644G - w/ Engine BSN 500000)	6076, 6076A and 6076T Engines - Diesel	Inframe Kit	\$ 1412.00	
Wheel Loaders: (644E, 644EH, 644ER, 644EZ Engine BSN 500000)	6076, 6076A and 6076T Engines - Diesel	Overhaul Kit	\$ 1584.00	

John Deere®—Industrial / Construction

Application	Description		Retail Price	Core
Crawlers/Dozers: 850 Engine BSN 033886, 855 Engine BSN 034179, Scrapers: 762 Engine BSN 034195, 860B Engine BSN 031522	6619T and 6619A Engine - Diesel	Inframe Kit	\$ 1893.00	
	Early, Curved Counterbore Relief	Overhaul Kit	\$ 1945.00	
Crawlers/Dozers: 850 Engine SN 033886-049059, 855 Engine SN 034179-049059, Scrapers: 762 Engine SN 034195-049059, 860B Engine SN 031522-049059, 862 Engine BSN 049060	6619T and 6619A Engine - Diesel	Inframe Kit	\$ 1868.00	
	Mid, Curved Counterbore Relief	Overhaul Kit	\$ 2125.00	
Crawlers/Dozers: (850, 855 Engine ASN 049059), Scrapers: 862 Engine ASN 049059, 862B Engine BSN 500000, Wheel Loader: 744E Engine BSN 500000	6101 A/H and 6619 A/T Engine - Diesel	Inframe Kit	\$ 1713.00	
	6101 Early, 6619 Late, Square Counterbore Relief	Overhaul Kit	\$ 1952.00	
Backhoe-Loaders: (210C, 310C Engine ASN 299999), 300D, 310D, 315D, Crawler/Dozer: 400G Engine ASN 299999, Forklift: 482C Engine ASN 299999	4039D Engine - Diesel	Inframe Kit	\$ 572.00	
		Overhaul Kit	\$ 675.00	
Backhoe-Loaders: (310C, 315C Engine ASN 299999), 310D, 315D	4039DT Engine - Diesel	Inframe Kit	\$ 616.00	
		Overhaul Kit	\$ 959.00	
Backhoe-Loaders: 310E, 310G, Crawlers/Dozers: 450H, 450J BSN 159987, Forklifts: 485E, 486E, 488E, Wheel Loaders: 324H, 344H Engine ASN 799999	4.5D PowerTech™ Engine - Diesel	Inframe Kit	\$ 704.00	
		Major Overhaul Kit	\$ 705.00	
Backhoe-Loaders: 310E, 310G, 310SE, 310SG, 315SE, 315SG, 410E, 410G, Crawlers/Dozers: 450H, (450J, 550J, 650J BSN 159987), 550H, 650H, Wheel Loader: 344H Engine BSN 800000	4045T PowerTech™ Engine - Diesel	Inframe Kit	\$ 704.00	
		Overhaul Kit	\$ 741.00	
Crawler/Dozer: 700H	6.8T PowerTech™ Engine - Diesel	Inframe Kit	\$ 1049.00	
	Early Connecting Rod Marked R123959	Overhaul Kit	\$ 1197.00	
	6.8T PowerTech™ Engine - Diesel	Inframe Kit	\$ 1378.00	
	Late Connecting Rod Marked R500000	Overhaul Kit	\$ 1208.00	
Crawlers/Dozers: 850C, 850C-II, Graders: 770C, 770C-II, 770CH, 770CH-II, 772CH, 772CH-II, Scraper: 762B-II, Wheel Loaders: 644G, 644H	8.1 PowerTech™ Engine - Diesel	Inframe Kit	\$ 1667.00	
	SN 086536-199999	Overhaul Kit	\$ 1889.00	
Backhoe-Loaders: 410C, 410D, Crawlers/Dozers: (450G, 455G Engine SN 300000-742459), Wheel Loader: 344E Engine ASN 299999	4045D Engine - Diesel	Overhaul Kit	\$ 804.00	
		Inframe Kit	\$ 685.00	
Crawlers/Dozers: 850C, 850C-II, Graders: 770C, 770C-II, 770CH, 770CH-II, 772CH, 772CH-II, Scraper: 762B-II ASN 818908	6081 A/H PowerTech™ Engine - Diesel	Inframe Kit	\$ 1668.00	
	Engine BSN 086536	Overhaul Kit	\$ 1890.00	
Crawlers/Dozers: 450E, 455E, 550, 555, (450G, 455G, 550A, 550B, 550G, 555A, 555B, 555G, 650G Engine BSN 300000), Wheel Loader: 444E Engine BSN 300000	4276T Engine - Diesel	Overhaul Kit	\$ 766.00	

Crankshafts



Application	Description	Part Number	Retail Price	Core
Backhoe-Loaders: 300B, 310, Crawlers/Dozers: 350B, 350C, 350D, 355D, Forklift: 380 Replaces RE46896, RE47637, T23516, T23516T, T20031T	Crankshaft 3-152, 3-164, 3-179, 3029, 3029D Diesel Engines 4.328" Stroke, (152) 3.8581" - 3.8595", (164) 3.875", (179) 4.192", (179T) 4.190" Bore, 2.748" - 2.749" Rod, 3.123" - 3.124" Main Flange - 4 Bolt Holes, 1 Dowel Snout - 1 Bolt Hole, 1 Keyway, w/ Gear	AMAT18031	\$ 660.00	

John Deere®—Industrial / Construction

Application	Description	Part Number	Retail Price	Core
Backhoe-Loaders: 300D, 310C, 315C, Excavator: 190E, Wheel Tractors: 5500, 6200, 6300 Replaces R23909, R81959, R97926, R97928, R121018, RE65224	Crankshaft 4039, 4239 ASN 769620 w/ 2.360" (60 mm) Long Snout Engines 4.331" Stroke, 4.192" - 4.194" Bore, 2.748" - 2.7488" Rod, 3.1236" - 3.1244" Main Flange - No Centering Ring, Flat, 4 Bolt Holes, 1 Dowel Hole Snout - 1 Bolt Hole, 2 Keyways (Keyway 5/16" x 1 1/8"), w/ 24 Tooth Timing Gear, Left Hand Helix	AMRE20585	\$ 575.00	
Backhoe-Loaders: 310, 310B, 310C, 310D, 315C, 410, 410B, 415B, 515B, Crawlers/Dozers: 450, 450A, 450B, 450C, 450D, 455D, Excavators: 70, 70D, 290D, 490, Forklifts: 480, 480A, 480B, 480C, 482C, Skidders: 440, 440A, 440B, Wheel Loader: 244E Replaces R23517, R81959, R94644, RE33197, RE48748, RE57664, T23480, T23517, T28743	Crankshaft (202, 219, 239 BSN 769619), 4039D, 4039T - 4 Cylinder Engines 4.330" Stroke, (202) 3.8579" - 3.859", (219) 4.020", (239) 4.192" - 4.194 Bore, 2.748" - 2.7488" Rod, 3.1235" - 3.1245" Main Flange - No Centering Ring, Flat, 4 Bolt Holes, 1 Dowel Snout - Straight, No Splines, 1 Bolt Hole, 1 Keyway	AMAT18030	\$ 535.00	
Backhoe-Loaders: 310E, 310G, 310SE, 310SG, 315SE, 315SG, 410E, 410G, Crawlers/Dozers: 450G, 450H, 455G, 550G, 550H, 555G, 650G, 650H, Excavator: 120, Forklifts: 485E, 486E, 488E, Wheel Loaders: 444H, TC44H Replaces R113596, RE50618	Crankshaft 4.5 PowerTech™ Straight Nose 4 Cylinder Engine 5" Stroke, 4.192" - 4.194" Bore, 3.063" - 3.064" Rod, 3.123" - 3.124" Main Flange - No Centering Ring, Flat, 4 Bolt Holes, 1 Dowel Hole Snout - Straight, 4 Bolt Holes, 1 Keyway, w/ 30 Tooth Helical Timing Gear	AMRE504638	\$ 775.00	
Backhoe-Loaders: 310J, 310SJ, 410J, Crawlers/Dozers: (450J, 550J, 650J - Tier III Engine ASN 159987), Telehandler: 3800, Wheel Loaders: 344H Engine ASN 800000, 444J Tier III ASN 611275 Replaces R503715	Crankshaft 4.5 PowerTech™ Taper Nose 4 Cylinder Engine 5" Stroke, 4.192" - 4.194" Bore, 3.063" - 3.064" Rod, 3.123" - 3.124" Main Flange - No Centering Ring, Flat, 4 Bolt Holes, 1 Dowel Hole Snout - Tapered, 1 Bolt Hole, 1 Keyway, w/ Timing Gear	AMRE506195	\$ 895.00	
Backhoe-Loaders: 410C, 510B, 510C, 610B, 610C, Crawlers/Dozers: 450E, 450G, 455E, 455G, 550, 550A, 550B, 550G, 555, 555A, 555B, 555G, 650G, Excavators: 490D, 495D, 590D, 595, 595D, Skidders: 340D, 440C, 440D, 448D, 540B, 540D, Track Feller Buncher: 493D, Wheel Loaders: 344E, 444E Replaces R54501	Crankshaft 4-276D, 4-276T - 276 CID 4.5 Liter 4 Cylinder Diesel Engines 5" Stroke, 4.192" - 4.194" Bore, 3.063" - 3.064" Rod, 3.1235" - 3.1245" Main Flange - 4 Bolt Holes, 1 Dowel Pin Hole Snout - 1 Bolt Hole, 2 Keyways	AMRE56792	\$ 720.00	
Backhoe-Loaders: 410D, 510D, 610C, Crawler/Dozer: 650G, Excavator: 490E, 590D, 595D, Skidders: 540E, 548E	Crankshaft 4045D, 4045T - 4.5 Liter 4 Cylinder Engines This Crankshaft is not the PowerTech™ w/ 3 Bolt Holes in the Snout and No Gear 5" Stroke, 4.192" - 4.194" Bore, 3.063" - 3.064" Rod, 3.123" - 3.124" Main Flange - No Centering Ring, Flat, 4 Bolt Holes, 1 Dowel Hole Snout - 1 Bolt Hole, 2 Keyways, 2.36" Long, w/ Gear 0.871" Wide	AMRE54883	\$ 650.00	
Backhoe-Loaders: 500, 500A, 500B, 500C, 510 Replaces R40570, R46498	Crankshaft 4.750" Stroke Flange - Centering Ring, 6 Bolt Holes, 1 Dowels Snout - Straight, 1 Bolt Hole, 1 Keyway, w/ Balanced Gear Installed	AMAR40485	\$ 1650.00	
Backhoe-Loaders: 500, 500A, 500B, 500C, 510 Replaces R26540R, R46498	Crankshaft 254 4.2 Liter Diesel Engine BSN 129999 4.750" Stroke, 4.125" Bore, 2.998" - 2.999" Rod, 3.3715" - 3.3725" Main Flange - Flat, 4 Bolt Holes, 2 Dowels Snout - 1 Bolt Hole, 1 Keyway, w/ Balancer Gear	AMAR26428	\$ 1565.00	
Backhoe-Loaders: 710B, 710C, 710D, Graders: 570A, 570B, Skidders: 540, 540A, 540E, 540G, 548E, Wheel Loaders: 444, 444C, 444CH, 444D, 544, 544A, 544C, 544D, 544E, 544G Replaces R45541, R108658, R108679, RE502190, T23266	Crankshaft 6-303, 6-329, 6-359, 6059D, 6059T Engines 4.330" Stroke, (303) 3.860", (329) 4.020", (359) 4.190" Bore, 2.748" - 2.7488" Rod, 3.1236" - 3.1244" Main Flange - No Centering Ring, Flat, 4 Bolt Holes, 1 Dowel Snout - 1 Bolt Hole, 1 Keyway	AMAT22562	\$ 830.00	

John Deere®—Industrial / Construction

Application	Description	Part Number	Retail Price	Core
<p>Compactor: 646B, Crawlers/Dozers: 850, 855, Excavators: 890, 890A, 992D, Graders: 770A, 772A, Scrapers: 760, 760A, 762, 860, 860B, 862, 862B, Wheel Loader: 644B Replaces AR36350R, AR47403, AR69264, AR78403, R36350, R57730, R63476, R63478</p>	<p>Crankshaft w/ Gear 6-531 8.7 Liter, 6-619 10.1 Liter BSN 499999 - Diesel Engines 5" Stroke, 5.1245" - 5.1263" Bore, 3.498" - 3.499" Rod, 3.748" - 3.749" Main Flange - Flat, 6 Bolt Holes, 2 Large Dowels Snout - Straight, 1 Large Bolt Hole, w/ Timing Gear, w/ Oil Pump Drive Gear</p>	AMAR92533	\$ 2350.00	
<p>Compactor: 646C, Crawler/Dozer: 850B, Excavators: 690, 690A, 690C, 790, 790D, 792, 892DLC, Graders: 770A, 770B, 772A, 772B, Scrapers: 762A, 762B, Track Feller Bunchers: 693C, 793D, Wheel Feller Bunchers: 743, 743A, Wheel Loaders: 644, 644A, 644C, 644D Replaces AR96189, R26506, R26506R, R56919, R56934, R56979, R63451, R87544A, RE42675, RE53203, RE53477</p>	<p>Crankshaft 466 ASN 50000, 6076 BSN 187657 - 7.6 Liter Diesel Engines w/ Crank Driven Oil Pump 4.750" Stroke, 4.5615" - 4.5635" Bore, 2.998" - 2.999" Rod, 3.372" - 3.373" Main Flange - Centering Ring, 6 Bolt Holes, 1 Dowel Snout - Straight, 3" Short Nose, 1 Bolt Hole, 1 Keyway, w/ Oil Pump Drive Gear, 2.75" Long to the Shoulder of the 1st Main Journal to the End of the Snout</p>	AMRE53422	\$ 1350.00	
<p>Crawlers/Dozers: 655B, 750, 750B, 750C, 755, 755A, 755B, Excavators: 690D, 690DR, 690ELC, 790ELC, Graders: 670, 670A, 670B, 672A, 672B, Skidders: 640, 640D, 640E, 648D, 648E, 648G, Track Feller Bunchers: 653E, 693D, Wheel Feller Bunchers: 643, 643D, Wheel Loaders: 544B, 544C, 544D, 624E, 624G Replaces R54619, R104523, RE33687, RE502191</p>	<p>Crankshaft 6068, 6068D, 6068T, 6414, 6414D Engines 5" Stroke, 4.192" Bore, 3.063" - 3.064" Rod, 3.123" - 3.124" Main Flange - Flat, 4 Bolt Holes, 1 Dowel Snout - Straight, 1 Keyway, 1 Bolt Hole, 1 Front Helical Gear</p>	AMRE45517	\$ 1350.00	
<p>Crawlers/Dozers: 750C, 750C-II, 750J, Excavator: 690ELC, Track Feller Bunchers: 653E, 653G, Graders: 670C, 670CH, 672CH, Skidders: 640G, 640G-II, 640G-III, Sprayers: 640H, 648H, 748H, 848H, 4730, 4830, 5430, Wheel Loaders: 544, 624H, 624H LL Replaces RE52850, RE515785</p>	<p>Crankshaft 6.8 Power Tech, 414 CID. 6.8 Liter, 6 Cylinder 5" Stroke, 4.192" Bore, 3.063" - 3.064" Rod, 3.123" - 3.124" Main Flange - No Centering Ring, 6 Bolt Holes, 1 Dowel Hole Snout - Straight Double Step Nose, 4 Bolt Holes, w/ 30 Tooth Timing Gear, Left Hand Helix</p>	AMRE504639	\$ 1675.00	
<p>Crawlers/Dozers: 850, 850C BSN 883331, 850C-II ASN 883332, 850J, Dump Trucks: 250D, 300D, Excavators: 330C, 330LC, 330LCR, 370C, Forwarders: 1710D, 1711D, Graders: (770C, 770CH, 772CH BSN 582129), (770C-II, 770CH-II, 772CH-II ASN 582130), 772D, 870D, 872D, Knuckleboom Loaders: 530B, 535, Skidders: 560D, 660D, 740G BSN 565684, 748G, 748G-II SN 565685-576602, 748G-III ASN 576603, 848G, Swing Machine: 3554, Track Feller Bunchers: 608L ASN 006020, 608S SN 10BA1045-007075, 753G SN 002001-002063, 753J, 759G, 759J, 759JH, 853G ASN 0030847, 853J, 900 ASN 001001, 903G ASN 002001, 903J, 909J, 953G ASN 004005, 953J, 959J, Track Harvesters: 853JH, 903JH, 909JH, Wheel Loaders: 644G, 644H, 644J BSN 611231, 724J Replaces R35502, RE55522</p>	<p>Crankshaft w/ Gears 8.1 PowerTech™ Late 6 Cylinder Engine ASN 142157 5.059" Stroke, 4.560" Bore, 2.998" - 2.999" Rod, 3.748" - 3.749" Main Flange - Centering Ring, 6 Bolt Holes, 1 Dowel Hole, w/ 74 Tooth Oil Pump Drive Gear, Right Hand Helix Snout - Straight, 1 Bolt Hole, 2 Keyways, w/ 27 Tooth Timing Gear 27 mm Wide</p>	AMRE535300	\$ 2175.00	
<p>Excavators: 790, 790D, 792DLC, 892, 892ELC, Graders: 770B, 772B, Wheel Loader: 644G</p>	<p>Crankshaft 6076 Late 6 Cylinder Engine 4.375" Stroke, 4.5615" - 4.5635" Bore, 2.998" - 2.999" Rod, 3.372" - 3.373" Main Flange - Centering Ring, 6 Bolt Holes, 1 Dowel Hole, w/ 74 Tooth Oil Pump Drive Gear, Right Hand Helix Snout - 1 Bolt Hole, 2 Keyways, w/ 27 Tooth Straight Timing Gear, 3" Nose</p>	AMRG23551	\$ 1550.00	
<p>Excavator: 892E, Skidders: 740E, 748G, Wheel Loaders: 644E, 644EH, 644ER, 644G Replaces R104855, RE42671, RE63293</p>	<p>Crankshaft w/ Gear 6076, 6076A, 6076D, 6076H, 6076T 7.6 Liter Diesel Engine SN 187658-499999 4.750" Stroke, 4.5615" - 4.5635" Bore, 2.998" - 2.999" Rod, 3.372" - 3.373" Main Flange - Centering Ring, 6 Bolt Holes, 1 Dowel Snout - 1 Bolt Hole, 2 Keyways, 3.40" Long from the Shoulder of the 1st Main Journal to the End of the Snout</p>	AMRE53201	\$ 1350.00	

Prices Subject to Change without Prior Notice. The use of original equipment manufacturer (OEM) part numbers or trademarks, e.g. Case® and John Deere®, are for reference purposes only and for indicating product use and compatibility. Our company and the listed replacement parts contained herein are not sponsored, approved or manufactured by the OEM. All parts are New unless designated Reman in the description.

John Deere®—Industrial / Construction

Application	Description	Part Number	Retail Price	Core
Graders: 670D, 672D, Wheel Feller Bunchers: 643J, 843J, Wheel Loaders: 544J, 624J, 644J Replaces R503470	Crankshaft 6068HRW60, 6068HRW62, 6068HRW71 - 6.8 PowerTech™ Tier II 414 CID 6.8 Liter 6 Cylinder Engines 5" Stroke, 4.192" Bore, 3.063" Rod, 3.123" Main Flange - No Centering Ring, Flat, 6 Bolt Holes, 1 Dowel Snout - Tapered, 1 Bolt Hole, 1 Keyway, No Timing Gear	AMRE505921	\$ 915.00	

Connecting Rods

All connecting rods are cleaned and inspected for defects prior to remanufacturing. Rods are then shot-peened for stress relief and the size is checked against OEM specifications. New piston pin bushings are installed in each rod and bored to the correct center-to-center dimensions. The center-to-center dimension greatly affects the performance of your engine and is a step that many remanufacturers ignore. Final assembly of our connecting rods include installation of new rod bolts and verifying product dimensions, including bend and twist, one final time.



Application	Description	Part Number	Retail Price	Core
Backhoe-Loaders: 310SG, 315SE, 315SG, 410E, 410G, Crawlers/Dozers: 450J, 550H, 550J, 650H, Excavator: 230LCRD, Forklifts: 485E, 486E, 488E, Wheel Loaders: 324H, 344H	Connecting Rod 1.375" Pin Diameter Replaces RE60272	AMRE500002	\$ 90.00	

Crankshafts Pulleys and Dampers

Application	Description	Part Number	Retail Price	Core
Backhoe-Loaders: 210C, 310A, 310B, Forklifts: 480A BSN 193100, 480B BSN 193099, 480C, 482C BSN 216422	Crankshaft Pulley w/ Damper Single Groove, 5.59" OD Replaces T24440, T25365, T47412	AMR80808	\$ 110.00	
Wheel Loaders: 244J, 304J, 324J	Crankshaft Pulley w/ Sleeve	AMRE520244	\$ 32.41	



Camshafts

Application	Description	Part Number	Retail Price	Core
Compactors: 646, 646B, Crawlers/Dozers: 850, 855, Excavators: 890, 890A, 992D, Graders: 770, 770A, 772A, Scrapers: 760, 760A, 762, 860B, Wheel Loaders: 644B, 744E	Reman Camshaft Replaces R63406, R77447, R77448	AMRE11137GRG	\$ 295.00	\$ 100.00
Compactor: 646B, Crawlers/Dozers: 850, 855, Excavators: 890, 890A, 992DLC, Graders: 770, 770A, 772A, Power Units: 6619TF, 6619AF, Scrapers: 760, 760A, 762, 860B, 862, 862B, Wheel Loaders: 644B, 744E	Camshaft Replaces R40469, R44982, R54843, R63406, AR36822	AMRE11137	\$ 359.72	



Balancer Shafts

Application	Description	Part Number	Retail Price	Core
Backhoe-Loaders: 210C, 300D, 310D, 315D, 415B	Balancer Shaft Replaces AR61351, R54054, RE26282	Right Hand AMRE56349	\$ 85.47	
	Balancer Shaft Replaces AR61352, RE26283	Left Hand AMRE56350	\$ 130.00	



John Deere®—Industrial / Construction

Application	Description	Part Number	Retail Price	Core
Backhoe-Loaders: 310E, 310G, 310J, 310K, 310K EP, 310SE, 310SG, 310SJ TMC, 315SE, 315SG, 410E, 410G, 410J, Crawlers/Dozers: 450G, 450H, 450J, 550G, 550H, 550J, 555G, 650G, 650H, Excavators: 110, 120, 120C, 160CLC, 230LCRD, Forklifts: 485E, 486E, 488E, Forwarders: 810D, 1010D, Telehandlers: 3215, 3220, 3400, 3415, 3420, 3800, Wheel Harvester: 770D, Wheel Loaders: 324H, 344H, 444H, 444J, TC44H	Balancer Shaft Replaces RE69364	Right Hand AMRE500448	\$ 120.00	
Backhoe-Loader: 515B	Balancer Shaft Weighted Style Cast # - R54634	Right Hand AMAR69710	\$ 90.00	
	Balancer Shaft Weighted Style Cast # - R54634	Left Hand AMAR69711	\$ 90.00	

Cylinder Heads



Application	Description	Part Number	Retail Price	Core
Wheel Loader: 744H Engine BSN 010637	Reman Cylinder Head w/ Valves Dual Fuel Rail Replaces R115594, R136222, RE69912	AMCHJD12.5-1WV	\$ 6500.00	\$ 2000.00
Wheel Loaders: 744J, 824J, 844J	Reman Cylinder Head w/ Valves Single Fuel Rail Replaces R515452, R518554, SE500708	AMCHJD12.5-2WV	\$ 6500.00	\$ 2000.00

Oil Pumps, Engine

Application	Description	Part Number	Retail Price	Core
Excavators: 120, 120C, 160CLC, 200CLC, 230CLC, 270CLC	Engine Oil Pressure Switch 0.125" Thread Size	AMRE55145	\$ 65.45	



Oil Coolers, Engine

Application	Description	Part Number	Retail Price	Core
Backhoe-Loader: 300B, Compactors: 646 BSN 223644, 646B SN 223645-247906, Skidder: 440 w/ 11-CM3, 23-CM3 or 50-CM3 Pump, Wheel Loaders: 444, 544B	Oil Cooler Hose 0.75", ID, 22" Overall TY22423, Also Replaces L35843, R109884, R109885 when cut to proper length	AMTY22423	\$ 11.05	
Backhoe-Loaders: 310, 310A, 310B, 310C, 315C, 410, 410B, 415B, 710B, 710C, Crawlers/Dozers: 350B, 350C, 350D, 355D, 400G Early, 450B, 450C, 450D, 455D, Excavators: 70, 70D, 290D, Graders: 570, 570A, 570B, Skidders: 440, 440A, 440B, 540, 540A, Wheel Feller Bunchers: 743, 743A, Wheel Loaders: 444, 444C, 444CH, 444D, 544, 544A, 544E Early	Oil Cooler Hose 0.63" ID, 1.319" Long	AMR55127	\$ 10.15	
Backhoe-Loaders: 410C, 410D, 510B, 510C, 510D, 610B, 610C, Crawlers/Dozers: 450E, 450G, 455E, 455G, 550, 550A, 550B, 550G, 555, 555A, 555B, 555G, 650G, 655B, 750B, 750C, 755B, Excavators: 490D, 490E, 495D, 590D, 595, 595D, 690D, 690DR, 690ELC, 790ELC, Graders: 670B, 672B, Power Units: 4045DF, 4045TF, 4045TFM, 4276D, 4276T, 6068DF, 6068DFM, 6068TF, 6068TFM, 6414D, 6414T, Skidders: 340D, 440C, 440D, 448D, 540B, 540D, 540E, 548D, 548E, 640D, 640E, 640G, 648D, 648E, 648G, Track Feller Bunchers: 493D, 653E, 693D, Wheel Feller Bunchers: 643, 643D, Wheel Loaders: 344E, 344G, 444E, 444G, 624E, 624G	Oil Cooler Core Diameter: 2.375" Replaces AR65812	AMRE31089	\$ 469.58	

Prices Subject to Change without Prior Notice. The use of original equipment manufacturer (OEM) part numbers or trademarks, e.g. Case® and John Deere®, are for reference purposes only and for indicating product use and compatibility. Our company and the listed replacement parts contained herein are not sponsored, approved or manufactured by the OEM. All parts are New unless designated Reman in the description.

John Deere®—Industrial / Construction

Application	Description	Part Number	Retail Price	Core
Backhoe-Loaders: 710D, 710G, 710J, Crawlers/Dozers: 450G, 550G, 555G, 650G, 700H, 700J, 750C, 750C-II, 750J, Excavators: 110, 120, 120C, 160CLC, 160LC, 200CLC, 200LC, 230CLC, 230LC, 230LCR, 230LCRD, 240DLC, 270CLC, 270DLC, 270LC, 690ELC, Forwarders: 810D, 1010D, 1110D, 1410D, Graders: 670C, 670C-II, 670CH, 670CH-II, 670D, 672CH, 672CH-II, 672D, Knuckleboom Loaders: 330B, 335, 335C, 430B, 430B-II, 435, 435-II, 435C, 437C, Power Units: 4045HF120, 4045HF150, 4045HF158, 4045HF157, 4045HF275, 4045TF157, 4045TF158, 4045TF220, 4045TF250, 4045TF258, 4045TF275, 4045TFM50, 4045TFM75, 6068HF120, 6068HF150, 6068HF157, 6068HF158, 6068HF250, 6068HF258, 6068HF275, 6068HF285, 6068HF475, 6068HF485, 6068HFN50, 6068HFN51, 6068SFM50, 6068SFM75, 6068TF120, 6068TF150, 6068TF151, 6068TF157, 6068TF158, 6068TF220, 6068TF250, 6068TF258, 6068TF275, 6068TFM50, 6068TFM75, 6068TFM76, Skidders: 360DC, 360DG, 460DC, 460DG, 540G, 540G-II, 540G-III, 548G, 548G-II, 548G-III, 640G, 640G-II, 640G-III, 648G, 648G-II, 648G-III, Swing Machines: 2054, 2554, Telehandlers: 3200, 3215, 3220, 3400, 3415, 3420, 3800, Track Feller Bunchers: 653E, 653G, Wheel Feller Bunchers: 643G, 643H, 643J, 740, 840, 843G, 843H, 843J, Wheel Harvesters: 770D, 1070D, Wheel Loaders: 444H, 444H LL, 444J, 544H, 544H LL, 544J, 624H, 624H LL, 624J, TC44H, TC54H, TC62H	Oil Cooler, 9 Plate Replaces RE560754	AMRE59298	\$ 175.00	
Compactor: 646C, Crawler/Dozer: 850B, Excavators: 690C, 690CR, 790, 790D, 792, 892DLC, Graders: 770A, 770B, 770BH, 772A, 772B, 772BH, Scrapers: 762A, 762B, Skidders: 740, 740A, Track Feller Bunchers: 693C, 793D, Wheel Feller Bunchers: 743, 743A, Wheel Loaders: 544, 544A, 644A, 644C, 644D, 644E, 644ER	Oil Cooler, 12-Plate	AMAT25038	\$ 188.51	
Wheel Loaders: 244J, 304J, 324J	Oil Cooler, 9 Plate	AMRE515469	\$ 188.95	
	Oil Cooler Hose	AMR516071	\$ 12.44	



Radiators

Application	Description	Part Number	Retail Price	Core
Backhoe-Loader: 300B, Forklift: 480	Radiator w/o Side Mount Oil Cooler Replaces AT20847, AT28810	AMAR65715	\$ 235.00	
Backhoe-Loaders: 310, 310A, 310B	Radiator Core: 13 3/4" x 20 1/8" x 2 5/8"	AMAT32527	\$ 480.00	
Backhoe-Loaders: 500C, 510	Radiator Core: 18 7/8" x 22 7/16" x 2 5/8"	AMAT58449	\$ 688.47	
Crawlers/Dozers: 950C, 1050C	Radiator Core: 16.00" x 23 3/8" x 2 3/4" 4 Rows, 10 Fins per Inch	AMAT26474	\$ 465.00	
Telehandlers: 3220, 3420	Radiator Core: 21 3/8" x 22 1/2" x 5 1/4" 13 Fins per Inch Replaces AL164554, AL169733, AL176361	AMAL171542	\$ 1440.00	

John Deere®—Industrial / Construction



Radiator Hoses and Thermostats

Application	Description	Part Number	Retail Price	Core
Backhoe-Loader: 210C, Forklift: 482C	Radiator Hose, Upper 1.50" ID	AMT100921	\$ 19.44	
Backhoe-Loader: 300B Gas, Forklifts: 380, 480, 480A, 480B - Gas, Skidders: 440, 440A, 440B - Gas	Radiator Hose, Upper 1.50" ID	AMT22496	\$ 12.00	
Backhoe-Loader: 300B BSN 345266, Forklifts: (380 BSN 345266, 480 - Diesel), (480A, 480B BSN 305414 w/ Diesel Engine), Skidders: (440, 440A, 440B BSN 49999)	Radiator Hose, Upper 1.50" ID	AMT23533	\$ 13.17	
Backhoe-Loaders: 300D, 310C, 310D, 315C, 315D, 410B, 410C, 410D, 415B, 510B, 510C, 510D, 515B, 610B, 610C, 710B, 710C, 710D	Radiator Hose, Upper 1.92" & 2" ID	AMT68579	\$ 26.83	
Backhoe-Loaders: 310, 410 - Gas	Radiator Hose, Upper 1.50" ID	AMT33370	\$ 13.29	
Backhoe-Loader: 410 Diesel	Radiator Hose, Upper 1.50" ID	AMT33401	\$ 23.02	
Backhoe-Loaders: 500, 500A, 500B, 500C, 510, 600	Radiator Hose, Upper 2" ID	AMR26475	\$ 13.19	
Forklifts: (480A, 480B ASN 305415 w/ Diesel)	Radiator Hose, Upper 1.50" ID	AMTY22409	\$ 8.94	
Scraper: 760A	Radiator Hose, Upper 2" ID	AMR53231	\$ 17.00	
Backhoe-Loader: 210C, Forklift: 482C	Radiator Hose, Lower 1.875" ID	AMT100922	\$ 17.07	
Backhoe-Loaders: 300B, 310, 310A, 310B, 410, Forklifts: 380, 480, 480A, 480B, 480C, Skidder: 440, 440A, 440B	Radiator Hose, Lower 1.875" ID	AMT22500	\$ 9.00	
Backhoe-Loader: 300B, Forklifts: 380, 480, 480A, 480B, Skidders: (440, 440A, 440B BSN 49999) - All w/ Gas Engine	Radiator Hose, Lower 1.875" ID	AMT22497	\$ 16.53	
Backhoe-Loaders: 300D, 310C, 410B, 410C, 410D, 415B, 510B, 510C, 510D, 515B, 610B, 610C	Radiator Hose, Lower 2" & 2.312" ID	AMT100294	\$ 30.04	
Backhoe-Loaders: 500, 500A, 500B, 500C, 510	Radiator Hose, Lower 1.937" and 2.187" ID	AMR26472	\$ 11.18	
Backhoe-Loaders: 310J, 310K, 310L, 310SJ, 310SK, 310SL, 315SJ, 315SK, 315SL, 410J, 410K, 410L, 710J, 710K, Crawlers/Dozers: 450J, 650J, 850J, 850J-II, 850JR, 950K, Dump Trucks: 250D, 260E, 300D, 310E, Excavators: 120D, 130G, 160DLC, 160GLC, 180GLC, 200DLC, 210G, 210GLC, 350DLC, 350GLC, 380GLC, E330LC, E360, E400, Forwarders: 1710D, 1711D, 1910E, Graders: 670G, 670GP, 672G, 672GP, 770G, 770GP, 772G, 772GP, 870G, 870GP, 872G, 872GP, Knuckleboom Loaders: 335D, 337E, 437D, Skidders: 848L, 948L, Swing Machines: 2154D, 3154G, 3156G, 3754D, 3754G, 3754GLC, 3756G, 3756GLC, Track Feller Bunchers: 753J, 753JH, 759J, 759JH, 803M, 853M, 859M, 903K, 903M, 909K, 909M, 953K, 953M, 959K, 959M, Track Harvesters: 703JH, 803MH, 853MH, 859MH, 903KH, 903MH, 909KH, 909MH, 953MH, 959MH, Wheel Harvesters: 1270D, 1270E, 1270G, 1470D, 1470E, 1470G, Wheel Loaders: 524K, 524K-II, 544K, 544K-II, 724K, 744K	Thermostat, 180° 2.125" OD Replaces RE540550	AMDZ100553	\$ 16.56	
Backhoe-Loaders: 310K, 310L, 310SK, 310SK TC, 310SL, 315SL, 410K, 410K TC, 410L, Crawlers/Dozers: 450K, 550K, 605K, 650K, 755D, 764 High Speed, 850J, Excavators: 130G, 160GLC, 180GLC, 210G, 210GLC, 240DLC, 250GLC, 270DLC, 290GLC, E210LC, E240LC, Forwarders: 810D, 810E, 1010D, 1010E, 1110D, 1110E, 1110G, 1210E, 1210G, 1410D, 1510E, 1510G, Graders: 620G, 620GP, 622G, 622GP, 670G, 670GP, 672G, 672GP, Skidders: 460DC, 460DG, 640G-III, 640H, 640L, 648G-III, 648H, 648HTJ, 648L, 748H, 748HTJ, 748L, 848H, 848HTJ, Swing Machines: 2154G, 2156G, 2454D, 2654G, 2656G, 2954D, Wheel Feller Buncher: 643L, Wheel Harvesters: 1070D, 1070E, 1170E, Wheel Loaders: 344K, 444K, 524K-II, 544K-II, 624J, 624K, 624K-II, 624KR, 644J, 644K	Thermostat Replaces RE538806	AMRE538289	\$ 15.50	

John Deere®—Industrial / Construction

Prices Subject to Change without Prior Notice. The use of original equipment manufacturer (OEM) part numbers or trademarks, e.g. Case® and John Deere®, are for reference purposes only and for indicating product use and compatibility. Our company and the listed replacement parts contained herein are not sponsored, approved or manufactured by the OEM. All parts are New unless designated Reman in the description.

John Deere®—Industrial / Construction

Application	Description	Part Number	Retail Price	Core
Crawlers/Dozers: 655K, 700K, 750K, 755K, 850K, 950K, 1050K, Dump Trucks: 250D, 260E, 300D, 310E, 370E, 410E, 460E, Excavators: 210GLC, 250GLC, 290GLC, 300GLC, 350GLC, 380GLC, 470GLC, Forwarders: 1110E, 1110G, 1210E, 1210G, 1510E, 1510G, 1910G, Graders: 670G, 670GP, 672G, 672GP, 770G, 770GP, 772G, 772GP, 870G, 870GP, 872G, 872GP, Knuckleboom Loader: 437E, Skidders: 640L, 648L, 748L, 848L, 948L, Swing Machines: 2154G, 2156G, 2654G, 2656G, 3154G, 3156G, 3754G, 3756G, Track Feller Bunchers: 803M, 853M, 859M, 903M, 953M, 959M, Track Harvesters: 803MH, 853MH, 859MH, 953MH, 959MH, Wheel Feller Bunchers: 643L, 843L, Wheel Harvesters: 1070E, 1070G, 1170E, 1170G, 1270E, 1270G, 1470E, 1470G, Wheel Loaders: 524K, 524L, 544K, 544L, 624K, 624L, 644K, 724K, 744K, 824K-II, 844K-II, 844K-III, 944K	Thermostat Replaces RE540379	AMRE554015	\$ 19.62	
Backhoe-Loaders: 310, 310A, 410, Crawlers/Dozers: 350 Gas, 350B Gas, 450, Forklifts: 480 Diesel, 480A Diesel BSN 305414, 480C	Thermostat Housing Hose 0.50" ID	AMT20277	\$ 9.68	
Excavator: 200DLC, Swing Machine: 2154D, Track Feller Bunchers: (753JH, 759J, 759JH ASN 220452), Track Harvester: 703JH ASN 220452	Rubber Coupling, Upper Radiator Hose 2" & 2.50" ID Replaces R188811	AMR189038	\$ 9.75	

Ring Gears

Application	Description	Part Number	Retail Price	Core
Backhoe-Loaders: 500, 500A, 500B, 500C, 510 - w/ Gas Engine	Flywheel Ring Gear 165 Tooth, 15.54" ID, 16.678" OD	AMR26054	\$ 124.79	



Water Pumps and Components

Application	Description	Part Number	Retail Price	Core
Crawlers/Dozers: 850J, 850JR, Dump Trucks: 250D, 300D, Excavators: 350DLC, 350GLC, 380GLC, E330LC, E360LC, Forwarders: 1710D, 1910E, Graders: 670G, 670GP, 672G, 672GP, 770G, 770GP, 772G, 772GP, 870G, 870GP, 872G, 872GP, Swing Machine: 3754D, Track Feller Bunchers: 753J, 753JH, 759J, 759JH, 803M, 853M, 903K, 903M, 909K, 909M, 953K, 953M, 959K, 959M, Track Harvesters: 703JH, 803MH, 853MH, 903KH, 903MH, 909KH, 909MH, Wheel Harvesters: 1270D, 1270E, 1470D, 1470E, Wheel Loaders: 724K, 744K - All w/ PowerTech™ 6090 9.0L Tier 2 and 3 Engines	Water Pump Kit 14 Tooth Gear Replaces RE523828, SE51228	AMRE530194	\$ 160.00	
Backhoe-Loaders: 300B, 310, Excavators: 70, 70D, 290D, Forklifts: 380, 480, Skidders: 440, 440A, 440B - All w/ 300 Series Diesel Engines	Reman Water Pump Cast # - R51039 Replaces RE19949	AMR51039	\$ 120.00	\$ 30.00

John Deere®—Industrial / Construction

Application	Description	Part Number	Retail Price	Core
Backhoe-Loaders: 310J, 310K, 310L, 310SJ, 310SL, 315SJ, 315SL, 325J, 325SL, 410J, 410K, 410L, 710D, 710G, 710J, 710L, Crawlers/Dozers: 550K, 650K, 700H, 700J, 750C, 750J, 755D, 764 High Speed, 850J, Excavators: 120C, 120D, 130G, 160CLC, 160DLC, 160GLC, 180GLC, 200DLC, 200LC, 210G, 210GLC, 230LC, 240DLC, 250GLC, 270CLC, 270DLC, 270LC, 290GLC, 690ELC, Forklifts: 485E, 486E, 488E, Forwarders: 810D, 810E, 1010D, 1010E, 1110D, 1110E, 1210E, 1410D, 1510E, Graders: 670C, 670CH, 670D, 670G, 672CH, 672D, 672G, Skidders: 360DC, 540G, 540G-II, 540H, 548G-II, 548H, 640G, 640G-II, 640H, 640L, 648G-II, 648H, 648L, 740G, 748G, 748H, 748L, 848H, Swing Machines: 2054, 2554, Track Feller Bunchers: 653E, 653G, Wheel Feller Bunchers: 643G, 643H, 643J, 643K, 643L, 843G, 843H, 843J, 843K, Wheel Harvesters: 1070D, 1070E, 1170E, Wheel Loaders: 444H, 444K, 544H, 624H, 624J, 624K, 624KR, 644J, 644K, TC44H, TC54H, TC62H - All w/ 3029, 4036, 4045 or 6068 Engine	Water Pump Pulley 94 mm Diameter	AMR115250	\$ 41.67	
Crawler/Dozer: 850, Excavators: 330LC, 330LCR, 370, Skidders: 560D, 660D, 740G, 748G, 848G, Wheel Loaders: 644G, 644H, 644J	Water Pump 16 Tooth Gear, Low Flow	AMRE521502	\$ 145.00	
Crawler/Dozer: 850C, Excavators: 792DLC, 892ELC, Wheel Loader: 644G	Water Pump Cast # - RE49540W/X, RE500514W/X Replaces RE49540, RE68229, RG28370	AMRE500214	\$ 231.00	
Crawler/Dozer: 850J, Excavators: 210G, 210GLC, Forwarders: 810E, 1010E, 1110D, 1110E, 1210E, 1410D, 1510E, Skidder: 648H, Wheel Harvesters: 1070D, 1070E, 1170E, Wheel Loaders: 444K, 624J	Water Pump Replaces RE509813, RE523169	AMRE546918	\$ 130.00	
Crawlers/Dozer: 950K, Dump Trucks: 250D, 300D, Excavators: 350GLC, 380GLC, Forwarder: 1910G, Graders: 870G, 870GP, 872G, 872GP, Loaders: 644K, 724K, 744K, 744K-II, Skidders: 848L, 948L, Swing Machines: 3154G, 3156G, 3754G, 3756G, Track Feller Bunchers: 803M, 853M, 903M, 953M, 959M, Track Harvesters: 803MH, 853MH, 953MH, 959MH, Wheel Harvesters: 1270G, 1470G	Water Pump	AMDZ102107	\$ 419.00	
Crawler/Dozer: 1050K, Wheel Loaders: 824K, 844K	Water Pump	AMRE549117	\$ 525.00	
Wheel Loaders: 304J, 324J	Water Pump Replaces RE507604	AMRE545573	\$ 170.00	
Backhoe-Loaders: 310E, 310G, 310SE, 310SG, 310SL, 315SE, 315SG, 410E, 410G, 410K, 410L, 710D, 710G, 710J, 710L, Crawlers/Dozers: 450G, 455G, 550G, 555G, 650G, 650H, 650J, Excavators: 110, 120, 120C, 130G, 160LC, 200CLC, 230CLC, 270CLC, E210LC, E240LC, Forklifts: 485E, 486E, 488E, Forwarders: 810D, 1010D, 1110D, 1410D, Knuckleboom Loaders: 330B, 335, 335C, 335D, 430B, 435C, 437C, 437D, Skid Steer Loader: 270, Swing Machines: 2054, 2554, Telehandlers: 215, 3415, Wheel Harvesters: 770D, 1070D, Wheel Loader: WL56	Fan Drive Pulley	AMR128660	\$ 84.94	
Telehandlers: 3200, 3215, 3220, 3400, 3415, 3420, 3800	Tensioner Isolator	AMAL81953	\$ 17.50	
Wheel Loaders: 244J, 304J, 324J	Fan Idler Pulley	AMRE537940	\$ 20.64	

Fan Clutch Components

Application	Description	Part Number	Retail Price	Core
Wheel Loaders: 244J, 304J, 324J	Fan Drive Hub w/ Bearing	AMRE505621	\$ 85.95	

Belts

Application	Description	Part Number	Retail Price	Core
Backhoe-Loader: 300B Gas or Diesel	Fan Belt Replaces T20334	AMR97758	\$ 13.00	

Prices Subject to Change without Prior Notice. The use of original equipment manufacturer (OEM) part numbers or trademarks, e.g. Case® and John Deere®, are for reference purposes only and for indicating product use and compatibility. Our company and the listed replacement parts contained herein are not sponsored, approved or manufactured by the OEM. All parts are New unless designated Reman in the description.

John Deere®—Industrial / Construction

Application	Description	Part Number	Retail Price	Core
Excavators: 200CLC, 230CLC, 240DLC, 270CLC, 270DLC, 350DLC, Swing Machine: 3754D	A/C Compressor Belt	AMDH400223	\$ 27.75	



Fuel Lift Pumps

Application	Description	Part Number	Retail Price	Core
Backhoe-Loader: 310L, Excavators: 17D, 17G, 26G, 27D, 30G, 35D, 35G, 50G, 60D, 60G, 75G, 85G, E36ZS, Wheel Loaders: 204L, 244K, 244L, 304K, 304L, 324K, 324L	Fuel Transfer Pump	AMAT318139	\$ 71.00	

Injection Pumps

All of our injection pumps are disassembled, thoroughly cleaned and inspected. All worn out parts are replaced and the pumps are reassembled with new gaskets. Pumps are tested for leaks and fuel delivery at low idle, high idle, full load, part load and at start up. Any pumps with an automatic advance system has the advance set. As an additional quality check, all pumps are tested with a special oil that will not varnish inside the pump.



Application	Description	Part Number	Retail Price	Core
Crawler/Dozer: 750	Reman Injection Pump Roosa Master, Mfg # - DM4627-4489	AMP750-DM	\$ 1250.00	\$ 400.00
Wheel Loader: 644A Engine ASN 280000	Injection Line, Fuel Filter to Injection Pump	AMAR31553	\$ 33.79	

Injectors

Our remanufactured injectors are disassembled and thoroughly cleaned. The internal components are lapped to ensure there is no leakage. All tips are inspected for hole erosion and opening pressure; and the spray pattern is tested using OEM specifications.



Application	Description	Part Number	Retail Price	Core
Backhoe-Loader: 210C, 300B, 310, 310A, 310B, 310C, 315C, 410, 410B, 710B, 710C, Crawlers/Dozers: 350, 350B, 350C, 350D, 355D, 400G, 450, 450B, 450C, 450D, 455D, 455G, 550G, 555G, 650G, Excavators: 70, 70D, 290D, Forklifts: 380, 480, 480A, 480B, 480C, 482C, Graders: 570, 570A, Skidders: 440B, 540A, Wheel Loaders: 444, 444D, 544, 544A	Injector 3-152, 3-164, 3-179, 4-202, 4-219, 4-239, 6-303, 6-329, 3029, 4039 Turbo & Non-Turbo Engines Pencil # - 17427, 17511, 18457, 18717, 18742, 19762, 20500, 20631, 22042, 22202, 22203, 27333, 27334, 28481	AMAR89564	\$ 45.00	
Backhoe-Loaders: 300D, 310D, 315D	Pencil Injector	AMRE38087	\$ 33.00	
Backhoe-Loaders: 310G, 310SG, 310SJ, 315SG, Crawlers/Dozers: 450H, 550H, 650H	Injector Replaces SE501177	AMRE515684	\$ 64.03	
Excavators: 200CLC, 270CLC, Swing Machines: 2054, 2554	Injector Replaces SE501105	AMRE507948	\$ 61.70	
Excavators: 690, 690A, Wheel Loader: 644A	Injector Replaces SE501166	AMAR52014	\$ 61.67	
Graders: 670C, 670C-II, 670CH, 670CH-II, 672CH, 672CH-II	Injector Replaces SE501104	AMRE507287	\$ 61.04	
Scrapers: (760, 760A - w/ 6.531D 6 Cylinder Engine)	Injector Replaces SE501164	AMAR50782	\$ 61.67	

John Deere®—Industrial / Construction

Application	Description	Part Number	Retail Price	Core
Backhoe-Loaders: 210C, 300B, 300D, 302A, 310, 310A, 310B, 310C, 310D, 315C, 315D, 401C, 401D, 410, 410B, 410C, 415B, 500, 500A, 500B, 500C, 510, 510B, 510C, 515B, 610B, 610C, 710B, 710C, Compactor: 646, Crawlers/Dozers: 350, 350B, 350C, 350D, 355D, 400G, 450, 450B, 450C, 450D, 450E, 450G, 455D, 455E, 455G, 550, 550A, 550B, 550G, 555, 555A, 555B, 555G, 650G, 655, 655B, 750, 750B, 755, 755A, 755B, Excavators: 70, 70D, 190E, 290D, 490, 490D, 495D, 590D, 595, 595D, 690, 690A, 690D, 690DR, Forklifts: 380, 480, 480A, 480B, 480C, 482C, Graders: 570, 570A, 570B, 670, 670A, 670B, 672A, 672B, Knuckleboom Loaders: 7610, 7620, 7630, Power Units: 152DN01, 202DE01, 219DH01, 219DH02, 3029DF, 3029DF120, 3029DF128, 3029DF150, 3029DF151, 3029DF152, 3029DF160, 3029DF180, 3164D, 3179D, 329DH01, 329DH02, 329DN03, 4039DF, 4039DFM, 4219D, 4239D, 4239T, 4239T/A, 4276D, 4276T, 6059DF, 6068DF, 6068DFM, 6329D, 6359D, 6359T/A, 6404, 6414D, 6414T, EA202D, HA219D, HA303D, HB303D, HC219D, HC329D, NA152D, NA303D, NB329D, Scrapers: 760, 760A, Skidders: 340D, 440, 440A, 440B, 440C, 440D, 448D, 540, 540A, 540B, 540D, 548D, 640, 640D, 648D, Track Feller Bunchers: 493D, 693D, Wheel Feller Buncher: 643, Wheel Loaders: 344E, 444, 444C, 444CH, 444D, 444E, 544, 544A, 544B, 544C, 544D, 544E, 624E, 644, 644A	Pencil Injector Washer For Lower Injector 0.381" ID, 0.562" OD, 0.120" Thick Replaces 64355A, 499210, A41403	AMR60746	\$ 0.58	



Turbochargers and Components

Application	Description	Part Number	Retail Price	Core
Backhoe-Loaders: 310E, 310SE, 315SE, 410E, Crawlers/Dozers: 450G, 455G, 550G, 555G, 650G, Wheel Loader: 344H	Turbocharger Replaces RE60099, RE505047, RE508876	AM471049-9001	\$ 575.00	
Backhoe-Loaders: 710J, 710K, Crawlers/Dozers: 750J, 750J-II, Excavators: 200DLC, 210G, 210GLC, Swing Machine: 2154D, Wheel Loaders: 524K, 524K-II, 544J, 544K, 544K-II	Turbocharger	AMRE550941	\$ 1071.43	
Excavators: 350GLC, E330LC, E360, Wheel Loaders: 724K, 744K	Turbocharger Replaces DZ107131, RE531469, SE502374	AMRE531288	\$ 781.50	
Wheel Loaders: 244J, 304J	Turbocharger Replaces SE501678	AMRE518228	\$ 475.00	
Backhoe-Loaders: 310J, 310SJ, 315SJ, 325J, 410J, 710G, 710J, Crawlers/Dozers: 700H, 700J, 750J, 755D, 764, 850J, Excavators: 160GLC, 180GLC, 200DLC, 210G, 210GLC, 270CLC, Forklift: 444JR, Forwarders: 810D, 1010D, 1110D, 1410D, 1510E, Graders: 670C, 670CH, 670D, 672CH, 672D, Swing Machine: 2554, Wheel Feller Bunchers: 643J, 643K, 843J, 843K, Wheel Harvester: 770D, 1070D, Wheel Loaders: 324H, 344H, 344J, 444J, 544J, 624J, 624K, 644J, 644K, 824K, 844K	Turbocharger Drain Hose	AMR120013	\$ 33.92	
Backhoe-Loaders: 310E, 310G, 310J, 310SE, 310SG, 310SJ, 315SE, 315SG, 315SJ, 325J, 410G, 410J, 710G, 710J, Knuckleboom Loaders: 330B, 335, 335C, 430B, 435, 435C, 437C, Skidders: 540G, 540G-II, 548G-II, 640G, 640G-II, 648G, 648G-II, 740G, 748G, Track Feller Bunchers: 653E, 653G, Wheel Feller Bunchers: 643G, 843G, Wheel Loaders: 324H, 344H, 344J	Turbocharger Oil Inlet Hose	AMRE501260	\$ 43.00	
Excavator: 160DLC	Turbocharger Replaces RE528771	AMRE548726	\$ 765.00	

John Deere®—Industrial / Construction



Manifold and Components

Application	Description	Part Number	Retail Price	Core
Backhoe-Loader: 300B w/ 3 Cylinder Diesel Engine and Vertical Exhaust	Exhaust Manifold	AMT20252	\$ 110.00	
Backhoe-Loader: 300B w/ 3-Cylinder Diesel Engine	Manifold Gasket Set, Set of 3 Ref# R90658	AMX36262	\$ 1.26	

Starters

All of our remanufactured starters are disassembled, cleaned and inspected. Almost all units receive new field coils. If it meets OEM specifications the armature is test turned and under cut, otherwise it is replaced with a quality factory remanufactured or new part. Starters with factory solenoids have the solenoids replaced with new parts. The drive is carefully inspected and if it does not meet specifications it is replaced with new or quality factory remanufactured drives.



Application	Description	Part Number	Retail Price	Core
Backhoe-Loaders: 210C, 300B, 300D, 310, 310A, 310B, 310C, 310D, 315C, 315D, 410, 510C, 610C, Crawlers/Dozers: 350, 350B, 450B, 450E, 455E, Forklifts: 380, 480, 480A, 480B, 480C, 482C, Skidder: 540A	Starter, 12 Volt Delco, 28MT, Gear Reduction, 10 Tooth Replaces AL110597, AL70850, RE59588, RE62916, RE417418, SE501428, TY1458, TY6702, TY24305	AMRE239087	\$ 160.00	
Backhoe-Loaders: 500, 500A, 500B, 500C, 510, Compactor: 646C, Excavators: 690, 690A, 690B, Graders: 570, 570A, Skidders: 540, 740A, Track Feller Buncher: 693B, Wheel Feller Bunchers: 743, 743A, Wheel Loaders: 544, 544A, 544B, 644A, 644C, 644D, 644E, 644ER, 644EZ - All Diesel	Starter, 12 Volt HD Planetary Gear Reduction, 10 Tooth Steel Pinions, Steel Ring Gear, CW Rotation Replaces 1113391, 1113672 Solenoid Use w/ AMX34112 Starter	AMX34112 AMX34113	\$ 285.00 \$ 60.00	
Telehandlers: 3200, 3215, 3220, 3415, 3420, 3800	Starter, 12 Volt Gear Reduction, 10 Tooth, 4.20kW Replaces RE509856, RE523501, SE502632	AMRE523502	\$ 275.00	
Wheel Loaders: 244J, 304J, 324J	Starter, 12 Volt Bosch, Planetary Magnet Gear Reduction, 9 Tooth, 2.20kW, CW Rotation, 2-Ear Mount	AMRE508922	\$ 99.00	
Wheel Loaders: 744H, 744J, 824J	Starter, 24 Volt Gear Reduction, 12 Tooth, 6.50kW Note: Special Order Item	AMRE540886	\$ 625.00	
Backhoe-Loader: 300B	Ignition Switch Replaces AR47458, AR47459, AR53452	AMAR58126	\$ 19.97	

Air Cleaner Components

Application	Description	Part Number	Retail Price	Core
Backhoe-Loaders: 310E, 310G, 310J, 310K, 310L, 310SE, 310SG, 310SJ, 310SK, 310SL, 315SE, 315SG, 315SJ, 315SK, 315SL, 325J, 325K, 325SK, 325SL, 410E, 410G, 410J, 410K, 410L, 710D, 710J, Crawlers/Dozers: 450H, 450J, 550H, 550J, 650H, 650J, 700H, 700J, Excavators: 230LCR, 230LCRD, Knuckleboom Loaders: 330B, 335, 335C, 430B, 435, 435C, 437C, Skidders: 460D, 640G-II, 640G-III, Track Feller Bunchers: 653E, 653G, Wheel Feller Bunchers: 643G, 643H, 740, 840, 843G, 843H, Wheel Loaders: 324H, 344H, 344J	Air Intake Hose 3.15" Long	AMR500596	\$ 7.06	

John Deere®—Industrial / Construction



Tachometers, Gauges and Instrument Cluster

Red needle: early tractors; white needle: late tractors, has provisions for back light and fiber optics.

Application	Description	Part Number	Retail Price	Core
Backhoe-Loaders: 300B	Tachometer Replaces AR50954, AT20641, AT159296, T22409	AMAR65445	\$ 25.00	
Backhoe-Loaders: 500A SN 123114-152141, 500B	Fuel Gauge For 12 Volt Negative Ground Systems w/ 2" Opening OD, 1 1/2" Thick Gauge Housing, 30 to 250 OHM Rating Note: Some applications may require external ground (not included) Replaces AT375294, AR45436	AMAR45436	\$ 46.50	
Backhoe-Loaders: 300B	Tachometer Cable 25.19" Long Replaces AT19904	AMAL23838	\$ 16.00	
Backhoe-Loaders: 500, 500A BSN 123113	Tachometer Cable 33.50" Long, Steel Outer Sheath, Restoration Quality Replaces AR28589	AMAR26721	\$ 29.50	



Alternators

Application	Description	Part Number	Retail Price	Core
Backhoe-Loaders: 210C ASN 787475, 300D, 310C, 310D, 310E, (310G, 310SG BSN 958549), 310SE, 315C, 315D, 315SE, 315SG, 410C, 410D, 410E, 410G BSN 958703, 510C, 510D, 710D, 710G BSN 960384, Crawlers/Dozers: (450G, 455G, 550G, 555G, 650G SN 788817-821573), 450H, 550H, 650H, (450J, 550J, 650J BSN 159986), Knuckleboom Loaders: 330B, 335, 335C, 430B, 435C, 437C, Skidders: Skidders: 360DC, 360DG BSN 604615, 460DC, 460DG, (540E, 548E, 640E, 648E ASN 538967), 540G, 540G-II, (540G-III, 548GIII, 640G-III, 648G-III SN 576603-604613), 540H, 548G, (548GII, 640G-II SN 565685-576602), 560D, 640G, 640H, 648G, 648G-II, 648H, (740E, 748E ASN 539019), 740G, 748G, Telehandlers: 3215, 3220, 3415, 3800, Wheel Feller Bunchers: 643, 643D, 643G, 643H, 643J, 740, 840, 843G, 843H, 843J, Wheel Loaders: 544G, 624G, 644G	Alternator Bosch, 12 Volt, 95 Amps Replaces ABO0209, AL-6236	AMTY24485	\$ 141.00	
Skidders: 440C, 540B, 540D, 640, 640D	Alternator 12 Volt, 72 Amps, IR/EF, CW Rotation, Plug at 12 o'clock Position, 3-Pin	AMTY6600	\$ 137.86	
Telehandler: ML1335, Wheel Loaders: 344J, L512, L514, L524, L528, L534	Reman Alternator Bosch Type, 12 Volt, 65 Amps, IR/EF	AMRE533516	\$ 188.59	\$ 20.00
Wheel Loaders: 444D, 544D	Alternator 80 Amps, w/o Pulley Replaces AR87205, AR93448, AT103789	AMTY26050	\$ 170.00	

John Deere®—Industrial / Construction

John Deere®—Industrial / Construction

Sensors

Application	Description	Part Number	Retail Price	Core
Backhoe-Loaders: 310E, 310J, 310K, 310SJ, 410E, 410J, 410K, 710J, Crawlers/Dozers: 450J, 550J, 650J, 700J, 750J, 850J, 850JR, Dump Trucks: 300D, 250D, Excavators: 210G, 210GLC, 350DLC, 350GLC, 380GLC, E360, Forwarders: 810E, 1010E, 1110D, 1110E, 1210E, 1410D, 1510E, Graders: 670G, 670GP, 672G, 672GP, 770G, 770GP, 772G, 772GP, 870G, 870GP, 872G, 872GP, Skidders: 540H, 640H, 648H, Skid Steer Loaders: 318D, 319D, 320D, 323D, 326D, 328D, 329D, 332D, 333D, Swing Machines: 2154D, 2154G, 2156G, 2454D, 2654G, 2656G, 2954D, 3154G, 3156G, 3754D, 3754G, 3756G, Track Feller Bunchers: 753J, 753JH, 759J, 759JH, 803M, 953K, 953M, 959K, 959M, Track Harvesters: 703JH, 803MH, 853MH, 903KH, 903MH, 909KH, 909MH, Wheel Harvesters: 1070D, 1070E, 1170E, 1270E, 1470D, 1470E, Wheel Loaders: 244J, 304J, 324J, 344J, 444J, 444K, 544J, 624J, 644J, 724K, 744K, 844K	Air Temperature Sensor Replaces 72102514	AMRE525016	\$ 19.25	
Backhoe-Loaders: 310G, 310J, 310K, 310K EP, 310SG, 310SJ, 310SK, 315SG, 315SJ, 315SK, 325J, 325K, 325SK, 410G, 410J, 410K, 710G, 710J, 710K, Crawlers/Dozers: 450H, 450J, 550H, 550J, 650J, 700H, 700J, 750C, 750C-II, 750J, 755D, 850J, 950K, LR612, LR614, Excavators: 120, 120C, 120D, 130G, 160CLC, 160DLC, 160GLC, 160LC, 180GLC, 200CLC, 200DLC, 210G, 210GLC, 230CLC, 240DLC, 250GLC, 270DLC, 290GLC, 330CLC, 350DLC, 350GLC, 370C, 380GLC, 450CLC, 892ELC, Forklift: 444JR, Forwarders: 810D, 810E, 1010D, 1010E, 1110D, 1110E, 1210E, 1410D, 1510E, 1710D, 1711D, 1910E, Graders: 670C, 670CH, 670D, 670G, 670GP, 672CH, 672D, 672G, 672GP, 770B, 770BH, 770C, 770CH, 770G, 770GP, 772B, 772BH, 772CH, 772D, 772G, 772GP, 870D, 870G, 870GP, 872D, 872G, 872GP, Skidders: 360D, 460D, 540G-II, 540G-III, 540H, 548G-II, 548G-III, 548H, 560D, 748G-II, 748H, 748HTJ, 848H, 848HTJ, Swing Machines: 2054, 2554, 3554, Telehandlers: 3215, 3220, 3415, 3420, 3800, Track Feller Bunchers: 608B, 608L, 608S, 640G-II, 640H, 648G-II, 648H, 653G, 703G, 703JH, 753G, 753GL, 759G, 803M, 853G, 853J, 853M, 900, 903G, 903J, 903K, 909J, 909K, 953J, 953K, 959K, 959M, Track Harvesters: 853JH, 903JH, 903KH, 909JH, Wheel Loaders: 244J, 304J, 324J, 444J, 444K, 524K, 544J, 544K, 624J, 624K, 624KR, 644H, 644K, 724J, 724K, 744K, 824J, 824K, 844J, 844K, 844K-III, 944K	Engine Speed Sensor	AMRE519144	\$ 20.00	
Backhoe-Loaders: 310G, 310SG, 315SG, 410G, 710G, Graders: 670D, 672D, 770D, 772D, 870D, 872D, Wheel Loaders: 444J, 444K, 524K, 524K-II, 544J, 544K, 544K-II, 624J, 624K, 624KR, 644H, 644K, 724J, 724K, 744K, 824J, 824K, 844J, 844K, 844K-III, 944K	Potentiometer Sensor	AMRE261354	\$ 100.00	
Crawler/Dozer: 850J, Excavators: 350DLC, 350GLC, 380GLC, Forwarder: 1910E, Graders: 670G, 670GP, 672G, 672GP, 770G, 770GP, 772G, 772GP, 870G, 870GP, 872G, 872GP, Track Feller Bunchers: 803M, 853M, 903K, 903M, 909K, 909M, 953K, 953M, 959K, 959M, Track Harvesters: 703JH, 903KH, 909KH, Wheel Loaders: 724K, 744K	Fuel Filter Moisture Sensor Replaces RE532949	AMRE503590	\$ 60.00	

Hydrostat Components and Drives

Application	Description	Part Number	Retail Price	Core
Forwarder: 810D ASN 002300	Hydrostat Motor Replaces F062899	AMF070730	\$ 6000.00	
Forwarder: 1010D	Hydrostat Motor	AMF062837	\$ 7440.00	
Forwarder: 1110D ASN 002300	Hydrostat Motor Replaces F063897	AMF070732	\$ 7440.00	
Forwarders: 1110E BSN 003819, 1210E BSN 001501, 1510E BSN 003001	Hydrostat Motor	AMF069929	\$ 7440.00	
Forwarder: 1410D	Hydrostat Motor Replaces F062623	AMF070731	\$ 7440.00	
Forwarder: 1710D	Hydrostat Motor Replaces F070735	AMF671923	\$ 8565.00	





John Deere®—Industrial / Construction

Application	Description	Part Number	Retail Price	Core
Wheel Harvester: 770D	Hydrostat Motor Replaces F062973	AMF070729	\$ 5940.00	
Wheel Harvesters: 970D, 1070D ASN 001300	Hydrostat Motor Replaces F062974	AMF070733	\$ 7435.00	
Wheel Harvesters: 1270D ASN 001000, 1470D Tier 2 SN 0001-0309 & ASN 001000	Hydrostat Motor Replaces F062681	AMF070734	\$ 7440.00	
Wheel Harvesters: 1270E ASN 002500, 1270G, 1470E ASN 001800, 1470G	Hydrostat Motor 215 cc	AMF075293	\$ 8975.00	
Wheel Harvesters: 1270E BSN 002501, 1470E BSN 001801	Hydrostat Motor	AMF072672	\$ 7440.00	
Forwarder: 810D ASN 002002	Hydrostat Pump Replaces F062625, F076738	AMF678172	\$ 3970.00	
Forwarder: 1010D ASN 004000	Hydrostat Pump Replaces F062836, F076741	AMF678176	\$ 4915.00	
Forwarder: 1110D ASN 002300	Hydrostat Pump Replaces F062682, F071586, F074560, F076740	AMF678175	\$ 6080.00	
Forwarder: 1410D ASN 001200	Hydrostat Pump Replaces F062624, F073767, F074561	AMF678170	\$ 6540.00	
Forwarder: 1710D	Hydrostat Pump Replaces F057019, F062637, F071313, F076739	AMF678174	\$ 8065.00	
Wheel Harvester: 770D	Hydrostat Pump Replaces F062972, F076736	AMF678177	\$ 3970.00	
Wheel Harvesters: 970D, 1070D ASN 001300	Hydrostat Pump Replaces F061336, F076734	AMF678166	\$ 4815.00	
Wheel Harvesters: 1170G, 1270D ASN 001000, 1270E, 1270G	Hydrostat Pump 190 cc Replaces F062536, F066764	AMF680147	\$ 8010.00	
Wheel Harvesters: (1270D, 1470D ASN 001000)	Hydrostat Pump Replaces F062534, F071310, F076735	AMF678168	\$ 5835.00	
Wheel Harvesters: 1270G SN 003505-004998, 6W and 8W, 1470D ASN 001000, 1470E, 1470G	Hydrostat Pump 210 cc Replaces F069146	AMF680155	\$ 8345.00	
Wheel Harvester: 1470E	Hydrostat Pump Replaces F072737	AMF678183	\$ 5810.00	
Track Feller Bunchers: 608B, 608L, 608S, 703G, 753G, 753GL, 753J, 753JH, 759J, 759JH, 850, 853G, 853J, 900, 903G, 903K, Track Harvesters: 703JH, 853JH, 903KH	Track Drive Unit Gear Box	AMF434223	\$ 6465.00	
Track Feller Bunchers: 608B, 703G	Track Drive Unit Gear Box w/ Standard Frame w/o Motor Replaces PG200363	AMF434149	\$ 16850.00	
Track Feller Bunchers: 608B BSN 005014, 850, 853G, 853J, 900, 903G, 903K, 950 ASN 009003, 953G ASN 004004, Track Harvesters: 853JH, 903KH	Track Drive Unit Gear Box w/o Motor Replaces AT457896	AMF434151	\$ 19995.00	
Track Feller Bunchers: 608L, 608S, 753G, 753GL, 753J, 753JH, 759G, 759J, 759JH, Track Harvester: 703JH	Track Drive Unit Gear Box w/o Motor	AMF434221	\$ 19100.00	
Track Feller Bunchers: 753J ASN 220452, 753JH ASN 220452, 850 ASN 008018, 853G ASN 003083, 900, 903G, 903J, 903K, 909J, 909K, 950, 953G, 953J, 953K, 959J, Track Harvesters: 903JH, 903KH, 909JH, 909KH	Track Drive Unit Gear Box w/ Standard Duty Gearbox Replaces AT457867	AMF434071	\$ 24385.00	



John Deere®—Industrial / Construction

Mechanical Front Wheel Drive Parts



MFWD Hub Components

	Application	Description	Part Number	Retail Price	Core
Mechanical Front Wheel Drive Parts		Backhoe-Loaders: 210C SN 737488-796033, 300D, (310C, 310D, 315D ASN 796033), 310E, 310G, 310SE, 310SG, 315C, 315CH ASN 737488, 315SE, 315SG BSN 962303, 710B, 710C, 710D, Forklifts: 482C SN 747987-796033, 485E, 486E, 488E, Wheel Loader: 324H	Cylindrical Roller Bearing Replaces VPJ2550	AMJD10250	\$ 45.00
		Backhoe-Loaders: 310G, 310SG, 315SG, 410D, 410G, 510D	Planetary Pinion Gear	AML100241	\$ 120.00
		Telehandlers: 3200, 3215, 3400, 3415, 3420, 3800	Planetary Pinion Gear 30 Tooth	AML114784	\$ 185.00
		Telehandlers: 3200, 3400	Planetary Pinion Shaft	AML110236	\$ 95.00
		Backhoe-Loaders: (310G, 310SG, 315SG SN 962304-962373), (410D, 510D ASN 796855), 410E, 410G	Ring Gear	AML79729	\$ 425.00

Tie Rods and Components

	Application	Description	Part Number	Retail Price	Core
	Backhoe-Loaders: 210C, 300D, 310C, 310D, 315C, 315D, 410C, 410D, 510C, 510D, Forklift: 482C	Ball Joint 8.25" Long M22x1.50" and M24x1.50" Right Hand Threads Replaces N14377	AMAL60161	\$ 65.00	
	Backhoe-Loaders: 310, 310A, 310B, 410, 500, 500A, 500B, 500C, 510, Forklift: 480C, Scrapers: 760, 760A	Tie Rod Clamp	AMM2301T	\$ 6.00	

Spindles

	Application	Description	Part Number	Retail Price	Core
	Backhoe-Loaders: 300B, 310 BSN 237997, Forklifts: 480 ASN 136912, 480A, 480B	Spindle Right or Left Hand A - 10.125 B - 1.75 C - 1.795 D - 1.312	AMAT33636	\$ 557.85	
	Backhoe-Loaders: 310, 310A, 310B, Forklift: 480C	Spindle Right or Left Hand A - 9.313 B - 1.747 C - 1.795 D - 1.312	AMAT76758	\$ 703.37	

John Deere®—Industrial / Construction



Wheel Hubs and Components

Application	Description	Part Number	Retail Price	Core
Backhoe-Loader: 300D	Wheel Hub, 8-Bolt Use w/ R50992 Press-On Hub Cap	AMR49841	\$ 85.00	



Axle Pivot Pins

Application	Description	Part Number	Retail Price	Core
Backhoe-Loaders: 300B, 310A, 310B, 410, 500C, Forklifts: 380, 480, 480A, 480B, 480C	Pivot Pin, Front 3.521" Long, 1.25" Diameter	AMT21669	\$ 12.00	
Backhoe-Loader: 300B, Forklifts: 380, 480, 480A, 480B, 480C	Pivot Pin, Rear 4.10" Long, 1.5727" OD	AMR54195	\$ 47.88	



Hydraulic Oil Coolers

Application	Description	Part Number	Retail Price	Core
Forklift: 480	Hydraulic Oil Cooler Replaces AR69398, AT77459, AT169229	AMAT165535	\$ 355.00	

Hydraulic Pumps and Motors

Application	Description	Part Number	Retail Price	Core
Backhoe-Loaders: 310SJ TMC, 310SK TC, 410G ASN 951254, 410J, 410J TMC, 410K, 410K TC	Hydraulic Pump	AMAT334876	\$ 4195.00	
Backhoe-Loaders: 310SL HL, 325SL, 410L	Hydraulic Pump 74 cc	AMAT431384	\$ 3995.00	
Crawler/Dozer: 755D	Hydraulic Pump	AMLW10440679	\$ 6425.00	
Crawler/Dozer: 764, Wheel Loaders: 644K Hybrid, 844J	Hydraulic Pump, Fan Drive	AMAT308355	\$ 1038.00	
Crawlers/Dozers: 605K, (750J, 750J-II SN 312435), 750K, 750L	Hydraulic Pump 63 cc	AMAT371543	\$ 3450.00	
Crawlers/Dozers: 655K, 750K BSN F271593, 850K	Hydraulic Pump 100 cc	AMAT378791	\$ 6425.00	
Crawlers/Dozers: 750J BSN 141344, 850J BSN 312436	Hydraulic Pump 74 cc	AMAT227183	\$ 4195.00	
Crawlers/Dozers: 750J BSN 235510, 850J BSN 208885, 850JR	Hydraulic Pump 100 cc	AMAT311182	\$ 6425.00	
Crawlers/Dozers: 850J ASN 312435, 850J-II, 850K, 850L	Hydraulic Pump 74 cc	AMAT370019	\$ 4100.00	
Dump Trucks: 350D, 400D	Hydraulic Pump Replaces TT210249	AMAT320769	\$ 5843.00	
Forwarders: 810B ASN 8100745, 810C, 810D	Hydraulic Pump	AMF058423	\$ 3750.00	
Forwarder: 1010D ASN 003639	Hydraulic Pump	AMF062758	\$ 4710.00	
Forwarder: 1110D	Hydraulic Pump	AMF062759	\$ 5585.00	
Forwarders: 1110E, 1110G, (1210E, 1510E - Tier 3 Gen I w/ Rotating and Leveling Cab)	Hydraulic Pump	AMF069894	\$ 5585.00	
Forwarders: 1410D, 1710D	Hydraulic Pump	AMF062760	\$ 5585.00	
Track Feller Bunchers: 753J, 753JH SN 178713-220452, 759J, 759JH, Track Harvester: 703J SN 178713-220452	Hydraulic Pump	AMAT343119	\$ 14250.00	
	Hydraulic Pump Replaces PG201122	AMAT343120	\$ 13000.00	

John Deere®—Industrial / Construction

Application	Description	Part Number	Retail Price	Core
Track Feller Bunchers: 753J, (753JH, 759JH BSN 220453), 759J, Track Harvester: 703JH	Hydraulic Pump	AMAT343125	\$ 4195.00	
Track Feller Bunchers: (803M, 853M - w/o Hydrostatic Transmission), Track Feller Bunchers: 859M, 903M, 909M, 953M, 959M, Track Harvesters: (803MH, 853MH, 859MH, 953MH, 959MH BSN 326230), Track Harvesters: 903MH, 909MH	Hydraulic Pump 71 cc	AMAT407296	\$ 3990.00	
Track Feller Bunchers: 850, 853G, 900, 903G, 950, 953G	Hydraulic Pump Replaces F435006	AMAT466837	\$ 18910.00	
Track Feller Bunchers: 853J, 903J, 903K, 909J, 909K, 953J, 953K, 959J, 959K, Track Harvesters: 853JH, 903JH, 903KH, 909JH, 909KH	Hydraulic Pump Replaces F437276	AMAT466836	\$ 20200.00	
Track Feller Bunchers: (903M, 959M BSN 343966), Track Feller Buncher: 909M, 953M BSN 326230, Track Harvesters: (803MH, 853MH, 859MH BSN 308387), Track Harvesters: 903MH, 909MH, Track Harvesters: (953MH, 959MH BSN 326230)	Hydraulic Pump 60 cc	AMAT407295	\$ 3260.00	
Track Feller Bunchers: (903M, 953M, 959M SN 301367-317981), 909M ASN 301366	Hydraulic Pump 260 cc Replaces AT447992	AMAT465940	\$ 21395.00	
Track Harvesters: (803MH, 853MH, 859MH ASN 326229 w/ Hydrostatic Transmission)	Hydraulic Pump	AMAT482172	\$ 6050.00	
Wheel Feller Bunchers: 643J, 643K, 843J, 843K	Hydraulic Pump Replaces F125038	AMAT335993	\$ 2750.00	
Wheel Feller Buncher: 843K	Hydraulic Pump	AMAT336025	\$ 3990.00	
Wheel Harvester: 770D	Hydraulic Pump Replaces F064223	AMF682179	\$ 5590.00	
Wheel Harvesters: 970D, 1070D ASN 001300	Hydraulic Pump Replaces F061339, F062978, F070999	AMF682617	\$ 6385.00	
Wheel Harvesters: 1270E ASN 002500, 1270G, 1470E ASN 001800, 1470G	Hydraulic Pump 180 cc	AMF075178	\$ 7150.00	
Wheel Loader: 444K	Hydraulic Pump	AMAT337774	\$ 3260.00	
Wheel Loader: 524K BSN 642122	Hydraulic Pump	AMAT337775	\$ 4195.00	
Wheel Loader: 544J	Hydraulic Pump Replaces AT226829	AMAT347903	\$ 3360.00	
Wheel Loader: 544K BSN 639108	Hydraulic Pump	AMAT337776	\$ 5350.00	
Wheel Loaders: 624K BSN 649457, 624KR	Hydraulic Pump	AMAT337777	\$ 6425.00	
Wheel Loader: 844J	Hydraulic Pump Replaces PG200236	AMAT316685	\$ 5035.00	
	Hydraulic Pump Replaces PG200237	AMAT323920	\$ 4735.00	
Dump Trucks: (250D, 300D BSN 642001)	Hydraulic Steering Metering Piston Pump	AMTT210492	\$ 3644.00	
Dump Trucks: 250D, 300D, 350D, 400D	Hydraulic Steering Metering Pump Replaces PG200344	AMTT210493	\$ 1050.00	
Track Feller Bunchers: 753J, 753JH, 759G, 759J, 759JH, Track Harvester: 703JH	Hydraulic Saw Pump Replaces F125977	AMAT343118	\$ 3665.00	
Track Feller Bunchers: 853J, 903J, 903K, 909J, 909K, 953J, 953K, 959J, 959K, Track Harvesters: 853JH, 903JH, 903KH, 909KH	Hydraulic Saw Pump	AMF437268	\$ 3775.00	
Wheel Feller Buncher: 643K	Hydraulic Saw Pump	AMAT336026	\$ 3990.00	
Crawler/Dozer: 764, Track Feller Bunchers: 903K, 903M BSN 343999, 909K, 909M, 953K, (953M, 959M BSN 343998), 959K, Track Harvesters: 903KH, 903MH, 909KH, 909MH, (953MH, 959MH SN 317982-343998), Wheel Loaders: 744K BSN E630720, 824K BSN E641970, 844J, 844K BSN E645194	Hydraulic Motor, Fan Drive 28 cc	AMAT308356	\$ 1085.00	
Dump Trucks: 350D, 400D	Hydraulic Motor, Fan Drive Replaces AT226829	AMTT210246	\$ 2350.00	

John Deere®—Industrial / Construction

Application	Description	Part Number	Retail Price	Core
Swing Machine: 959ML, Track Feller Bunchers: (608B, 608L, 703G, 753G, 753GL, 753J, 759G, 853M, 859M, 900, 903G, 909J, 950, 953G, 953J, 953K, 959J, 959K, 959M BSN 334647), (753JH, 759JH BSN 258547), 608S, 759J BSN 258547, 803M, 853G ASN 0003083, 903K, 903M, 909K, 909M, 953M, Track Harvesters: 703JH BSN 258547, 803MH, 853JH, 853MH, 859MH, 909MH, 953MH, 953ML, 959MH, (903JH, 903KH, 903MH, 909JH, 909KH BSN 334647)	Hydraulic Motor, Swing Drive Replaces F121812	AMF434661	\$ 1925.00	
Track Feller Bunchers: (753J, 753JH ASN 220452), 850 ASN 008018, 853G ASN 003083, 900, 903G, 903J, 903K, 909J, 909K, 950, 953G, 953J, 953K, 959J, 959K w/ Heavy Duty Gearbox, Track Harvesters: 903JH, 903KH, 909JH, 909KH	Hydraulic Motor, Track Drive	AMF121596	\$ 8870.00	
Track Feller Bunchers: (753J, 759J SN 220453-C269976), 803M	Hydraulic Saw Motor	AMF121407	\$ 5836.00	
Track Feller Bunchers: 803M, 850, 853J, 853M, 859M, 900, 903G, 903J, 903K, 903M, 909J, 909K, 909M, 953G ASN 004004, 959J, Track Harvesters: 803MH, 853MH, 859MH	Swing Drive Gear Box 32.47:1 Ratio w/o Motor Replaces AT473507, F120648, F121813, F434664	AMAT475605	\$ 15885.00	
3.3 cu. in. Main Hydraulic Pumps, Non-Serialized	Hydraulic Pump Shaft Used in 49 cc pumps, 6 cylinder engines	AMR34348	\$ 70.00	
Backhoe-Loaders: 210C, (300B, 310A, 410 SN 267583-268350 & ASN 270055), 300D, 310C, 310D, 315C, 315D, 410B, 410C, 415B, 500C, 510 ASN 283547, 510B, 510C, 510D, 515B, 610B, 610C, 710B, 710C, 710D, Forklift: 482C, Wheel Loaders: 444C, 444CH, 544C, 644C	Hydraulic Pump Drive Coupler Replaces T58195	AML34569	\$ 14.50	
Backhoe-Loader: 300B BSN 197259	Hydraulic Pump Drive Coupler 14 Spline, 4.37" Long	AMT22915	\$ 132.00	
Backhoe-Loaders: 500, 500A, Scraper: 760, Skidder: 440	Hydraulic Pump Drive Coupler 14 Spline, 4.37" Long	AMR34359	\$ 55.49	
Compactor: 646, Scraper: 762, Wheel Loaders: 444, 544, 644	Hydraulic Pump Drive Coupler	AMT31093	\$ 147.62	

Power Steering Cylinder Components

Application	Description	Part Number	Retail Price	Core
Backhoe-Loaders: 500A, 500B, 500C, 510, Scraper: 760	Power Steering Cylinder Pin Replaces R30917	AMR76513	\$ 15.82	

Selective Control Valves and Couplers

Application	Description	Part Number	Retail Price	Core
Backhoe-Loader: 500, Crawlers/Dozers: 350, 350C, 450B, 450C, 550, 550A	Outlet Socket, Selective Control Valve Coupler	AMR34397	\$ 52.50	
Backhoe-Loader: 300B	Selective Valve Seal Kit	AMRE10924	\$ 29.00	

Topshaft Components

Application	Description	Part Number	Retail Price	Core
Backhoe-Loaders: 500, 500A, 500B, 500C	Transmission Drive Shaft	AMR33512	\$ 602.39	

John Deere®—Industrial / Construction

Transmission Components

Application	Description	Part Number	Retail Price	Core
Backhoe-Loaders: 300B, 310, 310A, 310B, 410	3rd and 7th Gear on Differential Driveshaft 31 & 20 Tooth, 1.375" ID, 4.75" OD Marked T31080 Replaces T21978	AMAT30053	\$ 232.45	
Backhoe-Loader: 300B	4th & 8th Gear, Differential Drive Shaft 20 & 27 Tooth, 1.875" ID, 4.075" OD	AMT21977	\$ 178.80	
Backhoe-Loader: 300B	Transmission Pump Adapter Replaces AR39093	AMAR69659	\$ 220.00	

PTO Shafts and Components

Application	Description	Part Number	Retail Price	Core
Backhoe-Loader: 500	PTO Gear	AMR33339	\$ 204.00	
Backhoe-Loaders: 500, 500A	Drive Sleeve, PTO Output Shaft For Syncro-Range or Powershift Transmission	AMR33855	\$ 57.50	



Brakes and Components

Application	Description	Part Number	Retail Price	Core
Backhoe-Loaders: 210C ASN 747742, 300B, 300D, 310D, 315D	Brake Disc 12 Spline, 12" OD Replaces AT22034	AMAT63106	\$ 120.00	
Backhoe-Loaders: 310, 410, Forklifts: 480, 480B	Brake Plate 8.663" ID, 12.044" OD Replaces T28177, T38063, T46728	AML31016	\$ 98.00	



Brake Pinion Shafts

Application	Description	Part Number	Retail Price	Core
Graders: 570, 570B, Wheel Loader: 644	Brake Pinion Shaft 9.39" Long, 15 Tooth, 18 Spline Replaces R33431	AMR45779	\$ 450.93	

Drawbars and Components

Application	Description	Part Number	Retail Price	Core
Backhoe-Loader: 300B ASN 249301	Drawbar, Straight, Standard Duty 2.50" x 1.25" x 36.75", (3) 0.781" diameter front holes: 1.125", 2.75" & 8.578" from front	AMR61126	\$ 95.00	
Backhoe-Loader: 500C	Drawbar, Offset, Heavy Duty 2.50" x 1.25" x 44.75" w/ 2.50" Offset and w/o Hammer Strap Holes, (6) 1.01" diameter holes: 1.06", 2.31", 4.36", 7.05", 9.05" & 12.30" from front	AMR81576	\$ 135.00	
Backhoe-Loader: 300B	Lower/Rear Drawbar Support Replaces T31725	AMT21677	\$ 72.64	



John Deere®—Industrial / Construction

Lower Lift Links

Application	Description	Part Number	Retail Price	Core
Backhoe-Loader: 300B BSN 362024	Inner Pull Arm, Front Telescoping Style	AMAT30150	\$ 370.48	
	Inner Pull Arm, Front Telescoping Style	AMAT30151	\$ 358.21	
Backhoe-Loader: 300B ASN 362025	Inner Pull Arm, Front Telescoping Style	AMAL26679	\$ 318.24	
	Inner Pull Arm, Front Telescoping Style	AMAL26678	\$ 325.36	
Backhoe-Loader: 300B	Outer Pull Arm, Rear Telescoping Style Use w/ AMAL26678, AMAL26679, AMAR32547, AMAR32548, AMAT30150 or AMAT30151 Pull Arm to complete Assembly	AMAR28570	\$ 185.00	
	Pull Arm, Cat II, HD Non-Telescoping Flat Style 33.50" Long (Center-to-Center)	AMAR77530	\$ 290.00	

Load Sensing Shafts

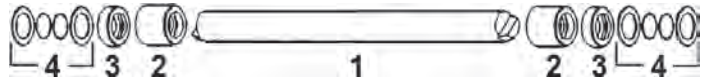

Application	Img Ref #	Description	Part Number	Retail Price	Core
Backhoe-Loaders: 300B	1	Load Sensing Shaft 19.69" Long, 0.815" Diameter Replaces T26598	AML26932	\$ 57.50	
Backhoe-Loaders: 500, 500A, 500C	1	Load Sensing Shaft, 20.937" Long, 1" Diameter	AMR33883	\$ 93.55	
Backhoe-Loaders: 500, 500A, 500C	4	Load Control Shims	AMR66425	\$ 18.10	
Backhoe-Loaders: 500, 500A, 500C	3	Load Control Seal	AMAR27371	\$ 6.05	

Toplink Assemblies Components

Application	Description	Part Number	Retail Price	Core
Backhoe-Loader: 500	Center Link Handle Replaces R27007	AMR42495	\$ 11.00	

Sway Blocks



Application	Description	Part Number	Retail Price	Core
Backhoe-Loader: 300B	Sway Block	Right Hand AMT30276	\$ 40.00	
	Sway Block	Left Hand AMT30277	\$ 40.00	
Backhoe-Loader: 300B	Sway Block Support Plate	Right Hand AMAT20167	\$ 47.00	
	Sway Block Support Plate Replaces AR90971	Left Hand AMAT20168	\$ 47.50	

Battery Boxes and Components







Application	Description	Part Number	Retail Price	Core
Backhoe-Loader: 500A SN 123114-152141	Battery Box	Right Hand AMAR40673	\$ 70.00	
		Left Hand AMAR40674	\$ 70.00	
Backhoe-Loader: 401C, Forklifts: 480A, 480B	Battery Box Door Cover	AMAT20026	\$ 40.00	

John Deere®—Industrial / Construction

Application	Description	Part Number	Retail Price	Core
Backhoe-Loader: 500	Positive Battery Cable 38" Long	AMAR28950	\$ 21.23	

Lighting

Application	Description	Part Number	Retail Price	Core
	Excavators: 230LCR, 230LCRD, 330LCR, Wheel Loaders: 444H, 444J, 544H, 544J, 624H, 624J, 644H, 644J, 724J, 744H, 744J, 824J, TC44H, TC54H, TC62H Replaces AT208435, AT226338, R54411, R54412	LED Floodlight Lower Front, Cab, Fender and ROPS 6" x 3.50" x 6" Rectangle Light 3600 Lumens, 40 Watts, 3.30 Amps For 12 Volt to 24 Volt Systems Includes Connector, Plug-and-Play	AMTL3030	\$ 90.00
		LED Floodlight Lower Front, Cab, Fender and ROPS 6" x 3.50" x 6" Rectangle Light 3600 Lumens, 40 Watts, 3.30 Amps For 12 Volt to 24 Volt Systems Includes Connector, Plug-and-Play	AM92269C1	\$ 72.00
	Telehandlers: 3200, 3215, 3220, 3400, 3415, 3420, 3800	LED Floodlight Cab Mount 4.25" x 4.50" Oval Light 3600 Lumens, 40 Watts, 3.20 Amps For 12 Volt to 24 Volt Systems Replaces RE567623, AL150478, AL156627, AL174341, AL175528, AL175529, AL202742, AL202743, AL205375	AMRE219708	\$ 105.00
	Backhoe-Loaders: 310G, 310J, 310K, 310L, 310SG, 310SJ, 310SK, 310SL, 315SG, 410J, 410K, 410L, 710G, 710J, 710K, 710L	LED Warning Light Floodlight 6.75" x 4" x 2.75" Rectangle Light Amber Lens, 11 Watts, 0.90 Amp For 12 Volt to 24 Volt Systems Plug-and-Play for Direct Replacement Includes Stainless Steel Hardware Replaces AT151873, AT326622	AMTL8020	\$ 50.00
	Backhoe-Loaders: 310G, 310J, 310K, 310L, 310SG, 310SJ, 310SK, 310SL, 315SG, 410J, 410K, 410L, 710G, 710J, 710K, 710L	LED Warning Light Floodlight 6.75" x 4" x 2.75" Rectangle Light Amber Lens, 11 Watts, 0.90 Amp For 12 Volt to 24 Volt Systems Plug-and-Play for Direct Replacement Includes Stainless Steel Hardware Replaces AT151873, AT326622	AMRE217551	\$ 40.00

Glass

Application	Description	Part Number	Retail Price	Core
444K, 524K, 524K-II, 544K, 544K-II, 624K, 624K-II, 644K, 724K, 744K, 744K-II, 824K, 844K, 844K-II, 944K	Front Windshield Glass	AMT230096	\$ 291.72	

Gas Struts

Application	Description	Part Number	Retail Price	Core
Telehandlers: 3200, 3215, 3220, 3400, 3415, 3420, 3800	Gas Strut, Steering Column Replaces AL150755	AMAL209275	\$ 45.00	



John Deere®—Industrial / Construction









Fuel Tanks and Components

Application	Description	Part Number	Retail Price	Core
Backhoe-Loader: 300B	Fuel Tank w/ Cap	AMAR72996	\$ 465.00	
Backhoe-Loader: 500	Fuel Sending Unit 2" Bolt circle, 16.75" Overall length Operates from 0 to 30 Ohms, Works w/ positive or negative ground systems, Gas or Diesel Includes Mounting Gasket	AMAR26434	\$ 44.01	

Steering Wheels

Application	Description	Part Number	Retail Price	Core
Backhoe-Loaders: 210C, 300B	Steering Wheel Smooth-finish, dished steering wheel w/ 3 covered spokes, 16" diameter, 7/8" splined hub	AMAR78405	\$ 64.00	

Air Conditioning and Components

Application	Description	Part Number	Retail Price	Core
 Crawlers/Dozers: 700H, 700J, 750C, 750J, 850C, 850J, Graders: 670C, 670CH, 670D, 672CH, 672D, 770C, 770CH, 770D, 772CH, 772D, 870D, 872D Replaces AT168543	Compressor, Denso 10PA17C Style 24 Volt, w/ 8-Groove Clutch Distance Between Mounting Holes: Top=5" (Center-to-Center); Bottom=4.60" (Center-to-Center)	AMX10228	\$ 350.00	
 Backhoe Loaders: 300D, 310D, 315D	Compressor Clutch 5.75" w/ 12 Volt Coil, Single Groove, Standard 6E171, w/o Dust Cover	AMRE10975	\$ 125.00	
 Excavators: 120C, 160C, 160CLC, 180CW, 200LC, 230LC, 230LCR, 230LCRD, 270LC, 330LC, 330LCR, 370, 450CLC, 450DLC, 450LC, 550LC, 600CLC, 650DLC, 750, 800C, 850DLC Replaces 4333461	Komatsu Receiver Drier XH9 Desiccant	AMX10239	\$ 40.00	
 Excavators: 200LC, 230LC, 270LC, 330LC, 370, 450LC Replaces AT180998	Expansion Valve Flange Type, O-Ring Connection, R12 and R134a Compatible	AMX10260	\$ 25.00	
 Backhoe-Loaders: 210C, 310C, 315C, 410B, 410C, 510B, 510C, 610B, 610C, 710B, 710C, Crawlers: 450G, 455G, 550G, 555G, 650G	Blower Motor Update Kit Complete Assembly w/ Resistor Includes One Assembly for Models w/ Single Blower Motor 12 Volt, Mounting Base: 21" x 6 5/8"	AMAR82006	\$ 270.00	
Skidders: (540G-III, 548G-III, 640H, 748H, 748HTJ, 848H BSN 649452 w/ A/C & Heater Module or BSN 649526 w/ Heater Module), (540H, 548H, 848HTJ BSN 649452), 560D, 748G-III, (640G-III, 648G-III, 648H - w/ A/C & Heater Module or BSN 649526 w/ Heater Module)	Blower Motor Resistor	AMRE171329	\$ 22.75	
 Backhoe-Loader: 210C	Blower Wheel, Plastic 4" Diameter, 3/8" Shaft, Reversible, Double Vented, Clamps Not Included	AMR81111	\$ 25.00	

John Deere®—Industrial / Construction

Kubota®—Tractor

Table of Contents

Air Conditioning Parts and Components	1313	PTO Shafts	1305
Alternators	1298	Quick Hitches	1308
Belts.....	1292	Radiator Hoses.....	1289
Drawbars	1304	Radiators and Components.....	1286
Fuel Lift Pumps and Components	1293	Rear Axle Components.....	1306
Glass	1312	Rockshaft Components	1316
Hydraulic Pumps and Components	1304	Spindles.....	1302
Injectors	1293	Starters.....	1296
Lift Link Assemblies and Components.....	1308	Steering Arms.....	1303
Lighting.....	1309	Steering Components.....	1307
Manifolds and Components.....	1294	Steering Gearbox Assembly.....	1306
Mechanical Front Wheel Drive Parts	1300	Steering Shafts.....	1307
MFWD Differentials and Components.....	1300	Steering Wheels and Caps.....	1307
MFWD Hubs and Housing	1301	Tie Rods and Components.....	1301
Mufflers and Exhaust.....	1294	Top Link Assemblies	1308
Oil Pump, Engine.....	1286	Transmission Components.....	1304
Power Steering Cylinders and Components.....	1306	Water Pumps.....	1291
PTO Adapters	1306	Wheel Hubs and Components.....	1303

Oil Pump, Engine

Application	Description	Part Number	Retail Price	Core
L35, L355, L2500, L2600, L2800, L2850, L2900, L3000, L3010, L3250, L3300, L3350, L3400, L3450, L3600, L3650, L3710, L4200, L4300, L4310, L4350, L4400, L4610, M4030	Engine Oil Pump Replaces 5471-35010, 15471-35012	AM15471-35013	\$ 74.02	
B20, B21, B26, B1700, B1750, B2100, B2150, B2320, B2400, B2410, B2620, B2630, B2650, B2710, B2910, B2920, B3000, B3030, B3200, B3300, B3350, B4200, B6200, B7200, B7300, B7400, B7410, B7410D, B7500, B7500D, B7510, B7510D, B7610, B7800, B8200, B9200, BX22, BX22D, BX23, BX23D, BX24, BX25, BX1500, BX1800, BX1830, BX1850, BX1850D, BX1860, BX1870, BX2200, BX2200D, BX2230, BX2230D, BX2350, BX2360, BX2370, BX2370-1, BX2660, L39, L45, L47, L48, L235, L275, L2501, L2600, L2800, L3000, L3130, L3200, L3240, L3350, L3400, L3430, L3540, L3560, L3700, L3710, L3750, L3800, L3830, L3940, L4060, L4150, L4240, L4300, L4310, L4330, L4400, L4600, L4610, L4630, L4740, L4760, L5030, L5040, L5060, L5240, L5460, L5740, L6060, M4D-061, M4D-071, M4N-071, M5-091, M5-111, M5L-111, M5N-091, M5N-111, M59, M62, M95S, M105S, M4800SU, M4900, M5660, M5700, M6060, M7060, M8560, M9960, MX4700, MX5000, MX5100	Oil Sender Switch Replaces 15521-39010, 15531-39013, 15531-39014	AM1A024-39010	\$ 17.77	



Radiators and Components

Application	Description	Part Number	Retail Price	Core
B2400D, B2400E, B2400HSD, B2400HSE	Radiator Core: 12 7/8" x 15 1/2" x 2" 2 Rows	AM6C040-58520	\$ 745.00	
B2410HSD, B2410HSDDB, B2410HSE, B2710HSD, F2260, F2560, F2560E	Radiator Core: 12 3/4" x 15 3/8" x 1 7/8"	AM6C070-58520	\$ 600.00	

Kubota®—Tractor

Application	Description	Part Number	Retail Price	Core
B3000HSDC, B3000HSDCC, B3030HSDC, B3030HSDCC	Radiator Aluminum Core: 16 15/16" x 13 3/4" 2 Rows, 11 Fins per Inch Includes Cap w/ 0.90 PSI	AM6C230-58520	\$ 250.50	
B6100, B7100 w/ OEM 16mm Drain Cock Port	Radiator Overall: 14 3/8" x 16 1/2" Core: 13 1/8" x 10 3/4" x 1 3/4" 3 Rows, 12 Serpentine Fins per Inch w/ OEM 16 mm Drain Cock Port Replaces 15553-72110, 15553-72111	AM15553-72060	\$ 480.00	
(B6100, B7100 - w/o HST Transmission)	Radiator Core: 13" x 10 5/8" 3 Rows, 12 Fins per Inch Replaces 15371-72110	AM15371-72060	\$ 304.00	
B7410D, B7500D, B7500DTN, B7500HSD, B7510D, B7510DN, B7510HSD, B7510HSDTR, B7610HSD	Radiator Aluminum Core: 13 1/2" x 11 3/4" 2 Rows, 11 Fins per Inch Includes Cap w/ 0.90 PSI Replaces 6C120-58502, 6C170-58521	AM6C120-58500	\$ 161.50	
B7510	Radiator Overall: 17 1/8" x 16 3/16" Core: 15 3/8" x 12 3/4" x 1 7/8" 2 Rows, 10 Serpentine Fins per Inch	AM6C170-58520	\$ 520.00	
BX23S, BX24D, BX25, BX25DLB, BX25DLB-1, BX1850D, BX1860, BX1870, BX1870-1, BX1880, BX2350D, BX2360, BX2370, BX2370-1, BX2380	Radiator Aluminum Core: 13 1/2" x 12 3/4" 2 Rows, 11 Fins per Inch Includes Cap w/ 0.90 PSI	AMK2581-85010	\$ 103.00	
L175	Radiator Core: 10 3/4" x 14" x 2" Replaces 15221-72063, 15228-72060	AM15221-72060	\$ 190.00	
L235, L245, L275, L2050, L2350, L2500	Radiator Core: 12 3/4" x 13" x 1 3/4" 3 Rows, 16 Fins per Inch	AM15575-72060	\$ 300.00	
L285, L295, L305, L345, L355	Radiator Core: 19 3/4" x 18 1/2" x 2" 3 Rows, 8 Fins per Inch	AM15301-72060	\$ 295.00	
L295DT BSN 001031 & ASN 007245, L295F ASN 007615, L305DT, L305F, L355SS	Radiator Core: 19 3/4" x 18 1/2" x 2"	AM15411-72062	\$ 1033.48	
L2000, L2001, L2200	Radiator Replaces 15321-72111	AM15321-72061	\$ 471.50	
L2250, L2550	Radiator Core: 14 3/4" x 16 1/4" x 1 1/4" Replaces 17321-72060	AM17331-72060	\$ 260.00	
L2600DT, L2600F, L2800DT, L2800F, L2800HST, L3000DT, L3000F, L3400DT, L3400F, L3400HST, L3700SU, L4300DT, L4300F	Radiator Aluminum Core: 17 1/4" x 13 3/4" 2 Rows, 11 Fins per Inch Includes Cap w/ 0.90 PSI	AMTC020-16000	\$ 226.00	
L2650DT, L2650DTGST, L2650DTWET, L2650F, L2950DT, L2950DTGST, L2950DTWET, L2950F	Radiator Overall: 15 3/4" x 18 1/2" Core: 15" x 14 3/4" x 1 1/4" 2 Rows, 12 Fins per Inch	AM17367-72060	\$ 435.00	
L2850DT, L2850DT-GST, L2850F, L3250DT, L3250F	Radiator Core: 15 13/16" x 16 9/16" x 1 1/2"	AM17355-72060	\$ 745.16	
L3130DT, L3130F, L3130GST, L3130HST, L3430DT, L3430GST, L3430HST, L3430HSTC	Radiator Core: 17.598" x 18.307" 1 Row, 11 Fins per Inch	AMT1060-16010	\$ 345.57	
L3240DT, L3240F, L3240GST, L3240HST, L3240HSTC	Radiator Core: 17.598" x 17.717" x 1.063"	AMTD110-16010	\$ 345.57	
L3240DT3, L3240F3, L3240GST3, L3240HST3, L3240HSTC3	Radiator w/o Shroud Core: 15.748" x 17.795" x 1.890"	AMT1880-16002	\$ 394.59	

Kubota®—Tractor

Application	Description	Part Number	Retail Price	Core
L3450DT, L3450F, L3450ST, L3450G, L3650DT, L3650DTGST, L3650F	Radiator Overall: 17 3/8" x 20 5/8" Core: 16 3/4" x 15 7/8" x 1 1/4"	AM16743-72060	\$ 355.00	
L3750, L4150	Radiator Core: 16 3/4" x 19 1/2" x 2" This radiator has a 1/2" off-center connection on the grille side of the bottom tank Replaces 17365-72060	AM17381-72060	\$ 350.00	
L3830DT, L3830F, L3830GST, L3830HST, L4330DT, L4330GST, L4330HST, L4330HSTC, L4630DT, L4630GST, L4630GSTC, L4630HST	Radiator Aluminum Core: 17 5/16" x 17 3/4" 2 Rows, 11 Fins per Inch Includes Cap w/ 0.90 PSI	AMT1150-16010	\$ 258.00	
L4400DT, L4400F, L4400H	Radiator w/o Shroud Core: 19.488" x 19.882" x 1.417"	AMTC230-99600	\$ 428.64	
L4850, L5450	Radiator Core: 16 3/4" x 19 1/2" x 2"	AM32590-10210	\$ 330.00	
M100GXDT, M100XDTC, M108SDS2, M108SDSC, M108SDSC2, M108SDSF, M108SDSL, M108SDSL2, M108SDSL2S, M108SDSLS, M108SH, M108SHC, M108SHD, M108SHDC, M108SHDC2, M108SSDS, M108XDTC, M110GXDT, M110XDTC, M4N-071HD12, M4N-071HDC12, M4N-071HDRC12, M8540DT, M8540DT1, M8540DTC, M8540DTC1, M8540F, M8540F1, M8540FC, M8540FC1, M8540HD, M8540HD1, M8540HD12, M8540HD121, M8540HDC, M8540HDC1, M8540HDC12, M8540HDC121, M8540HDC121, M8540HDC121, M8540HDNBC, M8540HDNBC, M8540HDNBC10, M8540HDNBCPC, M8560HD, M8560HD12, M8560HDC, M8560HDC12, M8560HF, M8560HFC, M9540DT, M9540DT1, M9540DTC, M9540DTC1, M9540F, M9540F1, M9540FC, M9540FC1, M9540HD, M9540HD1, M9540HD12, M9540HD121, M9540HDC, M9540HDC1, M9540HDC12, M9540HDC121, M9540HDC241, M9540HDCLTD, M9540HDL, M9540HDL1, M9540HDL1S, M9540HFL, M9540HFL1, M9540HFL1S, M96SDS, M96SDSC, M96SH, M96SHDM, M9960HD, M9960HD12, M9960HDC, M9960HDC12, M9960HDC24, M9960HDL, M9960HDLSN, M9960HF, M9960HFC	Radiator Aluminum Core: 19 1/8" x 19 1/8" 2 Rows, 12.70 Fins per Inch Includes Cap w/ 0.90 PSI	AM3C081-17100	\$ 258.00	
M550, M5500, M6030 Late, M7030, M7500, M8030	Radiator Core: 17 1/2" x 18 1/16" x 2" Replaces 15708-72060, 15714-72060, 15718-72060	AM15453-72060	\$ 320.00	
M4030, M4030DT, M5030, M5030DT, M5030SU, M5030SUMDT	Radiator Core: 19 9/16 x 18 11/16" 4 Rows	AM17301-72060	\$ 430.00	
M4050, M4050DT, M4500, M4500DT	Radiator Overall: 20" x 21 1/2" Core: 19 1/2" x 16 3/4" x 2 1/2" 4 Rows	AM15612-72060	\$ 335.00	
M4950, (M4950DTS, M4950S Late)	Radiator Overall: 20" x 23 3/8" Core: 19 1/2" x 18 3/4" x 2 1/2"	AM15621-72063	\$ 380.00	

Kubota®—Tractor

Application	Description	Part Number	Retail Price	Core
M5040DT, M5040DT1, M5040DTC, M5040DTC1, M5040F, M5040F1, M5040FC, M5040FC1, M5040HD, M5040HD1, M5040HDC, M5040HDC1, M5140DT, M5140DTC, M5140F, M5140FC, M5140HD, M5140HDC, M5640SU, M5640SUD, M5640SUD1, M5660SUH, M5660SUHD, M6040DT, M6040DT1, M6040DTC, M6040DTC1, M6040F, M6040F1, M6040FC, M6040FC1, M6040HD, M6040HD1, M6040HDC, M6040HDC1, M6040HDNB, M6040HDNB1, M6060HD, M6060HDC, M6060HFC, M7040DT, M7040DT1, M7040DTC, M7040DTC1, M7040F, M7040F1, M7040FC, M7040FC1, M7040HD, M7040HD1, M7040HDC, M7040HDC1, M7040HDCLTD, M7040HDNB, M7040HDNB1, M7040HDNBC, M7040SU, M7040SUD, M7040SUH, M7040SUHD, M7060HD, M7060HD12, M7060HDC, M7060HDC12, M7060HFC	Radiator Aluminum Core: 19" x 17 3/4" 2 Rows, 12.70 Fins per Inch Includes Cap w/ 0.90 PSI	AM3C001-17100	\$ 250.00	
M5950, M6950, M6970, M7580, M7980, M7950, M7970, M8580	Radiator Core: 17 1/2" x 18 1/4" x 2" Replaces 15482-72060, 15482-99280, 15571-72064, 15572-72060	AM15482-99280	\$ 340.00	
M6030 Early, M6030DT, M6030DTN, M6030DTNB	Radiator Core: 18" x 17 1/2" x 2 1/8" 3 Rows, 8 Fins per Inch Extra 1/2" Port to the Left of Bottom Hose Connection	AM15725-72060	\$ 370.00	
(M6800, M6800DT, M6800HDC, M6800S, M6800SDT - w/ Cab), (M8200, M8200DT, M8200HD, M8200SDTN, M9000, M9000DT, M9000DTM, M9000HD, M9000HDL-F - w/o Cab, Low Profile)	Radiator Overall: 19 3/4" x 23" Core: 19 1/4" x 19" x 2 7/16" 4 Rows, 12 Fins per Inch	AM3A151-17100	\$ 485.00	
M7950, M7950DT, M7950DTS, M7970DT	Radiator w/ 9/16" Heater Outlet Core: 19 3/4" x 18 1/2" x 2" 3 Rows, 8 Fins per Inch	AM15483-72060	\$ 1075.81	
L4850, L5450, M7030	Radiator Core: 19 1/2" x 16 3/4" x 2"	AM16504-72060	\$ 350.00	
M8200, M8200DT, M8200HDC, M8200SDTN, M9000, M9000DT, M9000DTMC, M9000HDC	Radiator Core: 19 7/8" x 26 1/4" x 2 7/16"	AM3A75117100	\$ 600.00	
MX4700DT, MX4700F, MX4700H, MX5100DT, MX5100F, MX5100H	Radiator w/o Shroud Core: 17.717" x 18.701" x 1.417"	AMTC250-99602	\$ 428.64	
L355, L1802, L2002, L2402	Fan, 7 Blade Replaces 15501-74110, 15511-74110	AM15521-74110	\$ 28.50	

Radiator Hoses



Application	Description	Part Number	Retail Price	Core
B26, B2710HSD, B2910HSD, B3030HSD, B3200HSD, B3200HSDWO, B3300SUHSD, B7800HSD	Radiator Hose, Upper 1.062" ID	AM6C070-58630	\$ 15.38	
B7200 2WD ASN 20000 & 4WD ASN 60000	Radiator Hose, Upper 1" ID	AM15531-72940	\$ 9.04	
L175, L185	Radiator Hose, Upper 1.312" ID	AM15221-72940	\$ 17.08	
L225, L235, L245, L245H, L275, L285, L295, L305, L345, L355, L2050 BSN 10749	Radiator Hose, Upper 1.312" ID	AM15321-72940	\$ 7.00	
L285, L295, L305, L345, L355	Radiator Hose, Upper 1.312" ID	AM15401-72940	\$ 6.51	

Kubota®—Tractor

Application	Description	Part Number	Retail Price	Core
L2250, L2550, L2850, L3250	Radiator Hose, Upper Front 1.312" ID	AM31351-18010	\$ 4.85	
	Radiator Hose, Upper Rear 1.312" ID	AM31351-18020	\$ 14.34	
L2650, L2950, L3450, L3650	Radiator Hose, Upper 1.312" ID	AM30400-88310	\$ 17.30	
L2900, L3300	Radiator Hose, Upper 1.375" ID	AM34070-16120	\$ 11.85	
L3750, L4150	Radiator Hose, Upper 1.312" ID	AM32530-10552	\$ 10.34	
M4N-071, M8540, M8560, M9540, M9960	Radiator Hose, Upper	AM3C081-17460	\$ 25.27	
M4000	Radiator Hose, Upper 1.375" ID	AM15601-72940	\$ 9.47	
M4050, M4500	Radiator Hose, Upper 1.375" ID	AM15612-72940	\$ 21.23	
(M5950, M6950 ASN 17834), (M5950-S, M6950-S - 2WD ASN 20001 & 4WD ASN 60001), M6030, M6970, M7030, M7030SU, M8030, (M7950 ASN 17834, M7950-S, M7970 - w/o Cab)	Radiator Hose, Upper 1.75" ID	AM15481-72940	\$ 23.88	
M7030 Narrow, Vineyard	Radiator Hose, Upper 1.312" & 1.75" ID	AM16504-72940	\$ 20.64	
(M7950, M7950-S, M7970 - w/ Cab)	Radiator Hose, Upper 1.812" ID	AM15441-72950	\$ 28.25	
M8950, M8950-S, M8970, M9580 ASN 60080	Radiator Hose, Upper 1.312" ID	AM15484-72940	\$ 30.55	
B26, B2710HSD, B2910HSD, B3030HSD, B3200HSD, B3200HSDWO, B3300SUHSD, B7800HSD	Radiator Hose, Lower 1.062" & 1.187" ID	AM6C070-58570	\$ 20.59	
B2320DT, B2320DTWO, B2320HSD, B2620HSD, B2920HSD, B7500D, B7500DTN, B7500HSD, B7510D, B7510DN, B7510HSD, B7510HSDTR, B7610HSD	Radiator Hose, Lower 1.062" & 1.187" ID	AM6A320-58570	\$ 17.05	
B7200	Radiator Hose, Lower 1" ID	AM15531-72850	\$ 5.81	
L175, L185	Radiator Hose, Lower 1.312" ID	AM15221-72850	\$ 15.74	
L225, L235, L245, L245H, L275, L285, L295, L305, L345, L355, L2050 BSN 10749	Radiator Hose, Lower 1.312" ID	AM15321-72850	\$ 6.35	
L2250, L2550	Radiator Hose, Lower Front 1.312" ID	AM31351-18050	\$ 7.65	
	Radiator Hose, Lower Rear 1.312" ID	AM31351-18060	\$ 9.13	
L2800DT, L2800F, L2800HST, L3400DT, L3400F, L3400HST, L3700SU	Radiator Hose, Lower	AMTC220-16140	\$ 18.23	
L2050DT, L2050F ASN 010750	Radiator Hose, Lower	AM35010-88360	\$ 10.00	
L2850, L3250	Radiator Hose, Lower Front 1.312" ID	AM32430-18050	\$ 10.34	
	Radiator Hose, Lower Rear 1.312" ID	AM32430-18060	\$ 11.66	
L2900, L3300, L3600, L4200	Radiator Hose, Lower 1.312" ID	AM34070-80390	\$ 16.23	
L3350, L4350	Radiator Hose, Lower 1.312" ID	AM17365-72850	\$ 28.18	
L3750, L4150, L4850, L5450	Radiator Hose, Lower 1.312" ID	AM17381-72850	\$ 15.75	
L4600DT, L4600F, L4600H	Radiator Hose, Lower	AMTC432-16140	\$ 37.16	

Kubota®—Tractor

Application	Description	Part Number	Retail Price	Core
M4000	Radiator Hose, Lower 1.312" ID Replaces 1560172851	AM15601-72850	\$ 14.30	
M4030, M4950, M4950S, M5030	Radiator Hose, Lower 1.25" ID	AM15621-72852	\$ 12.18	
M4050, M4500	Radiator Hose, Lower 1.312" ID	AM15612-72850	\$ 9.96	
M4950, M4950S	Radiator Hose, Lower 1.312" ID	AM15622-72852	\$ 6.73	
M5500, M7500	Radiator Hose, Lower Short Hose 1.50" ID	AM15701-72850	\$ 7.77	
M5950, M5950-S, M6030, M6950, M6950-S, M6970, M7030, M7030SU, M7950, M7950-S, M7970, M8030, M8950, M8950-S, M8970	Radiator Hose, Lower 1.437" ID	AM15571-72853	\$ 32.76	
M7580, M8580, M9580	Radiator Hose, Lower 1.437" ID	AM16541-72850	\$ 19.72	
M8540, M9540	Radiator Hose, Lower	AM3C081-17450	\$ 36.31	
B20, B1550, B1750, B2150, B5200, B6200 w/ HST Transmission or Gear Drive Engine ASN 369055, B7200, B8200, B9200	Radiator Hose Water Pump to Water Pipe Hose 1" ID	AM15531-72870	\$ 5.16	
L305, L345, L355, L3350, L4150, L4350, L4850, L5450, M4050, M4500, M5030	Heater, Lower Radiator Hose 600 Watts For 1.50" Diameter Hose	AM70000-82500	\$ 65.19	
K4030, L235, L275, L285, L1802, L2002, L2202, L2402, L2500, L2550, L2600, L2900, L2950, L3000, L3010, L3250, L3350, L3410, L3450, L3600, L3650, L3710, L4200, L4300, L4310, L4350, L4850DT, L5450, M4700, M4900, M5030, M5400, M5700, Excavators: K91H, KH66H, KH101, KH151, KX101, KX121, KX151, KX161-2, Loaders: R400, R410, R420, R510, R520	Bypass Hose	AM15321-73340	\$ 14.50	
KH191, KH28L, L245, L285, L295, L305, L345, L2000, L2201, L2600, M4850DT, M4950	Bypass Hose	AM15321-73350	\$ 7.00	
B20, B5200, B6200 2WD ASN 020000 or 4WD ASN 060000, B7200, B8200, B9200	Drain Hose	AM15741-73130	\$ 6.58	
B7500, B7510, B7610	Drain Hose, Lower 0.47" ID	AM6A320-58690	\$ 5.77	

Water Pumps



Application	Description	Part Number	Retail Price	Core
B20, B1550, B1750, B2150, B5200, B6200, B7200, B8200, B9200	Water Pump	AM15534-73030	\$ 93.01	
B2650, B3000, B3030, B3350	Water Pump Replaces 16326-73030	AM16326-73033	\$ 96.54	
B8200 Gear Drive Engine BSN 373345, Excavator: KH5 Engine BSN 555226	Water Pump w/ Pulley Replaces 15531-73030	AM15552-73030	\$ 92.75	
L47, L3560, L4060, L4701, L4760, L5060, L5460, L6060, M62, M5140, M5640, M5660, MX4800, MX5200, MX5800	Water Pump Replaces 1G928-73030, 1G928-73032, 1G928-73034	AM1G928-73035	\$ 121.11	
L225, L225DT, L245 BSN 14147, L245H	Water Pump w/ Pulley 3/8" Groove	AM15321-73032	\$ 58.00	
L235, L275, L355, L3350, L4350 Replaces 15521-73030, 15521-73033, 15521-73035, 15521-73039	Water Pump Includes Mounting Gasket	AM6653941	\$ 57.50	

Kubota®—Tractor

Application	Description	Part Number	Retail Price	Core
L235, L275, L355, L3350, L4350, L4350DT, KJS130D, KJS130DX, KJS150V, KJS150VX, KJT210V, KJT210VX, Excavators: KX101, KX121-2, KX151, KX161-2, KX161-2S, Generators: SQ1140, SQ1200, SQ3170, SQ3250, Loaders: R420, R520	Water Pump w/ Hub Replaces 15521-73035, 15521-73039	AM15521-73033	\$ 75.00	
L245 ASN 14147, L245DT	Water Pump w/ Pulley	AM15341-73030	\$ 124.04	
L2050, L2250, L2350, L2500, L2550, L2600, L2650, L2800, L2850, L2900, L2950, L3000, L3010, L3130, L3240, L3250, L3300, L3400, L3410, L3430, L3450, L3540, L3600, L3650, L3710, L3830, L3940, L4200, L4240, L4300, L4310, L4400, L4610, L4630, L4740, L4850, L5450, M4030SU, M4700, M4800SU, M4900, M5700, MX5000, MX5000DT, MX5000F, MX5000SU, MX5100, MX5100DT, MX5100HST, Ind: L35	Reman Water Pump w/ Hub Replaces 1A021-73030, 17331-73030, K164127	AM16412-73030	\$ 102.59	\$ 20.00
M4N-071, M5-111, M5L-111, M5N-091, M5N-111, M6-101, M6-111, M95S, M95X, M96S, M105S, M105X, M108X, M6800, M8200, M8540, M8560, M9000, M9540, M9960, M100X, M100GX, M110GX	Water Pump Replaces 1C010-73030	AM1C010-73032	\$ 137.79	
M4950, M4950DT, M5500, M5500DT, M5950, M5950DT, M6030, M6030DT, M6030N, M6950, M7030, M7030DT, M7030SU, M7500, M7500ACL, M7500DT, M7580DT, M8030, M8030DT, M9580DT	Water Pump w/ Hub Replaces 15451-73030	AM15481-73030	\$ 128.00	
M5040, M6040, M6060, M7040, M7060	Water Pump Replaces 1G772-73030, 1G772-73032, 1G772-73034	AM1G772-73035	\$ 191.34	

Belts



Application	Description	Part Number	Retail Price	Core
L200, L210	Fan Belt 0.50" x 5/16" V-Belt	AM07510-00048	\$ 7.00	
L175, L185, L225, L245, L295 BSN 3550, L1500, L1501, L2000	Fan Belt 0.45" x 41.57" Replaces 15221-72530	AM15321-72530	\$ 4.67	
L285, L305, L345, L1802, L2002, L2202, L2402	Fan Belt 0.375" x 41.50"	AM15401-97010	\$ 6.79	
L2500, L2850, L3750, L4150, L4850DT, L5450DT, M4030, M4030SU, M4050, M4500, M4700, M4950S, M5030, M5400, M5700, M5950, M7500ACL, Excavators: KH28, KH170, KH191	Fan Belt 0.50" x 5/16" V-Belt	AM15196-97010	\$ 7.90	
L2600, M4000, Excavator: KH-118	Fan Belt 0.50" x 5/16" V-Belt	AM15601-97010	\$ 7.00	
L4300, L4350, L4400, M110 BSN 50385, M120, M4800SU, M5950, M6950, M7950, M7580, M8580, M9580, MX5000, 4WD: L3350, L4350, Excavators: KH101, KH151, KX91-3S, KX101, KX121-2, KX121-2S, KX151, Loaders: R400, R410, R410B, R510, R510B, R520	Fan Belt 0.50" x 5/16" V-Belt	AM15471-97010	\$ 6.00	
M4050, M4500, M4950	Fan Belt 0.53" x 43.77"	AM15606-97012	\$ 6.00	
M5950, M5950-S, M6030, M6950, M6950-S, M6970, M7030, M7030SU, M7500, M7950, M7950-S, M7970, M8030, M8950, M8950-S, M8970 - w/o Cab	Fan Belt	AM15451-97010	\$ 5.00	
(M5950, M6950, M6950-S, M6970, M7950, M8950, M8950-S, M8970 - w/ Cab), M6030 ASN 80544, M7030 Narrow or 2WD/4WD ASN 80544, M7030SU ASN 80544, M7580, M8030 ASN 80544, M8580, M9580	Fan Belt	AM15451-99380	\$ 7.00	
M110 ASN 50386, M120, M125X, M7580 BSN 60078, M8580 BSN 60094	A/C Compressor Belt 0.50" x 63" V-Belt	AM33740-50890	\$ 6.46	
M7580 BSN 60079	A/C Compressor Belt 0.50" x 62" V-Belt	AM33760-50890	\$ 6.50	
M9000	A/C Compressor Belt 0.50" x 60.80"	AM3A851-79320	\$ 16.00	

Fuel Lift Pumps and Components

Application	Description	Part Number	Retail Price	Core
KH35, KH36, KH41, KH51, KH60, KH61, KH66, KH90, KH91, KH101, KH151, KH191, KX101, KX151, KX41H, KX71, Loaders: R310, R310BH, R400B, R410, R410B, R510, R510, Mowers: B6000, B6000E, G3200, G4200, G4200H, G5200H, G6200H - All w/ Diesel	Fuel Lift Pump Replaces 68371-51210	AM15231-52033	\$ 19.00	
L35TL, L39, L45, L48TL, L2800DHW, L2800DT, L2800F, L2900DT, L2900DTGST, L2900F, L3000DT, L3000F, L3010DT, L3010F, L3010GST, L3010HST, L3130DT, L3130F, L3130GST, L3130HST, L3240DT, L3240F, L3240GST, L3240HST, L3240HSTC, L3300DT, L3300DT-GST, L3300F, L3400DT, L3400F, L3400HST, L3410DT, L3410GST, L3410HST, L3430DT, L3430GST, L3430HST, L3430HSTC, L3540GST, L3540HST, L3540HSTC, L3600DT, L3600DTC/GSTC, L3600GST, L3700SUHSTP, L3710DT, L3710GST, L3710HST, L3710HSTC, L3830DT, L3830F, L3830GST, L3830HST, L3940DT, L3940GST, L3940HST, L3940HSTC, L4200DT-GST, L4200DT-GSTC, L4200DTGHST, L4240DT, L4240GST, L4240HST, L4240HSTC, L4300DT, L4300F, L4310DT, L4310F, L4310GST, L4310GSTC, L4310HST, L4310HSTC, L4330DT, L4330GST, L4330HST, L4330HSTC, L4400DT, L4400DW, L4400FV, L4400FW, L4400H, L4400W, L4610GST, L4610HST, L4610HSTC, L4630DT, L4630GST, L4630HST, L4630HSTC, L4740, L5030GST, L5030HST, L5030HSTC, L5040GST, L5240, L5450DT, L5740, M59, M4700, M4700DT, M4800SU, M4900, M4900C, M4900DT, M4900DTC, M4900S, M4900SC, M4900SCS-F, M4900SD, M4900SDC, M4900SU, M4900SUD, M5400, M5400DT, M5400DT-N, M5700, M5700C, M5700DT, M5700DT-N, M5700DTC, M5700HD-F, M5700HDC, MX4700DT, MX4700F, MX4700HST, MX5000DT, MX5000F, MX5100DT, MX5100F	Fuel Lift Pump Replaces 17121-52031, 1C010-52033	AM17121-52030	\$ 65.00	
M95S, M95X, M96S, M105S, M105X, M5040, M6040, M6800, M7040, M8200, M8540, M9000, M9540	Fuel Pump Replaces 1C010-52032, 1C010-52033, 1C010-52034	AM1C010-52035	\$ 103.21	
M5040, M6040, M7040	Fuel Solenoid Replaces 1G772-60010, 1G772-60012, 1G772-60013	AM1G772-60014	\$ 132.22	
B2410, B2710, B2910	Fuel Shutoff Solenoid Replaces 6A320-31152, 6A320-31150	AM6A320-31153	\$ 72.95	
M95, M95S, M95X, M96S, M105, M105S, M105X, M6800, M8200, M8540, M9000, M9540	Fuel Shut Off Solenoid	AM1C010-60017	\$ 88.64	
L3560, L4060, L4760, L5060, L5460, L6060, M5040, M5140, M5660, M6040, M6060, M7040	Fuel/Water Separator	AM1G311-43350	\$ 109.01	
M95S, M95X, M96S, M100X, M105S, M105X, M108S, M108X, M110X, M4900, M5700, M6800, M8200, M8540, M9000, M9540, MX4800, MX5200, MX5800	Fuel/Water Separator Replaces 16541-43350	AM1G410-43350	\$ 57.48	
(M5140DT, M5140DTC, M5140HD, M5140HDC BSN 051124), M5140F BSN 010084, M5140FC	Fuel/Water Separator	AMRA238-51400	\$ 37.90	

Injectors



Application	Description	Part Number	Retail Price	Core
B1550D, B1550E, B1550HSTE, B1552HSTD, B1750D, B1750E, B1750HSTD, B1750HSTE, B2150D, B2150E, B2150HSE, B7100HSTD, B7100HSTE, F2100-MOWER, L175, L225, L225DT	Fuel Injector Replaces 15271-53002	AM15221-53000	\$ 50.00	
B1700D, B1700E, B1700HSD, B1700HSE, B2100D, B2100E, B2100HSD, B2100HSE, B2400D, B2400E, B2400HSD, B2400HSE, B2410HSD, B2710HSD, B2910HSD, B7500D, B7500DTN, B7500HSD, B7510D, B7510HSD, B7510D, B7510HSD, B7510HSDTR, B7610HSD, B7800HSD, BX22D, BX23D, BX2200D	Fuel Injector Replaces 16032-53902, H1601-53000	AM16032-53900	\$ 78.00	
L2250DT, L2250F, L2250, L2550DTGST, L2550F, L2650DT, L2650DTGST, L2650DTWET, L2650F, L2850DT, L2850DTGST, L2850F, L3250DT, L3350DT, L3450DTGST, L3450DTWET, L3450F, L4150DTN, M4030, M4030DT, M4030SU, M4060SUTF, M5030, M5030DT, M5030SU, M5030SUMDT	Fuel Injector	AM17391-53000	\$ 54.50	



Manifolds and Components

Application	Description	Part Number	Retail Price	Core
L175, L185, L245, L1500, L1500DT	Exhaust Manifold Replaces 15221-12310, 15221-12312, 15221-12313	AM15221-12314	\$ 44.50	
	Exhaust Elbow Replaces 15221-12320, 15221-12323	AM15221-12325	\$ 30.00	
L1802, L2002, L2202, L2402	Exhaust Manifold L02 Series, 3 Cylinder Replaces 15521-12310	AM15521-12312	\$ 54.00	
L225, L235, L245, L275, L295, L305, L2000	Exhaust Manifold Replaces 15321-12313	AM15321-12310	\$ 53.50	
L285, L2600, L3001	Exhaust Manifold Replaces 15401-12310, 15401-12314	AM15401-12316	\$ 61.00	

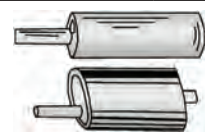

Mufflers and Exhaust

Application	Description	Part Number	Retail Price	Core
Universal Tractors	Exhaust Pipe Black Finish, Straight Pipe 4" ID, Overall Length 47.50"	AM400SP	\$ 59.00	
Universal Tractors	Exhaust Pipe Diameter 3.50", Length 48"	AMS312X48	\$ 57.00	
B21, B1700D, B1700E, B1700HSD, B1700HSE, Ind/Const: B2100D, B2100E, B2100HSD, B2100HSE, B2400D, B2400E, B2400HSD, B2400HSE, B2410HSD, B2410HSDB, B2410HSE, B2710HSD, B2910HSD, B7800HSD	Muffler Horizontal, Length 11" Replaces 6C040-58403, 6C040-58404, 32721-97000	AM32721-97002	\$ 88.00	
B26, B2320DT, B2320DTN-1, B2320DTWO, B2320HSD, B2320HSDN, Ind/Const: B2620HSD, B2630HSD, B2920HSD, B3030HSD, B7500D, B7500DTN, B7500HSD, B7510D, B7510DN, B7510HSD, B7510HSDTR, B7610HSD	Muffler Inlet OD 1.50", Length 110" Replaces 6A320-58404, 6A320-58405, 6A320-58406	AM6A320-58400	\$ 110.00	
B1550, B1750, B5200, B6200, B7200 - 1983- 89 w/ 13HP-20HP Engine	Muffler Vertical Round, Length 20"	AM15751-12010	\$ 76.00	
B3000HSDC, B3000HSDCC, B3030HSDC, B3030HSDCC	Muffler Oval, Length 16.25" Replaces 6C230-58402, 6C230-58403	AM6C230-58404	\$ 121.50	
BX22D, BX23D, BX1800D, BX1830D, BX2200D, BX2660D, BX2670, BX2670-1	Muffler Oval, Length 12.75" Replaces K2551-83110, K2561-83110	AMK2551-83112	\$ 84.00	
BX24D, BX25, BX25DLB, BX25DLB-1, BX2350D, BX2360, BX2370, BX2370-1	Muffler Oval, Length 12.67"	AMK2581-83110	\$ 54.00	
BX2230D	Muffler Round, Length 12.80"	AMK2571-83110	\$ 52.00	
L175, L185, L225, L235, L245, L275, L285, L295, L305, L1500, L1501, L2000, L2350, L2500, L2600, L3000, L3050, L3001 - w/ Vertical Muffler	Muffler Replaces Muffler and Pipe Vertical, Length 36 1/4" Use w/ Original Elbow Replaces 15221-12116, 34219-12410	AMX39109	\$ 75.00	
L175, L185, L225, L245, L295, L305, L1500, L1501, L2350, L2500, L2600, L3000, L3050ST	Muffler Replaces Elbow & Extension Vertical, Length 37" Replaces 15221-12115, 15221-12116	AMX39111	\$ 103.00	

Kubota®—Tractor

Application	Description	Part Number	Retail Price	Core
L175, L185, L225, L1500, L1501, L2000	Muffler Replaces Muffler, Elbow & Pipe Vertical, Length 42.91" Replaces 15221-12110, 15221-12114, 15221-12115, 15221-12116	AMX39110	\$ 79.50	
L185, L235, L275, L285, L295, L305, L345, L2050, L2350	Muffler Vertical Round, Length 20 1/2" Inlet Clamp Extension Pipe, Breakover Use w/ AM15221-12116, Will Not Fit Kubota OEM Muffler 24 1/4" Length, Clamp Not Included Inlet Clamp	AM15221-12116 CL-158 AM34219-12410 CL-200	\$ 45.00 \$ 4.00 \$ 27.00 \$ 4.00	
L2850, L3400DT	Muffler	AM32434-88710	\$ 65.00	
L345, L355SS, L1802, L2002, L2202, L2402, L2602, L3202, L4202	Muffler L02 Series Vertical, Length 34.64" Replaces 15521-12112	AM15521-12110	\$ 99.00	
L2800DT, L2800F, L2800HST, L3400DT, L3400F, L3400HST, L3700SU, L4400DT, L4400F, L4400H	Muffler Oval, Gasket Not Included	AMTC220-16410	\$ 195.00	
L3130DT, L3130F, L3130GST, L3130HST, L3240DT, L3240DT3, L3240F, L3240F3, L3240GST, L3240GST3, L3240HST, L3240HST3, L3240HSTC, L3240HSTC3, L3430DT, L3430GST, L3430HST, L3430HSTC, L3540GST, L3540GST3, L3540HST, L3540HST3, L3540HSTC, L3540HSTC3, L3830DT, L3830F, L3830GST, L3830HST, L3940DT, L3940DT3, L3940GST, L3940GST3, L3940HST, L3940HST3, L3940HSTC, L3940HSTC3, L4240DT, L4240DT3, L4240GST, L4240GST3, L4240HST, L4240HST3, L4240HSTC, L4240HSTC3, L4330DT, L4330GST, L4330HST, L4330HSTC, L4630DT, L4630GST, L4630GSTC, L4630HST	Muffler Oval, Length 19.75" Replaces TD050-16410	AMTD050-16412	\$ 228.00	
M100XDTC, M110XDTC	Muffler, Underhood	AM3T200-12110	\$ 341.50	
M5040DT, M5040DT1, M5040F, M5040F1, M5040HD, M5040HD1, M6040DT, M6040DT1, M6040F, M6040F1, M6040HD, M6040HD1, M6040HDNB, M7040DT, M7040DT1, M7040F, M7040F1, M7040HD, M7040HD1, M7040HDNB, M7040SU, M7040SUD BSN 54787	Muffler Round, Length 22.50"	AM3C001-12310	\$ 518.50	
M5040DT, M5040DT1, M5040F, M5040F1, M5040HD, M5040HD1, M6040DT, M6040DT1, M6040F, M6040F1, M6040HD, M6040HD1, M7040DT, M7040DT1, M7040F, M7040F1, M7040HD, M7040HD1	Muffler Round, Length 13.50" Replaces 3C011-12110	AM3C011-12113	\$ 341.50	
M5040DTC, M5040DTC1, M5040FC, M5040FC1, M5040HDC, M5040HDC1, M6040DTC, M6040DTC1, M6040FC, M6040FC1, M6040HDC, M6040HDC1, M7040DTC, M7040DTC1, M7040FC, M7040FC1, M7040HDC, M7040HDC1, M7040HDCLTD BSN 54787	Muffler Round, Length 13.60" Replaces 3C501-12110	AM3C501-12112	\$ 273.50	
M6040DTC, M6040DTC1, M6040FC, M6040FC1, M6040HDC, M6040HDC1, M7040DTC, M7040DTC1, M7040FC, M7040FC1, M7040HDC, M7040HDC1	Muffler Oval, Inlet OD 2" Replaces 3C754-12110	AM3C552-12110	\$ 210.00	
M6800, M6800DT, M6800HD, M6800S, M6800SDT	Muffler Replaces 3A112-12110	AM3A111-12115	\$ 495.00	

Kubota®—Tractor

Application	Description	Part Number	Retail Price	Core
M6800HDC, M6800SC, M6800SDTC	Muffler Replaces 3A652-12110	AM3A651-12112	\$ 275.00	
M6950, M7950 - 1983-87, 66 HP through 76 HP	Muffler Vertical Round, Length 34"	AM15621-12110	\$ 207.00	
MX4700DT, MX4700F, MX4700H, MX5000DT, MX5000F, MX5000SU	Muffler Oval, Length 25.25"	AMTC050-16410	\$ 256.50	



Starters

Application	Description	Part Number	Retail Price	Core
B20, B1500HSTD, B1550D, B1550E, B1550HSTE, B1750D, B1750E, B1750HSTD, B1750HSTE, B4200D, B7100HSTD, B7100HSTE, B7200HSTD, B7200HSTE, Mowers: F2000, F2100, G1700, G1800, G1800S, G1900, G1900S, G2000, G3200, G4200, G6200H	Starter, 12 Volt Mitsubishi, Direct Drive, 9 Tooth, 0.80kW 2-Ear Mount on Drive End Housing	AM15231-63015	\$ 127.50	
B21	Starter, 12 Volt Denso, Direct Drive, 9 Tooth, 1.00kW, CW Rotation Replaces 6A100-31150	AM6A100-31154	\$ 222.50	
B26, B2630HSD, B2710HSD, B2910HSD, B3000HSDC, B3000HSDCC, B3030HSD, B3030HSDC, B3030HSDCC, B3200HSD, B3200HSDWO, B3300SUHSD, B7800HSD	Starter, 12 Volt Mitsubishi, Direct Drive, 8 Tooth, CW Rotation Replaces 6C070-59211, 6C070-59212	AM6C070-59210	\$ 140.00	
B1700D, B1700E, B2100D, B2100E, B2320DT, B2320DTN, B2320DTWO, B2320HSD, B2320HSDN, B2400D, B2400E, B2410HSD, B2410HSDB, B2410HSE, B2620HSD, B2920HSD, B7500D, B7500DTN, B7500HSD, B7510D, B7510DN, B7510HSD, B7510HSDTR, B7610HSD	Starter, 12 Volt Mitsubishi, Permanent Magnet Gear Reduction, 8 Tooth, 0.90kW 2-Ear Mount Replaces 6C140-59210, 6C140-59211, 6C140-59212	AM6C140-59213	\$ 172.50	
BX22D, BX2200D, RTV900G, RTV900G6, RTV900R, RTV900R6, RTV900RSD, RTV900RSDL, RTV900S, RTV900T, RTV900T2, RTV900T5H, RTV900T6, RTV900W, RTV900W6, RTV900W6SE, RTV1100, RTV1100CR, RTV1100CW	Starter, 12 Volt Denso, Gear Reduction, 9 Tooth, 1.40kW 2-Ear Mount on Drive End Housing Replaces 16235-63010, K7561-61810, K7561-61811, K7711-61800, K7711-98600	AMK7571-96800	\$ 120.00	
Utility: BX1500D, Mowers: F2260, F2560, F2560E, F3060, G2160, G2160AU, G2160DS, GR2100, GR2110, GR2120, GR2120B, TG1860, ZD18, ZD18F, ZD21, ZD21F, ZD25, ZD28, ZD221, ZD321, ZD321N, ZD323, ZD326	Starter, 12 Volt Denso Style, Planetary Gear Reduction, 9 Tooth, 1.00kW 2-Ear Mount on Drive End Housing Replaces 1G023-63011, 1G069-63010, 1G069-63011, 67980-31150, 67980-31151, K3511-81410	AM1G023-63010	\$ 161.50	
KJ7210V, KJS150V, KJS150VX, KJT210V, KJT210VX, KJT270F, KJT270FSW, KJT270FXSW, L285, L295, L2250, L2550, L2850, L3250, L3450, L3600, L3650, L3710, L4200, L4300, L4310, L4610, Generators: GV1125Q60KTC, GV3170SW, GV3190Q60, GV3240, GV3250Q60SW, GV312060B, Excavators: KH28L, KH66HKCL, KH91H, KH101, KH151, KH170L, KH191, KX101, KX151, Loaders: R410, R410B, R420, R420S	Starter, 12 Volt Denso, Gear Reduction, 9 Tooth, 1.40kW 2-Ear Mount on Drive End Housing	AM17341-63010	\$ 130.00	
KJS130D, KJS130DX, L35, L2500DT, L2500F, L2650DT, L2650DTGST, L2650DTWET, L2650F, L2800DT, L2800F, L2900DT, L2900DTGST, L2900F, L2950DT, L2950DTGST, L2950DTWET, L2950F, L3010DT, L3010DTGST, L3010DTHST, L3010F, L3130DT, L3130DTGST, L3130DTHST, L3130F, L3200DT, L3200F, L3200H, L3240DT, L3240DT3, L3240DTGST, L3240F, L3240F3, L3240GST3, L3240HST, L3240HST3, L3300DT, L3300DTGST, L3300F, L3400DT, L3400DTHST, L3400F, L3410DT, L3410GST, L3410HST, L3430DT	Starter, 12 Volt Denso, Gear Reduction, 9 Tooth, 1.20kW 2-Ear Mount	AM34070-16800	\$ 105.00	

Kubota®—Tractor

Application	Description	Part Number	Retail Price	Core
L39, L45, L3200H, L3400DT, L3400F, L3400HST, L3540GST, L3540HST, L3700SU, L3800DT, L3800F, L3800H, L3830DT, L3830F, L3830GST, L3830HST, L3940DT, L3940GST, L3940HST, L4240DT, L4240GST, L4240HST, L4240HSTC, L4330DT, L4330GST, L4330HST, L4400DT, L4400F, L4400H, L4600DT, L4600F, L4630DT, L4630GST, L4630HST	Starter, 12 Volt Denso, Gear Reduction, 8 Tooth, 1.40kW	AMT1150-16800	\$ 218.50	
L48, L3430, L4330DT, L4740, L4740GST, L4740GST-3, L4740HST-3, L4740HSTC, L5030, L5030GST, L5030HST, L5040, L5040GST, L5040GST-3, L5240, L5240HST, L5240HST-3, L5740, L5740HST, L5740HST-3, M59, MX4700DT, MX4700F, MX4700H, MX5000, MX5000DT, MX5000F, MX5000SU, MX5100DT, MX5100F, MX5100H, Excavators: KX121-3, KX121-3S, KX121-3ST, KX161, KX161-3, KX161-3S, KX161-3ST, U45S, U45ST	Starter, 12 Volt Denso, Gear Reduction, 9 Tooth, 2.00kW 2-Ear Mount	AM17123-63016	\$ 210.50	
L175F, L185, L185DT, L185F	Starter, 12 Volt 9 Tooth, CW Rotation Replaces 15221-63014, 15221-63015, 70000-65214, 70000-65421, 70000-73450	AM15221-63010	\$ 283.50	
L2600DT, L2600F, L3000DT, L3000F	Starter Replaces T1060-16801, T1060-16804	AMT1060-16800	\$ 171.00	
L3350DT, L3750, L3750DT, L4150, L4150DT, L4150DTN, L4350DT, L4850DT, L5450DT, M4030, M4030DT, M4030SU, M4030SUTF, M4500, M4700, M4700DT, M4800SUDF, M4800SUF, M4900, M4900DT, M4900SU, M4900SUDT, M4950DTS, M4950S, M5030, M5030DT, M5030SU, M5030SUDT, M5030SUMDT, M5400, M5400DT, M5400DTN, M5700, M5700DT, M5700DTN	Starter, 12 Volt Denso, Gear Reduction, 11 Tooth, 1.40kW 2-Ear Mount on Drive End Housing Replaces 15601-63012, 70000-65440	AM15621-63012	\$ 108.00	
M55DT, M5500, M5950, M5950DT, M5950DTS, M5950S, M6030, M6030DT, M6030DTN, M6030DTNB, M6030T, M7030, M7030DT, M7030DTNB, M7030N, M7030SU, M7030SUDT, M7500, M8030, M8030DT	Starter, 12 Volt Denso, Gear Reduction, 9 Tooth, 2.50kW 3-Ear Mount	AM15451-63014	\$ 274.50	
M100XDT, M105, M105S, M105SDS, M105SDSF, M105SDSL, M105SDT, M105SH, M105SHD, M105XDTC, M108, M108DSC, M108DSC2, M108HDC2, M108SDS, M108SDS2, M108SDSF, M108SDSL, M108SDSL2, M108SDSL2S, M108SDSLS, M108SH, M108SHD, M108SHDC, M108XDTC, M110XDTC, M6040, M6800, M6800DT, M6800HD, M6800S, M6800SDT, M6800SDT, M7040, M7040DT, M7040DTC, M8200, M8200DT, M8200DTN, M8200HD, M8200SDTN, M8200SDTN, M8540DT, M8540DT1, M8540F, M8540F1, M8540HD, M8540HD1, M8540HD12, M8540HD121, M9000, M9000DT, M9000DTL	Starter, 12 Volt Mitsubishi, Planetary Gear Reduction w/ Open Drive End, 9 Tooth, 2.50kW 2-Ear Mount Replaces 1C010-63010, 1C010-62011, 1C010-63012, 1G010-63010, 1G772-63011	AM1G772-63012	\$ 165.00	
M6950, M6950DT, M6950DTS, M6950S, M6970DT, M7950, M7950DT, M7950DTS, M7950H, M7950S, M7950W, M7970DT, M8950, M8950DT, M8950DTS, M8950S, M8950SDT, M9550	Starter, 12 Volt Denso, Gear Reduction, 9 Tooth, 2.50kW 3-Ear Mount Replaces 70000-65460, 70000-73540	AM15481-63010	\$ 411.00	
L2501, L2600, L2800, L3000, L3200, L3400, L3700, L3800, L4300, L4400, L4600, MX4700, MX5000, MX5100	Ignition Switch Replaces TC020-31820	AMTC020-31822	\$ 48.76	
M5-091, M5-111, M5L-111, M5N-091, M5N-111, M95S, M96S, M105S, M108S, M4900, M5040, M5140, M5640, M5660, M5700, M6040, M6060, M6800, M7040, M7060, M8200, M8540, M8560, M9000, M9540, M9960	Ignition Switch Replaces 52200-41210	AM52200-41212	\$ 47.37	

Kubota®—Tractor



Alternators

Application	Description	Part Number	Retail Price	Core
B21, B26, B1550, B1750, B2100, B2150, B2400, B2410, B2630, B2710, B2910, B3030, B3200, B3300, B7311, B7324, B7500, B7510, B7610, BX22D, BX23D, BX1800D, BX1830D, BX2200D, BX2230D, FZ2100, Mowers: F2260, F2400, F2560, F3060, Excavators: KX412, KX612, KX71, KX912, Loader: R310	Alternator Denso Type, 12 Volt, 40 Amps, I/R, w/ 2-ear mount, B+ post on rear of CE Uses IG (Ignition) spade, L (Ign/Lamp) spade T-shaped single plug connector Replaces 16241-64010	AM16241-64012	\$ 99.00	
B1550, B1750, B2100, B2150, B2400, B2410, B2630, B2710, B2910, B3030, B3700, B5200, B6200, B7200, B7410, B7510, B7610, B7800, B8200, BX1500D, BX1800, BX1830, BX2200, BX2230, BX22D, BX23D, Utility Vehicles: RTV500, RTV500A, RTV500RA, Mowers: F2000, F2100, G1800, G1900, G2000, G3200, G4200H, G5200, G6200, GF1800, GR2110, ZD18, ZD21, ZD25, ZD28, ZD321, ZD323, ZD326P, ZD331LP, Excavators: K008, KH007, KH35, KH41, KH61	Alternator Dynamo Replacement, 12 Volt, 14 Amps, E/R, Permanent Magnet Dynamo Replaces 15531-54013, 15531-64016, 15531-64017, 6C040-59252, EG673-64010	AM15531-64017	\$ 113.00	
B6200, B6200D, B6200E, BB7200, BB7200D, BB7200E, B9200, B9200HSDTOW, L175, L185, L200, L225, L225DT, L235, L245, L285, L295, L305, L335, L335SS, L345, L355, L2250, L2550, L2850, L3250, L3350, L3750, L4150, L4350, L4850, L5450, M4030, M4950, M5030, M5500, M5950, M6030, M6950, M6970, M6970DT, M7030, M7500, M7950, M7970, M8030, M8950, M8970, M8970DT, Loaders: R400B, R410, R410B, Generators: GV1125Q60KTC, GV312060B, GV3170SW, GV3190Q60, GV3240, GV3250Q60SW, Excavators: KH101, KH151, KH191, KH90H, KX101, KX151	Alternator Denso Type, 12 Volt, 40 Amps, E/R, w/ 3-ear mount, Features B+ post and (1) three-wire single plug connector w/ E (ground), F (+ from reg), and N (AC) spades Replaces 15321-64012, 15411-64011, 15471-64010, 15471-64011, 15606- 64010, 15606-64011, 15763-64010	AM15253-64010	\$ 139.00	
L35, L39, L48, L2600, L2800, L2900, L3000, L3010, L3130, L3240, L3300, L3400, L3410, L3430, L3540, L3600, L3700, L3710, L3830, L3940, L4200, L4300, L4310, L4330, L4610, L4630, M4700, M4800, M4900, M5400, M5640, M5700, MX5000, Excavators: KX121-2, KX161-2, KX612	Alternator Denso Type, 12 Volt, 45 Amps, IR/IF, w/ 2-Ear Mount, B+ post on rear of CE Uses IG (Ignition) spade, L (Ign/Lamp) spade T-shaped single plug connector Replaces 34070-75600, T1060-15680, T1060-15681, T1060-15682	AM34070-75602	\$ 141.50	
L39, L3940, L4240, L4300, L4330, L4400, L4630, M4700, M4800SU, M4900, M5400, M5700, MX5000, MX5100	Alternator Denso Type, 12 Volt, 40 Amps, I/R, w/ 12 o'clock Plug Position Replaces Nippondenso 101211-1180, 101211-1360, 9761219-136	AM3A011-74013	\$ 139.18	
L175, L185, L225, L235, L245, L275, L285, L295, L305, L345, L355, L2050, L2350, M4000, M4030, M4050, M4500, M4950, M7000, Loaders: R400, R410, Generators: GV3190QSW, GV3240SW, GV3250QSW Replaces 5321-64010, 15321-64011, 15321-64012, 15411-64010, 15411-64011, 15471-64010, 15471-64011, 15606-64010, 15606-64011	Alternator Denso Type, 12 Volt, 25 Amps, E/R	AM15411-64010	\$ 77.00	
L2650DT, L2650F, L2950DT, L2950F, L3450DT, L3450F, L3650DT, L3650F, L4350DT, L4850DT, L4850DT, L5450DT, Loaders: R510, R510LST, R510B, R520	Alternator 12 Volt, 45 Amps Replaces 16705-64012, 16705-64010	AM17356-64010	\$ 165.00	
M95S, M105S, M105SDT, M5040, M5040DTC, M5040DTC1, M5040FC, M5040FC1, M5040HDC, M5040HDC1, M5140DTC, M5140FC, M5140HDC, M6040, M6040DTC, M6040DTC1, M6040FC, M6040FC1, M6040HDC, M6040HDC1, M6800, M6800HD, M6800HDC, M6800S, M6800SDT, M7040, M7040DTC, M7040DTC1, M7040FC, M7040FC1, M7040HDC, M7040HDC1, M8200, M8200DT, M8200HD, M8200SDTNQ, M8540, M9000, M9000DT, M9000DTM, M9000HD, M9540	Alternator Mitsubishi Unit, 12 Volt, 60 Amps, I/R Replaces 3A651-74010, 3A651-74011, 3C581-74010, 3C581-74011	AM3C581-74012	\$ 178.00	

Kubota®—Tractor

Application	Description	Part Number	Retail Price	Core
M105S, M105SDT, M5040, M5040DTC, M5040DTC1, M5040FC, M5040FC1, M5040HDC, M5040HDC1, M5140DTC, M5140FC, M5140HDC, M6040, M6040DTC, M6040DTC1, M6040FC, M6040FC1, M6040HDC, M6040HDC1, M6800, M6800HD, M6800HDC, M6800S, M6800SDT, M7040, M7040DTC, M7040DTC1, M7040FC, M7040FC1, M7040HDC, M7040HDC1, M8200, M8200DT, M8200HD, M8200SDTNQ, M8540, M9000, M9000DT, M9000DTM, M9000HD, M9540	Alternator Replaces 3C081-74013	AM3C081-74012	\$ 128.50	
M5500DT, M5950, M5950DT, M5950DTS, M5950S, M6030, M6030DT, M6030DTN, M6030DTNB, M6950, M6950DT, M6950DTS, M6950S, M6970DT, M7030, M7030DT, M7030DTNB, M7030N, M7030SU, M7030SUDT, M7500, M7500ACL, M7500DT, M7500DTACL, M7950, M7950DT, M7950DTS, M7950H, M7950S, M7970DT, M8030, M8030DT, M8950, M8950DT, M8950DTS, M8950S, M8970DT	Alternator 12 Volt, 53 Amps On some M series tractors lower dynamo support may need to be modified from 2 5/8" to 2 7/8" since SRE housing has been superseded through ND	AM15451-64010	\$ 140.00	
M6030, M6030DT, M6030DTN, M6030DTNB, M7030, M7030DT, M7030DTNB, M7030N, M7030SU, M7030SUDT, M7580, M7580DT, M8030, M8030DT, M8580, M8580DT, M9580, M9580DT	Alternator Replaces 16541-64010, 16541-64011, 16541-64012	AM35583-74012	\$ 125.00	
M6060, M7060, M8560, M9960	Alternator Mitsubishi Unit, 12 Volt, 100 Amps, IR/IF, CW	AM1J431-64012	\$ 204.50	
M6800, M6800DT, M6800S, M6800SDT, M8200, M8200DT, M9000, M9000DT	Alternator Replaces 1C010-64010	AM1C010-64012	\$ 148.00	
M7580, M8580, M9580	Reman Alternator 12 Volt, 60 Amps, ND/IR/IF Replaces 16540-64010	AM33990-74010	\$ 475.37	\$ 50.00
Utility Vehicles: B3000HSDC, B3000HSDCC, B3030HSDC, B3030HSDCC, RTV1140CPX, RTV1140CPXR, RTV900G, RTV900G6, RTV900R, RTV900R6, RTV900RSD, RTV900SDL, RTV900S, RTV900T, RTV900T2, RTV900T5H, RTV900T6, RTV900W, RTV900W6, RTV900W6SE	Alternator Denso Type, 12 Volt, 55 Amps Replaces 7561-61910, 7561-61911, A-80161, 101211-8770, AND0350, 7561-61912, 101211-8771	AMK7561-61910	\$ 140.00	
B5200, B6200, B7200, B8200, B9200	Voltage Regulator Replaces 15533-64600, 76611-55440	AMH1550-64600	\$ 102.00	
B6200, B7200, B8200, B9200, L185, L235, L245, L275, L295, L345, L2050, L2250, L2350, L2550, L2850, L3250, L3350, L4850, L5450, M4050, M4500, M4950, M5030, M5950, M6030, M6950, M7030, M7500, M7950, M8030, M8950 Replaces 33251-74010	Voltage Regulator 12 Volt - 14.30 volt setting, B-circuit, Single multi-spade (6) connector w/ pins: I - N - F - E - L - B, +IG female bullet pigtail Solid State unit to replace original mechanical unit	AM70000-65398	\$ 27.50	
B20, B1550D, B1550E, B1750D, B1750E, B4200D, B5200D, B5200E, B6200D, B6200E, B7200D, B7200E, B8200DP, B8200EP, F2000, F2100, F2100E, G1700, G1800, G1900	Solenoid Replaces 14278-63021, 14278-63022, 15231-63022	AM70000-65425	\$ 23.50	

Mechanical Front Wheel Drive Parts

MFWD Differentials and Components

Application	Description	Part Number	Retail Price	Core
L35, L39, L45, L47, L48, L2050, L2250, L2350, L2500, L2501, L2550, L2600, L2650, L2800, L2850, L2900, L2950, L3000, L3010, L3130, L3200, L3240, L3250, L3300, L3301, L3400, L3410, L3430, L3450, L3540, L3560, L3600, L3650, L3700, L3710, L3800, L3830, L3901, L3940, L4060, L4200, L4240, L4300, L4310, L4330, L4400, L4600, L4610, L4630, L4701, L4740, L4760, L5030, L5040, L5060, L5240, L5460, L5740, L6060, M4700, M4800SU, M4900, M4900SU, M5400, M5700, M8200, MX4700, MX4800, MX5000, MX5100, MX5200, MX5800	Differential Pinion Gear	AM31353-43343	\$ 36.44	
L35, L2050, L2250, L2350, L2500, L2501, L2550, L2600, L2650, L2800, L2850, L2900, L2950, L3000, L3010, L3130, L3200, L3240, L3250, L3300, L3301, L3400, L3410, L3430, L3450, L3540, L3560, L3600, L3650, L3700, L3710, L3800, L3830, L3901, L3940, L4060, L4200, L4240, L4300, L4310, L4400, L4600, L4701, M9000	Front Differential Side Gear	AM31353-43353	\$ 44.94	
M5-091, M5-111, M5L-111, M8540, M8560, M9540, M9960	Front Differential Bevel Gear Shaft 17 Tooth	AM3C091-42260	\$ 218.87	
M5-091, M5-111, M5L-111, M8540, M8560, M9540, M9960	Front Differential Bevel Gear 23 Tooth	AM3C091-42310	\$ 129.58	
L35, L2501, L2800, L2900, L3010, L3200, L3300, L3301, L3400, L3410, L3600, L3700, L3710, L3800, L3901, L4200, L4300, L4310	Front Axle Bevel Gear 42 Tooth	AM34070-13210	\$ 247.90	
L39, L3940, L4060, L4600	Front Axle Bevel Gear 11 Tooth	AM32781-13200	\$ 86.70	
L5040, L5060, L5240, L5460, L5740, L6060, M4800SU, M4900, M4900SU, M5640, M5700, M8200, MX4800, MX5200, MX5800	Front Axle Bevel Gear 9 Tooth	AM3G700-43520	\$ 160.59	
M5-091, M5-111, M5L-111, M8540, M8560, M9540, M9960	Front Axle Bevel Gear 15 Tooth	AM3C091-43520	\$ 123.87	
M5-091, M5-111, M5L-111, M8540, M8560, M9540, M9960	Front Axle Bevel Gear 41 Tooth	AM3C091-43720	\$ 223.21	
M4800SU, M4900, M4900SU, M5400, M5640, M5700, M8200, MX4700, MX4800, MX5100, MX5200, MX5800	Bevel Gear Set, Differential 8 & 21 Tooth	AM3C315-42300	\$ 313.83	
M4D-061, M4D-071, M4N-071, M5N-091, M5N-111, M62, M5660, M6040, M6060, M7040, M7060, M8540	Bevel Gear Set, Differential 10 & 23 Tooth	AM3C051-42300	\$ 466.84	
4WD: M4D-061, M4D-071, M5N-091, M5N-111, M59, M62, M5040, M5140, M5660, M6040, M6060, M7040, M7060, M8540	Front Axle Flange Assembly	AM3C011-43710	\$ 337.61	

Kubota®—Tractor





Mechanical Front Wheel Drive Parts

Application	Description	Part Number	Retail Price	Core
M5-091, M5-111, M5L-111, M8540, M8560, M9540, M9960	Front Axle Flange Assembly	AM3C091-43712	\$ 301.07	
M5-091, M5-111, M5L-111, M8540, M8560, M9540, M9960	Front Axle Shaft	AM3C091-43410	\$ 32.01	
M4D-061, M4D-071, M4N-071, M5N-091, M5N-111, M59, M62, M126X, M5040, M5140, M5660, M6040, M6060, M7040, M7060, M8540	Front Axle Bushing	AM52200-22280	\$ 16.92	
M4D-061, M4D-071, M4N-071, M5-091, M5-111, M5L-111, M5N-091, M5N-111, M59, M62, M5040, M5140, M5660, M6040, M6060, M7040, M7060, M8540, M8560, M9540, M9960	Front Axle Bushing	AM5J042-14170	\$ 24.62	
M8540, M8560, M9540, M9960	Front Propeller Shaft Replaces 3C091-41320	AM3C091-41322	\$ 82.18	
M4N-071, M5-091, M5-111, M5L-111, M5N-091, M5N-111, M8540, M8560, M9000, M9540, M9960	Propeller Shaft Bushing	AM3A181-41310	\$ 23.84	

MFWD Hubs and Housing



Application	Description	Part Number	Retail Price	Core
L45, L47, L48, L4240, L4330, L4610, L4630, L4740, L5030, L5040, L5240, L5740, M4700, M4800SU, M4900, M4900SU, M5400, M5640, M5700, M8200, MX4700, MX5000, MX5100 - 4WD	Bushing For Front Axle Trunnion, Upper	AM3A021-43370	\$ 12.97	
M5-091, M5-111, M5L-111, M8540, M8560, M9540, M9960	Pivot Bushing, Rear	AM3C091-41680	\$ 29.14	
M4D-061, M4N-071, M5N-091, M5N-111, M6-141, M59, M62, M135GX, M135X, M5040, M5140, M5660, M6040, M6060, M7040, M7060, M8540	Pivot Pin Bushing, Rear	AM3C011-41680	\$ 36.44	

Tie Rods and Components

Application	Description	Part Number	Retail Price	Core
 B1550, B1750, B4200D, B5200, B6100HST-E, B6200, B7100, B7200	Tie Rod 3.00" Long M12x1.25" Right Hand Thread	AM67121-56530	\$ 15.00	
 B1550, B1750, B4200D, B5200, B6100HST-E, B6200, B7100, B7200	Tie Rod 2.87" Long M12x1.50" Left Hand Thread	AM67121-56520	\$ 14.00	
 B1700, B2100, B2400, B2410, B2710, B2910, B7300, B7800	Tie Rod 3.00" Long Right Hand, M12x1.25" Thread	AM67950-56530	\$ 20.00	
 B1700, B2100, B2400, B2410, B2710, B2910, B7300, B7800	Tie Rod 2.87" Long Left Hand, M12x1.50" Thread	AM67950-56520	\$ 20.00	

Prices Subject to Change without Prior Notice. The use of original equipment manufacturer (OEM) part numbers or trademarks, e.g. Case® and John Deere®, are for reference purposes only and for indicating product use and compatibility. Our company and the listed replacement parts contained herein are not sponsored, approved or manufactured by the OEM. All parts are New unless designated Reman in the description.

Kubota®—Tractor

Application	Description	Part Number	Retail Price	Core
 B1700, B2100, B2400, B2410, B8200, B9200, L185, L210, L235, L245, L260, L275, L295, L2050, L2250, L2350, L2500, L2600, L3000, Ind: B20, B21	Tie Rod End, Left Hand Left Hand, M16x1.50" Male Thread 3.50" Length to Center of Ball Replaces 38440-44880	AM38440-44790	\$ 22.00	
 F2000, F2100E, F2400, L185F, L225, L2000	Tie Rod End 2.75" Long, 0.495" ID 0.45" to 0.482" Taper, 0.352" Taper Length Female Right Hand Thread Replaces 34150-12600, 34150-12603	AM38180-12600	\$ 27.50	
 L175, L185, L225, L1500, L1501, L1801, L2000, L2201	Tie Rod End 2.75" Long, 0.495" ID 0.45" to 0.482" Taper, 0.352" Taper Length Female Left Hand Thread Replaces 34150-12700, 34150-12703, 38180-12702, 38180-12703	AM38180-12700	\$ 27.50	
 L185, L2600	Tie Rod End 3.875" Long, 0.622" OD 0.516" to 0.576" Taper, 0.90" Taper Length Male Right Hand Thread Replaces 34208-12412, 34220-12412	AM34208-12410	\$ 22.00	
 L185F, L210, L245F, L245H, L285, L295F, L2050, L2250, L2350F, L2500, L2550, L2600, L2650DT, L2850F, L2900F, L2950, L3000, L3010F, L3130F, L3250F, L3300F, L3450, L3650F, L3830F, L4200F, L4300F, L4310F, MX5000F	Tie Rod End 3.875" Long, 0.622" OD 0.516" to 0.576" Taper, 0.90" Taper Length Male Right Hand Thread Replaces 32150-12600, 32150-12601, 32150-12602, 34160-12600, 34670-44780, 38440-44870	AM38440-44780	\$ 25.00	
 L2650DT BSN 50145, (L2950DT, L3450DT BSN 50198), L3650DT BSN 50212 - w/ MFWD	Tie Rod Assembly, Left Hand	AM32430-44612	\$ 95.00	
 L295, M4000, M4050, M4500, M7500	Tie Rod, Inner 3.40" Long Right Hand, M20x1.00" Thread	AM36200-62932	\$ 18.00	
 M5-091, M5-111, M5L-111, M126X, M135X, M8540, M8560, M9540, M996	Tie Rod End	AM3C091-62920	\$ 98.18	
 M105X, M110, M955, M1055, M9000	Tie Rod 9.44" Long, 1.08" Diameter Right Hand, M20x1.50" Thread	AM3A161-62920	\$ 45.00	
M4700, M4800, M4900, M5400, M5640, M5700 - w/ MFWD	Tie Rod End	AM3A022-62920	\$ 89.82	
M5040, M5140, M6040, M6060, M7040, M7060 - w/ MFWD	Tie Rod Assembly Includes Ball Joint	AM3C011-62970	\$ 253.89	
M5040, M6040, M7040	Tie Rod	AM3C011-62920	\$ 136.97	
M8540, M8560, M9540, M9960	Tie Rod Assembly For Front 4WD Steering Cylinder	AM3C091-62970	\$ 191.91	

Spindles

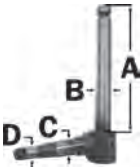
Application	Description	Part Number	Retail Price	Core
 L175, L185F, L225, L2000, L2201	Spindle w/ Nut Forged, 7 1/2" Replaces 34510-11110, 34510-11114, 34510-11115 A - 7.50 B - 0.9843 C - 0.9843 D - 0.7874	Right or Left Hand AM34209-11110	\$ 74.00	

Kubota®—Tractor

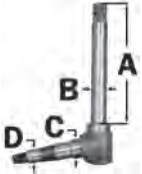
Application	Description	Part Number	Retail Price	Core	
	L175, L185F, L225, L235, L245, L285, L2000, L2050, L2050F, L2200, L2201, L2250, L2350, L2500, L2500F, L2600, L2600F, L3000, L3000F	Spindle w/ Nut 8 1/2" Replaces 34200-11110, 34200-11113, 34269-1112, 34269-1113 A - 10.9375 B - 1.1811 C - 1.1811 D - 0.9843	Right or Left Hand	AM34269-11110	\$ 95.00
	L175, L185, L210, L225, L235, L245F, L245H, L275, L285, L295F, L305F, L345, B1700, B2100, B2150, B2400, B2410, B8200, B9200HST-EP, L2000, L2201, L2600	Spindle Seal 1.8504" OD, 0.98425" ID	AM34150-11280	\$ 9.00	

Wheel Hubs and Components



Application	Description	Part Number	Retail Price	Core
L175, L225, L1500, L1501, L1801, L1802, L2000, L2201	Front Wheel Hub, 2WD 52 mm OD, 4 Lug Replaces 34150-11312	AM34150-11310	\$ 38.50	
L245F, L245H, L285D, L285WP, L295F, L2002, L2202, L2600, L2601, L3001	Front Wheel Hub, 2WD 62 mm OD, 6 Lug, 2 3/4" High Replaces 34260-11311, 34260-11312	AM34260-11310	\$ 63.00	
B1150, B1700, B1750, B2100, B2150, B2400, B2410, B5100, B6100, B6200, B7100, B7200, B8200, B9200HST-EP, F2100E, L175, L185F, L225, L1500, L1501, L1801, L2000, L2201	Front Wheel Hub 52" x 31 mm Replaces 34260-11150, 34150-11152	AM34150-11150	\$ 4.50	
L185DT, L235DT, L245DT, L275DT, L1802DT, L2050DT, L2402DT, L2500DT, L2550DT, L2600DT, L2650DT, L2950DT, L3000DT	Front Hub Seal 58" x 37 mm	AM37650-43670	\$ 17.00	
L185DT, L235DT, L245DT, L275DT, L1802DT, L2050DT, L2402DT, L2500DT, L2550DT, L2600DT, L2650DT, L2950DT, L3000DT	Front Hub Seal 70" x 36 mm	AM37720-43690	\$ 13.50	
L235, L245, L275, L285P, L285WP, L295F, L305F, L345, L2002, L2050F, L2202, L2250F, L2350F, L2402, L2550F, L2600F, L2601, L2650, L2850F, L2900F, L3000F, L3001, L3010F, L3250F, L3300F, L3650F, L4200F, L4300F, L4310F, MX5000F	Front Hub Seal 75" x 47 mm	AM37300-11160	\$ 11.50	
L260P, L285, L2200, L2600	Front Hub Seal 62" x 37 mm Replaces 32240-11151	AM32240-11150	\$ 10.00	
B1550, B1700, B1750, B2100, B2400, B2410, B4200, B5100, B5200, B6100, B6200, B7100, B7200, B7300, B7400, B7410, B7500, B7510, B7610	Rear Wheel Hub Assembly Replaces 67401-17450, 67401-17453	AMH6640-17300	\$ 137.00	

Steering Arms



Application	Description	Part Number	Retail Price	Core
L235, L245, L275, L285, L2600	Steering Arm, Right Hand Replaces 34260-11211	AM34260-11210	\$ 74.00	
	Steering Arm, Left Hand Replaces 34220-11221	AM34220-11220	\$ 95.00	
L225, L245, L2000, L2201	Steering Arm, Left Hand	AM34150-11215	\$ 62.50	
L2002, L2202, L2402	Steering Arm, Left Hand	AM34260-11220	\$ 74.00	

Prices Subject to Change without Prior Notice. The use of original equipment manufacturer (OEM) part numbers or trademarks, e.g. Case® and John Deere®, are for reference purposes only and for indicating product use and compatibility. Our company and the listed replacement parts contained herein are not sponsored, approved or manufactured by the OEM. All parts are New unless designated Reman in the description.

Kubota®—Tractor

Drawbars

Application	Description	Part Number	Retail Price	Core
L2050, L2250, L2350, L2550, L2650, L2850, L2900, L2950, L3250, L3600, L3650, L4200, L4350	Drawbar 2" x 1.25" x 23.50" Replaces SW07328	AM35070-29710	\$ 94.00	
M95S, M95X, M96S, M100GX, M100X, M105S, M105X, M108S, M108X, M110, M110GX, M110X, M120	Drawbar 3" x 1.50 x 41.38"	AM3F440-89120	\$ 215.84	
M5400	Drawbar	AM3A011-89120	\$ 90.00	
M6950, M6950S, M7950, M7950S	Drawbar 2.50" x 1.25" x 26.62" Replaces 36330-89120	AM36530-89120	\$ 128.00	



Hydraulic Pumps and Components







Application	Description	Part Number	Retail Price	Core
L175, L185, L185F, L245, L245DT, L245F, L1245H, L225, L295, L295DT, L295F, L1500, L1501, L2000, L2201, Engines: DH1101, D1301, Z750, Z751, Z851	Hydraulic Pump Keyed Shaft, 4-Bolt Mount Replaces 34150-36100, 34150-36102, 34150-36103, 34150-36110, 35110-76101, 35180-36100, 37150-36100, 37150-36110	AM35110-76100	\$ 463.16	
L235, L275	Hydraulic Pump Splined Shaft	AM38240-76100	\$ 225.00	
L275, L1801, L2002, L2050F, L2202, L2350F, L2402, L2500F	Hydraulic Pump Tanged Shaft, 4-Bolt Mount, Replaces 2-Bolt Pump Replaces 38180-36100, 38180-76120	AM38180-76100	\$ 592.00	
L2501, L2800, L3130, L3200, L3240, L3301, L3400, L3430, L3540, L3560, L3700, L3830, L3940, L4300, L4400	Hydraulic Pump Replaces T1150-36403, T1150-36407, T1150-36409	AMT1150-36440	\$ 675.00	
M4N-071, M5-091, M5-111, M5L-111, M5N-091, M5N-111, M7060, M8540, M8560, M9540, M9960	Hydraulic Pump Replaces 3C081-82200, 3C081-82202, 3C081-82203	AM3C081-82204	\$ 913.01	
M4700, M5400, M6800, M8200, M9000	Hydraulic Pump Replaces 3A111-82200	AM3A111-82202	\$ 886.40	
M5040, M5140, M5660, M6040, M6060, M7040, M7060, M8540	Hydraulic Pump	AM3C001-82204	\$ 1253.14	
M95SDS(SDTC)(SH), M96S, M100XDTC, M105S(SDTC), M108S(X)(XDTC), M110XDTC, M126XDTC, M135XDTC, M4900(DT)(DTC), M5040DT(DTC), M5040F(FC), M5040HD(HDC), M5640SU(SUD), M5700(HDC), M6040DT(DTC)(F)(FC), M6040HD(HDNB), M6800(DT)(HD)(HDC), M6800S(SC)(SDT)(SDTC), M7040DT(DTC), M7040F(FC), M7040HD(HDNB)(SU), M8200DTN(HDC)(DTN)(SDTNC), M8540DTC(FC), M8540HD(HDNB), M9000C(DT)(DTC)(DTC), M9000DTL(DTM)(DTMC)(HDC), M9540DT(DTC), M9540F(FC)(HD)	Hydraulic Coupler, Rigid Can be mounted directly to a valve or rigid tubing, 1/2" body size, 7/8" 14-UNF-2B thread, 3000 PSI rating	AM3A111-82011	\$ 108.00	
M5040, M6040, M7040, M8540, M9540	Auxiliary Control Lever Cable	AM3C085-82970	\$ 73.82	

Transmission Components

Application	Description	Part Number	Retail Price	Core
L175, L1500	Mainshaft 24, 17, 22 & 13 Tooth 10 Spline, 15" Long 4-Speed Transmissions	AM34150-21510	\$ 225.00	
L4600DT, L4600F, L4701DT, L4701F	Mainshaft Replaces TC432-22102	AMTC432-22103	\$ 384.50	



Kubota®—Tractor

Application	Description	Part Number	Retail Price	Core
L2900, L3010, L3300, L3410, L3600, L3710, L4200, L4300, L4310, L4400, L4610, MX5000	Mainshaft Gear 27 Tooth	AMTA040-22110	\$ 64.10	
 L175, L1500	Reverse Gear, 28T Replaces 34150-23130, 34150-23133	AM34159-23100	\$ 96.50	
 L225, L2000	Reverse Gear, 28T Replaces 34200-23134	AM34209-23100	\$ 101.50	
 L285, L2600	Reverse Gear, 20T Replaces 34260-23132, 34260-23133	AM34260-23130	\$ 84.00	
 L185, L225, L295, L305, L345, L2050, L2201, L2350, L2500, L2600, L3000	Reverse Fork, 2 Gear Replaces 35305-23530, 37150-23530, 37150-23534	AM35305-23532	\$ 78.50	
 L225, L2000	Reverse Fork, 2 Gear Replaces 34200-23532	AM34200-23530	\$ 104.50	
 L2202, L2402	Reverse Fork, 2 Gear	AM38240-23535	\$ 62.50	
L4300, L4400, MX4700, MX4800, MX5000, MX5100, MX5200	Countershaft Gear 34 Tooth Replaces TC030-22230, TC030-22233	AMTC030-22232	\$ 89.55	
M5040, M5140, M6040, M7040, M8540, M9540	Main Gear Shift Cable	AM3C081-29770	\$ 49.73	
M8540, M9540	Parking Brake Cable	AM3C081-29814	\$ 52.42	
M4800SU, M4900, M4900SU, M5040, M5140, M5640, M5660, M5700, M6040, M6060, M6800, M7040, M7060, M8200, M8540, M9540	Transmission Dipstick	AM3A211-21510	\$ 11.75	

PTO Shafts

Application	Description	Part Number	Retail Price	Core
L235, L275, L2002, L2202, L2250F, L2402, L2550DT, L2550F, L2250ST	PTO Shaft 24 Spline, 14 1/4" Replaces 38240-25310	AM38240-25313	\$ 189.00	
L285, L2600	PTO Shaft 24 Spline, 25 13/16" Replaces 34260-25314, 34260-25315	AM34260-25310	\$ 289.50	
L3301DT, L3301F	PTO Shaft	AMTC422-25314	\$ 183.44	
M4D-061, M4D-071, M5660, M6060, M7060	PTO Drive Shaft	AM3A484-79133	\$ 299.87	
M5660, M6800, M7040	PTO Drive Shaft 12 Tooth	AM3A111-79130	\$ 174.20	

PTO Adapters

Application	Description	Part Number	Retail Price	Core
Tractors up to 70HP	PTO Adapter Small 540 to 1000 Spline, 4 1/8" Overall Length Changes PTO from 1 3/8" x 6 spline to 1 3/8" x 21 spline and extends the PTO shaft 4 1/8"	AMX59112	\$ 40.00	
Tractors up to 70HP	PTO Adapter Small 1000 to 540 Spline, 6 3/8" Overall Length Reduces PTO from 1 3/8" x 21 spline to 1 3/8" x 6 spline and extends the PTO shaft 4 1/8"	AMX59108	\$ 40.00	
Tractors up to 100HP	PTO Adapter Large 1000 to 540 Spline, 7 1/2" Overall Length Reduces PTO from 1 3/4" x 20 spline to 1 3/8" x 6 spline and extends the PTO shaft 4 5/8"	AMX59109	\$ 70.00	
Tractors up to 100HP	PTO Adapter Large 1000 to Small 1000 Spline, 7" Overall Length Changes PTO from 1 3/4" x 20 Spline to 1 3/8" x 21 Spline and extends the PTO shaft 4 5/8"	AMX59110	\$ 70.00	

Rear Axles Components

Application	Description	Part Number	Retail Price	Core
L2050, L2350, L2500, L2501, L2600, L2800, L3000, L3200, L3400, L3700, L3800	Rear Axle Gear 53 Tooth	AM31331-26832	\$ 167.49	
L4600DT, L4600F, L4600H, L4701DT, L4701F, L4701H	Rear Axle Gear 60 Tooth	AMTC432-26830	\$ 512.34	
M4D-061, M4D-071, M59, M62, M5040, M5140, M5660, M6040, M6060, M7040, M7060, M8540	Rear Axle Differential Gear Shaft	AM3C011-43410	\$ 54.61	
M4800SU, M4900, M4900SU, M5640, M5660, M5700, M6800, M7040, M8200	Rear Axle Differential Planetary Gear 65 Tooth	AM3A111-48320	\$ 141.27	
M4800SU, M4900, M4900SU, M5640, M5660, M5700, M6800, M7040, M8200	Brake Shaft, Left Hand 13 Tooth Replaces 3A111-48470	AM3A211-48470	\$ 182.05	
	Brake Shaft, Right Hand 13 Tooth Replaces 3A211-48460	AM3A111-48460	\$ 163.87	



Power Steering Cylinders and Components

Application	Description	Part Number	Retail Price	Core
M4030, M4950-S, M5030, M5950-S, M6030, M6800, M6950-S, M7030, M7030SU, M8030, M8200	Power Steering Cylinder End 7" Long, 1.08" OD M20x1.50" Right Hand Thread	AM35533-62920	\$ 68.00	
M4700, M4800SU, M4900, M4900SU, M5400, M5700, M6800	Power Steering Cylinder End 3.39" Long Right Hand, M20x1.50" Thread	AM3A011-62922	\$ 47.00	
M4700, M5400	Power Steering Cylinder End 3.156" Long Right Hand, M20x1.50" Thread	AM3A012-62920	\$ 29.00	

Steering Gearbox Assembly



Application	Description	Part Number	Retail Price	Core
L175, L185, L245	Steering Gearbox Assembly Replaces 35240-16100, 34159-16091	AMH3520-99100	\$ 516.50	



Steering Shafts

Application	Description	Part Number	Retail Price	Core
L1500DT, L1501, L175, L1801, L185DT, L185F, L2000, L2201DT, L2250DT, L225DT, L245DT, L245F	Steering Shaft Assembly 4WD, Keyway 23 5/8" Overall Length 1 13/16" x 1 1/2" Ball Nut Replaces 34150-16201, 794130-15500	AM34150-16200	\$ 147.00	
L285, L2600	Steering Shaft Assembly 23 3/4" Overall Length 2" x 1 9/16" Ball Nut Replaces 34260-16201	AM34260-16200	\$ 158.50	
B4200, B5100, B6000, B6100, B7100D	Steering Shaft 18 5/8" Overall Length Replaces 66811-41200, H6680-91200, H6680-91202	AMH6680-41202	\$ 129.00	

Steering Components

Application	Description	Part Number	Retail Price	Core
 L150, L175, L185DT, L185F, L225, L225DT, L245DT, L245F, L245H, L2000, L2202	Steering Bearing Replaces 34150-16221	AM34150-16220	\$ 17.50	
 B8200DP, B8200EP, L2500DT, L2500F, L2600F	Steering Sector Shaft 15/16" to 1" Taper, 5 Tooth, 36 Splines	AM38180-16120	\$ 158.50	
 L210, L260P, L285, L285P, L285WP, L295DT, L295F, L345, L345DT, L2600	Steering Bearing	AM32200-16221	\$ 15.00	
M5040, M5140, M6040, M7040, M7060, M8540, M9540	Steering Joint Assembly	AM3C081-63360	\$ 94.92	

Steering Wheels and Caps

Application	Description	Part Number	Retail Price	Core
B2400, B5100, B6000, B6100, B7100, B8200, L185, L235, L245, L275, L305, L345, L355, L2050	Steering Wheel 15 3/4" Diameter, 18 Spline Hub, 3 1/2" Shaft Replaces 66611-41400, SBA334300050, SBA334310110	AM32400-16800	\$ 64.00	

Lift Link Assemblies and Components

Application	Description	Part Number	Retail Price	Core
M5-091HD, M5-091HD-1, M5-091HD12, M5-091HD12-1, M5-091HDC, M5-091HDC-1, M5-091HDC12, M5-091HDC12-1, M5-091HF, M5-091HF-1, M5-091HFC, M5-091HFC-1, M5-111HD, M5-111HD12, M5-111HDC, M5-111HDC12, M5-111HDC24, M5-111HF, M5-111HFC, M5L-111, M8560HD, M8560HD12, M8560HDC, M8560HDC12, M8560HF, M8560HFC, M9540HDC-LTD, M9540HDC24-1, M9960HD, M9960HD12, M9960HDC, M9960HDC12, M9960HDL, M9960HDLSN, M9960HF, M9960HFC, (M8540DT, M8540DT-1, M8540DTC, M8540DTC-1 ASN 053334), (M8540F, M8540F-1, M8540FC, M8540FC-1 ASN 10405), (M8540HD, M8540HD-1, M8540HD12, M8540HD12-1, M8540HDC, M8540HDC-1, M8540HDC12, M8540HDC12-1 ASN 53335), (M9540F, M9540F-1, M9540FC, M9540FC-1, M9540HFL, M9540HFL-1, M9540HFL-1S ASN 10613), (M9540DT, M9540DT-1, M9540DTC, M9540DTC-1, M9540HD, M9540HD-1, M9540HD12, M9540HD12-1, M9540HDC, M9540HDC-1, M9540HDC12, M9540HDC12-1, M9540HDL, M9540HDL-1, M9540HDL-1S ASN 57792)	Lift Link Assembly, Left Hand	AM3C081-91450	\$ 175.00	
M5040, M5140, M6040, M6060, M7040, M7060	Lift Link Assembly, Right Hand Lift Link Assembly, Left Hand	AM3C001-91232 AM3C001-91452	\$ 218.10 \$ 189.30	
M8540 ASN 053334, M9540	Leveling Box Assembly, Right Hand	AM3C08191230	\$ 75.00	
L4600, L4701	Lift Link, Left Hand	AMTC432-71540	\$ 113.73	



Quick Hitches









Application	Description	Part Number	Retail Price	Core
Cat II	Quick Hitch, 4" x 6" Beam 36" Wide, Includes 1 1/8" Mounting Pins and Adapter Bushings	AMX741020	\$ 565.00	
Cat III	Quick Hitch, 4" x 6" Beam 38" Wide, Includes 1 7/16" Mounting Pins	AMX741022	\$ 565.00	
Cat III	Quick Hitch, 4" x 6" Beam 44" Wide, Includes 1 7/16" Mounting Pins	AMX741021	\$ 565.00	

Top Link Assemblies

Application	Description	Part Number	Retail Price	Core
M5-091, M5-111, M5L-111, M8540, M8560, M9540, M9960	Toplink Assembly Replaces 3C081-91700	AM3C081-91702	\$ 236.42	
M5040, M6040, M6060, M7040, M7060, M8540	Toplink Assembly	AM3C001-91700	\$ 243.28	







Kubota®—Tractor

Lighting

	Application	Description	Part Number	Retail Price	Core
	Universal Equipment	LED Floodlight All-Position Light 4.25" x 4.25" Square Light 2650 Lumens, 48 Watts, 4 Amps For 12 Volt to 24 Volt Systems Includes Mounting Bracket and Stainless Steel Hardware	AMTL105F	\$ 95.00	
	Universal Equipment	LED Floodlight All-Position Light 6.25" x 1.75" Rectangle Light 1300 Lumens, 18 Watts, 1.50 Amps For 12 Volt to 24 Volt Systems Includes Mounting Bracket and Stainless Steel Hardware	AMTL118F	\$ 50.00	
	Universal Equipment	LED Floodlight All-Position Light 5" Round Light 3200 Lumens, 40 Watts, 3.30 Amps For 12 Volt to 24 Volt Systems Includes Mounting Bracket and Stainless Steel Hardware	AMTL180	\$ 89.00	
	Universal Equipment	LED Floodlight All-Position Light Round Light 6900 Lumens, 50 Watts, 4.10 Amps For 9 Volt to 32 Volt Systems Includes Mounting Bracket and Stainless Steel Hardware	AMTL500F	\$ 120.00	
		LED Floodlight All-Position Light 4.30" Round Light 5040 Lumens, 50 Watts, 4.10 Amps For 12 Volt to 24 Volt Systems Includes Stainless Steel Adjustable Mounting Bracket	AMAT305931	\$ 96.00	
	Universal Equipment	LED Floodlight All-Position Light 4.25" Round Light 2650 Lumens, 42 Watts, 3.50 Amps For 12 Volt to 24 Volt Systems Includes Mounting Bracket and Stainless Steel Hardware	AMTL115F	\$ 59.00	
	Universal Equipment	LED Wide Floodlight All-Position Light 5" x 7" Rectangle Light 3800 Lumens, 35 Watts For 12 Volt to 24 Volt Systems	AMX34171	\$ 60.00	
	Universal Equipment	LED Floodlight, Sealed Beam Fender Mount 4.50" Diameter Round Light 1250 Lumens, 18 Watts, 1.50 Amps Trapezoid Pattern For 12 Volt to 24 Volt Systems	AMTL3010	\$ 40.00	
		LED Floodlight Fender Mount 4.50" Diameter Sealed Beam Round Light 1250 Lumens, 18 Watts, 1.20 Amps Trapezoid Pattern For 12 Volt to 24 Volt Systems Lasts 50 times longer than halogen lighting, vibration resistant w/ no filament failures, uses original mount and wiring, Operating temperature of -40°F to 140°F / -40°C to 60°C	AMRE336111	\$ 35.00	
	Universal Equipment	LED Floodlight Fender Mount 4.50" Diameter Sealed Beam Round Light 1440 Lumens, 18 Watts, 1.60 Amps Lasts 50 times longer than halogen lighting, vibration resistant w/ no filament failures, 2-terminal connection, Operating temperature of -40°F to 140°F / -40°C to 60°C	AMRE336112	\$ 67.75	

Prices Subject to Change without Prior Notice. The use of original equipment manufacturer (OEM) part numbers or trademarks, e.g. Case® and John Deere®, are for reference purposes only and for indicating product use and compatibility. Our company and the listed replacement parts contained herein are not sponsored, approved or manufactured by the OEM. All parts are New unless designated Reman in the description.

Kubota®—Tractor



	Application	Description	Part Number	Retail Price	Core
	Universal Equipment	LED Floodlight Cab and Fender Mount 3.50" x 6" Rectangle Light 3600 Lumens, 40 Watts, 3 Amps	AMX34146	\$ 65.00	
	Universal Equipment	LED Spotlight All-Position Light 4.25" x 4.25" Square Light 1400 Lumens, 27 Watts, 2.20 Amps For 12 Volt to 24 Volt Systems	AMTL100S	\$ 45.00	
	Universal Equipment	LED Spotlight All-Position Light 6.25" x 1.75" Rectangle Light 1300 Lumens, 18 Watts, 1.50 Amps For 12 Volt to 24 Volt Systems Includes Mounting Bracket and Stainless Steel Hardware	AMTL118S	\$ 50.00	
	Universal Equipment	LED Spotlight All-Position Light Round Light 6900 Lumens, 50 Watts, 4.10 Amps For 9 Volt to 32 Volt Systems Includes Mounting Bracket and Stainless Steel Hardware	AMTL500S	\$ 120.00	
	Universal Equipment	LED Trapezoid Light Cab and Fender Mount 4.50" Diameter Round Light 2800 Lumens, 40 Watts, 3.30 Amps Trapezoid Pattern For 12 Volt to 24 Volt Systems Bottom Mount w/ Built-In Heat Sink Includes Mounting Bracket, Long and Short Rubber Bezels and Stainless Steel Hardware	AMTL2080	\$ 95.00	
		LED Trapezoid Light Cab and Rear Fender Mount 4.50" Diameter Round Light 2800 Lumens, 40 Watts, 3.30 Amps Trapezoid Pattern For 12 Volt to 24 Volt Systems Bottom Mount w/ Built-In Heat Sink Includes Mounting Bracket, Long and Short Rubber Bezels and Stainless Steel Hardware	AMX33121	\$ 76.00	
	Universal Equipment	LED Warning Light Cab, Header or Swather Mount Can be used for Turn Signal, Brake or Running Lights 4.125" Diameter Round Light Double Sided, Amber Lenses 25 Bulbs per Side For 12 Volt to 24 Volt Systems	AMTLFL2	\$ 55.00	
		LED Warning Light Cab, Header or Swather Mount Can be used for Turn Signal, Brake or Running Lights 4.125" Diameter Round Light Double Sided, Amber Lenses 25 Bulbs per Side For 12 Volt to 24 Volt Systems	AMX1910149	\$ 44.00	

Kubota®—Tractor

	Application	Description	Part Number	Retail Price	Core
	Universal Equipment	LED Warning Light Cab, Header or Swather Mount Can be used for Turn Signal, Brake or Running Lights 4.125" Diameter Round Light Double Sided, Red and Amber Lenses 25 Bulbs per Side For 12 Volt to 24 Volt Systems	AMTLFL3	\$ 55.00	
		LED Warning Light Cab, Header or Swather Mount Can be used for Turn Signal, Brake or Running Lights 4.125" Diameter Round Light Double Sided, Red and Amber Lenses 25 Bulbs per Side For 12 Volt to 24 Volt Systems	AMX33126	\$ 44.00	
	Universal Equipment	LED Magnetic Warning Light All-Position Light 360° Flashing Light, Multiple Patterns 9.50" x 6.75" Rectangle Light Magnetic Base or Solid Mount For 12 Volt to 24 Volt Systems Includes Cigarette Lighter Adapter, Wiring and Switch	AMTL1100	\$ 170.00	
	Universal Equipment	LED Magnetic Warning Light All-Position Light 360° Flashing Light, Multiple Patterns 14" x 6.75" Rectangle Light Magnetic Base or Solid Mount For 12 Volt to 24 Volt Systems Includes Cigarette Lighter Adapter, Wiring and Switch	AMTL1200	\$ 190.00	
	Universal Equipment	Warning Beacon 360° Flashing Beacon, Amber Lens For 0.9435" Diameter Pipe Replaces 84337818, AZ44705, AZ101891	AM82018390	\$ 45.64	
	Universal Equipment	LED Warning Beacon 360° Flashing Beacon 2.75" x 5.25" Light Polycarbonate Amber Lens and Housing For 12 Volt to 24 Volt Systems Includes Solid Mounting Pad and Stainless Steel Hardware	AMTL2100	\$ 30.00	
	Universal Equipment	LED Warning Beacon 360° Flashing Beacon, 3 Different Patterns 5" x 10" Light Amber Lens, 48 Watts, 4 Amps For 12 Volt to 24 Volt Systems Brackets Sold Separately	AMX33131	\$ 75.00	
	Universal Equipment	Warning Beacon Bracket	AMX33132	\$ 15.00	
	Universal Equipment	Warning Beacon Bracket	AMX33133	\$ 15.00	
	Universal Equipment	Warning Beacon Bracket	AMX33137	\$ 15.00	

Kubota®—Tractor

Kubota®—Tractor











Application	Description	Part Number	Retail Price	Core	
 Universal Equipment	Warning Beacon Bracket	AMX33135	\$ 15.00		
	<hr/>				
 Universal Equipment	LED Light Bar 4" Long, 1260 Lumens, Cree Bulbs	AMLED4	\$ 45.00		
	LED Light Bar Flood/Spotlight Combo 10" Long, 5700 Lumens, 50 Watts, 4.20 Amps For 12 Volt to 24 Volt Systems Includes Mounting Bracket and Stainless Steel Hardware	AMTL10SRC	\$ 129.00		
	LED Light Bar Floodlight/Spotlight Combo 14" Long, 5400 Lumens, 72 Watts, 6 Amps Die Cast Aluminum Housing, Polycarbonate Lens For 12 Volt to 24 Volt Systems Includes Mounting Bracket and Heavy Duty Stainless Hardware	AMTLB410C	\$ 150.00		
	LED Light Bar Floodlight/Spotlight Combo 30" Long, 13600 Lumens, 150 Watts, 12.50 Amps For 12 Volt to 24 Volt Systems Includes Mounting Bracket and Stainless Steel Hardware	AMTL30SRC	\$ 230.00		
	LED Light Bar 30" Long, 13860 Lumens, Cree Bulbs	AMLED30	\$ 130.00		
	LED Light Bar Floodlight/Spotlight Combo 40" Long, 17300 Lumens, 200 Watts, 16.70 Amps For 12 Volt to 24 Volt Systems Includes Mounting Brackets and Stainless Steel Hardware	AMTL40SRC	\$ 300.00		
	LED Light Bar 40" Long, 18200 Lumens, Cree Bulbs	AMLED40	\$ 160.00		
	LED Light Bar Floodlight/Spotlight Combo 42" Long, 14500 Lumens, 240 Watts, 19 Amps For 12 Volt to 24 Volt Systems Includes Mounting Bracket and Stainless Steel Hardware Replaces 1163691	AMTLB440C	\$ 250.00		
	LED Light Bar, Curved 50" Long, 21500 Lumens, Cree Bulbs	AMLED50C	\$ 190.00		
	<hr/>				
	 Universal Equipment	LED Magnetic Work Light All-Position Light 3.25" Square Floodlight 900 Lumens Magnetic Base Includes Lithium Ion Battery, Cigarette Lighter and DC Charger	AMTL2460	\$ 79.00	

Glass

Application	Description	Part Number	Retail Price	Core
(M95SDT, M105SDT - w/ Cab), 2WD: (M105S, M4900, M5700, M6800S, M8200, M9000 - w/ Cab), 4WD: (M105SDT, M5700DT, M6800SDT, M95SDT - Dual Traction w/ Cab), (M4900DT, M8200DT, M9000DT, M9000DTMC Muddler - w/ Cab), (M5700HDC, M6800HDC, M8200HDC, M9000HDC - Hydraulic Shuttle Tractors w/ Cab)	Lower Front Glass, Left Hand	AM3G710-70560	\$ 75.00	

Kubota®—Tractor

Air Conditioning Parts and Components













Application	Description	Part Number	Retail Price
 M6950, M7950, M8950	Compressor Conversion Kit Denso Style to Seltec Style Includes Compressor, Mounting Bracket, Service Valves, O-Rings, Belt and Mounting Hardware, Replaces Upright Style Denso Compressor See Manufacturer for Oil Type and Quantity	AMX10247	\$ 525.00
	Premium Synthetic Ester Oil, 100V, 12 oz	AMX10273	\$ 11.00
 B3030, L3240, L3430, L3540, L3940, L4240, L4330, L4630, L4740, L5030, L5240, L5740, M95S, M105S, M105X, M110, M120, M125X, M4900, M5700, M6800, M8200, M9000	Compressor, Denso SCSA06C Style 12 Volt, w/ Single Groove Clutch, 4.80" Clutch Diameter, Direct Mount Requires Synthetic Ester Oil 100V, 2.50 oz (74 cc) Replaces 6A671-97110, 6A671-97114	AMX10235	\$ 490.00
	Premium Synthetic Ester Oil, 100V, 12 oz	AMX10273	\$ 11.00
 L3600, L3710, L3940, L4200, L4240, L4310, L4610, L4630, L4740, L5740, M900, M4900, M6800, M9000 BSN 10913	Compressor, Denso 10PO8E Style 12 Volt, w/ Single Groove Clutch, 4.80" (122 mm) Clutch Diameter, 0.50" Belt Width, 3-Ear Mount, Must use Original Manifold Requires Pag Oil ND8, 4.50 oz (133 cc)	AMT0070-87290	\$ 775.00
	Denso ND8 Pag Oil, 46V, 8.50 oz	AMX10272	\$ 30.00
 M4N-071HDC12, M6-131DTC, M6-141DTC, M6-141DTC, M7-131P, M7-131P KVT, M7-131PB, M7-151P, M7-151P KVT, M7-151PB, M7-151PB KVT, M7-151S, M7-171P, M7-171P KVT, M7-171PB, M7-171PB KVT, M7-171S, M126GXDTSC, M126XDTC, M126XDTPC, M135GXDTSC, M135XDTC, M135XDTPC	Reman Compressor, SV07E 12 Volt w/ 6-Groove Clutch for Serpentine Belt, Coil Mounted at 10 o'clock Position 4.25" (112.80 mm) Clutch Diameter Requires Pag Oil ND8, 46V Replaces 3P999-00620, 447280-3080	AM447280-3050	\$ 625.00
 M108S, M5040, M6040, M7040, M8540 Replaces 3C581-50060	Compressor, Denso SVO7E Style 12 Volt, w/ Single Groove Clutch, 4.37" (111 mm) Clutch Diameter Distance from Top Ear to Center of Groove: 2.48" (63 mm) Coil Mounted at 10 o'clock Position, ND-Oil 8	AM3C581-97590	\$ 540.00
 M110 ASN 50386, M120 BSN 50839, M900, M4900, M6800 BSN 65762, M9000 SN 10914-11322	Compressor, Nippondenso SCS06 Style 12 Volt, w/ Single Groove Clutch, 4.80" (122 mm) Clutch Diameter, 0.50" Belt Width, Direct Mount, 3 oz Oil QTY ND-Oil 8	AMT1065-72213	\$ 590.00
 M110 BSN 50386, M120, M7580, M8580, M9580	Compressor, Denso 10PA15C Style 12 Volt, w/ Single Groove Clutch, Must use Original Manifold Distance Between Mounting Holes: Top=3.58" (91.08 mm); Bottom=3.08" (78.47 mm) Requires Pag Oil ND8, See Manufacturer for Oil Quantity	AM33770-50050	\$ 375.00
	Denso ND8 Pag Oil, 46V, 8.50 oz	AMX10272	\$ 30.00
 B3030, M120 ASN 50840, M4900, M5040, M5700 ASN 11018, M6040 BSN 52299, M6800, M9000 ASN 11431, RTV1100	Compressor Clutch SCSA06C Clutch, 4.80" Coil w/ 1/2" Single Groove, Splined-Type Shaft	AM6A671-97310	\$ 170.00
 M108S, M5040, M6040, M7040, M8540	Reman Compressor Clutch SV07E Clutch w/ 12 Volt Coil, Single Groove For Aftermarket AM3C581-97590 Compressor	AM3C581-96110	\$ 200.00
 M120 BSN 50839, M5700 SN 10658-11017, M9000 SN 10914-11322	Compressor Clutch SCS06 Clutch, 4.80" 12 Volt Coil w/ 1/2" Single Groove, Splined-Type Shaft Complete w/ Coil, Hub and Pulley	AMT1065-87310	\$ 170.00
 M9000 BSN 10913	Compressor Clutch 10POE Clutch, 4.78" 12 Volt Coil w/ 1/2" Single Groove, Key-Type Hub Complete w/ Coil, Hub and Pulley	AMT0070-87310	\$ 165.00

Prices Subject to Change without Prior Notice. The use of original equipment manufacturer (OEM) part numbers or trademarks, e.g. Case® and John Deere®, are for reference purposes only and for indicating product use and compatibility. Our company and the listed replacement parts contained herein are not sponsored, approved or manufactured by the OEM. All parts are New unless designated Reman in the description.

Kubota®—Tractor



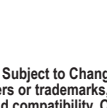

	Application	Description	Part Number	Retail Price
	M9000 SN 10913-11430	Nippondenso Compressor Clutch 4.80" Coil w/ 1/2" Single Groove	AM6A671-97210	\$ 255.00
	Universal Equipment	High Pressure Switch Normally Open, Opens at 305 PSI, Closes at 395 PSI, 7/16"x20 Thread	AMX10276	\$ 35.00
	Universal Equipment	Low Pressure Switch Normally Open, Opens at 6 PSI, Closes at 45 PSI, Standard 7/16"x20 Thread	AMX10277	\$ 55.00
	Universal Equipment	Low Pressure Switch Normally Open, Opens at 35 PSI, Closes at 46 PSI, Standard 7/16"x20 Thread	AMX10278	\$ 42.00
	B3030, L3240, L5740, M108S BSN 70282, M120 ASN 70657, M125X, M135X, M4900, M5700 ASN 10953, M6800, RTV1100 BSN 14540	Low Pressure Switch, Normally Open Opens at 29 PSI, Closes at 35 PSI, 11 mm Metric Thread, M11x100 Thread - Male	AM3A761-96290	\$ 32.00
	M108S ASN 70283, M120 BSN 70656, M5700 BSN 10952, M7580, RTV ASN 14541	Low Pressure Switch, Normally Open Opens at 30 PSI, Closes at 34 PSI, 11 mm Metric Thread, M11x100 Thread - Male	AM33770-96290	\$ 37.00
	B3030, L4630	Receiver Drier Metric Threads	AMT2055-72230	\$ 31.00
	B3030, KX121, KX121-3, KX161-3, L3240, L3430, L3600, L3710, L4200, L4310, L4330, L4610, L4630, L5030, L5240, L5740, M95S, M105S, M108S, M108X, M110, M120, M4900, M4900C, M5040, M5700, M6040, M6800, M7040, M7580, M8200, M8540, M8580, M9000, M9540, M9580, RTV1100 Replaces T0070-79270	Komatsu Receiver Drier XH9 Desiccant	AMX10239	\$ 40.00
	M5950, M6950, M7950	Receiver Drier 2 .64" x 9" Male O-Ring w/ Female Switch Port, Inlet - 14 mm, Outlet - 14 mm, Metric, R134a Compatible	AM70000-67458	\$ 31.00
	B3030, L3430, L3710, L4310, L4330, L4610, L4630, L4900C, L5030, M4900, M5700, M6800, M8200, M9000	Expansion Valve Internally Equalized w/ Capillary Tube, Metric	AMT1065-72170	\$ 23.00
	L3600, L4200	Expansion Valve	AMT0070-94120	\$ 30.00
	M120, M125X, M135X, M5700, M9580	Expansion Valve Internally Equalized, Metric	AM33770-96120	\$ 38.00

Kubota®—Tractor

	Application	Description	Part Number	Retail Price
	M108S, M1055, M4900, M5040, M6040, M6800, M7040, M8540, M9000, RTV1100	Expansion Valve Block Type	AM3A851-72170	\$ 35.00
	M5950, M6950	Expansion Valve Internally Equalized w/ 13.50" Capillary Tube, Metric	AM70000-67459	\$ 20.00
	B3030, L3240, M5700 BSN 11017, M6800 BSN 65762, M90000 ASN 10914	Blower Motor CW Rotation, 12 Volt, 2-Wire (Spade), Single 1/4" Shaft, Single Speed, 5 3/4" x 6 3/4" Overall Dimensions	AM3G910-72150	\$ 625.00
	290, 530, L3430, L3600, L4200	Blower Motor	AMT0070-94130	\$ 545.00
	L3430, L3710 ASN 71651, L4310 ASN 71290, L4610 ASN 71389, L5030	Blower Motor CW Rotation, 12 Volt, 2-Wire, Single 1/4" Shaft, Single Speed, 5 1/4" x 2 3/8" Overall Dimensions	AMT1065-72150	\$ 655.00
	L3710 BSN 71651, L4310 BSN 71289, L4610 BSN 72388	Blower Motor CW Rotation, 12 Volt, 2-Wire, Single 1/4" Shaft, Single Speed, 5" x 6 3/4" Overall Dimensions	AMT0270-72150	\$ 725.00
	M108S, M5700 ASN 11018, RTV1100, M6800 ASN 65763, M9000 ASN 11323	Blower Motor CCW Rotation, 12 Volt, 2-Wire, 5/16" Shaft Size, 2 15/16" Motor Diameter, 2 3/4" Wheel Length, 6 1/2" Wheel Diameter, 5 1/2" Overall Length	AM3A851-72150	\$ 160.00
	M110, M120	Blower Motor w/ Wheel CW Rotation, 12 Volt	AM3F760-57020	\$ 560.00
	M110, M120	Blower Motor w/ Wheel CCW Rotation, 12 Volt	AM3F760-57030	\$ 255.00
	M4900, M9000 BSN 10913	Blower Motor	AM3G710-72150	\$ 595.00
	M5950, M6950, M7580	Blower Motor CW Rotation, 12 Volt, 2-Wire, Single Speed, 5/16" Shaft	AM70000-73355	\$ 305.00
	B3030, B5030, L4630, L5030	Condenser Core: 11 5/8" x 14" x 5/8" 13 Fins per Inch	AMT2055-72220	\$ 125.00
	M108S, M5700 ASN 10658, M6800 ASN 65763, M8200, M9000	Condenser 14 1/4" x 13 1/2" x 7/8" Core Dimensions, 13 Fins per inch	AM3A851-50040	\$ 385.00
	M110, M120, M7580 ASN 60313, M8580, M9580	Condenser 17 1/2" x 12 1/4" x 1 3/4" Core Dimensions, 12 Fins per inch	AM33770-50042	\$ 700.00

Kubota®—Tractor

Kubota®—Tractor

Application	Description	Part Number	Retail Price
 M5040, M6040, M7040, M8540, M9540	Condenser 16" x 13 1/2" x 7/8" Core Dimensions, 13 Fins per inch	AM3C581-50040	\$ 450.00
 M5950, M6950, M7950, M8950, M8580	Condenser Core: 15 3/4" x 12 1/4" x 1 5/8" 10 Fins per inch Replaces 36919-50040	AM36919-50044	\$ 415.00
 L3600, L4200	Evaporator	AMT0070-94110	\$ 410.00
 L3710, L4310, L4610, L5030, M1055, M4900, M5700 BSN 10657, M6800 BSN 65762, M9000 BSN 58436	Evaporator Overall: 18" x 7 1/2" x 3 1/8" Core: 14" x 3 1/8" x 4 1/16"	AMT0270-87340	\$ 340.00
 M105, M105S, M108S, M4900, M5700 ASN 10658, M6800 ASN 65763, M9000 ASN 58437, RTV1100	Evaporator Core: 7 3/8" x 2 1/4" x 8 3/4"	AM3A851-72100	\$ 160.95

Rockshaft Components

Application	Description	Part Number	Retail Price	Core
M4D-061, M4N-071, M5N-091, M5N-111, M5040, M5140, M5640, M5660, M6040, M6060, M7040, M7060, M8540	Rockshaft Bushing	AM3C001-82410	\$ 16.91	
M5-091, M5-111, M5L-111, M5640, M5660, M7040, M8540, M8560, M9540, M9960	Rockshaft Bushing	AM3G705-82410	\$ 16.21	

Kubota®—Industrial / Construction

Table of Contents

Radiator Hoses..... 1317

Water Pumps..... 1317

Radiator Hoses



Application	Description	Part Number	Retail Price	Core
Excavators: KH28, KH101, KH151, KH191, Loaders: R400, R410	Heater, Lower Radiator Hose 600 Watts For 1.50" Diameter Hose	AM70000-82500	\$ 65.19	

Water Pumps



Application	Description	Part Number	Retail Price	Core
Excavators: KX057-4, U55, U55-4	Water Pump	AM1J700-73030	\$ 128.40	

Kubota®—Industrial / Construction

Massey Ferguson®—Tractor

Table of Contents

Air Cleaner Components	1338	Lighting	1360
Air Conditioning and Components	1366	Lower Lift Links	1356
Alternators	1338	Manifolds and Components	1335
Axle Center Tubes and Beams	1344	Manual Steering Gearbox Assemblies	1354
Axle Pivot Assemblies and Pins	1344	Mufflers and Exhaust	1336
Belts	1331	Oil Pumps, Engine	1323
Brake Pinion Shafts	1354	Overhaul Kits	1319
Brakes and Components	1353	Power Steering Cylinders and Components	1344
Camshafts and Lifters	1322	Power Steering Orbit Motors	1347
Carburetor	1333	Power Steering Pumps	1346
Connecting Rods	1322	PTO Adapters	1352
Crankshafts	1320	PTO Clutch Components	1351
Cylinder Heads, Complete	1323	PTO Gears	1351
Differentials and Components	1353	PTO Shaft Housings	1350
Distributors	1338	PTO Shafts and Hubs	1351
Drawbar Assemblies	1355	Quick Hitches	1356
Drawbars and Components	1355	Radiator Hoses and Thermostats	1324
Engine Balancer Assemblies	1322	Radiators	1323
Engine Fans	1329	Sensors	1339
Fenders	1359	Shop Manuals and Collections	1369
Flywheels and Components	1329	Shortblock Assemblies	1318
Front Grilles, Nose Cones and Components	1359	Side Panels	1359
Front Weights and Weight Brackets	1358	Spindles	1341
Fuel Lift Pumps	1333	Starters	1337
Fuel Tanks	1359	Steering Arms	1343
Gas Struts	1366	Steering Shafts	1354
Glass	1366	Steering Wheels and Caps	1360
Hollow PTO Drive Shafts	1350	Tie Rods and Components	1339
Hydraulic Lift Components	1357	Toplink Assemblies	1358
Hydraulic Lift Pumps	1345	Transmission Components	1347
Hydraulic Pump Components	1345	Turbochargers	1335
Hydraulic Pumps	1345	Water Pumps and Components	1330
Injection Pumps	1334	Wheel Bearing Kits	1343
Injectors	1335	Wheel Hubs and Components	1342
Lift Link Assemblies and Components	1355		

Shortblock Assemblies

Our remanufactured shortblocks meet the highest standards in quality. All remanufactured components are inspected for structural integrity, cracks and dimensional specifications and then remanufactured back to OEM specifications. The components are then assembled using the highest quality new parts. We back this with one of the best warranties in the industry.

Application	Description	Part Number	Retail Price	Core
1004.4 Perkins	Reman Shortblock Assembly, Perkins	SBPK1004.4T-2	\$ 3900.00	\$ 1000.00
1004.4 Perkins	Reman Shortblock Assembly, Perkins	SBPK1004.4-3	\$ 3900.00	\$ 1000.00

Massey Ferguson®—Tractor



Overhaul Kits

Application	Description		Retail Price	Core
TE20, TO20	Z120 Engine - Gas	Inframe Kit	\$ 481.00	
	w/ Half Flange Front Main Bearing	Overhaul Kit	\$ 453.00	
TO30	Z129 Engine - Gas	Inframe Kit	\$ 490.00	
	w/ Flangeless Front Thrust Main Bearing, w/ 2 Full Round Thrust Washers	Overhaul Kit	\$ 485.00	
35, 50, 135 Special, F40, TO35, TO40, Ind/Const: 202, 204, 2135, Wheel Tractor: 2200	Z134 Engine - Gas and LPG	Inframe Kit	\$ 433.00	
		Overhaul Kit	\$ 367.00	
135 Vineyard, 150, 230, 235, 245, Ind/Const: 20C, 30B, Forklifts: 2500, 4500	Z145 Engine - Gas and LPG	Inframe Kit	\$ 491.00	
		Overhaul Kit	\$ 503.00	
65, 165, Ind/Const: 3165	G176 Engine - Gas and LPG	Inframe Kit	\$ 732.00	
		Overhaul Kit	\$ 701.00	
20, 40, 135, 150, Forklifts: 2200, 2500	3.152 Engine - Gas	Major Overhaul Kit	\$ 400.00	
135, 150, Ind/Const: 20, 40, Forklift: 2200, 2500	3.152 Engine - Gas and LPG	Inframe Kit	\$ 272.00	
		Overhaul Kit	\$ 313.00	
35, 35X, 50, Ind/Const: 35 Utility, 203, 205	3.152 Engine - Diesel Indirect Injection	Inframe Kit	\$ 249.00	
		Overhaul Kit	\$ 265.00	
65, Ind/Const: 65, 365	4A.203 Engine - Diesel Engine ASN 2820092, Indirect Injection	Inframe Kit	\$ 354.00	
		Overhaul Kit	\$ 349.00	
(65, 255 - w/ Direct Injection), 165, Ind/Const: 30, 40B, 50, 50A, 65 w/ Direct Injection, 302, 304, 3165, Combine: 300	AD4.203 Engine - Diesel Direct Injection	Inframe Kit	\$ 247.00	
		Overhaul Kit	\$ 274.00	
165, 255	4.212 Engine - Gas	Inframe Kit	\$ 332.00	
		Overhaul Kit	\$ 343.28	
175 (Build List LE20721, LE20722), 180 (Build List LE20723, LE20724), 265 Engine BSN 9A349239 (Build List LE22078, LE22079), Forklift: 6500 (Build List LE22062)	AG4.236 Engine - Gas	Inframe Kit	\$ 643.00	
		Overhaul Kit	\$ 685.00	
174-4S (Build List LD22573), 184-4 (Build List LD22574), 255 (Build List LD22694, LD22695), 265 (Build List LD22051, LD22052), 270 (Build List LD22784), 274-4 (Build List LD22573, LD31110), 670 (Build List LD31110), Ind/Const: 50C, 50D, 50E (Build List LD31113, LD31114), 50F (Build List LD22186, LD22825, LD31122), 60, Forklift: 6500 (Build List LD22055)	4.236 Engine - Diesel Engine SN 236UA109215L-U106654N	Inframe Kit	\$ 317.00	
50C, 175, 180, 184-4, 255, 265, Forklift: 6500	4.236 Engine - Diesel	Overhaul Kit	\$ 425.00	
(390T, 393, 398 - Build List LJ31142, LJ31239), 698T (Build List LJ31131), (3065, 3070 - Build List LJ31153, LJ31217), Ind/Const: 60HX (Build List LJ31231)	4.236T Engine - Diesel Engine ASN U083371N	Inframe Kit	\$ 475.00	
		Overhaul Kit	\$ 555.00	

Prices Subject to Change without Prior Notice. The use of original equipment manufacturer (OEM) part numbers or trademarks, e.g. Case® and John Deere®, are for reference purposes only and for indicating product use and compatibility. Our company and the listed replacement parts contained herein are not sponsored, approved or manufactured by the OEM. All parts are New unless designated Reman in the description.

Massey Ferguson®—Tractor

Application	Description		Retail Price	Core
275 (Build List LF22312, LF22313, LF8531B), 283 (Build List LF22790, LF31105), 290 (Build List LF22790, LF31105), 294 Transmission BSN 223D02347 (Build List LF22575, LF22762), 690 (Build List LF31091, LF31109)	4.248 Engine - Diesel Engine BSN U880191K	Inframe Kit Overhaul Kit	\$ 342.00 \$ 373.00	
285, 298, 698, 1080, 1085, Ind/Const: 70, Combine: 540	4.318 Engine - Diesel	Inframe Kit Overhaul Kit	\$ 541.00 \$ 589.00	
1100, Ind/Const: 44B, 80, 400, Combine: 510	6.354 Engine - Diesel	Inframe Kit Overhaul Kit	\$ 594.00 \$ 625.00	
1105, 1130, 1135	6.354T Engine - Diesel	Inframe Kit Overhaul Kit	\$ 685.00 \$ 707.00	
399, 699, 2640, 2675, 3090, 3505, Combine: 550	6.354.4 Engine - Diesel	Inframe Kit Overhaul Kit	\$ 579.00 \$ 652.00	
2705, 3525, 3545, 3630, 3650, Combines: 750 ASN 1696-15716, 760 ASN 1746-009-413, 850 BSN 1696-027-544, 860	T6.354.4 Engine - Diesel	Inframe Kit Overhaul Kit	\$ 784.00 \$ 965.00	
4840 Non Turbo, 4880 Turbo	903 Engine - Diesel	Inframe Kit Overhaul Kit	\$ 2491.00 \$ 2962.00	
(396, 399 Build List YA31240), 3095 (Build List YA31230, YA31250), 3120 (Build List YA31232), 4260 (Build List YA31315, YA31396), 4270 (Build List YA31301, YA31397), 6170 BSN FO14038 (Build List YA31250)	1006.6 Engine - Diesel	Inframe Kit Overhaul Kit	\$ 967.00 \$ 601.00	

Crankshafts



Application	Description	Part Number	Retail Price	Core
27, 29, 31, 500, 510, 515, 520, 525, 530, 535, 699, 800, 840, 845, 1014, 1100, 1134, 1200, 2620, 2640, 2645, 2680, 2685, 2720, 2725 Replaces 247-5091, 7407N, 31322301, 31322302, 31322321, 31322322, 31322351, 31322421, 31323202, 31323207, 31323261, 31325016, 31325019, 31325022, 31325023, 31325025, 31325028, 31325036, 31325042, ZZ90089	Crankshaft 6.354-2 354 CID 5.8 Liter 6 Cylinder Engine w/ Rope Seal 5" Stroke, 3.877" - 3.878" Bore, 2.4988" - 2.4996" Rod, 2.9984" - 2.9996" Main Flange - No Centering Ring, Flat, 12 Bolt Holes, Rope Seal Snout - Splined, 1 Bolt Hole, 1 Keyway	AM31322317	\$ 675.00	
30, 40B, 50A, 165, 255, 300 Replaces 31315181, 31315182, 31315185, 3637458M91, ZZ90095, ZZ90111, ZZ94441, ZZ94454, ZZ94455	Crankshaft 4.203 Lip Seal, Splined Nose	AM31315181-2	\$ 395.00	
(30, 50, 255 Engine BSN U546167F, 302 - w/ AD4.203 Engine), (65, 365 - w/ 4A.203 Engine BSN 2820092 or AD4.203 Engine BSN 2939035), Ind/Const: (40B Engine BSN U546167F, 50A - w/ AD4.203 Engine) Massey Ferguson® Combine: 300 w/ AD4.203 Engine Replaces 736366M91, 742742M91, 3638473M91, 3638473V91	Crankshaft w/ Rope Seal Splined Nose	AMZZ90121K	\$ 375.00	
35, 135 Replaces 1750169M1, 830686M91, Z129C205, Z129C500, Z134C500	Crankshaft Z129, Z134 Gas Engines 3.875" Stroke, 3.313" - 3.315" Bore, 1.9365" - 1.9375" Rod, 2.249" - 2.250" Main Flange - No Centering Ring, Flat, 4 Bolt Holes Snout - 2 Keyways	AM830686M91	\$ 425.00	

Massey Ferguson®—Tractor

Application	Description	Part Number	Retail Price	Core
65, 150, 155, 158, 165, 650, 765, Ind: 50, Landini® Perkins® Engines: 192, A4, R-DT6000 Replaces 84407, 85811, 92484, 92485, 742742M91, 3638473M91, 31315135, 31315138, 31315148, 31315167, 31315184, U5BG0017	Crankshaft A4.203, AD4.203 - 203 CID 3.3 Liter 4 Cylinder Engines w/ Rope Seal 5" Stroke, 3.6015" - 3.6025" Bore, 2.248" - 2.249" Rod, 2.748" - 2.749" Main Flange - No Centering Ring, Flat, 6 Bolt Holes, 1 Dowel Hole, Rope Seal Snout - Keyed, 1 Bolt Hole	AM31315145-2	\$ 375.00	
(65, 165, 255, 300, 302, 304, 356 ASN 29C1085)	Crankshaft D4.203 Engine	AM3637458M91	\$ 320.00	
135, 148, 230, 240, 250, 254, 254S, 255, 350, 353, 355, 360, 363, 550, Ind: 20B, 20D, 20E, 20F, 30E, 30H, 40, 40E, MF-Landini® Engines: C4500, R-DT5500, Perkins® Engine: A3 Replaces, 736485M1, 736532M91, 3637454M91, 31312419, 31312441, 31312700, SD260034, U5BG0031, ZZ84402, ZZ90084, ZZ90116, ZZ90148	Crankshaft 3.152 152 CID 2.5 Liter 3 Cylinder Engine w/ Rope Seal 5" Stroke, 3.6015" - 3.6025" Bore, 2.2484" - 2.2492" Rod, 2.7485" - 2.7493" Main Flange - No Centering Ring, Flat, 6 Bolt Holes, 1 Dowel Hole, Rope Seal Snout - Keyed, 1 Bolt Hole Bolt on Counterweights	AM31312436	\$ 325.00	
135, 148, 230, 240, 250, 254, 254S, 255, 350, 353, 355, 360, 363, 550, Ind: 20B, 20D, 20E, 20F, 30E, 30H, 40, 40E, MF-Landini® Engines: C4500, R-DT5500, Perkins® Engine: AD3.152 Replaces, 94458, 94464, 637399M91, 3637410M91, 31312707, 31315135, U5BG0027, ZZ90078, ZZ90150	Crankshaft 3.152 152 CID 2.5 Liter 3 Cylinder Engine w/ Lip Seal 5" Stroke, 3.6015" - 3.6025" Bore, 2.2484" - 2.2492" Rod, 2.7485" - 2.7493" Main Flange - No Centering Ring, Flat, 6 Bolt Holes, 1 Dowel Hole, Lip Seal Snout - Keyed, 1 Large Bolt Hole Bolt on Counterweights	AM31312701	\$ 325.00	
135, 150, 230, 235, 245, Ind: 20C, 30B, Forklifts: 2500, 4500 Replaces Z145C500, Z145C600	Crankshaft Z145 Continental Gas Engine	AM1047539M1	\$ 645.00	
165, 174, 174-4S, 184-4S, 265, 274, 274S, 275, 284, 284-4S, 373, 377, 383, 387, 565, 575, Ind: 30D, 50, 50B, 50D, 50E, MF-Landini® Engine: R-DT7500 Replaces 73629M91, 85821, 94433, 94434, 31315641, 31315664, 31315871, 31315881, ZZ90082, ZZ90085, ZZ90122	Crankshaft 4.236 236 CID 3.9 Liter 4 Cylinder Engine w/ Lip Seal, Splined Nose 5" Stroke, 3.9785" Bore, 2.499" - 2.4995" Rod, 2.9985" - 2.999" Main Flange - No Centering Ring, Flat, 6 Bolt Holes, 1 Dowel Hole, Lip Seal Snout - Splined, 1 Bolt Hole, 1 Keyway	AM31315631	\$ 465.00	
165, 174, 265, 274, 274S, 275, 284, 373, 377, 383, 387, 565, 575, Ind: 30D, 50, 50B, 50D, 50E, 174-4S, 184-4S, 284-4S, MF-Landini, R-DT7500 - All w/ 236 4 Cylinder Engine Replaces 3135870, 31315881, 31315980	Crankshaft 236 CID 3.9 Liter 4 Cylinder Engine 5" Stroke, 3.877" - 3.878" Bore, 2.499" - 2.4995" Rod, 2.9985" - 2.999" Main Flange - No Centering Ring, Flat, 6 Bolt Holes, 1 Dowel Hole, Lip Seal Snout - Splined, 3-Bolt Hole, 1 Keyway	AM3639541M1	\$ 410.00	
168, 175, 180, 274, 274S, 274SK, 275, 284S, 285, 365, 373, 375, 377, 383, 387, 440, 565, 575, 675, 3050, Ind: 50, 50B, 50E/EX, 50H/HX, Landini 3131599F Replaces 68050, 68609, 84421, 84422, 31315601, 31315663, 31315851, 31315881, U5BG0026, ZZ90108	Crankshaft 4.236 236 CID 3.9 Liter 4 Cylinder Engine w/ Rope Seal	AM31315884	\$ 465.00	
178, 185, 188, 194-4F, 285, 290, 294S, 294-4S, 390, 393, 397, 590, 3060, Ind: 50E, 60H Replaces, 85721, 3637789M91, 7340893M1, 31315631, 31315881, 31315912, 31315921, ZZ90093	Crankshaft 4.248 248 CID 4.1 Liter 4 Cylinder Engine w/ Rope Seal 5" Stroke, 3.9785" - 3.9795" Bore, 2.4988" - 2.4996" Rod, 2.9984" - 2.9992" Main Flange - No Centering Ring, Flat, 6 Bolt Holes, No Dowel Hole, Rope Seal Snout - Straight, Splined, 1 Bolt Hole, 1 Keyway, No Counterweights	AM31315911	\$ 385.00	
178, 185, 188, 194-4F, 285, 290, 294S, 294-4S, 390, 393, 397, 590, 3060, Ind: 50E, 60H, 10004 Phaser Replaces 94435, 94436, 3637401M91, 31315870, 31315980, 31315982, 31315991, ZZ90081, ZZ90082, ZZ90143	Crankshaft 4.248 248 CID 4.1 Liter 4 Cylinder Engine w/ Lip Seal 5" Stroke, 3.9785" - 3.9795" Bore, 2.4990" - 2.4995" Rod, 2.9985" - 2.999" Main	AM31315981	\$ 385.00	

Prices Subject to Change without Prior Notice. The use of original equipment manufacturer (OEM) part numbers or trademarks, e.g. Case® and John Deere®, are for reference purposes only and for indicating product use and compatibility. Our company and the listed replacement parts contained herein are not sponsored, approved or manufactured by the OEM. All parts are New unless designated Reman in the description.

Massey Ferguson®—Tractor

Application	Description	Part Number	Retail Price	Core
399, 1105, 1130, 1135, 2620, 2640, 2645, 2680, 2685, 2720, 2725, 3080, 3610	Crankshaft w/ Rope Seal	AM3637408M91	\$ 595.00	
2705, 3525, 3545, 3630, 3650, Combines: 750, 760, 850, 860, MF-Landini® Engine: R-DT14500 Replaces 68076, 3637404M91, U5BG0035, ZZ90086	Crankshaft A6.354.4, T6.354.4 - 354 CID 5.8 Liter 6 Cylinder Perkins® Engines w/ Lip Seal 5" Stroke, 3.877" - 3.878" Bore, 2.4988" - 2.4996" Rod, 2.9984" - 2.9996" Main Flange - No Centering Ring, Flat, 12 Bolt Holes, Lip Seal Snout - Keyed Nose, 3 Bolt Holes, 2 Keyways	AM3131H021	\$ 675.00	
699, 800, 805, 840, 845, 1014, 1100, 1105, 1130, 1135, 1200, 2620, 2640, 2645, 2680, 2685, 2720, 2725, Combine: 750 Replaces 31323261, ZZ94443, ZZ94460, ZZ94468, ZZ90090	Crankshaft A6.354 354 CID 5.8 Liter 6 Cylinder Engine w/ Lip Seal 5" Stroke, 3.877"-3.878" Bore, 2.4988" - 2.4996" Rod, 2.9984" - 2.9996" Main Flange - No Centering Ring, Flat, 12 Bolt Holes, 1 Dowel Hole, Lip Seal Snout - Splined, Keyed, 1 Bolt Hole	AM31323262	\$ 615.00	
TE20, TO20	Crankshaft Z120 Gas Engine	AM47120042	\$ 425.00	

Connecting Rods



Application	Description	Part Number	Retail Price	Core
1105, 1130, 1135, Combines: 750, 760	Reman Connecting Rod	AMCR31337230-R	\$ 190.00	\$ 25.00

Camshafts and Lifters

Application	Description	Part Number	Retail Price	Core
35, 50, 135, 150, 203, 205, 2135, 2200, 230, 231, 235, 240, 245, 250, 20, 20C, 20D, 20F, 30B, 30D, 30E, 30H, 40	Camshaft A3.152, AD3.152	AM31415261	\$ 104.28	
65, 165, 356, 3135, 3165	Camshaft Cont. Gas- G176	AM1753789M1	\$ 227.00	
30, 31, 50C, 50D, 50E, 50H, 60, 165, 175, 180, 255, 262, 265, 270, 275, 282, 283, 285, 290, 365, 375, 565, 575, 675, 590, 690, 3050, 3060	Camshaft A4.212, A4.236, A4.248	AM31415321	\$ 100.00	
175, 180, 265	Camshaft A4.236	AM31415292	\$ 95.00	
365, 375, 383, 675, 3050, 390, 393, 397, 690	Camshaft A4.236, A4.248	AM31415375	\$ 110.00	
399, 699, 2640, 2675, 3090, 3505 - w/ Perkins® 354.4 Diesel Engine	Camshaft Replaces 745713M1	AM31416303	\$ 185.00	
40, 50, TO20, TO30, TO35	Camshaft Z120, Z129, Z134	AM836543M91	\$ 149.50	
35, 50, 65, 135, 150, 230, 231, 235, 245, 250, 253, 254-4, 255, 355, 356, 360, 3165, Ind: Tractors: 20, 20C, 20E, 20F, 30B, 30D, 30H, 40, 40B, 40E, 65, 203, 205, 365, 2135, 2200	Lifter w/o Adjusting Screw Replaces 957E6489, 731150M1, 731150V1, 860012, 81804255	AM0860012	\$ 4.65	

Engine Balancer Assemblies



Application	Description	Part Number	Retail Price	Core
4.236 and 4.248 - Early Perkins Diesel Engines	Engine Balancer Assembly Front Mount - 4 Bolt	AM746432M91	\$ 375.00	
4.236, 4.236T, 4.248 - Late Perkins Diesel Engines	Engine Balancer Assembly Mid Mount - 6 Bolt	AM3637352M91	\$ 550.00	

Massey Ferguson®—Tractor



Cylinder Heads, Complete

Application	Description	Part Number	Retail Price	Core
35, 50, MH50, Ind/Utility: 35, 200 Series	Cylinder Head, Complete Perkins® 3.152 w/ Indirect Injection	AM3638321M91	\$ 320.00	
35	Cylinder Head w/ Valves Perkins® 4.236	AMZZ80058	\$ 465.00	
65, Ind: 65, 365	Cylinder Head, Complete Marked ZZ80033, ZZ80047	AM3637485M91	\$ 545.00	
135, 150, 154, 230, 235, 240, 245, 250, 254, 200 Series Ind., 2135, 20, 20C, 30B, 30D, 40, 2200, 2500 & 4500 Forklift	Cylinder Head, Complete Perkins® AD3.152 w/ Direct Injection	AM3637389M91	\$ 320.00	
3100	Cylinder Head w/ Valves 6V 3 Cylinder w/o Turbo	AMZZ80082	\$ 520.00	



Oil Pumps, Engine

Application	Description	Part Number	Retail Price	Core
35, 50, 135, 150, 230, 231, 235, 241, 243, 250, 253, 263, 355, 360, 451, 2210, 2220, 3315, 3325, 4215, 4315, 4320, Ind: 20, 20C, 20D, 20E, 20F, 30B, 30D, 30E, 30H, 35X, 40, 40E, 40EL, 203, 205, 2135, 2200	Engine Oil Pump Idler Gear Not Included Replaces 3637359M91, 3638632M91, 3638632V91	AM41314078	\$ 50.00	
65, 165, 255, Ind: 30, 40B, 50, 302, 304, 3165 Perkins Diesel	Engine Oil Pump	AM41314189	\$ 80.00	
135, 150, 154-4, 202, 203, 205, 230, 235, 240, 245, 250, 250-4, 1545, 2135, Ind: 20, 20C, 20D, 20F	Engine Oil Pump	AM41314187	\$ 78.70	
174-4, 270, 283, 290, 294-4, 374, 375, 383, 384, 390, 390T, 393, 394, 690, 3050, 3060, 3065, 3075, 6150	Engine Oil Pump Fits late engines w/ mid-mount balancer 6-bolt mounting	AM4132F041	\$ 69.00	
285, 298, 698, 1080, 1085	Engine Oil Pump	AM41314113	\$ 161.97	
399, 699, 3090, 3505	Engine Oil Pump	AM4132F015	\$ 110.00	
1100, 1105, 1130, 1135	Engine Oil Pump	AM41314067	\$ 85.00	
3525, 3545, 3630, 3650	Engine Oil Pump	AM4132F016	\$ 79.66	



Radiators

Application	Description	Part Number	Retail Price	Core
20C ASN 9A282759, 230, 245	Radiator Overall: 15.75" x 24.25" x 2" 3 Rows	AM579004M91	\$ 317.00	
20D, 20E, 20F, 30E, 30H, 40E, 240, 250 - 2WD	Radiator Core: 15 3/16" x 18 1/2" x 2" 3 Rows, 6 Fins per Inch	AM1680547M92	\$ 185.00	
35 w/ 3.152 Diesel Engine	Radiator Overall: 16" x 23 1/8" Core: 15 1/2" x 17 1/2" x 1 5/8" 3 Rows, 9 Fins per Inch Replaces 894319M91	AM894319M92	\$ 200.00	
35 w/ Continental Gas Engine, TE20, TO20, TO30 Gas	Radiator Core: 15 3/8" x 17 1/2" x 2 1/16"	AM181623M91	\$ 145.00	

Massey Ferguson®—Tractor

Application	Description	Part Number	Retail Price	Core
50, MH50*, 65 - w/ Gas or LPG *MH50 will require lower brackets from old radiator	Radiator Replaces 184525M91	AM182456M91	\$ 220.00	
50, 50A, 65, 302, 304 - w/ Diesel Engine	Radiator Overall: 16 5/16" x 23" x 2"	AM186733M91	\$ 218.00	
50E, 265S, 270, 283, 283UK, 285S, 290, 290UK, 670	Radiator Core: 15 1/4" x 19" x 2 1/2"	AM1669650M94	\$ 210.00	
135, 148	Radiator Core: 15 1/2" x 18 1/2" x 1 5/8" 3 Rows, 9 Fins per Inch	AM1660499M92	\$ 175.00	
165, 185, 188	Radiator Replaces 885411M93	AM885579M93	\$ 225.00	
202, 205, 302, 304, TO35 BSN 204181	Radiator Core: 15 1/4" x 17 1/2" x 2" 3 Rows, 8 Fins per Inch"	AM180291M1	\$ 235.00	
285 Late	Radiator	AM579339M91	\$ 375.00	
375, 383, 390, 390T, 393, 398, 399 (w/ 354 Perkins Engine)	Radiator Core: 20" x 19 9/16" x 2 11/16" 4 Rows, 9 Fins per Inch	AM1695721M2	\$ 300.00	
1105, 1135	Radiator Core: 22" x 18 1/4" x 3 3/4" 5 Rows, 8 Fins per Inch	AM529684M91	\$ 475.00	
3070 Prior to 07/1993, 3075, 3095 BSN B249026, 3120, 6150, 6160, 6170, 6180	Radiator Overall: 23 1/2" x 28" x 2 3/4"	AM3618628M92	\$ 500.00	
5425 BSN 163022 & SN 186043-1637479, 5435 BSN 1637479, (5445, 5455 BSN 1637468), (6235, 6445 BSN 163361)	Radiator Aluminum Core: 20.71" x 27.09" x 3.94" 3 Rows	AM3781114M1	\$ 875.00	
5455, 6255, 6260, 6455	Radiator Aluminum Core: 20.71" x 21.57" x 3.94", 4 Rows	AM3781115M1	\$ 719.50	
5460, 5465, 5470, 6460, 6465, 6470, 6475, 6480, 7465, 7475	Radiator Aluminum Core: 20.71" x 22.36" x 3.94", 4 Rows Replaces 787420M2	AM3785830M2	\$ 957.00	
6497, 6499, 8220	Radiator	AM3780221M4	\$ 1006.93	
3645 ASN B249040, (3655, 3660 ASN B284013), 6190, 8110, 8120 BSN F044008, 8130	Radiator Overall: 23 3/8" x 29" x 3"	AM3619008M92	\$ 559.00	

Radiator Hoses and Thermostats

Application	Description	Part Number	Retail Price	Core
35 w/ A3.152 Engine	Radiator Hose, Upper 1.50" ID	AM890195M1	\$ 8.00	
35, 35X (FE), TO20, TO30, TE20, TEA20	Radiator Hose, Upper 1.50" ID Replaces 825656M1, 828147M1, K37575	AMK200730	\$ 14.46	
35X (FE) BSN 7704, TO35 - Diesel	Radiator Hose, Upper 1.50" ID	AM827496M1	\$ 13.49	
(50, 65 - Gas), 135 Gas or Diesel, 230 BSN 243032 Gas or Diesel, 235 Diesel	Radiator Hose, Upper 1.532" ID Replaces 180085M1	AM182345M1	\$ 9.99	
65 w/ A4.192 or AD4.203 Engine, 765 w/ A4.192 Engine	Radiator Hose, Upper 1.50" & 1.75" ID	AM186654M1	\$ 7.50	

Massey Ferguson®—Tractor

Application	Description	Part Number	Retail Price	Core
135UK, 230, 231, 240, 240S, 241, 243, 250, 253UK, 263, (265, 275 - w/ 4.236 Engine), (565, 575 - w/ A4.236 Engine)	Radiator Hose, Upper 1.375" & 1.437" ID Replaces 186826M1, 897455M1, 10329404	AM1869514M1	\$ 8.63	
135UK, 230, 231, 240, 240S, 241, 243, 250, 253UK, 263, (265, 275 - w/ 4.236 Engine), (565, 575 - w/ A4.236 Engine), Ind: 20D	Radiator Hose, Upper 1.375" & 1.437" ID Replaces 897455M1	AM186826M1	\$ 8.63	
(135, 230 BSN 243032, 235 Standard Clearance - Gas)	Radiator Hose, Upper 1.625" ID	AM194299M1	\$ 9.38	
150 Gas or Diesel	Radiator Hose, Upper 1.50" ID	AM505618M1	\$ 13.29	
165, 175	Radiator Hose, Upper 1.50" ID	AM194734M1	\$ 10.01	
165 - w/ Perkins® Gas Engine, 175 - w/ Perkins® Gas or Diesel Engine, 255 - w/ Gas Engine or A4-236 Diesel Engine, 265 Gas or Diesel, 275	Radiator Hose, Upper 1.532" ID	AM194736M1	\$ 13.70	
(165, 255 - Diesel)	Radiator Hose, Upper 1.50" ID	AM194738M1	\$ 8.76	
168 w/ A4.236 Engine, 261, 270, 275, 282, 290, (178 ASN 724937, 185, 188, 590 - w/ A4.248 Engine)	Radiator Hose, Upper 1.625" ID	AM899144M1	\$ 11.37	
180 Diesel	Radiator Hose, Upper 1.562" ID	AM506380M1	\$ 18.15	
210, 210-4	Radiator Hose, Upper 1.25" ID Replaces 3280168M1	AM72097704	\$ 18.56	
230 ASN 243032, 245 Standard - Gas	Radiator Hose, Upper 1.532" ID	AM544130M2	\$ 15.21	
230 ASN 243032, 245 Standard Models ASN 9A349238 or All Orchard - Diesel	Radiator Hose, Upper 1.532" ID	AM539808M2	\$ 13.92	
235 Orchard, 245 Orchard, Ind: (20C, 30B - Diesel), 30D	Radiator Hose, Upper 1.50" & 1.85" ID	AM533996M1	\$ 18.67	
283UK, 390E	Radiator Hose, Upper 1.50" ID	AM1692004M1	\$ 15.65	
285 ASN 349239	Radiator Hose, Upper 2" ID	AM772165M3	\$ 30.67	
285 BSN 349239	Radiator Hose, Upper 2" ID	AM532542M1	\$ 16.45	
362	Radiator Hose, Upper 1.50" & 1.812" ID	AM3611652M1	\$ 20.75	
364S, 374S, 384S, 394S	Radiator Hose, Upper 1.75" ID	AM3303316M1	\$ 5.98	
365, 375, 383, 390, 390T, 393, 398	Radiator Hose, Upper 2" ID	AM3596204M1	\$ 14.33	
399 w/ or w/o Cab	Radiator Hose, Upper 2" ID	AM1695563M1	\$ 21.33	
481, 590	Radiator Hose, Upper 1.532" ID	AM2800304M1	\$ 13.47	
(595, 1080 - w/ A4.318 Engine)	Radiator Hose, Upper 2" ID Replaces 1672030M1	AM1671076M1	\$ 17.70	
670, 690	Radiator Hose, Upper 1.50" & 1.812" ID Replaces 1681509V1	AM1681509M1	\$ 19.91	
698	Radiator Hose, Upper 2" ID	AM1669805M1	\$ 17.13	

Prices Subject to Change without Prior Notice. The use of original equipment manufacturer (OEM) part numbers or trademarks, e.g. Case® and John Deere®, are for reference purposes only and for indicating product use and compatibility. Our company and the listed replacement parts contained herein are not sponsored, approved or manufactured by the OEM. All parts are New unless designated Reman in the description.

Massey Ferguson®—Tractor

Application	Description	Part Number	Retail Price	Core
699	Radiator Hose, Upper 2" ID	AM1692871M1	\$ 27.82	
1080, 1085	Radiator Hose, Upper 2" ID	AM522078M1	\$ 13.55	
1100 Diesel ASN 3954, 1105, 1130 ASN 651500079, 1134	Radiator Hose, Upper 2" ID	AM512158M1	\$ 15.60	
1100 Diesel BSN 3954, 1130 BSN 651500079	Radiator Hose, Upper 2" ID	AM509843M1	\$ 17.10	
1150, 1155, 2675 BSN 9R007628, 2705 SN 9R006482-9R007110	Radiator Hose, Upper 2" ID	AM362005X1	\$ 4.91	
2745, 2775, 2805 ASN 9R0374	Radiator Hose, Upper 2.25" ID	AM3039215M1	\$ 10.11	
2775, 2805 ASN 9R0374	Radiator Hose, Upper 1.625" & 2.20" ID	AM3039214M1	\$ 9.11	
2805 BSN 9R0374	Radiator Hose, Upper 2.25" ID	AM367639X1	\$ 3.72	
3060 w/ A4.248 Engine, 3065 w/ AT4.236 Engine	Radiator Hose, Upper 1.95" ID Replaces 3382976M1	AM3382976M2	\$ 17.51	
3085, 3095, 3115, 3120, 3120T, 6160, 6170, 6180 Ind: 50B, 50D	Radiator Hose, Upper 1.625" ID Replaces VPE4150	AM3582179M2	\$ 23.43	
35, 135, TO35 - Gas	Radiator Hose, Lower 1.532" ID	AM180783M1	\$ 9.79	
35X (FE), 135UK, TO35 Standard Diesel	Radiator Hose, Lower 1.375" ID	AM826988M1	\$ 12.41	
(50, 65 - Diesel), Ind: 50A, 302, 303	Radiator Hose, Lower 1.50" ID	AM187554M1	\$ 20.28	
50, 65, 150	Radiator Hose, Lower 1.5352" ID	AM184325M1	\$ 22.84	
(50, 165UK, 765 - w/ AD4.203 Engine)	Radiator Hose, Lower 1.50" ID	AM898065M1	\$ 6.68	
135 Gas or Diesel	Radiator Hose, Lower 1.50" ID	AM519437M1	\$ 11.77	
(135, 135UK BSN 148525, 230 BSN 243032, 240S - Gas), (135, 230 BSN 243032, 235 - Diesel)	Radiator Hose, Lower 1.50" ID	AM186968M1	\$ 13.35	
150 Gas or Diesel	Radiator Hose, Lower 1.50" ID	AM505617M1	\$ 20.09	
165	Radiator Hose, Lower 1.50" ID Replaces 1206-0159	AM512058M1	\$ 17.10	
165, 175	Radiator Hose, Lower 1.532" ID	AM194735M2	\$ 10.71	
(165, 175 - w/ Gas Engine BSN 67215)	Radiator Hose, Lower 1.625" ID	AM515224M1	\$ 13.60	
(165, 175 ASN 67215), 255, 265 - All w/ Gas	Radiator Hose, Lower 1.625" ID	AM520646M1	\$ 9.67	
(165, 255 - Diesel)	Radiator Hose, Lower 1.50" ID Replaces 894793M1	AM194739M2	\$ 12.85	
(168, 565, 575- w/ A4.236 Engine), 175 Diesel, 180 (BSN 67215 w/ Gas Perkins® Engine), 185 (w/ A4.248 Engine), 261, (255, 265, 275 - w/ 4.236 Engine)	Radiator Hose, Lower 1.50" ID	AM898748M1	\$ 13.74	
175UK w/ A4.236 Engine, 178 BSN 724936 w/ A4.248 Engine	Radiator Hose, Lower 1.50" ID	AM898745M1	\$ 11.33	

Massey Ferguson®—Tractor

Application	Description	Part Number	Retail Price	Core
180 Diesel	Radiator Hose, Lower 1.562" ID	AM506378M1	\$ 19.82	
184-4, 274-4, 294-4	Radiator Hose, Lower 1.58" ID	AM1424533M2	\$ 31.09	
205, 205-4	Radiator Hose, Lower 1.062" & 1.25" ID	AM3281311M1	\$ 16.57	
210, 210-4	Radiator Hose, Lower 1.312" ID Replaces 3280167M1	AM72097702	\$ 18.14	
220, 220-4	Radiator Hose, Lower 1.25" ID Replaces 3280650M1	AM72098630	\$ 20.67	
230, 231, 240, 250	Radiator Hose, Lower 1.50" & 1.562" ID	AM1860374M1	\$ 10.65	
230, 231, 240, 250	Radiator Hose, Lower 1.50" & 1.562" ID Replaces 1860374M1	AM1860374M2	\$ 10.65	
230 BSN 243032, 235 Standard - Gas	Radiator Hose, Lower 1.58" ID	AM544313M1	\$ 11.19	
230 Gas or Diesel ASN 243031, 245 Standard	Radiator Hose, Lower 1.50" ID	AM544080M1	\$ 7.55	
230 Gas ASN 243032, 245 Vineyard Diesel	Radiator Hose, Lower 1.532" ID	AM826775M1	\$ 7.12	
(235, 245 - Diesel), Ind: (20C, 30B, 2200 - Diesel), (30D, 40 - Gas or Diesel)	Radiator Hose, Lower 1.50" ID	AM511951M1	\$ 18.14	
240 w/ Hydrostatic Steering, 253UK, 263	Radiator Hose, Lower 1.532" ID	AM3599573M3	\$ 21.20	
263, 4WD: 240 ASN A20286, 253	Radiator Hose, Lower 1.25" & 1.50" ID	AM3698937M1	\$ 14.23	
270, 282, 283UK, 290, 390E, 471, 481, 590, 670, 690, 5275, 5285, 5290	Radiator Hose, Lower 1.60" ID	AM885563M1	\$ 15.24	
275 BSN 349239	Radiator Hose, Lower 1.625" ID	AM534180M1	\$ 17.42	
275 ASN 349239	Radiator Hose, Lower 1.656" ID	AM579773M1	\$ 15.27	
285	Radiator Hose, Lower 1.75" & 2" ID	AM532541M2	\$ 16.94	
298	Radiator Hose, Lower 1.65" ID	AM1691477M1	\$ 18.32	
360	Radiator Hose, Lower 1.25" & 1.50" ID Replaces 1694711V3	AM1694711M3	\$ 24.15	
362	Radiator Hose, Lower 1.312" & 1.625" ID	AM1695868M1	\$ 11.05	
365, 375, 383, 390, 390T, 393, 398	Radiator Hose, Lower 1.532" ID	AM1695562M1	\$ 13.67	
396, 399 w/ 1006.6 Engine	Radiator Hose, Lower 1.625" & 2.25" ID	AM3614419M1	\$ 28.26	
399 - w/ Cab	Radiator Hose, Lower 0.47", 1.562" & 2.25" ID	AM3596194M1	\$ 34.04	
399 w/o Cab	Radiator Hose, Lower 1.625" & 2.312" ID	AM1695564M1	\$ 18.86	
698	Radiator Hose, Lower 1.65" ID Replaces 1669806V1	AM1669806M1	\$ 26.92	
699	Radiator Hose, Lower 1.28" ID	AM1692870M1	\$ 23.52	

Prices Subject to Change without Prior Notice. The use of original equipment manufacturer (OEM) part numbers or trademarks, e.g. Case® and John Deere®, are for reference purposes only and for indicating product use and compatibility. Our company and the listed replacement parts contained herein are not sponsored, approved or manufactured by the OEM. All parts are New unless designated Reman in the description.

Massey Ferguson®—Tractor

Application	Description	Part Number	Retail Price	Core
1080, 1085	Radiator Hose, Lower 1.75" & 2" ID	AM520309M91	\$ 26.04	
1100 Diesel ASN 17222, 1105, 1130 ASN 16950, 1134	Radiator Hose, Lower 2.06" ID	AM518179M91	\$ 14.15	
1100 Diesel BSN 17222, 1130 BSN 16950	Radiator Hose, Lower 2.125" ID	AM503595M1	\$ 16.13	
1150	Radiator Hose, Lower 2" & 2.25" ID	AM520656M1	\$ 17.89	
1155	Radiator Hose, Lower 2.312" ID	AM527775M1	\$ 19.47	
2620, 2625, 2640, 2645, 2675 BSN 9R007628, 2680, 2685, 2705 SN 9R006482-9R007110, 2720, 2725, 3505, 3525, 3545, 3630, 3650	Radiator Hose, Lower 2.25" ID	AM3040882M92	\$ 25.60	
(2775, 2805 BSN 0777)	Radiator Hose, Lower 3" ID	AM1626285M91	\$ 15.91	
3080, 3090	Radiator Hose, Lower 1.95" & 2.25" ID	AM3382985M1	\$ 16.89	
3085, 3095, 3115, 3120, 6160, 6170, 6180	Radiator Hose, Lower 2" & 2.125" ID	AM3618641M1	\$ 32.03	
(4225, 4325 - w/ 1004.4 Engine), 4233, 4240, 4243, 4253, 4263, 4265, 4365, 5320, (4235, 4245, 4255, 4335, 4345, 4355, 6235, 6245, 6255 - w/ 1004.4T Engine), (4260, 4360, 6260 - w/ 1006.6 Engine), 4270 w/ 1006.6 or 1006.6T Engine, (4370, 6270, 6280, 6290 - w/ 1006.6T Engine), 6265 w/ 1004.4T Engine	Radiator Hose, Lower 2" & 2.156" ID	AM3801168M1	\$ 27.08	
9240	Radiator Hose, Lower 2" ID	AM303424243	\$ 16.81	
TE20, TEA20, TO20, TO30	Radiator Hose, Lower 1.50" ID	AM180145M1	\$ 13.10	
TEA20	Radiator Hose, Lower 1.375" ID	AM825657M1	\$ 11.08	
(50, 65, 165, 255 - w/ AD4-203 Diesel Engine), Ind: 30, 40B, 50A, 302, 304, 3165	Radiator Hose 90° Elbow, 1.44" ID	AM731174M1	\$ 10.10	
2775, 2805	Water Pump Inlet Hose 1.625" ID	AM742999M1	\$ 8.91	
35, 135UK	Bypass Hose 0.90" ID	AM826257M1	\$ 7.09	
(35, 135, 148 - w/ A3.152 or AD3.152 Engine), 150 w/ Perkins® Gas Engine, 154-4, 154-4S, 230, 231, 235, 240, 240P, 245, 253, 254-4, 360, 550UK, Ind: 20, 20D, 20F, 30B, 30D, 30E, 30H, 40, 40E, 202, 203, 205, 2135, 2200	Bypass Hose 1.125" ID Replaces 747936M91, 81716947, 86513585, E6CJ9, E15CJ9	AM731256M1	\$ 5.76	
65 After Engine SN 203UA97890, 255 w/ AD4-203 Engine, Ind: (30, 50A - After Engine SN 203UA97890), 40B, Combine: 300 After Engine SN 203UA97890	Bypass Hose	AM747942M91	\$ 7.58	
396, 399, 650, 680, 3085, 3095, 3115, 3120, 3120T, 3125, 3140, 3635, 3645, 3655, 3660, 4260, 4263, 4270, 4360, 4370, 5320, 6160, 6170, 6180, 6190, 8110, 8120, 8130	Bypass Hose 1.50" ID	AM3637257M91	\$ 7.65	
471, 4243, 4253, 5275, 5285, 5290, 5300, (4225, 4235, 4240, 6110, 6120 - w/ 4.41 Engine), (4245, 4255 - w/ 1004.4 Engine), (6130, 6140, 6150 - w/ 1004.4T Engine)	Bypass Hose 1.125" ID	AM3640921M91	\$ 17.08	
(595, 698, 1080 - w/ A4.318 Engine)	Bypass Hose 1.75" ID Replaces 737163M1	AM747946M91	\$ 24.15	

Massey Ferguson®—Tractor

Application	Description	Part Number	Retail Price	Core
TEA20 w/ 80 mm or 85 mm Engine	Bypass Hose 0.90" ID Replaces 57073	AM825684M1	\$ 6.67	
35 w/ A3.152 Engine, 50, 135UK, 154-4, 154-4S, 231, 235, 240, 245, 253, 254-4, 263, (135, 150 - w/ Perkins® Gas or Diesel Engine), (148, 230, 250, 550UK - w/ AD3.152 Engine), Ind: 20, 20C, 20D, 20E, 20F, 30B, 30D, 30E, 30H, 40, 2135, 2200	Water Pump Inlet Hose 1.375" ID Replaces 8176946	AM732443M1	\$ 8.10	
292, 365, 375, 383, 390, 390T, 393, 398, 698T, 5275, 5285, 5290, 5300	Water Pump Inlet Hose 1.125" ID	AM3637573M1	\$ 12.69	
1100, 1105, 1130, 1135, Combines: 750 BSN 16961571 w/ A6-372 or AT6-354 Engine, 760 BSN 1746009413 w/ AT6-354 Engine	Water Pump Inlet Hose 2" ID, 2 3/8" & 4 5/8" Long Replaces 735604M1	AM744671M1	\$ 9.88	
2775, 2805	Water Pump Inlet Hose 2" ID	AM743001M1	\$ 6.68	
431, 461, 471, 491, 492, 543, 583, 596, 5425, 5435, (5445, 5455, 6445, 6455 - 02/2004 and Later), 6460 ASN P098025, 6470 ASN P102051	Thermostat, 180° Replaces Perkins® 4133L507	AM4225430M1	\$ 32.34	
135UK, 203, 205, 220, 230, 231, 235, 240, 245, 250, 253, 263, Ind/Const: 20, 20C, 20E, 30B, 30C, 30H, 35, 40, 40E, 4500	Thermostat Cap Replaces 731000M1	AM37747581	\$ 30.00	



Engine Fans

Application	Description	Part Number	Retail Price	Core
270, 274, 275, 282, 283, 290, 294, 298, 373, 374, 377, 383, 384, 387, 393, 394, 397, 590, 670, 690, 698, 1080, Ind: 50E	Engine Fan 6 Blade, 16" Diameter, 1.625" Pilot Hole 2.50" C-C Mounting Holes Replaces 773010M1, 1874995M1, 1874995M2	AM3538983M91	\$ 35.00	
TO20, TO30, TO35	Engine Fan 4 Blade, 15.375" Diameter, 1.625" Pilot Hole 2.50" C-C Mounting Holes	AM3638342M91	\$ 36.00	
5465, 5475, 7465, 7475	Belt Tensioner, Engine Fan Replaces 4226287M91	AM4227209M91	\$ 104.73	



Flywheels and Components

Application	Description	Part Number	Retail Price	Core
261, 270, 275, 282, 283, 362 (w/ A4.236 Engine Build List LD31234), 365 (BSN B18009 w/ A4.236 Engine), 375 (w/ A4.236 Engine), 383 (w/ A4.248 Engine), 390 (Build List LF31141, LF31249), 670 Diesel, 690	Flywheel Replaces 41112565, 41117084	AM742106M91	\$ 462.77	
All Models w/ 3.152, 4.236, 4.236T, 2.48 Perkins Diesel	Flywheel Ring Gear 115 Tooth, Use with 742106M91 Flywheels	AM731008M1	\$ 31.00	

Massey Ferguson®—Tractor

Water Pumps and Components

The remanufactured water pumps we supply have an extra step added to the remanufacturing process to ensure quality. Since the bearing and seal assembly are critical in performance, we ensure air-tight seals by vacuum testing our water pumps prior to packaging. This guarantees no leakage will occur after your water pump has been installed.



Application	Description	Part Number	Retail Price	Core
25, 130 - w/ 4.99 or 4.107 Perkins® Diesel Engine	Water Pump w/o Pulley Includes Mounting Gasket Replaces 743064M91, 748073M91, 3118125R91	AM748095M91	\$ 62.50	
30, 40B, 65, 165, 255, 300, 302, 304, 365	Water Pump w/ Pulley Includes Mounting Gasket Replaces 3637372R91, 3641250M1, 41312167	AM3637372M91	\$ 61.00	
30, 50, 65, 165, 255, Ind/Const: 302, 304, Utility: 3165 - All w/ 4.203 Engine	Water Pump Pulley Replaces 31146582	AM731805M1	\$ 36.16	
35, 50, 135, 150, F40, MH50, TO35, Ind: 204	Water Pump	AM830691M91	\$ 37.00	
(35, 135, 150, 235, 240, 245, 253, 360, 365, 4WD: 154-4, 254-4 - w/ Perkins® 3-152 Engine), 230, Ind: (20, 20C, 20F, 30B, 30D, 200 Series - w/ Perkins® 3-152 Engine)	Water Pump w/ Pulley Cast # - 37711330	AM3641823M91WP	\$ 39.00	
35, 135, 202, 204, 230, 235, 245, 2135, 2200, TO35, Forklift: 4500 - All w/ Continental Gas Engine	Water Pump Pulley, Single Groove	AM1750081M1	\$ 71.49	
44, 80, 400, 500, 510, 520, 525, 541	Water Pump	AM3641861M91	\$ 128.79	
50C, 175, 178 w/ A4.248 Engine, 180, 255, 261, 265, 270, 275, 283, 362	Water Pump Includes Mounting Gasket Replaces 4131A013, 4131A021, 743064M91	AM3637411M91	\$ 55.00	
65, 165 w/ AD4-203 Diesel Engine, 255, 765, 3165, Ind: 30, 40B, 50, 50A, 300, 302, 304, 356	Water Pump w/ Pulley Includes Mounting Gasket Replaces 731807M92, 3641250M91, 41312167	AM747597M91	\$ 88.00	
65, 180 - w/ Continental Gas Engine	Water Pump Includes Mounting Gasket Replaces 835615M91, 835615V92	AM835615M92	\$ 67.00	
65, 180, 274-4, 302, 304	Water Pump	AM835615M91	\$ 89.00	
Super 90 - w/ Perkins® Diesel	Reman Water Pump Cast # - 37711390	AM37711390-R	\$ 145.00	\$ 75.00
165, 255, 265, Ind: 30	Water Pump	AM37711070	\$ 95.00	
175, 255 Late w/ 4.236, 265, 275, 282, 290, Ind: 31, 50C, 50D, 50E, 50H	Water Pump Cast # - 37711630	AM3641832M91	\$ 45.00	
251XE, 263, 451, 4215, 4220, 4225, 4235, 4240	Water Pump Includes Mounting Gasket Replaces 4131A051, 4222656M91, 4224105M91	AM365375A1	\$ 152.00	
270, 283, 290, 294, 365, 375, 383, 390, 390T, 393, 398, 670, 690, 3055, 3060, 3065, 3070, 3075, 4225, 4235, 4243, 4245, 4253, 4255, 6140, 6150, Ind: 50E, 50F, 50HX, Backhoe-Loaders: 60H, 60HX	Water Pump w/o Pulley Replaces 3641181M91, 3641263M91, 4222002M91	AM41313227	\$ 60.00	
270, 390T, 393, 398, 471, 670, 698T, 2225, 3065, 3070, 3330, Ind/Const: 50E, 50F, 3050	Water Pump w/o Pulley Includes Mounting Gasket Replaces 3641361M91, 4222071M91	AMU5MW0106	\$ 76.00	
285, 298	Water Pump Cast # - 37711030	AM3641363M91	\$ 100.00	
375, 383, 390, 390T, 393, 398, 3050, 3060, 3065, 3070, Perkins® 4.236 Engine	Water Pump w/o Pulley Replaces 3637468M91	AM4222002M91	\$ 68.50	
375, 390, 390T, 393, 398, 3050, 3060, 3065, 3070, Ind: MF50H, HX60H, TLB	Water Pump w/ Pulley	AM4222002M91WP	\$ 74.00	

Massey Ferguson®—Tractor

Application	Description	Part Number	Retail Price	Core
396, 399 w/ 1006 Engine, 3095, 3120, 3120T, 3125, 3140, 3645, 3655, 3660, 4260, 4263, 4270, 4360, 4370, 6170, 6180, 6190, 8110, 8120, 8130	Water Pump Replaces 4222466M91, 4223109M91, 4223566M91	AMU5MW0159	\$ 110.00	
399, 699, 2640, 2675, 3090, 3545, 3630, 3650	Water Pump Cast # - 37712630	AM3641880M91	\$ 205.00	
491, 492, 4225, 4233, 4235, 4243, 4245, 4253, 4255, 4265, 4325, 4335, 4345, 4355, 4365, 5325, 6235, 6245, 6260, 6265, 6270, 6280, 6290, 8210, 8220	Water Pump Replaces 2396142, 4222840M91, 4224475M91	AMU5MW0193	\$ 138.00	
698, 1080, 1085	Water Pump, 3/4" Shaft Cast # - 37712390	AM37712390-3/4N	\$ 175.00	
	Water Pump, 15/16" Shaft	AM3641887M91	\$ 117.00	
750 w/ A6354.4 Engine, 760, 850, 860 w/ AT6354.4 Engine	Water Pump Cast # - 37711880, 37711882, 41313048	AM4222001M91	\$ 120.00	
750, 850	Water Pump Cast # - 37711870	AM3637466M91	\$ 158.34	
760, 860	Reman Water Pump Cast # - 37712470	AM3637354M91-R	\$ 140.00	\$ 75.00
1010, 1020	Water Pump Includes Mounting Gasket Replaces 72103891	AM3284086M92	\$ 84.00	
1040, 1045, 6140 - w/ 3 Cylinder Toyosha Engine	Water Pump Replaces 3436671V91, 3436674V91	AM72099891	\$ 99.50	
1100, 1130 - w/ Single Thermostat	Water Pump, 3/4" Shaft Cast # - 37712330	AM37712330-3/4N	\$ 282.00	
	Water Pump, 7/8" Shaft Cast # - 37712330	AM3641870M91	\$ 170.00	
1100, 1135, 1105, 1130	Water Pump, 3/4" Shaft Cast # - 37712540, 37712460	AM37712540-3/4N	\$ 165.00	
	Water Pump, 15/16" Shaft	AM3641365M91	\$ 207.00	
1150, 1155	Reman Water Pump Cast # - 37711000	AM37711000-R	\$ 105.00	\$ 75.00
2705, 3525	Water Pump	AM744314M91	\$ 270.00	
2745, 2775, 2805	Reman Water Pump This water pump will only work on app. where the serial number begins with "UA" Cast # - 37712640	AM37712640-R	\$ 175.00	\$ 30.00
5465, 6465, 6475, 6480, 7465, 7475, 7480	Water Pump Perkins® Mfg # - U5MW0196	AM4224708M91	\$ 175.31	
TE20, TO20, TO30	Water Pump	AM830862M91	\$ 48.00	
Utility: (1240, 1250, 1260 BSN E60101), 1433, 1440, 1533 All w/ Cab or ASN RA13834 w/o Cab, 1540	Water Pump Includes Mounting Gasket Replaces 3757045M92, 3757045M93	AM3757045M91	\$ 100.00	

Belts

Application	Description	Part Number	Retail Price	Core
50, 65, 165, 175, 180, 302, 304 Ref# 186750M1, 532527M1	Fan Belt 0.50" x 5/16" V-Belt	AM07510-00048	\$ 7.00	
175 Gas (Continental)	Fan Belt	AM189789M1	\$ 10.60	
175 Gas (Perkins)	Fan Belt	AM843198M1	\$ 8.75	
175 Diesel BSN 9A40277	Fan Belt	AM186750M2	\$ 10.35	
175 Diesel w/ Gen.	Fan Belt, Alt / Gen Belt	AM190083M1	\$ 7.62	
175 Diesel w/ Alt.	Fan Belt, Alt / Gen Belt	AM513833M1	\$ 10.85	

Prices Subject to Change without Prior Notice. The use of original equipment manufacturer (OEM) part numbers or trademarks, e.g. Case® and John Deere®, are for reference purposes only and for indicating product use and compatibility. Our company and the listed replacement parts contained herein are not sponsored, approved or manufactured by the OEM. All parts are New unless designated Reman in the description.

Massey Ferguson®—Tractor

Application	Description	Part Number	Retail Price	Core
180 Gas & LPG (Continental)	Fan Belt	AM505995M2	\$ 8.00	
180 Gas (Perkins)	Fan Belt	AM186976M1	\$ 8.19	
180 Diesel ASN 9A40277	Fan Belt	AM512951M1	\$ 14.00	
235, 245, 2230, Ind: 20C, 30B, 4500 Ref# 539735M1	Fan Belt 0.50" x 5/16" V-Belt	AM15601-97010	\$ 7.00	
255 Gas BSN 9A211258	Fan Belt	AM531371M1	\$ 11.38	
255 Gas and Diesel (AS4-203)	Fan Belt	AM532527M1	\$ 13.26	
255 (A4-236)	Fan Belt	AM517344M2	\$ 11.66	
285	Fan Belt Set of 2	AM532779M92	\$ 19.00	
298	Fan Belt Set of 2	AM1686616M91	\$ 10.70	
1080 w/o AC	Fan Belt	AM516467M1	\$ 13.59	
1085	Fan Belt Set of 2	AM529900M91	\$ 18.00	
1100 Diesel w/ AC ASN 354UA1332	Fan Belt	AM521398M91	\$ 17.25	
1100 Diesel w/o AC ASN 9B13590	Fan Belt	AM513133M1	\$ 9.27	
1100 Diesel w/ AC & 518995M91 Engine	Fan Belt Set of 2	AM517951M91	\$ 14.98	
1100 Diesel w/ AC S/N 65003753-9B13590	Fan Belt	AM512431M1	\$ 9.85	
1100 w/o AC & 518995M91 Engine	Fan Belt	AM503727M1	\$ 22.60	
1100 Gas & LPG	Fan Belt	AM513116M1	\$ 7.25	
1125	Fan Belt	AM3704187M1	\$ 18.36	
1130 BSN 650003753	Fan Belt	AM503727M1	\$ 22.60	
1130 S/N 650003753-9B13590	Fan Belt	AM512431M1	\$ 9.85	
1150, 1155	Fan Belt Set of 2	AM518506M92	\$ 18.80	
(1500, 1800 BSN 9C002356)	Fan Belt	AM525833M1	\$ 6.37	
(1500, 1800 ASN 9C002356)	Fan Belt, Alt / Gen Belt	AM530330M91	\$ 19.65	
	Water Pump Belt	AM530328M1	\$ 10.00	
2675, 2705	Fan Belt	AM3040950M91	\$ 18.69	
	Alt / Gen Belt, Water Pump	AM3040949M1	\$ 10.85	
2745, 2775, 2805 - Fan Belt not for 2745	Fan Belt	AM1612891M91	\$ 20.50	
	Alt / Gen Belt, Water Pump Set of 2	AM1612892M91	\$ 14.70	
4260, 4270, 4360, 4370, 6235, 6245, 6255, 6260, 6265, 6270, 6280	Fan 56.10" Long Replaces 3808730M1	AM3779379M91	\$ 21.75	
5430	Fan Belt	AM4287320M1	\$ 27.75	
5440	A/C Compressor Belt	AM4351267M1	\$ 20.00	
5445, 5455, 5460, 6445, 6455 - Tier 3	A/C Compressor Belt	AM4351269M1	\$ 28.00	
5460	A/C Compressor Belt	AM4286906M1	\$ 18.50	
5465, 5475, 6465, 6475, 6480, 6485, 6490, 6495, 6497, 6499, 7465, 7475, 7480, 7485, 7490, 7495, 7497, 7499	A/C Compressor Belt	AM4286263M1	\$ 22.20	
5465, 6475	Fan Belt	AM4285560M3	\$ 42.00	
5465, 6485	Fan Belt	AM4282010M1	\$ 37.20	
6445, 6455, 6485, 6490, 6495, 7485, 7490, 7495	Fan Belt	AM3787792M1	\$ 17.80	
6465, 7465	A/C Compressor Belt	AM3789028M1	\$ 14.00	
7614, 7615, 7618, 7619, 7620	Fan Belt	AM4375174M1	\$ 48.00	

Massey Ferguson®—Tractor

Application	Description	Part Number	Retail Price	Core
7614, 7615, 7618, 7619, 7620, 7624, 7626, 8670	A/C Compressor Belt	AM4350583M2	\$ 33.00	
8670, 8690	A/C Compressor Belt	AM4287376M2	\$ 26.15	
8690	Fan Belt	AM4385473M1	\$ 58.00	

Carburetor

Application	Description	Part Number	Retail Price	Core
35, 50, 135, 150, Ind: TO30, TO35	Carburetor, Zenith	AMX82003	\$ 456.00	
65	Reman Carburetor	AM184301M92	\$ 195.00	\$ 100.00
65, 150, 165	Carburetor	AMX82007	\$ 550.00	
135, 230, Ind: TE20, TO20, TO30	Carburetor, Zenith	AMX82002	\$ 508.00	
30, 31, 35, 40, 135, 150, 165, 175, TO35, Ind/Const: 30, 202, 2135, 3165	Tachometer Cable	AM506331M91	\$ 17.50	



Fuel Lift Pumps

Application	Description	Part Number	Retail Price	Core
35, 50, MH50, 135, 150, 2135, 2200, Ind: 200, 202, 203, 205, 2244, 2500	Fuel Lift Pump 2-Bolt Mounting, w/ Glass Bowl	AM4222094M91	\$ 31.00	
65, 165, 3165	Fuel Lift Pump 2-Bolt Mounting, w/ Glass Bowl	AM4222452M91	\$ 40.50	
20, 20C, 30B, 40, 135, 150, 203, 205, 230, 245, 2135	Fuel Lift Pump 2-Bolt Mounting, w/o Glass Bowl	AM3637307M91	\$ 21.00	
130	Fuel Lift Pump	AM4222174M91	\$ 44.00	
165, 255, 285, 298, 698, 1080, 1085, Ind: 30, 40B, 50, 50A	Fuel Lift Pump 2-Bolt Mounting, w/o Glass Bowl	AM4222107M91	\$ 25.00	
170, 180, 282, Ind: 31	Fuel Lift Pump 2-Bolt Mounting	AM4222104M91	\$ 24.00	
175, 180, 255, 265, 275, Landini Built: 184-4, 274-4, 294-4, Ind: 31, 50C, 50D, 60 TLB	Fuel Lift Pump 4-Bolt Mounting, w/o Glass Bowl	AM4222091M91	\$ 33.00	
270, 283, 290, 670, 690, 375, 383, 390, 390T, 398, 3050, 3060, 3065, 3070, Landini Built: 174-4, 194-4, 274-4, 294-4, Ind: 50C, 50D, 50E, 50F, 50H, HX60 TLB	Fuel Lift Pump 4-Bolt Mounting	AM3637290M91	\$ 17.50	
154-4, 254-4, 230, 231, 240, 245, 250, 253, Ind: 20C, 20D, 30B, 30D, 30E, 40E	Fuel Lift Pump 4-Bolt Mounting	AM4222090M91	\$ 29.00	
399, 3090, 3095, 3120, 3120T, 3125, 3140, 3645, 3655, 3660, 6170, 6180, 8120	Fuel Lift Pump 4-Bolt Mounting	AM4222105M91	\$ 33.50	
(471, 481, 492 - Tier 2), (573, 583, 593, 596 ASN BTO2019), 2650, 2660, 2670, 2680, (5425, 5435, 5450 - Tier 3)	Fuel Lift Pump Replaces 4132A018	AM4226937M91	\$ 90.00	
1105, 1135	Fuel Lift Pump 2-Bolt Mounting	AM4222093M91	\$ 33.00	
1114	Fuel Lift Pump	AM4223583M91	\$ 25.00	
1150, 1155	Fuel Lift Pump 2-Bolt Mounting, w/ Glass Bowl	AM3637289M91	\$ 47.50	
4000 Series - 4225, 4235, 4243, 6150	Fuel Lift Pump 4-Bolt Mounting	AM4222106M91	\$ 48.00	

Massey Ferguson®—Tractor

Injection Pumps

All of our injection pumps are disassembled, thoroughly cleaned and inspected. All worn out parts are replaced and the pumps are reassembled with new gaskets. Pumps are tested for leaks and fuel delivery at low idle, high idle, full load, part load and at start up. Any pumps with an automatic advance system has the advance set. As an additional quality check, all pumps are tested with a special oil that will not varnish inside the pump.

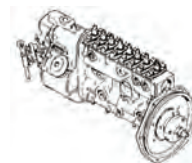

Application	Description	Part Number	Retail Price	Core
4.236 Engine w/ Mech Gov & Advance Device	Reman Injection Pump CAV, Mfg # 3248F440	AMP3248F440	\$ 895.00	\$ 200.00
35	Reman Injection Pump, A3.152 CAV, Mfg # 3230F030, 3243F390	AMP3230F030	\$ 925.00	\$ 200.00
65	Reman Injection Pump, AD4.203 CAV, Mfg # 3240F698, F968	AMP3240F698	\$ 925.00	\$ 200.00
65, 365	Reman Injection Pump, A4.203 CAV, Mfg # 3243F610	AMP3243F610	\$ 925.00	\$ 200.00
135, 150, 203, 205	Reman Injection Pump, AD3.152 CAV, Mfg # 3230F180, F190, F240, F350	AMP3230F180	\$ 925.00	\$ 200.00
165, 255	Reman Injection Pump, AD4.203 CAV, Mfg # 3240F938	AMP3240F938	\$ 925.00	\$ 200.00
175, 180, 265, 270	Reman Injection Pump, AD4.236 CAV, Mfg # 3241F360	AMP3241F360	\$ 925.00	\$ 200.00
230, 240	Reman Injection Pump, AD3.152 CAV, Mfg # 3230F450, F480	AMP3230F450	\$ 925.00	\$ 200.00
235, 245	Reman Injection Pump, AD3.152 CAV, Mfg # 3230F350, 440; 3233F671	AMP3230F350	\$ 925.00	\$ 200.00
250	Reman Injection Pump, AD3.152 CAV, Mfg # 3233F671, 3238F260	AMP3233F671	\$ 925.00	\$ 200.00
254	Reman Injection Pump, AD3.152 CAV, Mfg # 3233F521, 3238F260	AMP3233F521	\$ 925.00	\$ 200.00
255, 670	Reman Injection Pump, A4.236 CAV, Mfg # 3241F350, F360	AMP3241F350	\$ 925.00	\$ 200.00
274	Reman Injection Pump, A4.236 CAV, Mfg # 3241F490	AMP3241F490	\$ 925.00	\$ 200.00
275	Reman Injection Pump, AD4.248 CAV, Mfg # 3241F541	AMP3241F541	\$ 895.00	\$ 200.00
282	Reman Injection Pump, AD4.248 CAV, Mfg # 3241F102	AMP3241F102	\$ 925.00	\$ 200.00
285, 298, 698, 1080, 1085	Injection Pump, A4.318 Internal Splines CAV, Mfg # 3342F410	AMP3342F410-N	\$ 775.00	
285, 1080, 1085	Reman Injection Pump, A4.318 CAV, Mfg # 3342F410	AMP3342F410	\$ 925.00	\$ 200.00
290, 690	Reman Injection Pump, AD4.248 CAV, Mfg # 3241F570	AMP3241F570	\$ 925.00	\$ 200.00
294	Reman Injection Pump, 4.248 CAV, Mfg # 3241F101	AMP3241F101	\$ 925.00	\$ 200.00
298	Reman Injection Pump, 4.318 CAV, Mfg # 3343F010	AMP3343F010	\$ 925.00	\$ 200.00
1080	Reman Injection Pump, A4.318 CAV, Mfg # 3241F240, 3249F240	AMP3249F240	\$ 925.00	\$ 200.00
1100, 1105	Injection Pump, AT6.354 CAV, Mfg # 3263F670, 3362F080	AMP3263F670-N	\$ 770.00	
1130	Reman Injection Pump, AT6.354 CAV, Mfg # 3263090C	AMP1130-DPA	\$ 1075.00	\$ 200.00
1130, 1135	Reman Injection Pump, AT6.354 CAV, Mfg # 3260F288, 3269F920	AMP3260F288	\$ 925.00	\$ 200.00
2675	Reman Injection Pump, A6.354.4 CAV, Mfg # 3269F970; 3362F460, F490	AMP3269F970	\$ 925.00	\$ 200.00

Massey Ferguson®—Tractor

Application	Description	Part Number	Retail Price	Core
2705	Reman Injection Pump, AT6.345.4 CAV, Mfg # 3362F450	AMP3362F450	\$ 925.00	\$ 200.00
2745, 2775, 2805	Reman Injection Pump CAV, Manufacturing # - P5059-2	AMP2745-DPCON	\$ 995.00	\$ 200.00
220, 231, 241, 253, 263, 271, 281, 396, 399, 3075, 3095, 3120, 3125, 3140, (3315, 3325 BSN 326618G), 3645, 3655, 3660, 4225, 4233, 4235, 4240, 4243, 4245, 4253, 4255, 4260, 4263, 4270, 6140, 6150, 6170, 6180, 6235, 6245, 6255, 6265, 6270, 6280, 6290, 8120, 8210, 8220, 8250	Fuel Shut Off Solenoid Replaces 217608A1, 340521A1, 1896464M1	AM218323A1	\$ 20.00	

Injectors

Our remanufactured injectors are disassembled and thoroughly cleaned. The internal components are lapped to ensure there is no leakage. All tips are inspected for hole erosion and opening pressure; and the spray pattern is tested using OEM specifications.

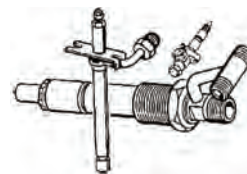

Application	Description	Part Number	Retail Price	Core
1130, 1135	Reman Injector	NBKBL-150S6576	\$ 50.00	\$ 30.00



Turbochargers

Application	Description	Part Number	Retail Price	Core
1105, 1135, 2705 Replaces 1446954M91, 1447152M91, 1447447M91	Turbocharger TO4B51, AiResearch 2 3/4" OD on Intake	AM465740-9001	\$ 425.00	
1130 Engine ASN 354UA1181T, 1135 Replaces 1853324M91	Reman Turbocharger H50807/3LD, Schwitzer	AM181777	\$ 975.00	\$ 200.00
Combines: 750 ASN 1746009413, 760 Replaces 1447462M91	Reman Turbocharger H50908/3LD, Schwitzer	AM181781	\$ 1315.00	\$ 200.00
Combines: 850, 860 Replaces 1447462M91, 1447617M91, 1447677M91	Reman Turbocharger TO4B71, AiResearch	AM465154	\$ 730.00	\$ 200.00



Manifolds and Components

Application	Description	Part Number	Retail Price	Core
35, 50, 135, 150, 230, 235, 245, F40, TO20, TO30, TO35 - w/ Z129 or Z134 Continental Gas Engine	Intake and Exhaust Manifold Manifold Gasket	AM1039258M1 AMX36241	\$ 185.00 \$ 6.50	
30, 165, 3165 - w/ 4 Cylinder Diesel Engine	Exhaust Manifold For Vertical Exhaust Replaces 37781400	AM736218M1	\$ 74.90	
30, 165, 3165 Turf - Diesel	Exhaust Elbow	AM507629M1	\$ 35.00	
50, 50D, 255, 265, 275, 285, 290 - w/ A4-236 or A4-248 Diesel Engine	Exhaust Manifold For Vertical Exhaust Replaces 37781051, VPE9202	AM741764M1	\$ 62.00	
50C, 175 BSN 644000915, 180, 255, 265, 275 - w/ 4 Cylinder Diesel Engine	Exhaust Manifold Replaces 37781321	AM734700M1	\$ 69.66	
135(UK), 230, 231, 240	Exhaust Manifold	AM740221M1	\$ 30.00	
	Manifold Gasket - 2 Required	AMX36242	\$ 10.50	

Massey Ferguson®—Tractor

Application	Description	Part Number	Retail Price	Core
175, 180, 270, 283, 290, 362, Ind: 50E, 50F, 50H, HX60H TLB, Forklifts: 6500, 6800	Exhaust Manifold	AM733206M1	\$ 35.00	
	Manifold Gasket - 2 Required	AMX36243	\$ 12.00	
236 Engine Only - 255	Exhaust Manifold	AM37781051	\$ 62.00	
	Manifold Gasket - 2 Required	AMX36243	\$ 12.00	
(255, 275 - w/ A4-236 or A4-248 Perkins® Diesel Engine) 265, Ind: (50, 50D - w/ A4-236 or A4-248 Perkins® Diesel Engine)	Exhaust Elbow	AM533446M2	\$ 57.50	
410 w/ 292 CID Chevy Engine	Exhaust Manifold	AM71178420	\$ 179.00	
	Manifold Gasket	AMX36236	\$ 15.00	
1100 Diesel Non-Turbo	Exhaust Manifold	AM37782321	\$ 213.00	
	Manifold Gasket Set, 3 Pc.	AMX36244	\$ 68.15	
1105, 1135	Exhaust Elbow Use w/ 3609201M1 Exhaust Sleeve Replaces 30-3159027, 740695M1, 37731881	AM740695M1	\$ 97.50	

Mufflers and Exhaust

Our mufflers are manufactured by experienced craftsmen here in the United States. All mufflers have welded seams. Aluminized steel is used for critical components. These features ensure that our products resist the corrosive effects of air, heat and the by-products of combustion that work to shorten muffler life. Additionally, they are painted either silver or black to cosmetically match its OEM counterpart, as well as provide further protection from the elements.

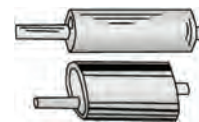

Application	Description	Part Number	Retail Price	Core
35, MH35, TO35, Ind: 202, 203, 204, 205	Exhaust System - Horizontal Bent Tube, Inlet - Plate	AM181600M91	\$ 34.00	
TO20, TO30	Exhaust System - Horizontal Tube, Inlet - Plate	AM181460M91	\$ 36.00	
Universal Tractors	Exhaust Pipe Black Finish, Straight Pipe 4" ID, Overall Length 47.50"	AM400SP	\$ 59.00	
Universal Tractors	Exhaust Pipe Diameter 3.50", Length 48"	AMS312X48	\$ 57.00	
(35, 135 - w/ Gas or Diesel Engine), Ind: (202, 203, 204, 205 - w/ Gas or Diesel Engine)	Muffler Vertical or Horizontal / Round Inlet 3", Length 34"	AM181867M91	\$ 30.00	
35 w/ 3 Cylinder Engine, 135, 148, 150, 230, 240, 245, 250, (255, 265, 275 - Diesel)	Muffler Horizontal Round, Inlet 8", Length 39" Replaces 180364M92, 825698M91, 890476M92	AM890476M91	\$ 42.00	
50, 65 - Diesel	Muffler Round, Inlet 1 3/4", Length 34"	AM187184M91	\$ 34.50	
	Inlet Clamp	CL-134	\$ 4.00	
	Outlet Clamp	CL-134	\$ 4.00	
65 1958-64 w/ Diesel Engine	Muffler Horizontal Round, Inlet 1 3/4", Length 40"	AM186886M91	\$ 37.00	
	Inlet Clamp	CL-134	\$ 4.00	
	Exhaust Pipe 3 Bolt Inlet, Horiz. Length 34", Vertical Length 12"	AM828194M91	\$ 25.00	
70 Gas or Diesel, 1080 Gas (4 Cylinder), 1100 Gas (6 Cylinder)	Inlet Clamp	CL-214	\$ 4.00	
	Rain Cap	RC-7	\$ 14.50	
165, 175, 180 - w/ Loader w/ Perkins® 4-236 or 4-248 Gas or Diesel Engine	Muffler Vertical Round, Inlet 2 1/8", Length 40"	AM194431M91	\$ 40.00	
	Inlet Clamp	CL-214	\$ 4.00	

Massey Ferguson®—Tractor

Application	Description	Part Number	Retail Price	Core
165, 175, 180 - w/o Loader w/ Perkins® 4-236 or 4-248 Gas or Diesel Engine	Muffler Round, Inlet 2 1/8", Length 40"	AM194431M95	\$ 48.50	
	Inlet Clamp	CL-214	\$ 4.00	
230, 235, 245, 255, 265, 275	Muffler Oval, Inlet 2 1/8", Length 37"	AM578090M91	\$ 103.00	
	Inlet Clamp	CL-214	\$ 4.00	
(230, 240, 250, 290* - Gas or Diesel), Ind: (20, 30, 31, 32, 40B, 50 - Gas or Diesel) *Requires 898534M1 Tailpipe when replacing 898535M91 on this model	Muffler Inlet 2.75", Length 39" Replaces 898535M91	AM508825M92	\$ 29.50	
	Inlet Clamp	CL-200	\$ 4.00	
285, 1085	Muffler Oval, Inlet 2 3/4", Length 24"	AM535950M91	\$ 88.00	
	Inlet Clamp	CL-234	\$ 11.00	
	Rain Cap	RC-7	\$ 14.50	
390, 390T, 393, 398	Muffler, Underhood Round, Inlet 3 3/4", Length 16 9/64" Replaces 1694963V5	AM1694963M5	\$ 120.00	
1080 Gas, 1100 Gas	Muffler Round, Inlet 2 3/4", Length 32"	AM513563M92	\$ 44.00	
1080 Gas or Diesel, 1100 Gas	Muffler Oval, Inlet 2 3/4", Length 34"	AM522422M	\$ 103.00	
	Inlet Clamp	CL-234	\$ 11.00	
	Rain Cap	RC-7	\$ 14.50	
1100 Diesel, 1130 Diesel	Muffler Round, Inlet 3 7/16", Length 32"	AM510634M91	\$ 48.00	
	Inlet Clamp	CL-312	\$ 6.50	
	Rain Cap	RC-8	\$ 16.50	
1105 Diesel, 1135 Diesel	Muffler Oval, Inlet 3 7/16", Length 28"	AM528068M92	\$ 127.00	
	Inlet Clamp	CL-312	\$ 6.50	
	Rain Cap	RC-8	\$ 16.50	
TE20, TEA20	Muffler Vertical Round, Inlet 2 5/32", Length 35 5/8"	AM894291M91	\$ 37.00	

Starters

All of our remanufactured starters are disassembled, cleaned and inspected. Almost all units receive new field coils. If it meets OEM specifications the armature is test turned and under cut, otherwise it is replaced with a quality factory remanufactured or new part. Starters with factory solenoids have the solenoids replaced with new parts. The drive is carefully inspected and if it does not meet specifications it is replaced with new or quality factory remanufactured drives.



Application	Description	Part Number	Retail Price	Core
165, 175 w/ Perkins Engine, 180 w/ Perkins Engine, 255, 265, 285, TO20, TO30, TO35, Ind: 30, 35, 2200, 3165 - All w/ Gas Engine	Starter, 6 Volt Delco, Direct Drive, 9 Tooth Ref# 1109457, 181541M91	AM1900347M91	\$ 158.00	
	Starter, 12 Volt Delco 10MT, Direct Drive, 10 Tooth Ref# 518670M91, 772482M91	AM1903105M91	\$ 192.00	
165, 175, 255, 265, 275, 285, 365, 375, 390, 393, 670, 698, 699, 3050, 3060, 3065, 3070, 3075, 4225, 4235, 4240, 4243, 4245, 4253, 4255, 4260, 4265, 4270, 6140, 6150, 8250	Starter Direct Drive, 10 Tooth, 2.80kW, Left Hand Mount Replaces both Hitachi and Delco Units	AM1868285M3	\$ 189.00	
230, 245, 285, 1080, 1085, 1100, 1105, 1130, 1135, Combines: 750, 760, 850, 860	Starter, 12 Volt Delco 37MT, 10 Tooth, Direct Drive, CW Rotation Replaces 1903109V91	AM1903109M91	\$ 315.00	

Prices Subject to Change without Prior Notice. The use of original equipment manufacturer (OEM) part numbers or trademarks, e.g. Case® and John Deere®, are for reference purposes only and for indicating product use and compatibility. Our company and the listed replacement parts contained herein are not sponsored, approved or manufactured by the OEM. All parts are New unless designated Reman in the description.

Massey Ferguson®—Tractor

Application	Description	Part Number	Retail Price	Core
8480, 8650, 8660, 8670, 8680, 8690, 8727, 8730, 8732, 8737	Starter, 12 Volt HD Planetary Gear Reduction, 10 Tooth, 4.20 kW, CW Rotation Replaces 4288993M91, 4288993M92, 4288993M93	AM4288991M4	\$ 425.00	
Combine: 9520	Starter, 12 Volt 11 Tooth, CW Rotation Replaces 84284540	AMV836873457	\$ 345.00	

Distributors

Application	Description	Part Number	Retail Price	Core
35, 50, TO20, TO30, TO35	Distributor 9 Tooth Replaces 1111722, 1111740, 1112570, 1112586	AM182852M91	\$ 115.00	

Air Cleaner Components

Application	Description	Part Number	Retail Price	Core
30, 35, 65, Super 90, Super 95, 253, 263, 271, 281, 282, 362, 365, 375, 390, 390T, 383, 393, 396, 398, 399, 699, 3050, 3060, 3065, 3070, 3075, 3090, 3095, 3120, 3120T, 6140, 6150, 6170, 6180 Replaces 1018554M1, 3639424M1	Large Precleaner Bowl 10.50" Diameter	AMP01-6330	\$ 12.00	
35 w/ A3.152 Perkins® Engine	Air Cleaner Hose	AM890258M1	\$ 17.08	
35, 35X (FE), TO35	Air Cleaner Hose 1.80" & 2.07" ID Replaces 1884897M1	AM826963M1	\$ 8.06	
(35, 65, 765 w/ A3.152, A4.192 or A4.203 Engine), 135UK, FE135, (155, 165 w/ AD4.203 Engine)	Air Cleaner Hose 2" ID	AM898104M1	\$ 8.09	
135 w/ Perkins® Gas Engine, Ind: 20 w/ Perkins® Gas Engine	Air Cleaner Hose 2" ID, 2.38" OD, 10.75" Long	AM521108M1	\$ 39.55	
135UK, 148, 230, 240, 240S, 250, Ind: 20B, 20D, 20E, 20F, 30E	Air Cleaner Hose 1.94" ID, 9" Long	AM1861746M1	\$ 25.64	
165	Air Cleaner Hose 2.25" ID	AM884546M1	\$ 72.97	
165UK, 185	Air Cleaner Hose	AM884545M1	\$ 62.84	
230, 235, 245, Ind: 20C	Air Cleaner Hose 2" & 2.312" ID	AM530781M2	\$ 31.00	
231, 240P	Air Cleaner Hose 2" ID	AM1672724M1	\$ 44.97	
261, 265S, 275UK, 282, 290UK	Air Cleaner Hose 2.25" ID	AM1876307M1	\$ 18.27	
275, 282, 390E	Air Cleaner Hose	AM1686294M1	\$ 39.91	

Alternators





Application	Description	Part Number	Retail Price	Core
383	Alternator Lucas, 12 Volt, 45 Amps, IR/EF, CW Rotation 1-Groove Pulley Replaces 81863039, 81868798, 83961474	AM82857207	\$ 111.00	

Massey Ferguson®—Tractor



















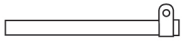

Sensors

Application	Description	Part Number	Retail Price	Core
243, 253, 263, 394, 471, 481, 491, 492, 2210, 2220, 2225, 2230, 2235, 3235, 3315, 3325, 3330, 3340, 3350, 3355, 4215, 4220, 4225, 4233, 4235, 4240, 4243, 4245, 4253, 4255, 4260, 4263, 4265, 4270, 4315, 4320, 4325, 4335, 4345, 4355, 4360, 4365, 4370, 6170, 6180, 6235, 6245, 6255, 6260, 6265, 6270, 6280, 6290, 8120, 8210, 8220	Temperature Sender, Engine Coolant 3/8" BSP Thread Size	AM4223862M1	\$ 31.99	





Tie Rods and Components

Application	Description	Part Number	Retail Price	Core
 35, 135, Ind/Const: 202, 203, 205, 2135	Tie Rod	AM192749MT	\$ 10.00	
 35, 135, 202, 204, 203, 205	Tie Rod 1.156" Long, 0.531" Diameter	AM1754629M91	\$ 23.00	
 35, 135 Early, TEA20, TE20, TO20, TO30, TO35	Drag Link End 3.594" Long, .687" Diameter Left Hand 18 Thread	AM180391M91	\$ 11.50	
 50 Gas SN 528163-533422, 50 Diesel SN 667918-692932, 65 SN 671680-692932, Loaders: 32, 99	Tie Rod 6.50" Long, 0.812" Diameter 16 Right Hand Thread	AM186077M92	\$ 22.00	
 50 BSN 528163, MH50, 65 Gas BSN 671680, 65 Diesel BSN 667918, 765 ASN 526080	Tie Rod, Inner Right Hand 6" Long, 0.812" Diameter 16 Right Hand Thread	AM182519M91	\$ 22.00	
 50, MH50, 65, 85, Super 90 (Standard & Hi-Arch), 135 (Orchard), 150, 165 BSN 643011388, 175 BSN 9A 59594, Ind: 202, 203, 204, 205	Tie Rod, Drag Link End 3.75" Long, .812" Diameter Right Hand 16 Thread	AM182534M91	\$ 14.00	
 50, 65 Gas or Diesel	Tie Rod, Outer Right Hand 14.656" Long, 0.737" Diameter 7 Holes w/ 10° Upward Angle	AM186236M91	\$ 24.00	
 50, 65 Gas or Diesel	Tie Rod, Outer Left Hand 16" Long, 0.737" Diameter 7 Holes w/ 10° Upward Angle	AM186235M91	\$ 24.00	
 50, 65, 150, 165	Tie Rod, Right Hand 15.487" Long, 0.937" Diameter 7 Notches	AM192865M1	\$ 44.00	
 50 SN 528163-533422, 65 Gas SN 671680-192932, 65 Diesel SN 667918-692932, 150	Tie Rod Assembly, Right Hand Includes Inner & Outer Tie Rod Ends and Hardware	AM186145M92	\$ 160.15	
 50 SN 528163-533422, 65 Gas SN 671680-192932, 65 Diesel SN 667918-692932, 150	Tie Rod Assembly, Left Hand Includes Inner & Outer Tie Rod Ends and Hardware	AM186146M92	\$ 86.96	
 165, 168, 175 ASN 724933, 185, 188, 255, 265, 270, 275, 282, 283, 290, 565, 575, 590, 675, 690	Tie Rod, Inner Right Hand 4" Long, 0.812" Diameter 16 Right Hand Thread	AM886802M91	\$ 13.00	
 165, 168, 175, 185, 188, 255, 265, 275, 285, 290, Ind: 30, 31	Tie Rod, Inner Left Hand 4.812" Long, 1" Diameter, Internal Thread	AM1028098M1	\$ 26.00	
 165, 168, 175, 185, 188, 255, 265, 275, 285, 290, Ind: 30, 31	Tie Rod Assembly, Right Hand	AM553326	\$ 55.00	

Massey Ferguson®—Tractor



	Application	Description	Part Number	Retail Price	Core
	165, 168, 175, 185, 188, 255, 265, 275, 285, 290, Ind: 30, 31	Tie Rod Assembly, Left Hand	AM553325	\$ 79.00	
	165, 168, 175, 185, 188, 255, 265, 275, 285, 290, Ind: 30, 31	Inner Tie Rod w/ Clamp 20.125" Long, 0.75" Diameter	AM1028264M1	\$ 28.00	
	165, 168, 175, 185, 188, 255, 265, 275, 285, 290, Ind: 30, 31	Outer Tie Rod 15.00" Long, 0.75" Diameter, Notches on Top	AM1028262M92	\$ 24.00	
	165, 168, 175, 185, 188, 255, 265, 275, 285, 290, Ind: 30, 31	Tie Rod Tube 13.625" Long Inner, Left Hand	AM1028099M91	\$ 14.00	
	180, 185, 1080, 1085	Tie Rod 3.875" Long, 1" Diameter Right Hand 16 Thread	AM1028268M91	\$ 20.00	
	185, 188, 1080, 1085	Tie Rod, Outer Right or Left Hand, 15.487" Long 0.937" Diameter, 7 Notches on Top	AM1028265M91	\$ 38.00	
	233, 245, Ind: 20C	Tie Rod, Inner Left Hand 32.843" Long, 0.937" Diameter 7 Notches On Top	AM1048272M91	\$ 45.00	
	235, 245 Orchard, 2200, Ind: 20C, 30B, 40B, 4500, Forklift: 2200	Tie Rod, Inner Right Hand 15.50" Long, 0.937" Diameter 7 Grooves on Side	AM1044295M91	\$ 26.00	
	235, 245 Orchard, 2200, Ind: 20C, 30B, 40B, 4500, Forklift: 2200	Tie Rod, Outer Right Hand 5.031" Long, 1" Diameter Right Hand 16 Thread	AM1044294M92	\$ 25.00	
	245 (w/ HD Front), 285	Tie Rod 15.50" Long, 0.937" Diameter 7 Grooves	AM1044298M91	\$ 34.00	
	245 (w/ HD Front), 285	Tie Rod, Left Hand 17" Long	AM1044297M91	\$ 39.00	
	245, 285	Tie Rod, Outer Right Hand 3.843" Long, 1" Diameter 16 Right Hand Thread	AM1048273M91	\$ 16.00	
	245 (w/ HD Front), 285	Tie Rod Tube 18.875" Long	AM1044296M91	\$ 36.16	
	1100, 1105, 1130, 1135, 1150, 1155	Tie Rod Right or Left Hand, 16.312" Long 0.937" Diameter, Notched	AM1026382M91	\$ 31.00	
	1100, 1105, 1130, 1135, 1150, 1155 - w/ Western Non-Adjustable Wide Fronts	Tie Rod, Inner Right or Left Hand, 3.875" Long 1.00" Diameter, Right Hand 16 Thread	AM1026383M91	\$ 20.00	
	1100, 1105, 1130, 1135, 1150, 1155	Tie Rod Assembly	AM553330	\$ 98.00	
	1100, 1105, 1130, 1135, 1150, 1155	Tie Rod, Outer Right or Left Hand, 16.312" Long .937" Diameter, 7 Grooves	AM1028095M91	\$ 65.63	
	2675, 2705 - w/ Standard Axle	Tie Rod, Inner 5.094" Long, 1" Diameter Right Hand 16 Thread	AM3045062M91	\$ 18.00	
	2675, 2705 - w/ Standard Axle	Tie Rod, Outer 20.75" Long, 1.375" Diameter 7 Vertical Holes	AM3040676M92	\$ 50.00	
	(2675, 2705 - w/ Heavy Duty Axle), 2745, 2775, 2805	Tie Rod, Inner Right or Left Hand, 21.625" Long 1.125" Diameter	AM3045308M91	\$ 136.23	

Massey Ferguson®—Tractor

Application	Description	Part Number	Retail Price	Core
 (2675, 2705 - w/ Heavy Duty Axle), 2745, 2775, 2805	Tie Rod, Inner Left Hand	AM1626710M92	\$ 40.00	
 (2675, 2705 - w/ Heavy Duty Axle), 2745, 2775, 2805	Tie Rod, Outer Right or Left Hand, 13.25" Long 1.116" Diameter	AM3038564M92	\$ 64.00	
5611, 5612, 5613, (5710, 5711 Tier 4), 5710S, 5710SL, 5711S, 5711SL, 5712S, 5712SL, 5713S, 5713SL - w/ Suspended or Fixed Axle	Tie Rod Assembly Includes Ball Joint	AM7302466803	\$ 155.21	
 TEA20, TO20, TO30, TO35	Tie Rod End 3.25" Long, 0.687" Diameter 18 Right Hand Thread	AM180381M91	\$ 9.00	
30, 165, 178, Ind: 3165	Drag Link Assembly 43.75" Long Replaces 505371M91	AM518434M91	\$ 136.00	
 20D, 20E, 135 Vineyard, 231, 240, 250, 2135	Drag Link End 3.594" Long, 0.687" Diameter 18 Left Hand Thread Replaces 194607M91, 826852M91, 969352M1	AM826752M92	\$ 16.00	

Spindles

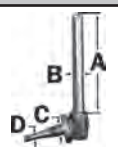
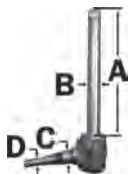
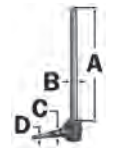
Spindles are forged from high grades of alloy steel, machined and assembled to exact specifications that meet or exceed OEM specifications.

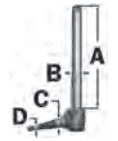
Application	Description	Part Number	Retail Price	Core
 31, 165, 175, 255, 265, 275 - w/ Standard Axle	Spindle A - 12.375	Left or Right Hand AM508571M92	\$ 95.00	
	B - 1.50	Bushing AM183086M1	\$ 5.00	
	C - 1.375	Wheel Bearing Kit WBK-MF-2	\$ 17.00	
	D - 0.75	Wheel Hub AM519278M91	\$ 45.00	
 40, MF50 (Lo-Clearance), 65	Spindle A - 11.625	Right Hand AM182559M92	\$ 65.00	
	B - 1.25	Left Hand AM182560M92	\$ 65.00	
	C - 1.25	Thrust Bearing AM195175M1	\$ 7.00	
	D - 0.75	Bushing AM196060M1	\$ 9.00	
		Wheel Bearing Kit WBK-MF-1	\$ 19.96	
 50, 65, 765, Ind: 40	Spindle A - 18.00	Right Hand AM182557M92	\$ 65.00	
	B - 1.25	Left Hand AM182558M92	\$ 65.00	
	C - 1.25	Bushing AM196060M1	\$ 9.00	
	D - 0.75	Thrust Bearing AM195175M1	\$ 7.00	
		Wheel Bearing Kit WBK-MF-1	\$ 19.96	
 135, 240 BSN A20286	Spindle A - 11.06	Right Hand AM897236M94	\$ 79.00	
	B - 1.245			
	C - 1.375			
	D - 0.75			
 165, 175, 180, 185, 255, 265, 275, 285, 1080	Spindle A - 14.875	Left or Right Hand AM532480M92	\$ 155.00	
	B - 1.50	Bushing AM183086M1	\$ 5.00	
	C - 1.375	Wheel Bearing Kit WBK-MF-2	\$ 17.00	
	D - 0.75			

Massey Ferguson®—Tractor

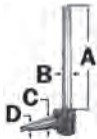
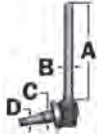
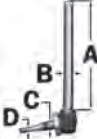
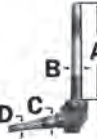
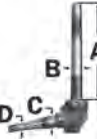
	Application	Description		Part Number	Retail Price	Core	
	165, 175, 180, 185, 1080, 255, 265, 275, 285 - Heavy Duty Hi-Clearance	Spindle	Left or Right Hand	AM553311M1	\$ 246.89		
		A - 15.875		Bushing	AM183086M1	\$ 5.00	
		B - 1.50		Wheel Bearing Kit	WBK-MF-3	\$ 39.00	
		C - 1.796 D - 1.25					
	165, 175, 180, 185, 1080, 255, 265, 275, 285 - Heavy Duty Standard Clearance	Spindle	Left or Right Hand	AM553312M1	\$ 155.00		
		A - 14.875		Bushing	AM183086M1	\$ 5.00	
		B - 1.50		Wheel Bearing Kit	WBK-MF-3	\$ 39.00	
		C - 1.796 D - 1.25					
	165, 175, 180, 255, 265, 275 - Row Crop, 180 (Fixed Tread Western), 1080, 1085 ASN BA49496 (w/ Adjustable Row Crop Axle)	Spindle	Left or Right Hand	AM508572M92	\$ 95.00		
		A - 15.875		Bushing	AM183086M1	\$ 5.00	
		B - 1.50		Wheel Bearing Kit	WBK-MF-2	\$ 17.00	
		C - 1.375 D - 0.75					
	235 BSN 9A210647 w/ Diesel Engine, 245 Orchard ASN 9A253749, Ind: 20C BSN 9A353177, 30B, 30D, 40B BSN 9A326404	Spindle	Right Hand	AM674385M93	\$ 221.23		
		Replaces 674385V93	Left Hand	AM674386M93	\$ 227.60		
		A - 11.875					
		B - 1.495 C - 1.796 D - 1.312					
	TE20, TO20, TO30, TO35, FE35, MF35	Spindle	Right Hand	AM180346M92	\$ 45.00		
		A - 11.00	Left Hand	AM180349M92	\$ 45.00		
		B - 1.25		Bushing	AM180345M1	\$ 2.50	
		C - 1.25		Thrust Bearing	AM195175M1	\$ 7.00	
		D - 0.75		Wheel Bearing Kit	WBK-MF-1	\$ 19.96	
	8745, 8765	Spindle Bushing		AM882327M1	\$ 19.74		





Wheel Hubs and Components

Application	Description	Part Number	Retail Price	Core
35, 50, MH50, 65, TO20, TO30, TO35	Wheel Hub - 6 Bolt Replaces 898085M91, 926942M1	AM180338M92	\$ 85.00	
	Hub Cap w/ Adjustable Front End	AM191142M1	\$ 5.00	
FE135, 135UK, 240UK, 240P, 250UK, 253UK, 360UK, 20DUK, 231UR	Wheel Hub - 6 Bolt	AM886336M1	\$ 32.00	
MF30, MF31, MF40, 65, 85, 88, Super 90, 100, 200, 175, 235, 255 ASN 9A324146, 265 ASN 9A349239, 275 ASN 324137, 285, 1085, 3165	Hub Cap - Threaded Used with 532781M91 and 191520M92 Hubs	AM191495M1	\$ 5.00	
135, 150, 165, 175, 180, 230, 235, 245, 255, 265, 275, 1080, 1085	Wheel Hub - 6 Bolt	AM519278M91	\$ 45.00	
	Hub Cap	AM194621M1	\$ 10.00	
165, 20D UK, 20F UK, 253, 255, 275, 283, 290, 30E UK, 30H UK, 362, 375, 383, 390 UK, 3925, 399	Wheel Hub - 6 Bolt	AM898346M93	\$ 40.00	
	Hub Cap	AM882637M1	\$ 8.50	
298, 375 (Extra Heavy Duty), 398 (Extra Heavy Duty), 399 (Extra Heavy Duty w/ 6-354.4 Engine), 698, 699	Wheel Hub - 6 Bolt	AM1625298M2	\$ 55.00	

Massey Ferguson®—Tractor

Wheel Bearing Kits

Application	Description	Part Number	Retail Price	Core
 20C, 135, 150, 165, 175, 180, 185, 202, 203, 204, 205, 230, 235, 245, 255, 265, 275, 285, 1080, 1085	Wheel Bearing Kit	WBK-MF-2	\$ 17.00	
	Components:			
	Inner Cone	1 LM48548	\$ 6.00	
	Inner Cup	1 LM48510	\$ 4.00	
	Outer Cone	1 LM11949	\$ 2.99	
	Outer Cup	1 LM11910	\$ 1.70	
	Seal	1 AP19920	\$ 4.00	
 35, 40, 50, 65, FE35, TE20, TO20, TO30, TO35	Wheel Bearing Kit	WBK-MF-1	\$ 19.00	
	Components:			
	Inner Cone	1 15123	\$ 6.00	
	Inner Cup	1 15245	\$ 4.00	
	Outer Cone	1 09067	\$ 3.12	
	Outer Cup	1 09195	\$ 2.45	
	Seal	1 AP19745	\$ 11.00	
 40, 165, 175, 180, 185, 202 BSN 306677, 203 BSN 65900300, 204 BSN 342537, 205 BSN 659100150, 255, 265, 275, 285, 1080, 2135 BSN 646992326 - w/ Standard and Hi-Clearance Axles w/ HD Spindle	Wheel Bearing Kit	WBK-MF-3	\$ 39.00	
	Components:			
	Inner Cone	1 25590	\$ 11.00	
	Inner Cup	1 25520	\$ 4.00	
	Outer Cone	1 LM67048	\$ 7.00	
	Outer Cup	1 LM67010	\$ 2.75	
	Seal	1 AP19225	\$ 8.50	

Steering Arms



Application	Description	Part Number	Retail Price	Core
165UK, 175, 245, 255, 265, 285, 3165, Ind: 30, 31	Steering Arm - Right Hand	AM194569M1	\$ 35.00	
	Steering Arm - Left Hand	AM194570M1	\$ 35.00	
165, 175, 3165, Ind: 30, 31	Steering Arm and Shaft, Center 11.875" Long Shaft	AM523112M91	\$ 369.37	
	Center Upper Steering Arm Use w/ AM523112M91 Steering Arm and Shaft, Center	AM514285M1	\$ 166.21	
	Center Lower Steering Arm Use w/ AM523112M91 Steering Arm and Shaft, Center	AM534155M91	\$ 65.00	
261, 270, 282, 283, 290, 670, 690, Ind: MF50E, MF50F, MF50H, HX60H, TLB	Center Steering Arm	AM1676664M1	\$ 45.00	
165 BSN 6430011388, 175 BSN 644002127, 3165 BSN 647001441	Center Lower Steering Arm	AM194567M92	\$ 117.30	
135UK, 240, 35, TO20, TO30, TE20, TEA20, TO35	Steering Arm	AM180350M1	\$ 40.00	
165 BSN 6430011388, 175 BSN 644002127, 3165 BSN 647001441	Center Steering Shaft Crank Arm	AM510336M2	\$ 65.00	
255, 265, 275, 285 - All ASN 9A251072	Center Steering Arm	AM578406M91	\$ 60.00	

Massey Ferguson®—Tractor

Axle Center Tubes and Beams



Application	Description	Part Number	Retail Price	Core
35, 135, 230, 235, TO20, TO30, TO35, Ind: 20, 2135	Front Axle Beam - Swept	AM183219M91	\$ 135.00	

Axle Pivot Assemblies and Pins

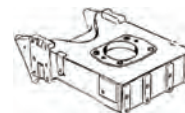

Application	Description	Part Number	Retail Price	Core
50, 65, 150, 165	Front Axle Pivot Support	AM506913M91	\$ 115.00	
175, 178, 255, 265, 270, 275, 290, 675, 690	Front Bolster, 13 5/8" Bolt Pattern	AM1870287M95	\$ 754.00	

Power Steering Cylinders and Components



Application	Description	Part Number	Retail Price	Core
35, 135, TO35	Power Steering Cylinder Kit Includes rack, pin & rod Does not include 175666M1 Seal Kit	AM1041940M91	\$ 618.43	
	Rack Kit Includes rack, pin & rod	AM1751665M1KIT	\$ 176.12	
35, 202, 203, 205, 2135, 2404	Power Steering Cylinder	Right or Left Hand AM192749M92	\$ 337.17	
135, 230, 240, 250	Power Steering Cylinder End	Male AM1851617M2	\$ 27.00	
		Female AM1851618M2	\$ 14.00	
135, 240 BSN A20286, 250, Ind: 20, 20D, 20E, 200 Series, 2135	Power Steering Cylinder	Right Hand AM3401241M91	\$ 155.00	
	Power Steering Cylinder	Left Hand AM3401240M91	\$ 155.00	
	Power Steering Cylinder Seal Kit Use on power steering cylinders AM3401240M91 and AM3401241M91	AM3314663M91	\$ 29.00	
235, 245 Orchard, Ind: 20C, 30B, 40B, 4500	Power Steering Cylinder	Right or Left Hand AM1749213M91	\$ 455.35	
235, 245 Orchard, 2200, Ind: MF20C, 30B, 40B, 4500, Forklift: 2200	Power Steering Cylinder End Used on Power Steering Cylinder AM1749213M91 and AM511562M91	AM1033035M91	\$ 22.00	
(255, 265, 275, 285 ASN 9A349239 w/ Dual Power Steering Cylinders)	Power Steering Cylinder	AM1749246M91	\$ 475.00	
340, 350, 355, 360, 362, 365, 375, 390, 390T, 398, 399	Power Steering Cylinder End	Female Right or Left Hand AM3427168M2	\$ 65.00	
360 Axle BSN 0997, 375, 383, 390, 390T, 393, 396, 398, 399	Power Steering Cylinder End Fits 4WD models w/ tie rod and steering cylinder on right hand side of axle	Male Right or Left Hand AM3426773M3	\$ 19.00	
		Center AM1695045M91	\$ 55.00	
375, 383, 390, 390T, 393, 396, 398, 399 - 2WD w/ Engine BSN P33139	Power Steering Cylinder End	Male AM3595527M91	\$ 50.00	
375, 383, 390, 390T, 393, 396, 398, 399, 3050, 3060, 3065, 3070, 3075, 3090, 3095, 3120, 3120T, 6150	Ball Joint Fits late model 4WD tractors equipped w/ axle numbers AG75, AG85 and AG105, w/ steering cylinder in center of tractor	Center AM1695045M91	\$ 55.00	
		Right or Left Hand AM3426312M1	\$ 55.00	
4245, 4255, 4260, 4270, 4345, 4355, 5435, 5445, 5455, 6235, 6245, 6255 - 4WD	Power Steering Cylinder End 6.102" Long, 0.78"-0.874" Stem Diameter M18x1.50" Right Hand Thread	AM3429938M2	\$ 66.17	

Massey Ferguson®—Tractor

Application	Description	Part Number	Retail Price	Core
5611, 5612, 5613, 5710, 5711, 5712, 5713 - 4WD	Power Steering Cylinder End 8.661" Long, 1.063"-1.193" Stem Diameter M24x1.50" Right Hand Thread	AM7302445042	\$ 99.94	
270, (271, 281 - 2WD Hydrostatic), 283, 290, 670, 690	Power Assist Steering Hose Replaces 1683031M91	AM1683831M91	\$ 34.14	
231, 240, 243, 250, 253, 263, 360, 2625, Ind: 20D, 20F, 30E, 30H, 40E	Front Axle Lube Hose Kit Includes 2 Hoses and Fittings	AM1670913M91	\$ 21.67	
165UK, 175, 178	Power Assist Steering Hose	AM897153M91	\$ 54.87	
271, 281, 282	Power Assist Steering Hose	AM1671228M92	\$ 30.67	



Hydraulic Lift Pumps



Application	Description	Part Number	Retail Price	Core
135, 148, 158, 165, 168, 175, 178, 185, 188, 230, 240, 250, 265, 275, 290, 298, 550, 565, 575, 590, 675, 690, 698, 698T, 699	Hydraulic Lift Pump 2 Port	AM1686766M91	\$ 430.00	
230, 240, 250, 265, 275, 290, 298, 550, 565, 575, 590, 675, 690, 698, 698T, 699, 1080	Hydraulic Lift Pump 1 Port Replaces 531607M93	AM1686765M91	\$ 510.00	



Hydraulic Pumps







Application	Description	Part Number	Retail Price	Core
TE20 ASN 83271, TEA20 BSN 285933, TO20, TO30	Hydraulic Pump Rebuild Kit Replaces PTO shaft bushing, PTO shaft gasket, base gasket, safety valve, sump plug gasket, side gasket, piston, side plate gasket, cam block and includes chamber repair kit	AMX47114	\$ 258.00	
205, 205-4	Hydraulic Pump Keyed Shaft, 4-Bolt Mount Replaces 34150-36100, 34150-36102, 34150-36103, 34150-36110, 35110-76101, 35180-36100, 37150-36100, 37150-36110	AM35110-76100	\$ 463.16	
399 w/ 6.354.4 & Internal Cold Start Valve	Hydraulic Pump	AM3597420M91	\$ 425.00	
2640, 2675, 2705, 2745, (2775, 2805 ASN 9R0465), 3505, 3525, 3545, 3630, 3645, 3650, 3655, 3660, 3670, 3680, 3690, 8120, 8140, 8150	Hydraulic Pump Replaces 3790722M1	AM3038730M2	\$ 624.00	

Hydraulic Pump Components



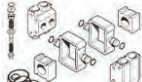

Application	Description	Part Number	Retail Price	Core
 135, 150, 165, 175, 180, Ind: 20, 30, 31, 40F, 200 Series, 2135, 2200, 3165	Camshaft 10 Spline	AM1809105M91	\$ 85.00	
 20, 20C, 20D, 20F, 30, 30D, 30E, 40, 40E, 50C, 50D, 50E, 135, 150, 165, 175, (230, 245, 265, 275, 285 BSN 9A349239), 231, 235, 240, 240P, 250, 255, 261, 270, 282, 283, 290, 298, 360, 399 w/ A6-354 or 1006.6 Engine, 670, 690, 698, 699, 1085	Camshaft 21 Spline	AM1684621M1	\$ 70.00	

Prices Subject to Change without Prior Notice. The use of original equipment manufacturer (OEM) part numbers or trademarks, e.g. Case® and John Deere®, are for reference purposes only and for indicating product use and compatibility. Our company and the listed replacement parts contained herein are not sponsored, approved or manufactured by the OEM. All parts are New unless designated Reman in the description.











Massey Ferguson®—Tractor

	Application	Description	Part Number	Retail Price	Core
	All Models with Ferguson Style Scotch-Yoke Lift Pump	Camshaft Bushing	AM1664491M2	\$ 6.00	
	All Models with Ferguson Style Scotch-Yoke Lift Pump	Camshaft Needle Bearing	AM1000251M1	\$ 7.19	
	All Models with Ferguson Style Scotch-Yoke Lift Pump	Cam Follower	AM180933M1	\$ 11.31	
	35, 50, MH50, 65, 85, 765, F40, FE35, TO35, Ind: 202, 203, 204, 205, 302, 304, Super 90	Control Valve Assembly Fits Mark I Pumps	AM189427M92	\$ 16.50	
	135, 148, 150, 165, 168, 175, 178, 180, 185, 188, Ind: MF20, MF30, 31, 40, 50, 202, 203, 204, 205, 302, 304, 2135, 3165	Control Valve Assembly Fits Mark II Pumps	AM1862486M96	\$ 54.50	
	135, 148, 150, 165, 168, 175, 178, 185, 188, 230, 231, 235, 240, 240P, 245, 250, 253, 255, 261, 265, 275, 282, 283, 285, 290, 298, 350, 355, 360, 362, 365, 375, 390, 390T, 383, 398, 399, 565, 575, 590, 595, 670, 675, 690, 698, 698T, 699, 1085	Control Valve Assembly Fits Mark III Pumps	AM1681789M91	\$ 34.50	
	135, 150, 165, 175, 230, 231, 235, 240, 245, 250, 253, 255, 261, 265, 270, 275, 282, 283, 285, 360, 362, 375, 390, 390T, 393, 396, 398, 399, 670, 690, 698, 699, 1085	Hydraulic Pump Repair Kit Mark III Pumps, 0.098" Chamber Bore Includes (2) 1868435M3 w/ Valves, (2) 1860038M1, (1) 180924M2, (1) 180925M2, (4) 897493M1 and (1) 1810680M92	AM1810860M93	\$ 195.00	

Power Steering Pumps

	Application	Description	Part Number	Retail Price	Core
	30, 31, 50C, 50D, 165, 175, 255, 265, 275, 6500 Forklift	Power Steering Pump, Reservoir Style 3-Bolt Mount, 14 Tooth	AM523092M91	\$ 235.00	
	30, 40B, 50A, 165 ASN 9A112205, 203, 204, 255, 256, 265, 3165	Power Steering Pump, Reservoir Style 3-Bolt Mount, 13 Tooth	AM523090M91	\$ 240.00	
	35, 50, 60, 135, 150, 202, 204, 2135 - w/ Continental Gas Engine	Power Steering Pump Style A	AM544443M91	\$ 685.00	
	35, 50, 135, 150 (Diesel Engine Only), 240 BSN A20286, 230, 231, 235, 245, 250, Ind: 20, 20C, 20D, 20E, 20F, 30B, 30E, 30H, 40, 200 Series, 2135, 2200, 2500, 4500	Power Steering Pump	AM773126M92	\$ 175.00	
	35, 50, 135, 230, 231, 235, 240, 245, 250, 253, Ind: 20, 20C, 30B, 30D, 30E, 40, 203, 205, 2135, 2200	Power Steering Pump	AM527904M91	\$ 267.87	

Massey Ferguson®—Tractor

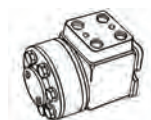

Application	Description	Part Number	Retail Price	Core
 154-4, 174-4, 184-4, 254-4, 274-4, 294-4	Power Steering Pump 11 cc, Left Hand, CCW Rotation 1/8" Tapered Shaft Replaces 1825210M91	AM3539858M91	\$ 184.00	
 165, 168, 175, 178, 185, 188, 265, 275, 285, 290, 565, 575, 590	Power Steering Pump 2-Bolt Mount	AM1666727M92	\$ 285.00	
 180	Power Steering Pump, Reservoir Style	AM523093M91	\$ 608.20	
 184-4, 274-4, 294-4	Power Steering Pump CW Rotation Replaces 5179724, 8273970, 1825212M91	AM3539857M91	\$ 184.00	
 255, 265, 275	Power Steering Pump, Reservoir Style 2-Bolt Mount	AM897147M91	\$ 210.00	
 285, 1080, 1085	Power Steering Pump, Reservoir Style	AM523089M91	\$ 237.50	
 362, 365, 375, 383, 390, 390T, 398	Power Steering Pump, Reservoir Style 2-Bolt Mount Replaces 3774616M92	AM1696665M91	\$ 500.00	
 375, 383, 390, 390T, 398	Power Steering Pump, Tandem	AM3774612V91	\$ 441.50	
 396, 399 (w/ 1006.6 Engine)	Power Steering Pump, Tandem	AM3774613M91	\$ 460.00	
 399 (w/ A6-354.4 Engine)	Power Steering Pump, Tandem	AM3595383M91	\$ 415.00	



Power Steering Orbit Motors

Application	Description	Part Number	Retail Price	Core
30B, 40B, 50C, 255, 265, 275	Power Steering Orbit Motor Replaces 532192M93	AM532192M92	\$ 540.00	
261, 375, 390, 390T, 393, 396, 398, 399	Power Steering Orbit Motor	AM1695445M91	\$ 375.00	

Transmission Components















Application	Description	Part Number	Retail Price	Core
 35, 50, 65, 70, 80, 85, 88, Super 90, 165, 180, 135, 150, 175, 202, 204, 203, 205, 302, 304, 1100, 1105, 1130, 1135, 1150, 1155, 1500, 1505, 1800, 1805, 2135, 2200, 2500, 3165	Spider Gear	AM181275M1	\$ 46.00	
 35, MF50, MH50, 65, 135, 150, 165, 175, 180, 230, 235, 240, 245, Ind: MF20, 20C, 2135, 3165, 2200, MF30, 31	1st Gear 44 Tooth, 18 Splines Fits Tractors w/ 8 Spd Transmissions	AM1682688M1	\$ 60.00	

Massey Ferguson®—Tractor





Massey Ferguson®—Tractor

	Application	Description	Part Number	Retail Price	Core
	135, 150, 165, 175, 240, 253, 282, 360, 375, 390, Ind: 20, 31, 30, 50F, 50H	3rd Gear 41 Tooth Fits Tractors w/ 8 Spd Constant Mesh Transmissions	AM1682690M1	\$ 70.00	
	35, 65, 135, 148, 155, 158, 165, 168, 175, 178, 185, 188, 240, 250, 265, 275, 285, 290, 550, 565, 575, 590, 765	Multipower or Non-Multipower Transmissions	AM520700M4	\$ 78.50	
	135, 150, 165, 175, 180, 1080, 1085, 230, 235, 245, 255, 265, 275, 282, 285, 240, 250, 253, 261, 283, 290, 298, 360, 375, 390, 390T, 393, 396, Ind: MF20, 20C, 20D, 20F, 30, 31, 40, 40B, 40E, 50D, 50C, 50E, 50H	2nd Gear 36/46 Tooth, 18 Splines Fits Tractors w/ Multi-Power, 6 Spd, 8 Spd, w/ Non-Synchro Transmissions	AM1682691M1	\$ 70.00	
	TO35, MF35, MF65, 135, 150, 165, 175, 180, 230, 231, 35, 240, 245, 250, 253, 255, 261, 265, 270, 275, 282, 283, 285, 290, 298, 360, 375, 390, 390T, 393, 396, Ind: 200 Series, MF20, 20C, 20D, 20F, 2135, 3165, 30, 31, 40, 40B, 40E, 50C, 50D, 50E, 50F, 50H	2nd Gear 23 Tooth Fits Tractors w/ 6 Spd Trans, 8 Spd Trans or Multi-Power Transmissions	AM180419M1	\$ 19.50	
	TO35, MF35, MF50, MF65, 135, 150, 165, 175, 230, 231, 235, 240, 245, 250, 253, 255, 265, 270, 275, 282, 283, 285, 290, 298, 360, 375, 390, 390T, 393, 396, Ind: 200 Series, MF20, 20C, 20D, 20F, 2135, 2200, MF30, MF40, 40B, 40E, 50, 50C, 50D, 50E	3rd Gear 33 Tooth Fits Tractors w/ 6 Spd Trans, 8 Spd Trans or Multi-Power Transmissions	AM180415M1	\$ 33.22	
	35, 65, 765, 135, 148, 158, 165, 168, 185, 188, 230, 240, 250, 265, 275, 290, 350, 355, 360, 362, 365, 375, 390, 390T, 550, 565, 575, 590, 675, 1080	Reverse Gear 13/21 Tooth Fits Tractors w/ 6 Spd Trans, 8 Spd Trans or Multi-Power Transmissions	AM183040M1	\$ 55.00	
	TO35, MF35, MF50, MH50, MF65, 135, 150, 165, 175, 180, 1080, 230, 235, 240, 245, Ind: 200 Series, MF30, 2135, 3165, 2200	Countershaft 15 Tooth Fits Tractors w/ 6 Spd Transmissions	AM183054M92	\$ 32.97	
	135, 150, 165, 175, 1085, 231, 240, 250, 253, 261, 283, 235, 245, 255, 265, 270, 275, 282, 285, 290, 298, 360, 362, 375, 390, 390T, 393, 396, Ind: MF20D, 20F, 40B, 50C, 50D, 40E, 50E	Countershaft 15 Tooth, 17/20 Spline Fits Tractors w/ 8 Spd Transmissions	AM906472M2	\$ 110.00	
	30, 35, 50, 65, 135, 148, 150, 155, 158, 165, 168, 175, 178, 180, 185, 188, 235, 240, 245, 250, 265, 270, 275, 285, 290, 298, 550, 565, 575, 590, 1080, 1085	Countershaft For Multipower Transmissions	AM189391M92	\$ 259.63	
	TO35, 35, 50, 65, 135, Ind: 2135, 2200, 3165	Countershaft 10 Spline, 17 Tooth, 20 Spline Fits Tractors w/ Single Clutch and Trans PTO	AM183085M1	\$ 95.00	
	253, 360, 362, 375, 390, 390T, 393, 396, 398, 399, 670, 690, 698, 699	Countershaft Fits Tractors w/ 12 Spd Synchromesh Transmissions	AM1677827M3	\$ 125.00	
	35, 65, 765	Mainshaft For Multipower Transmissions	AM189440M1	\$ 132.50	
	30, 135 Early, 148, 150, 155, 158, 165, 168, 175, 180, 185, 188, 235, 240, 245, 250, 255, 265, 275, 285, 290, 550, 565, 575, 590, 1080, 1085	Mainshaft 18 Tooth, 22 Splines Fits Tractors w/ 6 Spd and Multi-Power Transmission	AM1682542M1	\$ 120.00	
	135, 150, 165, 175, 180, 230, 235, 240, 245, Ind: 200 Series, 20, 20C, 30, 31, 3165	Mainshaft 11.844" Long, 18 Splines, 5 grooves Fits Tractors w/ 6 Spd Transmissions	AM1682663M1	\$ 100.00	

Massey Ferguson®—Tractor

Application	Description	Part Number	Retail Price	Core
 135, 150, 165, 175, 231, 240, 250, 253, 235, 255, 360, 375, 1085, Ind: 20, 20D, 20F, 30, 40, 40B, 40E	Mainshaft 13.44" Long, 18 Splines Fits Tractors w/ 8 Spd Transmissions	AM1687643M1	\$ 95.00	
 265, 275, 285, 255, 270, 282, 261, 283, 290, 298, 375, 390, 390T, 393, 396, 1085 ASN FD101, Ind: 50E, 50F, 50H, HX60H TLB	Mainshaft 13 7/16" Long, 22 Spline	AM1687642M1	\$ 90.00	
 253, 360, 362, 375	Mainshaft Fits Tractors w/ 8 Spd Synchro-Shuttle Transmissions, 12 Spd Synchromesh Transmissions or 12 Spd Synchromesh w/ Normal Duty Epicyclic Unit	AM1671459M2	\$ 95.00	
 360, 375, 390, 390T, 393, 396, 398, 399, 670, 690, 698, 699	Mainshaft 22/31 Tooth Fits Tractors w/ 12 Spd Synchromesh Transmissions	AM1662224M2	\$ 125.00	
 Ind: 30, 65, 150, 165, 175, 180, 255, 265, 275, 285, 1080, 1085	Input Shaft 25, 33 & 10 Tooth Fits Tractors w/ Multipower Transmissions	AM516523M92	\$ 125.00	
 285, 1085 ASN 22864	Pinion Shaft 25 Spline Fits Tractors w/ 8 Spd Transmissions	AM532061M1	\$ 175.00	
 TO35, 35, 50, 135, 150, 230, 235, 240, 245, Ind: 20, 20C, 2135, 2200	Input Shaft 18 Tooth Fits Tractors w/ 6 Spd Transmissions	AM1669325M2	\$ 125.00	
 TO35, 35, 50, 135, 150, 230, 235, 240, 245, Ind: 200 Series, 20, 20C, 2135, 2200	Main Drive Gear 50 Tooth Fits Tractors w/ 6 Spd Transmissions	AM181799M1	\$ 64.00	
 135, 150, 231, 235, 240, 245, 250, Ind: 20, 20C, 20D	Main Drive Gear 50 Tooth Fits Tractors w/ 8 Spd Transmissions	AM906468M1	\$ 60.00	
 100, 200 & 300 Series	High-Low Shift Fork	AM897065M2	\$ 28.67	
 35, 50, MH50, 65, 135, 150, 165, 175, 180, 230, 235, 245, 255, 265, 270, 275, 285, 290, 298, 1080, 1085, F40, FE35, TO35, Ind: 20, 20C, 20D, 30, 31, 50F, 202, 203, 204, 205, 2135, 2200, 3165	Shift Fork	AM180437M1	\$ 36.00	
 253, 360, 362, 375, 390, 390T, 393, 396, 398, 399, 670, 690, 698, 699	Reverse Idler Gear 14/21 Tooth	AM1688127M1	\$ 30.00	
 TO35, 35, 50, 65, 85, 88, Super 90, Ind: 20, 2135	High-Low Shift Lever	AM185804M1	\$ 12.86	
 253, 360, 362, 375, 390, 390T, 393, 396, 398, 399, 670, 690, 698, 699	2nd Pinion 20 Tooth, Fits Tractors w/ 12 Spd Synchromesh Transmissions	AM1687430M1	\$ 55.00	
 253, 360, 362, 375, 390, 390T, 393, 396, 398, 399, 670, 690, 698, 699	3rd Pinion 33 Tooth, Fits Tractors w/ 12 Spd Synchromesh Transmissions	AM1617923M3	\$ 56.00	

Massey Ferguson®—Tractor

Application	Description	Part Number	Retail Price	Core
 135, 148, 150, 155, 168, 175, 185, 188, 240, 240P, 265, 275, 282, 375, 383, 390, 565, 575, Ind: 20, 30, 31, 50H, 158	3rd Pinion 28 Tooth, 20 Splines, 4.35" Diameter Fits Tractors w/ 8 Spd Transmissions	AM964916M1	\$ 40.00	
 175, 180, Ind: MF30, 40, 50, 50A, 2200, 2500, 200 Series	Planetary Shift Coupler Use w/ AM1886634M91 Planetary Assembly	AM184770M3	\$ 45.00	
 255, 265, 270, 275, 282, 283, 285, 290, 298, 1080, 1085, 670, 690, 698, 699, 375, 390, 390T, 393, 396, 398, 399, Ind: MF30, 30B, 30D, 30E, 40, 40B, 50A, 50C, 50D, 50E, 50F, 50H, 60 TLB, Forklifts: 2500, 4500, 6500	Planetary Shift Coupler Use w/ AM1870538M93 Planetary Assembly	AM1866557M2	\$ 45.00	
 175, 180, Ind: MF30, 40, 50, 50A, 2200, 2500, 200 Series	Planetary Carrier Assembly	AM1886634M91	\$ 200.00	
 255, 265, 270, 275, 282, 283, 285, 290, 298, 1080, 1085, 670, 690, 698, 699, 375, 390, 390T, 393, 396, 398, 399, Ind: MF30, 30B, 30D, 30E, 40, 40B, 50A, 50C, 50D, 50E, 50F, 50H, 60 TLB, Forklifts: 2500, 4500, 6500	Planetary Carrier Assembly Heavy Duty	AM1870538M93	\$ 185.00	
65, 135 Gas, 230, 231, 235, 240, 245, 250, 340, 350, 355, 360, 362, 365	Transmission Coupler 3.08125" Long	AM1871924M1	\$ 40.20	

Hollow PTO Drive Shafts



Application	Description	Part Number	Retail Price	Core
35 Transmission ASN (CQ16563 w/ Multi-Power), 50 Transmission ASN CQ16563 (w/ Multi-Power), 65 (1700-540 Transmission w/ Multi-Power), 135 BSN 9A11664 (w/ Multi-Power), 150 (Early w/ Multi-Power), 165 (Early w/ Multi-Power), FE35 ASN 307136 (w/ Multi-Power), FE135 (w/ Multi-Power)	Hollow PTO Drive Shaft 10 Spline, 19 Tooth	AM191500M1	\$ 155.00	
135, 150, 165 BSN 130773 (w/ Standard Trans), 175, Ind: MF20, MF30, MF31	Hollow PTO Main Drive Shaft 10 Spline, 17 Tooth Shaft for 8-Speed Transmissions	AM906919M91	\$ 110.00	
135, 150, 165, 175, 180 - w/ Multi-Power Transmissions	Hollow PTO Main Drive Shaft 10 Spline, 17 Tooth	AM899332M1	\$ 148.00	
(135, 150, 165, 165UK, 235, 245, 255, 265, 270, 275, 275UK, 282 - w/ 8-Speed Transmission), 148, 155, 168, 185, 188, 240, 250, 283 Brazil, Ind: 20, 20C, 30, 31, 40, 40B, 50C, 50D, 50E, 158	Hollow PTO Main Drive Shaft 25 Spline, 17 Tooth Replaces 1868530M91	AM1868531M1	\$ 95.00	
1080, 1085	Hollow PTO Drive Shaft 10 Spline, 25 Tooth	AM516499M93	\$ 195.00	
135, 150, 165, 235, 245, 255, 265, 275, 285, 290 w/ Manual Transmission	Hollow PTO Main Drive Shaft 25 Spline, 17 Tooth Replaces 1868528M91	AM1868528M92	\$ 220.00	



PTO Shaft Housings

Application	Description	Part Number	Retail Price	Core
35, 50, 65, 135, 150, 165, 175, 180, 230, 235, 240, TO35, Ind: 20, 20C, 30, 31, 50F, 200 Series, 2135, 2200, 3165	PTO Shaft Housing Fits Tractors with 6-Speed Transmissions	AM1867223M1	\$ 75.00	

Massey Ferguson®—Tractor

Application	Description	Part Number	Retail Price	Core
35, 135 - Early Models w/ 6 Speed Transmissions	PTO Shaft Housing	AM180428M3	\$ 46.00	
65, 175, 265, 275, 285, 1080, 1085	PTO Shaft Housing, Rear	AM1860889M1	\$ 170.00	
135, 165, 185, 230, 240, 250, 265, 275, 285, 290, 340, 350, 355, 360, 365, 375, 390, 390T	PTO Shaft Housing Fits Tractors with 8-Speed Transmissions (Constantmesh, Synchromesh and Synchromesh Shuttle)	AM1860890M91	\$ 80.00	
135, 150, 165, 175, 180, 230, 231, 235, 240, 245, 250, 253, 255, 265, 270, 275, 282, 283, 285, 290, 298, 360, 375, 390, 390T, 393, 398, 670, 690, 698, 699, 1080, 1085, Ind: 200 Series, 20, 20C, 20D, 20E, 20F, 30, 30B, 30D, 30E, 30H, 31, 40, 40B, 40E, 50C, 50D, 50E, 2135, 3165	PTO Shaft Bearing Housing Use with AM1867081M1 and AM1868533M1 PTO Drive Shafts	AM899331M1	\$ 30.00	



PTO Gears

Application	Description	Part Number	Retail Price	Core
MF20, MF30, 31, 135, 150, 165, 175, 180, 202, 203, 240, 2315, 2200, 3165	PTO Drive Gear 53 Tooth, 15 Spline Replaces 899329M1	AM1867820M1	\$ 140.00	
135, 150, 165, 230, 240, 245, 255, 265, 270, 275, 282, 283, Ind: 20C, 30, 31, 40, 40B, 50C, 50D, 50E	PTO Drive Gear 53 Tooth, 21 Spline Fits tractors w/ single speed PTO	AM1868532M1	\$ 80.00	
230, 231, 240, 240P, 240S, 245, Ind: MF20, 20C, 20D	PTO Driven Gear 32 Tooth, 21 Spline Fits tractors w/ Live PTO	AM532906M4	\$ 90.53	
235, 240, 245, 250, 253, 255, 261, 265, 270, 275, 282, 283, 290, 360, Ind: MF20F, 30, 30B, 30D, 30E, 40, 40B, 40E	PTO Driven Gear 38 Tooth, 21 Spline Fits tractors w/ Live PTO	AM532907M1	\$ 60.00	



PTO Clutch Components

Application	Description	Part Number	Retail Price	Core
253, 263, 362, 365, 375, 383, 390, 396, 398, 399	PTO Clutch Assembly Replaces 4200050M91	AM3612562M94	\$ 382.00	
135, 150, 165, 175, 180, 235, 245, 255, 275, 280, 285, 1080, 1085, Ind: 20C, 30, 31, 40B, 50C	PTO Clutch Drum	AM515875M92	\$ 329.50	
1100, 1105, 1130, 1135, 1150, 1500, 1505, 1800, 1805	Friction Disc, PTO 57 Tooth, 3.457" ID, 5.05" OD 3 Required	AM523552M1	\$ 12.00	

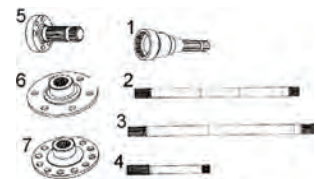

PTO Shafts and Hubs

Img	Application	Description	Part Number	Retail Price	Core
1	35, 50, 65, 135, 150, 165, 175, 180, TO35, Ind: 20, 30, 31, 40, 200 Series, 2135, 2200	PTO Shaft - 540 RPM 22.75" Long, 10 Splines For Tractors w/ Live PTO	AM181204M92	\$ 59.00	
1	135, 150, 165, 175, 230, 235, 255, 265, 275, Ind: 20, 21, 30, 40	PTO Shaft - 540 RPM 24" Long, 21 Spline For Tractors w/ Live PTO and Dry Brakes	AM1868557M93	\$ 100.00	

Massey Ferguson®—Tractor

Img	Application	Description	Part Number	Retail Price	Core
1	165UK, 230, 231, 235, 240, 245, 250, 253, 255, 261, 265, 270, 275, 282, 290, 360, 375, 390, Ind: 20, 20C, 20D, 20E, 20F, 30, 30B, 30C, 30D, 30E, 31, 40, 40B, 40E, 50C, 50D, 50E	PTO Shaft - 540 RPM 24.125" Long, 21 Spline	AM3599003M91	\$ 95.00	
1	285, 1080, 1085	PTO Shaft - 540 RPM 9.147" Long, 36 Spline	AM518529	\$ 423.84	
2	1100 Trans BSN DY101, 1130 Trans BSN DY101, 1150	PTO Drive Shaft 27" Long, 17 Spline	AM508894M2	\$ 371.35	
2	1100 Late, 1130 Late, 1150	PTO Drive Shaft 27.375" Long, 17 Spline	AM514181M1	\$ 302.68	
3	1105, 1135, 1155	PTO Drive Shaft 33.06" Long, 17 Spline	AM528009M1	\$ 343.78	
4	135, 150, 165, 175, 180, 285, 1080, 1085, Ind: 20, 30, 31, 200 Series, 2135, 3165	PTO Drive Shaft 10/15 Spline	AM1867081M1	\$ 80.00	
4	135, 150, 165, 230, 231, 235, 240, 245, 250, 253, 255, 265, 270, 275, 282, 283, 285, 290, 298, 360, 375, 390, 390T, 393, 398, 670, 690, 698, 699, Ind: 20, 20C, 20D, 20E, 20F, 30, 30B, 30D, 30E, 30H, 31, 40, 40B, 40E, 50C, 50D, 50E	PTO Drive Shaft 16" Long, 21/21 Spline	AM1868533M1	\$ 80.00	
4	1100, 1105, 1130, 1135, 1150, 1155	PTO Drive Shaft 11.575" Long, 17/21 Spline	AM503433M1	\$ 120.00	
5	1105, 1135	PTO Shaft - 1000 RPM Bolt-on style	AM677496	\$ 77.00	
6	1100, 1130	PTO Hub Flywheel Mounted, 6 Bolt, Heat Treated Steel Replaces 33471492A	AM736954M1	\$ 190.00	
7	1105, 1135, 1155	PTO Hub Flywheel Mounted, 12 Bolt, Heat Treated Steel	AM740635M1	\$ 190.00	
NI	285, 1080, 1085 - w/ Multipower Transmission	PTO Drive Shaft	AM1808810M92	\$ 145.00	
NI	TE20, TO20, TO30	PTO Output Shaft Converts 1 1/8" to 1 3/8" Splines Replaces 9N70038, 18116938	AM9N710B	\$ 85.00	
NI	TE20, TO20, TO30	PTO Shaft Kit	AMX59102	\$ 128.50	
NI	1100, 1105, 1130, 1135, 1150, 1155	Coupler 17 Spline, Use w/ 503433M1, 508897M1, 514181M1 or 528009M1 Shaft	AM516006M3	\$ 35.96	
NI	2640, 2675, 2705, 2745, 2775 ASN 9R0451, 2805	PTO Shaft, 1000 RPM 11.543" Long 21/24 Spline	AM1610239M3	\$ 128.21	
NI	20, 30, 31, 35, 40, 50, 65, 135UK, 150, 165UK, 175, 178, 180, 230, 235, 255, 265, 275, 2135, Combine: 31	PTO Housing Seal Retainer	AM180465M1	\$ 22.00	

PTO Adapters

Application	Description	Part Number	Retail Price	Core
Tractors up to 70HP	PTO Adapter Small 540 to 1000 Spline Changes PTO from 1 3/8" x 6 spline to 1 3/8" x 21 spline and extends the PTO shaft 4 1/8"	AMX59112	\$ 40.00	
Tractors up to 70HP	PTO Adapter Small 1000 to 540 Spline, 6 3/8" Overall Length Reduces PTO from 1 3/8" x 21 spline to 1 3/8" x 6 spline and extends the PTO shaft 4 1/8"	AMX59108	\$ 40.00	
Tractors up to 100HP	PTO Adapter Large 1000 to 540 Spline, 7 1/2" Overall Length Reduces PTO from 1 3/4" x 20 spline to 1 3/8" x 6 spline and extends the PTO shaft 4 5/8"	AMX59109	\$ 70.00	

Massey Ferguson®—Tractor

Application	Description	Part Number	Retail Price	Core
Tractors up to 100HP	PTO Adapter Large 1000 to Small 1000 Spline, 7" Overall Length Changes PTO from 1 3/4" x 20 Spline to 1 3/8" x 21 Spline and extends the PTO shaft 4 5/8"	AMX59110	\$ 70.00	

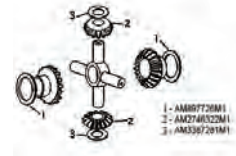

Differentials and Components

Application	Description	Part Number	Retail Price	Core
NI 20E, 20F, 30, 30B, 30D, 30E, 30H, 31, 40, 40B, 40E, 50, 50A, 50C, 50D, 50E, 65, 135, 150, 165, 175, 180, 205, 205-4, 220, 235, 240, 245, 250, 255, 261, 265, 270, 275, 282, 283, 285 ASN 9A349239, 290, 298, 360, 375, 390, 390T, 399 w/ 6.354.4 or 1006.6 Engine, 670, 690, 698, 699, 1085 - w/ Wet Brakes	Differential Case Assembly	AM882783M92	\$ 195.00	
1 135, 148, 158, 165, 168, 175, 178, 185, 188, 230, 240, 250, 265, 275, 285, 290, 298, 340, 350, 355, 360, 362, 365, 375, 390, 390T, 398, 399, 550, 565, 575, 590, 595, 675, 690, 698, 699, 3050, 3060, 3065, 3070, 3080, 3090	Differential Side Gear Thrust Washer Use w/ AM885518M2 Differential Side Gear	AM897726M1	\$ 7.00	
2 135, 148, 158, 165, 168, 175, 178, 185, 188, 230, 240, 250, 265, 275, 285, 290, 298, 340, 350, 355, 360, 362, 365, 375, 390, 390T, 398, 399, 550, 565, 575, 590, 595, 675, 690, 698, 699, 3050, 3060, 3065, 3070, 3080, 3090	Differential Pinion Gear 10 Tooth, 85 mm	AM2746322M1	\$ 27.00	
3 135, 148, 158, 165, 168, 175, 178, 185, 188, 230, 240, 250, 265, 275, 285, 290, 298, 340, 350, 355, 360, 362, 365, 375, 390, 390T, 398, 399, 550, 565, 575, 590, 595, 675, 690, 698, 699, 3050, 3060, 3065, 3070, 3080, 3090	Pinion Gear Thrust Washer	AM3387281M1	\$ 1.50	



Brakes and Components

Application	Description	Part Number	Retail Price	Core
35, 50, 135, 150, 230, 231, 235, 240, 245, TO20, TO30, TO35, Ind: 30, 40, 200 Series, 2135, 2200, 3165	Brake Drum	AM827707M5	\$ 65.00	
30, 31, 40, 50, 65, 85, 88, 90, 135, 150, 135, 175, 180, 203, 205, 302, 304, 356, 2500, 3165	Brake Disc, Bonded 27 Spline, 7.125" OD x 4" Replaces 1753117M91	AM1021314M1	\$ 17.00	
30, 31, 40, 135, 165, 175, 180, 235, 255, 265, 275, 285, 1080	Brake Disc, Bonded 27 Spline, 8.875" OD x 6"	AM1044526M1	\$ 25.00	
35, 135, 230, 240	Brake Lining Kit External Dry Brakes Kit Includes (4) Brake Linings and Mounting Rivets	AM1851062M91	\$ 40.00	
35, 135, 148, 230, 240, 340, 350, 355, 550	Brake Shoe Dry Brakes Sold Individually, (2) Required per Side	AM1810517M92	\$ 35.00	
240 BSN 20286, 245, 250, 253, 255, 261, 265, 270, 275, 282, 283, 285, 290, 298, (375, 390, 398 BSN B18008), 399 BSN V39466, 670, 690, 698	Brake Actuator Assembly Wet Brakes	AM1860963M92	\$ 46.00	
65, 85, 88, Super 90, 135, 150, 165, 175, 180, Ind: 30, 31, 40, 50, 200 Series, 2200, 2500, 3165	Brake Actuator Return Spring 7" Dry Brakes Use w/ AM764805M92 Actuator	AM1005510M1	\$ 1.15	
240 BSN 20286, 245, 250, 253, 255, 261, 265, 270, 275, 282, 283, 285, 290, 298, (375, 390, 398 BSN B18008), 399 BSN V39466, 670, 690, 698	Brake Actuator Return Spring 9" Wet Brakes Use w/ AM1860963M92 Actuator	AM1853148M1	\$ 1.75	

Massey Ferguson®—Tractor

Application	Description	Part Number	Retail Price	Core
65, 135, 150, 165, 175, 180, 1080, Ind: 30, 31, 40, 50, 200 Series, 2200, 2500, 3165	Brake Rod 7" Brake Disc	AM184334M1	\$ 26.86	
231, 240, Ind: 20D, 50F, 50H, HX60H TLB	Brake Shoe Spring, Short	AM1890319M1	\$ 6.00	
	Brake Shoe Spring, Long	AM1850217M1	\$ 5.00	
2620, 2625, 2640, 2645, 2680, 2685, 2720, 2725, 3050, 3060, 3065, 3070, 3075 ASN C340006, 3085, 3095 ASN C280041, 3115, 3120, 3125, 3140, 3630, 3635, 3645, 3650, 3655, 3660 Bendix w/ Dynashift™, 3670, 3680, 3690, 6110, 6120, 6130, 6140, 6150, 6160, 6170, 6180, 6190, 8110, 8120, 8130, 8140, 8150, 8160	Brake Master Cylinder	AM1613986M4	\$ 180.00	

Brake Pinion Shafts



Application	Description	Part Number	Retail Price	Core
2745, 2775, 2805	Brake Pinion Shaft 12 Tooth	Right Hand AM1612123M3	\$ 237.43	

Manual Steering Gearbox Assemblies



Application	Description	Part Number	Retail Price	Core
35, 135	Manual Steering Gearbox Assembly Right and Left Hand Steering Arms Included OEM steering wheel does not work on this assembly, Use AM1691798V1 Steering Wheel	AM1673663M1	\$ 525.00	
	Steering Wheel	AM1691798V1	\$ 17.50	

Steering Shafts



Application	Description	Part Number	Retail Price	Core
20, 35, 156, 202, 203, 204, 205	Manual Steering Shaft Left Hand, 6 Tooth	AM180558M1	\$ 110.00	
35, 135 BSN 641016186, TO35	Steering Shaft with Nut	AM180538M91	\$ 227.50	
35 UK, 135 BSN 400000 UK, FE35 UK, FE135 UK	Steering Shaft with Nut 21.00" Long	AM1850003M92	\$ 50.00	
135UK ASN 400000	Steering Shaft	AM1867192M91	\$ 60.00	
135 ASN 641016186	Steering Shaft with Nut	AM1031344M91	\$ 222.00	
20D, 20E, 30E, 231, 240, 240P, 240S Turkey, 250	Steering Shaft - Power Steering 22.50" Long	AM1890727M91	\$ 70.00	
35X FE, 135 UK, 240 ASN 522354, 240S Turkey	Top Rocker Shaft	AM1850017M1	\$ 39.41	
35 French, 135UK, (231S, 240S, 241 - Turkey)	Bottom Rocker Shaft	AM1861704M1	\$ 151.24	
165 UK, 175 UK ASN 724936, 178 ASN 724936, 265S, 275 UK, 282, 290 UK	Vertical Power Steering Shaft 13.475" Long, 1.87" Diameter	AM1676665M1	\$ 45.00	

Massey Ferguson®—Tractor

Drawbars and Components

All of our drawbars are cut, drilled and heat-treated to exact design and specifications that meet or exceed OEM specifications.



Application	Description	Part Number	Retail Price	Core
35	Drawbar 3" x 1.375" x 42.50", (2) Holes at 1.125" & 3.25" from Front Replaces 83902378, C9NN805A	AMD3NN805A	\$ 256.00	
35, 50, 65, 135, 150, 165, 235, 245, 255, 265, 275, TO35, Ind: 20C, 30B, 40B, 202, 205	Drawbar 2" x 1.125" x 35.75", (3) 1.031" Diameter Holes: 1.25", 3.25" & 5.25" from Front	AM531468M1	\$ 90.00	
40E, 50E, 275, 375, 383, 390, 393, 398, 399	Drawbar - Offset 3.75" x 1.50" x 33.13" w/ 1.25" Offset, (2) 1.031" Diameter Holes: 1.25" & 5.78" from Front Pin, 0.88" Offset Bend 11.50" from Rear	AM1869060M1	\$ 173.00	
50, 65, 135, 150, 165, Ind: 20	Drawbar - Offset 2.00" x 1.125" x 39.24" w/ 3" Offset	AM184629M1	\$ 81.05	
245, 285, 1080, 1085	Drawbar - Offset 2.50" x 1.50" x 39.25" w/ 1.25" Offset & 1.375" Offset Bend, (2) 1" Diameter Holes: 1" & 6" from Front Pin Replaces 516975M1, 516975M2	AM516975M3	\$ 150.00	
245, 285, 1085	Drawbar - Offset 2.50" x 1.50" x 39.25" w/ 4" Offset, (2) 1.031" Diameter Holes: 1.25" & 6.25" from Front Replaces 579181M1	AM579181M2	\$ 304.86	

Drawbar Assemblies



Application	Description	Part Number	Retail Price	Core
35, 50, 65, 135, 230, 240 Early, 250 Early	Drawbar Assembly, Standard Includes Drawbar Support/Pivot, Drawbar, Hammer Strap (Clevis) and Pins	AM670553	\$ 195.00	
240, 250, 270, 290, Ind: 20E	Drawbar Assembly, Heavy Duty Includes Drawbar Support/Pivot, Drawbar, Hammer Strap (Clevis) and Pins	AM670554	\$ 295.00	

Lift Link Assemblies and Components



Application	Description	Part Number	Retail Price	Core
20, 20C, 20D UK, 20F UK, 30, 30B UK, 30D UK, 30E UK, 40B UK, 40E UK, FE35, FE135 Coventry, 135, 135UK, 150, 165, 175, 202 Workbull, 203, 204 Workbull, 205, 230, 231 URSUS, 240 POL, 240 UK, 245, 250 UK, 255, 265, 275, 285, 302, 304, 2135, 2200	Leveling Box Assembly w/ Fork Right Hand	AM1660373M92	\$ 60.00	
	Leveling Box Fork	AM897659M1	\$ 20.00	
35, 50, 135, 150, 245, TO35	Lift Rod Assembly, Left Hand Replaces 9N564B, 182544M92, 81801642	AM1884720M1	\$ 40.00	
65, 175, 265HD, 275, 365, 375, 575, 675	HD Leveling Box Assembly w/ Fork Right Hand	AM1863053M94	\$ 95.00	
	HD Leveling Box Assembly w/o Fork Right Hand	AM1864977M92	\$ 80.00	
	Leveling Box Fork	AM1861392M3	\$ 35.00	

Massey Ferguson®—Tractor

Application	Description	Part Number	Retail Price	Core
65, 165, 175, 180, 240, 245, 250, 255, 262, 285, Ind: 203, 205, 3165	Leveling Box Assembly w/ Fork Right Hand	AM1884760M94	\$ 75.00	
	Leveling Box Assembly w/o Fork Right Hand	AM505446M92	\$ 70.00	
	Leveling Box Fork	AM893405M3	\$ 25.00	
255, 265, 270, 275, 282, 283, 285, 290, 298, 1080, 1085	Leveling Box Assembly w/ Fork Right Hand	AM1660438M92	\$ 106.00	



Quick Hitches

Application	Description	Part Number	Retail Price	Core
Cat II	Quick Hitch, 4" x 6" Beam 36" Wide, Includes 1 1/8" Mounting Pins and Adapter Bushings	AMX741020	\$ 565.00	
Cat III	Quick Hitch, 4" x 6" Beam 38" Wide, Includes 1 7/16" Mounting Pins	AMX741022	\$ 565.00	
Cat III	Quick Hitch, 4" x 6" Beam 44" Wide, Includes 1 7/16" Mounting Pins	AMX741021	\$ 565.00	

Lower Lift Links



Application	Description	Part Number	Retail Price	Core
35, 50, MH50, 135, TO35	Lower Lift Link, Cat I Rigid, 30.50" Long, 7/8" Hole	Right Hand AM182633M91	\$ 99.94	
		Left Hand AM182632M91	\$ 95.18	
135, 240, 240S, Ind: 20D	Lower Lift Link, Cat II Rigid, w/ Removable Ball 35.50" Long	Right Hand AM1869290M91	\$ 202.62	
		Left Hand AM1869289M91	\$ 80.00	
165, 175, 250, 253, 360, 362	Lower Lift Link, Cat II Rigid, w/ Removable Ball 38.50" Long, 1 1/8" Hole	Right Hand AM886452M94	\$ 125.00	
		Left Hand AM886451M94	\$ 125.00	
375, 390, 390T, 398, 399	Lower Lift Link, Cat II Rigid, 40.00" Long	Right Hand AM1660262M93	\$ 110.00	
	Replace both arms at the same time when replacing 2 Pc. Lift Arms to 1 Pc. Lift Arms	Left Hand AM1660263M93	\$ 110.00	
(365, 390, 390T, 398 - 09/1996 and Later), 4225, 4235, 4245, 4255, 4260, 4270, 4325, 4335, 4345, 4355, 4360, 4370, (6245, 6255 BSN K101027 and ASN K344000), 6265, 6270 BSN K101027	Pull Arm Latch, Cat II For Flat/Hook Style Pull Arm Replaces 3904032M91, 33471600	Right or Left Hand AMAL117720	\$ 55.00	
(6235, 6245, 6255 SN K101027-K344000), (6265, 6270 ASN K101026), 6465, 6475, 6480, 8210, 8220, 8240, 8250, 8260 01/2001 and Later	Pull Arm Latch, CAT III For Flat/Hook Style Pull Arm Replaces 3903314M91, 86017137, CH167802	Right or Left Hand AMAL117727	\$ 60.00	
Models that have Lift Links with Removable Ball	Lift Arm Replacement Ball, Cat II 1 1/8" Hole Use w/ AM886451M94, AM886452M94, AM1869289M91 or AM1869290M91 Lift Arm w/ Removable Ball	AM886429M1	\$ 7.00	
30, 65 Hi-Clearance, (165, 170, 180 BSN 9A130003)	Lower Lift Link Adapter	Right Hand AM885984M1	\$ 60.00	
		Left Hand AM885985M1	\$ 60.00	

Massey Ferguson®—Tractor



Hydraulic Lift Components

Application	Description	Part Number	Retail Price	Core
35, 40, 50, 65, 85, 135, 150, 165, 175, 180, 230, 231, 235, 240, 250, 253, 255, 265, 270, 275, 282, 283, 285, 290, 360, 362, 375, 383, 390, 398, 399, Ind: 20, 20C, 20D, 20F, 30, 30B, 30D, 30E, 31, 40, 40B, 40E, 50C, 50D, 50E, 202, 203, 204	Dual Hydraulic Remote Valve Kit Includes Valve, Couplers, Levers and Hoses	AM677421	\$ 475.00	
35, 50, 65, 135, 150, 165, TO35, Ind: 202, 203, 204, 205	Hydraulic Lift Cylinder 3" Diameter, 7.937" Long 9/16" Mounting Studs Use w/ AM184443M91 Piston and (3) AM184447M1 Rings	AM184442M1	\$ 115.00	
135, 150, 165, 230, 231, 235, 240, 240P, 245, 250, 265, 282, Ind: 20, 20C, 20D, 20E, 20F, 30, 30E, 40, 40E, 2135, 2200, 3165	Hydraulic Lift Cylinder 3 1/8" Diameter Uses AM1665737M91 Piston	AM897560M3	\$ 125.00	
245, 261, 265, 265S, 270, 275, 283, 290, 298, 670, 690, 698, 699, Ind: 20C, 30B, 30D, 40B, 50C, 50D, 50E	Hydraulic Lift Cylinder 3.375" Diameter Use with AM1665738M91 Piston	AM1671082M1	\$ 120.00	
35, 50, 65, 135, 150, 165, TO20, TO30, TO35, Ind: 202, 203, 204, 302, 304	Hydraulic Lift Arm, Right or Left Hand 37 Spline, 1.80" ID Replaces 182587M1	AM180910M1	\$ 50.00	
TO20, TO30	Hydraulic Lift Cylinder	AM829382M1	\$ 65.00	
35, 50, 65, 135 (Early w/ 3" Lift Cylinder Piston), (150, 165 - w/ 3" Lift Cylinder Piston), TO35,	Hydraulic Lift Shaft 37 End Splines, 42 Middle Splines	AM184359M2	\$ 65.00	
(135, 150, 165 w/ 3 1/2" Lift Cylinder), 175, 180, 230, 231, 235, 240, 245, 250, 253, 261, 265, 270, 275, 282, 283, 285, 290, 298, 360, 362, 375, 390, 390T, 393, 396, 398, 399, 670, 690, 698, 699	Hydraulic Lift Shaft 53 Fine and 1 Regular Middle Splines 49 Fine and 1 Regular End Splines	AM897567M3	\$ 85.00	
135, 135UK, 150, 165, 165UK, 175, 178, 230, 235, 255, 285, 3165, Ind: 20, 20C, 30, 40, 175, 2135	Hydraulic Draft Support	AM1884283M1	\$ 35.00	
135UK, 165UK, 230, 231, 235, 240, 245, 250, 253, 255, 265, 270, 275, 282, 283, 290, 298, 360, 362, 375, 383, 390, 393, 396, 398, 399, 670, 698, 699, Ind: 20, 20C, 20D, 20E, 20F, 30, 30B, 30D, 30E, 40, 40B, 40E, 50C, 50D, 50E, 390T	Hydraulic Draft Support	AM1870240M1	\$ 35.00	
35, MH50, 65, 135, 150, 165, TO35, Ind: 200 Series, 2135	Piston 3" Diameter Uses (3) AM184447M1 Rings	AM184443M91	\$ 35.00	
	Ring Used with AM184443M91 Piston	AM184447M1	\$ 4.29	
135, 150, 165, 230, 231, 235, 240, 240P, 245, 250, 265, 282, Ind: 20, 20C, 20D, 20E, 20F, 30, 30E, 40, 40E, 2135, 2200, 3165	Piston w/ Seal Ring Kit 3 1/8" Diameter	AM1665737M91	\$ 22.00	
135, 150, 165, 230, 235, 240, 245, 250, 253, 255, 265, 275, Ind: 20, 20C, 20D, 20F, 30, 30B, 30E, 40, 40B, 40E, 50C, 202, 203, 204, 205, 302, 304, 2135, 3165	Lift Cylinder Piston Seal Kit Includes Seal and O-Ring Use w/ AM1665737M91 Piston, 3 1/8" Diameter	AM2528203K1	\$ 9.74	
245, 261, 265, 265S, 270, 275, 283, 290, 298, 670, 690, 698, 699, Ind: 20C, 30B, 30D, 40B, 50C, 50D, 50E	Piston with Rings 3 3/8" Diameter	AM1665738M91	\$ 53.00	
245, 261, 265, 270, 275, 283, 290, 298, 670, 690, 698, 699, Ind: 20C, 30B, 30D, 40B, 50C, 50D, 50E	Seal Ring Kit Teflon O-Ring Kit For Late Style 3 3/8" Piston	AM1665684M91	\$ 5.00	
135, 150, 165, 175, 180, 230, 231, 235, 240, 245, 250, 255, 261, 265, 270, 275, 282, 283, 285, 290, 298, 670, 690, 698, 699, 1080, 1085, Ind: 20, 20C, 20D, 20E, 20F, 30, 30B, 30D, 30E, 31, 40, 40B, 40E, 50C, 50D, 50E, 202, 203, 204, 205, Backhoe-Loaders: 2135, 2200, 3165	Connecting Rod 8.25" Long	AM886410M1	\$ 20.00	

Prices Subject to Change without Prior Notice. The use of original equipment manufacturer (OEM) part numbers or trademarks, e.g. Case® and John Deere®, are for reference purposes only and for indicating product use and compatibility. Our company and the listed replacement parts contained herein are not sponsored, approved or manufactured by the OEM. All parts are New unless designated Reman in the description.

Massey Ferguson®—Tractor

Application	Description	Part Number	Retail Price	Core
135, 150, 165, 175, 180, 230, 231, 240, 245, 250, 253, 255, 261, 265, 270, 275, 282, 283, 290, 360, 362, 375, 390, 390T, 393, 396, 670, 690, Ind: 20C, 20D, 20E, 20F, 30, 30B, 30D, 30E, 40, 40B, 40E, 50C, 50D, 50E, 202, 203, 204, 205, 2135, 2200, 3165	Position Control Link Assembly Draft Control Link Assembly	AM1661918M91 AM1660324M91	\$ 26.00 \$ 35.00	
35, 50, 65, 135, 150, 165, 230, 235, 245, TO35, Ind: 20, 20C, 30, 40, 202, 203, 204, 205, 2135, 2200, 3165	Rocker Link Rocker Link Bushing - Left Hand Rocker Link Bushing - Right Hand Control Spring Head	AM180973M2 AM180974M1 AM181982M1 AM180972M2	\$ 21.50 \$ 6.18 \$ 6.00 \$ 32.31	
135, 165, 175, 180, 230, 231, 235, 240, 245, 250, 253, 255, 261, 265, 270, 275, 282, 283, 290, 298, 360, 362, 375, 390, 390T, 393, 396, 398, 399, 670, 690, 698, Ind: 20, 20C, 20E, 20F, 30, 30B, 30D, 30E, 31, 40, 40B, 40E, 50C, 50D, 50E	Control Spring Head	AM1863389M1	\$ 40.00	
135, 150, 165, 175, 178, 188, 180, 185, 188, 230, 235, 240, 245, 250, 255, 265, 270, 275, 282, 285, 290, 298, 341, 350, 352, 355, 360, 362, 365, 372, 375, 390, 390T, 398, 399, 550, 565, 575, 590, 670, 675, 690, 698, 698T, 699, 1080, 1085, Ind: 20D, 20F, 30D, 30E, 40B, 40E, 50C, 50D, 50E, 202, 203, 204, 205, 2135, 3165	Control Spring Plunger Replaces 866348M2	AM898136M1	\$ 21.50	
35, 50, 65, 135, 150, 165, 180, 230, 231, 235, 240, 245, 250, 253, 255, 261, 265, 270, 275, 282, 283, 290, 298, 360, 362, 375, 390, 390T, 393, 396, 398, 399, 670, 690, 698	Rubber Boot	AM887654M2	\$ 3.00	
35, 50, 65, 135, 150, 165, 180, 230, 231, 235, 240, 245, 250, 253, 255, 261, 265, 270, 275, 282, 283, 290, 298, 360, 362, 375, 390, 390T, 393, 396, 398, 399, 670, 690, 698, TO35, Ind: 20, 20C, 20E, 20F, 30, 30B, 30D, 30E, 31, 40, 40B, 40E, 50C, 50D, 50E, 202, 203, 204, 205, 2135, 2200, 3165	Control Spring Retainer Nut Control Spring Control Spring Seat	AM180979M2 AM182582M1 AM182581M1	\$ 8.50 \$ 37.00 \$ 10.50	
65, 135 (Early), 150, 165, 175, 180, Ind: 30, 31, 202, 203, 204, 205, 3165	Control Beam Rubber Mount	AM184555M1	\$ 6.00	
MH50, 135, 150, 165, 175, 202, 203, 204, 205, 220, 230, 235, 240, 245, 250, 255, 265, 275, 283, 285, 290, 298, 302, 304, 356, 360, 362, 365, 375, 383, 390, 393, 396, 398, 399, 670, 690, 698, 699, 1080, 1085, F40, Super 90, TO35, Ind: 20, 20C, 20D, 20F, 30, 30B, 30D, 30E, 30H, 31, 35, 40, 40B, 40E, 50, 50A, 50C, 50D, 60, 65, 85, 88, 2135, 2200, 3165	Hydraulic Cover Cap	AM180908M1	\$ 19.00	



Toplink Assemblies

Application	Description	Part Number	Retail Price	Core
285, 1080, 1085	Toplink Bracket	AM516912M92	\$ 52.00	

Front Weights and Weight Brackets

Application	Description	Part Number	Retail Price	Core
20, 2135	Weight Bracket Replaces 893555M1, 899628M92	AM899628M91	\$ 200.00	

Massey Ferguson®—Tractor



Side Panels

Application	Description	Part Number	Retail Price	Core
30, 31, 150, 165, 175, 3165	Side Panel	Right Hand	AM194840M1	\$ 34.00
		Left Hand	AM194841M1	\$ 44.32

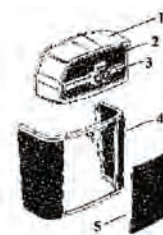

Front Grilles, Nose Cones and Components

Item	Application	Description	Part Number	Retail Price	Core
1	20, 30, 135, 150, 165, 175, 180, 2135, 3165	Nose Cone (w/o Screen, Bar & Emblem) Replaces only metal caps	AM194200M2	\$ 120.00	
2	20, 30, 135, 150, 165, 175, 180, 2135, 3165	Grille Screen	AM194236M	\$ 18.00	
2	135, 165, 175, 178 UK	Grille Screen	AM883159M1	\$ 9.00	
2	255, 265, 275, 285	Grille Screen	AM532260M92	\$ 69.00	
3	20, 30, 135, 150, 165, 175, 180, 2135, 3165	Bar & Emblem	AM523970M91	\$ 20.00	
4	150, 165, 175, Ind: 30, 31, 3165	Wrap Around Grille	AM506319M	\$ 130.00	
5	150, 165, 175, 180, 1080, Ind: 30, 31, 3165	Front Grille Door	AM194181M	\$ 79.00	
5	135 UK	Front Grille Door	AM1882984M92	\$ 25.00	
NI	375, 383, 390, 390T, 393, 396, 398, 399	Front Grille Replaces 1695426M96	AM3701923M91	\$ 120.00	
NI	255, 265, 275, 285	Bottom Grille Door	AM532234M91	\$ 60.00	
NI	135	Lower Front Grille	AM897821M1	\$ 25.00	

Fenders

Fenders are painted with a primer coat unless otherwise noted.



Application	Description	Part Number	Retail Price	Core
35, 135, TE20, TO20, TO30	Fender w/ Bracket Clamshell Style Fender Right or Left Hand	AM180707M92	\$ 90.00	

Fuel Tanks



Application	Description	Part Number	Retail Price	Core
135 w/ Cont. Gas	Fuel Tank	AM189209M93	\$ 291.00	
240, 250, 253, Ind: 20D, 20E, 30E, 30H, 40E	Fuel Tank Requires 1661794M92 Fuel Sender, 5-Bolt	AM3762589M91	\$ 165.00	



Massey Ferguson®—Tractor









Steering Wheels and Caps

Application	Description	Part Number	Retail Price	Core
30E, 35*, 135*, 200, 240, 250, TO35* *Only fits these models when used w/ AM1673663M1 Manual Steering Gearbox Assembly	Steering Wheel 40 Spline Center	AM1691798V1	\$ 17.50	
30E, 200, 240, 250	Steering Wheel Cap	AM1684894M92	\$ 5.00	
35, 135	Steering Wheel	AM1671945M1	\$ 37.00	
150, 165, 175, 178, 230 w/ Gas Engine ASN 9A243032 or Diesel Engine ASN 9A349239, 235 Engine SN 9A207044-9A214238, 255, 265, 275, 282, 285, 1500, 1505, 1800, 1805	Steering Wheel 36-Spline Hub Replaces 192234M2, 508460M2, 525681M2	AM894737M1	\$ 29.00	
360, 362, 375, 383, 390, 390T, 393, 396, 398, 399	Steering Wheel w/ Cap 15" Diameter, 36-Spline Hub	AM3595931M1	\$ 34.00	
35, 40, 50, 65, 85, 88, Super 90, 135, 35, 40, 50, 65, 85, 88, Super 90, 135, TE20, TE35, TO20, TO30, Ind: 20, 100, 202, 203, 204, 205, 303, 356, 2135	Steering Wheel 17 5/8" Diameter, Keyed Hub, 11/16" Shaft	AM180576M1	\$ 23.00	







Lighting

Application	Description	Part Number	Retail Price	Core
 4707, 4708, 5610, 6614, 6615, 6616, 7614, 7615, 7616, 7618, 7620, 7622, 7624, 7626, 7714, 7715, 7716, 7718, 7719, 7720, 7722, 7724, 7726, 8650, 8660, 8670, 8680, 8690, 8727, 8730, 8732, 8735, 8737 Replaces 3788699M93, 4291311M91	LED Conversion Light Front Handrail Mount 5.75" x 3.75" Oval Light 2900 Lumens, 35 Watts, 2.90 Amps For 12 Volt to 24 Volt Systems Includes Bracket and Connectors	AMTL5650	\$ 95.00	
	LED Conversion Light Front Handrail Mount 5.75" x 3.75" Oval Light 2900 Lumens, 35 Watts, 2.90 Amps For 12 Volt to 24 Volt Systems Includes Bracket and Connectors	AMAH207788	\$ 76.00	
 5425, 5435, 5445, 5450, 5455, 5460, 5465, 5470, 5475, 5480, 5609, 5610, 5611, 5612, 5613, 6350, 6360, 6445, 6455, 6460, 6465, 6475, 6480, 6485 Replaces 3788699M93, 4291311M91	LED Conversion Light Rear Fender Mount 5.75" x 3.75" Oval Light 2900 Lumens, 35 Watts, 2.90 Amps For 12 Volt to 24 Volt Systems Includes Bracket and Connectors	AMTL5650	\$ 95.00	
	LED Conversion Light Rear Fender Mount 5.75" x 3.75" Oval Light 2900 Lumens, 35 Watts, 2.90 Amps For 12 Volt to 24 Volt Systems Includes Bracket and Connectors	AMAH207788	\$ 76.00	
 135, 150, 165, 175, 180, 235, 245, 255, 265, 275, 285, 1080, 1085, 1100, 1105, 1130, 1135, 1150, 1155, 2640, 2675, 2705, 2745, 2775, 2805, 3505, 3525, 3545, 4WD: 1500, 1505, 1800, 1805 Replaces 505282M91, 505281M91, 509652M91, 509651M91	LED Trapezoid Light Fender Mount 4.50" Sealed Beam Round Light 2800 Lumens, 40 Watts, 3.30 Amps For 12 Volt to 24 Volt Systems Rear Stud Mount w/ Built-In Heat Sink Includes Both Long and Short Rubber Bezels	AMTL2060	\$ 95.00	
	Headlight Sealed Beam, 12 Volt, 2-Wire	AMRE25126	\$ 45.00	







Massey Ferguson®—Tractor

Application	Description	Part Number	Retail Price	Core
 (4225, 4235, 4240, 4245, 4255, 4260, 4265, 4270, 4325, 4335, 4355, 4360, 4370, 6140, 6150, 6170, 6180, 6190, 6235, 6245, 6255, 6265, 6270, 6280, 6290, 8120, 8140, 8150, 8160, 8210, 8220, 8240, 8250, 8260, 8270, 8280 - w/ High Visibility Cab) Replaces 3713134M91	LED Headlight Floodlight/Spotlight Combo 7.25" x 3.25" x 3.25" Rectangle Light 3500 Lumens, 40 Watts, 3.30 Amps For 12 Volt to 24 Volt Systems	AMTL9090	\$ 105.00	
	LED Headlight Floodlight/Spotlight Combo 7.25" x 3.25" x 3.25" Rectangle Light 3500 Lumens, 40 Watts, 3.30 Amps For 12 Volt to 24 Volt Systems Replaces 3713134M91, AZ41570	AMAX41570	\$ 84.00	
 135	Halogen Floodlight, Sealed Beam 4.50" Diameter Round Light 2-Terminal Connection For 12 Volt Systems Replaces A47179, AR104119, E3NN15330AA	AMH7606	\$ 13.25	
 Universal Equipment	LED Floodlight All-Position Light 4.25" x 4.25" Square Light 2650 Lumens, 48 Watts, 4 Amps For 12 Volt to 24 Volt Systems Includes Mounting Bracket and Stainless Steel Hardware	AMTL105F	\$ 95.00	
 Universal Equipment	LED Floodlight All-Position Light 6.25" x 1.75" Rectangle Light 1300 Lumens, 18 Watts, 1.50 Amps For 12 Volt to 24 Volt Systems Includes Mounting Bracket and Stainless Steel Hardware	AMTL118F	\$ 50.00	
 Universal Equipment	LED Floodlight All-Position Light 5" Round Light 3200 Lumens, 40 Watts, 3.30 Amps For 12 Volt to 24 Volt Systems Includes Mounting Bracket and Stainless Steel Hardware	AMTL180	\$ 89.00	
 Universal Equipment	LED Floodlight All-Position Light Round Light 6900 Lumens, 50 Watts, 4.10 Amps For 9 Volt to 32 Volt Systems Includes Mounting Bracket and Stainless Steel Hardware	AMTL500F	\$ 120.00	
	LED Floodlight All-Position Light 4.30" Round Light 5040 Lumens, 50 Watts, 4.10 Amps For 12 Volt to 24 Volt Systems Includes Stainless Steel Adjustable Mounting Bracket	AMAT305931	\$ 96.00	
 Universal Equipment	LED Floodlight All-Position Light 4.25" Round Light 2650 Lumens, 42 Watts, 3.50 Amps For 12 Volt to 24 Volt Systems Includes Mounting Bracket and Stainless Steel Hardware	AMTL115F	\$ 59.00	
Universal Equipment	LED Wide Floodlight All-Position Light 5" x 7" Rectangle Light 3800 Lumens, 35 Watts For 12 Volt to 24 Volt Systems	AMX34171	\$ 60.00	

Massey Ferguson®—Tractor

Application	Description	Part Number	Retail Price	Core
 Universal Equipment	LED Floodlight, Sealed Beam Fender Mount 4.50" Diameter Round Light 1250 Lumens, 18 Watts, 1.50 Amps Trapezoid Pattern For 12 Volt to 24 Volt Systems	AMTL3010	\$ 40.00	
	LED Floodlight Fender Mount 4.50" Diameter Sealed Beam Round Light 1250 Lumens, 18 Watts, 1.20 Amps Trapezoid Pattern For 12 Volt to 24 Volt Systems Lasts 50 times longer than halogen lighting, vibration resistant w/ no filament failures, uses original mount and wiring. Operating temperature of -40°F to 140°F / -40°C to 60°C	AMRE336111	\$ 35.00	
 Universal Equipment	LED Floodlight Fender Mount 4.50" Diameter Sealed Beam Round Light 1440 Lumens, 18 Watts, 1.60 Amps Lasts 50 times longer than halogen lighting, vibration resistant w/ no filament failures, 2-terminal connection, Operating temperature of -40°F to 140°F / -40°C to 60°C	AMRE336112	\$ 67.75	
 6235, 6245, 6255, 6265, 6270, 6280, 6290	LED Floodlight Side Mount 3.50" x 6" Rectangle Light 3600 Lumens, 40 Watts, 3.33 Amps Includes Connector for plug-and-play installation	AM92266C2	\$ 85.00	
 6235, 6245, 6255, 6265, 6270, 6280, 6290 Replaces 3781544M1, 3900811M91, 3900812M91	LED Floodlight Side Mount 6" x 3.50" Rectangle Light 3600 Lumens, 40 Watts, 3.30 Amps For 12 Volt to 24 Volt Systems Uses Original Mount and Wiring Includes Swivel Mounting Bracket and Hardware	AMTL3070	\$ 90.00	
	LED Floodlight Side Mount 6" x 3.50" Rectangle Light 3600 Lumens, 40 Watts, 3.30 Amps For 12 Volt to 24 Volt Systems Uses Original Mount and Wiring Includes Swivel Mounting Bracket and Hardware	AM92266C1	\$ 68.00	
 Universal Equipment	LED Floodlight Cab and Fender Mount 3.50" x 6" Rectangle Light 3600 Lumens, 40 Watts, 3 Amps	AMX34146	\$ 65.00	
 8245, 8260, 8270, 8280	LED Floodlight/Spotlight Combo Hood Mount 6" x 4" Rectangle Light Dual Hi/Lo Beam 3500 Lumens, 60 Watts, 5 Amps For 12 Volt to 24 Volt Systems Uses Original Mount and Wiring Includes Connector and Stainless Steel Hardware	AMTL6040	\$ 110.00	



Massey Ferguson®—Tractor

Application	Description	Part Number	Retail Price	Core
 Universal Equipment	LED Spotlight All-Position Light 4.25" x 4.25" Square Light 1400 Lumens, 27 Watts, 2.20 Amps For 12 Volt to 24 Volt Systems	AMTL100S	\$ 45.00	
 Universal Equipment	LED Spotlight All-Position Light 6.25" x 1.75" Rectangle Light 1300 Lumens, 18 Watts, 1.50 Amps For 12 Volt to 24 Volt Systems Includes Mounting Bracket and Stainless Steel Hardware	AMTL118S	\$ 50.00	
 Universal Equipment	LED Spotlight All-Position Light Round Light 6900 Lumens, 50 Watts, 4.10 Amps For 9 Volt to 32 Volt Systems Includes Mounting Bracket and Stainless Steel Hardware	AMTL500S	\$ 120.00	
 10, 20, 30, 31, 40, 50, 60, 70, 80, 135, 150, 165, 175, 180, 230, 240, 245, 250, 255, 270, 275, 285, 290, 298, 1080, 1085, 1100, 1105, 1130, 1135, 1150, 1155, 1500, 1505, 1800, 1805, 2640, 2675, 2705, 2745, 2775, 2805, 3505, 3525, 3545	LED Trapezoid Light Fender Mount 4.50" Sealed Beam Round Light 2200 Lumens, 24 Watts, 2 Amps For 12 Volt to 24 Volt Systems Uses Original Mount and Wiring Replaces RE336111	AMTL3015	\$ 50.00	
 Universal Equipment	LED Trapezoid Light Cab and Fender Mount 4.50" Diameter Round Light 2800 Lumens, 40 Watts, 3.30 Amps Trapezoid Pattern For 12 Volt to 24 Volt Systems Bottom Mount w/ Built-In Heat Sink Includes Mounting Bracket, Long and Short Rubber Bezels and Stainless Steel Hardware	AMTL2080	\$ 95.00	
	LED Trapezoid Light Cab and Rear Fender Mount 4.50" Diameter Round Light 2800 Lumens, 40 Watts, 3.30 Amps Trapezoid Pattern For 12 Volt to 24 Volt Systems Bottom Mount w/ Built-In Heat Sink Includes Mounting Bracket, Long and Short Rubber Bezels and Stainless Steel Hardware	AMX33121	\$ 76.00	
 Universal Equipment	LED Warning Light Cab, Header or Swather Mount Can be used for Turn Signal, Brake or Running Lights 4.125" Diameter Round Light Double Sided, Amber Lenses 25 Bulbs per Side For 12 Volt to 24 Volt Systems	AMTLFL2	\$ 55.00	
	LED Warning Light Cab, Header or Swather Mount Can be used for Turn Signal, Brake or Running Lights 4.125" Diameter Round Light Double Sided, Amber Lenses 25 Bulbs per Side For 12 Volt to 24 Volt Systems	AMX1910149	\$ 44.00	

Massey Ferguson®—Tractor

Application	Description	Part Number	Retail Price	Core
 Universal Equipment	LED Warning Light Cab, Header or Swather Mount Can be used for Turn Signal, Brake or Running Lights 4.125" Diameter Round Light Double Sided, Red and Amber Lenses 25 Bulbs per Side For 12 Volt to 24 Volt Systems	AMTLFL3	\$ 55.00	
	LED Warning Light Cab, Header or Swather Mount Can be used for Turn Signal, Brake or Running Lights 4.125" Diameter Round Light Double Sided, Red and Amber Lenses 25 Bulbs per Side For 12 Volt to 24 Volt Systems	AMX33126	\$ 44.00	
 Universal Equipment	LED Magnetic Warning Light All-Position Light 360° Flashing Light, Multiple Patterns 9.50" x 6.75" Rectangle Light Magnetic Base or Solid Mount For 12 Volt to 24 Volt Systems Includes Cigarette Lighter Adapter, Wiring and Switch	AMTL1100	\$ 170.00	
 Universal Equipment	LED Magnetic Warning Light All-Position Light 360° Flashing Light, Multiple Patterns 14" x 6.75" Rectangle Light Magnetic Base or Solid Mount For 12 Volt to 24 Volt Systems Includes Cigarette Lighter Adapter, Wiring and Switch	AMTL1200	\$ 190.00	
Universal Equipment	Warning Beacon 360° Flashing Beacon, Amber Lens For 0.9435" Diameter Pipe Replaces 84337818, AZ44705, AZ101891	AM82018390	\$ 45.64	
 Universal Equipment	LED Warning Beacon 360° Flashing Beacon 2.75" x 5.25" Light Polycarbonate Amber Lens and Housing For 12 Volt to 24 Volt Systems Includes Solid Mounting Pad and Stainless Steel Hardware	AMTL2100	\$ 30.00	
 Universal Equipment	LED Warning Beacon 360° Flashing Beacon, 3 Different Patterns 5" x 10" Light Amber Lens, 48 Watts, 4 Amps For 12 Volt to 24 Volt Systems Brackets Sold Separately	AMX33131	\$ 75.00	
 Universal Equipment	Warning Beacon Bracket	AMX33132	\$ 15.00	
 Universal Equipment	Warning Beacon Bracket	AMX33133	\$ 15.00	

Massey Ferguson®—Tractor

Application	Description	Part Number	Retail Price	Core
 Universal Equipment	Warning Beacon Bracket	AMX33137	\$ 15.00	
 Universal Equipment	Warning Beacon Bracket	AMX33135	\$ 15.00	
 Universal Equipment	LED Light Bar 4" Long, 1260 Lumens, Cree Bulbs	AMLED4	\$ 45.00	
	LED Light Bar Flood/Spotlight Combo 10" Long, 5700 Lumens, 50 Watts, 4.20 Amps For 12 Volt to 24 Volt Systems Includes Mounting Bracket and Stainless Steel Hardware	AMTL10SRC	\$ 129.00	
	LED Light Bar Floodlight/Spotlight Combo 14" Long, 5400 Lumens, 72 Watts, 6 Amps Die Cast Aluminum Housing, Polycarbonate Lens For 12 Volt to 24 Volt Systems Includes Mounting Bracket and Heavy Duty Stainless Hardware	AMTLB410C	\$ 150.00	
	LED Light Bar Floodlight/Spotlight Combo 30" Long, 13600 Lumens, 150 Watts, 12.50 Amps For 12 Volt to 24 Volt Systems Includes Mounting Bracket and Stainless Steel Hardware	AMTL30SRC	\$ 230.00	
	LED Light Bar 30" Long, 13860 Lumens, Cree Bulbs	AMLED30	\$ 130.00	
	LED Light Bar Floodlight/Spotlight Combo 40" Long, 17300 Lumens, 200 Watts, 16.70 Amps For 12 Volt to 24 Volt Systems Includes Mounting Brackets and Stainless Steel Hardware	AMTL40SRC	\$ 300.00	
	LED Light Bar 40" Long, 18200 Lumens, Cree Bulbs	AMLED40	\$ 160.00	
	LED Light Bar Floodlight/Spotlight Combo 42" Long, 14500 Lumens, 240 Watts, 19 Amps For 12 Volt to 24 Volt Systems Includes Mounting Bracket and Stainless Steel Hardware Replaces 1163691	AMTLB440C	\$ 250.00	
	LED Light Bar, Curved 50" Long, 21500 Lumens, Cree Bulbs	AMLED50C	\$ 190.00	

Massey Ferguson®—Tractor

Application	Description	Part Number	Retail Price	Core
 Universal Equipment	LED Magnetic Work Light	AMTL2460	\$ 79.00	
	All-Position Light 3.25" Square Floodlight 900 Lumens Magnetic Base Includes Lithium Ion Battery, Cigarette Lighter and DC Charger			



Glass

Application	Description	Part Number	Retail Price	Core
6140, 6150, 6170, 6180, 6190, 6235, 6245, 6255, 6260, 6265, 6270, 6280, 6290, 8120, 8140, 8150, 8160, 8210, 8220, 8240, 8245, 8250, 8260, 8270, 8280, (6445, 6455, 6465, 6475, 6480, 6485, 6490, 6495 BSN N195047, Non Tier 3), (6460, 6470 BSN N195047), (7465, 7475, 7480, 7485, 7490, 7495 BSN N205025, Non Tier 3)	Door Glass, Right Hand Replaces 3902124M1	AM3907222M1	\$ 466.87	
	Door Glass, Left Hand Replaces 3902123M1	AM3907221M1	\$ 366.00	

Gas Struts

Application	Description	Part Number	Retail Price	Core
50, 65, 85, 135, 150, 165, 168, 175, 178, 180, 185, 188, 235, 245, 250, 255, 265, 270, 275, 282, 285, 290, 565, 575, Ind/Const: 20, 30, 40, 50C, 60, 90, 2500, 3165, 6500	Gas Strut, Rear Window Replaces 3038161M91, 3476187M1, 83932024	AME2NN9444000AA	\$ 15.50	

Air Conditioning and Components









Application	Description	Part Number	Retail Price
 1080, 1085, 1100, 1105, 1130, 1135, 2640, 3505, 3525, 3545, 4800, 4840, 4880, 4900	Compressor Conversion Kit A6 Style to Seltec Style Includes Compressor, Mounting Brackets, Compressor Manifold, Hi-Lo Pressure Switches, Belt and Mounting Hardware, Adapts to the Original A6 Mounting Brackets Requires Pag Oil 100V, 6.76 oz (200 cc)	AMX10224	\$ 450.00
	Ultra Pag Double End Capped, 100V, 8 oz	AMX10267	\$ 12.00
	Universal Pag Oil, 8 oz	AMX10274	\$ 8.25
 375, 383, 390, 393, 396, 398, 399, 3050, 3070, 3080, 3090, 3095, 3120, 3125, 3140, (3505, 3525, 3545 ASN L178203), 3630, 3645, 3650, 3655, 3660, 3670, 3680, 3690, 4225, 4233, 4240, 4245, 4255, 4260, 4265, 4270, 8120, 8140, 8150, 8160, 8210, 8220, 8240, 8245, 8280 Replaces 3782613M2	Compressor w/ Dust Cover, Sanden 12 Volt, w/ 2-Groove Clutch, 5.50" (138 mm) Clutch Diameter, GM Pad Mount Requires Synthetic Ester Oil 100V, 6.42 oz (190 cc)	AMX10136	\$ 240.00
	Premium Synthetic Ester Oil, 100V, 12 oz	AMX10273	\$ 11.00
 670, 675, 690, 698, 699 Replaces 1690711M1	Compressor, Sanden SD510 Style 12 Volt, w/ 2-Groove Clutch, 5.19" (132 mm) Clutch Diameter, 0.50" Belt Width, Vertical #8 and #10 O-Ring, w/ R12 Charge Ports Requires Pag Oil 100V, 4.56 oz (135 cc)	AMX10220	\$ 325.00
	Ultra Pag Double End Capped, 100V, 8 oz	AMX10267	\$ 12.00
	Universal Pag Oil, 8 oz	AMX10274	\$ 8.25

Massey Ferguson®—Tractor



Application	Description	Part Number	Retail Price
 1080, 1085, 1100, 1105, 1130, 1800, 1805, 2640, 2675, 2705, 2745, 2775, 2805, 3505, 3525, 3545, 4800, 4840, 4880, 4900 Replaces 586126M91	Compressor w/ Dust Cover, HD Superheat Compressor, 12 Volt, w/ Single Groove Clutch, 5.58" (142 mm) Clutch Diameter. Can be used for 2 o'clock and 10 o'clock Positions, Must use Original Hoses and Belts, Replaces A6 Style w/ 10 Cylinder Nippondenso 10PA20 Style, Uses Less Power for Greater Efficiency Requires Pag Oil 46V, 7.00 oz (207 cc)	AMX10223	\$ 390.00
	Ultra Pag Double End Capped, 46V, 8 oz	AMX10266	\$ 12.00
 9240	Compressor, Sanden 12 Volt, w/ 2-Groove Clutch, 5.25" (133 mm) Clutch Diameter, Vertical Tube O-Ring, w/o Charge Ports Requires Synthetic Ester Oil 100V, 8.11 oz (240 cc)	AMX10130	\$ 365.00
	Premium Synthetic Ester Oil, 100V, 12 oz	AMX10273	\$ 11.00
 Universal Equipment	High Pressure Switch Normally Open, Opens at 305 PSI, Closes at 395 PSI, 7/16"x20 Thread	AMX10276	\$ 35.00
 Universal Equipment	Low Pressure Switch Normally Open, Opens at 6 PSI, Closes at 45 PSI, Standard 7/16"x20 Thread	AMX10277	\$ 55.00
 Universal Equipment	Low Pressure Switch Normally Open, Opens at 35 PSI, Closes at 46 PSI, Standard 7/16"x20 Thread	AMX10278	\$ 42.00
 285, 375, 383, 390, 390T, 393, 396, 398, 399, 698, 699, 1080, 1085, 1100, 1105, 1130, 1135, 1150, 1155, 1500, 1505, 1800, 1805, 2640, 2675, 2705, 2745, 2775, 2805, 3505, 3525, 3545 Replaces 250698M1, 3320059M2	Rotary Adjustable Thermostatic Switch 36" Capillary Tube	AMX10251	\$ 45.00
 285, 1080, 1085, 1105, 1100, 1130, 1135, 1150, 1155, 1500, 1505, 1800, 1805, 4800, 4840, 4880, 4900 Replaces 250929M91, 1034581M91	Receiver Drier 3" x 6" Male Flare, R12 and R134a Compatible	AMX10211	\$ 22.00
 365, 375, 383, 390, 390T, 393, 396, 398, 399, 2640, 2645, 2670, 2685, 2725, 3050, 3060, 3065, 3070, 3075, 3080, 3085, 3090, 3095, 3115, 3120, 3120T, 3125, 3140, 3610, 3630, 3635, 3645, 3650, 3655, 3660, 3670, 3680, 3690	Receiver Drier 3" x 7" Male O-Ring, Inlet - #6 3/8" Male O-Ring, Outlet - #6 3/8" Male O-Ring, Male Switch Port, R12 and R134a Compatible	AM3383321M1	\$ 23.00
 375, 383, 390, 393, 396, 398, 399, 670, 690, 698, 699 Reference 3763351M1	Receiver Drier 3" x 9" Male O-Ring, Male Switch Port, R12 and R134 Compatible	AMX10205	\$ 26.00
 670, 690, 698 Replaces 3763351M1	Receiver Drier 3" x 9 1/2" Male Flare, Male Switch Port, R12 and R134a Compatible	AMX10210	\$ 32.00
 1547, 1552, 1635, 1643, 1648, 1652, 1655 Replaces 6244522M91	Komatsu Receiver Drier XH9 Desiccant	AMX10239	\$ 40.00

Prices Subject to Change without Prior Notice. The use of original equipment manufacturer (OEM) part numbers or trademarks, e.g. Case® and John Deere®, are for reference purposes only and for indicating product use and compatibility. Our company and the listed replacement parts contained herein are not sponsored, approved or manufactured by the OEM. All parts are New unless designated Reman in the description.

Massey Ferguson®—Tractor

Application	Description	Part Number	Retail Price
 2620, 2675, 2680, 2705, 2720, 2745, 2775, 2805 Replaces 3039149M91	Receiver Drier 2 1/2" x 8" Male O-Ring, R12 & R134a Compatible	AMX10237	\$ 24.00
 Most 3000, 4000, 5000, 6000, 7000, 8000 Series	Receiver Drier 3" x 9" Male O-Ring, R12 and R134a Compatible	AM3712495M1	\$ 26.00
 471, 481, 491, 492, 573, 583, 593, 596, 660, 680, 2660, 3050, 3060, 3065, 3075, 3085, 3090, 3095, 3120, 3120T, 3125, 3140, 3315, 3325, 3330, 3340, 3350, 3355, 3635, 3645, 3655, 3660, 3670, 3690, 5275, 5285, 5290, 5425, 5435, 5445, 5450, 5455, 5460, 5465, 5470, 5475, 5480, 6120, 6130, 6140, 6150, 6160, 6170, 6180, 6190, 6235, 6245, 6255, 6260, 6265, 6270, 6280, 6290, 6445, 6455, 6460, 6465, 6470, 6475, 6480, 6485, 6490, 6495, 6497, 6499, 7465, 7475, 7480, 7485, 7490, 7495, 7497, 7499, 7619, 7620, 7622, 7624, 8110, 8120, 8130, 8140, 8150, 8160, 8170, 8180, 8210, 8220, 8240, 8245, 8250, 8260, 8270, 8280, 8450, 8460, 8470, 8480 Replaces 3902334M91	Expansion Valve Flange Type, O-Ring Connection, R12 and R134a Compatible	AMX10260	\$ 25.00
 1085, 1105, 1135, 1155, 1500, 1505, 1800, 1805, 4800, 4840, 4880, 4900 Replaces 529876M91, 529877M1, 250902M1	Expansion Valve Internally Regulated w/ 12" Capacity Tube w/ Flare Connection, R12 and R134a Compatible	AMX10215	\$ 30.00
 (3050, 3065, 3075, 3090, 3095, 3120, 3120T, 3125, 3140, 3645, 3655, 3660, 3670, 3690 BSN C210009), 3070, 3630, 3650, 3680 Replaces 3311533M91	Expansion Valve Block Type, R12 and R134a Compatible, O-Ring Connection	AMX10151	\$ 24.00
 3050, 3645, 3655, 3660, 3670, 3690, 5425, 5435, 5445, 5450, 5455, 5460, 5465, 5470, (5475, 6140, 6150, 6170, 6180, 6190 - w/o High Visibility Cab), 5480, 6120, 6130, 6160, (6235, 6245, 6255, 6260, 6265 w/ High Visibility Cab, 6270, 6280, 6290 ASN J348039), 6445, 6455, 6460, 6465, 6470, 6475, 6480, 6485, 6490, 6495, 8120, 8140, 8150, 8160, 8210, 8220, 8240, 8245, 8250, 8260, 8270, 8280	Expansion Valve Replaces 7028951M1	AM3902334M91	\$ 28.00
 360, 375, 390, 390T, 398, 471, 481, 491, 492, 573, 583, 593, 596, 660, 680, 3050, 3060, 3065, 3070, 3075, 3080, 3085, 3090, 3095, 3115, 3120, 3125, 3140, 3610, 3630, 3635, 3650, 3655, 3660, 3670, 3680, 3690, 5275, 5285, 5290, 5425, 5435, 5445, 5455, 6120, 6130, 6140, 6150, 6160, 6170, 6180, 6190, 6235, 6245, 6255, 6260, 6265, 6270, 6280, 6290, 6350, 6360, 6445, 6455, 6460, 6465, 6470, 6475, 6480, 6485, 6490, 6495, 6497, 6499, 8110, 8120, 8130, 8140, 8150, 8160, 8210, 8220, 8240, 8245, 8250, 8260, 8270, 8280, 8450, 8460, 8470, 8480 Replaces 3900465M91	Blower Motor w/ Wheels 12 Volt, 2-Wire, 5/16" Shaft Diameter	AM3310831M91	\$ 110.00
 1105, 1135, 1155, 1500, 1505, 1800, 1805 Replaces 72162089, 525444M1	Blower Motor 3-Speed, Double Shaft, 4-Wire, Reversible, 3/8" Shaft Diameter, 4 1/4" Long	AMX10120	\$ 80.00

Massey Ferguson®—Tractor

Application	Description	Part Number	Retail Price
 2640, 2675, 2705, 2745, 2775, 2805 Replaces 1680361M91	Blower Motor Single Speed, Double Shaft, 2-wire, Reversible, 5/16" Shaft Diameter, 3 12" Long	AMX10113	\$ 110.00
 285, 1085, 1105, 1135, 1155, 1505, 1805	Blower Motor Switch, 3-Speed	AM271105M1	\$ 6.50
 1105, 1135, 1155, 4000 Series	Evaporator	AM528785M92	\$ 245.00

Shop Manuals and Collections

I&T Shop Service Manuals provide the information you need to service virtually any make or model of wheel-type farm tractor. Easy-to-follow procedures, detailed illustrations and comprehensive specifications help guide you through complete tractor maintenance and repair with accuracy and efficiency.



Application	Description	Part Number	Retail Price
Models: TE20, TO20, TO30	Massey Ferguson®	IT-FE-2	\$ 28.00
Models: TO35, TO35 Diesel, F40, MH50, MHF202, MF35, MF35 Diesel, MF50, MF202, MF204	Massey Ferguson®	IT-MF-14	\$ 28.00
Models: 135, 150, 165	Massey Ferguson®	IT-MF-27	\$ 28.00
Model: 285	Massey Ferguson®	IT-MF-36	\$ 28.00
Models: 670, 690, 698	Massey Ferguson®	IT-MF-41	\$ 28.00
Models: 230, 235, 240, 245, 250	Massey Ferguson®	IT-MF-42	\$ 28.00
Models: 255, 265, 270, 275, 290	Massey Ferguson®	IT-MF-43	\$ 28.00
Models: 3505, 3525, 3545	Massey Ferguson®	IT-MF-44	\$ 28.00
Models: 362, 365, 375, 383, 390, 390T, 398	Massey Ferguson®	IT-MF-45	\$ 28.00
Models: 340, 350, 355, 360, 399	Massey Ferguson®	IT-MF-46	\$ 28.00
Models: 1010, 1020	Massey Ferguson®	IT-MF-47	\$ 28.00
Models: 65, 85, 88, Super 90, Super 90WR, 1080, 1085, 1100, 1130, 1150, 1105, 1135, 1155	Massey Ferguson® Collection	IT-MF-201	\$ 31.00
Models: 175, 180, 2675, 2705, 205, 210, 220, 2745, 2775, 2805	Massey Ferguson® Collection	IT-MF-202	\$ 31.00

Massey Ferguson®—Combine

Table of Contents

Air Conditioning and Components.....	1383	Draper Belts and Components	1379
Augers—Lower Clean Grain.....	1375	Elevator Chains	1374
Augers—Lower Return	1375	Elevator Chain Sprockets	1374
Axle Drive Shafts and Couplers.....	1370	Feederhouse Chains	1371
Belts—300	1388	Feederhouse Chain Sprockets	1371
Belts—410, 510	1389	Feederhouse Components	1371
Belts—540	1390	Feeder Shaft Angles and Paddles	1372
Belts—550	1391	Grain Pans and Components	1376
Belts—750, 760	1392	Guards and Cutter Bar Parts	1378
Belts—850, 860	1394	Header Drive Shafts	1378
Belts—8560, 8570, 8780	1395	Lighting	1379
Belts—8590, 9720	1396	Platform Components.....	1377
Belts—885 Swather.....	1387	Power Shafts and Bearings	1373
Belts—9520, 9540, 9560	1397	Reel Components.....	1377
Belts—9690, 9695, 9790, 9795, 9895	1398	Rethresher Bars and Channels	1373
Chaffers—Long Finger Top	1375	Shaker Shoe Shafts and Kits.....	1372
Chaffers—Short Finger Middle	1376	Sieves—Blunt Finger Bottom	1376
Chaffers—Short Finger Top	1375	Spindles.....	1378
Cleaning Fan Shafts	1373	Straw Chopper Blades and Components	1377
Concaves and Components	1373	Straw Chopper Drive Components.....	1377
Cornhead—Auger Liners.....	1385	Straw Walkers and Components	1376
Cornhead—Fenders and Snouts.....	1385	Thresher Cylinder Parts.....	1372
Cornhead—Row Unit Components	1386	Unloading Auger Gears	1375
Cornhead—Stalk Stompers and Components	1386	Unloading Auger Swing Cylinders	1374
Cylinder Bars and Kits	1372		
Cylinder Drive Shafts.....	1372		

Axle Drive Shafts and Couplers



Application	Description	Part Number	Retail Price	Core
750, 850	Axle Drive Shaft 29.312" Long	AM280512M1	\$ 148.78	
760, 860 - w/ 4 Speed Transmission	Axle Drive Shaft 55.50" Long	AM274842M1	\$ 175.82	
760 Late, 860 - w/ Hydro	Axle Drive Shaft 34.25" Long	AM280509M1	\$ 175.09	
750, 760, 850, 860	Axle Drive Shaft Coupler 3.687" Long	AM258993M	\$ 83.36	
750, 760, 850, 860	Axle Drive Shaft Stub Shaft (weld-in) allows repairing splines on either end of shaft w/ 259310M91, 258867M91, 271465M91 or 27484M92	AM259310M91E	\$ 109.05	

Massey Ferguson®—Combine

Feederhouse Chains

Our feederhouse chains utilize high-quality materials to meet or exceed OEM specifications. Slats are mounted using 3/8" grade 5 plated bolts and locknuts for easy replacement. Chains feature full side plates and high-strength steel for added durability. All feederhouse chains come with serrated slats unless otherwise noted. Call for different slats and chain configurations available to fit your application.



Application	Description	Part Number	Retail Price	Core
410, 540	Feederhouse Chain 70 Links - Serrated slats every 4th link 3 Chain Assembly	AMX28025	\$ 450.00	
	Serrated Slat For 14" Chain Centers	AM240152M92	\$ 15.00	
510, 550	Feederhouse Chain 70 Links - Serrated slats every 4th link 3 Chain Assembly	AMX28026	\$ 475.00	
	Serrated Slat For 18" Chain Centers	AM249652M92	\$ 15.00	
750, 850	Feederhouse Chain 81 Links - T-slats every 2nd link 4 Chain Assembly	AM278626M92L	\$ 1015.66	
760, 860	Feederhouse Chain 81 Links - T-slats every 2nd link 4 Chain Assembly	AM278611M92L	\$ 943.08	
8560, 8570	Feederhouse Chain 112 Links - 28 Serrated slats 19.25" Center-to-Center on Sprockets 3 Chain Assembly, CA557	AM263913W91L	\$ 1050.20	

Feederhouse Chain Sprockets

Application	Description	Part Number	Retail Price	Core
8680 ASN HL26101	Feederhouse Chain Sprocket 13 Tooth, 2" Hex Bore Replaces FM155	AM71394665	\$ 89.76	



Feederhouse Components

Application	Description	Part Number	Retail Price	Core
1 750, 850	Hub with Pressure Plate Assembly For throat slip clutch, Fits paddle-style feederhouses	AM284922M1	\$ 334.45	
1 760, 860	Hub with Pressure Plate Assembly For throat slip clutch, Fits paddle-style feederhouses	AM284921M1	\$ 271.09	
2 760, 860	Header Drive Sprocket - Right Hand Double 23 Tooth, 50 Chain, For slat-style feederhouse	AM278671M91	\$ 141.83	
2 760, 860	Drive Coupler with Sprocket Double Chain, 20 Tooth, 5.19" Diameter	AM273458M91	\$ 304.18	
3 410 ASN 1486008169, 510 ASN 1486008169, 540, 750, 760, 850, 855 ASN 169027544, 860, 865 ASN 1746019115, Most Corn and Grain Heads	Female Drive Coupler	AM470040M1	\$ 42.65	

Massey Ferguson®—Combine

Feeder Shaft Angles and Paddles



Application	Description	Part Number	Retail Price	Core
750, 850	Paddle Shaft - Middle 1.50" x 57.312"	AM258129M2	\$ 242.40	
750, 751, 850, 851, 852	Paddle Replaces Paddles on 4 Lower Shafts	AM293054M2	\$ 36.31	
750, 751, 850, 851, 852	Paddle Replaces Paddles on Top Drive Shaft	AM293179M1	\$ 35.81	
760	Paddle Shaft - Middle 1.75" x 66.875"	AM273002M2	\$ 95.00	
760, 860	Paddle Replaces Paddles on 4 Lower Shafts	AM293033M2	\$ 34.00	
760, 860	Small Angle	AM273972M3	\$ 56.21	
760, 860	Large Angle	AM273973M2	\$ 99.37	

Thresher Cylinder Parts

Application	Description	Part Number	Retail Price	Core
510	Cylinder V.S. Drive Hub	AM227361M	\$ 180.15	

Shaker Shoe Shafts and Kits

Application	Description	Part Number	Retail Price	Core
750	Shaker Shoe Shaft	AM253352M91	\$ 501.13	

Cylinder Drive Shafts

Application	Description	Part Number	Retail Price	Core
750 BSN 1696 19596, 760 BSN 1746-009-413	Cylinder Drive Shaft Early Style 2 Speed Cylinder Drive 15.94" Long	AM254478M1	\$ 219.31	
750 ASN 1696 19596, 751, 760 ASN 1746-009-413, 850, 851, 852, 860, 865	Cylinder Drive Shaft Late Style 2 Speed Cylinder Drive 22.094" Long	AM259677M1	\$ 315.34	
750, 760, 850 (BSN 1696-027-544 w/ 2-Speed or ASN 1696-027-543 w/ Electric Variable Speed), (855, 865 (w/ Electric Variable Speed), 860 (BSN 1746-019-115 w/ 2-Speed or ASN 1746-019-114 w/ Electric Variable Speed)	Cylinder Drive Assembly Bearing	AM842047M1	\$ 136.53	

Cylinder Bars and Kits

All bars are carefully checked and sets are matched for equal weight distribution on the cylinder prior to shipment. Grade 8 fasteners are supplied for most models.



Application	Description	Part Number	Retail Price	Core
750, 751, 850, 851, 852, 855 Hi-Inertia	Cylinder Bar Kit First 2 holes 10 1/2" apart, 4 Right and Left Hand Angle Bars w/ Mounting Fasteners	Standard AMOMF-750-1	\$ 453.45	
		Hardened AMOMF-750-1H	\$ 563.75	
760, 860 Hi-Inertia, 865	Cylinder Bar Kit 5 Hole, 4 Right and Left Hand Angle Bars w/ Mounting Fasteners	Standard AMOMF-760-5	\$ 375.00	
		Hardened AMOMF-760-5H	\$ 611.78	
		Chrome AMOMF-760-5C	\$ 642.52	

Massey Ferguson®—Combine

Application	Description		Part Number	Retail Price	Core
760	Cylinder Bar Kit 7 Hole, 4 Right and Left Hand Angle Bars w/ Mounting Fasteners	Standard	AMOMF-760-7	\$ 338.83	
8560, 8570, 8590, 8780XP, 9700, 9720	Cylinder Bar Kit 3 Bars w/ Mounting Fasteners	Front, Angle Rear, Flat	AM31-2497293 AM31-2497283	\$ 212.31 \$ 186.15	



Concaves and Components

Application	Description		Part Number	Retail Price	Core
750	Concave w/ Front and Rear Plates	Small Wire	AM258843E92	\$ 1665.05	
760	Concave w/ Front and Rear Plates	Small Wire	AM273632E92	\$ 1798.30	
860, 865	Concave w/ Front and Rear Plates	Large Wire Corn	AM278443E92	\$ 1587.51	
8560, 8570, 8780, 8780XP, 9520, 9690, 9695, 9790, 9795, 9895	Concave, Set of 7	Large Wire Corn and Soybean	AM104904W91	\$ 2850.00	
8560, 8570, 8780, 8780XP, 9690, 9695, 9790, 9795	Concave High Wire (7) Required	Large Wire Corn Small Wire	AM2464751W91 AM71390005	\$ 477.14 \$ 526.74	



Rethresher Bars and Channels

Application	Description	Description	Part Number	Retail Price	Core
410, 510, 540, 550, 750, 751, 850, 851, 852, 860, 865	Rethresher Channel Set of 6	Standard	AM252318M1	\$ 37.85	

Cleaning Fan Shafts

Application	Description	Part Number	Retail Price	Core
750 ASN 2311, 850 BSN 25803	Cleaning Fan Shaft 61.937" Long	AM259160M1	\$ 88.10	
760, 860 BSN 17403	Cleaning Fan Shaft 68.625" Long	AM256728M1	\$ 278.18	

Power Shafts and Bearings



Application	Description		Part Number	Retail Price	Core
750 BSN 19595	Power Shaft 36.75" Long		AM253310M1	\$ 115.00	
760 (w/ AT6.354 Diesel Engine BSN 11176)	Power Shaft 41.062" Long		AM270575M1	\$ 172.89	
760 (w/ AT6.354 Diesel Engine ASN 11177), 860 (w/ AT6.354 Diesel Engine BSN 16559)	Power Shaft 41.00" Long		AM280473M1	\$ 175.00	
760 (w/ V8-540 Diesel Engine BSN 11176)	Power Shaft 41.625" Long		AM274210M1	\$ 239.68	
850 (w/ Diesel Engine ASN 25656)	Power Shaft 36.50" Long		AM284580M1	\$ 370.31	
860 (w/ AT6.354 Diesel Engine ASN 16559)	Power Shaft 41.00" Long		AM284578M1	\$ 54.73	
860 (w/ V8-540 Diesel Engine ASN 16559)	Power Shaft 41.625" Long		AM284579M1	\$ 372.94	

Massey Ferguson®—Combine

Elevator Chains

Elevator chains include rubber paddles attached with 5/16" plated bolts and nuts (unless noted in the individual description). Chains feature full side plates for added strength.



Application	Description	Part Number	Retail Price	Core
410, 540	Clean Grain Elevator Chain 124 links - 5 1/4" x 3 1/2" Rubber paddles every 4th link	AM240610M92L	\$ 285.55	
750, 850	Clean Grain Elevator Chain 140 links - 5 5/8" x 3 1/2" Rubber paddles every 4th link	AM253167M91	\$ 416.81	
	Rubber Paddle 5 5/8" x 3 1/2"	AM253169M1	\$ 8.15	
750, 760, 850, 860 - w/ Extended Elevator	Clean Grain Elevator Chain 172 links - 5 5/8" x 3 1/2" Rubber paddles every 4th link	AM270725M91	\$ 495.98	
	Rubber Paddle 5 5/8" x 3 1/2"	AM253169M1	\$ 8.15	
8560, 8570, 8590, 8780	Clean Grain Elevator Chain 146 links - 9 1/2" x 3 1/8" Rubber paddles every 4th link	AM2605873W91	\$ 475.03	
750, 760, 850, 860	Return Grain Elevator Chain 57 links - 3 5/8 x 3 1/4 Rubber paddles every 4th link	AM253665M91L	\$ 232.13	
8590	Return Grain Elevator Chain 154 links - 5 5/8" x 3 1/8" Rubber paddles every 4th link	AM31-2605863L	\$ 397.07	

Elevator Chain Sprockets

To extend the life of your chain assemblies, always replace the sprockets when installing a new chain.



Application	Description	Part Number	Retail Price	Core
550 ASN 236302121, 750, 760, 850, 860	Clean Grain Elevator Chain Sprocket, Upper 8 Tooth, 1.125" Shaft	AM255806M1	\$ 39.19	
8560, 8570	Clean Grain Elevator Chain Sprocket, Upper 11 Tooth, 1.25" Shaft	AM2412960W1	\$ 117.85	
750, 760, 850, 860	Clean Grain Elevator Chain Sprocket, Lower 8 Tooth, 1.125" Shaft	AM255806M1	\$ 39.19	
	Clean Grain Elevator Chain Sprocket, Lower 8 Tooth, 1.125" Shaft	Hardened AM255806M1H	\$ 35.52	
8560, 8570	Clean Grain Elevator Chain Sprocket, Lower 11 Tooth, 1.50" Shaft	AM2571510W1	\$ 84.29	
750, 760, 850, 860	Return Grain Elevator Chain Sprocket, Upper 8 Tooth, 1.125" Shaft	AM255806M1	\$ 39.19	
	Return Grain Elevator Chain Sprocket, Upper 8 Tooth, 1.125" Shaft	Hardened AM255806M1H	\$ 35.52	
8560, 8570	Return Grain Elevator Chain Sprocket, Upper 8 Tooth, 1.125" Shaft	AM9863040W1	\$ 89.85	
750, 760, 850, 860	Return Grain Elevator Chain Sprocket, Lower 8 Tooth, 1.0625" Shaft	AM270277M1	\$ 46.64	
8560, 8570	Return Grain Elevator Chain Sprocket, Lower 8 Tooth, 1.125" Shaft	AMW9863030	\$ 64.12	

Unloading Auger Swing Cylinders



Application	Description	Part Number	Retail Price	Core
750, 760, 850, 860	Unloading Auger Swing Cylinder	AM1748368M91	\$ 518.46	

Massey Ferguson®—Combine

Augers—Lower Clean Grain

All augers are made with continuous roll-formed fighting for accuracy and durability.

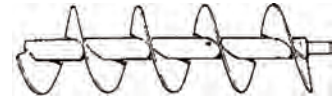

Application	Description	Part Number	Retail Price	Core
750, 850	Lower Clean Grain Auger Extended Wear, 77.25" Long	AM258839M91	\$ 325.00	
	Bearing	NPS100RPC	\$ 6.50	
760, 860	Lower Clean Grain Auger Extended Wear, 87.25" Long	AM273615M91	\$ 402.58	
	Bearing	NPS100RPC	\$ 6.50	

Augers—Lower Return

All augers are made with continuous roll-formed fighting for accuracy and durability.

Application	Description	Part Number	Retail Price	Core
750, 850	Return Grain Auger Extended Wear, 73.625" Long	AM280384M91	\$ 276.48	
	Bearing	AM6206LL	\$ 12.00	
	Bearing	NPS100RPC	\$ 6.50	
760, 860	Return Grain Auger Extended Wear, 83.625" Long	AM280383M91	\$ 355.00	
	Bearing	AM6206LL	\$ 12.00	
	Bearing	NPS100RPC	\$ 6.50	
8680	Lower Return Auger 70.385" Long	AM71364643	\$ 300.29	

Unloading Auger Gears

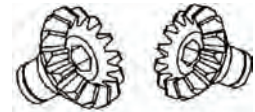

Application	Description	Part Number	Retail Price	Core
750 ASN 169613714, 760 ASN 174607664, 850, 860	Upper Unloading Auger Gear 14 Tooth, .88" Hex ID, 3.625" OD 2 Required	AM265465M1	\$ 109.32	
750, 760, 850, 860	Unloading Auger Gear Round Bore, 20 Tooth, 1 3/8"	AM271608M	\$ 201.88	
750, 760, 850, 860	Unloading Auger Gear Round Bore, 27 Tooth, 1 5/16"	AM271609M	\$ 214.97	

Chaffers—Short Finger Top

Adjustable short finger chaffer with 1 1/8" wire spacing. For use in cereal and fine seed crops.



Application	Description	Part Number	Retail Price	Core
510, 550	Short Finger Top Chaffer	43.38" x 34.00" AM252259M92	\$ 915.15	
750, 850	Short Finger Top Chaffer	48.00" x 39.28" AM258643M92	\$ 652.13	
760, 860	Short Finger Top Chaffer	58.00" x 39.28" AM273024M92	\$ 520.00	
8560, 8570	Short Finger Top Chaffer	49.86" x 78.75" AM2476473W91	\$ 1377.29	

Chaffers—Long Finger Top

Adjustable long finger chaffers with 1 5/8" wire spacing. For use in large seed crops such as corn and beans.

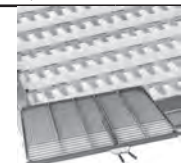

Application	Description	Part Number	Retail Price	Core
760, 860	Long Finger Top Chaffer	58.00" x 39.28" AM271491M92	\$ 764.81	
8560, 8570, 8780	Long Finger Top Chaffer	49.86" x 78.75" AM2527183W91	\$ 970.00	

Massey Ferguson®—Combine

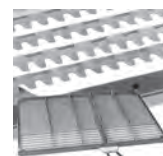

Chaffers—Short Finger Middle

Application	Description	Part Number	Retail Price	Core
510, 550	Short Finger Middle Chaffer	43.38" x 39.50" AM228135M91	\$ 813.68	
760, 860	Short Finger Middle Chaffer	58.00" x 39.28" AM293026M91	\$ 550.00	

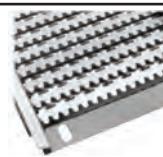

Sieves—Blunt Finger Bottom

Adjustable, blunt finger sieves with 1 1/8" wire spacing. For use in cereal and fine seed grains.

Application	Description	Part Number	Retail Price	Core
8560, 8570	Blunt Finger Bottom Sieve	50.38" x 58.00" AM2476463W91	\$ 1641.02	
8590	Blunt Finger Bottom Sieve	58.38" x 58.00" AM2442043W91	\$ 1125.52	

Grain Pans and Components

Our grain pans are built heavier than OEM and have galvanized pans to prevent rusting. Ripple pans may be ordered separately. Replaceable front sections are available.



Application	Description	Part Number	Retail Price	Core
750, 751, 850, 851, 852, 855	Grain Pan w/ Front Pans 3-piece style grain pan	AMGPMF-750-13G	\$ 1521.68	
760, 860	Grain Pan w/ Front Pans 3-piece style grain pan	AMGPMF-760-13G	\$ 2128.23	

Straw Walkers and Components



Application	Description	Part Number	Retail Price	Core
750	Straw Walkers, Lip Type 3 Louver	AM258722E91	\$ 644.97	
760	Straw Walkers, Lip Type 4 Louver - 119.50"	AM273745E91	\$ 673.34	
850	Straw Walkers, Lip Type 3 Louver - 143" Notch out to fit RH or LH sides	AM283147E95	\$ 837.74	
860	Straw Walkers, Lip Type 4 Louver Notch out to fit RH or LH sides	AM283146E95	\$ 930.99	
510, 550, 750, 751, 850, 852	Straw Walker Wood Block Bearing Set Set includes upper and lower block halves, steel plate, shims and hardware	AM836784M92	\$ 30.00	
760, 860	Straw Walker Wood Block Bearing Set Set includes upper and lower wood block bearing halves, steel plate, and hardware	AM836751M92	\$ 46.77	
760, 860	Walker Return Pan Wood Block Bearing Set - Middle One set of two half blocks and hardware	AM836752M92	\$ 32.40	
760, 860	Walker Return Pan Wood Block Bearing Set - End One set of two half blocks and hardware	AM836874M92	\$ 34.43	
860	Walker Return Pan Galvanized to prevent rust, 70" x 109 3/4"	AM268471M92	\$ 1593.70	

Massey Ferguson®—Combine

Straw Chopper Drive Components

Application	Description	Part Number	Retail Price	Core
(850, 855 ASN 27554), (860, 865 ASN 19115)	Straw Chopper Drive Shaft 15.31" Long	AM284886M1	\$ 45.00	



Straw Chopper Blades and Components

Hardened-steel chopper blades.

Application	Description	Part Number	Retail Price	Core
510 (11 sets), 540 (7 sets), 550 (11 sets), 750 (12 sets), 760 (14 sets), 850 (12 sets), 860 (14 sets)	Straw Chopper Blade Kit Set of 3 Hardened-Steel Blades Includes Hardware	AM71310275	\$ 20.00	
8560, 8570, 8780	Straw Chopper Blade Double Bevel Blade w/o Hardware	AMSCB310DB	\$ 15.62	
8680, 8780, 8780XP, 9690, 9695, 9790, 9795, 9895	Straw Chopper Blade, Paddle, Right Hand 6.77" Long, 0.187" Thick, 0.765" Hole Diameter	AM71382759	\$ 10.86	



Reel Components

Application	Description	Part Number	Retail Price	Core
Platforms: 8000, 8200, 9250, 9800, 9850	Reel Tine Nylon, Double Wing Unit, 6" Spacing Includes Hardware Sold in Multiples of 25, Priced Individually	AMX27222	\$ 2.25	
	Reel Tine, Right Hand Wing 6" Spacing, Includes Hardware	AMX29057	\$ 3.76	
	Reel Tine, Left Hand Wing Nylon, 6" Spacing Includes Hardware	AMX29056	\$ 3.76	
Platforms: 5000, 5100, 5200, 7000, 8000, Draper Platform: 9850, Swathers: 9200, 9300, 9800	Reel Tine, Flexible Tear Drop Style Replaces 276306M1, 700708862, 800714195	AM86562205	\$ 2.26	
Platforms: 9700, 9750	Reel Tine Nylon, 3-Piece Double Wing Unit 4.50" Spacing Includes Hardware Sold in Multiples of 25, Priced Individually Replaces center tine, some modification required for right and left hand sides	AMTINE	\$ 2.00	
	Reel Tine For Platforms w/ Tear Drop Bats and Tines Mounted to Rear of the Steel Bat	AM1970586C1	\$ 1.58	
Platforms: 9700, 9750, 9800, 9850 Series	Quick Fingers, 10 Pack	AMX27550	\$ 22.00	
Platforms: 9700, 9750, 9800, 9850	Reel Bearing	AMH136954	\$ 3.20	

Platform Components

Application	Description	Part Number	Retail Price	Core
7200, 8200	Auger Finger 3/4"x10 UNC Right Hand Thread 0.75" OD, 10.94" Overall Length, 1.62" Thread Length	AM71453629	\$ 13.80	

Massey Ferguson®—Combine



Guards and Cutter Bar Parts

Application	Description	Part Number	Retail Price	Core
540, 550, 750, 760, 850, 860 - Equipped w/ Flex Platforms w/ Floating Cutter Bar	Knife Guard	AM1053174M1	\$ 12.00	
Platforms: Most Models	Knife Guard, Double Pronged Heat Treated Replaces H113571, H145791, H153719, H171031	AMH75386	\$ 9.00	
Platform: 9020 Replaces 700707147, 700716292	Knife Guard, Double Pronged w/ Trash Bar Use w/ 3" Cutter Bar Knife	AM86615982	\$ 11.75	
Platform: 9100 Flex	Knife Guard	AM244925M2	\$ 12.00	
Platform: 9250	Knife Guard, Double Pronged Replaces 7116504, 71386962	AM71341601	\$ 10.00	
Cutting Platforms: 220, 5000	Knife Guard, Double Pronged Replaces 113400M1	AM66603	\$ 17.08	

Header Drive Shafts

Application	Description	Part Number	Retail Price	Core
410, 540, 550	Table Drive Shaft 16.062" Long	AM268316M91	\$ 202.75	
510, 540, 550	Table Drive Shaft 12.50" Long	AM268317M2	\$ 245.14	
760, 860 - w/ Paddle Type Feederhouse	Elevator to Table Drive Shaft 70.125" Long	AM274049M4	\$ 165.57	
1486 Headers	Auger Drive Shaft 13.25" Long	AM260564M1	\$ 28.95	
1859 Headers	Auger Drive Shaft 25.375" Long	AM261456M1	\$ 230.42	
24, 34, 44, 44-0, 54C - Cornheads	Cornhead Main Drive Shaft 41.875" Long	AM263289M1	\$ 123.03	
540*, 550*, 750* ASN 1696-19596, 760* ASN 1746-009-413, 850 BSN 1696-027-544, 860 BSN 1746-019-115 - w/ 18', 20' & 24' 1859 Platforms w/ Floating Cutter Bar *Used with Electrical Variable Speed Reel Drive ASN 1859056180	Header Drive Shaft 27.312" Long	AM245946M1	\$ 170.68	
540, 550, 750 ASN 1696-19596, 760 ASN 1746-009-413, 850 BSN 1696-027-544, 860 BSN 1746-019-115 - w/ 13' 1859 Rigid Platforms ASN 1859056180	Header Drive Shaft 49.875" Long	AM264495M3	\$ 268.40	
540, 550, 750 ASN 1696-19596, 760 ASN 1746-009-413, 850 BSN 1696-027-544, 860 BSN 1746-019-115 - w/ 15' 1859 Rigid Platforms ASN 1859056180 w/ Electrical Variable Speed Reel Drive	Header Drive Shaft 63.125" Long	AM245948M1	\$ 323.19	
410, 510, 540, 550, 750, 760, 850, 860, Corn Heads: 24, 33, 34, 43, 44, 44-0, 54C, 62, 63, 63C, 64, 82, 83, 1124, 1134, 1143, 1144, 1153, 1154, 1163, 1164, 1183	Header Drive Shaft Nut	AM249677M1	\$ 1.55	

Spindles

Spindles are forged from high grades of alloy steel, machined and assembled to exact specifications that meet or exceed OEM specifications.



Application	Description	Part Number	Retail Price	Core
750, 850, 760, 860	Spindle Straight fine splines 1.745" diameter upright shaft	AM274332M91	\$ 71.77	
750, 850, 760, 860	Spindle Heavy Duty, Tapered course splines 1.87" diameter upright shaft	AM280297M92	\$ 302.30	

Massey Ferguson®—Combine







Draper Belts and Components

Application	Description	Part Number	Retail Price	Core
Draper Platforms: 5000, 5200	Draper Belt 18', 41" x 150.50" Single V-Guide	AM700726373	\$ 392.00	
	Draper Belt 22', 41" x 205.55" Single V-Guide	AM700719982	\$ 457.00	
	Draper Belt 25', 41" x 229.25" Overall Dimensions Single V-Guide	AM700726014	\$ 502.00	
	Draper Belt 30', 41" x 289.65" Single V-Guide	AM700719983	\$ 625.00	
	Side Draper Belt 36', Right and Left Hand, 41" x 396"	AM700726007	\$ 847.00	
	Side Draper Belt 36', Right and Left Hand, 41" x 348"	AM700726008	\$ 731.00	
	Draper Platform: 5100	Draper Center Feeder Belt 60" x 57.46"	AM71401899	\$ 459.00
Draper Platform: 9250	Draper Center Feeder Belt 25', 30', 35' or 40', 51.50" x 62.99"	AM71413887	\$ 395.00	
	Side Draper Belt 25', Right and Left Hand, 41" x 243.70" Single V-Guide	AM71483146	\$ 599.00	
	Side Draper Belt 30', Right and Left Hand, 41" x 303.70" Single V-Guide	AM71483144	\$ 724.00	
	Side Draper Belt 35', Right and Left Hand, 41" x 363.70" Single V-Guide	AM71483142	\$ 843.00	
	Side Draper Belt 40', Right and Left Hand, 41" x 423.70" Single V-Guide	AM71483140	\$ 962.00	
Draper Platform: 9250 Flex	Draper Belt Repair Kit For 41" Belt Includes 34" Repair Section of RAPTOR Material, Pre-Punched for Connector, (2) Steel Tube Connectors and Hardware	AM1014724	\$ 159.00	







Lighting

	Application	Description	Part Number	Retail Price	Core
	550, 850, 851, 852, 855, 8570, 8780	Halogen Floodlight, Sealed Beam 4.50" Diameter Round Light 2-Terminal Connection For 12 Volt Systems Replaces A47179, AR104119, E3NN15330AA	AMH7606	\$ 13.25	
	Universal Equipment	LED Floodlight All-Position Light 4.25" x 4.25" Square Light 2650 Lumens, 48 Watts, 4 Amps For 12 Volt to 24 Volt Systems Includes Mounting Bracket and Stainless Steel Hardware	AMTL105F	\$ 95.00	
	Universal Equipment	LED Floodlight All-Position Light 6.25" x 1.75" Rectangle Light 1300 Lumens, 18 Watts, 1.50 Amps For 12 Volt to 24 Volt Systems Includes Mounting Bracket and Stainless Steel Hardware	AMTL118F	\$ 50.00	

Massey Ferguson®—Combine

	Application	Description	Part Number	Retail Price	Core
	Universal Equipment	LED Floodlight All-Position Light 5" Round Light 3200 Lumens, 40 Watts, 3.30 Amps For 12 Volt to 24 Volt Systems Includes Mounting Bracket and Stainless Steel Hardware	AMTL180	\$ 89.00	
	Universal Equipment	LED Floodlight All-Position Light Round Light 6900 Lumens, 50 Watts, 4.10 Amps For 9 Volt to 32 Volt Systems Includes Mounting Bracket and Stainless Steel Hardware	AMTL500F	\$ 120.00	
		LED Floodlight All-Position Light 4.30" Round Light 5040 Lumens, 50 Watts, 4.10 Amps For 12 Volt to 24 Volt Systems Includes Stainless Steel Adjustable Mounting Bracket	AMAT305931	\$ 96.00	
	Universal Equipment	LED Floodlight All-Position Light 4.25" Round Light 2650 Lumens, 42 Watts, 3.50 Amps For 12 Volt to 24 Volt Systems Includes Mounting Bracket and Stainless Steel Hardware	AMTL115F	\$ 59.00	
	Universal Equipment	LED Wide Floodlight All-Position Light 5" x 7" Rectangle Light 3800 Lumens, 35 Watts For 12 Volt to 24 Volt Systems	AMX34171	\$ 60.00	
	Universal Equipment	LED Floodlight, Sealed Beam Fender Mount 4.50" Diameter Round Light 1250 Lumens, 18 Watts, 1.50 Amps Trapezoid Pattern For 12 Volt to 24 Volt Systems	AMTL3010	\$ 40.00	
		LED Floodlight Fender Mount 4.50" Diameter Sealed Beam Round Light 1250 Lumens, 18 Watts, 1.20 Amps Trapezoid Pattern For 12 Volt to 24 Volt Systems Lasts 50 times longer than halogen lighting, vibration resistant w/ no filament failures, uses original mount and wiring, Operating temperature of -40°F to 140°F / -40°C to 60°C	AMRE336111	\$ 35.00	
	Universal Equipment	LED Floodlight Fender Mount 4.50" Diameter Sealed Beam Round Light 1440 Lumens, 18 Watts, 1.60 Amps Lasts 50 times longer than halogen lighting, vibration resistant w/ no filament failures, 2-terminal connection, Operating temperature of -40°F to 140°F / -40°C to 60°C	AMRE336112	\$ 67.75	
	Universal Equipment	LED Floodlight Cab and Fender Mount 3.50" x 6" Rectangle Light 3600 Lumens, 40 Watts, 3 Amps	AMX34146	\$ 65.00	
	8780	LED Floodlight/Spotlight Combo Hood Mount 6" x 4" Rectangle Light Dual Hi/Lo Beam 3500 Lumens, 60 Watts, 5 Amps For 12 Volt to 24 Volt Systems Uses Original Mount and Wiring Includes Connector and Stainless Steel Hardware	AMTL6040	\$ 110.00	



Massey Ferguson®—Combine

Application	Description	Part Number	Retail Price	Core
 Universal Equipment	LED Spotlight All-Position Light 4.25" x 4.25" Square Light 1400 Lumens, 27 Watts, 2.20 Amps For 12 Volt to 24 Volt Systems	AMTL100S	\$ 45.00	
 Universal Equipment	LED Spotlight All-Position Light 6.25" x 1.75" Rectangle Light 1300 Lumens, 18 Watts, 1.50 Amps For 12 Volt to 24 Volt Systems Includes Mounting Bracket and Stainless Steel Hardware	AMTL118S	\$ 50.00	
 Universal Equipment	LED Spotlight All-Position Light Round Light 6900 Lumens, 50 Watts, 4.10 Amps For 9 Volt to 32 Volt Systems Includes Mounting Bracket and Stainless Steel Hardware	AMTL500S	\$ 120.00	
 Universal Equipment	LED Trapezoid Light Cab and Fender Mount 4.50" Diameter Round Light 2800 Lumens, 40 Watts, 3.30 Amps Trapezoid Pattern For 12 Volt to 24 Volt Systems Bottom Mount w/ Built-In Heat Sink Includes Mounting Bracket, Long and Short Rubber Bezels and Stainless Steel Hardware	AMTL2080	\$ 95.00	
	LED Trapezoid Light Cab and Rear Fender Mount 4.50" Diameter Round Light 2800 Lumens, 40 Watts, 3.30 Amps Trapezoid Pattern For 12 Volt to 24 Volt Systems Bottom Mount w/ Built-In Heat Sink Includes Mounting Bracket, Long and Short Rubber Bezels and Stainless Steel Hardware	AMX33121	\$ 76.00	
 Universal Equipment	LED Warning Light Cab, Header or Swather Mount Can be used for Turn Signal, Brake or Running Lights 4.125" Diameter Round Light Double Sided, Amber Lenses 25 Bulbs per Side For 12 Volt to 24 Volt Systems	AMTLFL2	\$ 55.00	
	LED Warning Light Cab, Header or Swather Mount Can be used for Turn Signal, Brake or Running Lights 4.125" Diameter Round Light Double Sided, Amber Lenses 25 Bulbs per Side For 12 Volt to 24 Volt Systems	AMX1910149	\$ 44.00	
 Universal Equipment	LED Warning Light Cab, Header or Swather Mount Can be used for Turn Signal, Brake or Running Lights 4.125" Diameter Round Light Double Sided, Red and Amber Lenses 25 Bulbs per Side For 12 Volt to 24 Volt Systems	AMTLFL3	\$ 55.00	
	LED Warning Light Cab, Header or Swather Mount Can be used for Turn Signal, Brake or Running Lights 4.125" Diameter Round Light Double Sided, Red and Amber Lenses 25 Bulbs per Side For 12 Volt to 24 Volt Systems	AMX33126	\$ 44.00	

Massey Ferguson®—Combine

	Application	Description	Part Number	Retail Price	Core
	Universal Equipment	LED Magnetic Warning Light All-Position Light 360° Flashing Light, Multiple Patterns 9.50" x 6.75" Rectangle Light Magnetic Base or Solid Mount For 12 Volt to 24 Volt Systems Includes Cigarette Lighter Adapter, Wiring and Switch	AMTL1100	\$ 170.00	
	Universal Equipment	LED Magnetic Warning Light All-Position Light 360° Flashing Light, Multiple Patterns 14" x 6.75" Rectangle Light Magnetic Base or Solid Mount For 12 Volt to 24 Volt Systems Includes Cigarette Lighter Adapter, Wiring and Switch	AMTL1200	\$ 190.00	
	Universal Equipment	Warning Beacon 360° Flashing Beacon, Amber Lens For 0.9435" Diameter Pipe Replaces 84337818, AZ44705, AZ101891	AM82018390	\$ 45.64	
	Universal Equipment	LED Warning Beacon 360° Flashing Beacon 2.75" x 5.25" Light Polycarbonate Amber Lens and Housing For 12 Volt to 24 Volt Systems Includes Solid Mounting Pad and Stainless Steel Hardware	AMTL2100	\$ 30.00	
	Universal Equipment	LED Warning Beacon 360° Flashing Beacon, 3 Different Patterns 5" x 10" Light Amber Lens, 48 Watts, 4 Amps For 12 Volt to 24 Volt Systems Brackets Sold Separately	AMX33131	\$ 75.00	
	Universal Equipment	Warning Beacon Bracket	AMX33132	\$ 15.00	
	Universal Equipment	Warning Beacon Bracket	AMX33133	\$ 15.00	
	Universal Equipment	Warning Beacon Bracket	AMX33137	\$ 15.00	
	Universal Equipment	Warning Beacon Bracket	AMX33135	\$ 15.00	

Massey Ferguson®—Combine

Application	Description	Part Number	Retail Price	Core
 Universal Equipment	LED Light Bar 4" Long, 1260 Lumens, Cree Bulbs	AMLED4	\$ 45.00	
	LED Light Bar Flood/Spotlight Combo 10" Long, 5700 Lumens, 50 Watts, 4.20 Amps For 12 Volt to 24 Volt Systems Includes Mounting Bracket and Stainless Steel Hardware	AMTL10SRC	\$ 129.00	
	LED Light Bar Floodlight/Spotlight Combo 14" Long, 5400 Lumens, 72 Watts, 6 Amps Die Cast Aluminum Housing, Polycarbonate Lens For 12 Volt to 24 Volt Systems Includes Mounting Bracket and Heavy Duty Stainless Hardware	AMTLB410C	\$ 150.00	
	LED Light Bar Floodlight/Spotlight Combo 30" Long, 13600 Lumens, 150 Watts, 12.50 Amps For 12 Volt to 24 Volt Systems Includes Mounting Bracket and Stainless Steel Hardware	AMTL30SRC	\$ 230.00	
	LED Light Bar 30" Long, 13860 Lumens, Cree Bulbs	AMLED30	\$ 130.00	
	LED Light Bar Floodlight/Spotlight Combo 40" Long, 17300 Lumens, 200 Watts, 16.70 Amps For 12 Volt to 24 Volt Systems Includes Mounting Brackets and Stainless Steel Hardware	AMTL40SRC	\$ 300.00	
	LED Light Bar 40" Long, 18200 Lumens, Cree Bulbs	AMLED40	\$ 160.00	
	LED Light Bar Floodlight/Spotlight Combo 42" Long, 14500 Lumens, 240 Watts, 19 Amps For 12 Volt to 24 Volt Systems Includes Mounting Bracket and Stainless Steel Hardware Replaces 1163691	AMTLB440C	\$ 250.00	
	LED Light Bar, Curved 50" Long, 21500 Lumens, Cree Bulbs	AMLED50C	\$ 190.00	
	 Universal Equipment	LED Magnetic Work Light All-Position Light 3.25" Square Floodlight 900 Lumens Magnetic Base Includes Lithium Ion Battery, Cigarette Lighter and DC Charger	AMTL2460	\$ 79.00
 Universal Sprayers	LED Blue Work Light 4.25" x 4.50" x 3.00" Rectangle Light 2650 Lumens, 42 Watts, 3.50 Amps For 12 Volt to 24 Volt Systems Includes Stainless Steel Hardware and Mounting Bracket	AMTLFL5	\$ 59.00	







Air Conditioning and Components

Application	Description	Part Number	Retail Price
 8590	Compressor Conversion Kit York Style to Aftermarket Sanden Style Includes Compressor, Mounting Brackets, Compressor Manifold, O-Rings and Mounting Hardware See Manufacturer for Oil Type and Quantity	AMX10263	\$ 450.00
	Premium Synthetic Ester Oil, 100V, 12 oz	AMX10273	\$ 11.00



Massey Ferguson®—Combine

Application	Description	Part Number	Retail Price
 510, 8590, 8680, 9720 Replaces 269925M91, 71371464, 71336550	Compressor, York Style Left Hand Suction, Rotolock Clutch Not Included Requires Synthetic Ester Oil 100V, See Manufacturer for Oil Quantity Double Groove Clutch for York Compressor, 7" Premium Synthetic Ester Oil, 100V, 12 oz	AMX10225 AM470 AMX10273	\$ 260.00 \$ 101.00 \$ 11.00
 540, 550, 750, 760, 850, 860 Replaces 533713M91, 586126M91	Compressor w/ Dust Cover, HD Superheat Compressor, 12 Volt, w/ Single Groove Clutch, 5.58" (142 mm) Clutch Diameter, Can be used for 2 o'clock and 10 o'clock Positions, Must use Original Hoses and Belts, Replaces A6 Style w/ 10 Cylinder Nippondenso 10PA20 Style, Uses Less Power for Greater Efficiency Requires Pag Oil 46V, 7.00 oz (207 cc) Ultra Pag Double End Capped, 46V, 8 oz	AMX10223 AMX10266	\$ 390.00 \$ 12.00
 540, 550 BSN 236305, 750 ASN 169609674, 760 ASN 174605829, 850 BSN 1696025657, 860 BSN 1746016558	Compressor, A6 Style Superheat Compressor w/ Superheat Switch, 12 Volt, 5.58" Clutch Diameter, Coil Mounted at 2 o'clock Position	AMX10133	\$ 585.00
 8460 ASN 7800201	Compressor, York Style Right Hand Suction, O-Ring Fitting, Clutch Not Included Requires Synthetic Ester Oil 100V, 9.50 oz (281 cc) Double Groove Clutch for York Compressor, 7" Premium Synthetic Ester Oil, 100V, 12 oz	AMX10177 AM470 AMX10273	\$ 225.00 \$ 101.00 \$ 11.00
 8680 ASN SX65101, 8780 ASN MJ7101	Compressor, Sanden 12 Volt, w/ 2-Groove Clutch, 5.25" (133 mm) Clutch Diameter, Vertical Tube O-Ring, w/o Charge Ports Requires Synthetic Ester Oil 100V, 8.11 oz (240 cc) Premium Synthetic Ester Oil, 100V, 12 oz	AMX10130 AMX10273	\$ 365.00 \$ 11.00
 8680, 8780, 9790	Compressor, Sanden SD7H15 12 Volt, w/ 2-Groove Clutch, 5.25" (133 mm) Clutch Diameter, Horizontal Tube O-Ring, w/o Charge Ports Requires Synthetic Ester Oil 100V, 10.14 oz (300 cc) Premium Synthetic Ester Oil, 100V, 12 oz	AMX10187 AMX10273	\$ 270.00 \$ 11.00
 510, 750, 760	Compressor Clutch, 6.70" 12 Volt Coil, Single Groove 5/8" Belt, Warner	AM274363M91	\$ 259.49
 Universal Equipment	High Pressure Switch Normally Open, Opens at 305 PSI, Closes at 395 PSI, 7/16"x20 Thread	AMX10276	\$ 35.00
 Universal Equipment	Low Pressure Switch Normally Open, Opens at 6 PSI, Closes at 45 PSI, Standard 7/16"x20 Thread	AMX10277	\$ 55.00
 Universal Equipment	Low Pressure Switch Normally Open, Opens at 35 PSI, Closes at 46 PSI, Standard 7/16"x20 Thread	AMX10278	\$ 42.00
 410 ASN 1200011754, 510 ASN 1201011838, 540, 750 SN 169601206- 1696016538, 760 ASN 174607532 Replaces 250698M1, 3320059M2	Rotary Adjustable Thermostatic Switch 36" Capillary Tube	AMX10251	\$ 45.00
 750, 760 Replaces 250929M1	Receiver Drier 3" x 6" Male Flare, R12 and R134a Compatible	AMX10211	\$ 22.00

Massey Ferguson®—Combine

	Application	Description	Part Number	Retail Price
	8560, 8570 BSN 511100, 8590, 9720 Replaces 3347710W1	Receiver Drier 3" x 8 1/4" Male Flare, Female Switch Port - OE Parker, R12 and R134a Compatible	AM72161835	\$ 30.00
	8680, 8780, 9690, 9790 Replaces 71369761	Receiver Drier 3" x 10 1/2" Male O-Ring, R12 and R134a Compatible	AMX10218	\$ 26.00
	510, 750, 760 Replaces 529876M91, 250902M1	Expansion Valve Internally Regulated w/ 12" Capacity Tube w/ Flare Connection, R12 and R134a Compatible	AMX10215	\$ 30.00
	32, 36, 40 Replaces 3900465M91	Blower Motor w/ Wheels 12 Volt, 2-Wire, 5/16" Shaft Diameter	AM3310831M91	\$ 110.00
	750 ASN 1696013713, 760 w/ Early Style	Blower Motor Switch, 3-Speed	AM271105M1	\$ 6.50
	Swathers: WR9735, WR9740, WR9760, WR9770, WR9840, WR9860, WR9870	Condenser w/ Fuel Cooler Core: 33" x 7" x 5"	AM700733990	\$ 450.00

Cornhead—Fenders and Snouts

	Application	Description	Part Number	Retail Price	Core
	Models w/ Poly Snout	Poly Skid Bubble Tip	Outside Snout AMX27150	\$ 18.50	
	Models w/ Poly Snout	Poly Skid Bubble Tip	Inside Snout AMX27151	\$ 18.50	
	Most Models	Poly Gathering Chain Guard 8.90" x 23" - Red, Includes Hardware	AMX27153	\$ 21.00	

Cornhead—Auger Liners

Will need to trim liner for proper fit.









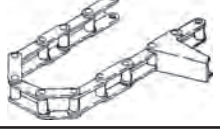
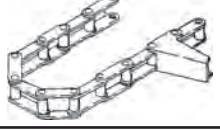

Application	Description	Part Number	Retail Price	Core
30" Row	4 Row Poly Auger Liner	AMX27129	\$ 260.00	
	6 Row Poly Auger Liner	AMX27130	\$ 299.00	
	8 Row Poly Auger Liner	AMX27131	\$ 367.00	
	12 Row Poly Auger Liner	AMX27132	\$ 578.00	

Massey Ferguson®—Combine

Cornhead—Stalk Stomper and Components

Application	Description	Part Number	Retail Price	Core
3000 Series	Stalk Stomper Kit, 2 Row Covers 1 Row on Each side of Cornhead	AMX31077	\$ 1200.00	
	Stalk Stomper Kit, 4 Row Covers 2 Rows on Each side of Cornhead	AMX31078	\$ 1600.00	
	Stalk Stomper Kit, 6 Row Covers 3 Rows on Each side of Cornhead	AMX31079	\$ 2225.00	
	Stalk Stomper Kit, 6 Row Covers 3 Rows on Each side of Cornhead	AMX31080	\$ 2775.00	
	Stalk Stomper Kit, 12 Row Covers 6 Rows on Each side of Cornhead	AMX31081	\$ 3650.00	
	Header Mounting Bracket Accommodates 2" x 2" Square Toolbar	AMX30029	\$ 120.00	

Cornhead—Row Unit Components

	Application	Description	Part Number	Retail Price	Core
	33, 43, 63, 63C, 1143, 1153, 1163, 1183	Gathering Chain	AM241090M91	\$ 65.00	
	9000 ASN 47000	Gathering Chain	AM1689933W91	\$ 115.00	
	3000	Gathering Chain	AM71505705	\$ 40.00	
	24, 33, 34, 43, 44, 44-0, 54C, 62, 63, 63C, 64, 82, 83, 1124, 1134, 1143, 1144, 1153, 1154, 1163, 1164, 1183	Cornhead Flute 2 Required per Shaft	AM264687M2	\$ 18.25	
	24, 33, 34, 43, 44, 44-O, 54, 54C, 62, 63, 63C, 64, 82, 83	LH Stripper Plate	AM263450M93	\$ 75.00	
	1100 Series	LH Stripper Plate	AM267392M92	\$ 118.45	
	24, 33, 34, 43, 44, 44-O, 54, 54C, 62 ASN 1438001025, 63, 63C, 64, 82 ASN 1438010055, 83	RH Stripper Plate Check Model and SN Before Ordering	AM263453M92	\$ 108.23	
	24 ASN 1438052240, 33 ASN 1438020460, 34 ASN 1438060539, 43 ASN 1438030616, 62 ASN 1438001000, 63 ASN 1438040217, 64, 82 ASN 1438010030, 83	Lower Idler Sprocket 8 Tooth, 1/2" ID	AM263282M1	\$ 44.00	
	1144, 1154, 1163, 1183	Lower Idler Sprocket 8 Tooth, 5/8" ID	AM844076M2	\$ 34.77	
	9000	Lower Idler Sprocket 10 Tooth, 5/8" ID	AM1689940W1	\$ 63.69	
	24, 33, 34, 43, 44, 44-0, 54C, 62, 63, 63C, 64, 82, 83, 1124, 1134, 1143, 1144, 1153, 1154, 1163, 1164, 1183	Snapper Roll Shaft 26.062" Long Has splines on the upper end of shaft	AM267507M1	\$ 206.23	
	24, 33, 34, 64, 222, 321, 1143, 1144	Snapping Roll Shaft Bearing 1.25" ID, 2.8346" OD	AM833356M1	\$ 19.90	

Massey Ferguson®—Combine

Application	Description	Part Number	Retail Price	Core
63	Main Drive Shaft 47 11/32" Long	AM263287M1	\$ 58.10	
1163	Upper Drive Shaft, Left Hand 62.062" Long, Early Style w/ Woodruff Key 1"-20 NFT and 7/8" 20-NFT Threads	AM267718M3	\$ 366.99	

Belts - 885 Swather

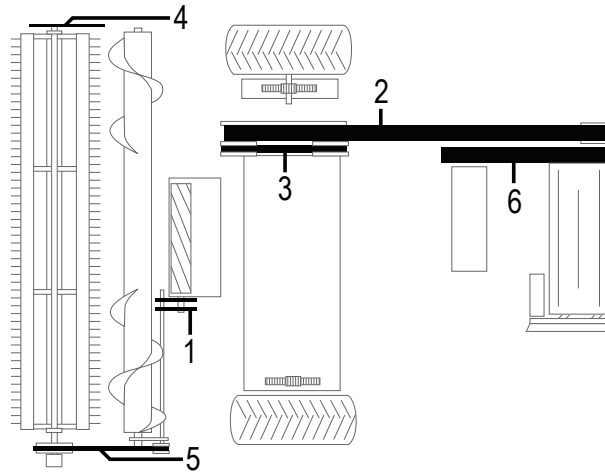

Application	Description	Part Number	Retail Price
1 885 (S/N G)	Conditioner Set of 2	AM1071847M1	\$ 50.00
2 885	Header Drive	AM24370	\$ 173.67
4 885 (S/N C, D, E)	Reel	AM1056914M1	\$ 46.00
5 885 (S/N C, D, E)	Sickle Drive	AM1056877M1	\$ 37.53
6 885	Traction Drive	AM1056409M1	Call for Price
NI 885	Sickle	AM10771684M1	Call for Price

Massey Ferguson®—Combine

Belts—300

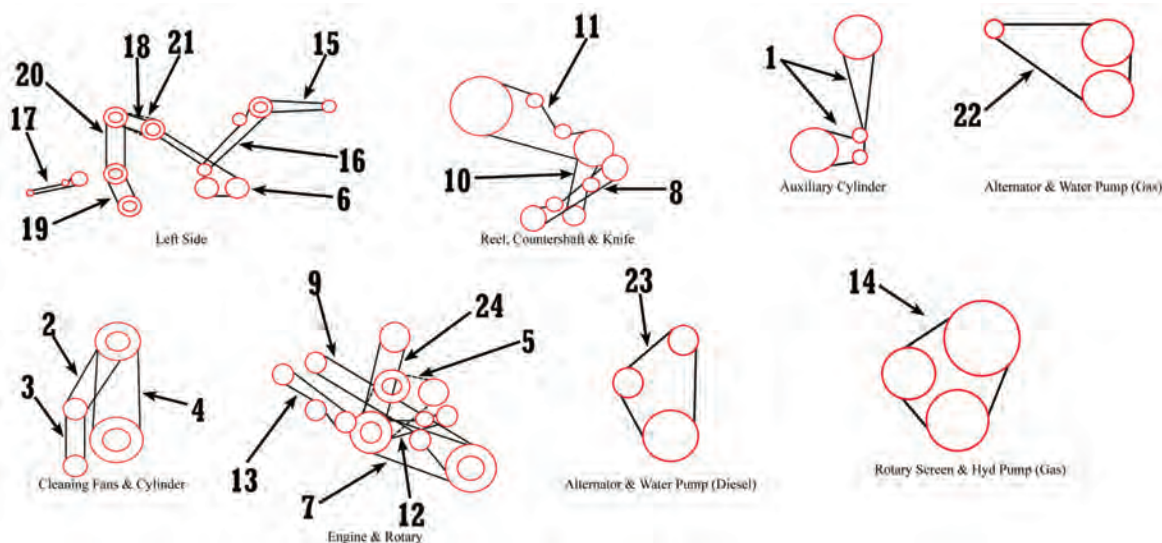

Application	Description	Part Number	Retail Price
1 300	Auxiliary Cylinder	AM832822M1	\$ 23.31
2 300	Cleaning Fan	AM832877M1	\$ 10.26
3 300	Cleaning Fan, Lower	AM832876M1	\$ 26.71
3 300	Cleaning Fan, RH Grass Seed	AMGH5047	\$ 9.92
4 300	Cylinder	AM832873M1	\$ 97.00
5 300 BSN 12989	Generator & Water Pump, Diesel	AM236959M1	\$ 8.17
6 300	Grain & Return Auger	AM832866M2	\$ 56.00
7 300	Hydraulic Pump	AM230381M1	\$ 17.53
8 300 BSN 13989	Knife	AM832869M1	\$ 32.75
8 300 S/N 13939-32098	Knife	AM834058M1	\$ 32.00
8 300 ASN 32098	Knife	AM834190M1	\$ 24.25
9 300 BSN 12989	Radiator Fan, Gas	AM236670M1	\$ 6.50
9 300	Radiator Fan, Diesel	AM236958M1	\$ 8.75
10 300	Reel Countershaft	AM834139M1	\$ 21.75
11 300 BSN 5818	Reel	AM832872M1	\$ 28.00
11 300 ASN 13989	Reel	AM834140M1	\$ 44.09
11 300	Reel, Variable Speed	AM833768M1	\$ 32.00
12 300	Rotary Screen Countershaft, Diesel	AM832896M1	\$ 6.50
13 300	Rotary Screen Countershaft, Gas	AM832895M2	\$ 8.83
14 300 ASN 12989	Rotary Screen Hyd Pump, Gas	AM834148M1	\$ 7.00
15 300	Straw Spreader	AM832855M1	\$ 26.00
16 300	Straw Walker	AM832867M1	\$ 39.00
17 300 ASN 13989	Table, Platform Set of 2	AM228147M91	\$ 115.65
17 300 BSN 13989	Table, Platform	AM832870M1	\$ 38.95
18 300	Tank Unloader	AM832878M1	\$ 24.28
19 300	Traction Lower, Grain	AM832789M3	\$ 65.23
19 300	Traction Lower, Rice	AM832965M1	\$ 69.00
20 300	Traction, Upper	AM832790M3	\$ 95.00
NI 300	Countershaft, Straw Chopper	AM1033078M1	\$ 69.00
NI 300 ASN 12989	A/C or Clean Fan High Speed	AM834492M2	\$ 10.67

Massey Ferguson®—Combine

Application	Description	Part Number	Retail Price
NI 300 S/N 5818-13989	Grain Auger	AM227984M1	\$ 36.41

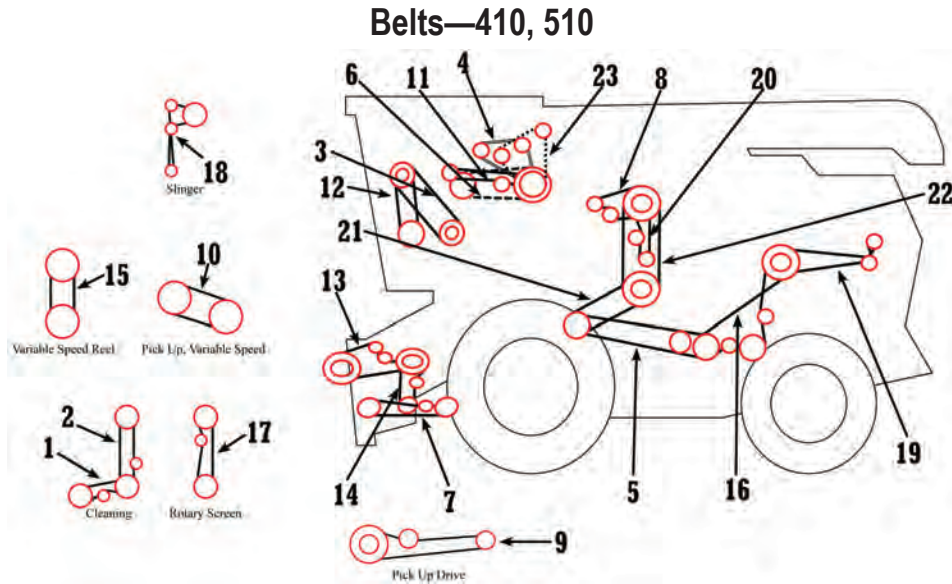

Application	Description	Part Number	Retail Price
1 410, 510	Cleaning Fan	AM227976M1	\$ 12.25
1 410 ASN 1200 006777, 510	A/C or Clean Fan, High Speed	AM834492M2	\$ 10.67
2 410 BSN 1200 0150163, 510 BSN 1201 09077	Cleaning Fan Countershaft	AM1855008M1	\$ 46.55
3 410, 510	Cylinder Drive	AM226981M1	\$ 80.74
4 510 Gas	Governor	AM234995M1	\$ 5.23
4 410	Governor	AM238891M1	\$ 6.95
5 410, 510	Grain Auger	AM227984M1	\$ 36.41
6 410, 510	Hydraulic Pump, Gas	AM230380M1	\$ 18.05
6 510	Hydraulic Pump, Diesel	AM230381M1	\$ 17.53
6 410	Hydraulic Pump, Diesel	AM832490M1	\$ 31.20
7 410 BSN 1200 0150163, 510 BSN 1201 09077	Knife Wobble	AM833128M1	\$ 44.50
7 510 BSN 1201 09077	Knife Wobble, Table	AM834057M1	\$ 28.00
7 410, 510	Knife Wobble	AM834058M1	\$ 32.00
7 510 S/N 1859 037752	Knife Wobble, Table	AM834190M1	\$ 24.25
8 510 Gas	Drive	AM230355M2	\$ 179.00
8 510 Diesel	Drive	AM230356M4	\$ 187.00
8 410 Diesel	Main Drive	AM233213M2	\$ 187.00
8 410 Gas	Main Drive	AM238887M2	\$ 140.00
9 410, 510 BSN 1485 2394	Pick Up 112" w/ Forward PU	AM1027752M1	\$ 31.81
11 410, 510	Radiator Fan	AM240575M2	\$ 13.00
12 410 BSN 4202, 510 BSN 902	Rear Beater	AM227978M2	\$ 97.00
12 410 ASN 4202, 510 ASN 902	Rear Beater	AM240447M3	\$ 99.00
13 410 Grain ASN 1200 015063, 510 ASN 1201 009077	Reel	AM834140M1	\$ 44.09
14 410 ASN 1200 0150163, 510 ASN 1201 09077	Reel Countershaft	AM834139M1	\$ 21.75
15 410 ASN 6777, 510	Reel, Variable Speed	AM833768M1	\$ 32.00
16 410, 510	Return Auger & Walker	AM227986M2	\$ 36.68
17 410, 510	Rotary Screen	AM228722M1	\$ 21.00
18 410 S/N 1200 000001-120 011754, 510	Slinger (For Field Install Kit)	AM222347M1	\$ 14.24

Prices Subject to Change without Prior Notice. The use of original equipment manufacturer (OEM) part numbers or trademarks, e.g. Case® and John Deere®, are for reference purposes only and for indicating product use and compatibility. Our company and the listed replacement parts contained herein are not sponsored, approved or manufactured by the OEM. All parts are New unless designated Reman in the description.

Massey Ferguson®—Combine

Application	Description	Part Number	Retail Price
18 410 BSN 1200 011754, 510 Driven BSN 1201 007358	Slinger	AM228999M1	\$ 15.00
18 410 S/N 1200 011754-1200 015063, 510 Driven S/N 1201 007358-1201 009077	Slinger	AM833742M1	\$ 17.86
18 410 BSN 1200 011754, 510	Aux Cyl (Slinger), Use w/ Field Install Kit	AM834332M1	\$ 17.86
19 410 BSN 1200 15177, 510 BSN 1201 009156	Straw Spreader (Dual)	AM832446M1	\$ 22.06
19 510	Straw Spreader (Single)	AM833131M1	\$ 28.41
19 410 ASN 1200 2940	Straw Spreader (Single)	AM833563M1	\$ 38.00
19 410 ASN 1200 15177, 510 ASN 1200 9156	Straw Spreader (Dual)	AM834254M1	\$ 68.59
20 410, 510	Tank Unloader	AM228813M3	\$ 21.67
21 410, 510	Traction, Lower (Grain)	AM834174M1	\$ 68.47
21 410, 510	Traction, Lower (Rice)	AM230097M2	\$ 107.72
22 410, 510	Traction, Upper	AM834110M1	\$ 110.00
23 410, 510 BSN 1201 009077	Water Pump & Generator, Diesel	AM230350M1	\$ 4.87
23 410	Water Pump & Generator Diesel	AM236959M1	\$ 8.17
23 410 BSN 1200 0150163, 510 BSN 1201 09077	Water Pump & Alternator	AM252164M1	\$ 12.60
NI 410 Rice BSN 1200 11753, 510 Rice BSN 1201 9156	Chopper Drive, Straw	AM1033137M1	\$ 73.21
NI 410 ASN 1200 11756	Chopper Drive	AM1033199M1	\$ 87.93
NI 510 ASN 1201 19156	Chopper Drive	AM1036940M1	\$ 135.00
NI 510	Pick Up Drive, 67"	AM1047702M1	\$ 28.45

Belts—540

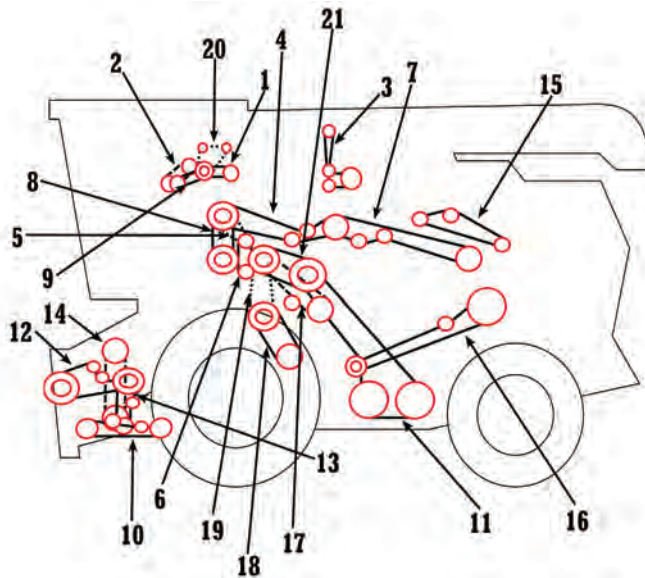

Application	Description	Part Number	Retail Price
1 540	Air Conditioning	AM843045M1	\$ 8.98
2 540	Air Intake	AM240575M2	\$ 13.00
3 540	Aux Cyl (Slinger)	AM834332M1	\$ 17.86
4 540	Chopper Drive, Low Speed	AM843759M1	\$ 60.08
4 540	Chopper Drive, High Speed	AM843760M1	\$ 50.00
5 540	Cleaning Fan	AM832877M1	\$ 10.26
6 540	Cleaning Fan, Countershaft	AM228997M1	\$ 16.61
7 540	Countershaft Drive	AM843758M1	\$ 83.65

Massey Ferguson®—Combine

Application	Description	Part Number	Retail Price
8 540	Cylinder	AM832873M1	\$ 97.00
9 540	Hydraulic Pump	AM230380M1	\$ 18.05
10 540	Knife Wobble, 13' Rigid Bar High Speed	AM832085M1	\$ 36.90
10 540	Knife Wobble, Floating Cut Bar	AM833962M1	\$ 55.00
10 540	Knife Wobble, Rigid Cut Bar	AM834190M1	\$ 24.25
10 540	Knife Wobble, Speed Up 15', 16', 18', 20'	AM843029M1	\$ 33.00
11 540	Rear Beater or Straw Chopper	AM843747M1	\$ 78.50
12 540	Reel	AM834140M1	\$ 44.09
13 540	Reel Countershaft	AM834139M1	\$ 21.75
14 540	Reel, Variable Speed	AM833768M1	\$ 32.00
15 540	Straw Spreader	AM843742M1	\$ 25.84
16 540	Straw Walker	AM832867M1	\$ 39.00
17 540	Tank Unloader	AM832878M1	\$ 24.28
18 540 ASN 2428 00819	Traction Drive, Lower	AM843732M2	\$ 73.30
19 540 BSN 2428 00819	Traction Drive, Upper	AM832790M3	\$ 95.00
19 540 ASN 2428 00819	Traction Drive, Upper	AM844091M1	\$ 71.00
20 540 BSN 1856	Water Pump, Fan, Alternator Set of 2	AM532779M92	\$ 19.00
20 540 ASN 1857	Water Pump, Fan, Alternator	AM844171M1	\$ 5.37
NI 540	Pick Up	AM1047702M1	\$ 28.45
NI 540	Main Drive	AM236370M2	\$ 274.00

Belts—550

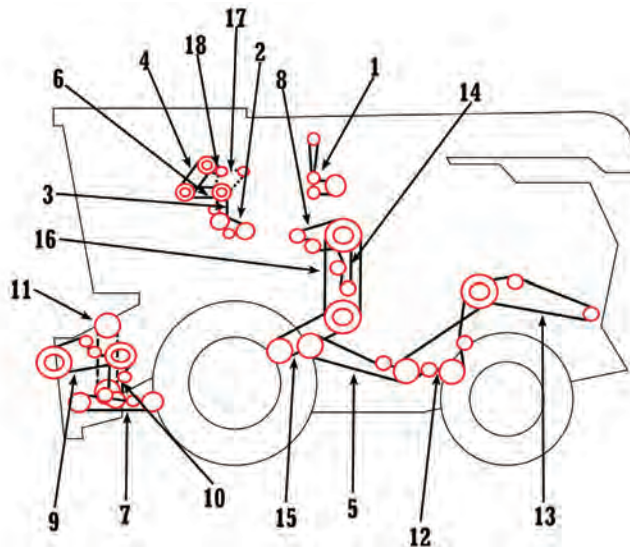

Application	Description	Part Number	Retail Price
1 550	Aux Cyl (Slinger)	AM834332M1	\$ 17.86
2 550	Cleaning Fan	AM227976M1	\$ 12.25
2 550	Cleaning Fan, High Speed	AM834492M2	\$ 10.67
3 550	Cleaning Fan Countershaft	AM1855008M1	\$ 46.55
4 550	Cylinder	AM226981M1	\$ 80.74
5 550	Grain Auger	AM227984M1	\$ 36.41
6 550	Hydraulic Pump	AM843737M1	\$ 12.19

Massey Ferguson®—Combine

Application	Description	Part Number	Retail Price
7 550	Knife Wobble, Rigid Cut Bar	AM195671M1	\$ 29.33
7 550	Knife Wobble, Floating Cut Bar	AM833962M1	\$ 55.00
7 550	Knife Wobble, Centered Chain Drive	AM834058M1	\$ 32.00
7 550	Knife Wobble, Rigid Cut Bar	AM834190M1	\$ 24.25
8 550	Main Drive	AM230356M4	\$ 187.00
9 550	Reel	AM834140M1	\$ 44.09
10 550	Reel Countershaft	AM834139M1	\$ 21.75
11 550	Reel, Variable Speed	AM833768M1	\$ 32.00
12 550	Return Auger & Walker	AM227986M2	\$ 36.68
13 550	Straw Spreader (Dual)	AM834254M1	\$ 68.59
14 550	Tank Unloader	AM228813M3	\$ 21.67
15 550	Traction Drive, Non-Hydro, Lower, 4 Speed	AM230097M2	\$ 107.72
15 550	Traction Drive, Non-Hydro, Lower, 3 Speed	AM834174M1	\$ 68.47
15 550	Traction Drive, Hydro Lower	AM834176M1	\$ 60.96
16 550	Traction Drive, Upper, 3 & 4 Speed	AM834110M1	\$ 110.00
16 550	Traction Drive, Hydro, Upper	AM834175M1	\$ 86.06
17 550 ASN 2363 05307	Water Pump, Fan and Alternator	AM268847M91	\$ 18.00
17 550 BSN 5307	Water Pump, Fan and Alternator	AM532779M92	\$ 19.00
NI 550	Pick Up	AM1047702M1	\$ 28.45
NI 550	Chopper Drive	AM1051235M1	\$ 110.19
NI 550	Straw Chopper Corn Kit, Low Speed	AM842935M1	\$ 17.65

Belts—750, 760

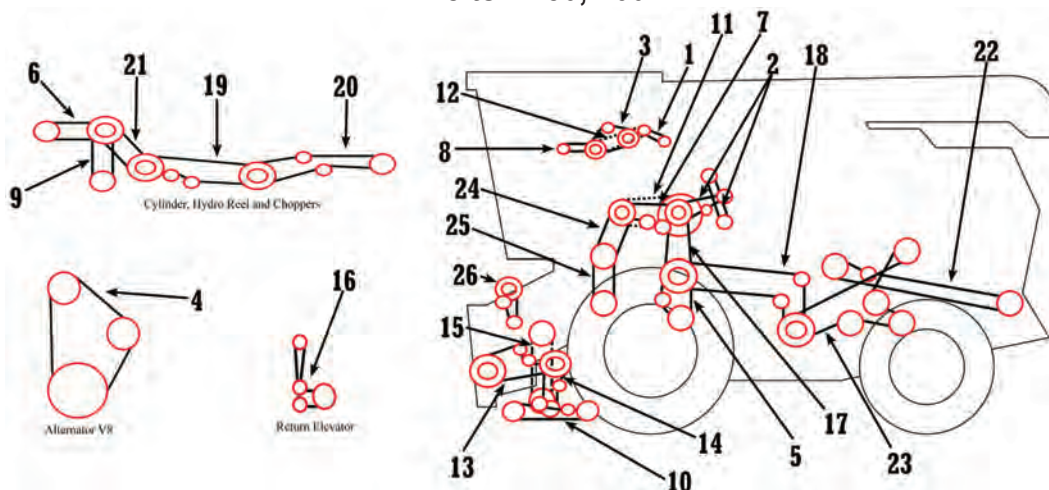

Application	Description	Part Number	Retail Price
1 750 S/N 1696 00964-1696 015420, 760 S/N 1746 05829-1746 07663	Air Conditioning	AM843045M1	\$ 8.98
1 750 BSN 1696 009674, 760 BSN 1746 05829	Air Conditioning	AM834492M2	\$ 10.67
1 750 S/N 1696015420, 760 S/N 174605829-174607663	Air Conditioning w/ Frigidare Compressor	AM843045M1	\$ 8.98
2 750 BSN 1696 013713	Air Intake	AM216897M1	\$ 17.43
2 760 BSN 1746 09413	Air Intake	AM833867M1	\$ 11.00
3 750 Diesel ASN 1696 016539, 760 6 Cyl ASN 1746 009413	Alternator	AM844079M1	\$ 5.88
4 760 ASN 13173	Alternator, V-8	AM3040950M91	\$ 18.69
4 760 BSN 13173	Alternator, V-8	AM844163M1	\$ 10.00

Massey Ferguson®—Combine

Application	Description	Part Number	Retail Price
5 750, 760	Cleaning Fan Drive	AM833863M1	\$ 24.50
5 750, 760	Cleaning Fan Drive, Small Seed Kit	AM842423M1	\$ 48.00
6 750, 760	Cylinder	AM833868M2	\$ 135.00
7 760	Grain Tank Unloader	AM833862M3	\$ 97.00
7 750	Grain Tank Unloader	AM833873M1	\$ 48.00
8 750 BSN 1696 05387, 760 S/N 1746 00511-1746 02474	Hydraulic Pump Drive	AM222882M2	\$ 10.00
8 750 ASN 5387, 760 ASN 1746 02474	Hydraulic Pump Drive	AM842413M2	\$ 10.80
8 760 BSN 1746 00511	Hydraulic Pump Drive	AM842464M2	\$ 44.16
9 750, 760	Hydrostatic Reel	AM842845M1	\$ 17.55
10 760 ASN 1746 009413	Wobble Box, w/ 30" Table	AM210774M1	\$ 30.00
10 760 ASN 1746 009413	Knife Wobble, 13' Rigid Bar Speed Up Kit	AM832085M1	\$ 36.90
10 760 ASN 1746 009413	Knife Wobble, Floating Cut Bar	AM833962M1	\$ 55.00
10 760 BSN 1859 32098	Knife Wobble, 13' Rigid Cut Bar	AM834058M1	\$ 32.00
10 750, 760 ASN 1746 009413	Knife Wobble, 15' to 24' Rigid Cut Bar	AM834190M1	\$ 24.25
10 750, 760	Wobble Box, w/ Draper Table	AM842809M1	\$ 109.89
11 760	Main Drive	AM833865M1	\$ 141.00
11 750	Main Drive	AM833874M1	\$ 145.00
12 750	Radiator Fan	AM265522M91	\$ 17.62
12 760 ASN 1746 07663	Radiator Fan	AM259047M91	\$ 21.50
12 760 BSN 1746 00511	Radiator Fan, Left Side Engine	AM833869M1	\$ 13.99
12 760 BSN 1746 00511	Radiator Fan, Right Side Engine	AM833870M1	\$ 20.85
13 750, 760	Reel Drive	AM834140M1	\$ 44.09
14 750, 760	Reel Countershaft Drive	AM834139M1	\$ 21.75
15 750, 760	Reel, Variable Speed	AM833768M1	\$ 32.00
16 750, 760	Return Elevator Drive	AM833854M2	\$ 35.00
17 750 BSN 1696 015716, 760 BSN 1746 009413	Shaker Shoe Countershaft Fan Drive Set of 2	AM274015M91	\$ 36.00
17 750 ASN 1696 015716, 760 ASN 1746 009413	Shaker Shoe Countershaft Fan Drive	AM281560M91	\$ 40.20
18 750, 760	Shaker Shoe Drive Set of 2	AM273757M91	\$ 103.00
19 750 BSN 1696 016439, 760 BSN 9413	Straw Chopper	AM832866M2	\$ 56.00
19 750 ASN 1696 016439, 760 ASN 1746 09413	Straw Chopper	AM843747M1	\$ 78.50
20 760 ASN 1746 009413	Straw Chopper Drive	AM832906M1	\$ 44.50
20 750 BSN 1696 01639, 760 BSN 1746 09413	Straw Chopper Drive	AM833872M1	\$ 60.00
21 750 BSN 1696 016539, 760 BSN 1746 09413	Straw Chopper Drive	AM833871M1	\$ 67.00
21 750 ASN 1696 016539, 760 ASN 1746 09413	Straw Chopper Drive	AM843948M1	\$ 84.00
22 750, 760	Straw Spreader	AM842110M1	\$ 36.16
23 750	Straw Walker	AM833855M1	\$ 48.25
23 760	Straw Walker	AM833860M1	\$ 78.00
24 750 BSN 16539	Traction, Upper, 4 Speed	AM833856M1	\$ 101.11
24 750 S/N 05387-13713	Traction, Upper, 4 Speed, Cog	AM833857M4	\$ 132.00
24 750, 760 BSN 1746 02474	Traction, Upper, 4 Speed	AM833858M4	\$ 74.00
24 760	Traction, Upper, Hydro	AM833866M1	\$ 85.00
24 750	Traction, Upper, Hydro	AM844077M1	\$ 135.52
25 760	Traction, Upper, 4 Speed	AM833858M4	\$ 74.00
25 750 ASN 13713	Traction, Lower, 4 Speed, Cog	AM833859M4	\$ 82.00
25 750 ASN 16539, 760	Traction, Lower, Hydro	AM833866M1	\$ 85.00
NI 750, 760 BSN 1746 009413	Straw Chopper Corn Kit	AM842935M1	\$ 17.65

Prices Subject to Change without Prior Notice. The use of original equipment manufacturer (OEM) part numbers or trademarks, e.g. Case® and John Deere®, are for reference purposes only and for indicating product use and compatibility. Our company and the listed replacement parts contained herein are not sponsored, approved or manufactured by the OEM. All parts are New unless designated Reman in the description.

Massey Ferguson®—Combine

Belts—850, 860

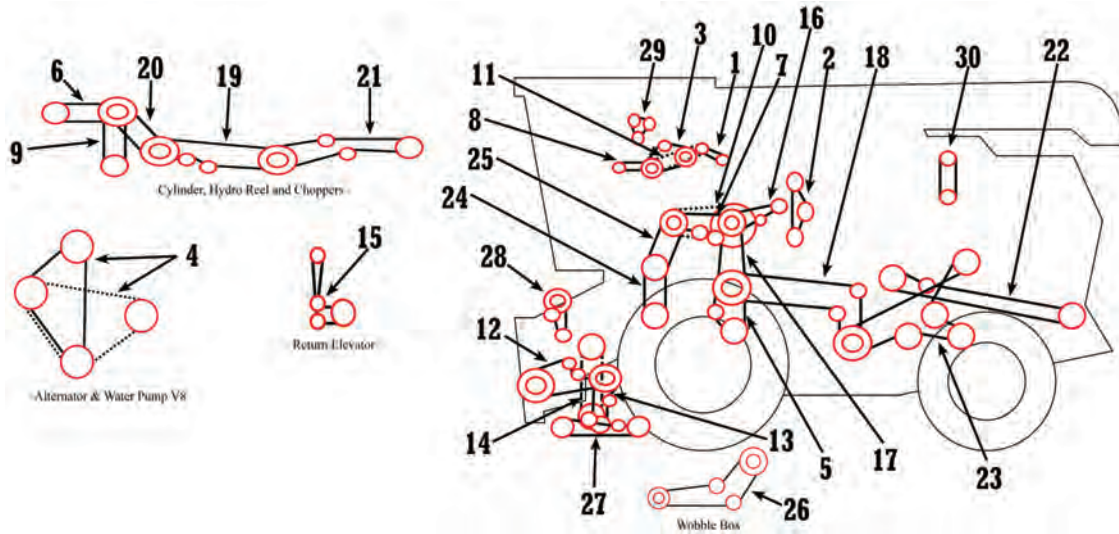

Application	Description	Part Number	Retail Price
1 850 ASN 1696 25658	Air Conditioning	AM1614371M1	\$ 9.27
1 850 BSN 1696 25658, 860 w/ Frigidaire	Air Conditioning	AM529964M1	\$ 12.35
2 850	Air Intake	AM844307M1	\$ 13.75
2 860	Countershaft to Rotary Screen	AM844306M1	\$ 14.30
3 850, 860	Alternator, 6-Cylinder	AM844079M1	\$ 5.88
4 860	Alternator & Water Pump, V-8 Engine	AM844163M1	\$ 10.00
5 850, 860	Cleaning Fan	AM833863M1	\$ 24.50
5 850, 860	Cleaning Fan, Small Seed Kit	AM842423M1	\$ 48.00
6 850, 860	Cylinder Drive	AM833868M2	\$ 135.00
7 860	Grain Tank Unloader	AM833862M3	\$ 97.00
7 850	Grain Tank Unloader	AM833873M1	\$ 48.00
8 850, 860	Hydraulic Pump	AM842413M2	\$ 10.80
9 850, 860	Hydrostatic Reel	AM842845M1	\$ 17.55
10 860	Main Drive	AM833865M1	\$ 141.00
10 850	Main Drive, 3 Band	AM833874M1	\$ 145.00
10 850	Main Drive, 4 Band	AM844475M1	\$ 123.00
11 850	Radiator Fan	AM265522M91	\$ 17.62
11 860 BSN 1746 016559	Radiator Fan	AM259047M91	\$ 21.50
11 860 ASN 1746 016559	Radiator Fan	AM284633M91	\$ 27.03
12 850, 860	Reel	AM834140M1	\$ 44.09
13 850, 860	Reel Countershaft	AM834139M1	\$ 21.75
14 850	Reel, Variable Speed	AM833768M1	\$ 32.00
15 850, 860	Return Elevator	AM833854M2	\$ 35.00
16 860	Rotary Screen Countershaft	AM833867M1	\$ 11.00
17 850, 860	Shaker Shoe Countershaft Fan	AM281560M91	\$ 40.20
18 850, 860	Shaker Shoe Set of 2	AM273757M91	\$ 103.00
19 850, 860	Straw Chopper, Center	AM843747M1	\$ 78.50
20 850, 860	Straw Chopper, Front	AM843948M1	\$ 84.00
21 850, 860	Straw Chopper, Rear, 199" Long	AM843760M1	\$ 50.00
21 860	Straw Chopper, Rear, 224" Long	AM844496M1	\$ 88.00
22 850, 860	Straw Spreader, Rear	AM842110M1	\$ 36.16
23 860	Straw Walker	AM843302M1	\$ 61.00
23 850	Straw Walker	AM843310M1	\$ 56.00
24 850 ASN 1696 27544	Traction Drive, 4 Speed, Lower	AM280071M1	\$ 164.00

Massey Ferguson®—Combine

Application	Description	Part Number	Retail Price
24 860 ASN 1746 019115	Traction Drive, 4 Speed, Lower	AM833857M4	\$ 132.00
24 860 BSN 1746 019115	Traction Drive, 4 Speed, Lower	AM833858M4	\$ 74.00
24 850 BSN 1696 27544	Traction Drive, 4 Speed, Lower	AM833859M4	\$ 82.00
24 850 Hydro, 860	Traction Drive, Hydro, Lower	AM833866M1	\$ 85.00
24 860	Traction Drive, Hydro, Lower	AM844336M1	\$ 141.00
25 850, 860	Traction Drive, 4 Speed, Upper	AM833858M4	\$ 74.00
25 850 ASN 1696 27544, 860	Traction Drive, Upper	AM833866M1	\$ 85.00
25 850 BSN 1696 27544	Traction Drive, Hydro, Upper	AM844077M1	\$ 135.52
25 860	Traction Drive, Hydro, Upper	AM844336M1	\$ 141.00
26 860 - 130"	Wobble Box, 22' Floating w/ 6 Mounting Bracket	AM227455M1	\$ 36.00
26 860 - 126"	Wobble Box, 22' Floating w/ 6 Mounting Bracket	AM832832M1	\$ 72.50
26 860 - 120"-123"	Wobble Box, 15'-20' Floating Bar	AM833962M1	\$ 55.00
27 850, 860 w/ 15'-20' Table - 92"	Wobble Box, Rigid Cut Bar Speed Up	AM195671M1	\$ 29.33
27 850, 860 - 100 1/2"	Wobble Box, w/ 22' & 24' Rigid Cut Bar	AM210774M1	\$ 30.00
27 850	Wobble Box, 22' Floating Cutter Bar	AM227455M1	\$ 36.00
27 850	Knife Wobble, 15'-20' Float Cutter Bar	AM833962M1	\$ 55.00
27 850, 860 - 88 3/4"	Knife Wobble, Rigid 15' to 24', 1859 Table	AM834190M1	\$ 24.25
27 860	Draper Table	AM842809M1	\$ 109.89
NI 860	Oil Cooler Fan	AM3040966M1	\$ 13.00
NI 850	Straw Chopper Corn Kit	AM842935M1	\$ 17.65

Belts—8560, 8570, 8780

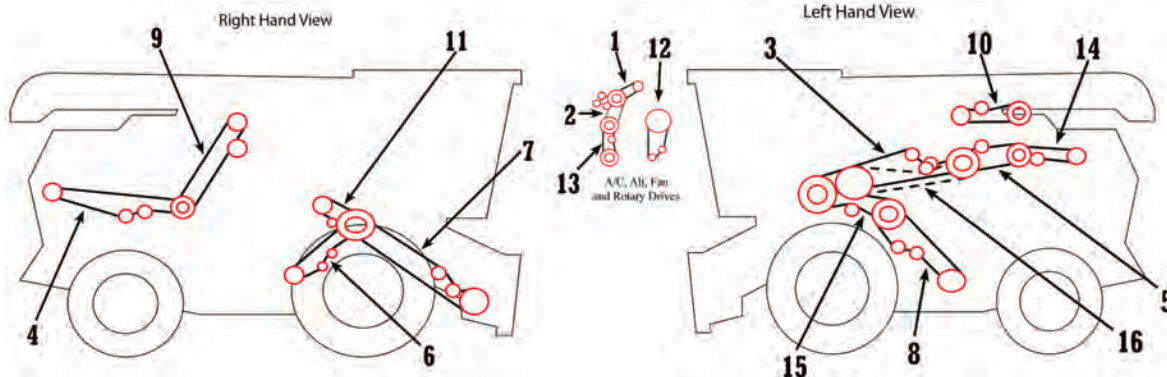

Application	Description	Part Number	Retail Price
1 8560	A/C Compressor Drive	AM525906M1	\$ 5.25
1 8570, 8780 BSN MJ87101	A/C Compressor Drive	AM531603M1	\$ 12.75
1 8780 ASN MJ8701	A/C Compressor Drive	AM71148120	\$ 8.25
2 8560	Alternator & Fan Drive	AM2634420W1	\$ 71.01
2 8570	Alternator & Fan Drive	AM1076753M1	\$ 25.45
2 8780	Alternator & Fan Drive	AM111677W1	\$ 28.31
2 8780 ASN MJ87101	Fan and Alternator	AMA3289213	\$ 35.00
3 8560, 8570, 8780	Beater Drive	AM2624390W1	\$ 158.17
3 8780 S/N W55101-HL87999	Beater Drive, 175.30"	AM71386352	\$ 131.91
4 8560, 8570, 8780	Spreader Drive	AM1680230W1	\$ 62.00
4 8560	Chopper Drive	AM1781280W1	\$ 125.00
4 8570, 8780 SN W55101-HL87999 & ASN V51101	Chopper Drive	AM71388712	\$ 84.00
5 8560, 8570	Countershaft Drive, 123" 3V Belt	AM1594240W1	\$ 140.00
5 8570	Countershaft Drive	AM104180W1	Call for Price
5 8570 ASN V51101	Countershaft Drive	AM104180W1	Call for Price

Prices Subject to Change without Prior Notice. The use of original equipment manufacturer (OEM) part numbers or trademarks, e.g. Case® and John Deere®, are for reference purposes only and for indicating product use and compatibility. Our company and the listed replacement parts contained herein are not sponsored, approved or manufactured by the OEM. All parts are New unless designated Reman in the description.

Massey Ferguson®—Combine

Application	Description	Part Number	Retail Price
5 8780 BSN MJ87101	Countershaft Drive, 125.5"	AM71385693	Call for Price
5 8780 ASN MJ87101	Countershaft Drive, 138.5"	AM71387775	Call for Price
6 8560, 8570, 8780	Fan Drive, Vari-Speed	AM2612330W1	\$ 84.00
7 8560, 8570	Feeder Drive	AM2621170W1	\$ 211.90
7 8570, 8780 ASN V51101	Feeder Drive, 217.9" (3 Banded)	AM108190W1	\$ 236.00
7 8570	Feeder Drive (4 Banded, High Capacity)	AM104072W1	Call for Price
7 8780 S/N W55101-HL87999	Feeder Drive (4 Banded)	AM71379105	\$ 208.33
7 8780 ASN W55101-HL7999	Feeder Drive (4 Banded)	AM71379124	Call for Price
8 8560	Grain Elevator Drive	AM9811200W1	Call for Price
8 8560, 8570, 8780	Grain Elevator Drive	AM227455M1	\$ 36.00
9 8560	Jackshaft Drive, Chopper	AM9810810W1	Call for Price
9 8570, 8780	Jackshaft Drive, Spreader	AM227455M1	\$ 36.00
9 8780 BSN MJ87101	Jackshaft Drive, Chopper	AM103319M1	\$ 52.01
9 8780 ASN MJ87101	Jackshaft Drive, Chopper	AM71385837	\$ 54.37
10 8560, 8570	Propulsion Pump Drive	AM9811830W2	\$ 72.46
11 8560, 8570, 8780 ASN V51101	Return Elevator Drive	AM2619760W1	\$ 17.00
11 8780 BSN MJ87101	Return Elevator Drive	AM2619760W1	\$ 17.00
11 8780 ASN MJ87101	Return Elevator Drive	AM71385801	\$ 38.10
12 8560, 8570, 8780	Rotary Screen Drive	AM1764410W1	\$ 17.06
13 8560, 8570	Rotary Screen "C" Shaft	AM2624080W1	\$ 23.43
13 8570, 8780	Rotary Screen "C" Shaft	AM104259W1	\$ 12.25
14 8560	Rotor Drive	AM1669570W1	\$ 76.20
14 8570	Rotor Drive	AM9811830W2	\$ 72.46
10 8570	Propulsion Pump Drive	AM104179W1	Call for Price
14 8780	Rotor Drive	AM111954W1	\$ 123.95
15 8560, 8570, 8780	Shaker Shoe Pitman Drive	AM2593000W1	\$ 72.19
16 8560, 8570, 8780	Unloader	AM101102M1	\$ 100.39

Belts—8590, 9720

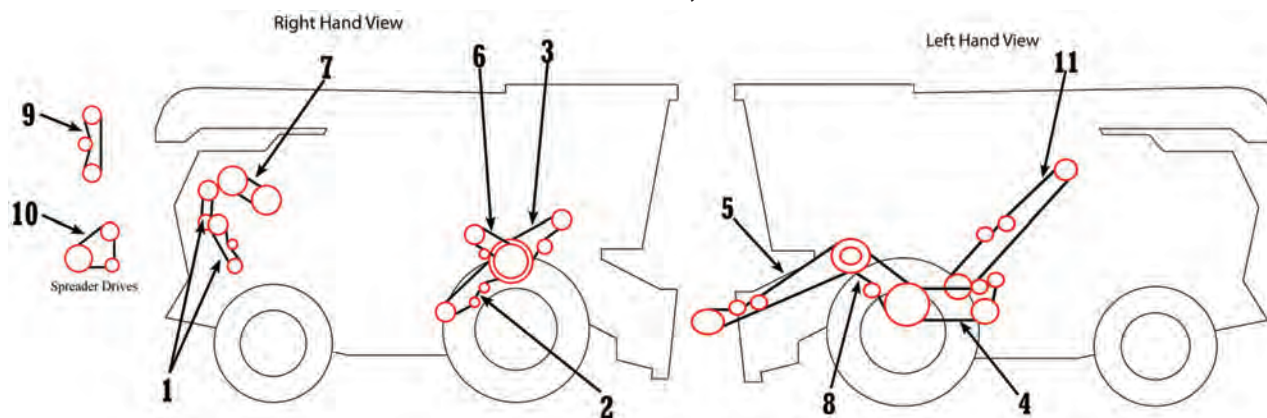

Application	Description	Part Number	Retail Price
1 8590, 9720	Chopper Drive Set of 2	AM2553480W1	\$ 57.64
2 8590, 9720	Cleaning Fan Drive Replaces 31-2439720	AM2439720W1	\$ 65.22
3 8590, 9720	Feed Impeller Drive 3V Belt	AM1594240W1	\$ 140.00
4 8590, 9720	Grain Elevator Drive	AM2439700W1	\$ 49.70
5 8590, 9720	Head Countershaft Drive	AM2523670W1	\$ 167.00

Massey Ferguson®—Combine

Application	Description	Part Number	Retail Price
6 8590, 9720	Return Elevator Drive	AM2492070W1	\$ 10.83
7 8590, 9720	Rotor Drive	AM2445370W1	\$ 177.18
8 8590, 9720	Shaker Shoe Pitman Drive	AM2439710W1	\$ 69.52
9 8590, 9720	Straw Spreader	AM2543960W1	\$ 17.64
10 8590, 9720	Straw Spreader (Secondary)	AM2543970W1	\$ 15.60
11 8590, 9720	Unloader Drive	AM2496110W1	\$ 98.00

Belts—9520, 9540, 9560

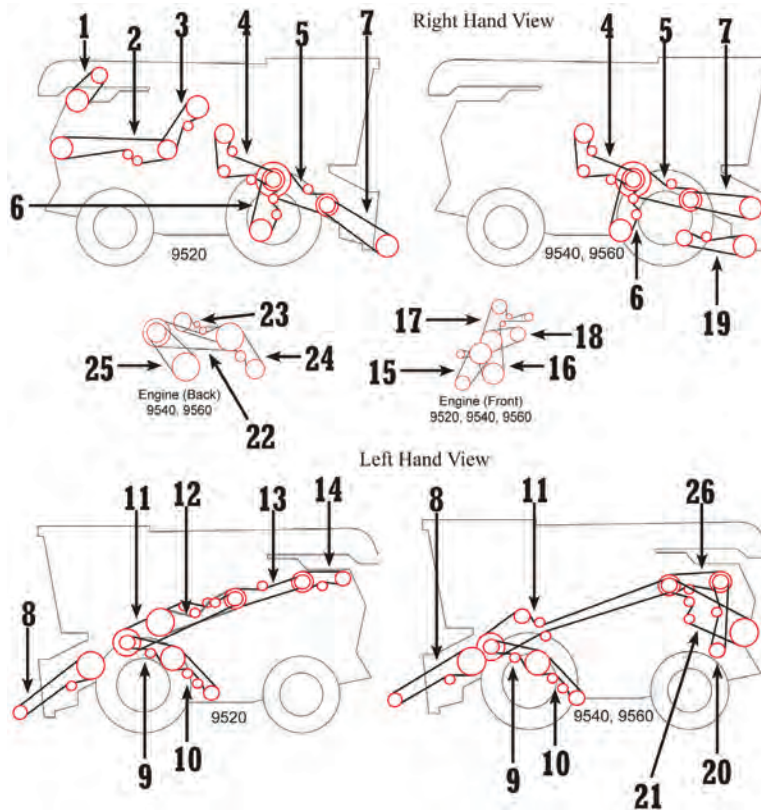

Application	Description	Part Number	Retail Price
1 9520	Rotary Screen	AM71430931	\$ 10.45
2 9520	Straw Chopper, Secondary Drive	AM71406339	\$ 121.63
3 9520	Straw Chopper, Primary Drive	AM71406338	\$ 75.08
4 9520, 9540, 9560	Return Elevator	AM71385801	\$ 38.10
5 9520	Beater Drive	AM71398384	\$ 128.43
5 9540, 9560	Beater Drive	AM71448508	\$ 179.00
6 9520	Fan Drive, Variable Speed	AM71444732	\$ 91.34
6 9540, 9560	Fan Drive, Variable Speed	AM71429015	\$ 91.00
7 9520	Header Drive, Variable Speed	AM71453905	\$ 438.29
7 9520	Header Drive, Fixed Speed	AM71399519	\$ 227.36
7 9540, 9560	Header Drive, Variable Speed	AM71448509	\$ 441.79
8 9520	Feederhouse, Fixed Speed	AM71447401	\$ 118.00
8 9520	Feederhouse, Variable Speed	AM71427255	\$ 76.00
8 9540, 9560	Feeder Conveyor	AM71450686	\$ 299.00
9 9520, 9540, 9560	Pitman Drive	AM71390199	\$ 71.45
10 9520, 9540, 9560	Clean Grain Drive	AM71460655	\$ 128.74
11 9520	Beater Drive	AM71388216	\$ 210.33

Prices Subject to Change without Prior Notice. The use of original equipment manufacturer (OEM) part numbers or trademarks, e.g. Case® and John Deere®, are for reference purposes only and for indicating product use and compatibility. Our company and the listed replacement parts contained herein are not sponsored, approved or manufactured by the OEM. All parts are New unless designated Reman in the description.

Massey Ferguson®—Combine

Application	Description	Part Number	Retail Price
11 9540, 9560	Beater Drive	AM71427343	\$ 835.00
12 9520	Unloader Drive	AM71410767	\$ 87.00
13 9520	Countershaft, Main	AM71390188	\$ 109.89
14 9520	Tandem Pumps	AM71418984	\$ 151.99
15 9520, 9540, 9560	Aspirator Fan	AM71438552	\$ 24.24
16 9520	Alternator	AM71444986	\$ 36.00
16 9540, 9560	Alternator and Compressor	AM71448150	\$ 48.00
17 9520	A/C Compressor	AM71457301	\$ 29.00
17 9540, 9560	Alternator	AM71457301	\$ 29.00
18 9520, 9540, 9560	Water Pump	AMV685040894	\$ 73.53
19 9540, 9560	Header Drive, Fixed Speed	AM71448515	\$ 262.00
20 9540, 9560	Chopper Drive, Secondary	AM71448503	\$ 203.00
21 9540, 9560	Straw Spreader	AM71432587	\$ 58.65
22 9540, 9560	Separator Drive	AM71447360	\$ 372.00
23 9540, 9560	Unloader Drive	AM71441902	\$ 197.76
24 9540, 9560	Hydraulic Pump Drive	AM71432619	\$ 157.80
25 9540, 9560	Rotor Drive	AM71426441	\$ 561.38
26 9540, 9560	Chopper Drive, Primary	AM71440999	\$ 143.07

Belts—9690, 9695, 9790, 9795, 9895

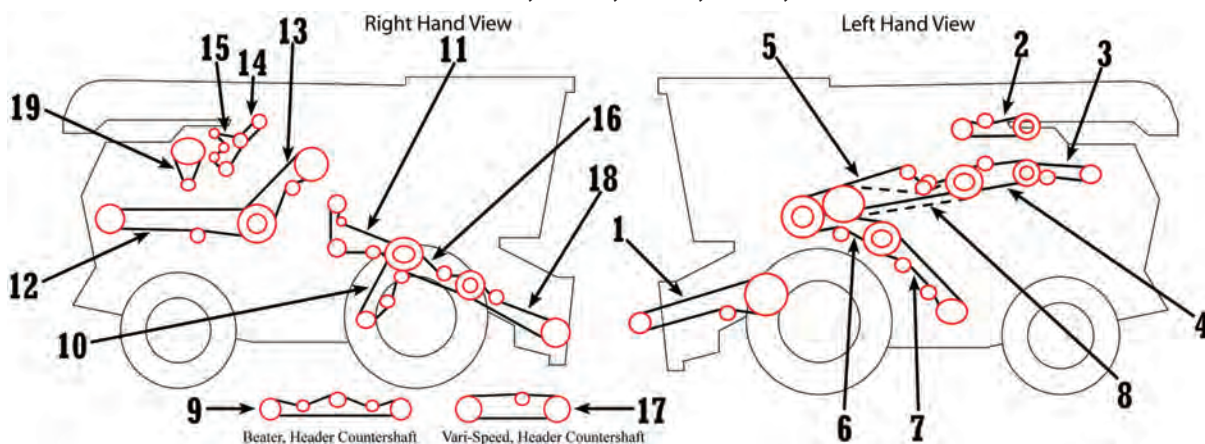

Application	Description	Part Number	Retail Price
1 9690 ASN HP87101	Feeder, Pivot Shaft	AM71398388	\$ 77.41
1 9790 ASN HP36101, 9895 ASN HSC8101	Feeder, Pivot Shaft	AM71398388	\$ 77.41
1 9695, 9795, 9895 ASN HUC8101	Feeder, Pivot Shaft	AM71427255	\$ 76.00
2 9790 BSN HR36101	Pump Drive, Propel	AM71390209	\$ 106.37
2 9790 ASN HR87101, 9795	Pump Drive, Propel	AM71418978	\$ 120.00
2 9895	Pump Drive, Propel	AM71406286	\$ 86.00
3 9690 BSN HR87101, 9790, 9795	Pump Drive, Rotor	AM71418976	\$ 113.00
3 9690 ASN HR87101, 9695	Pump Drive, Rotor	AM71418984	\$ 151.99
3 9895	Pump Drive, Rotor	AM71406285	\$ 99.00
4 9690, 9695, 9790, 9795	Countershaft, Main	AM71390188	\$ 109.89
4 9895	Countershaft, Main	AM71403721	\$ 175.00
5 9690	Beater Drive	AM71386352	\$ 131.91
5 9695, 9790, 9795, 9895	Beater Drive	AM71388216	\$ 210.33
6 9690, 9695, 9790, 9795, 9895	Shaker Shoe Pitman Drive	AM71390199	\$ 71.45
7 9690 BSN HP87101, 9760 BSN HP36101	Grain Elevator Drive	AM227455M1	\$ 36.00
7 9690 ASN HP87101, 9790 ASN HP36101	Grain Elevator Drive	AM71403685	\$ 50.64

Massey Ferguson®—Combine

Application	Description	Part Number	Retail Price
7 9695, 9795, 9895 ASN HUC8101	Grain Elevator Drive	AM71410765	\$ 76.00
7 9895 ASN HSC8101	Grain Elevator Drive	AM71403685	\$ 50.64
8 9690, 9790	Unloader Drive	AM101102M1	\$ 100.39
8 9695, 9795, 9895	Unloader Drive	AM71410767	\$ 87.00
9 9690 BSN HP87101, 9790 BSN HP36101	Header Countershaft, Beater	AM71379105	\$ 208.33
10 9690, 9695, 9790, 9795	Cleaning Fan, Vari-Speed	AM71394352	\$ 86.00
10 9895 BSN BHC08101	Cleaning Fan, Vari-Speed	AM71400662	\$ 80.00
10 9895 ASN BHC08101	Cleaning Fan, Vari-Speed	AM71444743	\$ 108.44
10 9895 ASN HSC8101	Cleaning Fan, Vari-Speed	AM71400662	\$ 80.00
11 9690, 9695, 9790, 9795, 9895	Return Elevator Drive	AM71385801	\$ 38.10
12 9690 BSN HR87101, 9790 BSN HR36101	Chopper (Secondary)	AM71388712	\$ 84.00
12 9690 ASN HR87101, 9790 ASN HR36101	Chopper (Secondary)	AM71406339	\$ 121.63
12 9695, 9795, 9895 (2 Band, 214")	Chopper (Secondary)	AM71406339	\$ 121.63
12 9895 ASN HU8101 (3 Band, 242")	Chopper, MAV (Secondary)	AM71430816	\$ 264.03
12 9895 ASN HU8101 (3 Band, 216")	Chopper (Secondary)	AM71427340	\$ 162.60
12 9690, 9695, 9790, 9795, 9895	Spreader Drive (Secondary)	AM1680230W1	\$ 62.00
13 9690 BSN HR87101, 9790 BSN HR36101	Chopper (Primary)	AM71385837	\$ 54.37
13 9690 ASN HR87101, 9790 ASN HR36101	Chopper (Primary)	AM71406361	\$ 76.81
13 9695, 9795, 9895 (2 Band, 138.9")	Chopper (Primary)	AM71406338	\$ 75.08
13 9895 ASN HUC8101 (2 Band, 160")	Chopper, MAV (Primary)	AM71424226	\$ 102.92
13 9895 ASN HU8101 (2 Band, 167")	Chopper (Primary)	AM71424227	\$ 132.00
13 9690, 9790	Spreader (Primary)	AM227455M1	\$ 36.00
13 9695, 9795, 9895	Spreader (Primary)	AM71414420	\$ 63.00
14 9690, 9695, 9790, 9795	A/C Compressor	AM71148120	\$ 8.25
15 9690 BSN HR87101, 9790 BSN HP36101	Fan and Alternator	AMA3289213	\$ 35.00
15 9690 BSN HR87101, 9790 ASN HP36101	Fan and Alternator (Kit)	AMA71410501	\$ 40.00
15 9690 ASN HR87101, 9790 ASN HR36101	Fan and Alternator (SISU)	AMV685121585	\$ 55.61
15 (9690, 9790, 9795 Engine ASN T11858), 9695	Fan and Alternator (SISU)	AMV658121530	Call for Price
15 9695 ASN BHC06101, 9795 ASN BHC07101	Alternator and Fan	AM71444986	\$ 36.00
15 9895 ASN HUC8101	Fan and Alternator	AM288-1607	\$ 64.86
15 9895 ASN HSC8101	Fan and Alternator	AM71407841	\$ 64.86
16 9690 ASN HP87101, 9695	Beater, Feederhouse Jackshaft	AM71398384	\$ 128.43
16 9790 ASN HP36101, 9795, 9895	Beater, Feederhouse Jackshaft	AM71398384	\$ 128.43
17 9690 ASN HP87101, 9790 ASN HP36101	Header Countershaft, Vari-Speed	AM71399505	\$ 412.80
17 9695, 9795, 9895 ASN HSC9101	Header Countershaft, Vari-Speed	AM71423444	\$ 437.00
17 9895 ASN HSC9101	Header Countershaft, Vari-Speed	AM71399505	\$ 412.80
18 9690 ASN HP87101, 9790 ASN HP36101	Header Countershaft, Fixed Speed	AM71399519	\$ 227.36
18 9695, 9795, 9895	Header Countershaft, Fixed Speed	AM71399519	\$ 227.36
19 9690 ASN HR87101, 9695, 9790, 9795, 9895	Rotary Screen	AM71396754	\$ 16.25

Massey Ferguson®—Industrial / Construction

Table of Contents

Crankshafts	1400	Radiator Hoses	1400
Power Steering Pumps	1400	Starters	1400

Crankshafts

Application	Description	Part Number	Retail Price	Core
Forklift: 202 Replaces 1750169M1, 830686M91, Z129C205, Z129C500, Z134C500	Crankshaft Z129, Z134 Gas Engines 3.875" Stroke, 3.313" - 3.315" Bore, 1.9365" - 1.9375" Rod, 2.249" - 2.250" Main Flange - No Centering Ring, Flat, 4 Bolt Holes Snout - 2 Keyways	AM830686M91	\$ 425.00	
Forklift: 860C Replaces 31315181, 31315182, 31315185, 3637458M91, ZZ90095, ZZ90111, ZZ94441, ZZ94454, ZZ94455	Crankshaft 4.203 Lip Seal, Splined Nose	AM31315181-2	\$ 395.00	



Radiator Hoses

Application	Description	Part Number	Retail Price	Core
Backhoe-Loaders: 50H, 60H	Radiator Hose, Upper 1.625" ID Replaces VPE4150	AM535203M1	\$ 22.20	
Forklifts: 2500, 4500	Bypass Hose 1.125" ID Replaces 747936M91, 81716947, 86513585, E6CJ9, E15CJ9	AM731256M1	\$ 5.76	
Forklifts: 2500, 4500	Water Pump Inlet Hose 1.375" ID Replaces 8176946	AM732443M1	\$ 8.10	

Starters

Application	Description	Part Number	Retail Price	Core
Backhoe-Loader: 60, Forklift: 11 - All Diesel	Starter, 12 Volt HD Planetary Gear Reduction, 10 Tooth Steel Pinions, Steel Ring Gear, 4kW, CW Rotation For Diesel Engines Replaces 1113391, 1113672	AMX34112	\$ 285.00	
	Solenoid Use w/ AMX34112 Starter	AMX34113	\$ 60.00	

Power Steering Pumps

Application	Description	Part Number	Retail Price	Core
Forklifts: 2500, 4500	Power Steering Pump	AM527904M91	\$ 267.87	

MacDon®—Header

Table of Contents

Auger Components—Bare Header/Platform	1404	Reel Components.....	1405
Belts.....	1408	Sickle Assemblies With Heads	1403
Cornhead—Stalk Stompers and Components	1408	Sickle Assemblies Without Heads	1401
Draper Belts and Components	1405	Sickle Drives and Components	1404
Guards and Cutter Bar Parts.....	1405	Sickle Knife Heads	1401
Poly Skid Plates.....	1407	Skid Shoes	1407

Sickle Knife Heads

Application	Description	Part Number	Retail Price	Core
Platforms: 962 ASN 153178, 973, 974	Sickle Knife Head Replaces 87408818	AM153812	\$ 93.00	
Platforms: D50, D60, D65, FD70, FD75	Sickle Knife Head, 5°, Right Hand	AM132897	\$ 83.00	
	Sickle Knife Head, 5°, Left Hand	AM132896	\$ 83.00	

Sickle Assemblies Without Heads

Easy-to-assemble interlocking/overlapping bar bolts together for greater field convenience. All sickle sections feature bolt-on convenience and are heat-treated for superior cutting life.



Application	Description	Part Number	Retail Price	Core
Platform: 972	Sickle Assembly w/o Head, Coarse Includes: (1) 129024 Left Hand Head Segment, (1) 129026 Mid Segment, (1) 129028 Tail Segment, (2) 129043 Splice Kits	21' AMX29037	\$ 319.00	
	Sickle Assembly w/o Head, Coarse Includes: (1) 129024 Left Hand Head Segment, (1) 129026 Mid Segment, (1) 129031 Tail Segment, (2) 129043 Splice Kits	25' AMX29038	\$ 365.00	
	Sickle Assembly w/o Head, Coarse Includes: (1) 129024 Left Hand Head Segment, (2) 129026 Mid Segments, (1) 129029 Tail Segment, (3) 129043 Splice Kits	30' AMX29039	\$ 448.00	
	Sickle Assembly w/o Head, Coarse Includes: (1) 129024 Left Hand Head Segment, (3) 129026 Mid Segments, (1) 129030 Tail Segment, (4) 129043 Splice Kits	36' AMX29040	\$ 545.00	
Platforms: D50, D60, D65, FD70, FD75	Sickle Assembly w/o Head, Coarse Includes: (1) 129024 Left Hand Head Segment, (1) 129026 Mid Segment, (1) 129043 Tail Segment, (2) 129043 Splice Kits	20' AMX29020	\$ 319.00	
	Sickle Assembly w/o Head, Coarse Includes: (1) 129024 Left Hand Head Segment, (1) 129026 Mid Segment, (1) 129031 Tail Segment, (2) 129043 Splice Kits	25' AMX29021	\$ 365.00	
	Sickle Assembly w/o Head, Coarse Includes: (1) 129024 Left Hand Head Segment, (2) 129026 Mid Segments, (1) 129029 Tail Segment, (3) 129043 Splice Kits	30' AMX29022	\$ 448.00	
	Sickle Assembly w/o Head, Coarse Includes: (1) 129024 Left Hand Head Segment, (2) 129026 Mid Segments, (1) 172255 Tail Segment, (3) 129043 Splice Kits	35' AMX29023	\$ 532.00	
	Sickle Assembly w/o Head, Coarse Includes: (1) 129024 Left Hand Head Segment, (3) 129026 Mid Segments, (1) 172254 Tail Segments, (4) 129043 Splice Kits	40' AMX29024	\$ 606.00	

MacDon®—Header

Application	Description	Part Number	Retail Price	Core
972 Note: Right and Left Hand Assemblies Must be Purchased Separately to Create Full Double Sickle	Double Sickle Right Hand Assembly w/o Head, Coarse Includes: (1) 118449 Right Hand Head Segment, (1) 129028 Tail Segment, (1) 129043 Splice Kit	18' AMX29042	\$ 212.00	
	Double Sickle Left Hand Assembly w/o Head, Coarse Includes: (1) 129025 Left Hand Head Segment, (1) 129023 Left Hand Overlap Tail Segment, (1) 129043 Splice Kit	18' AMX29041	\$ 195.00	
	Double Sickle Right Hand Assembly w/o Head, Coarse Includes: (1) 129040 Right Hand Head Segment, (1) 129038 Right Hand Overlap Tail Segment, (1) 129043 Splice Kit	21' AMX29044	\$ 209.00	
	Double Sickle Left Hand Assembly w/o Head, Coarse Includes: (1) 129024 Left Hand Head Segment, (1) 129032 Left Hand Overlap Tail Segment, (1) 129043 Splice Kit	21' AMX29043	\$ 174.00	
	Double Sickle Right Hand Assembly w/o Head, Coarse Includes: (1) 129040 Right Hand Head Segment, (1) 129036 Right Hand Overlap Tail Segment, (1) 129043 Splice Kit	25' AMX29046	\$ 190.00	
	Double Sickle Left Hand Assembly w/o Head, Coarse Includes: (1) 129024 Left Hand Head Segment, (1) 129033 Left Hand Overlap Tail Segment, (1) 129043 Splice Kit	25' AMX29045	\$ 195.00	
	Double Sickle Right Hand Assembly w/o Head, Coarse Includes: (1) 129040 Right Hand Head Segment, (1) 129037 Right Hand Overlap Tail Segment, (1) 129043 Splice Kit	30' AMX29048	\$ 262.00	
	Double Sickle Left Hand Assembly w/o Head, Coarse Includes: (1) 129024 Left Hand Head Segment, (1) 129034 Left Hand Overlap Tail Segment, (1) 129043 Splice Kit	30' AMX29047	\$ 216.00	
	Double Sickle Right Hand Assembly w/o Head, Coarse Includes: (1) 129040 Right Hand Head Segment, (2) 129027 Mid Segments, (1) 129038 Right Hand Overlap Tail Segment, (3) 129043 Splice Kits	36' AMX29050	\$ 469.00	
	Double Sickle Left Hand Assembly w/o Head, Coarse Includes: (1) 129024 Left Hand Head Segment, (2) 129027 Mid Segments, (1) 129032 Left Hand Overlap Tail Segment, (3) 129043 Splice Kits	36' AMX29049	\$ 419.00	

MacDon®—Header

MacDon®—Header

Application	Description	Part Number	Retail Price	Core
Platforms: D50, D60, D65, D75 Note: Right and Left Hand Assemblies Must be Purchased Separately to Create Full Double Sickle	Double Sickle Right Hand Assembly w/o Head, Coarse Includes: (1) 172330 Right Hand Head Segment	20' AMX29026	\$ 177.00	
	Double Sickle Left Hand Assembly w/o Head, Coarse Includes: (1) 129024 Left Hand Head Segment, (1) 165978 Left Hand Overlap Tail Segment, (1) 129043 Splice Kit	20' AMX29025	\$ 177.00	
	Double Sickle Right Hand Assembly w/o Head, Coarse Includes: (1) 129040 Right Hand Head Segment, (1) 172300 Right Hand Overlap Tail Segment, (1) 129043 Splice Kit	25' AMX29028	\$ 187.00	
	Double Sickle Left Hand Assembly w/o Head, Coarse Includes: (1) 129024 Left Hand Head Segment, (1) 165980 Left Hand Overlap Tail Segment, (1) 129043 Splice Kit	25' AMX29027	\$ 188.00	
	Double Sickle Right Hand Assembly w/o Head, Coarse Includes: (1) 129040 Right Hand Head Segment, (1) 172302 Right Hand Overlap Tail Segment, (1) 129043 Splice Kit	30' AMX29030	\$ 212.00	
	Double Sickle Left Hand Assembly w/o Head, Coarse Includes: (1) 129024 Left Hand Head Segment, (1) 165982 Left Hand Overlap Tail Segment, (1) 129043 Splice Kit	30' AMX29029	\$ 229.00	
	Double Sickle Right Hand Assembly w/o Head, Coarse Includes: (1) 129040 Right Hand Head Segment, (1) 172303 Right Hand Overlap Tail Segment, (1) 129043 Splice Kit	35' AMX29032	\$ 242.00	
	Double Sickle Left Hand Assembly w/o Head, Coarse Includes: (1) 129024 Left Hand Head Segment, (1) 172312 Left Hand Overlap Tail Segment, (1) 129043 Splice Kit	35' AMX29031	\$ 254.00	
	Double Sickle Right Hand Assembly w/o Head, Coarse Includes: (1) 129040 Right Hand Head Segment, (2) 129027 Mid Segments, (1) 172299 Right Hand Overlap Tail Segment, (3) 129043 Splice Kits	40' AMX29034	\$ 380.00	
	Double Sickle Left Hand Assembly w/o Head, Coarse Includes: (1) 129024 Left Hand Head Segment, (2) 129027 Mid Segments, (1) 172310 Left Hand Overlap Tail Segment, (3) 129043 Splice Kits	40' AMX29033	\$ 418.00	
	Double Sickle Right Hand Assembly w/o Head, Coarse Includes: (1) 129040 Right Hand Head Segment, (2) 129027 Mid Segments, (1) 172301 Right Hand Overlap Tail Segment, (3) 129043 Splice Kits	45' AMX29036	\$ 420.00	
	Double Sickle Left Hand Assembly w/o Head, Coarse Includes: (1) 129024 Left Hand Head Segment, (2) 129027 Mid Segments, (1) 172311 Left Hand Overlap Tail Segment, (3) 129043 Splice Kits	45' AMX29035	\$ 439.00	

Sickle Assemblies With Heads



Application	Description	Part Number	Retail Price	Core
For 14' Platform w/ Double Drive: A40-D	Sickle Assembly w/ Head, Coarse	7' Right Hand AM124925	\$ 255.00	
For 14' Mower Conditioners w/ Double Drive: A30-D, A30-S	9 Teeth per Inch, Top Serrated, Self-Sharpening Serrations	7.50' Left Hand AM124923	\$ 270.00	
Note: Right and Left Hand Assemblies Must be Purchased Separately to Create 14' Sickle	Features bolt-on, coarse sections Will ship UPS and FedEx			

MacDon®—Header

Application	Description		Part Number	Retail Price	Core
For 16' Platform w/ Double Drive: A40-D	Sickle Assembly w/ Head, Coarse	8.50' Right Hand	AM124926	\$ 270.00	
For 16' Mower Conditioners w/ Double Drive: A30-D, A30-S	9 Teeth per Inch, Top Serrated, Self-Sharpening Serrations	7.50' Left Hand	AM124923	\$ 270.00	
Note: Right and Left Hand Assemblies Must be Purchased Separately to Create 16' Sickle	Features bolt-on, coarse sections 8.50' Assembly Ships Truck Freight Only 7.50' Assembly Will ship UPS and FedEx				
For 18' Platform w/ Double Drive: A40-D	Sickle Assembly w/ Head, Coarse	8.50' Right Hand	AM124926	\$ 270.00	
For 18' Mower Conditioners w/ Double Drive: A30-D, A30-S	9 Teeth per Inch, Top Serrated, Self-Sharpening Serrations	9' Left Hand	AM124924	\$ 305.00	
Note: Right and Left Hand Assemblies Must be Purchased Separately to Create 18' Sickle	Features bolt-on, coarse sections Ships Truck Freight Only				
Platform: A40-D, Mower Conditioners: A30-D, A30-S - All w/ Single Drive	Sickle Assembly w/ Head, Coarse Self-Sharpening Serrations	14'	AM14285	\$ 410.00	
		16'	AM142846	\$ 440.00	
For 14' Platform w/ Double Drive: A40-D	Sickle Assembly w/ Head, Fine	7' Right Hand	AM172002	\$ 255.00	
For 14' Mower Conditioners w/ Double Drive: A30-D, A30-S	14 Teeth per Inch, Top Serrated, Self-Sharpening Serrations	7.50' Left Hand	AM172001	\$ 270.00	
Note: Right and Left Hand Assemblies Must be Purchased Separately to Create 14' Sickle	Features bolt-on, fine sections Will ship UPS and FedEx				
For 16' Platform w/ Double Drive: A40-D	Sickle Assembly w/ Head, Fine	8.50' Right Hand	AM170087	\$ 270.00	
For 16' Mower Conditioners w/ Double Drive: A30-D, A30-S	14 Teeth per Inch, Top Serrated, Self-Sharpening Serrations	7.50' Left Hand	AM172001	\$ 270.00	
Note: Right and Left Hand Assemblies Must be Purchased Separately to Create 16' Sickle	Features bolt-on, fine sections 8.50' Assembly Ships Truck Freight Only 7.50' Assembly Will ship UPS and FedEx				
For 18' Platform w/ Double Drive: A40-D	Sickle Assembly w/ Head, Fine	8.50' Right Hand	AM170087	\$ 270.00	
For 18' Mower Conditioners w/ Double Drive: A30-D, A30-S	14 Teeth per Inch, Top Serrated, Self-Sharpening Serrations	9' Left Hand	AM170086	\$ 305.00	
Note: Right and Left Hand Assemblies Must be Purchased Separately to Create 18' Sickle	Features bolt-on, fine sections Ships Truck Freight Only				

Auger Components—Bare Header/Platform

Application	Description	Part Number	Retail Price	Core
Platforms: FD70, FD75 Replaces 187081	Finger Guide Use w/ AM1302699C1 Finger	AM87620690	\$ 3.75	
Platforms: FD70, FD75 Replaces 7642	Auger Finger Use w/ AM87620690 Finger Guide	AM1320699C1	\$ 8.25	

Sickle Drives and Components

Application	Description	Part Number	Retail Price	Core
Platforms: 910, 920 BSN 124499	Wobble Box Repair Kit	AMAE57735	\$ 647.00	
Platforms: (910, 920, 930, 932 ASN 124500), 912, 922, 933, 962, 963, 972, 973, 974, A40-D, D50, D60, FD70 Replaces 100532	Wobble Box	AM338670A1	\$ 1575.00	
Platforms: 960 Replaces 26320	Wobble Box 2-Bolt and 2-Dowel Pin Mounting Replaces E59258	AMAE34800	\$ 1195.00	
Platforms: 910, 912, 920, 922, 930, 932, 933, 942, 962, 963, 972, 973, 974, A40-D, D50, D60, FD70	Wobble Box Yoke	AM100706	\$ 517.00	
Platforms: (910, 920, 930, 932 ASN 124500), 912, 922, 933, 962, 963, 972, 973, 974, A40-D, D50, D60, FD70 Replaces 47832, 174982	Pulley, Knife Drive Gearbox	AM338585A1	\$ 265.00	
Platforms: (910, 920, 930, 932 ASN 124500), 912, 922, 933, 962, 963, 972, 973, 974, A40-D, D50, D60, FD70 Replaces 113698	Arm	AM369994A1	\$ 195.00	



Guards and Cutter Bar Parts

Application	Description	Part Number	Retail Price	Core
Platforms: 960, 962, 972, 973, 974, D40, D50, D60, D65, FD70, FD75, FD130, FD135, FD140, FD145 Replaces 23064, 28013	Knife Guard, Double Pronged	AM118344	\$ 11.00	
Platform: 972	Knife Guard, Double Pronged Replaces 49312	AM118346	\$ 10.00	
Auger Platforms: 912, 922, Draper Platforms: 960, 972, 973, 974, D40, D50, D60, FD70, FD75	Knife Guard, Double Pronged Drive Head Guard (3) Required per Single Knife, (6) Required per Double Knife	AM118345	\$ 12.00	
Auger Platforms: 912, 922, Draper Platforms: 960, 972, 973, 974, D40, D50, D60, FD70, FD75, FD130, FD135, FD140, FD145	Knife Guard First Guard, Left Hand w/ Cross Bar Double Heat Treated (1) Required per Head Replaces 47709129, 87422039	AM118301	\$ 13.00	
	Knife Guard Last Guard, Right Hand w/ Cross Bar Double Heat Treated (1) Required per Head Replaces 47709128, 87422040	AM118302	\$ 13.00	
Platforms: 960, 962, 963, 972, 973, 974, D60, FD70	Sickle Section, Coarse 3.25" Long, 3" Wide, 2.125" Hole Spacing Sold in Multiples of 25, Priced Individually	AM158516	\$ 1.50	
Platforms: 960, 962, 963, 972, 973, 974, D50, D60, D65, FD70, FD75, D125, D130, D135, D140, D145, FD130, FD135, FD140, FD145 Replaces 49420, 118162	Hold Down Clip Hi-Arch Includes Nut and Bolt	AM118499	\$ 6.85	

Reel Components



Application	Description	Part Number	Retail Price	Core
Platforms: 972, 973, 974	Reel Tine Sold in Multiples of 25, Priced Individually Replaces 105212, 105351, 105352	AM381139A1	\$ 2.50	
Platforms: D50, D60, D70, D75 Replaces 174849, 174850	Reel Tine, HD Sold in Multiples of 25, Priced Individually	AM87561020	\$ 3.00	
Draper Platforms: D50, D60, D65, FD70, FD75, FD130, FD135, FD140, FD145	Quick Finger Repair Tine	AMX41116	\$ 2.95	

Draper Belts and Components



Application	Description	Part Number	Retail Price	Core
Platforms: 871, 872, 873 - Adapter for Gleaner®, Case IH® 60 & 66 Series, and New Holland® TR Combines Replaces 101671	Draper Center Feeder Belt 38.40" x 97.00" Single V-Guide For 38.00" Feed Deck	AM338361A1	\$ 338.00	
Platforms: 960, D1, D1X, D50, D60, D65, FD1, FD70, FD75 - w/ Center Delivery Replaces 113131	Draper Center Feeder Belt 78.50" x 63.46" Single V-Guide	AM87560973	\$ 415.00	
Platform: 972 w/ Center Delivery - Adapter for Case IH® 80 & 88 Series and Lexion® 450, 470, 475 Combines	Draper Center Feeder Belt 45.00" x 97.00" Single V-Guide For 45.00" Feed Deck	AM114267	\$ 319.00	

MacDon®—Header

MacDon®—Header

Application	Description	Part Number	Retail Price	Core
Platforms: Most Models - Adapter for New Holland® TX, Lexion® 460, 465, 480, 485, and John Deere® Combines	Draper Center Feeder Belt 55.90" x 97.00" Single V-Guide	AM101672	\$ 432.00	
Platforms: 960 (1995-2000), 962, 963 - w/ Double Delivery Replaces 100266	Draper Belt, HD 30' Right Hand, 41.60" x 345.00" Single V-Guide	AM338630A1	\$ 750.00	
Platforms: 960 (1995-2000), 962, 963 - w/ Double Delivery Replaces 100265	Draper Belt, HD 30' Left Hand, 41.60" x 297.80" Single V-Guide	AM338629A1	\$ 685.00	
Platforms: 960 (1995-2000), 962, 963 - w/ Double Delivery Replaces 100268	Draper Belt, HD 36' Right Hand, 41.60" x 417.00" Single V-Guide	AM338635A1	\$ 962.00	
Platforms: 960 (1995-2000), 962, 963 - w/ Double Delivery Replaces 100267	Draper Belt, HD 36' Left Hand, 41.60" x 369.70" Single V-Guide	AM338633A1	\$ 847.00	
Platforms: 960, D50, D60, D65, D135, FD70, FD75, FD135 - w/ Double Delivery Replaces 220638	Draper Belt, HD 35' Right and Left Hand, 41.60" x 337.24" Single V-Guide	AM87560979	\$ 750.00	
Platforms: 960 (1995-2000), D50, D60, D65, D130, FD70, FD75, FD130 - w/ Double or Triple Delivery Replaces 145960, 172195, 220637	Draper Belt, HD 30' Right and Left Hand, 41.60" x 277.24" Single V-Guide	AM47489938	\$ 645.00	
Platforms: 960 1995-2000, D50, D60, D65, D140, FD70, FD75, FD140 - w/ Double Delivery Replaces 220639	Draper Belt, HD 40' Right and Left Hand, 41.60" x 397.24" Single V-Guide	AM87560980	\$ 1004.00	
Platforms: 962 w/ Double Delivery, (973, 974 - w/ Center Delivery) Replaces 100275	Draper Belt, HD 21' Right and Left Hand, 71.60" x 201.00" Single V-Guide	AM346016A1	\$ 459.00	
Platform: (972, 973, 974 - w/ Double Delivery) Replaces 100438	Draper Belt, HD 25' Right and Left Hand, 41.60" x 249.00" Single V-Guide	AM346018A1	\$ 578.00	
Platforms: 972 w/ Double Delivery, (973, 974 - w/ Center Delivery) Replaces 101912	Draper Belt, HD 30' Right and Left Hand, 41.60" x 309.00" Single V-Guide	AM346022A1	\$ 674.00	
Platforms: 972 w/ Double Delivery, (973, 974 - w/ Center Delivery)	Draper Belt, HD 36' Right Hand, 41.60" x 405.00" Single V-Guide	AM372312A1	\$ 934.00	
Platforms: 972 w/ Double Delivery, (973, 974 - w/ Center Delivery) Replaces 101913	Draper Belt, HD 36' Left Hand, 41.60" x 357.00" Single V-Guide	AM372311A1	\$ 783.00	
Platforms: 972, 973, 974 - w/ Center Delivery Replaces 129212	Draper Belt, HD 39' Left Hand, 41.60" x 389.00" Single V-Guide	AM87446868	\$ 891.00	
Platforms: 972, 973, 974 - w/ Center Delivery Replaces 129214	Draper Belt, HD 39' Right Hand, 41.60" x 433.00" Single V-Guide	AM87446870	\$ 940.00	
Platforms: 972, 973, 974 - w/ End Delivery Replaces 113538	Draper Belt, HD 36' Right Hand - Outboard Deck, 41.60" x 154.00" Single V-Guide	AM372321A1	\$ 485.00	
Platforms: 972, 973, 974 - w/ End Delivery Replaces 129213	Draper Belt, HD 39' Right Hand - Outboard Deck, 41.60" x 182.00" Single V-Guide	AM87446869	\$ 448.00	
Platforms: 973, 974 - w/ Center or End Delivery Replaces 100438	Draper Belt, HD 36' or 39' Right Hand - Inboard Deck, 41.60" x 249.00" Single V-Guide	AM346018A1	\$ 578.00	
Platforms: D50, D60, D65, D125, D125X Replaces 220636	Draper Belt, HD 25' Right and Left Hand, 41.60" x 217.24" Single V-Guide	AM47767475	\$ 575.00	
Platforms: D60, D65, D120X Replaces 220635	Draper Belt, HD 20' Right and Left Hand, 41.60" x 158.24" Single V-Guide	AM47611890	\$ 450.00	

MacDon®—Header

MacDon®—Header

Application	Description	Part Number	Retail Price	Core
Platforms: D60, D65, D145, FD70, FD75, FD145 Replaces 172198, 220640	Draper Belt, HD 45' Right and Left Hand, 41.60" x 457.24" Single V-Guide	AM84399888	\$ 1019.00	
Platform: D65 w/ Center Delivery	Draper Side Belt 15' Right and Left Hand, 41.60" x 104.33" Single V-Guide	AM220634	\$ 307.00	
Platform: D130XL	Draper Belt, HD 30' Right and Left Hand, 49.60" x 277.24"	AM227750	\$ 870.00	
Platforms: D130XL, D135XL, D140XL, D145XL	Bulk Draper Belt 49.60" x 150.00'	AMDRB49.6X150MAD	\$ 5032.00	
Platform: D135XL	Draper Belt, HD 35' Right and Left Hand, 49.60" x 327.24"	AM227751	\$ 1029.00	
Platform: D140XL	Draper Belt, HD 40' Right and Left Hand, 49.60" x 397.24"	AM227752	\$ 1188.00	
Platform: D145XL	Draper Belt, HD 45' Right and Left Hand, 49.60" x 457.24"	AM227753	\$ 1347.00	
Platforms: 960, 962, 963, 972, 973, 974	Draper Belt Repair Kit For 41.60" Belt Includes 34" Repair Section of RAPTOR Material, Pre-Punched for Connector, (2) Steel Tube Connectors and Hardware	AM1014725	\$ 190.00	
Platforms: D50, D60, D65, FD70, FD75	Draper Belt Repair Kit For 41.60" Belt Includes 34" Repair Section of RAPTOR Material Pre-Punched for Connector, (2) Steel Tube Connectors and Hardware	AMX27266	\$ 160.50	
Platforms: D50, D60, D65, FD70, FD75, FD130, FD135, FD140, FD145	Steel Tube Connector Set For 41.60" Belts 39.80" Long Includes (2) Steel Tube Connectors and Hardware	AM1002377	\$ 40.00	
Platforms: D130XL, D135XL, D140XL, D145XL	Steel Tube Connector 12 Holes, 47.77" Long	AM1011511	\$ 36.60	
Platforms: Most Models	Steel Tube Connector 10 Holes, 38.78" Long	AM1005840	\$ 33.00	



Skid Shoes

Application	Description	Part Number	Retail Price	Core
Platform: FD70	Skid Shoe	Center	AM42053	\$ 48.50
		Right End	AM42055	\$ 48.00
		Left End	AM42054	\$ 60.00

Poly Skid Plates

Application	Description	Part Number	Retail Price	Core
Platforms: D65, FD75	Poly Skid Plate, Right End Replaces 87561542	AM165386	\$ 50.00	
	Poly Skid Plate, Left End Replaces 87561540	AM165188	\$ 50.00	
	Poly Skid Plate, Center Replaces 47414657, 87561539	AM165208	\$ 60.00	
	Poly Skid Plate Transition Pan (4) Required Replaces 87597512	AM151551	\$ 45.00	
Draper Platforms: D50, D60, D65, FD70, FD75	Poly Skid Plate, Cutterbar Replaces 129297	AM87532221	\$ 9.50	

MacDon®—Header

Cornhead—Stalk Sompers and Components

Application	Description	Part Number	Retail Price	Core
Harvestec 5000 Series, Harvestec 6000 Series	Stalk Stomper Kit, 2 Row Covers 1 Row on Each side of Cornhead	AMX31061	\$ 775.00	
	Stalk Stomper Kit, 4 Row Covers 2 Rows on Each side of Cornhead	AMX31062	\$ 1450.00	
	Stalk Stomper Kit, 6 Row Covers 3 Rows on Each side of Cornhead	AMX31063	\$ 2025.00	
	Stalk Stomper Kit, 8 Row Covers 4 Rows on Each side of Cornhead	AMX31064	\$ 2675.00	
	Stalk Stomper Kit, 12 Row Covers 6 Rows on Each side of Cornhead	AMX31065	\$ 3450.00	
	Header Mounting Bracket Accommodates 2" x 2" Square Toolbar	AMX30026	\$ 75.00	

Belts

Application	Description	Part Number	Retail Price	Core
Platform: A40-D, Draper Platform: FD75, Swather Platforms: 721, 910, 920, 921, 930, 932, Mower Conditioners: A30-D, A30-S	Timing Belt	AM38926	\$ 197.28	
	Belt, Knife Drive	AM145706	\$ 63.81	

White® / Oliver® / M&M®—Tractor

Table of Contents

Air Cleaner Components	1417	PTO Adapters	1421
Air Conditioning and Components	1427	PTO Shafts and Hubs	1420
Brakes	1421	Quick Hitches	1421
Carburetors	1409	Radiator Hoses	1411
Connecting Rods	1410	Radiators	1410
Crankshaft Damper Pulleys	1410	Shop Manuals and Collections	1429
Glass	1427	Spindles	1418
Hydraulic Pumps	1419	Starters	1417
Injection Pumps	1414	Steering Arms	1419
Input Shafts	1420	Steering Shafts	1421
Lighting	1422	Sway Blocks	1421
Manifolds and Components	1415	Tie Rods and Components	1417
Mufflers and Exhaust	1415	Turbochargers	1414
Overhaul Kits	1409	Water Pumps	1414
Power Steering Pumps and Conversion Kits	1419	Wheel Hubs	1419

Carburetors

Application	Description	Part Number	Retail Price	Core
Oliver®: 60, 66, 70, 77, 660, Super 44, Super 66, Super 77	Carburetor, Zenith	AMX82002	\$ 508.00	
Oliver®: 66, 88, 550, Super 88, White®: 2-44	Carburetor	AMX82007	\$ 550.00	
Oliver®: 88, Super 88	Carburetor, Zenith	AMX82003	\$ 456.00	
White®: 1750, 1800, 1850	Reman Carburetor	AMUSX32-1	\$ 325.00	\$ 100.00



Overhaul Kits

Application	Description		Retail Price	Core
77, Super 77, 770	194 and 216 Engines - Diesel	Inframe Kit	\$ 1051.00	
		Overhaul Kit	\$ 1235.00	
88, Super 88, 880	231 and 265 Engines - Gas	Inframe Kit	\$ 812.00	
		Overhaul Kit	\$ 1103.00	
	231 and 265 Engines - Diesel	Inframe Kit	\$ 881.00	
		Overhaul Kit	\$ 865.00	
1550, 1555	232 Engine - Gas	Inframe Kit	\$ 1018.00	
		Overhaul Kit	\$ 1062.00	
	232 Engine - Diesel	Inframe Kit	\$ 1003.00	
		Overhaul Kit	\$ 1192.00	
1600, 1650, 1655	265 Engine - Gas	Inframe Kit	\$ 1057.00	
		Overhaul Kit	\$ 1171.00	

Prices Subject to Change without Prior Notice. The use of original equipment manufacturer (OEM) part numbers or trademarks, e.g. Case® and John Deere®, are for reference purposes only and for indicating product use and compatibility. Our company and the listed replacement parts contained herein are not sponsored, approved or manufactured by the OEM. All parts are New unless designated Reman in the description.

White® / Oliver® / M&M®—Tractor

Application	Description		Retail Price	Core
1750, 1755	VRG283 Engine - Gas	Inframe Kit	\$ 1580.00	
		Overhaul Kit	\$ 1686.00	
1650, 1655, 2-70	VRD283 Engine - Diesel BSN 187586, Flat Top Piston	Inframe Kit	\$ 1758.00	
		Overhaul Kit	\$ 1171.00	
	VRD283 Engine - Diesel ASN 187586, Cavity Top Piston	Inframe Kit	\$ 1039.00	
		Overhaul Kit	\$ 1114.00	
Oliver®: 1850, 1855, 1950	VRG310 Engine - Gas	Inframe Kit	\$ 1780.00	
		Overhaul Kit	\$ 1845.00	
1750, 1755	VRD310 Engine - Diesel	Inframe Kit	\$ 983.00	
		Overhaul Kit	\$ 1046.00	
1855, 1950T, 1955	VRD310 Engine - Diesel	Inframe Kit	\$ 1092.00	
		Overhaul Kit	\$ 1220.00	
1850, 2-85	6.354 Engine - Diesel	Inframe Kit	\$ 625.00	
		Overhaul Kit	\$ 643.00	
White®: 2-105 (Build List TH22282), Combines: 8800, 8900	6.354T Engine - Diesel	Inframe Kit	\$ 685.00	
		Overhaul Kit	\$ 707.00	

Connecting Rods

Application	Description	Part Number	Retail Price	Core
White®: 2-105, Combines: 8800, 8900	Reman Connecting Rod	AMCR31337230-R	\$ 190.00	\$ 25.00

Crankshaft Damper Pulleys

Application	Description	Part Number	Retail Price	Core
White®: 100, 120, 125, 140, 6124, 6125, 6144, 6145, 6710, 6810, 8310 - w/ 6BT, 6B5.9L, 6BT5.9L or 6BTA5.9L Engine	Crankshaft Damper Pulley 0.753" ID, 8.22" OD, 2.10" Thick Replaces 3914454, J911422, J914454	AMJ958258	\$ 120.00	



Radiators

Application	Description	Part Number	Retail Price	Core
White®: 2-88, 2-110	Radiator Core: 21 3/4" x 22 1/4" x 3 1/2"	AM30-3348091	\$ 1195.00	
White®: (2-85, 2-105 ASN 297447)	Radiator Core: 21 7/8" x 22 1/8" x 22 1/8" 4 Rows, 8 Fins per Inch	AM30-3369641	\$ 1085.00	
White®: 2-135, 2-155	Radiator Core: 25" x 25 5/8" x 3 5/8" 6 Rows, 8 Fins per Inch Replaces 30-3203050	AM30-3394492	\$ 1160.00	
MM®: G750, Oliver®: 1550, 1555, 1600, 1650, 1655, White®: 2-62, 2-70, 2-78, 4-78	Radiator Replaces 163342AS, 163343AS, MFG0176, 163273A, 1652570	AM163272A	\$ 485.00	

White® / Oliver® / M&M®—Tractor

Radiator Hoses

Application	Description	Part Number	Retail Price	Core
Minneapolis-Moline®: 335 w/ Gas Engine, (445, Jet Star 4, Jet Star 4 Super - w/ Gas or Diesel Engine)	Radiator Hose, Upper 1.625" ID	AM10A7294	\$ 10.32	
Minneapolis-Moline®: Jet Star 3, Jet Star 3 Super - Gas or Diesel	Radiator Hose, Upper 1.375" & 1.75" ID	AM10A21032	\$ 13.99	
Minneapolis-Moline®: M5, M504, M602, M604 - Gas or Diesel	Radiator Hose, Upper 1.687" ID	AM10A9584	\$ 22.45	
Minneapolis-Moline®: (M670, M670 Super ASN 29901892 w/ Gas or LPG Engine or ASN 30000820 w/ Diesel Engine)	Radiator Hose, Upper 1.625" ID	AM10A23896	\$ 19.03	
Minneapolis-Moline®: (M670, M670 Super BSN 29901891 w/ Gas or LPG Engine or BSN 30000819 w/ Diesel Engine)	Radiator Hose, Upper 1.625" ID	AM10A22503	\$ 14.51	
Oliver®: Super 55, 550 SN 60501-72831 w/ Diesel Engine, 550 ASN 60501 w/ Gas Engine	Radiator Hose, Upper 1.50" ID	AME518	\$ 15.53	
Oliver®: 66, Super 66, 77, Super 77, 88, Super 88, 550, 660, 770, 880	Radiator Hose, Upper 1.50" ID	AMB388	\$ 4.51	
Oliver®: 66, Super 66, 660	Radiator Hose, Upper 1.50" ID	AML518	\$ 12.51	
Oliver®: 77, Super 77, 88, Super 88, 880	Radiator Hose, Upper 1.50" ID	AMM518	\$ 11.60	
Oliver®: (88, Super 88 SN 1017521-1017719 w/ Diesel Engine)	Radiator Hose, Upper 1.50" ID	AM100023A	\$ 8.23	
Oliver®: 550 ASN 72832	Radiator Hose, Upper 1.50" ID	AM102763A	\$ 29.63	
Oliver®: 550 Gas or Diesel SN 60501-127364, Super 55	Radiator Hose, Upper 1.50" ID	AM102764A	\$ 17.33	
Oliver®: 770 ASN 60501 w/ Gas or LPG Engine	Radiator Hose, Upper 1.50" ID	AM101963A	\$ 7.59	
Oliver®: (770, 880 ASN 60501 w/ Gas or Diesel Engine)	Radiator Hose, Upper 1.50" ID Replaces 101714A1	AM101714A	\$ 11.87	
Oliver®: 1265, 1270, 1355, 1365, 1370, White®: 2-50, 2-60	Radiator Hose, Upper 1.75" ID Replaces 677214A, 4950088	AM72089692	\$ 16.28	
Oliver®: 1465, 1470	Radiator Hose, Upper 1.50" & 1.75" ID	AM312900986	\$ 24.06	
Oliver®: (1550, 1555 - Gas or Diesel)	Radiator Hose, Upper 1.50" & 2" ID	AM161214A	\$ 20.64	
Oliver®: 1600 w/ Gas or Diesel	Radiator Hose, Upper 1.50" ID	AM155613A	\$ 32.50	
Oliver®: 1600 Gas, (1650, 1655 ASN 147569 w/ Gas), White®: 2-70 Gas	Radiator Hose, Upper 2" ID Replaces 157434AV	AM157434A	\$ 16.54	
Oliver®: 1650, 1655 ASN 147569 w/ Diesel Engine, White®: 2-70 Diesel	Radiator Hose, Upper 2" ID Replaces 158664AV	AM158664A	\$ 15.96	
Oliver®: 1750, 1755, 1855 - Gas or Diesel, 1850 Gas	Radiator Hose, Upper 2" ID Replaces 158620AV	AM158620A	\$ 13.85	
Oliver®: (1750, 1855 - Gas or Diesel), (1755, 1850 - Gas)	Radiator Hose, Upper 2" ID Replaces 158615AV	AM158615A	\$ 12.63	
Oliver®: 1755 Diesel	Radiator Hose, Upper 2" ID	AM168687A	\$ 15.47	
Oliver®: 1800 ASN 90525 w/ Gas or Diesel or ASN 140077 w/ LPG Engine	Radiator Hose, Upper 2" ID	AM104701A	\$ 16.35	

White® / Oliver® / M&M®—Tractor

Application	Description	Part Number	Retail Price	Core
Oliver®: 1800 SN 90525-140076 w/ LPG Engine	Radiator Hose, Upper 2" ID	AM104741A	\$ 15.56	
Oliver®: 1800 SN 90525-140076 w/ LPG Engine	Radiator Hose, Upper 2" ID	AM104742A	\$ 11.08	
Oliver®: 1850 Diesel	Radiator Hose, Upper 2" ID	AM158600A	\$ 28.10	
Oliver®: 1850 Diesel	Radiator Hose, Upper 2" ID	AM158715A	\$ 23.49	
White®: 2-55, 2-62, 2-65	Radiator Hose, Upper 1.50" ID	AM330033901	\$ 39.65	
White®: 2-85, 2-105	Radiator Hose, Upper 2" ID Replaces 30V3144380	AM303144380	\$ 13.05	
White®: (2-85, 2-105 ASN 297447)	Radiator Hose, Upper 2" ID Replaces 30V3295877	AM303295877	\$ 22.01	
White®: 2-88, 2-110	Radiator Hose, Upper 2" ID Replaces 30V3375943	AM303375943	\$ 20.81	
White®: 2-135, 2-155	Radiator Hose, Upper 2" ID Replaces 166288AV	AM166288A	\$ 21.38	
White®: 2-150	Radiator Hose, Upper 1.75" & 2" ID	AM303154912	\$ 12.31	
White®: 2-180	Radiator Hose, Upper 2" ID	AM303287092	\$ 18.27	
White®: 60 American, 80 American	Radiator Hose, Upper 1.75" ID Replaces 30-3457273	AM303457273	\$ 24.12	
White®: 100, 120, 125 Workhorse, 140, 145 Workhorse	Radiator Hose, Upper 1.75" ID Replaces 30V3443736	AM303443736	\$ 22.49	
White®: 160, 170 Workhorse, 185 Field Boss, 195 Workhorse	Radiator Hose, Upper 2.25" ID Replaces 30V3424235	AM303424235	\$ 31.77	
Minneapolis-Moline®: 445, Jet Star 4, Jet Star 4 Super - Gas or Diesel	Radiator Hose, Lower 1.625" ID	AM10A7815	\$ 27.24	
Minneapolis-Moline®: G900 Gas or Diesel, (M670, M670 Super ASN 29901892 w/ Gas or LPG Engine or ASN 30000820 w/ Diesel Engine)	Radiator Hose, Lower 2" ID	AM10A27664	\$ 13.39	
Minneapolis-Moline®: Jet Star 3, Jet Star 3 Super - Gas or Diesel	Radiator Hose, Lower 1.625" ID	AM10A20054	\$ 25.64	
Minneapolis-Moline®: (M5, M504, M602, M604 - Gas or Diesel), (M670, M670 Super BSN 29901891 w/ Gas or LPG Engine or BSN 30000000 w/ Diesel Engine)	Radiator Hose, Lower 1.625" & 2" ID	AM10A9932	\$ 21.47	
Oliver®: 550 ASN 127365 w/ Gas or Diesel	Radiator Hose, Lower 1.50" & 1.75" ID	AM156542A	\$ 16.10	
Oliver®: 1265, 1270, 1355, 1365, 1370, White®: 2-50, 2-60	Radiator Hose, Lower 1.437" ID	AM72089314	\$ 8.42	
Oliver®: 1465, 1470	Radiator Hose, Lower 1.50" & 1.75" ID	AM156543A	\$ 9.52	
Oliver®: (1550, 1555 SN 160000-201509 w/ Gas or Diesel Engine)	Radiator Hose, Lower 1.75" ID	AM160608A	\$ 8.35	
Oliver®: (1550, 1555 SN 147569-178173 w/ Gas Engine or All w/ Diesel Engine), 1600 Gas or Diesel, (1650, 1655 SN 147569-178173 w/ Gas Engine)	Radiator Hose, Lower 1.875" ID	AM104978A	\$ 10.75	

White® / Oliver® / M&M®—Tractor

Application	Description	Part Number	Retail Price	Core
Oliver®: (1550, 1555 ASN 201210 w/ Gas), 1650 ASN 178174 w/ Gas or Diesel, 1655 ASN 178174 w/ Diesel	Radiator Hose, Lower 1.75" & 2.125" ID	AM163362A	\$ 10.99	
Oliver®: (1550, 1555 ASN 201510 w/ Gas), 1850 Gas, (1650, 1655 ASN 147569 w/ Gas or Diesel), (1750, 1755, 1855 - Gas or Diesel), White®: 2-70 Gas or Diesel, 2-85, 2-105	Radiator Hose, Lower 2.125" ID Replaces 163337AV	AM163337A	\$ 5.13	
Oliver®: 1600 Gas or Diesel, (1650, 1655 ASN 147569 w/ Gas)	Radiator Hose, Lower 1.75" ID	AM104979A	\$ 6.49	
Oliver®: 1650, 1655 - Diesel	Radiator Hose, Lower 2.125" ID	AM158682A	\$ 8.78	
Oliver®: (1650, 1655 ASN 147569 w/ Diesel), 1850 Diesel	Radiator Hose, Lower 1.75" ID Replaces 158625AV	AM158625A	\$ 3.91	
Oliver®: 1750 Gas or Diesel, 1755 Diesel	Radiator Hose, Lower 2.125" ID	AM164131A	\$ 9.92	
Oliver®: 1800 ASN 124396 w/ Gas or Diesel Engine	Radiator Hose, Lower 2.25" ID	AM104699A	\$ 13.90	
Oliver®: 1850 Diesel	Radiator Hose, Lower 2" ID	AM158624A	\$ 20.23	
White®: 2-45, 2-55	Radiator Hose, Lower 1.125" & 1.625" ID	AM330031933	\$ 55.09	
White®: 2-62, 2-65	Radiator Hose, Lower 1.156" & 1.75" ID	AM330033898	\$ 37.04	
White®: (2-85, 2-105 SN 255216-297446)	Radiator Hose, Lower 2" ID Replaces 30V3145808	AM303145808	\$ 16.81	
White®: (2-85, 2-105 ASN 297447)	Radiator Hose, Lower 2.25" ID	AM303337456	\$ 23.14	
White®: 2-88, 2-110	Radiator Hose, Lower 2.25" ID Replaces 30V3350037	AM303350037	\$ 30.11	
White®: 2-135, 2-155	Radiator Hose, Lower 3" ID	AM157969A	\$ 13.10	
White: (2-135, 2-155 SN 272595-289550)	Radiator Hose, Lower 2.50" ID Replaces 166290AV	AM166290A	\$ 8.84	
White®: (2-135, 2-155 ASN 289551)	Radiator Hose, Lower 2.50" ID Replaces 30-3336867	AM303336867	\$ 7.02	
White®: 2-150	Radiator Hose, Lower 2.375" & 2.625" ID Replaces 10V30898	AM10A30898	\$ 14.12	
White®: 60 American, 80 American	Radiator Hose, Lower 2.25" ID Replaces 30-3457265	AM303457265	\$ 20.72	
White®: 160, 170 Workhorse, 185 Field Boss, 195 Workhorse	Radiator Hose, Lower 2" ID	AM303424243	\$ 16.81	
White®: 160, 170 Workhorse, 185 Field Boss, 195 Workhorse	Radiator Hose, Lower 2" & 2.375" ID	AM3920762	\$ 16.44	
Minneapolis-Moline®: G750 ASN 147569, Oliver®: 1650, 1655, 1750 ASN 180537, (1755, 1855, 1955 ASN 220000), 1800, 1850 ASN 150421, 1900, 1950, 1950T ASN 195080, White®: 2-70, 2-78, 4-78	Bypass Hose 1.75" ID	AM168494A	\$ 37.16	

White® / Oliver® / M&M®—Tractor



Water Pumps

The remanufactured water pumps we supply have an extra step added to the remanufacturing process to ensure quality. Since the bearing and seal assembly are critical in performance, we ensure air-tight seals by vacuum testing our water pumps prior to packaging. This guarantees no leakage will occur after your water pump has been installed.

Application	Description	Part Number	Retail Price	Core
Oliver®: 1465, 1470	Water Pump	AM8822883	\$ 105.00	
Oliver®: 1650 Diesel, 1655 Diesel ASN 147569, 1755, 1800 Diesel ASN 134684, 1850 Gas & LPG, 1855 Gas & Diesel, 1950T Gas & Diesel, 1955 Gas & Diesel, White®: 2-70	Reman Water Pump w/o pulley	AM157069A	\$ 145.00	\$ 30.00
Oliver®: 1850	Water Pump C/N 37711480	AM30-3061310	\$ 160.00	
White®: 2-85, 2-105, 2-88, 2-110	Water Pump Cast # - 37712630	AM3641880M91	\$ 205.00	
White®: 2-85, 2-105	Water Pump, 15/16" Shaft	AM3641365M91	\$ 207.00	
White®: 2-180, 4-150, 4-175, 4-180, 4-210, 4-225 - w/ 3208 Caterpillar® Engine	Water Pump w/ 3-Groove Pulley	AM9N5023	\$ 220.00	

Injection Pumps

All of our injection pumps are disassembled, thoroughly cleaned and inspected. All worn out parts are replaced and the pumps are reassembled with new gaskets. Pumps are tested for leaks and fuel delivery at low idle, high idle, full load, part load and at start up. Any pumps with an automatic advance system has the advance set. As an additional quality check, all pumps are tested with a special oil that will not varnish inside the pump.

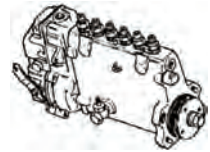

Application	Description	Part Number	Retail Price	Core
White®: 4.236 Engine w/ Mech Gov & Advance Device	Reman Injection Pump CAV, Mfg # 3248F440	AMP3248F440	\$ 895.00	\$ 200.00
White®: 4.236 Engine w/ Mech Gov & Advance Device	Reman Injection Pump CAV, Mfg # 3248F441	AMP3248F441	\$ 925.00	\$ 200.00
White®: 4.236 Engine w/ Mech Gov & Advance Device	Reman Injection Pump CAV, Mfg # 3248F451	AMP3248F451	\$ 925.00	\$ 200.00
White®: 2-105 w/ 6.354T Engine	Reman Injection Pump CAV, Mfg # 3260F278	AMP2-105-DPA	\$ 1075.00	\$ 200.00
White®: 2-105 Late w/ 6.354T Engine	Reman Injection Pump CAV, Mfg # 3269F840	AMP2-105-LDPA	\$ 1075.00	\$ 200.00
White®: 2-110 Early	Reman Injection Pump CAV, Mfg # - 3362F240	AMP2-110-F240	\$ 950.00	\$ 200.00
White®: 2-110 Mid-Early	Reman Injection Pump CAV, Mfg # - 3362F241	AMP2-110-F241	\$ 950.00	\$ 200.00
White®: 2-110 Mid-Late	Reman Injection Pump CAV, Mfg # - 3362F242	AMP2-110-F242	\$ 950.00	\$ 200.00
White®: 2-110 Late	Reman Injection Pump CAV, Mfg # - 3362F243	AMP2-110-F243	\$ 950.00	\$ 200.00
White®: 2-155	Reman Injection Pump Stanadyne, Mfg # DM4 629AL 3044	AMP2-155-DM	\$ 1250.00	\$ 300.00
Oliver®: 1850	Reman Injection Pump Manufacturing # - 3263F680	AMP3263F680	\$ 895.00	\$ 200.00



Turbochargers

Application	Description	Part Number	Retail Price	Core
Oliver®: 2150, White®: 2-105, 2-110 Replaces 303172023	Turbocharger TO4B51, AiResearch 2 3/4" OD on Intake	AM465740-9001	\$ 425.00	

White® / Oliver® / M&M®—Tractor

Application	Description	Part Number	Retail Price	Core
Oliver®: 1855, 1950, 1955	Reman Turbocharger TO4B38, AiResearch	AM465300-9008DR	\$ 960.00	\$ 200.00
White®: 2-135, 2-105, 2-155	Turbocharger T04B37, AiResearch 3" OD on Intake	AM465260	\$ 535.00	
White® Combine: 8900	Reman Turbocharger TO4B71, AiResearch	AM465154	\$ 730.00	\$ 200.00

Manifolds and Components



Application	Description	Part Number	Retail Price	Core
M&M®: Jet Star 5 Gas, M5, M504, M602, M604	Intake and Exhaust Manifold	AM10A9465	\$ 265.00	
M&M®: G750, Oliver®: 88, 880, 1600, 1650 - All w/ Gas Engine	Exhaust Manifold Manifold Gasket Set	AM156344A AMX36253	\$ 185.00 \$ 19.00	
Oliver®: 88, 880, 1600 - w/ Gas	Intake Manifold Manifold Gasket Set	AM1K425 AMX36253	\$ 116.00 \$ 19.00	
Oliver®: 880, 1650, 1655, White®: 2-70	Intake Manifold For machines w/ 2 5/8" Carburetor Bolt Spacing Replaces 101337A, 155896A	AM101337	\$ 145.00	
Oliver®: 1550, 1555, White®: 2-62 - All w/ Gas or LPG Engine ASN 159999	Exhaust Manifold Replaces 161158A	AM161818A	\$ 215.00	
Oliver®: 1750, 1755, 1800, 1850, 1855 - w/ Gas	Exhaust Manifold	AM155879A	\$ 215.00	
Oliver®: 1850 w/ Diesel	Exhaust Manifold Manifold Gasket Set, 3 Pc.	AM37782300 AMX36244	\$ 706.00 \$ 68.15	
Oliver®: 2050, 2150, White®: 2-135, 2-155 - All w/ Diesel	Exhaust Manifold Exhaust Manifold Manifold Gasket 1 Required Per Manifold	Front Section AM166871AV Rear Section AM72511206V AMX36255	\$ 180.00 \$ 140.00 \$ 31.05	
White®: 2-105, 2-110	Exhaust Elbow Use w/ 3609201M1 Exhaust Sleeve Replaces 30-3159027, 740695M1, 37731881	AM740695M1	\$ 97.50	
White®: 2-135, 2-150, 2-155 - w/ 6 Cylinder Diesel Engine	Exhaust Elbow	AM303216063	\$ 83.50	

Mufflers and Exhaust

Our mufflers are manufactured by experienced craftsmen here in the United States. All mufflers have welded seams. Aluminized steel is used for critical components. These features ensure that our products resist the corrosive effects of air, heat and the by-products of combustion that work to shorten muffler life. Additionally, they are painted either silver or black to cosmetically match its OEM counterpart, as well as provide further protection from the elements.

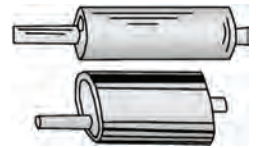

Application	Description	Part Number	Retail Price	Core
Universal Tractors	Exhaust Pipe Black Finish, Straight Pipe 4" ID, Overall Length 47.50"	AM400SP	\$ 59.00	
Universal Tractors	Exhaust Pipe Diameter 3.50", Length 48"	AMS312X48	\$ 57.00	

White® / Oliver® / M&M®—Tractor

Application	Description	Part Number	Retail Price	Core
2-105 Diesel	Muffler Oval, Inlet 3 7/16", Length 38"	AM30-3387712	\$ 183.00	
	Inlet Clamp	CL-312	\$ 6.50	
	Rain Cap	RC-8	\$ 16.50	
2-105 Diesel, 2-135 Diesel - Non-Aspirated	Muffler Oval, Inlet 3 7/16", Length 38"	AM30-3322734	\$ 137.00	
	Inlet Clamp	CL-312	\$ 6.50	
	Rain Cap	RC-8	\$ 16.50	
2-135 Diesel	Muffler Vertical Oval, Inlet 3 7/16", Length 38" w/ 1 1/2" OD Aspirator Tube	AM30-3322742	\$ 231.00	
	Inlet Clamp	CL-312	\$ 6.50	
	Rain Cap	RC-9	\$ 18.00	
5 Star, G, G-6 / G-VI, Jet Star Late, U, Z Early	Muffler Vertical Round, Inlet 2 3/4", Length 26"	AM10A12633	\$ 34.50	
	Inlet Clamp	CL-234	\$ 11.00	
	Rain Cap	RC-7	\$ 14.50	
77 Diesel, 88 Diesel	Muffler Round, Inlet 2 3/8", Length 10"	AMK452	\$ 27.00	
	Inlet Clamp	CL-212	\$ 7.00	
	Inlet Clamp	CL-134	\$ 4.00	
(770, 880, 1550, 1600 - Gas or Diesel Model), 1650 Gas	Muffler Round, Inlet 2 3/8", Length 29"	AM100694A	\$ 37.50	
	Inlet Clamp	CL-212	\$ 7.00	
	Rain Cap	RC-3	\$ 14.50	
1650 Diesel, 1655, 1750, 1755, 1850 Gas or Diesel, 1855 Gas	Muffler Oval, Inlet 2 15/16", Length 32"	AM30-3040828	\$ 134.00	
	Inlet Clamp	CL-300	\$ 6.00	
	Rain Cap	RC-3	\$ 14.50	
1650 Diesel, 1750, 1800, 1850 Gas, LPG or Diesel	Muffler Round, Inlet 2 15/16", Length 34"	AM104764	\$ 52.50	
	Inlet Clamp	CL-300	\$ 6.00	
	Rain Cap	RC-3	\$ 14.50	
1850 Diesel, 1950T Diesel, 1955 Diesel, 2050 Diesel, 2150 Diesel	Muffler Oval, Inlet 3 1/4", Length 36"	AM164961A	\$ 169.00	
	Clamp	CL-400	\$ 6.50	
1900, 1950 - w/ GM Diesel Engine ASN 124396	Muffler Oval, Inlet 3 1/2", Length 27"	AM79015996V	\$ 61.00	
	Inlet Clamp	CL-312	\$ 6.50	
	Rain Cap	RC-4	\$ 16.00	

White® / Oliver® / M&M®—Tractor

Starters

All of our remanufactured starters are disassembled, cleaned and inspected. Almost all units receive new field coils. If it meets OEM specifications the armature is test turned and under cut, otherwise it is replaced with a quality factory remanufactured or new part. Starters with factory solenoids have the solenoids replaced with new parts. The drive is carefully inspected and if it does not meet specifications it is replaced with new or quality factory remanufactured drives.











Application	Description	Part Number	Retail Price	Core
Oliver®: (1850, 1950, 1950T - Diesel), White®: (2-70, 2-85, 2-88, 2-105, 2-110 - w/ D283 Waukesha® Diesel Engine)	Starter, 12 Volt HD Planetary Gear Reduction, 10 Tooth Steel Pinions, Steel Ring Gear, CW Rotation Replaces 1113391, 1113672	AMX34112	\$ 285.00	
	Solenoid Use w/ AMX34112 Starter	AMX34113	\$ 60.00	
M&M®: A4T-1400, A4T-1600, G950, G1000 Vista, G1050, G1350, G1355, Jet Star 3 Super, M670, M670 Super, U-302, U-302 Super	Neutral Starting Switch Replaces 121629C3, 83954C91, AH98872	AMX34147	\$ 30.00	



Air Cleaner Components

Application	Description	Part Number	Retail Price	Core
Oliver®: 770, 880, 1550, 1555, 1650, 1655, 1755, 1800, 1855, 1900, White®: 2-62, 2-70, 2-78, 4-78 Replaces 71125804	Small Precleaner Bowl 7" Diameter	AMP02-0227	\$ 10.00	
Oliver®: 1855, 1955 Replaces 70651270	Large Precleaner Bowl 10.50" Diameter	AMP01-6330	\$ 12.00	

Tie Rods and Components



Application	Description	Part Number	Retail Price	Core
 White®: 2-70, 2-85 SN 263341-271719, 2-105 SN 255216-271913, Oliver®: 1555, 1600, 1655, 1750, 1755, 1800, 1850, 1855, 1955	Tie Rod Assembly Includes Inner and Outer Tie Rod Ends, Tube, Clamp and Hardware	AM164210AS	\$ 65.00	
 White®: 2-70, 2-85 SN 263341-284964, 2-105 SN 255216-285182, Oliver®: 1555, 1600, 1655, 1750, 1755, 1800, 1850, 1855, 1955	Tie Rod Tube 18.625" Long, 1.00" Internal Thread	AM164367A	\$ 14.00	
 White®: 2-85 ASN 284965, 2-88, 2-105 ASN 285183, 2-110, 2-135, 2-155, 100, 120, 125 Workhorse, 145 Workhorse	Tie Rod Tube w/ Clamp 18" Long 16 Internal Thread	AM72162854	\$ 35.00	
 White®: 2-70, 2-105, Oliver®: 1555, 1600, 1755, 1800, 1850, 1855, 1955	Tie Rod 3.687" Long, 1.00" Diameter Right Hand 16 Thread	AM25-1001398	\$ 20.00	
 White®: 2-70, 2-105, Oliver®: 1555, 1600, 1755, 1800, 1850, 1855, 1955	Tie Rod 18.75" Long, 0.937" Diameter 15 Notches	AM164365A	\$ 26.00	
 White®: 2-85 ASN 284965, 2-88, 2-105 ASN 285183, 2-110, 2-135, 2-155, 100, 125 Workhorse, 145 Workhorse	Tie Rod 4.00" Long, 1.00" Diameter Right Hand 16 Thread	AM30-3443124	\$ 23.00	
 White®: 2-85, 2-105, 2-110, W100	Tie Rod 16.75" Long, 0.937" Diameter	AM30-3443132	\$ 30.00	
 White®: 2-85 SN 271720-284964, 2-105 SN 271914-285182	Tie Rod 18.75" Long, 0.937" Diameter	AM30-3211029	\$ 45.00	
 White® 2-135, 2-155, 100, 125 Workhorse, 145 Workhorse, 200	Tie Rod 15.75" Long, 0.937" Diameter Shank	AM72161866	\$ 27.00	

White® / Oliver® / M&M®—Tractor

	Application	Description	Part Number	Retail Price	Core
	White® Tractors: 2-135, 2-155, 100 Workhorse, 120 Workhorse, 125 Workhorse, 140 Workhorse, 145 Workhorse, 6125, 6145	Complete Tie Rod Assembly Includes AM30-3443124 Tie Rod, AM72161866 Tie Rod, AM72162854 Tie Rod Tube w/ Clamp and Jam Nut	AM72161861	\$ 110.00	
	White®: 2-180, 170, 195, W160, W185	Tie Rod 4.75" Long, 1.00" Diameter, 16 Thread	AM72161867	\$ 17.00	
	Oliver®: Super 55, Super 77, 550, White®: 2-44	Inner Tie Rod 18 Left Hand Thread 0.687" Diameter, 8.562" Long Replaces 1ES1161A	AM106681AS	\$ 65.00	

Spindles

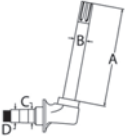
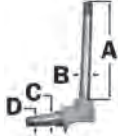
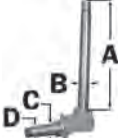
Spindles are forged from high grades of alloy steel, machined and assembled to exact specifications that meet or exceed OEM specifications.

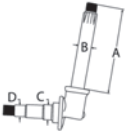
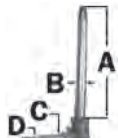
	Application	Description		Part Number	Retail Price	Core
	670, G1000	Spindle A - 14.312 B - 1.50 C - 1.50 D - 1.375	Left or Right Hand	AM11B23096	\$ 383.96	
	670, G1000	Spindle A - 13.875 B - 1.375 C - 1.50 D - 1.375	Left or Right Hand	AM11B23156	\$ 370.48	
	M, M5, 302, 602, 5 Star	Spindle A - 13.875 B - 1.375 C - 1.50 D - 1.375	Left or Right Hand	AM11B8726	\$ 379.31	
	Oliver®: 1650, 1750, 1850, 1950, 1950T, 1655, 1755, 1855, 1955, White®: 2-70, 2-78, 2-85, 2-88, 2-105, 2-110, Industrial: 4-78	Spindle A - 16.25 B - 1.747 C - 1.75 D - 1.375	Left or Right Hand	AM161959A	\$ 234.23	
	M&M®: 1870, 2270, (G900, G950, G1050 - HD), G955, G1350, G1355, G2155, Oliver®: 1865 (HD), 2255, White®: 2-135, 2-150, 2-155, 2-180, 160, 170, 185, 195	Spindle Replaces 11A26941 A - 12.30 B - 2.25 C - 2.00 D - 1.50	Left or Right Hand	AM72160101	\$ 615.57	
	Oliver®: 1550, 1555, 1650, 1655, White®: 2-62, 2-78, 4-78	Spindle A - 14.25 B - 1.50 C - 1.625 D - 1.25	Left or Right Hand	AM161473A	\$ 384.92	
	77, 7700, 88, 880, 1550, 1555, 1600, 1655 BSN 147569, 1750 S/N 180537-201090, 1850 S/N 150421-169758	Spindle A - 16.25 B - 1.50 C - 1.625 D - 1.25	Left or Right Hand	AM161340A	\$ 293.55	

White® / Oliver® / M&M®—Tractor

Application	Description	Part Number	Retail Price	Core
8745, 8765	Spindle Bushing	AM882327M1	\$ 19.74	



Wheel Hubs

Application	Description	Part Number	Retail Price	Core
Oliver®: 66, 550 (ASN 79236 w/ Adjustable Axle), 660	Wheel Hub, 6-Bolt	AM102718A	\$ 111.50	
Oliver®: 77, 88, 770, 880, 1550, 1555, 1650, 1655, 1750, 1755, 1800, 1850, 1855, White®: 2-62, 2-78	Wheel Hub, 6-Bolt Outer bearing cup measures 2.326" OD	AM155192A	\$ 198.52	
Oliver®: 1650, 1655, 1750, 1755, 1850, 1855, 1950, 1950T, 1955, White®: 2-70, 2-85, 2-88, 2-105, 2-110, W60, W80, W100, W120	Wheel Hub, 6-Bolt Outer bearing cup measures 2.873" OD	AM30-3363651	\$ 175.49	



Steering Arms

Application	Description	Part Number	Retail Price	Core
1550, 1555, 1600, 1650, 1750, 1755, 1800, 1850, 1855, 1950, 1950T, 1955	Steering Arm, Center 10 Spline Large hole on top	AM161424A	\$ 390.58	
1550, 1555, 1600, 1650, 1750, 1755, 1800, 1850, 1855, 1950, 1950T, 1955	Steering Arm, Center 10 Spline Large hole on bottom	AM161424SPL	\$ 389.22	
2-85 Late, 2-105, 2-135, 2-155	Steering Arm, Center 6 Spline (Big Tie Rod)	AM30-3117561	\$ 260.42	



Power Steering Pumps and Conversion Kits

Application	Description	Part Number	Retail Price	Core
Oliver®: 700, 1365, 1370, 1465, 1470, White®: 2-60	Power Steering Pump 11 cc, Left Hand, CCW Rotation 1/8" Tapered Shaft Replaces 1825210M91	AM3539858M91	\$ 184.00	

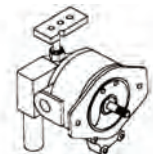

Hydraulic Pumps

Application	Description	Part Number	Retail Price	Core
2-70, 1600, 1650, 1750, 1800, 1850, 1950	Hydraulic Pump w/ Manifold Used in tractors with internal "open center" hydraulics. These pumps will replace all previous versions of pumps used, with one important exception: If old hydraulic pump has a relief valve in the back housing of the pump - DO NOT USE!	AM3062449	\$ 530.00	
2-70, 1600, 1650, 1750, 1800, 1850, 1950	Hydraulic Pump w/ Hose Used in tractors with internal "open center" hydraulics. These pumps will replace all previous versions of pumps used, with one important exception: If old hydraulic pump has a relief valve in the back housing of the pump - DO NOT USE!	AM30624491	\$ 745.00	

White® / Oliver® / M&M®—Tractor

Application	Description	Part Number	Retail Price	Core
Oliver®: 1755, 1855, 1955, 2255 White®: 2-105, 2-135, 2-150, 2-155, 2-180, 4-150, 4-180, 2-85	Reman Hydraulic Pump	AM3141764W	\$ 1850.00	\$ 75.00

Input Shafts

Application	Description	Part Number	Retail Price	Core
77, 770	Transmission Input Shaft 10.625" Long	AM1K616A	\$ 287.40	
88, 880 - Non-Hydro Power Models	Transmission Input Shaft 12.00" Long	AM1K616	\$ 323.91	
1950 ASN 1897007, 1950T, 1955	Transmission Input Shaft 12.50" Long	AM163981A	\$ 638.14	
2-85, 2-88, 2-105, 2-110, 2255	Transmission Input Shaft 12.50" Long Replaces 30-3088383	AM30-3381455	\$ 493.11	



PTO Shafts and Hubs

Application	Description	Part Number	Retail Price	Core
2-135, 2-155	Front PTO Shaft 26.203" Long	AM30-3360679	\$ 266.84	
4-150, 4-180	Front PTO Shaft 26.875" Long	AM30-3088774	\$ 206.67	
2-62, 2-78, 4-78, 77, 88, 770, 880, 1550, 1555, 1600, 1650, 1655	PTO Hub Bolts to Flywheel, 12 Internal Splines, Hub is sold w/o bearing	AM30-3068277	\$ 235.06	
4-175, 1850 Diesel	PTO Hub Bolts To Flywheel, Solid Hub w/ 17 Splines, Replaces dampened style hub	AM165988A	\$ 209.86	
1750, 1755, 1850 Gas, 1855, 1950T, 1955	PTO Hub Bolts To Flywheel 17 Internal Splines, 5 Mounting Holes	AM164103A	\$ 278.93	
2-85, 2-88, 2-105, 2-110, 2-135, 2-155, 1850 Diesel, 2050, 2150	PTO Hub Bolts To Flywheel 17 Internal Splines, 6 Mounting Holes	AM164812A	\$ 243.38	
77, Super 77	PTO Shaft 60.00" Long, 12 Spline	AM1MA1571A	\$ 363.77	
1550, 1555	PTO Shaft 71.062" Long, 12 Spline	AM160489A	\$ 380.95	
1600	PTO Shaft 70.375" Long, 12 Spline	AM155584A	\$ 494.67	
1650, 1655	PTO Shaft 73.75" Long, 12 Spline	AM159907A	\$ 530.20	
1750, 1755, 1850 ASN 194007, 1855, 1950, 1955	PTO Shaft 67.125" Long, 17 Spline Note: Shaft has plain finish between center and rear splines Replaces 163463A	AM30-3054527	\$ 521.20	
2-105, 1870, 2255, 2270, G955, G1355	PTO Shaft 68.375" Long, 17 Spline	AM30-3075338	\$ 300.67	
4-150, 4-180	PTO Drive Coupler 2.75" Long, Use w/ AM30-308774	AM30-3220923	\$ 83.78	

White® / Oliver® / M&M®—Tractor

Application	Description	Part Number	Retail Price	Core
2-85, 2-88, 2-105, 2-110, 2-150, 4-150, 1750, 1755, 1850, 1855, 2255, G955, G1355	PTO Output Shaft - 540 RPM 9.97" Long, 6 Spline	AM158281A	\$ 156.47	

PTO Adapters

Application	Description	Part Number	Retail Price	Core
Tractors up to 70HP	PTO Adapter Small 540 to 1000 Spline Changes PTO from 1 3/8" x 6 spline to 1 3/8" x 21 spline and extends the PTO shaft 4 1/8"	AMX59112	\$ 40.00	
Tractors up to 70HP	PTO Adapter Small 1000 to 540 Spline, 6 3/8" Overall Length Reduces PTO from 1 3/8" x 21 spline to 1 3/8" x 6 spline and extends the PTO shaft 4 1/8"	AMX59108	\$ 40.00	
Tractors up to 100HP	PTO Adapter Large 1000 to 540 Spline, 7 1/2" Overall Length Reduces PTO from 1 3/4" x 20 spline to 1 3/8" x 6 spline and extends the PTO shaft 4 5/8"	AMX59109	\$ 70.00	
Tractors up to 100HP	PTO Adapter Large 1000 to Small 1000 Spline, 7" Overall Length Changes PTO from 1 3/4" x 20 Spline to 1 3/8" x 21 Spline and extends the PTO shaft 4 5/8"	AMX59110	\$ 70.00	

Brakes

Application	Description	Part Number	Retail Price	Core
M&M®: G550, G750, Oliver®: (77, 88 - w/ Disc Brakes), 770, 880, 1550, 1555, 1600, 1650, 1655, White®: 2-70 Field Boss, Ind: 2-62, 2-78, 4-78	Brake Disc, Bonded 29 Spline, 7" OD, 4" ID	AM106724A	\$ 17.00	
M&M®: G955, G1355, Oliver®: 1750, 1755, 1850, 1855, 1870, 1950, 1950T, 1955, 2050, 2255, 2270, White®: 2-85, 2-88, 2-105, 2-110, 2-150, 4-150, 4-175, 4-180	Brake Disc, Bonded 21 Spline, 8" OD, 5" ID Use w/ 2.75" Shaft	AM30-3135241	\$ 17.00	
M&M®: Jet Star 5, M5, M504, M602, M604, M670, M670 Super	Brake Disc 3" ID, 7" OD, 24 Spline	AM70277355	\$ 48.51	

Steering Shafts

Application	Description	Part Number	Retail Price	Core
88, 880, 1550, 1600, 1655, 1750, 1850, 1950	Steering Shaft 9.16" long, 10 spline	AM30-3110311	\$ 189.17	

Sway Blocks

Application	Description	Part Number	Retail Price	Wholesale	Core
1755, 1855, 1950, 1955, 2-85, 2-105, 2-110	Sway Block, Left Hand	AM30-3018423	\$ 15.00	\$ 10.00	







Quick Hitches

Application	Description	Part Number	Retail Price	Core
Cat II	Quick Hitch, 4" x 6" Beam 36" Wide, Includes 1 1/8" Mounting Pins and Adapter Bushings	AMX741020	\$ 565.00	
Cat III	Quick Hitch, 4" x 6" Beam 38" Wide, Includes 1 7/16" Mounting Pins	AMX741022	\$ 565.00	





White® / Oliver® / M&M®—Tractor

Application	Description	Part Number	Retail Price	Core
Cat III	Quick Hitch, 4" x 6" Beam 44" Wide, Includes 1 7/16" Mounting Pins	AMX741021	\$ 565.00	
(6710, 6810 ASN J117019)	Pull Arm Latch, CAT III Right or Left Hand For Flat/Hook Style Pull Arm Replaces 3903314M91, 86017137, CH167802	AMAL117727	\$ 60.00	

Lighting







Application	Description	Part Number	Retail Price	Core
 M&M®: A4T-1400, A4T-1600, G750, G850, G900, G950, G1000, G1050, G1350, G1355, M670, M670 Super, U-302 (Replaces 30-3068242, 10A20255, 10A20258), Oliver®: 770, 880, 1550, 1555, 1600, 1650, 1655, 1750, 1755, 1800, 1855, 1865, 1900, 1950, 1955, 2050, 2150, 2655, White®: 2-70, 2-85, 2-105, 2-135, 2-150, 2-155, 2-180, 4-150, 4-175, 4-210, 4-225, 4-270 (Replaces 30-3068242, 105340AS, 105341AS, 164089AS, 164108AS)	LED Trapezoid Light Fender Mount 4.50" Sealed Beam Round Light 2800 Lumens, 40 Watts, 3.30 Amps For 12 Volt to 24 Volt Systems Rear Stud Mount w/ Built-In Heat Sink Includes Both Long and Short Rubber Bezels	AMTL2060	\$ 95.00	
 White®: 60 American, 80 American, 100, 120, 125 Workhorse, 140, 145 Workhorse, 170 Workhorse, 195 Workhorse Replaces 30-3534510	LED Headlight Hood and Cab Mount 6.75" x 4.25" Rectangle Light Dual Hi/Lo Beam 3500 Lumens, 60 Watts, 5 Amps For 12 Volt to 24 Volt Systems Includes Connector and Adpater, Plug-and-Play	AMTL9020	\$ 99.00	
	LED Headlight Hood and Cab Mount 6.75" x 4.25" Rectangle Light Dual Hi/Lo Beam 3500 Lumens, 60 Watts, 5 Amps For 12 Volt to 24 Volt Systems Includes Connector, Plug-and-Play	AMRE46298	\$ 79.20	
 Universal Equipment	LED Floodlight All-Position Light 4.25" x 4.25" Square Light 2650 Lumens, 48 Watts, 4 Amps For 12 Volt to 24 Volt Systems Includes Mounting Bracket and Stainless Steel Hardware	AMTL105F	\$ 95.00	
 Universal Equipment	LED Floodlight All-Position Light 6.25" x 1.75" Rectangle Light 1300 Lumens, 18 Watts, 1.50 Amps For 12 Volt to 24 Volt Systems Includes Mounting Bracket and Stainless Steel Hardware	AMTL118F	\$ 50.00	
 Universal Equipment	LED Floodlight All-Position Light 5" Round Light 3200 Lumens, 40 Watts, 3.30 Amps For 12 Volt to 24 Volt Systems Includes Mounting Bracket and Stainless Steel Hardware	AMTL180	\$ 89.00	

White® / Oliver® / M&M®—Tractor

Application	Description	Part Number	Retail Price	Core
 Universal Equipment	LED Floodlight All-Position Light Round Light 6900 Lumens, 50 Watts, 4.10 Amps For 9 Volt to 32 Volt Systems Includes Mounting Bracket and Stainless Steel Hardware	AMTL500F	\$ 120.00	
	LED Floodlight All-Position Light 4.30" Round Light 5040 Lumens, 50 Watts, 4.10 Amps For 12 Volt to 24 Volt Systems Includes Stainless Steel Adjustable Mounting Bracket	AMAT305931	\$ 96.00	
 Universal Equipment	LED Floodlight All-Position Light 4.25" Round Light 2650 Lumens, 42 Watts, 3.50 Amps For 12 Volt to 24 Volt Systems Includes Mounting Bracket and Stainless Steel Hardware	AMTL115F	\$ 59.00	
Universal Equipment	LED Wide Floodlight All-Position Light 5" x 7" Rectangle Light 3800 Lumens, 35 Watts For 12 Volt to 24 Volt Systems	AMX34171	\$ 60.00	
 Universal Equipment	LED Floodlight, Sealed Beam Fender Mount 4.50" Diameter Round Light 1250 Lumens, 18 Watts, 1.50 Amps Trapezoid Pattern For 12 Volt to 24 Volt Systems	AMTL3010	\$ 40.00	
	LED Floodlight Fender Mount 4.50" Diameter Sealed Beam Round Light 1250 Lumens, 18 Watts, 1.20 Amps Trapezoid Pattern For 12 Volt to 24 Volt Systems Lasts 50 times longer than halogen lighting, vibration resistant w/ no filament failures, uses original mount and wiring, Operating temperature of -40°F to 140°F / -40°C to 60°C	AMRE336111	\$ 35.00	
 Universal Equipment	LED Floodlight Fender Mount 4.50" Diameter Sealed Beam Round Light 1440 Lumens, 18 Watts, 1.60 Amps Lasts 50 times longer than halogen lighting, vibration resistant w/ no filament failures, 2-terminal connection, Operating temperature of -40°F to 140°F / -40°C to 60°C	AMRE336112	\$ 67.75	
 Universal Equipment	LED Floodlight Cab and Fender Mount 3.50" x 6" Rectangle Light 3600 Lumens, 40 Watts, 3 Amps	AMX34146	\$ 65.00	

White® / Oliver® / M&M®—Tractor

White® / Oliver® / M&M®—Tractor



Application	Description	Part Number	Retail Price	Core
 8510, 8610, 8710, 8810	LED Floodlight/Spotlight Combo Hood Mount 6" x 4" Rectangle Light Dual Hi/Lo Beam 3500 Lumens, 60 Watts, 5 Amps For 12 Volt to 24 Volt Systems Uses Original Mount and Wiring Includes Connector and Stainless Steel Hardware	AMTL6040	\$ 110.00	
 Universal Equipment	LED Spotlight All-Position Light 4.25" x 4.25" Square Light 1400 Lumens, 27 Watts, 2.20 Amps For 12 Volt to 24 Volt Systems	AMTL100S	\$ 45.00	
 Universal Equipment	LED Spotlight All-Position Light 6.25" x 1.75" Rectangle Light 1300 Lumens, 18 Watts, 1.50 Amps For 12 Volt to 24 Volt Systems Includes Mounting Bracket and Stainless Steel Hardware	AMTL118S	\$ 50.00	
 Universal Equipment	LED Spotlight All-Position Light Round Light 6900 Lumens, 50 Watts, 4.10 Amps For 9 Volt to 32 Volt Systems Includes Mounting Bracket and Stainless Steel Hardware	AMTL500S	\$ 120.00	
 Universal Equipment	LED Trapezoid Light Cab and Fender Mount 4.50" Diameter Round Light 2800 Lumens, 40 Watts, 3.30 Amps Trapezoid Pattern For 12 Volt to 24 Volt Systems Bottom Mount w/ Built-In Heat Sink Includes Mounting Bracket, Long and Short Rubber Bezels and Stainless Steel Hardware	AMTL2080	\$ 95.00	
	LED Trapezoid Light Cab and Rear Fender Mount 4.50" Diameter Round Light 2800 Lumens, 40 Watts, 3.30 Amps Trapezoid Pattern For 12 Volt to 24 Volt Systems Bottom Mount w/ Built-In Heat Sink Includes Mounting Bracket, Long and Short Rubber Bezels and Stainless Steel Hardware	AMX33121	\$ 76.00	
 Universal Equipment	LED Warning Light Cab, Header or Swather Mount Can be used for Turn Signal, Brake or Running Lights 4.125" Diameter Round Light Double Sided, Amber Lenses 25 Bulbs per Side For 12 Volt to 24 Volt Systems	AMTLFL2	\$ 55.00	
	LED Warning Light Cab, Header or Swather Mount Can be used for Turn Signal, Brake or Running Lights 4.125" Diameter Round Light Double Sided, Amber Lenses 25 Bulbs per Side For 12 Volt to 24 Volt Systems	AMX1910149	\$ 44.00	

White® / Oliver® / M&M®—Tractor

Application	Description	Part Number	Retail Price	Core
 Universal Equipment	LED Warning Light Cab, Header or Swather Mount Can be used for Turn Signal, Brake or Running Lights 4.125" Diameter Round Light Double Sided, Red and Amber Lenses 25 Bulbs per Side For 12 Volt to 24 Volt Systems	AMTLFL3	\$ 55.00	
	LED Warning Light Cab, Header or Swather Mount Can be used for Turn Signal, Brake or Running Lights 4.125" Diameter Round Light Double Sided, Red and Amber Lenses 25 Bulbs per Side For 12 Volt to 24 Volt Systems	AMX33126	\$ 44.00	
 Universal Equipment	LED Magnetic Warning Light All-Position Light 360° Flashing Light, Multiple Patterns 9.50" x 6.75" Rectangle Light Magnetic Base or Solid Mount For 12 Volt to 24 Volt Systems Includes Cigarette Lighter Adapter, Wiring and Switch	AMTL1100	\$ 170.00	
 Universal Equipment	LED Magnetic Warning Light All-Position Light 360° Flashing Light, Multiple Patterns 14" x 6.75" Rectangle Light Magnetic Base or Solid Mount For 12 Volt to 24 Volt Systems Includes Cigarette Lighter Adapter, Wiring and Switch	AMTL1200	\$ 190.00	
Universal Equipment	Warning Beacon 360° Flashing Beacon, Amber Lens For 0.9435" Diameter Pipe Replaces 84337818, AZ44705, AZ101891	AM82018390	\$ 45.64	
 Universal Equipment	LED Warning Beacon 360° Flashing Beacon 2.75" x 5.25" Light Polycarbonate Amber Lens and Housing For 12 Volt to 24 Volt Systems Includes Solid Mounting Pad and Stainless Steel Hardware	AMTL2100	\$ 30.00	
 Universal Equipment	LED Warning Beacon 360° Flashing Beacon, 3 Different Patterns 5" x 10" Light Amber Lens, 48 Watts, 4 Amps For 12 Volt to 24 Volt Systems Brackets Sold Separately	AMX33131	\$ 75.00	
 Universal Equipment	Warning Beacon Bracket	AMX33132	\$ 15.00	
 Universal Equipment	Warning Beacon Bracket	AMX33133	\$ 15.00	

White® / Oliver® / M&M®—Tractor

White® / Oliver® / M&M®—Tractor

Application	Description	Part Number	Retail Price	Core
 Universal Equipment	Warning Beacon Bracket	AMX33137	\$ 15.00	
 Universal Equipment	Warning Beacon Bracket	AMX33135	\$ 15.00	
 Universal Equipment	LED Light Bar 4" Long, 1260 Lumens, Cree Bulbs	AMLED4	\$ 45.00	
	LED Light Bar Flood/Spotlight Combo 10" Long, 5700 Lumens, 50 Watts, 4.20 Amps For 12 Volt to 24 Volt Systems Includes Mounting Bracket and Stainless Steel Hardware	AMTL10SRC	\$ 129.00	
	LED Light Bar Floodlight/Spotlight Combo 14" Long, 5400 Lumens, 72 Watts, 6 Amps Die Cast Aluminum Housing, Polycarbonate Lens For 12 Volt to 24 Volt Systems Includes Mounting Bracket and Heavy Duty Stainless Hardware	AMTLB410C	\$ 150.00	
	LED Light Bar Floodlight/Spotlight Combo 30" Long, 13600 Lumens, 150 Watts, 12.50 Amps For 12 Volt to 24 Volt Systems Includes Mounting Bracket and Stainless Steel Hardware	AMTL30SRC	\$ 230.00	
	LED Light Bar 30" Long, 13860 Lumens, Cree Bulbs	AMLED30	\$ 130.00	
	LED Light Bar Floodlight/Spotlight Combo 40" Long, 17300 Lumens, 200 Watts, 16.70 Amps For 12 Volt to 24 Volt Systems Includes Mounting Brackets and Stainless Steel Hardware	AMTL40SRC	\$ 300.00	
	LED Light Bar 40" Long, 18200 Lumens, Cree Bulbs	AMLED40	\$ 160.00	
	LED Light Bar Floodlight/Spotlight Combo 42" Long, 14500 Lumens, 240 Watts, 19 Amps For 12 Volt to 24 Volt Systems Includes Mounting Bracket and Stainless Steel Hardware Replaces 1163691	AMTLB440C	\$ 250.00	
	LED Light Bar, Curved 50" Long, 21500 Lumens, Cree Bulbs	AMLED50C	\$ 190.00	



White® / Oliver® / M&M®—Tractor

Application	Description	Part Number	Retail Price	Core
 Universal Equipment	LED Magnetic Work Light	AMTL2460	\$ 79.00	
	All-Position Light 3.25" Square Floodlight 900 Lumens Magnetic Base Includes Lithium Ion Battery, Cigarette Lighter and DC Charger			

Glass















Application	Description	Part Number	Retail Price	Core
6710, 6810, 8310, 8410, 8510, 8610, 8710, 8810	Door Glass, Right Hand	AM3907222M1	\$ 466.87	
	Door Glass, Left Hand	AM3907221M1	\$ 366.00	

Air Conditioning and Components

Application	Description	Part Number	Retail Price
 White®: 2-85, 2-105, 2-150, 2-185	Compressor Conversion Kit York to Sanden Includes Compressor, Mounting Bracket, Compressor Manifold, O-Rings, Service Valves and Mounting Hardware Requires Pag Oil 100V, 6.76 oz (200 cc)	AMX10200	\$ 395.00
	Ultra Pag Double End Capped, 100V, 8 oz	AMX10267	\$ 12.00
	Universal Pag Oil, 8 oz	AMX10274	\$ 8.25
	Compressor Conversion Kit York Style to Sanden Style Includes Compressor, Mounting Brackets, Compressor Manifold and Mounting Hardware 2-Groove Long Body Replacement Kit, Replaces York 2-Groove w/ 1.66" Gauge Line (measure from front side mounting hole to first clutch groove on original York) Requires Pag Oil 100V, 6.76 oz (200 cc)	AMX10199	\$ 395.00
 White®: 2-135, 2-155	Ultra Pag Double End Capped, 100V, 8 oz	AMX10267	\$ 12.00
	Universal Pag Oil, 8 oz	AMX10274	\$ 8.25
	Compressor Conversion Kit York Style to Aftermarket Sanden Style Includes Compressor, Mounting Brackets, Compressor Manifold, O-Rings and Mounting Hardware See Manufacturer for Oil Type and Quantity	AMX10263	\$ 450.00
	Premium Synthetic Ester Oil, 100V, 12 oz	AMX10273	\$ 11.00
 White®: 2-85, 2-105, 2-135, 2-150, 2-155, 2-180, 4-150, 4-175, 4-180, 4-210, 4-210, Oliver®: 1755, 1855, 1955, 2255, M&M®: G955, G1355 Replaces 30-3075699	Compressor, York Style Left Hand Suction, Rotolock Clutch Not Included Requires Synthetic Ester Oil 100V, See Manufacturer for Oil Quantity	AMX10225	\$ 260.00
	Double Groove Clutch for York Compressor, 7" Use w/ AM54-032, AMX10177 or AMX10225 Compressor For York Compressor	AM470	\$ 101.00
	Premium Synthetic Ester Oil, 100V, 12 oz	AMX10273	\$ 11.00



White® / Oliver® / M&M®—Tractor

White® / Oliver® / M&M®—Tractor

Application	Description	Part Number	Retail Price
 Universal Equipment	High Pressure Switch Normally Open, Opens at 305 PSI, Closes at 395 PSI, 7/16"x20 Thread	AMX10276	\$ 35.00
 Universal Equipment	Low Pressure Switch Normally Open, Opens at 6 PSI, Closes at 45 PSI, Standard 7/16"x20 Thread	AMX10277	\$ 55.00
 Universal Equipment	Low Pressure Switch Normally Open, Opens at 35 PSI, Closes at 46 PSI, Standard 7/16"x20 Thread	AMX10278	\$ 42.00
 White®: 2-85, 2-105, 2-135, 2-155, 2-180, 4-150, 4-175, 4-180, 4-210 Replaces 30-3224724, 30-3127680	Receiver Drier 3" x 6" Male Flare, R12 and R134a Compatible	AMX10211	\$ 22.00
 White®: 2-85 ASN 295302, 2-88, 4-225, 4-270, 100, 120, 125, 140, 145, 160, 170, 185, 195, (6175, 6195 BSN 681000) Replaces 30-3347710, 72160880	Receiver Drier 3" x 8 1/4" Male Flare, Female Switch Port - OE Parker, R12 and R134a Compatible	AM72161835	\$ 30.00
 White®: 6410, 6510, 6710, 6810, 8310, 8410, 8510, 8610, 8710, 8810	Receiver Drier 3" x 9" Male O-Ring, R12 and R134a Compatible	AM3712495M1	\$ 26.00
 White®: 2-85, 2-105, 2-110, (2-135, 2-155 BSN 400417), 2-150, 2-180	Expansion Valve Bulb Type, Externally Equalized, R12 and R134a Compatible, 12" Tube Length, Flare Connection	AMX10153	\$ 25.00
 White®: (2-135, 2-155 ASN 400418) Replaces 30-3432211, 106-5121, 4379-RD5-6868-0, 60012-5011	Expansion Valve Block Type, R12 and R134a Compatible, O-Ring Connection	AMX10151	\$ 24.00
 White®: 2-85, 2-88, 2-105, 2-135, 2-150, 2-155, 2-180, 4-105, 4-110, 4-175, 4-180, 4-210, 4-225, 4-270, 60 Series, 80 Series, 100, 120, 125, 140, 145, 160, 170, 185, 195, 6215	Adapter Kit Rotolock to O-Ring or Flare Service Valve	AMX10204	\$ 32.00
 White®: 120	Service Valve Kit R134a Tube O-Ring to O-Ring or Flare Fitting Insert Flare Adapters for Flare Applications	AMX10202	\$ 35.00
 White®: 2-85 ASN 265928, 2-88, 2-105 SN 255216-257898, 2-110, 2-135, 2-150, 2-155, 2-180, 160, 170, 185, 195 Replaces 30-3178684	Blower Motor 3-Speed, Double Shaft, 4-Wire, Reversible, 3/8" Shaft Diameter, 4 1/4" Long	AMX10120	\$ 80.00
 White®: 4-150, 4-175 Replaces 30-3133842	Blower Motor 12 Volt, Single Speed, Single Shaft, 2-Wire, Reversible, 5/16" Shaft Diameter, 1 1/2" Long	AMX10104	\$ 60.00
 White® Tractor: 4-180 Ref# 30-3378543	Blower Motor Single Speed, Single Shaft, 2-Wire, Reversible, 5/16" Shaft Diameter, 1 1/2" Long	AMX10107	\$ 42.00
 White®: 6710, 6810, 8310, 8410, 8510, 8610, 8710, 8810	Blower Motor w/ Wheels 12 Volt, 2-Wire, 5/16" Shaft Diameter	AM3310831M91	\$ 110.00

White® / Oliver® / M&M®—Tractor

White® / Oliver® / M&M®—Tractor

Application	Description	Part Number	Retail Price
 White®: 6124, 6125, 6144, 6145, 6175, 6195, 6215	Blower Motor Switch, 3-Speed	AM271105M1	\$ 6.50
 White®: 2-85 (ASN 277182), 2-105 (ASN 276762), 2-88, 2-110, 2-135, 2-155, 2-180, 4-175, 4-210, 4-225, 4-270, 60 & 80 Series, 100, 120, 125, 140, 145, 160, 170, 185, 195, 6125 (BSN 622000), 6145 (BSN 642000), 6175 (BSN 661000), 6195 (BSN 681000)	Condenser Overall: 28 1/8" x 12" Core: 19" x 12" x 1 7/8"	AM72503630	\$ 260.00

Shop Manuals and Collections

I&T Shop Service Manuals provide the information you need to service virtually any make or model of wheel-type farm tractor. Easy-to-follow procedures, detailed illustrations and comprehensive specifications help guide you through complete tractor maintenance and repair with accuracy and efficiency.



Application	Description	Part Number	Retail Price
Oliver® Series: 2050, 2150, Cockshutt® Series: 2050	Oliver® and Cockshutt®	IT-O-22	\$ 31.00
Models: 99 (6 CYL.) 4-Speed, Super 99 (6 Cyl.) 6-Speed, Super 99 GM (3-Cyl.), 6-Speed, Super & Non-Super 66, 77, 88, 660, 770, 880, Series: 99 GMTC, 950, 990, 995, MF98, Series: Super 55, 550	Oliver® & Cockshutt® Collection	IT-O-201	\$ 31.00
Oliver® & Cockshutt® Series: 1550, 1555, 1600, 1650, 1655, 1755, 1855, 1955, 2255, Series: 1750, 1800, 1850, 1900, 1950, 1950-T Minneapolis-Moline® Models: G955, G1355, Series: G550, G570	Oliver® & Cockshutt® Collection	IT-O-202	\$ 31.00

White® / Oliver® / M&M®—Tractor

White® / Oliver® / M&M®—Combine

Table of Contents

Air Conditioning and Components.....	1436	Cylinder Bars and Kits.....	1431
Belts—7600, 7800.....	1437	Cylinder Heads, Complete.....	1430
Belts—8600.....	1438	Elevator Chains.....	1431
Belts—8650.....	1439	Elevator Chain Sprockets.....	1431
Belts—8700, 8900.....	1440	Feederhouse Chains.....	1430
Belts—8800.....	1439	Final Drives and Components.....	1430
Belts—8920.....	1441	Hydrostats and Components.....	1430
Belts—9700.....	1442	Lighting.....	1432
Belts—9720.....	1443	Straw Chopper Blades and Components.....	1432
Concaves.....	1431		

Cylinder Heads, Complete

Application	Description	Part Number	Retail Price	Core
6125, 6145	Complete Cylinder Head 6-590, 6T-590, 6TA-590	AMJ917287WV	\$ 750.00	

Hydrostats and Components

Our hydrostats are remanufactured by a remanufacturing facility recognized by Sauer/Sundstrand. All units are assembled by a factory-trained technician, using genuine new and remanufactured replacement parts. All units are fully tested to factory specifications for maximum performance.

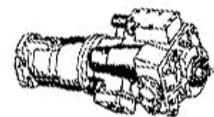

Application	Description	Part Number	Retail Price	Core
8600	Reman Hydrostat, Sundstrand	H8600S	\$ 3350.00	\$ 500.00
9700	Reman Hydrostat, Sundstrand	H9700S-24/24	\$ 4950.00	\$ 900.00

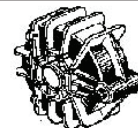

Final Drives and Components

Application	Description	Part Number	Retail Price	Core
White®: 7600, 7800, 8600, 8700, 8800, 8900, 8920	Pinion Shaft 15 Tooth	AMW1500030	\$ 485.99	

Feederhouse Chains

Our feederhouse chains utilize high-quality materials to meet or exceed OEM specifications. Slats are mounted using 3/8" grade 5 plated bolts and locknuts for easy replacement. Chains feature full side plates and high-strength steel for added durability. All feederhouse chains come with serrated slats unless otherwise noted. Call for different slats and chain configurations available to fit your application.



Application	Description	Part Number	Retail Price	Core
7600, 8600, 8700	Feederhouse Chain 90 links - Serrated slats every 2nd link 3 Chain Assembly	AM31-1779723L	\$ 744.94	
9700, 9720	Feederhouse Chain 96 links - Serrated slats every 4th link 3 Chain Assembly, CA-557	AM31-2606273L	\$ 1068.31	

White® / Oliver® / M&M®—Combine



Cylinder Bars and Kits

All bars are carefully checked and sets are matched for equal weight distribution on the cylinder prior to shipment. Grade 8 fasteners are supplied for most models.

Application	Description	Part Number	Retail Price	Core
9700, 9720	Cylinder Bar Kit 3 Bars w/ Mounting Fasteners	AM31-2497293	\$ 212.31	
9700, 9720	Cylinder Bar Kit 3 Bars w/ Mounting Fasteners	AM31-2497283	\$ 186.15	

Concaves

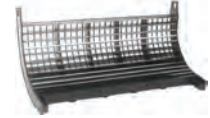

Application	Description	Part Number	Retail Price	Core
7800, 8800, 8900, 8920, 8950	Concave, Small Grain Wrap Around, Narrow Space	AM31-1812733	\$ 1458.83	

Elevator Chains

Elevator chains include rubber paddles attached with 5/16" plated bolts and nuts (unless noted in the individual description). Chains feature full side plates for added strength.



Application	Description	Part Number	Retail Price	Core
9700, 9720	Clean Grain Elevator Chain 146 links - 9 1/2" x 3 1/8" Rubber paddles every 4th link	AM2605873W91	\$ 475.03	
White®: 7600, 7800, 8600, 8700, 8800, 8900, 8920	Return Grain Elevator Chain 138 links - 5 5/8" x 3 1/8" paddles every 6th link	AM31-1666673L	\$ 315.97	
9700, 9720	Return Grain Elevator Chain 154 links - 5 5/8" x 3 1/8" Rubber paddles every 4th link	AM31-2605863L	\$ 397.07	

Elevator Chain Sprockets

To extend the life of your chain assemblies, always replace the sprockets when installing a new chain.



Application	Description	Part Number	Retail Price	Core
2500, 2600	Clean Grain Elevator Chain Sprocket, Upper 8 Tooth Sprocket w/o Hub	AM71373688	\$ 57.54	
7600, 7800, 8600, 8650, 8700, 8800, 8900, 8920	Clean Grain Elevator Chain Sprocket, Upper 8 Tooth, 1.125" Shaft	AM9863040W1	\$ 89.85	
9700, 9720	Clean Grain Elevator Chain Sprocket, Upper 11 Tooth, 1.25" Shaft	AM2412960W1	\$ 117.85	
2500, 2600	Clean Grain Elevator Chain Sprocket, Lower 8 Tooth Sprocket w/o Hub	AM71373688	\$ 57.54	
7600, 7800, 8600, 8650, 8700, 8900, 8920	Clean Grain Elevator Chain Sprocket, Lower 8 Tooth, 1.125" Shaft	AMW9863030	\$ 64.12	
9700, 9720	Clean Grain Elevator Chain Sprocket, Lower 11 Tooth, 1.25" Shaft	AM31-24163050	\$ 92.66	
2500, 2600	Return Grain Elevator Chain Sprocket, Upper 8 Tooth Sprocket w/o Hub	AM71373688	\$ 57.54	
7600, 7800, 8600, 8650, 8700, 8800, 8900, 8920	Return Grain Elevator Chain Sprocket, Upper 8 Tooth, 1.00" Shaft	AMW9863070	\$ 104.23	
9700, 9720, 8560, 8570	Return Grain Elevator Chain Sprocket, Upper 8 Tooth, 1.125" Shaft	AM9863040W1	\$ 89.85	
2500, 2600	Return Grain Elevator Chain Sprocket, Lower 8 Tooth Sprocket w/o Hub	AM71373688	\$ 57.54	
7600, 7800, 8600, 8650, 8700, 8800, 8900, 8920	Return Grain Elevator Chain Sprocket, Lower 8 Tooth, 1.00" Shaft	AMW9863700	\$ 42.36	

White® / Oliver® / M&M®—Combine

Application	Description	Part Number	Retail Price	Core
9700, 9720, 8560, 8570	Return Grain Elevator Chain Sprocket, Lower 8 Tooth, 1.125" Shaft	AMW9863030	\$ 64.12	









Straw Chopper Blades and Components







Hardened-steel chopper blades

Application	Description	Part Number	Retail Price	Core
8800, 8900, 9700	Straw Chopper Blade Kit Set of 3 w/ hardware	AM71310275	\$ 20.00	





Lighting

Application	Description	Part Number	Retail Price	Core
 Universal Equipment	LED Floodlight All-Position Light 4.25" x 4.25" Square Light 2650 Lumens, 48 Watts, 4 Amps For 12 Volt to 24 Volt Systems Includes Mounting Bracket and Stainless Steel Hardware	AMTL105F	\$ 95.00	
 Universal Equipment	LED Floodlight All-Position Light 6.25" x 1.75" Rectangle Light 1300 Lumens, 18 Watts, 1.50 Amps For 12 Volt to 24 Volt Systems Includes Mounting Bracket and Stainless Steel Hardware	AMTL118F	\$ 50.00	
 Universal Equipment	LED Floodlight All-Position Light 5" Round Light 3200 Lumens, 40 Watts, 3.30 Amps For 12 Volt to 24 Volt Systems Includes Mounting Bracket and Stainless Steel Hardware	AMTL180	\$ 89.00	
 Universal Equipment	LED Floodlight All-Position Light Round Light 6900 Lumens, 50 Watts, 4.10 Amps For 9 Volt to 32 Volt Systems Includes Mounting Bracket and Stainless Steel Hardware	AMTL500F	\$ 120.00	
 Universal Equipment	LED Floodlight All-Position Light 4.30" Round Light 5040 Lumens, 50 Watts, 4.10 Amps For 12 Volt to 24 Volt Systems Includes Stainless Steel Adjustable Mounting Bracket	AMAT305931	\$ 96.00	
 Universal Equipment	LED Floodlight All-Position Light 4.25" Round Light 2650 Lumens, 42 Watts, 3.50 Amps For 12 Volt to 24 Volt Systems Includes Mounting Bracket and Stainless Steel Hardware	AMTL115F	\$ 59.00	
Universal Equipment	LED Wide Floodlight All-Position Light 5" x 7" Rectangle Light 3800 Lumens, 35 Watts For 12 Volt to 24 Volt Systems	AMX34171	\$ 60.00	

White® / Oliver® / M&M®—Combine

Application	Description	Part Number	Retail Price	Core
 Universal Equipment	LED Floodlight, Sealed Beam Fender Mount 4.50" Diameter Round Light 1250 Lumens, 18 Watts, 1.50 Amps Trapezoid Pattern For 12 Volt to 24 Volt Systems	AMTL3010	\$ 40.00	
	LED Floodlight Fender Mount 4.50" Diameter Sealed Beam Round Light 1250 Lumens, 18 Watts, 1.20 Amps Trapezoid Pattern For 12 Volt to 24 Volt Systems Lasts 50 times longer than halogen lighting, vibration resistant w/ no filament failures, uses original mount and wiring. Operating temperature of -40°F to 140°F / -40°C to 60°C	AMRE336111	\$ 35.00	
 Universal Equipment	LED Floodlight Fender Mount 4.50" Diameter Sealed Beam Round Light 1440 Lumens, 18 Watts, 1.60 Amps Lasts 50 times longer than halogen lighting, vibration resistant w/ no filament failures, 2-terminal connection, Operating temperature of -40°F to 140°F / -40°C to 60°C	AMRE336112	\$ 67.75	
 Universal Equipment	LED Floodlight Cab and Fender Mount 3.50" x 6" Rectangle Light 3600 Lumens, 40 Watts, 3 Amps	AMX34146	\$ 65.00	
 Universal Equipment	LED Spotlight All-Position Light 4.25" x 4.25" Square Light 1400 Lumens, 27 Watts, 2.20 Amps For 12 Volt to 24 Volt Systems	AMTL100S	\$ 45.00	
 Universal Equipment	LED Spotlight All-Position Light 6.25" x 1.75" Rectangle Light 1300 Lumens, 18 Watts, 1.50 Amps For 12 Volt to 24 Volt Systems Includes Mounting Bracket and Stainless Steel Hardware	AMTL118S	\$ 50.00	
 Universal Equipment	LED Spotlight All-Position Light Round Light 6900 Lumens, 50 Watts, 4.10 Amps For 9 Volt to 32 Volt Systems Includes Mounting Bracket and Stainless Steel Hardware	AMTL500S	\$ 120.00	

White® / Oliver® / M&M®—Combine

Application	Description	Part Number	Retail Price	Core
 Universal Equipment	LED Trapezoid Light Cab and Fender Mount 4.50" Diameter Round Light 2800 Lumens, 40 Watts, 3.30 Amps Trapezoid Pattern For 12 Volt to 24 Volt Systems Bottom Mount w/ Built-In Heat Sink Includes Mounting Bracket, Long and Short Rubber Bezels and Stainless Steel Hardware	AMTL2080	\$ 95.00	
	LED Trapezoid Light Cab and Rear Fender Mount 4.50" Diameter Round Light 2800 Lumens, 40 Watts, 3.30 Amps Trapezoid Pattern For 12 Volt to 24 Volt Systems Bottom Mount w/ Built-In Heat Sink Includes Mounting Bracket, Long and Short Rubber Bezels and Stainless Steel Hardware	AMX33121	\$ 76.00	
 Universal Equipment	LED Warning Light Cab, Header or Swather Mount Can be used for Turn Signal, Brake or Running Lights 4.125" Diameter Round Light Double Sided, Amber Lenses 25 Bulbs per Side For 12 Volt to 24 Volt Systems	AMTLFL2	\$ 55.00	
	LED Warning Light Cab, Header or Swather Mount Can be used for Turn Signal, Brake or Running Lights 4.125" Diameter Round Light Double Sided, Amber Lenses 25 Bulbs per Side For 12 Volt to 24 Volt Systems	AMX1910149	\$ 44.00	
 Universal Equipment	LED Warning Light Cab, Header or Swather Mount Can be used for Turn Signal, Brake or Running Lights 4.125" Diameter Round Light Double Sided, Red and Amber Lenses 25 Bulbs per Side For 12 Volt to 24 Volt Systems	AMTLFL3	\$ 55.00	
	LED Warning Light Cab, Header or Swather Mount Can be used for Turn Signal, Brake or Running Lights 4.125" Diameter Round Light Double Sided, Red and Amber Lenses 25 Bulbs per Side For 12 Volt to 24 Volt Systems	AMX33126	\$ 44.00	
 Universal Equipment	LED Magnetic Warning Light All-Position Light 360° Flashing Light, Multiple Patterns 9.50" x 6.75" Rectangle Light Magnetic Base or Solid Mount For 12 Volt to 24 Volt Systems Includes Cigarette Lighter Adapter, Wiring and Switch	AMTL1100	\$ 170.00	
 Universal Equipment	LED Magnetic Warning Light All-Position Light 360° Flashing Light, Multiple Patterns 14" x 6.75" Rectangle Light Magnetic Base or Solid Mount For 12 Volt to 24 Volt Systems Includes Cigarette Lighter Adapter, Wiring and Switch	AMTL1200	\$ 190.00	
Universal Equipment	Warning Beacon 360° Flashing Beacon, Amber Lens For 0.9435" Diameter Pipe Replaces 84337818, AZ44705, AZ101891	AM82018390	\$ 45.64	

White® / Oliver® / M&M®—Combine





	Application	Description	Part Number	Retail Price	Core
	Universal Equipment	LED Warning Beacon 360° Flashing Beacon 2.75" x 5.25" Light Polycarbonate Amber Lens and Housing For 12 Volt to 24 Volt Systems Includes Solid Mounting Pad and Stainless Steel Hardware	AMTL2100	\$ 30.00	
	Universal Equipment	LED Warning Beacon 360° Flashing Beacon, 3 Different Patterns 5" x 10" Light Amber Lens, 48 Watts, 4 Amps For 12 Volt to 24 Volt Systems Brackets Sold Separately	AMX33131	\$ 75.00	
	Universal Equipment	Warning Beacon Bracket	AMX33132	\$ 15.00	
	Universal Equipment	Warning Beacon Bracket	AMX33133	\$ 15.00	
	Universal Equipment	Warning Beacon Bracket	AMX33137	\$ 15.00	
	Universal Equipment	Warning Beacon Bracket	AMX33135	\$ 15.00	
	Universal Equipment	LED Light Bar 4" Long, 1260 Lumens, Cree Bulbs	AMLED4	\$ 45.00	
		LED Light Bar Flood/Spotlight Combo 10" Long, 5700 Lumens, 50 Watts, 4.20 Amps For 12 Volt to 24 Volt Systems Includes Mounting Bracket and Stainless Steel Hardware	AMTL10SRC	\$ 129.00	
		LED Light Bar Floodlight/Spotlight Combo 14" Long, 5400 Lumens, 72 Watts, 6 Amps Die Cast Aluminum Housing, Polycarbonate Lens For 12 Volt to 24 Volt Systems Includes Mounting Bracket and Heavy Duty Stainless Hardware	AMTLB410C	\$ 150.00	
		LED Light Bar Floodlight/Spotlight Combo 30" Long, 13600 Lumens, 150 Watts, 12.50 Amps For 12 Volt to 24 Volt Systems Includes Mounting Bracket and Stainless Steel Hardware	AMTL30SRC	\$ 230.00	
		LED Light Bar 30" Long, 13860 Lumens, Cree Bulbs	AMLED30	\$ 130.00	
	LED Light Bar Floodlight/Spotlight Combo 40" Long, 17300 Lumens, 200 Watts, 16.70 Amps For 12 Volt to 24 Volt Systems Includes Mounting Brackets and Stainless Steel Hardware	AMTL40SRC	\$ 300.00		

Prices Subject to Change without Prior Notice. The use of original equipment manufacturer (OEM) part numbers or trademarks, e.g. Case® and John Deere®, are for reference purposes only and for indicating product use and compatibility. Our company and the listed replacement parts contained herein are not sponsored, approved or manufactured by the OEM. All parts are New unless designated Reman in the description.

White® / Oliver® / M&M®—Combine

Application	Description	Part Number	Retail Price	Core
Universal Equipment	LED Light Bar 40" Long, 18200 Lumens, Cree Bulbs	AMLED40	\$ 160.00	
	LED Light Bar Floodlight/Spotlight Combo 42" Long, 14500 Lumens, 240 Watts, 19 Amps For 12 Volt to 24 Volt Systems Includes Mounting Bracket and Stainless Steel Hardware Replaces 1163691	AMTLB440C	\$ 250.00	
	LED Light Bar, Curved 50" Long, 21500 Lumens, Cree Bulbs	AMLED50C	\$ 190.00	
Universal Equipment	LED Magnetic Work Light All-Position Light 3.25" Square Floodlight 900 Lumens Magnetic Base Includes Lithium Ion Battery, Cigarette Lighter and DC Charger	AMTL2460	\$ 79.00	

Air Conditioning and Components

Application	Description	Part Number	Retail Price
 2500, 2600, 7300, 7600, 7800, 8600, 8700, 8800, 8900, 8920, 9700, 9720 Replaces 30-3075699	Compressor, York Style Left Hand Suction, Rotolock Clutch Not Included Requires Synthetic Ester Oil 100V, See Manufacturer for Oil Quantity	AMX10225	\$ 260.00
	Double Groove Clutch for York Compressor, 7"	AM470	\$ 101.00
	Premium Synthetic Ester Oil, 100V, 12 oz	AMX10273	\$ 11.00
 Universal Equipment	High Pressure Switch Normally Open, Opens at 305 PSI, Closes at 395 PSI, 7/16"x20 Thread	AMX10276	\$ 35.00
 Universal Equipment	Low Pressure Switch Normally Open, Opens at 6 PSI, Closes at 45 PSI, Standard 7/16"x20 Thread	AMX10277	\$ 55.00
 Universal Equipment	Low Pressure Switch Normally Open, Opens at 35 PSI, Closes at 46 PSI, Standard 7/16"x20 Thread	AMX10278	\$ 42.00

White® / Oliver® / M&M®—Combine

Belts—7600, 7800

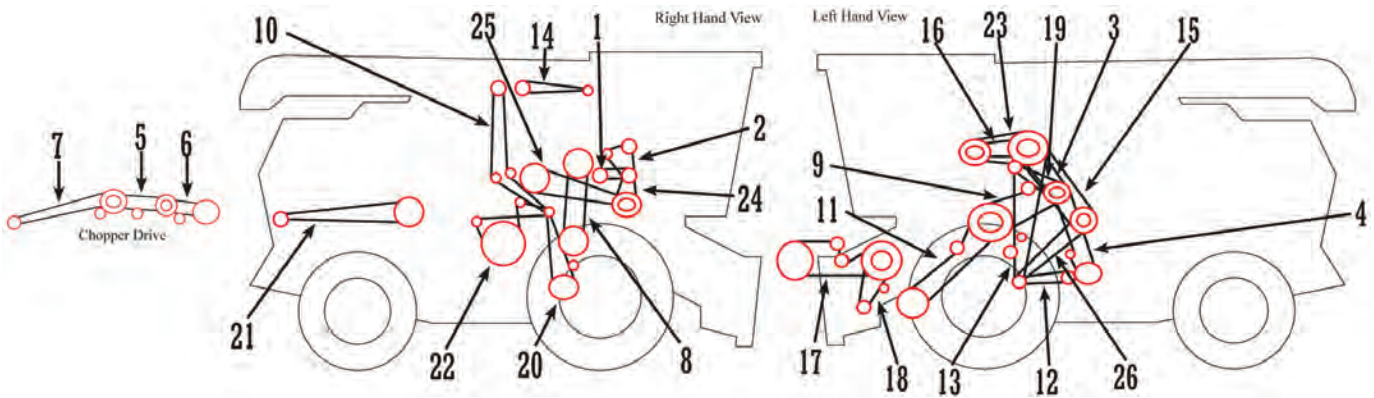

Application	Description	Part Number	Retail Price
1 7600, 7800	Air Compressor Drive	AM31-1607690	\$ 13.73
2 7600	Alternator & Fan Drive (Set of 2)	AM9811873	\$ 14.16
2 7800	Fan Drive (Set of 2)	AM31-1558890	\$ 7.50
2 7800	Alternator & Water Pump Drive	AM31-1558900	\$ 20.00
3 7600, 7800	Beater Drive	AM9811400	\$ 56.50
4 7600, 7800	Cleaning Fan Drive	AM9811480	\$ 26.11
5 7600, 7800	Crop Chopper Intermediate Drive	AM7532740	\$ 39.00
6 7600, 7800	Crop Chopper Primary Drive	AM7532730	\$ 29.00
7 7600, 7800	Crop Chopper Rear Drive	AM7531090	\$ 48.00
8 7600, 7800	Cylinder Drive, Vari-Speed	AM31-1587320	\$ 123.66
9 7600, 7800	Feeder Shaft Drive, Top	AM31-1587320	\$ 123.66
10 7600, 7800 ASN 30101	Grain Elevator Drive	AM31-1602420	\$ 41.18
10 7800 BSN 30101	Grain Elevator Drive	AM9811470	\$ 84.00
11 7600, 7800	Header Countershaft Drive	AM31-1594230	\$ 130.44
12 7600, 7800 ASN 40101	Hydro Charger Pump	AM31-1567430	\$ 10.75
13 7600	Hydrostatic Drive	AM9811840	\$ 153.00
13 7800	Hydrostatic Drive	AM31-1564110	\$ 145.00
14 7600	Leveling Auger Drive	AM31-1563120	\$ 29.00
14 7800	Leveling Auger Drive	AM9811800	\$ 31.00
15 7600, 7800	Mechanical Drive	AM31-1566290	\$ 60.46
16 7600, 7800	Propulsion Drive	AM9811830W2	\$ 72.46
17 7600, 7800	Reel Final Belt Drive	AM9810030	\$ 41.50
17 7600, 7800	Reel Belt Drive, Vari-Speed	AM403408D	\$ 35.81
18 7600, 7800	Reel Primary Belt Drive	AM9811000	\$ 9.00
19 7600, 7800	Return Elevator Drive	AM9811490	\$ 17.06
20 7600, 7800	Shoe Pitman Drive	AM9811450	\$ 33.13
21 7800	Straw Spreader Drive	AM9811790	\$ 50.00
22 7600, 7800	Straw Walker Drive	AM9811710	\$ 40.81
23 7600, 7800	Thresher Drive (Declutch)	AM9811400	\$ 56.50
24 7600 BSN 23141	Unloader Countershaft Drive	AM9811420	\$ 44.00
24 7600 ASN 23141, 7800	Unloader Countershaft Drive	AM31-1558170	\$ 50.00
25 7600, 7800	Unloader Auger Drive	AM9811430	\$ 131.00
26 7600, 7800	Mechanical Drive, Vari-Speed (OPT)	AM9811820	\$ 224.97

White® / Oliver® / M&M®—Combine

Belts—8600

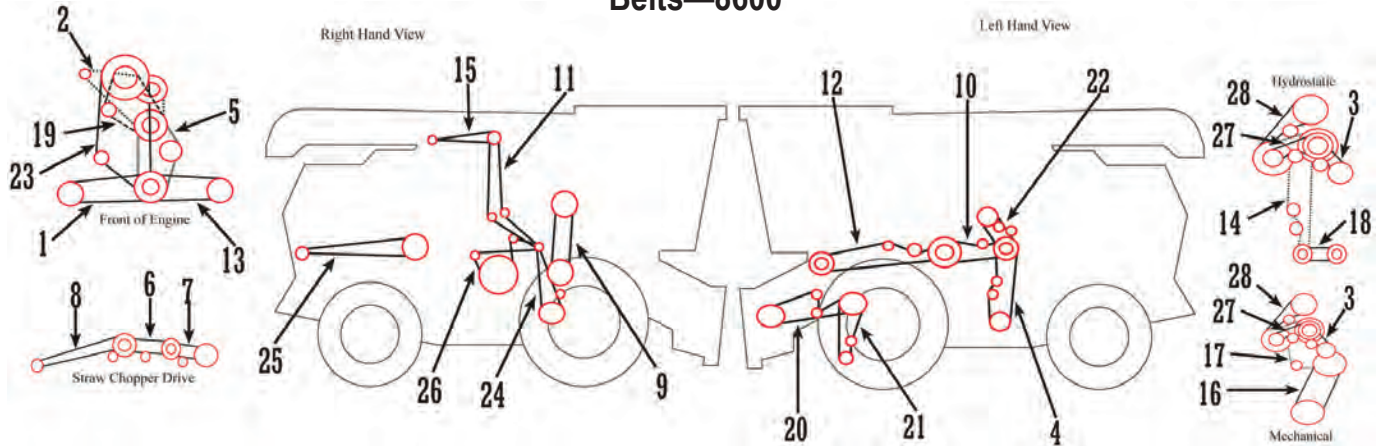

Application	Description	Part Number	Retail Price
1 8600 ASN 40701	A/C Compressor Drive	AM31-1679590	\$ 8.81
2 8600 ASN 40701	Alternator & Water Pump Drive (400 Gas)	AM31-1558900	\$ 20.00
2 8600 ASN 40701	Alternator & Water Pump Drive (Diesel)	AM31-1774180	\$ 11.90
3 8600 ASN 40701	Beater Drive	AM31-1669570	\$ 83.52
4 8600	Cleaning Fan Drive	AM9811480	\$ 26.11
5 8600 ASN 40701	Countershaft Drive (Set of 2)	AM31-1677220	\$ 15.63
6 8600	Crop Chopper Intermediate Drive	AM7532740	\$ 39.00
7 8600	Crop Chopper Primary Drive	AM7532730	\$ 29.00
8 8600	Crop Chopper Rear Drive	AM7531090	\$ 48.00
9 8600 ASN 40701	Cylinder Drive, Vari-Speed	AM31-1669580	\$ 170.00
10 8600	Feeder Shaft Drive, Top 3V Belt	AM1594240W1	\$ 140.00
11 8600	Grain Elevator Drive	AM31-1602420	\$ 41.18
12 8600	Header Countershaft Drive	AM31-1594230	\$ 130.44
13 8600 BSN 62000	Hydraulic Pump Drive	AM31-1681440	\$ 5.92
13 8600 ASN 62001	Hydraulic Pump Drive	AM31-1710550	\$ 11.20
14 8600 ASN 40701	Hydrostatic Propulsion Drive	AM31-1669610	\$ 145.00
15 8600	Leveling Auger Drive	AM31-1680730	\$ 49.00
16 8600	Mechanical Propulsion Drive	AM9811820	\$ 224.97
17 8600 ASN 40701	Mechanical Propulsion Drive	AM31-1679050	\$ 105.59
18 8600	Pump Drive Belt (Hydro)	AM31-1567430	\$ 10.75
19 8600 ASN 40701	Radiator Fan Drive (Set of 2)	AM31-1677150	\$ 14.12
20 8600	Reel Final Drive, Vari-Speed	AM9810030	\$ 41.50
21 8600	Reel Primary Drive	AM9811000	\$ 9.00
22 8600	Return Elevator Drive	AM9811490	\$ 17.06
23 8600 ASN 40701	Rotary Screen Drive	AM31-1764410	\$ 17.06
24 8600	Shoe Pitman Drive	AM9811450	\$ 33.13
25 8600	Straw Spreader Drive	AM9811790	\$ 50.00
26 8600	Straw Walker Drive	AM9811710	\$ 40.81
27 8600 ASN 40701	Thresher Declutch Drive	AM31-1669790	\$ 99.07
28 8600 ASN 40701	Unloader Declutch Drive	AM31-1669560	\$ 33.61

White® / Oliver® / M&M®—Combine

Belts—8650

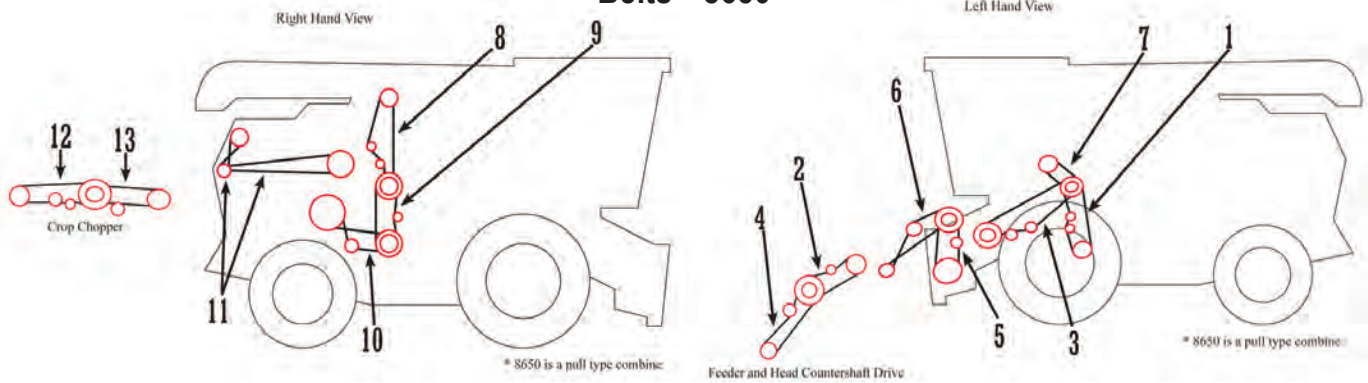

Application	Description	Part Number	Retail Price
1 8650	Cleaning Fan Drive	AM9811480	\$ 26.11
2 8650	Feeder Shaft Drive, Top	AM31-1744280	\$ 31.35
3 8650	Main Drive	AM31-1730570	\$ 182.50
7 8650	Return Elevator	AM9811490	\$ 17.06
9 8650	Shoe Pitman Drive	AM9811450	\$ 33.13
10 8650	Straw Walker	AM31-1730590	\$ 22.81
12 8650	Crop Chopper, Rear (OPT)	AM31-7535030	\$ 74.25
13 8650	Crop Chopper, Front (OPT)	AM31-7535040	\$ 45.50

Belts—8800

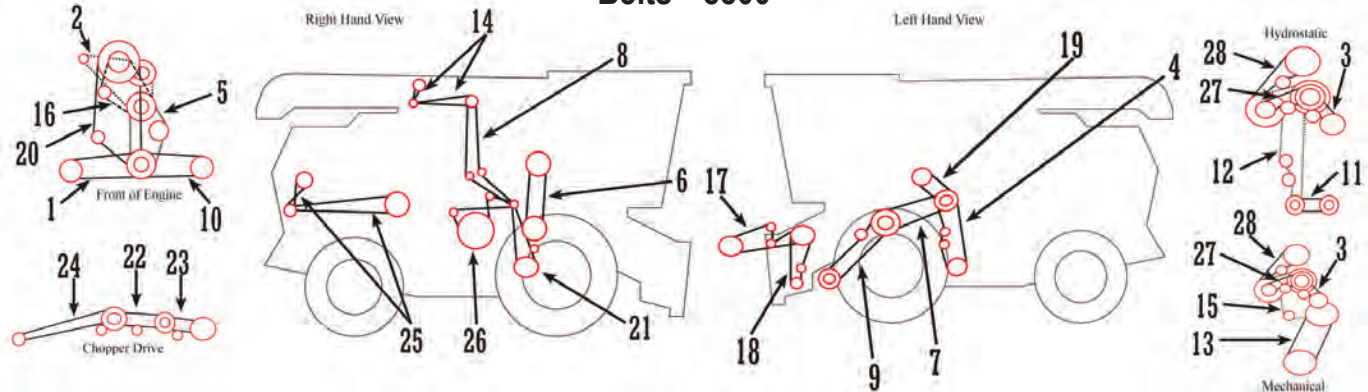

Application	Description	Part Number	Retail Price
1 8800 S/N 35101	A/C Compressor Drive	AM31-1679590	\$ 8.81
2 8800 S/N 35101	Alternator & Water Pump Drive (318 Gas)	AM31-1683780	\$ 4.25
2 8800 S/N 35101	Alternator & Water Pump Drive (354 Diesel)	AM31-1774180	\$ 11.90
3 8800 S/N 35101	Beater Drive	AM31-1669570	\$ 83.52
4 8800	Cleaning Fan Drive	AM9811480	\$ 26.11
5 8800 S/N 35101	Countershaft Drive	AM31-1677220	\$ 15.63
6 8800 S/N 35101	Cylinder Belt Drive, Vari-Speed	AM31-1669580	\$ 170.00
7 8800	Feeder Shaft Drive, Top 3V Belt	AM1594240W1	\$ 140.00
8 8800	Grain Elevator Drive	AM31-1602420	\$ 41.18
9 8800	Header Countershaft Drive	AM31-1594230	\$ 130.44
10 8800 S/N 35101	Hydraulic Pump Drive	AM31-1681440	\$ 5.92
11 8800	Hydro Pump Drive	AM31-1567430	\$ 10.75
12 8800 S/N 35101	Hydrostatic Propulsion Drive	AM31-1669620	\$ 126.00

White® / Oliver® / M&M®—Combine

Prices Subject to Change without Prior Notice. The use of original equipment manufacturer (OEM) part numbers or trademarks, e.g. Case® and John Deere®, are for reference purposes only and for indicating product use and compatibility. Our company and the listed replacement parts contained herein are not sponsored, approved or manufactured by the OEM. All parts are New unless designated Reman in the description.

White® / Oliver® / M&M®—Combine

Application	Description	Part Number	Retail Price
13 8800	Hydrostatic Propulsion Drive, Vari-Speed	AM9811820	\$ 224.97
14 8800	Leveling Auger Drive	AM1680230W1	\$ 62.00
15 8800 S/N 35101	Mechanical Propulsion Drive	AM31-1679050	\$ 105.59
16 8800 S/N 35101	Radiator Fan Drive	AM31-1677150	\$ 14.12
17 8800	Reel Final Drive	AM9810030	\$ 41.50
17 8800	Reel Final Drive, Vari-Speed	AM403408D	\$ 35.81
18 8800	Reel Primary Drive	AM9811000	\$ 9.00
19 8800	Return Elevator Drive	AM9811490	\$ 17.06
20 8800 S/N 35101	Rotary Screen Drive	AM31-1764410	\$ 17.06
21 8800	Shoe Pitman Drive	AM9811450	\$ 33.13
22 8800	Straw Chopper, Intermediate	AM7532740	\$ 39.00
23 8800	Straw Chopper, Primary	AM7532730	\$ 29.00
24 8800	Straw Chopper, Rear	AM7531090	\$ 48.00
25 8800	Straw Spreader Drive	AM9811790	\$ 50.00
26 8800	Straw Walker Drive	AM9811710	\$ 40.81
27 8800 S/N 35101	Thresher Declutch Drive	AM31-1669790	\$ 99.07
28 8800 S/N 35101	Unloader Declutch Drive	AM31-1669560	\$ 33.61

Belts—8700, 8900

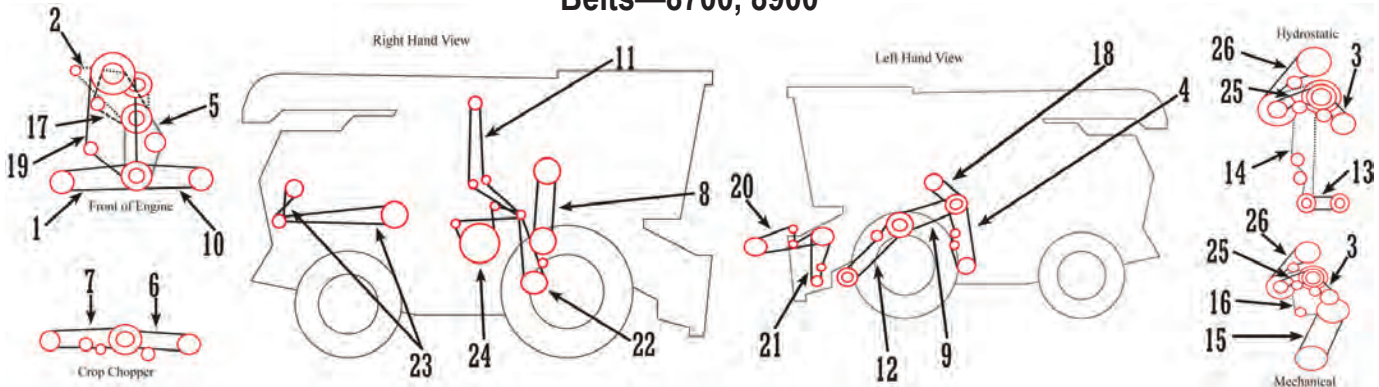

Application	Description	Part Number	Retail Price
1 8700, 8900	Air Conditioning Compressor Drive	AM31-1679590	\$ 8.81
2 8700, 8900	Alternator & Water Pump Drive (354 Dsl Engine)	AM31-1774180	\$ 11.90
3 8700, 8900	Beater Drive	AM31-1669570	\$ 83.52
4 8700, 8900	Cleaning Fan Drive (Standard Speed)	AM9811480	\$ 26.11
4 8700, 8900	Cleaning Fan Drive (Slow Speed)	AM31-1567900	\$ 22.25
5 8700, 8900 ASN 21101	Countershaft Drive, Hyd Pump and A/C	AM31-1803500	\$ 26.91
5 8900 BSN 21100	Countershaft Drive, Hyd Pump and A/C	AM31-1677220	\$ 15.63
6 8700, 8900	Crop Chopper, Primary	AM31-7535040	\$ 45.50
7 8700, 8900	Crop Chopper, Rear	AM31-7535030	\$ 74.25
8 8700, 8900	Cylinder Drive, Vari-Speed (OPT)	AM31-1669580	\$ 170.00
9 8700, 8900	Feeder Shaft Drive, Top 3V Belt	AM1594240W1	\$ 140.00
10 8700, 8900	Hydraulic Pump Drive	AM31-1710550	\$ 11.20
11 8700, 8900	Grain Elevator Drive	AM31-1781280	\$ 63.09
12 8700 BSN 34701	Head Countershaft Drive, Grain	AM31-1779580	\$ 80.00
12 8700 ASN 34701, 8900	Header Countershaft Drive	AM31-1594230	\$ 130.44

White® / Oliver® / M&M®—Combine

Application	Description	Part Number	Retail Price
12 8700, 8900	Long Rice Feeder Belt	AM31-1695680	\$ 151.73
13 8700, 8900	Hydro Pump Drive	AM31-1567430	\$ 10.75
14 8700	Hydrostatic Propulsion Drive (OPT)	AM31-1669620	\$ 126.00
14 8900	Hydrostatic Propulsion Drive (OPT)	AM31-1669610	\$ 145.00
15 8700, 8900	Mechanical Propulsion Drive, VS (OPT)	AM9811820	\$ 224.97
16 8700, 8900	Mechanical Propulsion Drive (OPT)	AM31-1679050	\$ 105.59
17 8700, 8900	Radiator Fan Drive	AM31-1677150	\$ 14.12
18 8700, 8900	Return Elevator Drive	AM9811490	\$ 17.06
19 8700, 8900	Rotary Screen Drive	AM31-1764410	\$ 17.06
20 8700, 8900	Reel Final Drive	AM9810030	\$ 41.50
20 8700, 8900	Reel Final Drive, Vari-Speed	AM403408D	\$ 35.81
21 8700, 8900	Reel Primary Drive	AM9811000	\$ 9.00
22 8700, 8900	Shoe Pitman Drive	AM9811450	\$ 33.13
23 8900	Straw Spreader Drive	AM9811790	\$ 50.00
24 8700, 8900	Straw Walker Drive	AM9811710	\$ 40.81
25 8700	Thresher Declutch Drive	AM31-1779320	\$ 83.73
25 8900	Thresher Declutch Drive	AM31-1669790	\$ 99.07
26 8700, 8900	Unloader Declutch Drive	AM31-1732180	\$ 78.00

Belts—8920

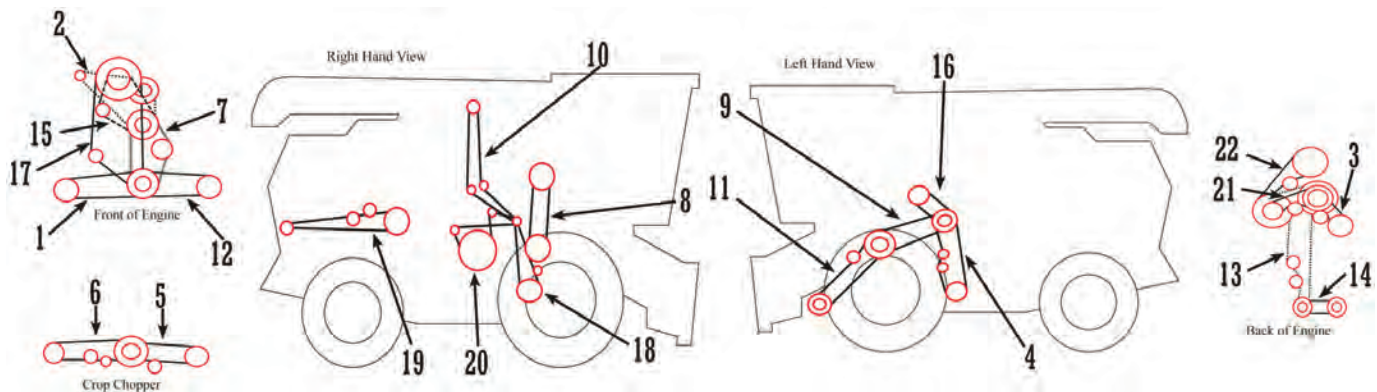

Application	Description	Part Number	Retail Price
1 8920	A/C Compressor Drive	AM31-1679590	\$ 8.81
2 8920	Alternator & Water Pump Drive	AM31-1774180	\$ 11.90
3 8920	Beater Drive	AM31-1669570	\$ 83.52
4 8920	Cleaning Fan Drive (Standard Speed)	AM9811480	\$ 26.11
4 8920	Cleaning Fan Drive (Slow Speed)	AM31-1567900	\$ 22.25
6 8920	Crop Chopper, Primary	AM31-7535040	\$ 45.50
6 8920	Crop Chopper, Rear	AM31-7535030	\$ 74.25
7 8920	Countershaft Drive, Hyd Pump and A/C	AM31-1803500	\$ 26.91
8 8920	Cylinder Drive, Vari-Speed	AM31-1669580	\$ 170.00
9 8920	Feeder Shaft Drive, Top 3V Belt	AM1594240W1	\$ 140.00
10 8920	Grain Elevator Drive	AM31-1781280	\$ 63.09
11 8920	Head Countershaft Drive	AM31-1695680	\$ 151.73
12 8920	Hydraulic Pump Drive	AM31-1710550	\$ 11.20

White® / Oliver® / M&M®—Combine

White® / Oliver® / M&M®—Combine

Application	Description	Part Number	Retail Price
13 8920	Hydrostatic Propulsion Drive	AM31-1669610	\$ 145.00
14 8920	Pump Drive	AM31-1567430	\$ 10.75
15 8920	Radiator Fan Drive	AM31-1677150	\$ 14.12
16 8920	Return Elevator Drive	AM9811490	\$ 17.06
17 8920	Rotary Screen Drive	AM31-1764410	\$ 17.06
18 8920	Shoe Pitman Drive	AM9811450	\$ 33.13
19 8920	Straw Spreader Drive	AM31-1831290	\$ 35.75
20 8920	Straw Walker Drive	AM9811710	\$ 40.81
21 8920	Thresher Declutch Drive	AM31-1669790	\$ 99.07
22 8920	Unloader Declutch Drive	AM31-1732180	\$ 78.00

Belts—9700

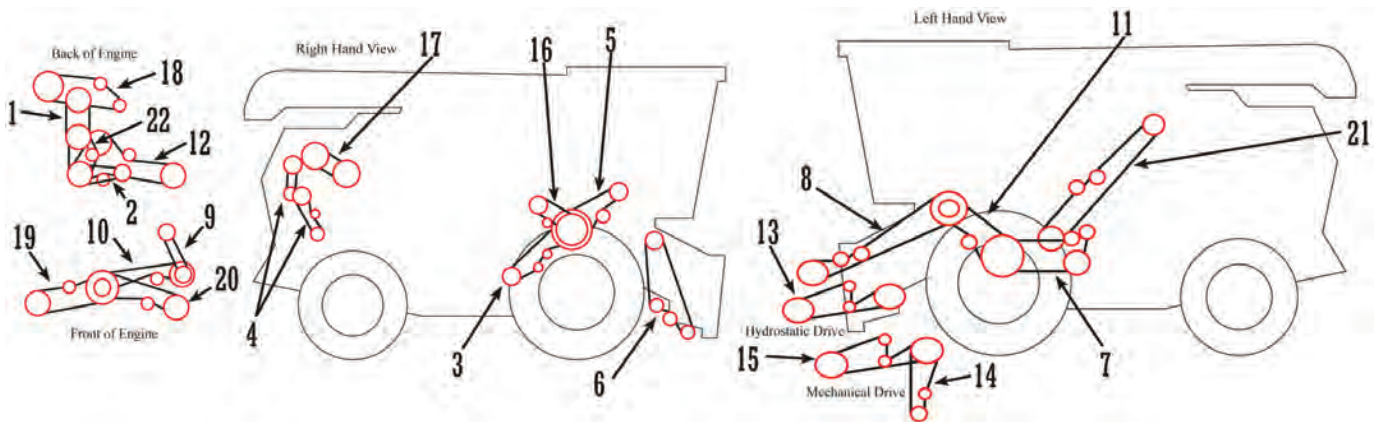

Application	Description	Part Number	Retail Price
1 9700	Air Conditioner Compressor Drive	AM2498110W1	\$ 5.60
2 9700	Alternator Drive	AM31-2403270	\$ 4.25
3 9700	Cleaning Fan Drive Replaces 31-2439720	AM2439720W1	\$ 65.22
4 9700 ASN 20101	Crop Chopper Drive, 77.7"	AM31-2553480	\$ 35.47
4 9700 BSN 30100	Crop Chopper Drive, 76"	AM31-2456600	\$ 15.00
5 9700	Feed Impeller Drive 3V Belt	AM1594240W1	\$ 140.00
7 9700	Grain Elevator Drive, Primary	AM2439700W1	\$ 49.70
8 9700	Head Countershaft Drive	AM2523670W1	\$ 167.00
9 9700	Hydraulic Pump Drive	AM31-2549250	\$ 12.17
10 9700	Hydrostatic Pump Drive	AM31-2449520	\$ 88.59
11 9700	Pitman Drive	AM2439710W1	\$ 69.52
12 9700	Radiator Fan & Countershaft Drive	AM31-2449290	\$ 42.04
13 9700	Reel Final Drive (Hydro)	AM9810440	Call for Price
14 9700	Reel Final Drive (Mech)	AM9810030	\$ 41.50
15 9700	Reel Primary Drive (Mech)	AM9811000	\$ 9.00
16 9700	Return Elevator Drive	AM31-2492070	\$ 27.75
17 9700	Rotor Drive	AM2445370W1	\$ 177.18
18 9700	Rotary Screen Drive	AM31-2448930	\$ 18.19
19 9700	Thresher Drive	AM2404170W1	\$ 137.00
20 9700	Unloader Drive, Primary	AM31-2553810	\$ 93.83

White® / Oliver® / M&M®—Combine

Application	Description	Part Number	Retail Price
21 9700	Unloader Drive, Secondary	AM2496110W1	\$ 98.00
22 9700	Water Pump Drive	AM31-2414670	\$ 7.70

Belts—9720

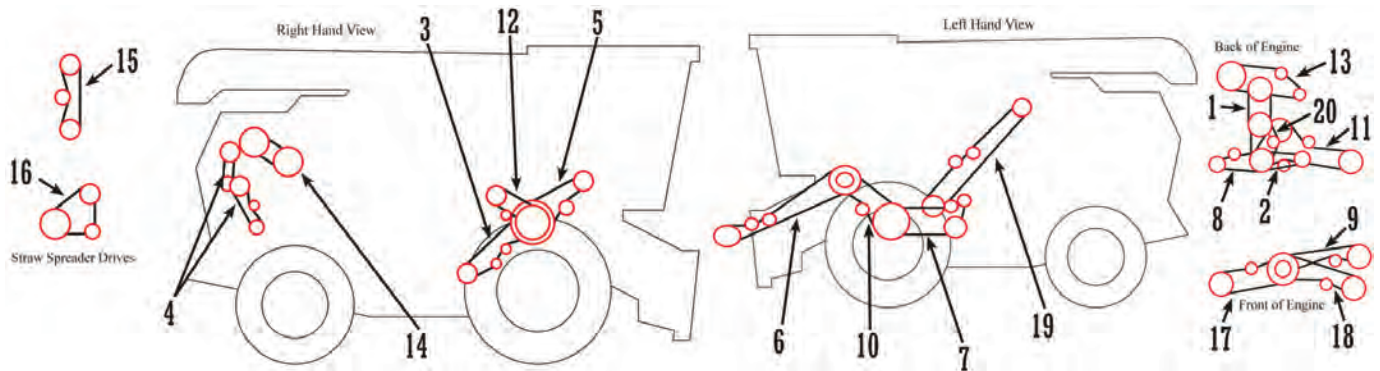

Application	Description	Part Number	Retail Price
1 9720	A/C Compressor Drive	AM2498110W1	\$ 5.60
2 9720	Alternator Drive	AM31-2403270	\$ 4.25
3 9720	Cleaning Fan Drive Replaces 31-2439720	AM2439720W1	\$ 65.22
4 9720	Crop Chopper Drive	AM31-2553480	\$ 35.47
5 9720	Feed Impeller Drive 3V Belt	AM1594240W1	\$ 140.00
6 9720	Head Countershaft Drive	AM2523670W1	\$ 167.00
7 9720	Grain Elevator Drive, Primary	AM2439700W1	\$ 49.70
8 9720	Hydraulic Pump Drive Set of 2	AM31-2604010	\$ 41.25
9 9720	Hydrostatic Pump Drive	AM31-2449520	\$ 88.59
10 9720	Pitman Drive	AM2439710W1	\$ 69.52
11 9720	Radiator Fan & Countershaft Drive	AM31-2449290	\$ 42.04
12 9720	Return Elevator Drive	AM31-2492070	\$ 27.75
13 9720	Rotary Screen Drive	AM31-2448930	\$ 18.19
14 9720	Rotor Drive	AM2445370W1	\$ 177.18
15 9720	Straw Spreader, Primary	AM2543960W1	\$ 17.64
16 9720	Straw Spreader, Secondary	AM2543970W1	\$ 15.60
17 9720	Thresher Drive	AM2404170W1	\$ 137.00
18 9720	Unloader Primary Drive	AM2605020W1	\$ 83.40
19 9720	Unloader Drive, Secondary	AM2496110W1	\$ 98.00
20 9720	Water Pump Drive	AM31-2414670	\$ 7.70

White® / Oliver® / M&M®—Combine

Lexion®—Combine

Table of Contents

Belts—405, 410, 465	1444	Belts—480	1448
Belts—415, 430, 440, 460	1445	Belts—580R, 585R.....	1449
Belts—470, 475, 485	1446	Cornhead—Stalk Stompers and Components	1444

Lexion®—Combine

Cornhead—Stalk Stompers and Components

Application	Description	Part Number	Retail Price
Most Models	Stalk Stomper Kit, 2 Row Covers 1 Row on Each side of Cornhead	AMX31087	\$ 1200.00
	Stalk Stomper Kit, 4 Row Covers 2 Rows on Each side of Cornhead	AMX31067	\$ 1600.00
	Stalk Stomper Kit, 6 Row Covers 3 Rows on Each side of Cornhead	AMX31068	\$ 2225.00
	Stalk Stomper Kit, 8 Row Covers 4 Rows on Each side of Cornhead	AMX31066	\$ 2775.00
	Stalk Stomper Kit, 12 Row Covers 6 Rows on Each side of Cornhead	AMX31069	\$ 3550.00
	Stalk Stomper Kit, 16 Row Covers 8 Rows on Each side of Cornhead	AMX31070	\$ 4125.00
	Header Mounting Bracket Accommodates 2" x 2" Square Toolbar	AMX30027	\$ 120.00

Belts—405, 410, 465

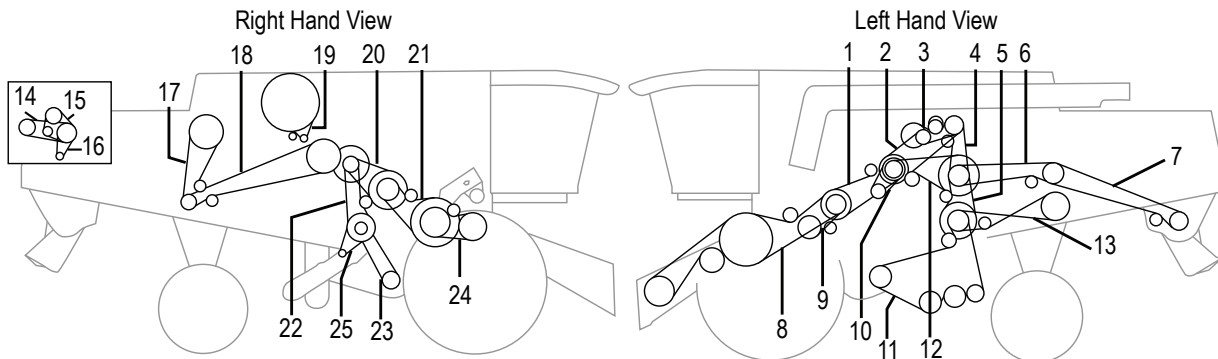

Application	Description	Part Number	Retail Price
1 465	Header Drive, 1 Stage	AM667255	\$ 107.00
2 465	Threshing Mechanism	AM667453	\$ 336.69
3 465	Grain Tank Unloading	AM667250	\$ 91.11
4 465	Straw Chopper, 1 Stage	AM667958	\$ 102.84
5 405, 410, 465	Cleaning, 2 Stage	AM667252	\$ 112.00
6 405, 410	Straw Chopper, 2 Stage	AM667683	\$ 55.25
6 465	Straw Chopper, 2 Stage	AM061700	\$ 107.49
6 465	Straw Chopper, 2 Stage	AM749712	\$ 150.39
7 465	Straw Chopper, 3 Stage	AM749828	\$ 183.47
7 465	Straw Chopper, 3 Stage	AM350462	\$ 122.94
8 405, 410, 465	Header Drive, 2 Stage	AM667454	\$ 93.19

Lexion®—Combine

Application	Description	Part Number	Retail Price
9 405, 410, 465	Header Drive, 3 Stage	AM667249	\$ 94.09
10 405, 410, 465	Impeller Drum	AM758719	\$ 14.49
11 405, 410	Header, Variable Speed	AM667651	\$ 158.93
11 465	Header, Variable Speed	AM667530	\$ 137.71
12 405, 410, 465	Straw Spreader	AM644209	\$ 43.19
13 405, 410, 465	Cleaning, 3 Stage	AM667477	\$ 55.08
14 405, 410	V-Belt	AM667560	\$ 12.35
15 405, 410, 465	Fan & Rotary Screen	AM667242	\$ 11.03
16 465	Rotary Screen, Stage 1	AM667456	\$ 10.78
17 405, 410, 465	Agitator Tines, Rear	AM667973	\$ 29.86
18 405, 410, 465	Agitator Tines, Front	AM667974	\$ 48.95
19 405, 410, 465	Rotary Screen, 2 Stage	AM667561	\$ 23.79
20 465	Threshing Drum, Variable Speed	AM667248	\$ 520.94
21 405, 410	Threshing Drum	AM644902	\$ 138.97
21 465 ASN 55700462	Threshing Drum	AM176442	\$ 228.13
21 465 BSN 55700461	Threshing Drum	AM667458	\$ 130.00
22 405, 410	Fan Drive, Stage 1	AM667957	\$ 31.59
22 465	Fan Drive, Stage 1	AM742026	\$ 21.49
23 405, 410, 465	Fan, Variable Speed	AM667457	\$ 69.91
24 405, 410, 465	Accelerator	AM667251	\$ 108.65
25 465	Suction Blower	AM644781	\$ 10.82
NI 465	Hydraulic Reel Drive	AM829094	\$ 15.00
NI 465	Hydraulic Reel Drive	AM055292	\$ 16.20
NI 465	Straw Spreader Drive	AM539443	\$ 465.30

Belts—415, 430, 440, 460

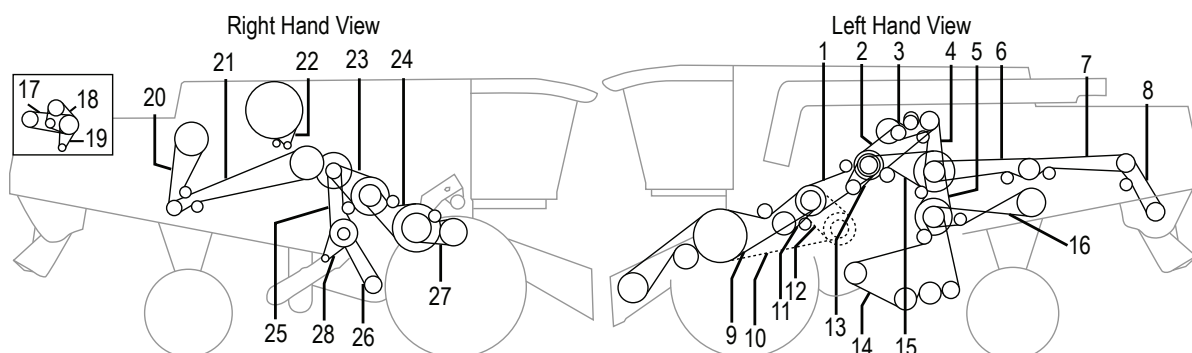

Application	Description	Part Number	Retail Price
1 415, 430, 440, 460	Header Drive, 1 Stage	AM667255	\$ 107.00
2 440, 460	Threshing Mechanism	AM667453	\$ 336.69
3 440, 460	Grain Tank Unloading	AM667250	\$ 91.11
4 440, 460	Straw Chopper, 1 Stage	AM667958	\$ 102.84
5 415, 430, 440, 460	Cleaning, 2 Stage	AM667252	\$ 112.00
6 415, 430	Straw Chopper, 2 Stage	AM667683	\$ 55.25
6 440, 460	Straw Chopper, 2 Stage	AM061700	\$ 107.49
7 415, 430	Straw Chopper, 3 Stage	AM667683	\$ 55.25

Prices Subject to Change without Prior Notice. The use of original equipment manufacturer (OEM) part numbers or trademarks, e.g. Case® and John Deere®, are for reference purposes only and for indicating product use and compatibility. Our company and the listed replacement parts contained herein are not sponsored, approved or manufactured by the OEM. All parts are New unless designated Reman in the description.

Lexion®—Combine

Application	Description	Part Number	Retail Price
7 440, 460	Straw Chopper, 3 Stage	AM061700	\$ 107.49
7 460	Straw Chopper, 3 Stage	AM749712	\$ 150.39
8 440, 460	Joined V-Belt	AM661093	\$ 92.33
9 415, 430, 440, 460	Header Drive, 2 Stage w/o Vari-Speed	AM667454	\$ 93.19
10 415, 430, 440, 460	Header Drive, 3 Stage w/ Vari-Speed Set of 2	AM667551	\$ 230.00
11 415, 430, 440, 460	Impeller Drum	AM667249	\$ 94.09
12 415, 430, 440, 460	Header, Variable Speed	AM667530	\$ 137.71
13 415, 430, 440, 460	Straw Spreader	AM758719	\$ 14.49
14 415, 430, 440, 460	Cleaning, 3 Stage	AM667651	\$ 158.93
14 460	Cleaning, 3 Stage	AM644866	\$ 238.36
15 415, 430, 440, 460	Cleaning, 1 Stage	AM644209	\$ 43.19
16 415, 430, 440, 460	Straw Walker Driver	AM667477	\$ 55.08
17 415, 430, 440, 460	V-Belt	AM667560	\$ 12.35
18 415, 430, 440, 460	Fan & Rotary Screen	AM667242	\$ 11.03
19 440, 460	Rotary Screen, Stage 1	AM667456	\$ 10.78
20 415, 430, 440, 460	Agitator Tines, Rear	AM667973	\$ 29.86
21 415, 430, 440, 460	Agitator Tines, Front	AM667974	\$ 48.95
22 415, 430, 440, 460	Rotary Screen, 2 Stage	AM667561	\$ 23.79
22 460	Rotary Screen, 2 Stage	AM545689	\$ 24.80
23 415, 430, 440, 460	Threshing Drum, Variable Speed	AM667248	\$ 520.94
24 460 ASN 55700462	Threshing Drum	AM176442	\$ 228.13
24 460 BSN 55700461	Threshing Drum	AM667458	\$ 130.00
24 415, 430, 440	Threshing Drum	AM667255	\$ 107.00
25 415, 430, 440, 460	Fan Drive, Stage 1	AM742026	\$ 21.49
25 415, 430, 440, 460	Fan Drive, Stage 1	AM667957	\$ 31.59
26 415, 430, 440, 460	Fan, Variable Speed	AM667457	\$ 69.91
27 415, 430, 440, 460	Accelerator	AM667251	\$ 108.65
28 415, 430, 440, 460	Suction Blower	AM644781	\$ 10.82
NI 460	Straw Spreader Drive	AM539443	\$ 465.30

Belts—470, 475, 485

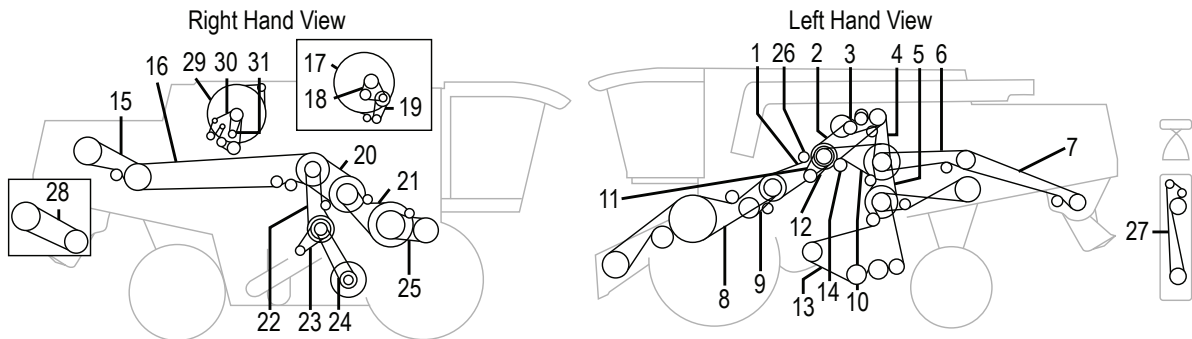

Application	Description	Part Number	Retail Price
1 470, 475, 485	Header Drive, 1 Stage	AM667255	\$ 107.00
2 470	Threshing Mechanism	AM667453	\$ 336.69
2 470, 475	Threshing Mechanism	AM352403	\$ 373.11
2 485	Threshing Mechanism	AM667881	\$ 418.90

Lexion®—Combine

Application	Description	Part Number	Retail Price
3 470, 475, 485	Grain Tank Unloading	AM667250	\$ 91.11
4 470, 475	Straw Chopper, 1 Stage	AM667958	\$ 102.84
4 485 BSN 56800529	Straw Chopper, 1 Stage	AM644685	\$ 158.05
4 485 ASN 56800530	Straw Chopper, 1 Stage	AM644966	\$ 129.16
5 470, 475, 485	Cleaning, 2 Stage	AM667252	\$ 112.00
6 470, 475, 485	Straw Chopper, 2 Stage	AM061700	\$ 107.49
6 485	Straw Chopper, 2 Stage	AM749712	\$ 150.39
7 470, 475, 485	Straw Chopper, 3 Stage	AM350463	\$ 170.55
8 470, 475, 485	Header Drive, 2 Stage, w/o Vari-Speed	AM667454	\$ 93.19
9 470, 475, 485	Header Drive, 3 Stage, w/ Vari-Speed Set of 2	AM667551	\$ 230.00
10 470, 475, 485	Impeller Drum	AM667249	\$ 94.09
11 470, 475, 485	Header, Variable Speed	AM667530	\$ 137.71
12 470, 475, 485	Straw Spreader	AM758719	\$ 14.49
13 470, 475, 485	Cleaning, 3 Stage	AM644866	\$ 238.36
14 470, 475, 485	Cleaning, 1 Stage	AM644209	\$ 43.19
15 470, 475, 485	Hybrid Drive, Stage 2	AM629510	\$ 124.57
15 470, 485	Hybrid Drive, Stage 2	AM667983	\$ 126.00
15 470, 475	Hybrid Drive, Stage 2 - 300 RPM	AM749895	\$ 178.85
15 470, 485	Hybrid Drive, Stage 2	AM667458	\$ 130.00
16 470, 475, 485	Hybrid Drive, Stage 1	AM749886	\$ 442.38
16 470, 485	Hybrid Drive, Stage 1	AM667554	\$ 352.65
17 470, 485	Rotary Screen, 2 Stage	AM667561	\$ 23.79
17 475	Rotary Screen, 2 Stage	AM545689	\$ 24.80
18 470	Fan & Rotary Screen	AM667242	\$ 11.03
18 485	Fan & Rotary Screen	AM350340	\$ 26.77
19 470, 485	Rotary Screen, Stage 1	AM667456	\$ 10.78
20 470, 475, 485	Threshing Drum, Variable Speed	AM667248	\$ 520.94
21 470, 475, 485 ASN 56800462	Threshing Drum	AM176442	\$ 228.13
21 485 BSN 56800461	Threshing Drum	AM667458	\$ 130.00
22 470, 475, 485	Fan Drive, Stage 1	AM742026	\$ 21.49
23 470, 475, 485	Suction Blower	AM644781	\$ 10.82
24 470, 475, 485	Fan, Variable Speed	AM667457	\$ 69.91
25 470, 475, 485	Accelerator	AM667251	\$ 108.65
26 470, 475, 485	Hydraulic Reel Drive	AM829094	\$ 15.00
26 470, 485	Hydraulic Reel Drive	AM055292	\$ 16.20
27 470, 475, 485	Straw Spreader Drive	AM539443	\$ 465.30
28 470, 475, 485	Hybrid Drive, 2 Stage	AM667248	\$ 520.94
29 470, 485	Rotary Screen, 2 Stage	AM545689	\$ 24.80
NI 485	Belt	AM761979	\$ 29.75

Lexion®—Combine

Belts—480

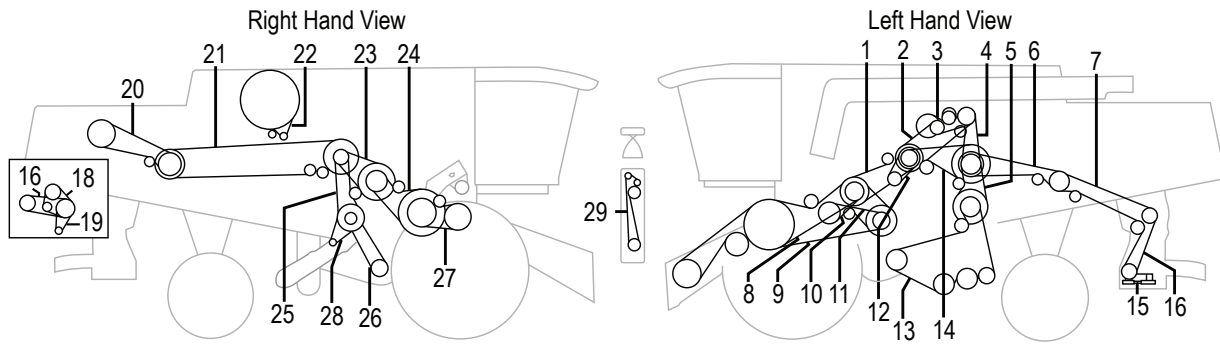

Application	Description	Part Number	Retail Price
1 480	Header Drive, 1 Stage	AM667255	\$ 107.00
2 480	Threshing Mechanism	AM667881	\$ 418.90
3 480	Grain Tank Unloading	AM667250	\$ 91.11
4 480	Straw Chopper, 1 Stage	AM644685	\$ 158.05
4 480	Straw Chopper, 1 Stage	AM644966	\$ 129.16
5 480	Cleaning, 2 Stage	AM667252	\$ 112.00
6 480	Straw Chopper, 2 Stage	AM061700	\$ 107.49
7 480	Straw Chopper, 3 Stage	AM749712	\$ 150.39
7 480	Straw Chopper, 3 Stage	AM350463	\$ 170.55
8 480	Header Drive, 2 Stage	AM667454	\$ 93.19
9 480	Header Drive, 3 Stage w/ Vari-Speed Set of 2	AM667551	\$ 230.00
10 480	Impeller Drum	AM667249	\$ 94.09
11 480	Header, Variable Speed	AM667530	\$ 137.71
12 480	Straw Spreader Drive	AM2338431	\$ 18.08
12 480	Straw Spreader Drive	AM758719	\$ 14.49
13 480	Cleaning, 3 Stage	AM644866	\$ 238.36
14 480	Cleaning, 3 Stage	AM667651	\$ 158.93
15 480	Cleaning, 1 Stage	AM644209	\$ 43.19
17 480	V-Belt	AM667798	\$ 33.19
18 480	V-Belt	AM667560	\$ 12.35
18 480	Fan & Rotary Screen	AM667242	\$ 11.03
19 480	Fan & Rotary Screen	AM350340	\$ 26.77
20 480	Rotary Screen, Stage 1	AM667456	\$ 10.78
20 480	Hybrid Drive, Stage 2	AM667983	\$ 126.00
20 480	Hybrid Drive, Stage 2	AM629510	\$ 124.57
20 480	Hybrid Drive, Stage 2 - 300 RPM	AM176442	\$ 228.13
20 480	Hybrid Drive, Stage 2 - 300 RPM	AM667458	\$ 130.00
21 480	Hybrid Drive, Stage 1	AM667554	\$ 352.65
21 480	Hybrid Drive, Stage 1	AM749886	\$ 442.38
22 480	Rotary Screen, 2 Stage	AM667561	\$ 23.79
22 480	Rotary Screen, 2 Stage	AM545689	\$ 24.80
23 480	Threshing Drum, Variable Speed	AM667248	\$ 520.94
24 480 ASN 56600462	Threshing Drum	AM176442	\$ 228.13
24 480 BSN 56600461	Threshing Drum	AM667458	\$ 130.00
24 480	Threshing Drum	AM667255	\$ 107.00

Lexion®—Combine

Application	Description	Part Number	Retail Price
25 480	Fan Drive, Stage 1	AM742026	\$ 21.49
26 480	Fan, Variable Speed	AM667457	\$ 69.91
27 480	Accelerator	AM667251	\$ 108.65
28 480	Suction Blower	AM644781	\$ 10.82
29 480	Straw Spreader Drive	AM539443	\$ 465.30
NI 480	Hydraulic Reel Drive	AM829094	\$ 15.00
NI 480	Hydraulic Reel Drive	AM055292	\$ 16.20
NI 480	Belt	AM761979	\$ 29.75

Belts—580R, 585R

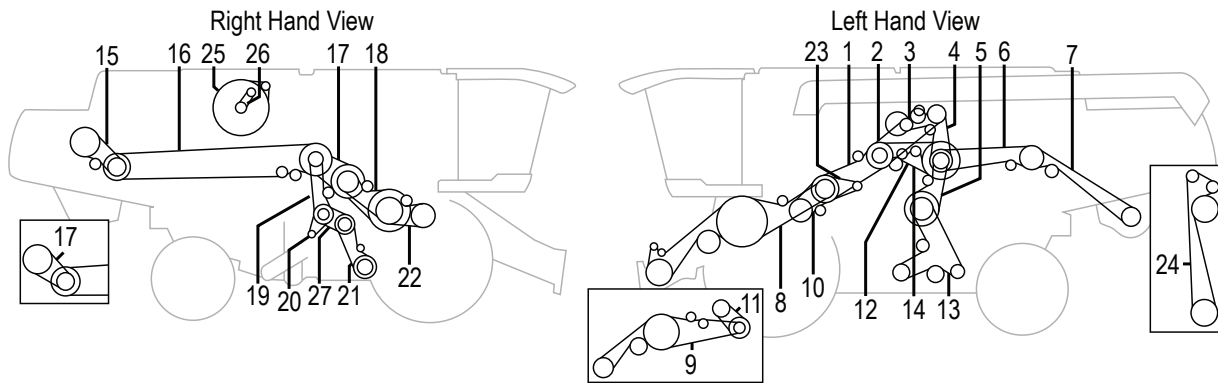

Application	Description	Part Number	Retail Price
1 580R, 585R	Belt	AM644892	Call for Price
2 580R, 585R	Threshing Mechanism	AM667452	Call for Price
3 580R, 585R	Grain Tank Unloader	AM667250	\$ 91.11
4 580R, 585R	Straw Chopper, 1 Stage	AM667958	\$ 102.84
5 580R, 585R	Cleaning, 2 Stage	AM644902	\$ 138.97
6 580R, 585R	Straw Chopper, 2 Stage	AM644890	Call for Price
7 580R, 585R	Belt	AM355658	Call for Price
8 580R, 585R	Header Drive, 2 Stage	AM667454	\$ 93.19
9 580R, 585R	Header Drive, 3 Stage Set of 2	AM667551	\$ 230.00
10 580R, 585R	Impeller Drum	AM667249	\$ 94.09
11 580R, 585R	Header, Variable Speed	AM667530	\$ 137.71
12 580R, 585R	Straw Spreader	AM746508	Call for Price
13 580R, 585R	Belt	AM756466	Call for Price
14 580R, 585R	Cleaning, 1 Stage	AM644209	\$ 43.19
15 580R, 585R	Hybrid Drive, Stage 2	AM629510	\$ 124.57
15 580R, 585R	Hybrid Drive, Stage 2 - 300 RPM	AM749895	\$ 178.85
16 580R, 585R	Hybrid Drive, Stage 1	AM749886	\$ 442.38
17 580R, 585R	Threshing Drum, Variable Speed	AM667248	\$ 520.94
18 580R, 585R	Threshing Drum	AM176442	\$ 228.13
19 580R, 585R	Fan Drive, Stage 1	AM667957	\$ 31.59
20 580R, 585R	Suction Blower	AM667367	Call for Price
21 580R, 585R	Belt	AM744785	Call for Price
22 580R, 585R	Accelerator	AM667251	\$ 108.65

Prices Subject to Change without Prior Notice. The use of original equipment manufacturer (OEM) part numbers or trademarks, e.g. Case® and John Deere®, are for reference purposes only and for indicating product use and compatibility. Our company and the listed replacement parts contained herein are not sponsored, approved or manufactured by the OEM. All parts are New unless designated Reman in the description.

Lexion®—Combine

Application	Description	Part Number	Retail Price
23 580R, 585R	Hydraulic Reel Drive	AM829094	\$ 15.00
24 580R, 585R	Straw Spreader Drive	AM539443	\$ 465.30
25 580R, 585R	Rotary Screen, 2 Stage	AM545689	\$ 24.80
26 580R, 585R	Belt	AM743910	Call for Price
27 580R, 585R	Fan, Variable Speed	AM628847	Call for Price
NI 580R, 585R	Belt	AM765985	Call for Price

Used Parts

Table of Contents

Axle Sleeves.....	1458	Electronic Control Modules.....	1451
Dual Hubs.....	1461		

Electronic Control Modules

Application	Description	Part Number	Retail Price	Wholesale
Case® Tractors: 1896 ASN 17895499, 2096 ASN 17897499, 2394, 2594, 3394, 3594	Used Electronic Steering Control Module Replaces 1935094C1	AMA187171-U	\$ 900.00	\$ 810.00
Case® Tractors: 4494, 4694, 4894	Used Electronic Steering Control Module	AMA177107-U	\$ 900.00	\$ 810.00
Case IH® Tractors: Magnum®: (250, 280, 310, 310 Rowtrac™, 340, 340 Rowtrac™ - Tier 4B CVT or PST), (Magnum®: 380 Tier 4B CVT), Magnum®: 380 Rowtrac™, Quadtrac®: 370 Rowtrac™, 420 Rowtrac™, Quadtrac®: (470, 470 Rowtrac™, 500, 500 Rowtrac™, 540, 580, 620 - Tier 4B 03/2014-11/17), Steiger®: 370, 420, 470, 500, 540, 580, 620, Ford®/New Holland® Tractors: (T8.320, T8.350, T8.380, T8.380 SmartTrax™, T8.410, T8.410 SmartTrax™, T8.435, T8.435 SmartTrax™ - Tier 4B CVT or PST), (T9.435, T9.480, T9.530, T9.565, T9.600, T9.645, T9.700 - Tier 4B 03/2014-11/17)	Used Electronic Control Module For Tractors w/o AFS Connect™ or PLM Intelligence™ Replaces 84474442	AM47416081-U	\$ 400.00	\$ 360.00
Case IH® Tractors: 5120, 5130, 5140, 5220, 5230, 5240, 5250	Used Electronic Steering Control Module	AM1987440C1-U	\$ 900.00	\$ 810.00
	Used Electronic Steering Control Module	AM1983208C3-U	\$ 900.00	\$ 810.00
Case IH® Tractors: 7110, 7120, 7130, 7140, 7150	Used Electronic Hitch Control Module	AM1983407C1-U	\$ 500.00	\$ 450.00
Case IH® Tractors: 8910, 8920, 8930, 8940, 8950	Used Electronic Control Module Unit	AM232825A2-U	\$ 750.00	\$ 675.00
Case IH® Tractors: (9210, 9230, 9240, 9250, 9260, 9270, 9280 BSN JCB0028400)	Used Electronic Transmission Controller	AM60-6478T2-U	\$ 1200.00	\$ 1000.00
Case IH® Tractors: MX180, MX200, MX210, MX220, MX230, MX240, MX255, MX270, STX275, STX325, STX375, STX440, Ford®/New Holland® Tractors: T9020, T9030, T9040, T9050, T9060, TG210, TG230, TG255, TG285, TJ275, TJ280, TJ325, TJ330, TJ375, TJ380, TJ425, TJ430, TJ450, TJ480, TJ500, TJ530	Used Electronic Control Module	AM313776A4-U	\$ 800.00	\$ 720.00
Case IH® Tractors: (MX180, MX200, MX220, MX240, MX270 BSN JJA0105000)	Used Electronic Draft Control Module	AM323758A1-U	\$ 550.00	\$ 500.00
Case IH® Tractors: (MX215, MX245, MX275, MX305, MX180, MX200, MX210, MX220, MX230, MX240, MX255, MX270, MX285, STX275, STX280, STX325, STX330, STX375, STX380, STX425, STX430, STX440, STX450, STX480, STX500, STX530 BSN Z6RZ04001), (Magnum®: 215, 245, 275, 305, 335 BSN Z6RZ04001), Steiger®: 330, 335, 380, 385, 430, 435, 480, 485, 530, 535, Combines: 2366, 2377, 2388, 2577, 2588, Floaters: FLX3010, FLX3510, FLX4010, FLX4510, Sprayer: SPX4410	Used Active Terminator Use w/ AFS Systems, AccuGuide, or Electronic Modules	AM284638A2-U	\$ 250.00	\$ 225.00
Case IH® Tractors: (MX240, MX270 ASN JJA0104999), MX255, MX285, STX275, STX325, Cotton Pickers: CPX610, CPX620 BSN Y6T011701, Floaters: FLX3010, FLX3300B, FLX3510, FLX4010, FLX4300, FLX4375, FLX4510, Sprayer: SPX4410, Ford®/New Holland® Tractors: TG255, TG285, TJ275, TJ325	Used Electronic Engine Controller Replaces 3944125, J3944125	AMJ944125-U	\$ 1000.00	\$ 900.00
Case IH® Tractors: MXM120, MXM130, MXM155, MXM175, MXM190, Puma®: 165, 180, 195, 210, Ford®/New Holland® Tractors: T7030, T7040, T7050, T7060, TM120, TM130, TM140, TM155, TM175, TM190	Used Electronic Control Module Mfg # 47130674	AM47130674-U	\$ 500.00	\$ 450.00
Case IH® Tractors: MXU100, MXU110, MXU115, MXU125, MXU130, MXU135, Ford®/New Holland® Tractors: TS100A, TS110A, TS115A, TS130A, TS135A	Used Electronic Control Module Mfg # 87304684	AM82032690-U	\$ 400.00	\$ 360.00
Case IH® Combines: 88 Series	Used Yield Monitor Controller	AM333351A1-U	\$ 450.00	\$ 405.00
Case IH® Combines: 1420 ASN 005500, 1440 ASN 030000, 1460 ASN 032000, 1480 ASN 034000	Used Automatic Reel Speed to Ground Speed Control Unit	AM1301289C2-U	\$ 225.00	\$ 202.50
Case IH® Combines: 1620 ASN JJC0032630, 1640, 1644, 1660, 1666, 1680, 1688	Used Feeder Cut Off Module	AM1983213C2-U	\$ 425.00	\$ 382.50

Prices Subject to Change without Prior Notice. The use of original equipment manufacturer (OEM) part numbers or trademarks, e.g. Case® and John Deere®, are for reference purposes only and for indicating product use and compatibility. Our company and the listed replacement parts contained herein are not sponsored, approved or manufactured by the OEM. All parts are New unless designated Reman in the description.

Used Parts

Application	Description	Part Number	Retail Price	Wholesale
Case IH® Combines: 1640, 1660, 1680, 2144, 2166, 2188, 2366, 2377, 2388, 2577, 2588	Used Field Tracker Control Module Replaces 100275A1, 100275A2	AM271499-U	\$ 550.00	\$ 495.00
Case IH® Combines: 1644, 1666, 1688, 2144, 2166, 2188, 2344, 2377, 2388	Used AFS Yield Monitor	AM222694A3-U	\$ 1025.00	\$ 922.50
Case IH® Combines: 2344 BSN JJC0174359, 2366 BSN JJC0252949, 2388 BSN JJC0267149, Cotton Pickers: 2555 ASN JJC0157149, CPX420, CPX610	Used Control Module Replaces 239951A1	AM239951A2-U	\$ 325.00	\$ 292.50
Case IH® Combines: 2366, 2377, 2388 ASN HAJ0292000, 2577, 2588, 7010, 8010, AFX8010	Used Yield Monitor Interface Unit Controller Replaces 348084A3	AM86976394-U	\$ 450.00	\$ 405.00
Case IH® Combine: 2388, Floater: 438 Flex Air Applicator, Sprayer: SPX4260	Used Trimble GPS Receiver Trimble AFS Universal Receiver	AM293594A2-U	\$ 800.00	\$ 720.00
Cummins® Engine: 6BTA6.7C	Used ECM Module	AMP4921776-U	\$ 400.00	\$ 360.00
Ford®/New Holland® Tractors: (5640, 6640, 7740, 7840, 8240, 8340 - 12x12 or 16x16 Transmission w/ or w/o Dual Power), (8210 03/1989 and Later w/ Hydraulic Lift)	Used Electronic Transmission Controller Replaces 84252956	AM87037950-U	\$ 575.00	\$ 515.00
Ford®/New Holland® Tractors: 8530, 8630, 8730, 8830	Used Transmission Controller	AME9NN7Z369AC-U	\$ 900.00	\$ 810.00
Ford®/New Holland® Tractors: TM115, TM120, TM125, TM130, TM135, TM140, TM150, TM155, TM165, TM175, TM190	Used Electronic Control Module Mfg # 87304731	AM82029203-U	\$ 450.00	\$ 405.00
Ford®/New Holland® Tractors: TM175, TM190	Used Electronic Control Unit Replaces 87304731	AM82033620-U	\$ 500.00	\$ 450.00
New Holland® Combines: CR6090, CR7090, CR8080, CR8090, CR9040, CR9060, CR9065, CR9070, CR9080, CX8070, CX8080, CX8090	Used Electronic Control Module	AM87105720-U	\$ 1115.00	\$ 1000.00
International® Engine: DT466E Non EGR	Used Diesel Engine Computer Module	AM1807476C1-U	\$ 750.00	\$ 675.00
International® Tractors: 786, 886, 986, 1086, 1486, 1586, 3088, 3288, 3388, 3588, 3688, 3788, Hydro 186	Used Electronic Steering Control Module	AM107336C91-U	\$ 900.00	\$ 810.00
International® Tractors: 3088, 3288, 3488, 3688, 5088, 5288, 5488, 6388, 6588, 6788, 7288, 7488	Used Electronic Steering Control Module Replaces 1252486C1, 1252488C1	AM1252486C2-U	\$ 900.00	\$ 810.00
John Deere® PowerTech™ Engines: 10.5L 6105AF001 and 6105HF001, 12.5L 6125AF001, 6125AT801 6125HF001 Engine ASN 010966 and 6125HF070 High Temperature Engine ASN 299999	Used Electronic Engine Controller Replaces RE507301, RE507317, RE507325, RE507329, RE507361, RE515051, RE515166	AMRE507982-U	\$ 1250.00	\$ 1125.00
John Deere® Most Models	Used Electronic Steering Controller Used Electronic Vehicle Controller	AMRE573595-U AMAXE66878-U	\$ 750.00 \$ 750.00	\$ 675.00 \$ 675.00
John Deere® Tractors: 4050, 4250, 4450, 4650, 4850, 8450, 8650, 8850	Used Digital Tachometer Replaces AR101282, RE16441, RE66830	AMRE13654-U	\$ 600.00	\$ 550.00
John Deere® Tractors: 4055, 4255, 4455, 4555, 4755, 4955, 8560, 8760, 8960	Used Intellitrak™ Performance Monitor Replaces RE24516	AMRE44861-U	\$ 800.00	\$ 720.00
John Deere® Tractors: 4555, 4755, 4560, 4760, 4955, 4960, 8560, 8760, 8960	Used Hitch Controller Motorola, Mfg # 7EHH2JD04 Replaces RE26789, RE42031, RE55229	AMRE38819-U	\$ 400.00	\$ 360.00
John Deere® Tractors: 4955, 4960, 8100, 8200, 8300, 8560, 8570, 8760, 8770, 8870, 9500, 9500SH, 9600, Combine: CTS	Used Engine Controller Module Mfg # RE501731, RE28320, Bosch 0281001058 For 6076 BSN 499999, 6076A, 6076AF, 6076AFN-30, 6076H, 6076HF, 6081HF001, 6101AF010, 6101HF010	AMRE28320-U	\$ 875.00	\$ 787.50
John Deere® Tractor: 6120	Used Electronic Control Module Replaces AL161843	AMAL161843-U	\$ 500.00	\$ 450.00
John Deere® Tractors: 6120, 6220, 6320, 6320L, 6420, 6420L, 6520L, 7220, 7320, 7420, 7520	Used Basic Control Unit, Hitch Replaces AL161753, AL151142, AL159961, AL162476, AL169652	AMAL161753-U	\$ 700.00	\$ 630.00
John Deere® Tractors: 6170R, 6190R, 6210R, 7230R BSN 080000, 9360R	Used Electronic Engine Controller	AMRE539229-U	\$ 1225.00	\$ 1100.00
John Deere® Tractors: Premium Models: (6230, 6330, 6430, 7130, 7230, 7430, 7530 BSN 637887), Combines: 9570STS, 9670STS, 9770STS, 9870STS, S550, S650, S660, S670, S670HM, S680, S680HM, S690, S690HM, S760, S770, S780, S790	Used Electronic Control Module	AMAH224250-U	\$ 200.00	\$ 180.00
John Deere® Tractors: 6320, 6420, 7220, 7320, 7720, 7820	Used Electronic Engine Controller Replaces RE508774	AMRE522509-U	\$ 700.00	\$ 630.00

Used Parts

Application	Description	Part Number	Retail Price	Wholesale
John Deere® Tractors: 6320, 6420, 7630, 7730, 7830, 7930	Used Steering Control Module Replaces RE231728, RE240027	AMRE251348-U	\$ 575.00	\$ 517.50
John Deere® Tractors: 7200, 7210, 7400, 7410, 7510, 7600, 7610, 7700, 7710, 7800, 7810	Used Electronic Control Module Replaces RE150595, RE150596, RE168573, RE168574, RE170415, RE170416, RE52627, RE61858, RE61891, RE64601, RE64602, RE66874, RE67323, RE69204, RE70916	AMRE51230-U	\$ 450.00	\$ 405.00
John Deere® Tractors: 7200, 7210, 7400, 7410, 7510, 7600, 7610, 7700, 7710, 7800, 7810, 8560 ASN 003100, 8570, 8760 ASN 005100, 8770, 8870, 8960 ASN 004100	Used Electronic Hitch Controller Replaces RE26789, RE42031, RE43828, RE53245, RE55228, RE55228A, RE55229, RE66220, RE69206, RE70918, RE150600, RE160007, RE162932	AMRE170904-U	\$ 450.00	\$ 400.00
John Deere® Tractors: (7220, 7320 - w/ PowerQuad™ Transmission & Tier 2 Engine ASN 012450), (7420, 7520 - w/ PowerQuad™ Transmission & Tier 2 Engine ASN 012453)	Used Electronic Engine Controller Replaces RE519774	AMRE522528-U	\$ 750.00	\$ 675.00
John Deere® Tractors: 7220, 7320, 7420, 7520	Used Electronic Basic Control Unit Replaces AL159961, AL161753, AL162476, AL173701	AMAL177189-U	\$ 550.00	\$ 500.00
John Deere® Tractors: 7220, 7320, 7720, 7820 - w/ IVT™ Transmissions	Used Electronic Engine Controller	AMRE508774-U	\$ 750.00	\$ 675.00
John Deere® Tractors: 7300, 7400, 7500, 7700, 7800, 9120, 9220, 9300T, 9320, 9320T, 9400T, 9420, 9420T, 9520, 9520T, 9620, 9620T, Combine: 9860STS	Used Engine Control Module Replaces RE507435, RE507980, RE509905, RE509907, RE597433	AMRE507980-U	\$ 1000.00	\$ 900.00
John Deere® Tractors: 7600 ASN 005968, 7700 ASN 007069, 7800 ASN 0010168	Used Electronic Transmission Controller 12 Volt For Powershift™ Transmission Replaces RE47166, RE55276, RE58141	AMRE168698-U	\$ 750.00	\$ 675.00
John Deere® Tractors: 7630, 7730, 7830, 7930, 8330, (8130, 8230, 8430, 8530 BSN 040000), (9230, 9330, 9430, 9530, 9630 BSN 013000), (9430T, 9530T, 9630T BSN 911000)	Used Electronic Hitch and SCV Controller	AMRE231325-U	\$ 475.00	\$ 425.00
John Deere® Tractors: 7630, 7730, 7830, 7930, (8130, 8230, 8330, 8430, 8530 BSN 010000), 8230T, 8330T, 8430T, 9230, Premium Models: 6230 w/ 4 Valve Engine, 6330 w/ 4045HL480 or 4045HL482 Engine w/ 4 Valve Engine, 6430 w/ 4045HL480 Engine w/ 4 Valve Engine, (7130, 7230 - w/ 6068HRW73 Engine w/ 4 Valve Engine), 7330 w/ 6068HRW75 Engine w/ 4 Valve Engine, 7430 w/ 6068HRW77 Engine w/ 4 Valve Engine, Combines: 9570STS, (9660STS, 9760STS ASN 715400), 9770STS, Sprayer: 4930	Used Electronic Engine Controller	AMRE520953-U	\$ 1250.00	\$ 1125.00
John Deere® Tractors: 7630, 7730, 7830, 7930, (8130, 8230, 8330, 8430 w/ Cab ASN 009999), 8225R BSN 053100, 8230T, (8245R, 8345R BSN 053100), 8270R, 8295R, 8320R, 8320RT ASN 912000, 8330T, 8345RT BSN 907101, 8430T, 8530 ASN 009999, Premium Models: (6230, 6430 - w/ 4045HL480 Engine w/ 4 Valve Engines), (6330 w/ 4045HL480 or 4045HL482 Engine w/ 4 Valve Engines), (7130, 7230 - w/ 6068HRW73 Engine w/ 4 Valve Engines), (7330, 7430 - w/ 6068HRW77 Engine w/ 4 Valve Engines), 7530, Combines: 9560STS ASN 720100, 9570STS, (9660STS, 9760STS ASN 715400), 9770STS, Cotton Pickers: 7660, 9970 w/ 6068HN065 Engine, Forage Harvesters: 7250 w/ 6090HZ008 Engine, (8100, 8200 - w/ 6090HZ013 Engine)	Used Electronic Engine Controller Replaces RE520953	AMRE531808-U	\$ 990.00	\$ 900.00
John Deere® Tractors: (7710, 7810 ASN 090000), 7720, 7820, 7920, 8120, 8120T, 8220, 8220T, 8320, 8320T, 8420, 8420T, 8520, 8520T, Combines: 9560STS, 9650, 9650CTS, 9650STS, 9660, 9750STS, Cotton Picker: 9996	Used Engine Controller	AMRE518503-U	\$ 700.00	\$ 630.00

Used Parts

Prices Subject to Change without Prior Notice. The use of original equipment manufacturer (OEM) part numbers or trademarks, e.g. Case® and John Deere®, are for reference purposes only and for indicating product use and compatibility. Our company and the listed replacement parts contained herein are not sponsored, approved or manufactured by the OEM. All parts are New unless designated Reman in the description.

Used Parts

Application	Description	Part Number	Retail Price	Wholesale
John Deere® Tractors: 7710 BSN 090000 w/ 6081TRW03/AQT Engine, 7810 BSN 090000 w/ 6081TRW04/AQT Engine, 8100 ASN 09999 w/ 6076HRW06 Engine, 8110, 8110T, 8200 ASN 09999, 8210, 8210T, 8300*, 8310, 8310T, 8400, 8410, 8410T, 9100, Combines: 9500, 9500SH, 9510, 9510SH, 9550 w/ 6081HH008 or HH020 Engine ASN 126224, 9550SH w/ 240 HP 6081HH009 Engine, 9600 w/ 6076HH030, HH031 or HH035 Engine ASN 499999, 9610, 9650 Engine BSN 200000, 9650CTS w/ 6081HH010 Engine BSN 200000, 9650STS, 9750STS - w/ 6081HH005 or HH006 Engine BSN 200000), CTS, CTS II, Cotton Pickers: 9976 w/ 6081HN001 Engine, 9986 w/ 6081HN003 Engine *BSN 010000 w/ 6076HRW33, HRW34 or HRW35 Engine & ASN 09999 w/ 6076HRW08 Engine	Used Electronic Engine Controller L3/12 Volt ECU Marked RE66614, RE502404 Replaces RE48731, RE69550, RE70027, RE500109, RE500180, RE500510, RE500719, RE500769, RE500772, RE500773, RE501761, RE501770, RE501771, RE501772, RE502081, RE502082, RE502083, RE502121, RE502122, RE502123, RE502124, RE502146, RE502425, RE502426, RE502427, RE502428, RE502892, RE502893, RE502894, RE503177, RE503178, RE503179, RE503182, RE503183, RE503233, RE503234, RE503312, RE503313, RE503314, RE503315, RE503316, RE503340, RE503347, RE503350, RE503378, RE503379, RE503380, RE503398, RE504071, RE504179, RE507722, RE507723, RE507727, RE507728, RE508646, RE509559	AMRE502404-U	\$ 975.00	\$ 877.50
John Deere® Tractors: (7710, 7810 ASN 089999), (7720, 7820, 7920 Engine ASN 217335), 8120*, 8220*, 8320*, 8420*, 8520*, Combines: 9560STS w/ 6081HH019 or HH028 Engine, (9650, 9650CTS Engine ASN 217679), (9650STS, 9750STS - w/ 6081HH012 Engine ASN 217607 or 6081HH013 Engine ASN 217606), 9660, 9660CTS, 9660STS**, 9760STS**, Cotton Picker: 9996 Engine ASN 217607, Sprayer: 4920 *Models w/ 6081HRW23, HRW25, HRW26, HRW27, HRW28, HRW31, HRW32, HRW33, HRW34, HRW35, HRW36, HRW37 or HRW38 Engine ASN 217335 & w/ 6081HRW46 Engine ASN 217606 **Models w/ 6081HH012 Engine ASN 217607, 6081HH013 Engine ASN 217335, 6081HH026 Engine ASN 217606 or 6081HH027 Engine ASN 217748	Used Electronic Engine Controller Replaces RE518503	AMRE522515-U	\$ 700.00	\$ 630.00
John Deere® Tractors (7720, 7820, 7920, 8120T, 8320T, 8420T, 8520T BSN 217336), (8120, 8220, 8320, 8420, 8520 BSN 217607 w/ 6081HRW46 Engine & BSN 217336 w/ 6081HRW23, HRW25, HRW26, HRW27, HRW28, HRW31, HRW32, HRW33, HRW34, HRW35, HRW36, HRW37 or HRW38 Engine), 8220T BSN 217607, (9120, 9220, 9320, 9420, 9520, 9620 BSN 217336 w/ 6125HRW30 Engine), Combines: (9650, 9650CTS BSN 217680 w/ 608HH017 Engine), (9650STS, 9750STS BSN 217680 w/ 6081HH013 Engine & BSN 217608 w/ 6081HH012 Engine), (9660STS BSN 217607 w/ 6081HH013 or HH026 Engine, BSN 217608 w/ 6081HH012 Engine, or BSN 217749 w/ 6081HH027 Engine), 9760STS BSN 217607 w/ HH026 Engine, or BSN 217336 w/ 6081HH013 Engine, or BSN 217749 w/ 6081HH012 or HH027 Engine, Cotton Picker: 9996 BSN 217608, Forage Harvester: 7200 BSN 213711	Used Electronic Engine Controller Marked R508773	AMRE508773-U	\$ 1200.00	\$ 1000.00
John Deere® Tractors: 7720, 7820, 7920, Combines: 9560, 9560SH, 9560STS, 9650STS, 9660, 9660CTS, 9660STS, 9750STS, 9760STS, 9860STS, 9870STS	Used Steering Control Module For IVT™ and PowerQuad™ Plus Transmission Replaces AH209023, RE196143	AMRE231717-U	\$ 500.00	\$ 450.00
John Deere® Tractors: (8100, 8200, 8300, 8400 ASN 019999)	Used Electronic Vehicle Control Module	AMRE152380-U	\$ 930.00	\$ 840.00
John Deere® Tractors: (8100, 8200, 8300, 8400 BSN 010000)	Used Electronic Control Module	AMRE66875-U	\$ 525.00	\$ 472.50
John Deere® Tractors: 8100, 8100T, 8110, 8110T, 8120, 8120T, 8200, 8200T, 8210, 8210T, 8220, 8220T, 8300, 8300T, 8310, 8310T, 8320, 8320T, 8400, 8400T, 8410, 8410T, 8420, 8420T, 8520, 8520T, 9100, 9120, 9200, 9220, 9300, 9300T, 9320, 9320T, 9400, 9400T, 9420, 9420T, 9520, 9520T, 9620, 9620T	Used SCV Digital Display Panel Replaces RE60928, RE63440	AMRE64583-U	\$ 800.00	\$ 720.00

Used Parts

Application	Description	Part Number	Retail Price	Wholesale
John Deere® Tractors: 8100, 8100T, 8200, 8200T, 8300, 8400, 9100, 9200, 9300, 9400	Used SCV Controller Mfg # RE60959, RE62611, RE63896, RE67118, RE67870, RE156219, RE159624, RE162767, RE165854, RE172584, RE183437, RE202679 Replaces RE63895, RE67116, RE67868, RE156220, RE159622, RE162770, RE165852, RE172586, RE183431 SCO-4 OR 5 SCV/R	AMRE60959-U	\$ 500.00	\$ 450.00
	Used SCV Controller Mfg # RE60959, RE62611, RE63896, RE67118, RE67870, RE156219, RE159624, RE162767, RE165854, RE172584, RE183437, RE202679 Replaces RE60957, RE63895, RE67116, RE67868, RE156220, RE159622, RE162770, RE165852, RE172586, RE183431 SCO-4 OR 5 SCV/R	AMRE62609-U	\$ 500.00	\$ 450.00
	Used SCV Controller Mfg # RE60959, RE62611, RE63896, RE67118, RE67870, RE156219, RE159624, RE162767, RE165854, RE172584, RE183437, RE202679 Replaces RE60957, RE62609, RE63895, RE67116, RE67868, RE156220, RE159622, RE162770, RE165852, RE172586, RE183431 SCO-4 or SCV/R	AMRE63896-U	\$ 500.00	\$ 450.00
John Deere® Tractors: 8100, 8110, 8120, 8200, 8210, 8220, 8300, 8310, 8320, 8400, 8410, (8420, 8520 ASN 031218)	Used Electronic Steering Controller Replaces RE214152, RE231728	AMRE251374-U	\$ 665.00	\$ 600.00
John Deere® Tractors: 8100, 8110, 8200, 8210, 8300, 8310, 8400, 8410, 9100 ASN 030934	Used SCV Controller Replaces RE60957, RE62609, RE63895, RE67116, RE67118, RE67868, RE156220, RE159622, RE162770, RE165852, RE172586, RE183431	AMRE172584-U	\$ 575.00	\$ 517.50
John Deere® Tractors: 8100, 8110T, 8200, 8210T, 8300, 8310T, 8400, 8410T, 9300T, 9400T	Used Hitch and SCV Controller Mfg # RE60959, RE62610, RE67022, RE67869, RE159623, RE162766, RE165853, RE172578, RE172584, RE183436, RE202678 Replaces RE60965, RE62607, RE67009, RE67117, RE159620, RE159932, RE162764, RE165850, RE171616, RE183430, RE202676	AMRE67869-U	\$ 500.00	\$ 450.00
John Deere® Tractors: 8100, 8200, 8300, 8400	Used Electronic Control Module	AMRE66877-U	\$ 1000.00	\$ 900.00
	Used Hitch and SCV Controller Replaces RE18430, RE60956, RE62607, RE67009, RE67117, RE67866, RE156220, RE159932, RE162764, RE165850, RE171616	AMRE67022-U	\$ 500.00	\$ 450.00
	Used SCV Controller Replaces RE60957, RE62609, RE63895, RE67116, RE67868, RE156220, RE159622, RE162770, RE165852, RE172586, RE183431	AMRE67118-U	\$ 750.00	\$ 675.00
	Used Electronic Instrument Control Unit Replaces RE60476	AMRE62649-U	\$ 825.00	\$ 740.00
John Deere® Tractors: 8110, 8120, 8210, 8220, 8310, 8320, 8410, 8420, 8520	Used Electronic Vehicle Monitor	AMRE172237-U	\$ 825.00	\$ 742.50
John Deere® Tractors: 8110, 8210, 8310, 8410	Used Electronic Vehicle Controller	AMRE179075-U	\$ 900.00	\$ 810.00
John Deere® Tractors: 8120, 8120T, 8220, 8220T, 8320, 8320T, 8420, 8420T, 8520, 8520T	Used Vehicle Controller Motorola, Mfg # 7VCU3JD01 Replaces RE190803, RE198007, RE201568, RE219402, RE235950	AMRE201568-U	\$ 750.00	\$ 675.00
	Used Electronic Vehicle Controller CCU/PCU Replaces RE190803, RE198007, RE201568	AMRE219402-U	\$ 750.00	\$ 675.00
John Deere® Tractors: 8120, 8120T, 8220, 8220T, 8320, 8320T, 8420, 8420T, 8520, 8520T, 9120, 9220, 9320, 9320T, 9420, 9420T, 9520T, 9620, 9620T	Used Electronic SCV Controller Marked RE201265 Replaces RE197241, RE198411, RE201265	AMRE201259-U	\$ 550.00	\$ 500.00
John Deere® Tractor: 9100	Used Engine Control Module Mfg # RE66614	AMRE66614-U	\$ 700.00	\$ 630.00

Used Parts

Application	Description	Part Number	Retail Price	Wholesale
John Deere® Tractors: 9120, 9220, 9320, 9320T, 9420, 9420T, 9520, 9520T, 9620, 9620T	Used Electronic Central Control Unit Marked RE223934	AMRE223933-U	\$ 575.00	\$ 515.00
John Deere® Tractors: (9120, 9220, 9320, 9420, 9520 ASN 011407 w/ Powershift Transmission), (9320T, 9420T, 9620T ASN 902242), 9520T, 9620	Used Electronic Transmission Controller	AMYZ502029-U	\$ 750.00	\$ 675.00
John Deere® Tractors: 9230, 9330, 9430, 9430T, 9530, 9530T, 9630, 9630T	Used Electronic Vehicle Control Module	AMRE227650-U	\$ 675.00	\$ 605.00
John Deere® Tractors: 9330, (9410R, 9460R, 9460RT, 9510R, 9510RT, 9560R, 9560RT - w/ Stage II Engine), 9430, 9430T, 9530, 9530T, 9630, 9630T, Combines: 9870TS, S680, S680HM, S690, S690HM, S780, S790, Cotton Pickers: 7760, CP690, Forage Harvesters: 7350, 7380, 7450, 7480, (7550, 7750 - w/ 6135HZ009 Engine), 7580, 7780, (8300, 8400, 8500, 8600 - w/ 6135HZ012 or 6135HZ017 Engine)	Used Electronic Engine Controller	AMRE520954-U	\$ 1200.00	\$ 1000.00
John Deere® Combines: Most Models	Used Digital Tachometer Gauge Mfg # - 7DTS2JD10 Note: Please verify Part Number before ordering	AMAH136295-U	\$ 350.00	\$ 315.00
	Used Circuit Board Mfg # - 7CAM9JD01 Note: Please verify Part Number before ordering	AMAH159036-U	\$ 150.00	\$ 135.00
	Used Circuit Board Mfg # - 605117, 95-135264 Note: Please verify Part Number before ordering	AMAH207365-U	\$ 250.00	\$ 225.00
	Used Electronic Vehicle Controller For Right Control Unit 1	AMAXE47162-U	\$ 650.00	\$ 585.00
John Deere® Combines: (1450, 1550 - South American SN 044825-047353)	Used Reel Speed Circuit Board	AMAH204478-U	\$ 500.00	\$ 450.00
John Deere® Combines: 6620 BSN 600962, 7720 BSN 601321, 8820 BSN 600005	Used Digital Tachometer Gauge Replaces AH108181	AMAH99763-U	\$ 350.00	\$ 315.00
	Used Digital Tachometer Gauge Replaces 7DTS2JD01	AMAH108181-U	\$ 350.00	\$ 315.00
John Deere® Combines: (9400, 9410, 9510, 9510SH, 9600, 9610, CTS, CST II - w/ Harvestrak), 9500, 9500SH	Used Instrument Gauge Circuit Board	AMAH125627-U	\$ 350.00	\$ 315.00
John Deere® Combines: 9400 ASN 660100, 9410, 9500 ASN 660200, 9510, 9600 ASN 660300, 9610, CTS Grain ASN 660400, CTS II	Used Dial-A-Matic Circuit Board	AMAH137147-U	\$ 300.00	\$ 270.00
John Deere® Combines: 9400 BSN 655118, 9600 BSN 655389, CTS BSN 655400	Used Dial-A-Matic Circuit Board	AMAH136498-U	\$ 150.00	\$ 135.00
	Used Instrument Gauge Circuit Board Replaces AH136498	AMAH145698-U	\$ 150.00	\$ 135.00
John Deere® Combines: 9400, 9410, 9450, 9500, 9500SH, 9510, 9510SH, 9550, 9550SH, 9600, 9610, 9650, 9650CTS, 9650STS, 9750STS, CTS, CTS II	Used Dial-A-Matic Circuit Board	AMAH145964-U	\$ 450.00	\$ 405.00
John Deere® Combines: 9400, 9410, 9500, 9500SH, 9510, 9510SH, 9600, 9610, CTS, CTS II, Cotton Pickers: 9935, 9965, 9970, 9976, 9986, 9996, Cotton Strippers: 7450, 7455, 7460, Sprayers: 6100, 6500, 6600, Swathers: 4890, 4895, 4990, 4995	Used Instrument Panel Circuit Board Replaces AH127572	AMAH141984-U	\$ 150.00	\$ 135.00
John Deere® Combines: 9400, 9500, 9500SH, 9600, CTS	Used Dial-A-Speed Controller Circuit Board	AMAH128397-U	\$ 350.00	\$ 315.00
John Deere® Combines: 9450 ASN 695100, 9550 ASN 695200, 9550SH ASN 695700, 9650 ASN 695300, 9650CTS ASN 695400, 9650STS ASN 695500, 9660CTS, 9750STS ASN 695600	Used Grain Loss Monitor Control Module Replaces AH168416, AH202647, AH204508	AMAH208074-U	\$ 325.00	\$ 292.50
John Deere® Combines: 9450 ASN 695100, 9550, 9550SH, 9560, 9560SH, 9560STS, 9650 ASN 695300, 9650CTS ASN 695400, 9650STS ASN 695500, 9660, 9660CTS, 9660STS, 9750STS ASN 695600, 9760STS, 9860STS	Used Circuit Board Replaces AH201393	AMAH206013-U	\$ 450.00	\$ 405.00
	Used Electrical Fuse/Relay Panel	AMAH213820-U	\$ 350.00	\$ 315.00
	Used Electrical Fuse/Relay Panel	AMAH213822-U	\$ 350.00	\$ 315.00
John Deere® Combines: 9450 BSN 695101, 9550 BSN 695201, 9550SH BSN 695701, 9650 BSN 695301, 9650CTS BSN 695401, (9650STS, 9750STS BSN 695501)	Used Grain Loss Monitor Control Module Replaces AH165536, AH167722, AH171674	AMAH201582-U	\$ 450.00	\$ 405.00

Used Parts

Application	Description	Part Number	Retail Price	Wholesale
John Deere® Combines: 9450, 9550, 9550SH, 9560, 9560SH, 9560STS, 9570STS, 9650, 9650CTS, 9650STS, 9660, 9660CTS, 9660STS, 9670STS, 9760STS, 9770STS, 9860STS, 9870STS	Used Return Elevator Slave Sensor	AMAH158581-U	\$ 225.00	\$ 202.50
John Deere® Combines: 9450, 9550, 9550SH, 9560, 9560SH, 9560STS, 9650, 9650CTS, 9650STS, 9750STS, 9660, 9660CTS, 9660STS, 9760STS, 9860STS	Used Tailings Elevator Sensor Master Control Module 12 Pin Connector Replaces AH158580, AH203071	AMAH214415-U	\$ 375.00	\$ 337.50
John Deere® Combines: 9450, 9550, 9550SH, 9650, 9650CTS, 9650STS, 9750STS	Used Power Distribution Circuit Board Replaces AH161474, AH168939	AMAH168940-U	\$ 200.00	\$ 180.00
John Deere® Combines: 9500, 9500SH, 9600, Cotton Picker: 9960 Engine SN 000101-000111, Cotton Stripper: 7445	Used Digital Tachometer Gauge Replaces AH130102	AMAH136006-U	\$ 525.00	\$ 472.50
John Deere® Combines: 9500, 9500SH, 9600, CTS	Used Circuit Board	AMAH127572-U	\$ 150.00	\$ 135.00
John Deere® Combines: 9500, 9600	Used Electronic Engine Controller Use w/ 6076TH001, HH003 or HH031 Engine w/ 85 mm Injection Pump Bore Replaces RE34048, RE44705, RE46802	AMRE34049-U	\$ 950.00	\$ 855.00
John Deere® Combines: (9570STS, 9670STS, 9770STS - South American)	Used Electronic Vehicle Controller Replaces AH222197	AMAH232507-U AMAH230758-U	\$ 450.00 \$ 550.00	\$ 405.00 \$ 500.00
John Deere® Combines: 9570STS, 9670STS, 9770STS, 9870STS	Used Electronic Vehicle Controller w/o Self-Leveling Shoe	AMAH230757-U	\$ 475.00	\$ 427.50
John Deere® Combine: 9600 BSN 642301	Used Shaft Speed Circuit Board	AMAH125485-U	\$ 250.00	\$ 225.00
John Deere® Combines: (9650STS, 9750STS - South American Models)	Used Warning Display Panel Circuit Board	AMAH211518-U	\$ 350.00	\$ 315.00
John Deere® Combines: 9660STS, 9760STS, 9860STS	Used Power Distribution Circuit Board Power Distribution w/ Relays Replaces AH167823	AMAH207669-U	\$ 575.00	\$ 517.50
John Deere® Combines: S550, S650, S660, S670, S670HM, S680, S680HM, S690, S690HM, S760, S770, S780, S790	Used Electronic Slave Material Sensor Module For Tailings Rethresher Replaces AH235611	AMAXE69423-U	\$ 170.00	\$ 150.00
John Deere® Combines: S550, S660, S670 BSN 765172, S670HM, S680 BSN 766007, S680HM, S690 BSN 765250, S690HM	Used Electronic Vehicle Controller Replaces AH232941	AMAXE22470-U	\$ 550.00	\$ 495.00
John Deere® Combines: S550, S650, S660 ASN 765171, S670 ASN 765272, S680 ASN 766006, S690 ASN 765249, S760, S770, S780, S790	Used Fuse Box	AMAXE20524-U	\$ 380.00	\$ 340.00
John Deere® Combines: S550, S680 BSN 766007, S680HM	Used Electronic Vehicle Controller For Right Control Unit 1	AMAXE22469-U	\$ 650.00	\$ 585.00
John Deere® Combines: S650, S660 ASN 765171, S670 ASN 765272, S680 ASN 766006, S690 ASN 765249, S760, S770, S780, S790	Used Electronic Grain Loss Controller	AMAXE27140-U	\$ 275.00	\$ 250.00
John Deere® Combines: S650, (S680, S690 ASN 785000), S760, S770, S780, S790	Used Electronic Vehicle Controller For Right Control Unit 1 Replaces AXE47162, AXE67947	AMAXE76443-U	\$ 440.00	\$ 400.00
John Deere® Combines: S660 ASN 765171, S670 ASN 765000, S680 ASN 766006, S690 ASN 765249, Cotton Picker: CP690, Cotton Stripper: CS690, Forage Harvesters: (8100, 8200, 8300, 8400, 8500, 8600 BSN 620000), 8700, 8800	Used Electronic Drive Train Controller Pro Drive™ or PTP Controller	AMAXE27355-U	\$ 425.00	\$ 385.00
John Deere® Combines: S680 ASN 766006, S690, S780, S790 ASN 805000	Used Electronic Engine Controller For Final Tier 4 Engine Replaces RE546396	AMDZ115244-U	\$ 770.00	\$ 690.00
John Deere® Combines: S760, S770, S780, S790	Used Electrical Load Center	AMAXE66929-U	\$ 90.00	\$ 75.00
	Used Electronic Vehicle Controller	AMAXE57803-U	\$ 450.00	\$ 400.00
John Deere® Combines: (T550, T560, T660, T670 - 2012-13)	Used Electronic Vehicle Controller	AMAXE22471-U	\$ 925.00	\$ 832.50
	Used Electronic Vehicle Controller Replaces AH232943	AMAXE22474-U	\$ 500.00	\$ 450.00

Used Parts

Application	Description	Part Number	Retail Price	Wholesale
John Deere® Cotton Pickers: 7760, Skid Steer Loaders: (330G, 331G, 333G), 332G BSN 387238, Wheel Loaders: 444K, 444L, 524K, 524K-II, 524L, 544K, 544K-II, 544L, 624K, 624K-II, 624L, 644K, 644K Hybrid, 644L, 644LH, 724K, 724L, (744K - w/ 6090DW06 or DW08 Engine ASN 632967 or 6090DW12 Engine ASN 630719) 744K-II, 824K, 824K-II, 844K, 844K-II, 844K-III, 944K BSN 690605	Used GPS Satellite Control Module	AMPF81438-U	\$ 475.00	\$ 427.50
John Deere® Cotton Picker: 9935, Cotton Stripper: 7455, Sprayer: 6100	Used Digital Tachometer Gauge	AMAH147554-U	\$ 525.00	\$ 472.50
John Deere® Cotton Picker: 9960 Engine SN 000101-000111	Used Digital Tachometer Gauge	AMAH128015-U	\$ 525.00	\$ 472.50
John Deere® Forage Harvesters: 5730, 5830, Swathers: 3430, 3830	Used Digital Tachometer	AMRE13916-U	\$ 350.00	\$ 315.00
John Deere® Forage Harvesters: 7180, 7250, 7280, 7350, 7380, 7450, 7480, 7550, 7580, 7780, 7850, 7950, (8100, 8200, 8300, 8400, 8500 BSN 621000), 8600 ASN 618999	Used Electronic Vehicle Controller Replaces AH222195	AMAH230756-U	\$ 570.00	\$ 510.00

Axle Sleeves

Application	Description	Part Number	Retail Price	Wholesale
John Deere® Tractors: 50, 60, 70, 520, 530, 620, 630, 720, 730, 2510, 2520, 2840, 2940, 2950, 2955, 3010, 3020, 4000, 4010, 4020, 4030, 4230	Used Axle Wedge For 79 mm Axle	Keyed AMR32224-U	\$ 50.00	\$ 45.00
	Used Axle Wedge For 79 mm Axle	Keyed AMA4386R-U	\$ 50.00	\$ 45.00
John Deere® Tractors: 50, 520, 530, 1020, 1120, 1520, 1530, 1630, 1640, 1830, 1840, 2010, 2020, 2030, 2040, 2040S, 2120, 2130, 2140, 2350, 2355, 2440, 2510, 2520, 2550, 2555, 2630, 2640, 2750, 4030, Utility: 2240	Used Axle Wedge For 2 7/8" (73 mm) Axle	Non-Keyed AMB3016S-U	\$ 75.00	\$ 67.50
	Used Axle Wedge For 2 7/8" (73 mm) Axle	Non-Keyed AMB3018S-U	\$ 95.00	\$ 85.50
John Deere® Tractors: 2555, 2650, 2755, 2850, 2955, 3055, 3155, 3255, 6110, 6110L, 6120, 6120L, 6200, 6200L, 6210, 6210L, 6215, 6220, 6220L, 6300, 6300L, 6310, 6310L, 6320, 6320L, 6400, 6400L, 6410, 6410L, 6415, 6420, 6420L, 6420S, 6500L, 6520L, 6605, 6615, 6715	Used Axle Wedge For 79 mm Axle	Keyed AML56288-U	\$ 125.00	\$ 112.50
John Deere® Tractors: 2555, 2650, 2755, 2840, 2850, 2940, 2950, 2955, 3010, 3020, 3030, 3040, 3055, 3120, 3130, 3140, 3150, 3155, 3255, 4000, 4010, 4020, 4030, 6110, 6110L, 6120, 6120L, 6200, 6200L, 6210, 6210L, 6215, 6220, 6220L, 6300, 6300L, 6310, 6310L, 6320, 6320L, 6400, 6400L, 6410, 6410L, 6415, 6420, 6420L, 6420S, 6500L, 6520L, 6605, 6615, 6715	Used Axle Wedge For 79 mm Axle	Non-Keyed AMR33539-U	\$ 35.00	\$ 31.50
John Deere® Tractors: 2840, 2940, 2950, 3010, 3020, 3030, 3040, 3120, 3130, 3140, 3150, 4000, 4010, 4020, 4030	Used Axle Wedge For 79 mm Axle	Keyed AMR33540-U	\$ 75.00	\$ 67.50
John Deere® Tractors: 4020, 4040, 4050, 4055, 4230, 4240, 4250, 4255, 4320, 4430, 4440, 4455, 7020, 7405, 7520	Used Axle Wedge For 86 mm Axle	Keyed AMR93955-U	\$ 45.00	\$ 40.50
	Used Axle Wedge For 86 mm Axle	Non-Keyed AMR33531-U	\$ 45.00	\$ 40.50
John Deere® Tractors: 4020, 4040, 4050, 4230, 4240, 4250, 4320, 4430, 4440, 4455, 7020, 7405, 7520	Used Axle Wedge For 86 mm Axle	Keyed AMR33532-U	\$ 57.00	\$ 51.30
John Deere® Tractors: 4020, 4040, 4050, 4230, 4240, 4250, 4320, 4430, 4440, 4455, 7020, 7520	Used Axle Wedge For 86 mm Axle	Keyed AMR33534-U	\$ 100.00	\$ 90.00
John Deere® Tractors: 4020, 4040, 4050, 4240, 4250, 4230, 4320, 4430, 4440, 4455, 7020, 7520	Used Axle Wedge For 86 mm Axle	Non-Keyed AMR33533-U	\$ 75.00	\$ 67.50
John Deere® Tractors: 4040, 4050, 4240, 4250, 4430, 4440, 7020, 7520	Used Axle Wedge For 86 mm Axle	Keyed AMR52032-U	\$ 75.00	\$ 67.50
John Deere® Tractors: 4430, 4440, 4450, 4520, 4620, 4630, 5010, 5020, 6030, 8430, 8630	Used Axle Wedge For 92 mm Axle	Keyed AMAR83354-U	\$ 81.00	\$ 72.90
	Used Axle Wedge For 92 mm Axle	Non-Keyed AMR35302-U	\$ 100.00	\$ 90.00

Used Parts

Application	Description		Part Number	Retail Price	Wholesale
John Deere® Tractors: 4430, 4440, 4450, 8430, 8630, Cotton Pickers: 9940, 9950	Used Axle Wedge Marked R57934 For 92 mm Axle	Keyed	AMR57927-U	\$ 82.00	\$ 73.80
	Used Axle Wedge For 92 mm Axle	Keyed	AMR57934-U	\$ 82.00	\$ 73.80
	Used Axle Wedge For 92 mm Axle	Non-Keyed	AMR57928-U	\$ 95.00	\$ 85.50
John Deere® Tractors: 4555, 4560, 4755, 4760, 4955, 4960, 7720, 7820, 7920, 8100, 8110, 8120, 8200, 8210, 8220, 8300, 8310, 8320, 8400, 8410, 8560, 8570, 8760, 8770, 8870, 9100, 9120, 9200, 9220, 9300, 9320	Used Axle Wedge For 100 mm Axle	Keyed	AMR92531-U	\$ 150.00	\$ 135.00
	Used Axle Wedge For 100 mm Axle	Keyed	AMR105006-U	\$ 150.00	\$ 135.00
	Used Axle Wedge For 100 mm Axle	Keyed	AMR111103-U	\$ 150.00	\$ 135.00
John Deere® Tractors: 4455, 7600, 7610, 7700, 7710, 7720, 7800, 7810, 7820, 7920	Used Axle Wedge For 92 mm Axle	Keyed	AMR111102-U	\$ 165.00	\$ 148.50
	Used Axle Wedge For 92 mm Axle	Keyed	AMR105004-U	\$ 165.00	\$ 148.50
	Used Axle Wedge For 92 mm Axle	Non-Keyed	AMR124248-U	\$ 150.00	\$ 135.00
	Used Axle Wedge For 92 mm Axle	Non-Keyed	AMR107726-U	\$ 150.00	\$ 135.00
John Deere® Tractors: 4555, 4560, 4755, 4760, 4955, 4960, 7720, 7820, 7920, 8560, 8570, 8760, 8770, 8870	Used Axle Wedge For 100 mm Axle	Non-Keyed	AMR92525-U	\$ 150.00	\$ 135.00
	Used Axle Wedge For 100 mm Axle	Non-Keyed	AMR105005-U	\$ 150.00	\$ 135.00
	Used Axle Wedge For 100 mm Axle	Non-Keyed	AMR107727-U	\$ 150.00	\$ 135.00
	Used Axle Wedge For 100 mm Axle	Non-Keyed	AMR124249-U	\$ 150.00	\$ 135.00
John Deere® Tractors: 4620, 4630, 4640, 4650, 4840, 4850, 6030, 8430, 8440, 8450, 8630, 8640, 8650	Used Axle Wedge For 100 mm Axle	Non-Keyed	AMR58864-U	\$ 75.00	\$ 67.50
	Used Axle Wedge For 100 mm Axle	Keyed	AMAR83356-U	\$ 75.00	\$ 67.50
	Used Axle Wedge For 100 mm Axle	Keyed	AMR59899-U	\$ 75.00	\$ 67.50
John Deere® Tractors: (7200, 7210, 7400, 7410, 7510 - w/ Steel Disc or Cast Rear Wheels), (7220, 7320 - w/ Steel Disc Rear Wheels), (7420, 7520 - w/ Multi-Position Dual Rear Wheels w/ 10-Bolt Hubs)	Used Axle Wedge Verify Cast Number Keyed Sleeve Use with 79.50 mm Axle Shaft		AMR107837-U	\$ 133.00	\$ 120.00
	Used Axle Wedge Verify Cast Number Use with 79.50 mm Axle Shaft Replaces R107846		AMR124246-U	\$ 150.00	\$ 135.00

Used Parts

Application	Description	Part Number	Retail Price	Wholesale
John Deere® Tractors: (7210R, 7230R ASN 103000 w/ 110 mm Double Tapered Axle Shaft), (7250R, 7260R, 7270R, 7280R, 7290R, 7310R, 7R 210, 7R 230, 7R 250, 7R 270, 7R 290, 7R 310, 7R 330, 8R 230, 8R 250, 8R 280, 8260R, 9470R - w/ 110 mm Double Tapered Axle Shaft), 8245R ASN 090000 w/ 110 mm Double Tapered Axle Shaft, (8120, 8130, 8220, 8230, 8235R, 8285R, 8310R, 8320, 8330, 8360R, 8420, 8430, 8530 - w/ Heavy Duty Cast or Steel Wheels or Heavy Duty Duals/Multi-Position Duals), 8225R BSN 120000 w/ Heavy Duty Cast or Steel Wheels or Heavy Duty Duals/Multi-Position Duals, (8245R, 8295R, 8320R - w/ Heavy Duty Cast or Steel Wheels or Heavy Duty Duals/Multi-Position Duals), 8345R BSN 053100 w/ Heavy Duty Cast or Steel Wheels or Heavy Duty Duals/Multi-Position Duals), (8270R, 8295R Dual Wheel ASN 090000 w/ 110 mm Double Tapered Axle Shaft), (8270R, 8335R BSN 090001 w/ Heavy Duty Cast or Steel Wheels or Heavy Duty Duals/Multi-Position Duals), (9120, 9220, 9230, 9320, 9330, 9420, 9430, 9520, 9530 HD Cast Wheels only, 9620 - w/ Heavy Duty Cast or Steel Inner/Dual Wheels or Heavy Duty Triple Wheel Option), (9360R, 9410R Dual or Triple Wheel Option w/ 110 mm Double Tapered Axle Shaft), (9370R, 9420R BSN 066160 w/ Single, Dual or Triple Wheel Option w/ Single Reduction Axle w/ 110 mm Double Tapered Axle Shaft), (9370R, 9470R BSN 066160 w/ 110 mm Double Tapered Axle Shaft w/ Single Wheel Option w/ 12-Bolt Hubs), (9420R BSN 066160 w/ Single Reduction Axles 9370R, 9470R BSN 066160 w/ 110 mm Double Tapered Axle Shaft w/ Single Wheel Option w/ 12-Bolt Hubs), (9520R, 9570R, 9620R Triple Wheel Option w/ 110 mm Double Tapered Axle Shaft)	Used Axle Wedge	AMR192510-U	\$ 163.00	\$ 146.00
John Deere® Tractors: (7210R, 7230R ASN 103000 w/ 110 mm Double Tapered Axle Shaft), (7250R, 7260R, 7270R, 7280R, 7290R, 7310R, 7R 210, 7R 230, 7R 250, 7R 270, 7R 290, 7R 310, 7R 330, 8260R, 8R 230, 8R 250, 8R 280, 9470R - w/ 110 mm Double Tapered Axle Shaft), (8120, 8220, 8320 - w/ Heavy Duty Steel Wheels or Heavy Duty Multi-Position Duals), (8130, 8230, 8235R, 8420, 8285R, 8310R, 8330, 8360R, 8430, 8530 - w/ Heavy Duty Cast or Steel Wheels or Heavy Duty Duals/Multi-Position Duals), (8225R, 8245R, 8295R, 8320R, 8345R BSN 053100 w/ Heavy Duty Cast or Steel Wheels or Heavy Duty Duals/Multi-Position Duals), (8245R ASN 090000 w/ 110 mm Double Tapered Axle Shaft), (8270R, 8295R Dual Wheel ASN 090000 w/ 110 mm Double Tapered Axle Shaft), (8270R, 8335R BSN 090001 w/ Heavy Duty Cast or Steel Wheels or Heavy Duty Duals/Multi-Position Duals), (9120, 9220, 9230, 9320, 9330, 9420, 9430, 9520, 9620 - w/ Heavy Duty Cast or Steel Inner/Dual Wheels or Heavy Duty Triple Wheel Option), (9360R, 9410R Dual or Triple Wheel Option w/ 110 mm Double Tapered Axle Shaft), (9370R, 9420R BSN 066160 w/ Single Dual or Triple Wheel Option w/ Single Reduction Axle w/ 110 mm Double Tapered Axle Shaft), (9370R, 9470R BSN 066160 w/ 110 mm Double Tapered Axle Shaft w/ Single Wheel Option w/ 12 Bolt Hubs), 9420R BSN 066160 w/ Single Reduction Axles w/ 110 mm Double Tapered Axle Shaft w/ Single Wheel Option w/ 12 Bolt Hubs, (9520R, 9570R, 9620R - Triple Wheel Option w/ 110 mm Double Tapered Axle Shaft), 9530 Heavy Duty Cast Wheels Only	Used Axle Wedge Verify Cast Number Heavy Duty Rounded Style Wedge for 10-Bolt Hubs Use with 110 mm Axle Shafts	AMR192509-U	\$ 154.00	\$ 138.00
John Deere® Tractors: 8100, 8110, 8120, 8200, 8210, 8220, 8300, 8310, 8320, 8400, 8410, 8870, 8960, 8970, 9100, 9120, 9200, 9220, 9300, 9320, 9400	Used Axle Wedge For 110 mm Axle	Keyed AMR111104-U	\$ 65.00	\$ 58.50

Used Parts

Application	Description		Part Number	Retail Price	Wholesale
John Deere® Tractors: 8100, 8110, 8120, 8200, 8210, 8220, 8300, 8310, 8320, 8400, 8410, 8870, 8960, 8970, 9200, 9300, 9400	Used Axle Wedge For 110 mm Axle	Non-Keyed	AMR126587-U	\$ 75.00	\$ 67.50
	Used Axle Wedge For 110 mm Axle	Non-Keyed	AMR124250-U	\$ 75.00	\$ 67.50
	Used Axle Wedge For 110 mm Axle	Non-Keyed	AMR92526-U	\$ 75.00	\$ 67.50
John Deere® Tractors: 8100, 8110, 8120, 8200, 8210, 8220, 8300, 8310, 8320, 8400, 8410, 8870, 8960, 8970, 9100, 9120, 9200, 9220, 9300, 9320, 9400	Used Axle Wedge For 110 mm Axle	Keyed	AMR105008-U	\$ 150.00	\$ 135.00
John Deere® Tractor: 8850	Used Axle Wedge	Keyed	AMR72003-U	\$ 75.00	\$ 67.50
	Used Axle Wedge	Non-Keyed	AMR71903-U	\$ 75.00	\$ 67.50

Dual Hubs

Application	Description		Part Number	Retail Price	Wholesale
John Deere® Tractors: 2840, 2940, 2950, 2955, 3010, 3020, 4000, 4010, 4020, 4030, 4040, 4050, 4230, 4240, 4250, 4320, 4430, 4440, 4455, 7020, 7520	Used Dual Hub w/o Wedges 9-Bolt Hub		AMR28490-U	\$ 220.00	\$ 200.00
John Deere® Tractors: 4040, 4050, 4240, 4250, 4320, 4430, 4440, 4450, 8430, 8630, Cotton Pickers: 9940, 9950	Used Dual Hub w/o Wedges 9-Bolt Hub		AMR57969-U	\$ 315.00	\$ 283.50
John Deere® Tractors: 4050, 4250, 4430, 4440, 4450, 4520, 4620, 4630, 4640, 4840, 5020, 6030, 8430, 8440, 8450, 8630, 8640, 8650, 8850	Used Dual Hub w/o Wedges 10-Bolt Hub		AMR54160-U	\$ 425.00	\$ 382.50
John Deere® Tractors: 4055, 4255, 4455, 4555, 4560, 4755, 4760, 4955, 4960, 7200, 7400, 7600, 7700, 7800, 8100, 8200, 8300, 8400, 8560, 8570, 8760, 8770, 8870, 8960, 8970	Used Dual Hub w/o Wedges 10-Bolt Hub		AMR108955-U	\$ 315.00	\$ 283.50
John Deere® Tractors: 4055, 4255, 4455, 4555, 4755, 4955, 8560, 8570, 8760, 8770, 8870, 8960, 8970	Used Dual Hub w/o Wedges 10-Bolt Hub		AMR104948-U	\$ 425.00	\$ 382.50
John Deere® Tractors: 4055, 4255, 4455, 4555, 4755, 4955, 8560, 8760, 8960	Used Dual Hub w/o Wedges 10-Bolt Hub		AMR89885-U	\$ 315.00	\$ 283.50
John Deere® Tractors: 4560, 4760, 4960, 7200, 7210, 7220, 7320, 7400, 7410, 7510, 7600, 7610, 7700, 7710, 7800, 7810, 8100, 8110, 8200, 8210, 8300, 8310, 8400, 8410, 8760, 8770, 8870, 8960, 8970, 9100, 9120, 9200, 9220, 9300, 9320, 9400, 9420, 9520, 9620	Used Dual Hub w/o Wedges 10-Bolt Hub		AMR111007-U	\$ 315.00	\$ 283.50
John Deere® Tractors: 7200, 7210, 7220, 7320, 7400, 7410, 7420, 7510, 7520, 7600, 7610, 7700, 7710, 7720, 7800, 7810, 7820, 7920, 8100, 8110, 8120, 8200, 8210, 8220, 8300, 8310, 8320, 8400, 8410, 8570, 8770, 8870, 8970, 9100, 9120, 9200, 9220, 9300, 9320, 9400, 9420, 9520, 9620	Used Dual Hub w/o Wedges 10-Bolt Hub		AMR127282-U	\$ 425.00	\$ 382.50

Header Adapters

Table of Contents

Header Adapters..... 1462

Header Adapters

Application	Description	Part Number	Retail Price	Wholesale	Core
	Cornhead Adapter AGCO Combines to JD Cornhead	AMX29134	\$ 1500.00	\$ 1350.00	
	Cornhead Adapter AFX Combine to CNH 2200 Series Cornhead, w/ Yokes	AMX29128	\$ 1100.00	\$ 1000.00	
	Cornhead Adapter AFX Combine to IH 1083 Cornhead, w/o PTO	AMX29140	\$ 2495.00	\$ 2245.00	
	Cornhead Adapter AFX Combine to JD 600 Cornhead, Adapter Only	AMX29139	\$ 2250.00	\$ 2025.00	
	Cornhead Adapter AFX or CR Combine to JD Cornhead	AMX29132	\$ 935.00	\$ 841.50	
	Cornhead Adapter Lexion Combine to CNH 2200 Cornhead	AMX29136	\$ 495.00	\$ 445.50	
	Cornhead Adapter Lexion Combine to JD Cornhead, 4 1/8" Offset on 8 Rows	AMX29135	\$ 1100.00	\$ 1000.00	
	Cap, Top Tube	AMX29137	\$ 385.00	\$ 346.50	
Case IH® Combines: 1420, 1440, 1460, 1480, 1620, 1640, 1644, 1660, 1666, 1680, 1688, 2144, 2166, 2188, 2388, 2577, 2588	Cornhead Adapter IH Combine to CNH 2200 Cornhead	AMX29131	\$ 1276.00	\$ 1148.40	
	Cornhead Adapter IH Terrain Tracker Combine to JD Cornhead	AMX29130	\$ 765.00	\$ 688.50	
	Cornhead Adapter IH Standard Drive Combine to JD Cornhead	AMX29129	\$ 765.00	\$ 688.20	
New Holland® Combines: TR70, TR75, TR85, TR86, TR87, TR88, TR89, TR95, TR96, TR97, TR98, TR99	Cornhead Adapter TR Combine to JD Cornhead	AMX29133	\$ 726.00	\$ 653.40	
John Deere® Combines: 9550, 9650, 9750, 9660, 9760	Cornhead Adapter JD 50 or 60 Series to CNH 96C, 2200 or 2400, w/ Yokes	AMX29138	\$ 1265.00	\$ 1138.50	



Abilene Machine LLC
P.O. Box 129
Abilene, KS 67410
800-255-0337

Honest. Personal. Service.



Abilene Machine LLC

Kansas & Montana: 800-255-0337

South Carolina: 800-543-2451

South Dakota: 844-340-4020



AbileneMachine.com

